













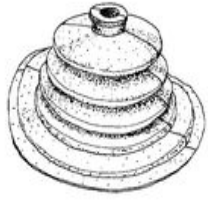
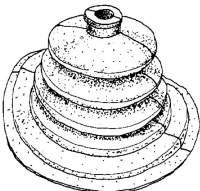

	<p>A2570 NO. 0817745 - 817745 - 90136269</p> <p>APOIO DA BOMBA COMBUSTÍVEL</p> <p>OPEL</p> <p>d20x 14mm p1-M8 compr-12mm p2-M8 compr-12mm</p>		<p>D0052 NO. 0458363 - 0458366 - 0458367 - 458363 - 458366 - 458367 - 90023735 - 90425689 - 90578558</p> <p>CARDAN TRANSMISSÃO</p> <p>OPEL MONZA A (22_) 2.5 E (05.81 A 08.86) 136cv 2490cc Coupé - OPEL MONZA A (22_) 2.8 (02.78 A 04.81) 140cv 2784cc Coupé - OPEL MONZA A (22_) 3.0 (04.78 A 07.82) 150cv 2969cc Coupé - OPEL MONZA A (22_) 3.0 GSE (02.78 A 08.86) 180cv 2969cc Coupé - OPEL MONZA A (22_) 3.0 GSE (09.85 A 08.86) 156cv 2969cc Coupé</p> <p>d127X30mm 6f-d12mm</p>
	<p>D0052 NO. 0458363 - 0458366 - 0458367 - 458363 - 458366 - 458367 - 90023735 - 90425689 - 90578558</p> <p>CARDAN TRANSMISSÃO</p> <p>OPEL SENATOR A (29_) 2.5 E (09.84 A 08.87) 140cv 2490cc três volumes - OPEL SENATOR A (29_) 2.8 (02.78 A 04.81) 140cv 2784cc três volumes - OPEL SENATOR A (29_) 3.0 (04.78 A 07.82) 150cv 2969cc três volumes 2 / 2 - OPEL SENATOR A (29_) 3.0 (09.85 A 08.87) 156cv 2969cc três volumes - OPEL SENATOR A (29_) 3.0 E (02.78 A 12.86) 180cv 2969cc três volumes - OPEL SENATOR A (29_) 2.2 TD (11.84 ...</p> <p>d127X30mm 6f-d12mm</p>		<p>D0052 NO. 0458363 - 0458366 - 0458367 - 458363 - 458366 - 458367 - 90023735 - 90425689 - 90578558</p> <p>CARDAN TRANSMISSÃO</p> <p>OPEL SENATOR B (V88) 2.5 i (P19) (09.90 A 09.93) 140cv 2490cc três volumes - OPEL SENATOR B (V88) 2.6 i (P19) (09.90 A 09.93) 150cv 2594cc três volumes - OPEL SENATOR B (V88) 3.0 (P19) (09.87 A 09.93) 156cv 2969cc três volumes - OPEL SENATOR B (V88) 3.0 (P19) (01.88 A 09.90) 177cv 2969cc três volumes - OPEL SENATOR B (V88) 3.0 i Cat (P19) (01.88 A 09.93) 177cv 2969cc três volumes - OPEL ...</p> <p>d127X30mm 6f-d12mm</p>
	<p>E0013 NO. 852715 - 852716 - 852720</p> <p>ESTICADOR DE ESCAPE</p> <p>OPEL COMMODORE C (APÓS 78)</p> <p>66x56x13mm</p>		<p>F1041-15 NO.</p> <p>Fole alavanca velocidades</p> <p>OPEL</p> <p>d150x80mm 1f-15mm</p>
	<p>F1041-20 NO.</p> <p>FOLE DA ALAVANCA DE VELOCIDADES</p> <p>OPEL MANTA - OPEL RECORD</p> <p>d150x80mm 1f-d20mm</p>		<p>H815 NO.</p> <p>PALA MEIA LUA GRANDE</p> <p>OPEL</p> <p>510x226x5mm 5 fixações</p>
	<p>H862 NO.</p> <p>PALA MEIA LUA PEQUENA</p> <p>OPEL</p> <p>496x195x5mm 5 fixações</p>		<p>L0218 NO.</p> <p>CASQUILHO</p> <p>OPEL</p> <p>d32x34mm d27mm 1f-d15mm</p>
	<p>N2002 NO. 030540081 - 113E5381B - 1719466</p> <p>ANEL DE ESCAPE</p> <p>OPEL 1900 GT</p> <p>d43x12mm 1f-d19mm</p>		<p>R225654 NO. 3647451 - 9683587180 - 9815434180 - 9820100680</p> <p>TUBO DO AR SOBREALIMENTAÇÃO</p> <p>OPEL GRANDLAND / GRANDLAND X (A18, P1UO) 1.2 (75) desde 06.2017 96KW 131CV 1199CC B 12 XHT (EB2DTS) D 12 XHT (EB2ADTS) F 12 XHT (EB2ADTS) 0035BLC 1844AAN - OPEL GRANDLAND / GRANDLAND X (A18, P1UO) 1.5 Turbo D (75) desde 04.2018 96KW 131CV 1499CC D 15 DTH (DV5RC) 1844AHG - OPEL GRANDLAND / GRANDLAND X (A18, P1UO) 1.5 Turbo D (75) desde 06.2018 75KW 102CV 1499CC D 15 DT (DV5RD) 1844AIY - OPEL GRANDL...</p> <p>B545-48/48mm 95x141x96x100x70mm</p>
	<p>T0001-E NO. 856516 - 856521</p> <p>BATENTE DE ESCAPE</p> <p>OPEL COMMODORE C (1978 A 1983) - SENATOR - MONZA (1978 A 1987)</p>		<p>U0007 NO.</p> <p>TAPA-FURO</p> <p>OPEL</p> <p>d45mm e1mm d40mm</p>
	<p>UAP83244 NO. 055565375 - 55565375</p> <p>ANILHA PROTEÇÃO TÉRMICA INJECTORES</p> <p>OPEL CROSSLAND X (P17) 1.6 Turbo D (08 - 68) (De 03-2017 Até .1-20 -) 73kW 99CV 1560cc Veículo todo-terreno fechado OPEL CROSSLAND X (P17) 1.6 Turbo D (08 - 68) (De 03-2017 Até .1-20 -) 88kW 120CV 1560cc Veículo todo-terreno fechado</p> <p>d15x2mm 1f-d7mm</p>		<p>UAP83244 NO. 055565375 - 55565375</p> <p>ANILHA PROTEÇÃO TÉRMICA INJECTORES</p> <p>OPEL GRANDLAND X (A18) 1.6 Turbo D (75) (De 06-2017 Até .1-20 -) 88kW 120CV 1560cc Veículo todo-terreno fechado</p> <p>d15x2mm 1f-d7mm</p>



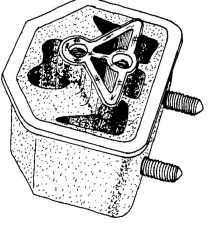
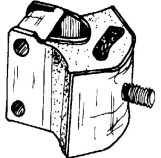
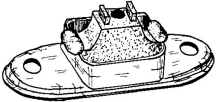







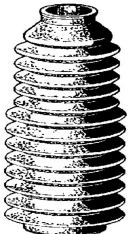
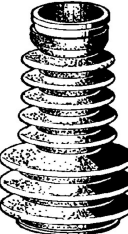

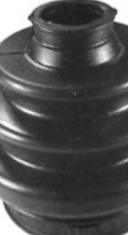
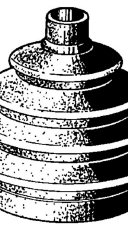
	UMB84011 NO. 031126 TAMPÃO BLOCO MOTOR OPEL SENATOR B (V88) 3.0 24V (P19) (De 09-1989 Até 09-1993) 150kW 204CV 2969cc três volumes d-18x8mm di-16mm		UMB84019 NO. 2060668 TAMPÃO BLOCO MOTOR OPEL SENATOR B (V88) 3.0 24V (P19) (De 09-1989 Até 09-1993) 150kW 204CV 2969cc três volumes d-26x9,5mm di-23,3mm
	UMV25438 NO. 3649167 - 55499457 - 55499458 - 55503114 - 55503115 - 565537081 MANETE PUNHO TOPO ALAVANCA MUDANÇAS 5 VELOCIDADES F17MM OPEL CROSSLAND X / CROSSLAND (P17, P2QO) 1.2 desde 07.2019 61KW 83CV 1199CC F 12 XE (EB2FA) 1844AKG 1844AIN - OPEL CROSSLAND X / CROSSLAND (P17, P2QO) 1.2 (75) desde 03.2017 60KW 82CV 1199CC D 12 XE (EB2FA) B 12 XE (EB2F) 0035BIZ 1844ADU - OPEL CROSSLAND X / CROSSLAND (P17, P2QO) 1.2 (75) desde 03.2017 81KW 110CV 1199CC B 12 XHL (EB2DT) D 12 XHL (EB2ADT) F 12 XHL (EB2ADT) 0035BJA 1844AKH 1844ADT ... 51x57x106mm 1f-d17mm		UTV83019 NO. 0652315 - 0652477 - 652315 - 652477 - 90502556 - 96023264 TAMPÃO VEDAÇÃO BUJÃO OPEL ASTRA H (A04) 1.4 (L48) (De 04-2004 Até 10-2004) 55kW 75CV 1364cc Hatchback OPEL ASTRA H (A04) 1.4 (L48) (De 03-2004 Até 10-2010) 66kW 90CV 1364cc Hatchback OPEL ASTRA H (A04) 1.4 LPG (L48) (De 08-2009 Até 10-2010) 66kW 90CV 1364cc Hatchback OPEL ASTRA H (A04) 1.6 (L48) (De 03-2004 Até 10-2010) 77kW 105CV 1598cc Hatchback OPEL ASTRA H (A04) 1.6 (L48) (De 12-2006 Até 05-2014) 85kW 116CV 1598cc... d25x14mm c9mm d13mm
	Y3208 NO. 3549817 PARAFUSO PERNO RODA CHAVE 17 M12X1,25X57MM (BASE PLANA PARA JANTES LIGA LEVE) OPEL CROSSLAND X / CROSSLAND (P17, P2QO) 1.2 (75) 03.2017 - 126415 60 82 1199 SUV OPEL CROSSLAND X / CROSSLAND (P17, P2QO) 1.2 (75) 03.2017 - 126416 81 110 1199 SUV OPEL CROSSLAND X / CROSSLAND (P17, P2QO) 1.2 (75) 03.2017 - 126414 96 131 1199 SUV OPEL CROSSLAND X / CROSSLAND (P17, P2QO) 1.2 LPG (75) 10.2017 - 129169 60 82 1199 SUV OPEL CROSSLAND X / CROSSLAND (P17, P2QO) 1.5 Turbo D (75) 06.2018 ... d29x57mm 1p-d12x1,25x36mm		Z00531 NO. 1470998 - 207217563 - N0154322 Mola porca rápida OPEL (TODOS) 24.6x16.2x5.5mm 1f-d6.3mm
	Z00538 NO. 2072077 Mola porca rápida Opel 21x13x4mm 1f-d5.5mm		Z10502 NO. Mola de fixação OPEL (TODOS) d12x11mm 1p-d4.8-12.4mm 1f-d3mm
	Z10672 NO. 1719245 - 30550549 - 90138810 MOLA DE FIXAÇÃO OPEL VÁRIOS MODELOS d14x27mm 1p-d8x6x11mm		Z50531 NO. 90138810 MOLA DE FIXAÇÃO REBITE PLÁSTICO 8mm OPEL (VÁRIOS MODELOS) d16x21mm 1p-d9x10mm
	Z55288 NO. 13317099 MOLA DO PAINEL DAS PORTAS OPEL CROSSLAND X (A partir de 2017) F12mm T17mm L12mm H19mm S1-9mm		Z57101 NO. 13252119 MOLA DO PAINEL DA PORTA OPEL CROSSLAND X (A partir de 2017) F9mm T17mm L15mm H20mm S1-6mm
	Z71162 NO. 11610926 MOLA DO PAINEL EXTERIOR MOLDURAS OPEL CROSSLAND X (A partir de 2013) F13mm T20mm L15mm H20mm S1-7mm		Z71500 NO. 13252118 MOLA DO PAINEL DA PORTA OPEL CROSSLAND X (A partir de 2017) F9mm T17mm L14mm H20mm S1-7mm
	Z80470 NO. 0164361 - 164361 - 90033713 Mola de fixação OPEL (TODOS) d5x45mm		Z80488 NO. 1216904 - 90123504 Mola de fixação OPEL ASCONA (TODOS) 25x15x16mm

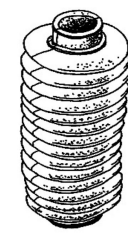
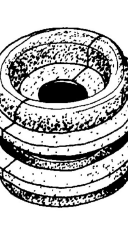



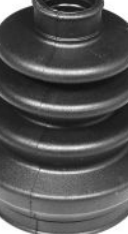





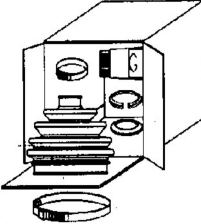
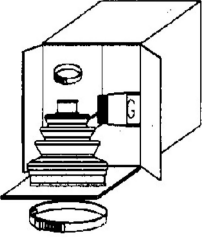
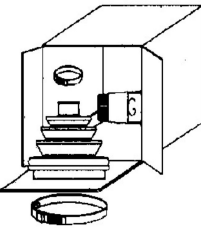
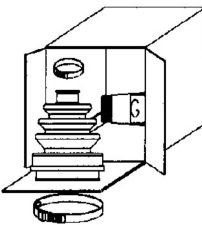

	Z80555	NO.		Z80582	NO. 6389840061 - 6389841661 - 7703077153 - 7703077356 - A6389840061 - A6389841661 - SS070069A
	Mola de friso Opel			Mola de painel RENAULT TWINGO	
	30x16.5x6mm			d16x21,5mm	1p-d11/12-18mm
	Z80656	NO. 90355604		Z80684	NO. 0180942 - 16131176747 - 1800940 - 180942 - 90127883 - 90413589
	Mola de friso OPEL (TODOS)			Mola de retenção OPEL (TODOS)	
	22x18x11mm	1p-8x3-9mm		d16x10mm	1f-d6mm
	Z80750	NO. 0009880328 - 0009880528 - 2207713 - 90082231			
	Mola de painel OPEL (TODOS)				
	d20x23mm	1p-d9-20mm			

OPEL ADMIRAL - KADETT (A)-(B)-(C)-(D)-(E)









	A0100	NO. 0684195 - 0684263 - 684195 - 684263 - 90135339 - 90217259 - 90250348 - 90250434 - 96227425		A0651	NO. 0684266 - 684266
	APOIO SUPORTE FRENTE DIREITO DO MOTOR OPEL KADETT E Hatchback (T85): 1.2 (C08, C48, D08, D48) 09.1984/07.1986 40KW 55CV 1196CC - OPEL KADETT E Hatchback (T85): 1.3 N (C08, C48, D08, D48) 09.1984/08.1991 44KW 60CV 1297CC - OPEL KADETT E Hatchback (T85): 1.3 i Cat (C08, C48, D08, D48) 09.1985/08.1991 44KW 60CV 1297CC - OPEL KADETT E Hatchback (T85): 1.3 S (C08, C48, D08, D48) 09.1984/08.1987 55KW 75CV 1297CC - OPEL KADETT E Hatchback (T...			APOIO MOTOR (GASTA 2 UNIDADES) OPEL KADETT B 1.1 09.1965/07.1971 33KW 45CV 1078CC 11 N 0039445, 0039317, 0039315 - OPEL KADETT B 1.1 S 09.1965/07.1971 40KW 55CV 1078CC 11 S 0039446, 0039318, 0039316 - OPEL KADETT B 1.1 SR 11.1966/07.1971 44KW 60CV 1078CC 11 SR 0039422, 0039425, 0039447 - OPEL KADETT B Combi 1.1 09.1965/07.1971 33KW 45CV 1078CC 11 N 003939, 00039388 - OPEL KADETT B Coupé 1.1 09.1965/07.1971 33KW 45CV 1078CC 11 N...	
	114x91x56mm	2p-d9-25mm 2r-d8mm		73x70x58mm	1p-d10-16mm
	A0652	NO. 0684836 - 684836		A1206	NO. 682549
	APOIO SUPORTE DA CAIXA DE VELOCIDADES OPEL KADETT B 1.1 09.1965/07.1971 33KW 45CV 1078CC 11 N 0039445, 0039317, 0039315 - OPEL KADETT B 1.1 S 09.1965/07.1971 40KW 55CV 1078CC 11 S 0039446, 0039318, 0039316 - OPEL KADETT B 1.1 SR 11.1966/07.1971 44KW 60CV 1078CC 11 SR 0039422, 0039425, 0039447 - OPEL KADETT B Combi 1.1 09.1965/07.1971 33KW 45CV 1078CC 11 N 003939, 00039388 - OPEL KADETT B Coupé 1.1 09.1965/07.1971 33KW 45CV 1078CC 11 N...			APOIO ESQUERDO DE MOTOR TRÁS OPEL CORSA B 1.4i - 1.4i 16v (1998 A 2000)	
	190x68x54mm	1f-d14mm		158x90x60mm	2r-d10mm
	A1206	NO. 682549		A1207	NO. 684257 - 684285 - 684289 - 684841 - 684843 - 90216584
	APOIO ESQUERDO DE MOTOR TRÁS OPEL KADETT E 1.2 - 1.3 - 1.5TD - 1.6 - 1.6D - 1.7D - 1.8i (1984 A 1991)			APOIO DE MOTOR OPEL KADETT E (T85) TIPO ANO DE CONSTRUÇÃO KW HP CC	
	158x90x60mm	2r-d10mm		185x95x67mm	2r-d11mm
	A1216	NO. 0344517 - 0344531 - 0926614001 - 344517 - 344517S1 - 344518 - 344524 - 344531 - 90345330 - 90374844...		NUMERO DE ALEMANIA: 684282 - 684291 - 6844282 - 6844283 - 684667 INFO: 684667	
	APOIO SUPORTE AMORTECEDOR FRENTE (GASTA 2 UNIDADES) OPEL KADETT (E) 1.7D (1992 A 1994)			1.2 (C19, D19) 09.1984 - 07.1986 40 55 1196 12 SC 0039661 1.3 (C19, D19) 09.1984 - 07.1986 44 60 1297 C 13 N 0039662 1.3 N (C19, D19) 09.1984 - 08.1989 44 60 1297 13 NB13 N 0039662 OPEL KADETT (E) 1.7D (1992 A 1994) 13 S 0039663 1.4i (C19, D19) 01.1990 - 08...	
	150x130x43mm	1f-d32mm 1f-d14mm		185x95x67mm	2f-d11mm

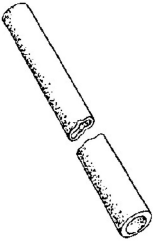
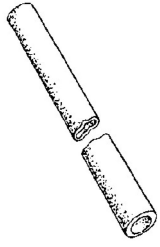
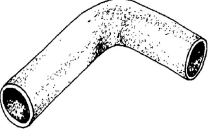

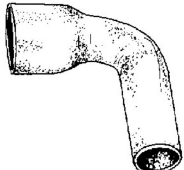
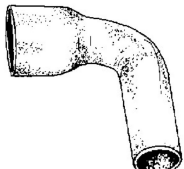
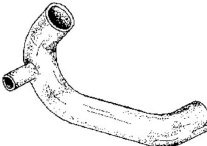
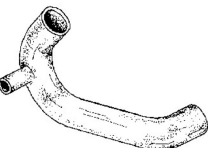







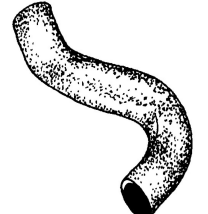
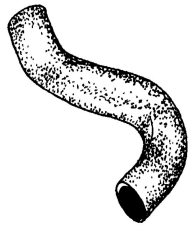

	<p>A1406 NO. 0650702 - 90233962</p> <p>APOIO MOTOR ESQUERDO</p> <p>OPEL KADETT</p> <p>d20x15mm 1p-d6-10mm 1p-d6-15mm</p>		<p>A1461 NO. 0684267 - 684265 - 684267 - 90334757</p> <p>APOIO SUPORTE DA FRENTE MOTOR LADO DIREITO</p> <p>OPEL KADETT E DIESEL 1.6D - 1.7D (1984 A 1991)</p> <p>120x100x95mm</p>
	<p>A2242 NO. 0817744 - 817744 - 90080552</p> <p>APOIO DA BOMBA DO COMBUSTIVEL</p> <p>OPEL KADETT E (T85) 1.8 S (C19, D19) (De 1987.09 Até 1991.08) 62kW 84cv 1796cm3 três volumes - OPEL KADETT E (T85) 1.8 i (C19, D19) (De 1990.09 Até 1991.08) 66kW 90cv 1796cm3 três volumes - OPEL KADETT E (T85) 1.8 i (C19, D19) (De 1985.10 Até 1986.08) 74kW 100cv 1796cm3 três volumes - OPEL KADETT E (T85) 1.8 (C19, D19) (De 1987.09 Até 1990.08) 84kW 114cv 1796cm3 três volumes...</p> <p>19x21mm 2p-d8x14mm</p>		<p>A2322 NO. 0682561 - 682561</p> <p>APOIO DO MOTOR PARTE DE TRÁS</p> <p>OPEL KADETT E (T85) MONZA 1.2 (C19, D19) 09.1984/07.1986 40KW 55CV 1196CC 12 SC 0039661 - OPEL KADETT E (T85) MONZA 1.3 i Cat (C19, D19) 09.1985/08.1991 44KW 60CV 1297CC C 13 N 0039662 - OPEL KADETT E (T85) MONZA 1.3 N (C19, D19) 09.1984/08.1989 44KW 60CV 1297CC 13 NB 13 N 0039662 - OPEL KADETT E (T85) MONZA 1.3 S (C19, D19) 09.1984/08.1987 55KW 75CV 1297CC 13 S 0039663 - OPEL KADETT E (T85)...</p> <p>139x66x73mm 1f-d10mm 2f-11x15mm</p>
	<p>A2461 NO. 682506</p> <p>APOIO DO MOTOR TRÁS CENTRO</p> <p>OPEL KADETT D (31_-34_, 41_-44_) : 1.0 09.1979ZT08.1982 30KW 41CV 993CC - OPEL KADETT D (31_-34_, 41_-44_) : 1.0 09.1979/08.1984 33KW 45CV 993CC - OPEL KADETT D (31_-34_, 41_-44_) : 1.0 08.1979/12.1983 37KW 50CV 993CC - OPEL KADETT D (31_-34_, 41_-44_) : 1.2 08.1979/07.1982 39KW 53KW 1196CC - OPEL KADETT D (31_-34_, 41_-44_) : 1.2 08.1982/08.1984 40KW 55CV 1196CC - OPEL KADETT D (31_-34_, 41_-44_) : 1.2...</p> <p>122x91x46mm 2f-d8mm 1f-d12mm</p>		<p>C0233 NO. 1160724 - 90054143</p> <p>BOTÃO AFINAÇÃO CAPÔT</p> <p>OPEL KADETT E Hatchback (33_34_43_44_) 1.2 (09.84 A 07.86) 55cv 1196cc Hatchback - OPEL KADETT E Hatchback (33_34_43_44_) 1.3 i Cat (09.85 A 08.91) 60cv 1297cc Hatchback - OPEL KADETT E Hatchback (33_34_43_44_) 1.3 S (09.84 A 08.87) 75cv 1297cc Hatchback - OPEL KADETT E Hatchback (33_34_43_44_) 1.4 i (01.90 A 08.91) 60cv 1389cc Hatchback - OPEL KADETT E Hatchback (33_34_43_44_)...</p> <p>d19x31mm</p>
	<p>E0006 NO. 852717 - 852718 - 90091697</p> <p>ESTICADOR SUPORTE DE ESCAPE TRÁS</p> <p>OPEL KADETT D (31_-34_, 41_-44_) : 1.2 08.1979/07.1982 39KW 53CV 1196CC - OPEL KADETT D (31_-34_, 41_-44_) : 1.2 08.1982/08.1984 40KW 55CV 1196CC - OPEL KADETT D (31_-34_, 41_-44_) : 1.2 S 08.1979/08.1984 44KW 60CV 1196CC - OPEL KADETT D (31_-34_, 41_-44_) : 1.3 N 08.1979/08.1984 44KW 60CV 1297CC - OPEL KADETT D (31_-34_, 41_-44_) : 1.3 S 08.1979/08.1984 55KW 75CV 1297CC - OPEL KADETT D (31_-34_, 41_-44_)...</p> <p>105x30x20mm</p>		<p>E0008 NO. 852512 - 856517</p> <p>ESTICADOR DE ESCAPE</p> <p>OPEL KADETT C City: 1.2 S 08.1973/07.1979 44KW 60CV 1196CC - OPEL KADETT C: 1.2 S 08.1973/07.1979 44KW 60CV 1196CC - OPEL KADETT C Coupé: 1.2 S 08.1973/07.1979 44KW 60CV 1196CC</p> <p>d44x40mm</p>
	<p>E0013 NO. 852715 - 852716 - 852720</p> <p>ESTICADOR DE ESCAPE</p> <p>OPEL KADETT E (APÓS 85) - KADETT COMBO (85 A 90)</p> <p>66x56x13mm</p>		<p>E0016 NO. 0852719 - 852719 - 90128194</p> <p>ESTICADOR SUPORTE CENTRAL E TRÁS DO ESCAPE</p> <p>OPEL KADETT E Hatchback (T85): 1.2 (C08, C48, D08, D48) 09.1984/07.1986 40KW 55CV 1196CC - OPEL KADETT E Hatchback (T85): 1.3 i Cat (C08, C48, D08, D48) 09.1985/08.1991 44KW 60CV 1297CC - OPEL KADETT E Hatchback (T85): 1.3 S (C08, C48, D08, D48) 09.1984/08.1987 55KW 75CV 1297CC - OPEL KADETT E Hatchback (T85): 1.4 i (C08, C48, D08, D48) 01.1990/08.1991 44KW 60CV 1389CC - OPEL KADETT E Hatchback (T...)</p> <p>105x35x33mm</p>
	<p>E0085 NO. 350261 - 90278577</p> <p>ESTICADOR BARRA ESTABILIZADORA FRENTE FURO 18MM (GASTA 2 UNIDADES)</p> <p>OPEL KADETT E (T85) MONZA 1.4 S (C19, D19) 01.1990/08.1991 55KW 75CV 1389CC 14 NV 0039828 - OPEL KADETT E Cabriolet (T85) 1.4 S 08.1990/02.1993 55KW 75CV 1389CC 14 NV 0039837 - OPEL KADETT E Combi (T85) 1.4 S (C15, C35, D15, D35) 01.1990/08.1991 55KW 75CV 1389CC 14 NV 0039832 - OPEL KADETT E Combo (T85) 1.4 S (C25, D25) 07.1989/08.1991 55KW 75CV 1389CC 14 NV 0039113 - OPEL KADETT E Combo (T85) 1...</p> <p>110x40x35mm</p>		<p>E0128 NO. 0350263 - 350263 - 4544599 - 90495045</p> <p>ESTICADOR DA BARRA ESTABILIZADORA DA FRENTE</p> <p>OPEL KADETT (E) 1.4S - 1.7D (1989 A 1993)</p> <p>105x34x34mm 1p-d12-25mm</p>
	<p>E0147 NO. 350260 - 90278579 - 90278586</p> <p>ESTICADOR DA BARRA ESTABILIZADORA DA FRENTE</p> <p>OPEL KADETT (E) 1.4S - 1.7D</p> <p>100x50x35mm 1f-d21mm 1p-d8-28mm</p>		<p>E1003 NO. 0856519 - 856519 - 9281771</p> <p>ESTICADOR SUPORTE TRÁS DO ESCAPE</p> <p>OPEL KADETT C City: 1.0 05.1975/07.1979 29KW 40CV 993CC - OPEL KADETT C City: 1.2 05.1975/04.1977 38KW 52CV 1196CC - OPEL KADETT C City: 1.2 07.1976/07.1979 40KW 54CV 1196CC - OPEL KADETT C City: 1.2 S 08.1973/07.1979 44KW 60CV 1196CC - OPEL KADETT C City: 1.6 S 05.1977/07.1979 55KW 75CV 1584CC - OPEL KADETT C: 1.0 01.1974/07.1979 29KW 40CV 993CC - OPEL KADETT C: 1.2 08.1973/04.1977 38KW 52CV 1196...</p> <p>50x44x42mm 2f-d5mm 2f-18x9mm</p>
	<p>E1071 NO. 852723 - 90352773</p> <p>ESTICADOR DE ESCAPE</p> <p>OPEL KADETT E (1985 A 1991)</p> <p>72x61x20mm</p>		<p>E23401-V NO. 0758801 - 758801 - 90250156</p> <p>ESTICADOR MANETE CAIXA DE VELOCIDADES</p> <p>OPEL KADETT E Hatchback (T85) 1.3 i Cat (C08 - C48 - D08 - D48) (De 09-1985 Até 08-1991) 44KW 60CV 1297cc Hatchback OPEL KADETT E Hatchback (T85) 1.4 i (C08 - C48 - D08 - D48) (De 01-1990 Até 08-1991) 44KW 60CV 1389cc Hatchback OPEL KADETT E Hatchback (T85) 1.6 i (C08 - C48 - D08 - D48) (De 09-1986 Até 08-1991) 55KW 75CV 1598cc Hatchback OPEL KADETT E Hatchback (T85) 1.6 i Cat (C08 - C48 - D08 - D48)...</p> <p>207x17x18mm 2f-d11mm</p>

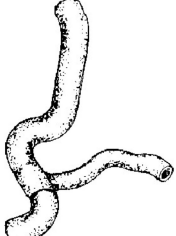
	<p>F0460-I NO. 322506</p> <p>FOLE DIRECÇÃO DIREITO/ESQUERDO (GASTA 2 UNIDADES)</p> <p>OPEL KADETT C City 1.0 05.1975/07.1979 29KW 40CV 993CC 10 N 0039520 0039290 0039293 - OPEL KADETT C City 1.2 05.1975/04.1977 38KW 52CV 1196CC 12 N 0039294 0039291 - OPEL KADETT C City 1.2 07.1976/07.1979 40KW 54CV 1196CC 12 N 0039521 - OPEL KADETT C City 1.2 S 08.1973/07.1979 44KW 60CV 1196CC 12 S 0039522 0039292 0039295 - OPEL KADETT C City 1.6 S 05.1977/07.1979 55KW 75CV 1584CC 16 S 0039528 - OP...</p> <p>d70x190mm 1f-d22mm 1f-d40mm</p>		<p>F0465-I NO. 322501</p> <p>FOLE DIRECÇÃO DIREITO/ESQUERDO (GASTA 2 UNIDADES)</p> <p>OPEL KADETT B Combi 1.1 09.1965/07.1971 33KW 45CV 1078CC 11 N 0039390 0039388 - OPEL KADETT B Combi 1.1 09.1965/07.1971 40KW 55CV 1078CC 11 S 0039389 0039391 - OPEL KADETT B Combi 1.1 08.1971/08.1973 37KW 50CV 1078CC 11 N 0039487 0039486 - OPEL KADETT B Combi 1.2 08.1971/08.1973 44KW 60CV 1196CC 12 S 0039201 0039202 - OPEL KADETT B Coupé 1.1 09.1965/07.1971 33KW 45CV 1078CC 11 N 0039440 0039392 - ...</p> <p>d75x160mm d52mm 1f-d40mm 1f-d33mm</p>
	<p>F0466-I NO. 90090811 - 902825 - 902828 - 9105983</p> <p>FOLE DIRECÇÃO DIREITO/ESQUERDO (GASTA 2 UNIDADES)</p> <p>OPEL KADETT D (31_-34_, 41_-44_) 1.0 09.1979/08.1982 30KW 41CV 993CC 10 N - OPEL KADETT D (31_-34_, 41_-44_) 1.0 09.1979/08.1984 33KW 45CV 993CC 10 S - OPEL KADETT D (31_-34_, 41_-44_) 1.0 08.1979/12.1983 37KW 50CV 993CC 10 S - OPEL KADETT D (31_-34_, 41_-44_) 1.2 08.1982/08.1984 40KW 55CV 1196CC 12 ST 0039614 - OPEL KADETT D (31_-34_, 41_-44_) 1.2 08.1979/07.1982 39KW 53CV 1196CC 12 N 0039575 - O...</p> <p>d78x165mm 1f-d41mm 1f-d51mm</p>		<p>F0469-I NO. 3435052 - 414510</p> <p>FOLE DA TRANSMISSÃO LADO DA CAIXA</p> <p>OPEL ADMIRAL B: 2.8 S 03.1969/07.1975 97KW 132CV 2784CC - OPEL ADMIRAL B: 2.8 03.1969/02.1975 107KW 146CV 2784CC - OPEL ADMIRAL B: 2.8 E 03.1975/01.1978 118KW 160CV 2784CC - OPEL ADMIRAL B: 2.8 E 03.1969/02.1975 121KW 165CV 2784CC</p> <p>d85x80mm 1f-d61mm 1f-d23mm</p>
	<p>F0481-I NO. 374019 - 90095087</p> <p>FOLE DO SEMI-EIXO EXTERNO</p> <p>OPEL KADETT D 1.1 - 1.3 - 1.6 - KADETT E 1.1 - 1.3 - 1.6 MANUALE (8-1979 A 1984)</p> <p>d100x80mm 1f-d20mm 1f-d75mm</p>		<p>F0519-I NO. 374040 - 90112609 - 90129014</p> <p>FOLE DO SEMI-EIXO LADO DA CAIXA DE VELOCIDADES</p> <p>OPEL KADETT 1.6 AUTOMATIC (APÓS 1989) - KADETT D 1.6 DIESEL (APOS 1989)</p> <p>d88x97mm 1f-d66mm 1f-d21mm</p>
	<p>F0520-I NO. 374018 - 90095162</p> <p>FOLE DO SEMI-EIXO INTERNO (F1026)</p> <p>OPEL KADETT D 1.2 - 1.3 - 1.6 MANUALE (8-1979 A 1984)</p> <p>d72x94mm 1f-d54mm 1f-d19mm</p>		<p>F1023 NO. 322502 - 322503</p> <p>FOLE DA DIRECÇÃO</p> <p>OPEL KADETT C City 1.0 05.1975/07.1979 29KW 40CV 993CC 10 N 0039520 0039290 0039293 - OPEL KADETT C City 1.2 05.1975/04.1977 38KW 52CV 1196CC 12 N 0039294 0039291 - OPEL KADETT C City 1.2 07.1976/07.1979 40KW 54CV 1196CC 12 N 0039521 - OPEL KADETT C City 1.2 S 08.1973/07.1979 44KW 60CV 1196CC 12 S 0039522 0039292 0039295 - OPEL KADETT C City 1.6 S 05.1977/07.1979 55KW 75CV 1584CC 16 S 0039528 - OP...</p> <p>d65x170mm 1f-d40mm 1f-d20mm</p>
	<p>F1029 NO. 0402637 - 402637</p> <p>FOLE APOIO SUPORTE REPARAÇÃO TRANSMISSÃO</p> <p>Opel Kadett C 1973-79 1,0/1.2 - 6N</p> <p>d82x50mm 1f-d28mm</p>		<p>F1285-I NO. 90236492</p> <p>FOLE DO SEMI-EIXO LADO DA RODA</p> <p>OPEL KADETT (D) 1.3S - 1.6S (1979 A 1984) - KADETT (E) 1.2 - 1.3i - 1.3N - 1.3S - 1.4i (1984 A 1991)</p> <p>d99x85mm 1f-d83mm 1f-d20mm</p>
	<p>F1305-I NO. 0902828 - 1609074 - 26024585</p> <p>FOLE DA DIRECÇÃO ASSISTIDA LADO DIREITO E ESQUERDO</p> <p>OPEL KADETT (E) 1.3i - 1.3S - 1.3N - 1.4i - 1.4S - 1.5TD - 1.6i - 1.6D - 1.7D - 1.8i - 1.8S - 1.8E - 2.0 - 2.0GSi</p> <p>d78x170mm 1f-d54mm 1f-d42mm</p>		<p>F1337-I NO. 902829</p> <p>FOLE DA DIRECÇÃO ASSISTIDA (CAIXA ZF)</p> <p>OPEL KADETT (E) 1.2 - 1.3i - 1.3N - 1.4S - 1.5TD - 1.6i - 1.6D - 1.7D - 1.8i - 1.8GSi - 2.0i</p> <p>d57x425mm 2f-d51mm</p>
	<p>F1373-I NO. 1603141 - 374040 - 90009020 - 90112609 - 90421756</p> <p>FOLE DA TRANSMISSÃO JUNTO À CAIXA</p> <p>OPEL KADETT D 1.5TD - 1.6 & S - 1.6D - 1.6S - 1.6i - 1.7D - 1.8GT-E - 1.8S - 1.8i - 1.8i & E - 1.8i & GSi - 2.0i - 2.0i & GSi - 2.0i GSi 16V (79 A 84)</p> <p>d87x99mm 1f-d65mm 1f-d22mm</p>		<p>F1373-I NO. 1603141 - 374040 - 90009020 - 90112609 - 90421756</p> <p>FOLE DA TRANSMISSÃO JUNTO À CAIXA</p> <p>OPEL KADETT E 1.5TD - 1.6i - 1.6 - 1.6D - 1.7D - 1.8i - 1.8 - 2.0i (84 A 93)</p> <p>d87x99mm 1f-d65mm 1f-d22mm</p>
	<p>F1534-I NO. 07842255 - 7842255</p> <p>FOLE DA TRANSMISSÃO JUNTO À CAIXA</p> <p>OPEL KADETT D 1.3 N - 1.3 S - 1.3i - 1.4i (1979 A 1984)</p> <p>d109x126mm 1f-d91mm 1f-d23mm</p>		<p>F1534-I NO. 07842255 - 7842255</p> <p>FOLE DA TRANSMISSÃO JUNTO À CAIXA</p> <p>OPEL KADETT E 1.3i - 1.3 - 1.4i (1984 A 1991)</p> <p>d109x126mm 1f-d91mm 1f-d23mm</p>

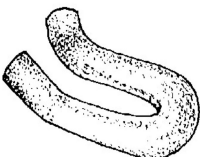
	<p>F4094 NO. 0738978 - 5738414 - 738978 - 90373314 - 90437426</p> <p>FOLE ALAVANCA VELOCIDADES</p> <p>OPEL KADETT E Hatchback (T85): 1.2 (C08, C48, D08, D48) 09.1984/07.1986 40KW 55CV 1196CC - OPEL KADETT E Hatchback (T85): 1.3 N (C08, C48, D08, D48) 09.1984/08.1991 44KW 60CV 1297CC - OPEL KADETT E Hatchback (T85): 1.3 i Cat (C08, C48, D08, D48) 09.1985/08.1991 44KW 60CV 1297CC - OPEL KADETT E Hatchback (T85): 1.3 S (C08, C48, D08, D48) 09.1984/08.1987 55KW 75CV 1297CC - OPEL KADETT E Hatchback (T...</p> <p>170x120x220mm 1f-160x105mm 1f-d50mm</p>		<p>H762 NO.</p> <p>PALA ORIGINAL</p> <p>OPEL KADETT D</p> <p>360x210mm</p>
	<p>H768 NO.</p> <p>PALA ORIGINAL</p> <p>OPEL KADETT E</p> <p>440x225mm</p>		<p>KF2300 NO. 374019 - 6152107500002 - 90095087</p> <p>FOLE DO LADO DA RODA</p> <p>OPEL KADETT (D - E) - 1.0 - 1.2 - 1.3 - 1.3 AUT.</p> <p>d96x79mm 1f-d19mm 1f-d77mm</p>
	<p>KF2310 NO. 374040</p> <p>FOLE DO LADO DA RODA</p> <p>OPEL KADETT D - E 1.6 - 1.8</p> <p>d90x79mm 1f-d22mm 1f-d83mm</p>		<p>KF2340 NO. 1603179 - 374050 - 90125491</p> <p>FOLE DO LADO DA RODA</p> <p>OPEL KADETT D - E 1.6 - 1.6 AUT. 1.8 - 2.0</p> <p>d103x78mm 1f-d22mm 1f-d82mm</p>
	<p>KF2345 NO. 374190 - 90236762</p> <p>FOLE DO LADO DA RODA</p> <p>OPEL KADETT E 1.2 - 1.3 S - 1.6</p> <p>d90x82mm 1f-d19mm 1f-d75mm</p>		<p>L3020 NO. 0856700 - 856700 - 9275758</p> <p>CASQUILHO DE ESCAPE</p> <p>OPEL KADETT D (31_-34_, 41_-44_): 1.3 N 08.1979/08.1984 44KW 60CV 1297CC - OPEL KADETT D (31_-34_, 41_-44_): 1.3 S 08.1979/08.1984 55KW 75CV 1297CC - OPEL KADETT D (31_-34_, 41_-44_): 1.6 S 09.1981/08.1984 66KW 90CV 1598CC - OPEL KADETT D (31_-34_, 41_-44_): 1.8 GT/E 02.1983/08.1984 85KW 115CV 1796CC - OPEL KADETT D (32_-37_, 39_, 42): 1.3 N 08.1979/08.1984 44KW 60CV 1297CC - OPEL KADETT D Combi (3...</p> <p>d29x12mm d26/di19x8mm 1f-d9mm</p>
	<p>L3020 NO. 0856700 - 856700 - 9275758</p> <p>CASQUILHO DE ESCAPE</p> <p>OPEL KADETT E</p> <p>d29x12mm d26/di19x8mm 1f-d9mm</p>		<p>M6003 NO. 854952</p> <p>JUNTA DE ESCAPE</p> <p>OPEL KADETT D - KADETT (E)</p> <p>d59x13.5mm 1f-d45mm</p>
	<p>M6004 NO. 854934</p> <p>JUNTA DE ESCAPE</p> <p>OPEL KADETT D 1.2S (1979 A 1984) - KADETT E (APOS 1984)</p> <p>d56x13.5mm 1f-d41mm</p>		<p>M6008 NO. 854943</p> <p>JUNTA DE ESCAPE</p> <p>OPEL KADETT E Hatchback (T85): 1.5 TD (C08, C48, D08, D48) 07.1988/08.1991 53KW 72CV 1488CC - OPEL KADETT E (T85): 1.5 TD (C19, D19) 07.1988/08.1991 53KW 72CV 1488CC - OPEL KADETT E Combi (T85): 1.5 TD (C15, C35, D15, D35) 07.1988/08.1991 53KW 72CV 1488CC</p> <p>d65x5mm 1f-d50mm</p>
	<p>M6036 NO. 02886093 - 02886931 - 854926</p> <p>JUNTA DE ESCAPE</p> <p>OPEL KADETT C (1971 A 1979) - CITY (1976 A 1979)</p> <p>96x60mm 2f-d36mm</p>		<p>M6041 NO. 854842 - 90091769</p> <p>JUNTA DE ESCAPE</p> <p>OPEL KADETT E (1984 A 1993)</p> <p>142x68mm 2f-d50mm</p>
	<p>M6045 NO. 854936 - 90231063</p> <p>JUNTA DE ESCAPE</p> <p>OPEL KADETT E (1985 A 1991)</p> <p>95x92mm 1f-d55mm</p>		<p>M6082 NO. 854943 - 854944 - 854955 - 97069287</p> <p>JUNTA DE ESCAPE</p> <p>OPEL KADETT E (1988 A 1991)</p> <p>d64x5mm 1f-d53mm</p>

	<p>N1617 NO. 852705 - 852711</p> <p>ANEL DE ESCAPE</p> <p>OPEL KADETT B (1965 A 1973)</p> <p>d65x13mm 1f-d40mm</p>		<p>N2001 NO. 852707 - 852712</p> <p>ANEL DE ESCAPE TRÁS</p> <p>OPEL KADETT A (1962 A 1965)</p> <p>d70x14mm 1f-d46mm</p>
	<p>N2074 NO. 856506</p> <p>ANEL DE ESCAPE</p> <p>OPEL KADETT (A) (1962 A 1965) - KADETT (B) (1965 A 1971)</p> <p>d54x10mm 1f-d34mm</p>		<p>N2335 NO. 0852713 - 09275338 - 852713 - 9275338</p> <p>ANEL ESCAPE</p> <p>OPEL KADETT E Hatchback (T85): 1.2 (C08, C48, D08, D48) 09.1984/07.1986 40KW 55CV 1196CC - OPEL KADETT E Hatchback (T85): 1.3 N (C08, C48, D08, D48) 09.1984/08.1991 44KW 60CV 1297CC - OPEL KADETT E Hatchback (T85): 1.3 i Cat (C08, C48, D08, D48) 09.1985/08.1991 44KW 60CV 1297CC - OPEL KADETT E Hatchback (T85): 1.3 S (C08, C48, D08, D48) 09.1984/08.1987 55KW 75CV 1297CC - OPEL KADETT E Hatchback (T...)</p> <p>d65x15mm 1f-d36mm</p>
	<p>N2335 NO. 0852713 - 09275338 - 852713 - 9275338</p> <p>ANEL ESCAPE</p> <p>OPEL KADETT C City: 1.0 05.1975/07.1979 29KW 40CV 993CC - OPEL KADETT C City: 1.2 05.1975/04.1977 38KW 52CV 1196CC - OPEL KADETT C City: 1.2 07.1976/07.1979 40KW 54CV 1196CC - OPEL KADETT C City: 1.2 S 08.1973/07.1979 44KW 60CV 1196CC - OPEL KADETT C: 1.0 01.1974/07.1979 29KW 40CV 993CC - OPEL KADETT C: 1.2 08.1973/04.1977 38KW 52CV 1196CC - OPEL KADETT C: 1.2 08.1973/07.1979 40KW 55CV 1196CC - OP...</p> <p>d65x15mm 1f-d36mm</p>		<p>N2336 NO. 852711 - 9275338</p> <p>ANEL ESCAPE</p> <p>OPEL KADETT E Hatchback (T85): 1.2 (C08, C48, D08, D48) 09.1984/07.1986 40KW 55CV 1196CC - OPEL KADETT E Hatchback (T85): 1.3 N (C08, C48, D08, D48) 09.1984/08.1991 44KW 60CV 1297CC - OPEL KADETT E Hatchback (T85): 1.3 S (C08, C48, D08, D48) 09.1984/08.1987 55KW 75CV 1297CC - OPEL KADETT E Hatchback (T85): 1.4 S (C08, C48, D08, D48) 01.1990/08.1991 55KW 75CV 1389CC - OPEL KADETT E Hatchback (T85):...</p> <p>d62x14mm 1f-d36mm</p>
	<p>N2336 NO. 852711</p> <p>ANEL ESCAPE</p> <p>OPEL KADETT C City: 1.0 05.1975/07.1979 29KW 40CV 993CC - OPEL KADETT C City: 1.2 05.1975/04.1977 38KW 52CV 1196CC - OPEL KADETT C City: 1.2 07.1976/07.1979 40KW 54CV 1196CC - OPEL KADETT C City: 1.2 S 08.1973/07.1979 44KW 60CV 1196CC - OPEL KADETT C: 1.0 01.1974/07.1979 29KW 40CV 993CC - OPEL KADETT C: 1.2 08.1973/04.1977 38KW 52CV 1196CC - OPEL KADETT C: 1.2 08.1973/07.1979 40KW 55CV 1196CC - OP...</p> <p>d62x14mm 1f-d36mm</p>		<p>N4021 NO. 852713</p> <p>ANEL DE ESCAPE</p> <p>OPEL KADETT E (1984 A 1991)</p> <p>d60x14mm 1f-d33mm</p>
	<p>N6371 NO. 08949811 - 852706 - 856507</p> <p>ANEL DE ESCAPE</p> <p>OPEL KADETT B 1.1 09.1965/07.1971 33KW 45CV 1078CC 11 N 0039445, 0039317, 0039315 - OPEL KADETT B 1.2 S 08.1971/08.1973 44KW 60CV 1196CC 12 S 0039204, 0039203 - OPEL KADETT B 1.7 08.1967/08.1971 55KW 75CV 1698CC 17 S 0039426, 0039448 - OPEL KADETT B Combi 1.1 09.1965/07.1971 33KW 45CV 1078CC 11 N 0039390, 0039388 - OPEL KADETT B Coupé 1.2 08.1971/08.1973 44KW 60CV 1196CC 12 S 0039205 - OPEL KADETT...</p> <p>d100x9mm 1f-d82mm</p>		<p>N6371 NO. 08949811 - 852706 - 856507</p> <p>ANEL DE ESCAPE</p> <p>OPEL KADETT A</p> <p>d100x9mm 1f-d82mm</p>
	<p>P1012 NO. 0560808 - 560808 - 90105172</p> <p>CAPA PEDAL EMBRAIAGEM/TRAVAO (GASTA 2 UNIDADES)</p> <p>OPEL KADETT E Hatchback (T85): 1.2 (C08, C48, D08, D48) 09.1984/07.1986 40KW 55CV 1196CC - OPEL KADETT E Hatchback (T85): 1.3 N (C08, C48, D08, D48) 09.1984/08.1991 44KW 60CV 1297CC - OPEL KADETT E Hatchback (T85): 1.3 i Cat (C08, C48, D08, D48) 09.1985/08.1991 44KW 60CV 1297CC - OPEL KADETT E Hatchback (T85): 1.3 S (C08, C48, D08, D48) 09.1984/08.1987 55KW 75CV 1297CC - OPEL KADETT E Hatchback (T...)</p> <p>60x55x9mm</p>		<p>P1012 NO. 0560808 - 560808 - 90105172</p> <p>CAPA PEDAL EMBRAIAGEM/TRAVAO (GASTA 2 UNIDADES)</p> <p>OPEL KADETT D (31_-34_, 41_-44_): 1.2 08.1979/07.1982 39KW 53CV 1196CC - OPEL KADETT D (31_-34_, 41_-44_): 1.2 08.1982/08.1984 40KW 55CV 1196CC - OPEL KADETT D (31_-34_, 41_-44_): 1.2 S 08.1979/08.1984 44KW 60CV 1196CC - OPEL KADETT D (31_-34_, 41_-44_): 1.3 N 08.1979/08.1984 44KW 60CV 1297CC - OPEL KADETT D (31_-34_, 41_-44_): 1.3 S 08.1979/08.1984 55KW 75CV 1297CC - OPEL KADETT D (31_-34_, 41_-44_):...</p> <p>60x55x9mm</p>
	<p>P1081 NO. 0842736 - 842736 - 90232022</p> <p>CAPA PEDAL ACELARADOR</p> <p>OPEL KADETT E (T85) MONZA 1.4 S (C19, D19) 01.1990/08.1991 55KW 75CV 1389CC 14 NV 0039828 - OPEL KADETT E Cabriolet (T85) 1.4 S 08.1990/02.1993 55KW 75CV 1389CC 14 NV 0039837 - OPEL KADETT E Combi (T85) 1.4 S (C15, C35, D15, D35) 01.1990/08.1991 55KW 75CV 1389CC 14 NV 0039832 - OPEL KADETT E Combo (T85) 1.4 S (C25, D25) 07.1989/08.1991 55KW 75CV 1389CC 14 NV 0039113 - OPEL KADETT E Combo (T85) 1...</p> <p>132x53x14mm</p>		<p>P1081 NO. 0842736 - 842736 - 90232022</p> <p>CAPA PEDAL ACELARADOR</p> <p>OPEL CALIBRA A (C89) 2.0 i (M07) 08.1989/12.1996 85KW 115CV 1998CC C 20 NE 0039844 - OPEL CALIBRA A (C89) 2.0 i 16V (M07) 06.1990/02.1994 110KW 150CV 1998CC C 20 XE 0039845 - OPEL CALIBRA A (C89) 2.0 i 16V (M07) 02.1994/07.1997 100KW 136CV 1998CC X 20 XEV 0039922 - OPEL CALIBRA A (C89) 2.0 i 16V 4x4 (M07) 06.1990/02.1994 110KW 150CV 1998CC C 20 XE 0039843 - OPEL CALIBRA A (C89) 2.0 i 16V 4x4 (M0...)</p> <p>132x53x14mm</p>
	<p>R021101 NO. 1818521</p> <p>TUBO DE LIGAÇÃO DA BOMBA DE ÁGUA AO COLECTOR</p> <p>OPEL KADETT B: 1.1 09.1965/07.1971 33KW 45CV 1078CC</p> <p>B165-d14/14mm 55-145mm</p>		<p>R021801 NO. 1336312 - 90144321</p> <p>TUBO SUPERIOR DO RADIADOR</p> <p>OPEL KADETT D (31_-34_, 41_-44_) 1.2 08.1982/08.1984 40KW 55CV 1196CC 12 ST 0039614 - OPEL KADETT D Combi (35_, 36_, 45_, 46_) 1.2 08.1979/07.1982 39KW 53CV 1196CC 12 N 0039582</p> <p>B300-d32/32mm 110-200-450mm</p>

	R021964 NO. 1818101 - 5943091 <i>TUBO DE RETORNO DA ÁGUA DO AQUECIMENTO</i> OPEL OPEL KADETT A 1.0 09.1962/08.1965 29KW 40CV 993CC 10 N 0039310 0039311		R021964 NO. 1818101 - 5943091 <i>TUBO DE RETORNO DA ÁGUA DO AQUECIMENTO</i> OPEL KADETT B 1.1 09.1965/07.1971 33KW 45CV 1078CC 11 N 0039445 0039317 0039315
	B435-d14/14mm 435mm		B435-d14/14mm 435mm
	R0609 NO. 1336250 - 1336316 - 90091138 - 90169012 <i>TUBO SUPERIOR DO RADIADOR</i> OPEL KADETT D (31_-34_, 41_-44_) 1.3 N 08.1979/08.1984 44KW 60CV 1297CC 13 N 0039577 - OPEL KADETT D (31_-34_, 41_-44_) 1.3 S 08.1979/08.1984 55KW 75CV 1297CC 13 S 0039578 - OPEL KADETT D (32_, 37_, 39_, 42_) 1.3 N 08.1979/08.1984 44KW 60CV 1297CC C 13 N - OPEL KADETT D (32_, 37_, 39_, 42_) 1.3 S 08.1979/08.1984 55KW 75CV 1297CC 13 S - OPEL KADETT D Combi (35_, 36_, 45_, 46_) 1.3 N 08.1979/08.1984 44KW ...		R0609 NO. 1336250 - 1336316 - 90091138 - 90169012 <i>TUBO SUPERIOR DO RADIADOR</i> OPEL KADETT E (T85) 1.3 i Cat (C19, D19) 09.1985/08.1991 44KW 60CV 1297CC C 13 N 0039662 - OPEL KADETT E (T85) 1.3 N (C19, D19) 09.1984/08.1989 44KW 60CV 1297CC 13 NB13 N 0039662 - OPEL KADETT E (T85) 1.3 S (C19, D19) 09.1984/08.1987 55KW 75CV 1297CC 13 S 0039663 - OPEL KADETT E Caixa/Combi (T85) 1.3 N (C70, D70) 09.1984/07.1989 44KW 60CV 1297CC 13 NB13 N 0039094 - OPEL KADETT E Combi (T85) 1.3 i ...
	B235-d34/34mm 180-145mm		B235-d34/34mm 180-145mm
	R0705 NO. 1336752 - 1336855 <i>TUBO SUPERIOR DO RADIADOR</i> OPEL KADETT C 1.0 01.1974/07.1979 29KW 40CV 993CC 10 N 0039244 0039246 - OPEL KADETT C 1.2 08.1973/04.1977 38KW 52CV 1196CC 12 N 0039233 0039235 - OPEL KADETT C 1.2 08.1973/07.1979 40KW 55CV 1196CC 12 N 0039519 - OPEL KADETT C City 1.0 05.1975/07.1979 29KW 40CV 993CC 10 N 0039520 0039290 0039293 - OPEL KADETT C City 1.2 05.1975/04.1977 38KW 52CV 1196CC 12 N 0039294 0039291 - OPEL KADETT C City 1.2...		R0705 NO. 1336752 - 1336855 <i>TUBO SUPERIOR DO RADIADOR</i> OPEL KADETT B 1.1 09.1965/07.1971 33KW 45CV 1078CC 11 N 0039445 0039317 0039315 - OPEL KADETT B 1.1 08.1971/08.1973 37KW 50CV 1078CC 11 N 0039488 0039489 - OPEL KADETT B 1.2 S 08.1971/08.1973 44KW 60CV 1196CC 12 S 0039204 0039203
	B180-d76/35mm 115-120mm		B180-d76/35mm 115-120mm
	R0705 NO. 1336752 - 1336855 <i>TUBO SUPERIOR DO RADIADOR</i> OPEL KADETT D (31_-34_, 41_-44_) 1.0 09.1979/08.1982 30KW 41CV 993CC 10 N - OPEL KADETT D (32_, 37_, 39_, 42_) 1.0 09.1979/08.1982 30KW 41CV 993CC 10 N		R0710 NO. 1336754 - 1336829 - 1336856 <i>TUBO INFERIOR DO RADIADOR</i> OPEL KADETT C 1.0 01.1974/07.1979 29KW 40CV 993CC 10 N 0039244 0039246 - OPEL KADETT C 1.2 08.1973/04.1977 38KW 52CV 1196CC 12 N 0039233 0039235 - OPEL KADETT C 1.2 08.1973/07.1979 40KW 55CV 1196CC 12 N 0039519 - OPEL KADETT C City 1.0 05.1975/07.1979 29KW 40CV 993CC 10 N 0039520 0039290 0039293 - OPEL KADETT C City 1.2 05.1975/04.1977 38KW 52CV 1196CC 12 N 0039294 0039291 - OPEL KADETT C City 1.2...
	B180-d76/35mm 115-120mm		B235-d33/34mm 100-210-65-ch45-d14mm
	R0710 NO. 1336754 - 1336829 - 1336856 <i>TUBO INFERIOR DO RADIADOR</i> OPEL KADETT B: 1.1 09.1965/07.1971 33KW 45CV 1078CC		R0710 NO. 1336754 - 1336829 - 1336856 <i>TUBO INFERIOR DO RADIADOR</i> OPEL KADETT A: 1.0 09.1962/08.1965 29KW 40CV 993CC
	B235-d33/34mm 100-210-65-ch45-d14mm		B235-d33/34mm 100-210-65-ch45-d14mm
	R080249 NO. 1336062 - 90265800 - 90322216 <i>TUBO RÍGIDO REFRIGERAÇÃO</i> OPEL KADETT E (T85) 1.6 i (C19, D19) 09.1986/08.1991 55KW 75CV 1598CC E 16 NZ 0039689 - OPEL KADETT E (T85) 1.6 S (C19, D19) 09.1984/08.1986 66KW 90CV 1598CC 16 SH 0039664 - OPEL KADETT E (T85) 1.6 S (C19, D19) 09.1986/08.1991 60KW 82CV 1598CC 16 SV 0039690 - OPEL KADETT E (T85) 1.8 i (C19, D19) 10.1985/08.1986 74KW 100CV 1796CC C 18 NE 0039665 - OPEL KADETT E (T85) 1.8 i (C19, D19) 08.1989/05.199...		R220254 NO. 1336749 - 1336783 - 90424150 <i>TUBO INFERIOR SAÍDA ÁGUA DO RADIADOR</i> OPEL KADETT B: 1.7 08.1967/08.1971 55KW 75CV 1698CC - OPEL KADETT B Coupé: 1.9 08.1967/08.1973 66KW 90CV 1897CC
	B325-34/32mm 284-80mm 2f-d7mm 3p-d15x26mm		B250-d45/35mm 75-175-85mm
	R220263 NO. 1336870 <i>TUBO DO RADIADOR DO AQUECIMENTO PARA O MOTOR</i> OPEL KADETT C City 1.0 05.1975/07.1979 29KW 40CV 993CC 10 N 0039520 0039290 0039293 - OPEL KADETT C Combi 1.0 01.1974/07.1979 29KW 40CV 993CC 10 N 0039248 - OPEL KADETT C Coupé 1.0 01.1974/07.1979 29KW 40CV 993CC 10 N 0039247 - OPEL KADETT C K 180 1.0 01.1974/07.1979 29KW 40CV 993CC 10 N 0039244 0039246		R220277 NO. 1336752 - 1336855 <i>TUBO DE RADIADOR SUPERIOR</i> OPEL KADETT B 1.1 09.1965/07.1971 33KW 45CV 1078CC 11 N 0039445 0039317 0039315
	B210-31/34mm 51-120-44-85mm		B185-d32/53mm 125-125mm
	R220277 NO. 1336752 - 1336855 <i>TUBO DE RADIADOR SUPERIOR</i> OPEL KADETT C 1.0 01.1974/07.1979 29KW 40CV 993CC 10 N 0039244 0039246		R220280 NO. 1818218 <i>TUBO DO AQUECIMENTO</i> OPEL KADETT C 1.0 01.1974/07.1979 29KW 40CV 993CC 10 N 0039244 0039246
	B185-d32/53mm 125-125mm		B140-d17/16mm 50-100-55mm

	<p>R220281 NO. 1818220</p> <p>TUBO DE RETORNO DA ÁGUA DO AQUECIMENTO</p> <p>OPEL KADETT C: 1.0 01.1974/07.1979 29KW 40CV 993CC</p> <p>B565-d16/18mm 115-95-210-165-115-55mm</p>		<p>R220284 NO. 1336250 - 1336251 - 1336316 - 90091138 - 99169012</p> <p>TUBO DE RADIADOR SUPERIOR</p> <p>OPEL KADETT D (31_-34_, 41_-44_) 1.3 N 08.1979/08.1984 44KW 60CV 1297CC - OPEL KADETT D (31_-34_, 41_-44_) 1.3 S 08.1979/08.1984 55KW 75CV 1297CC - OPEL KADETT D (32_-37_, 39_, 42_) 1.3 N 08.1979/08.1984 44KW 60CV 1297CC - OPEL KADETT D (32_-37_, 39_, 42_) 1.3 S 08.1979/08.1984 55KW 75CV 1297CC - OPEL KADETT D Combi (35_, 36_, 45_, 46_) 1.3 N 08.1979/08.1984 44KW 60CV 1297CC - OPEL KADETT D Combi...</p> <p>B225-d34/34mm 120-80-115mm</p>
	<p>R220284 NO. 82416660 - 82429521</p> <p>TUBO DE RADIADOR SUPERIOR</p> <p>OPEL KADETT E Hatchback (T85): 1.2 (C08, C48, D08, D48) 09.1984/07.1986 40KW 55CV 1196CC - OPEL KADETT E Hatchback (T85): 1.3 N (C08, C48, D08, D48) 09.1984/08.1991 44KW 60CV 1297CC - OPEL KADETT E Hatchback (T85): 1.3 N (C08, C48, D08, D48) 09.1984/08.1991 44KW 60CV 1297CC - OPEL KADETT E Hatchback (T85): 1.3 N (C08, C48, D08, D48) 09.1984/08.1991 44KW 60CV 1297CC - OPEL KADETT E Hatchback (T85): 1.3 i Cat (C08, C48, D08, D48) 09.1985/08.1991 44KW 60CV 1297CC - OPEL KADETT E Hatchback (T...</p> <p>B225-d34/34mm 120-80-115mm</p>		<p>R220285 NO. 1336244 - 1337051 - 90091137</p> <p>TUBO DE RADIADOR INFERIOR</p> <p>OPEL KADETT D (31_-34_, 41_-44_) 1.3 N 08.1979/08.1984 44KW 60CV 1297CC - OPEL KADETT D (31_-34_, 41_-44_) 1.3 N 0039577 1.3 S 08.1979/08.1984 55KW 75CV 1297CC 13 S 0039578 - OPEL KADETT D (32_-37_, 39_, 42_) 1.3 N 08.1979/08.1984 44KW 60CV 1297CC C 13 N - OPEL KADETT D (32_-37_, 39_, 42_) 1.3 S 08.1979/08.1984 55KW 75CV 1297CC 13 S - OPEL KADETT D Combi (35_, 36_, 45_, 46_) 1.3 N 08.1979/08.1984 44KW...</p> <p>B430-d34/34mm 45-220-140-100mm</p>
	<p>R220285 NO. 1336244 - 1337051 - 90091137</p> <p>TUBO DE RADIADOR INFERIOR</p> <p>OPEL KADETT E (T85) 1.3 i Cat (C19, D19) 09.1985/08.1991 44KW 60CV 1297CC C 13 N 0039662 - OPEL KADETT E (T85) 1.3 N (C19, D19) 09.1984/08.1989 44KW 60CV 1297CC 13 NB13 N 0039662 - OPEL KADETT E (T85) 1.3 S (C19, D19) 09.1984/08.1987 55KW 75CV 1297CC 13 S 0039663 - OPEL KADETT E (T85) 1.4 i (C19, D19) 01.1990/08.1991 44KW 60CV 1389CC C 14 NZ 0039829 - OPEL KADETT E Cabriolet (T85) 1.4 i 01.1990/08...</p> <p>B430-d34/34mm 45-220-140-100mm</p>		<p>R220286 NO. 1336242 - 90088086</p> <p>TUBO DE LIGAÇÃO DO RADIADOR À BOMBA DE ÁGUA</p> <p>OPEL KADETT D (31_-34_, 41_-44_) 1.3 N 08.1979/08.1984 44KW 60CV 1297CC 13 N 0039577 - OPEL KADETT D (31_-34_, 41_-44_) 1.3 S 08.1979/08.1984 55KW 75CV 1297CC 13 S 0039578 - OPEL KADETT D (32_-37_, 39_, 42_) 1.3 N 08.1979/08.1984 44KW 60CV 1297CC C 13 N - OPEL KADETT D (32_-37_, 39_, 42_) 1.3 S 08.1979/08.1984 55KW 75CV 1297CC 13 S - OPEL KADETT D Combi (35_, 36_, 45_, 46_) 1.3 N 08.1979/08.1984 44KW ...</p> <p>B145-d33/33mm 55-45-55mm</p>
	<p>R220286 NO. 1336242 - 90088086</p> <p>TUBO DE LIGAÇÃO DO RADIADOR À BOMBA DE ÁGUA</p> <p>OPEL KADETT E (T85) 1.3 i Cat (C19, D19) 09.1985/08.1991 44KW 60CV 1297CC C 13 N 0039662 - OPEL KADETT E (T85) 1.3 N (C19, D19) 09.1984/08.1989 44KW 60CV 1297CC 13 NB13 N 0039662 - OPEL KADETT E (T85) 1.3 S (C19, D19) 09.1984/08.1987 55KW 75CV 1297CC 13 S 0039663 - OPEL KADETT E Caixa/Combi (T85) 1.3 N (C70, D70) 09.1984/07.1989 44KW 60CV 1297CC 13 NB13 N 0039094 - OPEL KADETT E Combi (T85) 1.3 i ...</p> <p>B145-d33/33mm 55-45-55mm</p>		<p>R220535 NO. 60-210-80-115-80mm + ch d18 50-30-</p> <p>TUBO DE RADIADOR INFERIOR COM 3 VIAS</p> <p>OPEL KADETT E (T85) 1.6 D (C19, D19) 09.1984/01.1989 40KW 54CV 1598CC 16 DA16 D 0039667 - OPEL KADETT E Hatchback (T85) 1.6 D (C08, C48, D08, D48) 09.1984/01.1989 40KW 54CV 1598CC 16 DA16 D 0039643</p> <p>B480-d31/31mm 60-210-80-115-80mm + ch d18 50-30-35-70-70mm</p>
	<p>R220536 NO. 1336407 - 90220143</p> <p>TUBO SUPERIOR DO RADIADOR</p> <p>OPEL KADETT E (T85) 1.2 (C19, D19) 09.1984/07.1986 40KW 55CV 1196CC 12 SC 0039661 - OPEL KADETT E (T85) 1.3 i Cat (C19, D19) 09.1985/08.1991 44KW 60CV 1297CC C 13 N 0039662 - OPEL KADETT E (T85) 1.3 N (C19, D19) 09.1984/08.1989 44KW 60CV 1297CC 13 NB13 N 0039662 - OPEL KADETT E (T85) 1.3 S (C19, D19) 09.1984/08.1987 55KW 75CV 1297CC 13 S 0039663 - OPEL KADETT E Caixa/Combi (T85) 1.2 (C70, D70) 09...</p> <p>B380-34/54mm 50x70x70x240x80x80x80mm</p>		<p>R220537 NO. 1336408 - 90220144</p> <p>TUBO INFERIOR DO RADIADOR</p> <p>OPEL KADETT E (T85) 1.2 (C19, D19) 09.1984/07.1986 40KW 55CV 1196CC 12 SC 0039661 - OPEL KADETT E (T85) 1.3 i Cat (C19, D19) 09.1985/08.1991 44KW 60CV 1297CC C 13 N 0039662 - OPEL KADETT E (T85) 1.3 N (C19, D19) 09.1984/08.1989 44KW 60CV 1297CC 13 NB 13 N 0039662 - OPEL KADETT E (T85) 1.3 S (C19, D19) 09.1984/08.1987 55KW 75CV 1297CC 13 S 0039663 - OPEL KADETT E Caixa/Combi (T85) 1.2 (C70, D70) 09...</p> <p>B305-d29/d30mm 81-122-157mm</p>
	<p>R220538 NO. 1336426 - 90233006</p> <p>TUBO DE RADIADOR SUPERIOR</p> <p>OPEL KADETT E (T85) 1.6 D (C19, D19) 09.1984/01.1989 40KW 54CV 1598CC 16 DA16 D 0039667 - OPEL KADETT E Caixa/Combi (T85) 1.6 D (C70, D70) 08.1984/08.1988 40KW 54CV 1598CC 16 DA16 D 0039098 - OPEL KADETT E Combi (T85) 1.6 D (C15, C35, D15, D35) 09.1984/01.1989 40KW 54CV 1598CC 16 DA16 D 0039739 0039649 - OPEL KADETT E Combo (T85) 1.6 D (C25, D25) 01.1986/12.1989 40KW 54CV 1598CC 16 DA16 D 0039105 ...</p> <p>B70-d34/34mm 70-150-200-55mm</p>		<p>R220815 NO. 1336402 - 90183050</p> <p>TUBO DE RADIADOR SUPERIOR</p> <p>OPEL KADETT E (T85) 1.6 D (C19, D19) 09.1984/01.1989 40KW 54CV 1598CC 16 DA16 D 0039667 - OPEL KADETT E Caixa/Combi (T85) 1.6 D (C70, D70) 08.1984/08.1988 40KW 54CV 1598CC 16 DA16 D 0039098 - OPEL KADETT E Combi (T85) 1.6 D (C15, C35, D15, D35) 09.1984/01.1989 40KW 54CV 1598CC 16 DA16 D 0039739 0039649 - OPEL KADETT E Combo (T85) 1.6 D (C25, D25) 01.1986/12.1989 40KW 54CV 1598CC 16 DA16 D 0039105 ...</p> <p>B120-d34/34mm 90-60-85-70mm</p>
	<p>R220822 NO. 1337002 - 90348446</p> <p>TUBO DE RADIADOR INFERIOR</p> <p>OPEL KADETT E (T85) 1.6 D (C19, D19) 09.1984/01.1989 40KW 54CV 1598CC 16 DA16 D 0039667 - OPEL KADETT E (T85) 1.7 D (C19, D19) 02.1989/08.1991 42KW 57CV 1699CC 17 D 0039783 - OPEL KADETT E Hatchback (T85) 1.6 D (C08, C48, D08, D48) 09.1984/01.1989 40KW 54CV 1598CC 16 DA16 D 0039643 - OPEL KADETT E Hatchback (T85) 1.7 D (C08, C48, D08, D48) 02.1989/08.1991 42KW 57CV 1699CC 17 D 0039787 - OPEL KADETT...</p> <p>B485-d40/40mm 80-125-60-210-60mm</p>		<p>R220823 NO. 1337009 - 90325853</p> <p>TUBO DE RADIADOR SUPERIOR DE ENTRADA DE ÁGUA</p> <p>OPEL KADETT E (T85) 1.6 D (C19, D19) 09.1984/01.1989 40KW 54CV 1598CC 16 DA16 D 0039667 - OPEL KADETT E (T85) 1.7 D (C19, D19) 02.1989/08.1991 42KW 57CV 1699CC 17 D 0039783 - OPEL KADETT E Hatchback (T85) 1.6 D (C08, C48, D08, D48) 09.1984/01.1989 40KW 54CV 1598CC 16 DA16 D 0039643 - OPEL KADETT E Hatchback (T85) 1.7 D (C08, C48, D08, D48) 02.1989/08.1991 42KW 57CV 1699CC 17 D 0039787 - OPEL KADETT...</p> <p>B135-d34mm 50-140-50-40</p>
	<p>R221420 NO. 1337106 - 90421900</p> <p>TUBO SUPERIOR DE ENTRADA DE ÁGUA DO RADIADOR</p> <p>OPEL KADETT E Combo (T85) 1.7 D (C25, D25) 07.1992/07.1994 44KW 60CV 1699CC 17 DR17 D 0039120</p> <p>B135-d34mm 100-120-70mm</p>		<p>R221421 NO. 1337111 - 90421905</p> <p>TUBO INFERIOR DE SAÍDA DE ÁGUA DO RADIADOR</p> <p>OPEL KADETT E Combo (T85) 1.7 D (C25, D25) 07.1992/07.1994 44KW 60CV 1699CC 17 DR17 D 0039120</p> <p>B480-d38/34mm 70-135-255-70mm</p>

OPEL ADMIRAL - KADETT (A)-(B)-(C)-(D)-(E)

	<p>R221422 NO. 1818159</p> <p>TUBO DE ENTRADA DE ÁGUA DE AQUECIMENTO</p> <p>OPEL KADETT E Combo (T85) 1.7 D (C25, D25) 07.1992/07.1994 44KW 60CV 1699CC 17 DR17 D 0039120</p> <p>B450-d20/14mm 45-50-135-225-85-135-55mm</p>		<p>R221423 NO. 1818202</p> <p>TUBO RETORNO DE ÁGUA DE AQUECIMENTO</p> <p>OPEL KADETT E Combo (T85) 1.7 D (C25, D25) 07.1992/07.1994 44KW 60CV 1699CC 17 DR17 D 0039120</p> <p>B340-d20/15mm 55-55-5550-80-60-90-75mm</p>
	<p>R221470 NO. 1336485 - 90265784</p> <p>TUBO SUPERIOR DO RADIADOR</p> <p>OPEL KADETT E (T85) 1.4 S (C19, D19) (De 2001.1990 Até 2008.1991) 55kW 75cv 1389cm3 três volumes - OPEL KADETT E Cabriolet (T85) 1.4 S (De 2008.1990 Até 2002.1993) 55kW 75cv 1389cm3 Cabriolet - OPEL KADETT E Combi (T85) 1.4 S (De 2001.1990 Até 2008.1991) 55kW 75cv 1389cm3 Combi - OPEL KADETT E Combo (T85) 1.4 S (De 2007.1989 Até 2008.1991) 55kW 75cv 1389cm3 Caixa -</p> <p>B805-82/37mm 83x70x54x77mm</p>		<p>R221485 NO. 1336812 - 1337463 - 90265803 - 90530796</p> <p>TUBO DE LIGAÇÃO À BOMBA DE ÁGUA</p> <p>OPEL KADETT E (T85) 1.6 i (C19, D19) (De 1986.09 Até 1991.08) 55kW 75cv 1598cm3 três volumes - OPEL KADETT E (T85) 1.8 i (C19, D19) (De 1990.09 Até 1991.08) 66kW 90cv 1796cm3 três volumes - OPEL KADETT E (T85) 1.8 i (C19, D19) (De 1985.10 Até 1986.08) 74kW 100cv 1796cm3 três volumes - OPEL KADETT E (T85) 1.8 i (C19, D19) (De 1984.09 Até 1986.08) 85kW 115cv 1796cm3 três volume...</p> <p>B165-32/38mm 47x47x55mm</p>
	<p>R222719 NO. 1336294 - 1337395 - 90128078 - 90166058 - 90570030</p> <p>TUBO DE LIGAÇÃO TERMOSTATO À BOMBA DE ÁGUA</p> <p>OPEL KADETT E Hatchback (T85): 1.5 TD (C08, C48, D08, D48) 07.1988/08.1991 53KW 72CV 1488CC - OPEL KADETT E Hatchback (T85): 1.6 D (C08, C48, D08, D48) 09.1984/01.1989 40KW 54CV 1598CC - OPEL KADETT E Hatchback (T85): 1.7 D (C08, C48, D08, D48) 02.1989/08.1991 42KW 57CV 1699CC - OPEL KADETT E (T85): 1.5 TD (C19, D19) 07.1988/08.1991 53KW 72CV 1488CC - OPEL KADETT E (T85): 1.6 D (C19, D19) 09.1984/...</p> <p>boca a boca 137 mm d1 31mmd2 32mm</p>		<p>R222719 NO. 1336294 - 1337395 - 90128078 - 90166058 - 90570030</p> <p>TUBO DE LIGAÇÃO TERMOSTATO À BOMBA DE ÁGUA</p> <p>OPEL KADETT D (31_34_41_44_) 1.6 D 03.1982/08.1984 40KW 54CV 1598CC 16 D 0039606 - OPEL KADETT D (32_37_39_42) 1.6 D 03.1982/08.1984 40KW 54CV 1598CC 16 D - OPEL KADETT D Combi (35_36_45_46_) 1.6 D 03.1982/08.1984 40KW 54CV 1598CC 16 D 0039607</p> <p>boca a boca 137 mm d1 31mmd2 32mm</p>
	<p>R222769 NO. 1336509 - 1337465 - 90351806 - 90530799</p> <p>TUBO DE LIGAÇÃO AO TERMOSTATO</p> <p>OPEL KADETT D 2.0 i</p> <p>B220-d20/20mm 80-70-60-70-60mm</p>		<p>R222811 NO. 650872</p> <p>TUBO DE LIGAÇÃO AO TERMOSTATO</p> <p>OPEL KADETT E Hatchback (T85) 1.5 TD (C08, C48, D08, D48) (De 1988.07 Até 1991.08) 53kW 72cv 1488cm3 Hatchback - OPEL KADETT E (T85) 1.5 TD (C19, D19) (De 1988.07 Até 1991.08) 53kW 72cv 1488cm3 três volumes - OPEL KADETT E Combi (T85) 1.5 TD (C15, C35, D15, D35) (De 1988.07 Até 1991.08) 53kW 72cv 1488cm3 Combi -</p> <p>B57-15/15mm 50x22x50mm</p>
	<p>R222812 NO. 650873</p> <p>TUBO LIGAÇÃO TERMOSTATO</p> <p>OPEL KADETT E Hatchback (T85) 1.5 TD (C08 - C48 - D08 - D48) (De 07-1988 Até 08-1991) 53kW 72CV 1488cc Hatchback OPEL KADETT E (T85) 1.5 TD (C19 - D19) (De 07-1988 Até 08-1991) 53kW 72CV 1488cc três volumes OPEL KADETT E Combi (T85) 1.5 TD (C15 - C35 - D15 - D35) (De 07-1988 Até 08-1991) 53kW 72CV 1488cc Combi</p> <p>B97-14/14mm 60-41mm</p>		<p>R222871 NO. 650872 - 650873</p> <p>TUBOS DE LIGAÇÃO AO TERMOSTATO</p> <p>OPEL KADETT E (T85) MONZA 1.5 TD (C19, D19) 07.1988/08.1991 53KW 72CV 1488CC 15 TD 0039784 - OPEL KADETT E Combi (T85) 1.5 TD (C15, C35, D15, D35) 07.1988/08.1991 53KW 72CV 1488CC 15 TD 0039791 - OPEL KADETT E Hatchback (T85) 1.5 TD (C08, C48, D08, D48) 07.1988/08.1991 53KW 72CV 1488CC 15 TD 0039789 0039788</p> <p>B113-14/14mm B56-16/16mm 40x59mm 40x1540mm</p>
	<p>R2475 NO. 13362687 - 90128022</p> <p>TUBO INFERIOR DO RADIADOR</p> <p>OPEL KADETT E 1600-1800-2000-1600D-1800D-ASCONA-C-1600-1800E</p> <p>B180-d35/32mm 65-65-65mm</p>		<p>R8078 NO. 1336328 - 1337393 - 90322911 - 90570033</p> <p>TUBO DE LIGAÇÃO À BOMBA DE ÁGUA</p> <p>OPEL KADETT E (T85) 2.0 i (C19, D19) 09.1987/05.1992 85KW 115CV 1998CC 20 NE 0039766 - OPEL KADETT E Hatchback (T85) 2.0 GSI 16V (C08, C48, D08, D48) 12.1987/08.1991 115KW 156CV 1998CC 20 XE 0039772 - OPEL KADETT E Hatchback (T85) 2.0 GSI 16V (C08, C48, D08, D48) 03.1988/08.1991 110KW 150CV 1998CC 20 XEJC 20 XE 0039773 - OPEL KADETT E Hatchback (T85) 2.0 GSI 16V Cat (C08, C48, D08, D48) 03.1988/08...</p> <p>B171-d40/34mm d27mm 45-90-45mm 85-80mm</p>
	<p>R8080 NO. 1336294 - 1337395 - 2101-1303090 - 90128078 - 90166058 - 90570030 - 90916-01013</p> <p>TUBO DO RADIADOR À BOMBA DE ÁGUA</p> <p>OPEL KADETT D (31_34_41_44_) 1.6 D 03.1982/08.1984 40KW 54CV 1598CC 16 D 0039606 - OPEL KADETT D (32_37_39_42) 1.6 D 03.1982/08.1984 40KW 54CV 1598CC 16 D - OPEL KADETT D Combi (35_36_45_46_) 1.6 D 03.1982/08.1984 40KW 54CV 1598CC 16 D 0039607</p> <p>B140-d34/34mm 85-75mm</p>		<p>R8080 NO. 1336294 - 1337395 - 2101-1303090 - 90128078 - 90166058 - 90570030 - 90916-01013</p> <p>TUBO DO RADIADOR À BOMBA DE ÁGUA</p> <p>OPEL KADETT E (T85) 1.5 TD (C19, D19) 07.1988/08.1991 53KW 72CV 1488CC 15 TD 0039784 - OPEL KADETT E (T85) 1.6 D (C19, D19) 09.1984/01.1989 40KW 54CV 1598CC 16 DA 16 D 0039667 - OPEL KADETT E (T85) 1.7 D (C19, D19) 02.1989/08.1991 42KW 57CV 1699CC 17 D 0039783 - OPEL KADETT E Caixa/Combi (T85) 1.6 D (C70, D70) 08.1984/08.1988 40KW 54CV 1598 16 DA 16 D 0039098 - OPEL KADETT E Caixa/Combi (T85) 1.7 ...</p> <p>B140-d34/34mm 85-75mm</p>
	<p>RF80245 NO. 0606401 - 606401</p> <p>TUBO DE FERRO REFRIGERAÇÃO</p> <p>OPEL KADETT E Hatchback (T85) 1.8 S (C08 - C48 - D08 - D48) (De 09-1987 Até 08-1991) 62kW 84CV 1796cc Hatchback OPEL KADETT E Hatchback (T85) 1.8 i (C08 - C48 - D08 - D48) (De 06-1985 Até 08-1991) 66kW 90CV 1796cc Hatchback OPEL KADETT E Hatchback (T85) 1.8 E (C08 - C48 - D08 - D48) (De 10-1985 Até 08-1986) 74kW 100CV 1796cc Hatchback OPEL KADETT E Hatchback (T85) 1.8 GSI (C08 - C48 - D08 - D48...</p> <p>d35x51mm c45mm 1f-d31</p>		<p>RF80248 NO. ch-d30-25mm ch-d15-25mm ch-d13-25mm 2f-9mm...</p> <p>TUBO DE FERRO REFRIGERAÇÃO</p> <p>OPEL KADETT E Hatchback (T85) 1.7 D (C08 - C48 - D08 - D48) (De 02-1989 Até 08-1991) 42kW 57CV 1700cc Hatchback OPEL KADETT E (T85) 1.7 D (C19 - D19) (De 02-1989 Até 08-1991) 42kW 57CV 1700cc três volumes OPEL KADETT E Combi (T85) 1.7 D (C15 - C35 - D15 - D35) (De 02-1989 Até 08-1991) 42kW 57CV 1700cc Combi OPEL KADETT E Caixa (T85) 1.7 D (C70 - D70) (De 08-1988 Até 09-1992) 42kW 57CV 1700cc Ca...</p> <p>B470-28/34mm ch-d30-25mm ch-d15-25mm ch-d13-25mm 2f-9mm...</p>

	<p>RT08545 NO. 562345 - 562350 - 562358 - 90235568 - 90374106 - 90468316 - 90468319</p> <p>TUBO DE TRAVÃO FRENTE RH</p> <p>OPEL KADETT E Hatchback (T85): 1.2 (C08, C48, D08, D48) 09.1984/07.1986 40KW 55CV 1196CC - OPEL KADETT E Hatchback (T85): 1.3 N (C08, C48, D08, D48) 09.1984/08.1991 44KW 60CV 1297CC - OPEL KADETT E Hatchback (T85): 1.3 i Cat (C08, C48, D08, D48) 09.1985/08.1991 44KW 60CV 1297CC - OPEL KADETT E Hatchback (T85): 1.3 S (C08, C48, D08, D48) 09.1984/08.1987 55KW 75CV 1297CC - OPEL KADETT E Hatchback (T...</p> <p>310mm FB3/1 - OR1</p>		<p>RT80333 NO. 562342 - 562357 - 582357 - 90217551 - 90445761</p> <p>TUBO TRAVÃO TRÁS RH-LH</p> <p>OPEL KADETT E Caixa (T85) 1.2 (C70, D70) (De 1984.09 Até 1986.07) 40kW 55cv 1196cm3 Caixa - OPEL KADETT E Caixa (T85) 1.3 N (C70, D70) (De 1984.09 Até 1989.07) 44kW 60cv 1297cm3 Caixa - OPEL KADETT E Caixa (T85) 1.4 i (C70, D70) (De 1990.01 Até 1991.08) 44kW 60cv 1389cm3 Caixa - OPEL KADETT E Caixa (T85) 1.6 i (C70, D70) (De 1989.08 Até 1993.09) 55kW 75cv 1598cm3 Caixa -</p> <p>ØF0mm FA8 - FB3/1</p>
	<p>S0190 NO.</p> <p>SILENT-BLOC DE VAUS DE SUSPENSÃO</p> <p>OPEL KADETT B</p> <p>d32x28mm d30mm 1f-d15mm</p>		<p>S0191 NO.</p> <p>SILENT-BLOC DE VAUS DE SUSPENSÃO</p> <p>OPEL KADETT B</p> <p>d32x41mm d28mm 1f-d12mm</p>
	<p>S1023 NO.</p> <p>SILENT-BLOC DE VAUS SUSPENSÃO INFERIOR</p> <p>OPEL KADETT B 1.1 09.1965/07.1971 33KW 45CV 1078CC 11 N 0039445, 0039317, 0039315 - OPEL KADETT B 1.1 S 09.1965/07.1971 40KW 55CV 1078CC 11 S 0039446, 0039318, 0039316 - OPEL KADETT B 1.1 SR 11.1966/07.1971 44KW 60CV 1078CC 11 SR 0039422, 0039425, 0039447 - OPEL KADETT B Combi 1.1 09.1965/07.1971 33KW 45CV 1078CC 11 N 0039399, 00039388 - OPEL KADETT B Coupé 1.1 09.1965/07.1971 33KW 45CV 1078CC 11 N...</p> <p>d36x33mm d28mm 1f-d13mm</p>		<p>S1074 NO. 352334 - 352349 - 90235042 - 90335966 - 96335966</p> <p>SILENT-BLOC FRENTE DO BRAÇO DA SUSPENSÃO FRENTE C/ CASQUILHO</p> <p>OPEL KADETT D 1.0 - 1.2 - 1.3 - 1.6 - 1.8 - 2.0 - KADETT E 1.0 - 1.2 - 1.3 - 1.6 - 1.8 - 2.0</p> <p>d44x59mm d38mm 1fd-14mm</p>
	<p>S1075 NO. 90217845</p> <p>SILENT-BLOC DO BRAÇO DA SUSPENSÃO</p> <p>OPEL KADETT S- CASQUILHO</p> <p>d45x49mm d39mm 1f-d18mm</p>		<p>S1080 NO.</p> <p>SILENT-BLOC DE VAUS DE SUSPENSÃO</p> <p>OPEL KADETT C</p> <p>d39x41mm c29mm d30mm 1f-d12mm</p>
	<p>S1127 NO. 352300 - 352346</p> <p>SILENT-BLOC DO BRAÇO DA SUSPENSÃO FRENTE DIAM.12mm</p> <p>OPEL KADETT (E) 1.4S - 1.7D</p> <p>d43x60mm d38mm 1f-d12mm</p>		<p>S1128 NO. 90268463 - 0352348 - 352347 - 352348 - 353460 - 90250709</p> <p>SILENT-BLOC EXTERIOR DO BRAÇO DA SUSPENSÃO FRENTE DIAM.16mm</p> <p>OPEL KADETT (E) 1.4S - 1.7D</p> <p>d68x58mm d60mm 1f-d16mm</p>
	<p>S1198 NO. 352335 - 352345 - 90235040</p> <p>SILENT-BLOC DA SUSPENSÃO</p> <p>OPEL KADETT E 1.2 - 1.3 - 1.5TD - 1.6D - 1.7D - 1.8 (1984 A 1991)</p> <p>65x55x55mm 1f-d21mm 1f-d6mm</p>		<p>S1275 NO. 402642 - 90189050</p> <p>SILENT-BLOC DA SUSPENSÃO DE TRÁS</p> <p>OPEL KADETT E Hatchback (T85): 1.2 (C08, C48, D08, D48) 09.1984/07.1986 40KW 55CV 1196CC - OPEL KADETT E Hatchback (T85): 1.3 N (C08, C48, D08, D48) 09.1984/08.1991 44KW 60CV 1297CC - OPEL KADETT E Hatchback (T85): 1.3 i Cat (C08, C48, D08, D48) 09.1985/08.1991 44KW 60CV 1297CC - OPEL KADETT E Hatchback (T85): 1.3 S (C08, C48, D08, D48) 09.1984/08.1987 55KW 75CV 1297CC - OPEL KADETT E Hatchback (T...</p> <p>d56x 75mm c-63mm dc-48mm1f-d12mm</p>
	<p>S1275 NO. 402642 - 90189050</p> <p>SILENT-BLOC DA SUSPENSÃO DE TRÁS OE 402642 - 90189050</p> <p>OPEL KADETT D (31_-34_, 41_-44_): 1.0 09.1979/08.1982 30KW 41CV 993CC - OPEL KADETT D (31_-34_, 41_-44_): 1.0 09.1979/08.1984 33KW 45CV 993CC - OPEL KADETT D (31_-34_, 41_-44_): 1.0 08.1979/12.1983 37KW 50CV 993CC - OPEL KADETT D (31_-34_, 41_-44_): 1.2 08.1979/07.1982 39KW 53CV 1196CC - OPEL KADETT D (31_-34_, 41_-44_): 1.2 08.1982/08.1984 40KW 55CV 1196CC - OPEL KADETT D (31_-34_, 41_-44_): 1.2 ...</p> <p>d56x 75mm c-63mm dc-48mm1f-d12mm</p>		<p>T0001-E NO. 856516 - 856521</p> <p>BATENTE DE ESCAPE</p> <p>KADETT C K 180</p> <p>Informações</p> <p>Tipo</p> <p>Ano de construção</p> <p>kW</p> <p>HP</p> <p>cc</p> <p>Código(s) do motor</p> <p>Número KBA (Alemanha)</p> <p>1.0 01.1974 - 07.1979 29 40 993</p> <p>10 N</p> <p>0039244 0039246</p> <p>KADETT D (31_-34_, 41_-44_)</p> <p>Informações</p> <p>Tipo</p> <p>Ano de construção</p> <p>kW</p> <p>HP</p> <p>cc</p> <p>Código(s) do motor</p> <p>Número KBA (Alemanha)</p> <p>1.3 N 08.1979 - 08.1984 44 60 1297</p> <p>13 N</p> <p>0039577</p>

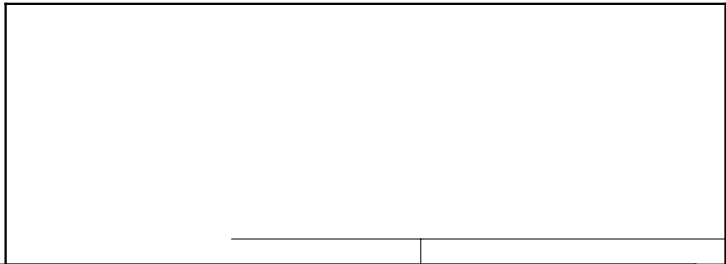

	<p>T0739-I NO. 13173321 - 22697919 - 24411014 - 90095608 - 90216605 - 90216613 - 90250393</p> <p>BATENTE APOIO DE SUSPENSÃO TRÁS (GASTA 2 UNIDADES)</p> <p>OPEL KADETT D (31_-34_, 41_-44_) 1.0 (De 08.1979 Até 12.1983) 37kW 50cv 993cm3 Hatchback - OPEL KADETT D (31_-34_, 41_-44_) 1.2 (De 08.1979 Até 07.1982) 39kW 53cv 1196cm3 Hatchback - OPEL KADETT D (31_-34_, 41_-44_) 1.2 (De 08.1982 Até 08.1984) 40kW 55cv 1196cm3 Hatchback - OPEL KADETT D (31_-34_, 41_-44_) 1.2 S (De 08.1979 Até 08.1984) 44kW 60cv 1196cm3 Hatchback - OPEL KADETT D (31_-34_, 41_-44_...</p> <p>d126x49mm 1f-d15mm</p>		<p>T0739-I NO. 13173321 - 22697919 - 24411014 - 90095608 - 90216605 - 90216613 - 90250393</p> <p>BATENTE APOIO DE SUSPENSÃO TRÁS (GASTA 2 UNIDADES)</p> <p>OPEL KADETT E (T85) 1.2 (C19, D19) (De 09.1984 Até 07.1986) 40kW 55cv 1196cm3 três volumes - OPEL KADETT E (T85) 1.3 N (C19, D19) (De 09.1984 Até 08.1989) 44kW 60cv 1297cm3 três volumes - OPEL KADETT E (T85) 1.3 S (C19, D19) (De 09.1984 Até 08.1987) 55kW 75cv 1297cm3 três volumes - OPEL KADETT E (T85) 1.3 i Cat (C19, D19) (De 09.1985 Até 08.1991) 44kW 60cv 1297cm3 três volumes - OPEL KADETT E (T85...</p> <p>d126x49mm 1f-d15mm</p>
--	--	---	--

	<p>UMB84001 NO. TAMPÃO BLOCO MOTOR OPEL KADETT E hatchback (T85) 1.3 S (C08, C48, D08, D48) 09.84 - 08.87 55 75 1297 hatchback</p>		<p>UMB84001L NO. TAMPÃO BLOCO DE MOTOR (RELAS) OPEL KADETT E hatchback (T85) 1.3 S (C08, C48, D08, D48) 09.84 - 08.87 55 75 1297 hatchback</p>
	<p>UMB84011 NO. 031126 TAMPÃO BLOCO MOTOR OPEL KADETT E Hatchback (T85) 1.2 (C08 - C48 - D08 - D48) (De 09-1984 Até 07-1986) 40kW 55CV 1196cc Hatchback OPEL KADETT E Hatchback (T85) 1.3 i Cat (C08 - C48 - D08 - D48) (De 09-1985 Até 08-1991) 44kW 60CV 1297cc Hatchback OPEL KADETT E Hatchback (T85) 1.4 i (C08 - C48 - D08 - D48) (De 01-1990 Até 08-1991) 44kW 60CV 1389cc Hatchback OPEL KADETT E Hatchback (T85) 1.4 S (C08 - C48 - D08 - D48)...</p>		<p>UMB84011L NO. 11062402 - 2060675 TAMPÃO BLOCO DE MOTOR (RELAS) OPEL KADETT E Hatchback (T85) 1.2 (C08 - C48 - D08 - D48) (De 09-1984 Até 07-1986) 40kW 55CV 1196cc Hatchback OPEL KADETT E Hatchback (T85) 1.3 i Cat (C08 - C48 - D08 - D48) (De 09-1985 Até 08-1991) 44kW 60CV 1297cc Hatchback OPEL KADETT E Hatchback (T85) 1.4 i (C08 - C48 - D08 - D48) (De 01-1990 Até 08-1991) 44kW 60CV 1389cc Hatchback OPEL KADETT E Hatchback (T85) 1.4 S (C08 - C48 - D08 - D48) (D...)</p>
	<p>UMB84016L NO. N01191410 - N0119142 - N0119143 - N0119148 - N0119149 TAMPÃO BLOCO DE MOTOR (RELAS) SEAT CORDOBA (6K1 - 6K2) 1.0 i (De 09-1996 Até 10-2002) 37kW 50CV 999cc três volumes SEAT CORDOBA (6K1 - 6K2) 1.4 (De 12-1997 Até 04-1999) 40kW 54CV 1390cc três volumes SEAT CORDOBA (6K1 - 6K2) 1.4 16V (De 05-2000 Até 10-2002) 55kW 75CV 1390cc três volumes SEAT CORDOBA (6K1 - 6K2) 1.4 i 16V (De 09-1996 Até 10-2002) 74kW 101CV 1390cc três volumes SEAT CORDOBA (6K1 - 6K2) 1.6 i (De 05-1994 Até 06-1...</p>		<p>UMB84019 NO. 2060668 TAMPÃO BLOCO MOTOR OPEL KADETT E Hatchback (T85) 1.3 N (C08 - C48 - D08 - D48) (De 09-1984 Até 08-1991) 44kW 60CV 1297cc Hatchback OPEL KADETT E Hatchback (T85) 1.3 i Cat (C08 - C48 - D08 - D48) (De 09-1985 Até 08-1991) 44kW 60CV 1297cc Hatchback OPEL KADETT E Hatchback (T85) 1.3 S (C08 - C48 - D08 - D48) (De 09-1984 Até 08-1987) 55kW 75CV 1297cc Hatchback OPEL KADETT E Hatchback (T85) 1.4 i (C08 - C48 - D08 - D48) ...</p>
	<p>UMB84019L NO. 2060668 TAMPÃO BLOCO DE MOTOR (RELAS) OPEL KADETT E Hatchback (T85) 1.3 N (C08 - C48 - D08 - D48) (De 09-1984 Até 08-1991) 44kW 60CV 1297cc Hatchback OPEL KADETT E Hatchback (T85) 1.3 i Cat (C08 - C48 - D08 - D48) (De 09-1985 Até 08-1991) 44kW 60CV 1297cc Hatchback OPEL KADETT E Hatchback (T85) 1.3 S (C08 - C48 - D08 - D48) (De 09-1984 Até 08-1987) 55kW 75CV 1297cc Hatchback OPEL KADETT E Hatchback (T85) 1.4 i (C08 - C48 - D08 - D48) ...</p>		<p>UMB84021 NO. 2060673 TAMPÃO BLOCO MOTOR (RELAS) OPEL KADETT E Hatchback (T85) 1.3 N (C08 - C48 - D08 - D48) (De 09-1984 Até 08-1991) 44kW 60CV 1297cc Hatchback OPEL KADETT E Hatchback (T85) 1.3 i Cat (C08 - C48 - D08 - D48) (De 09-1985 Até 08-1991) 44kW 60CV 1297cc Hatchback OPEL KADETT E Hatchback (T85) 1.3 S (C08 - C48 - D08 - D48) (De 09-1984 Até 08-1987) 55kW 75CV 1297cc Hatchback OPEL KADETT E Hatchback (T85) 1.4 i (C08 - C48 - D08 - D48) ...</p>
	<p>UMB84021L NO. 2060673 TAMPÃO BLOCO DE MOTOR (RELAS) OPEL KADETT E Hatchback (T85) 1.3 N (C08 - C48 - D08 - D48) (De 09-1984 Até 08-1991) 44kW 60CV 1297cc Hatchback OPEL KADETT E Hatchback (T85) 1.3 i Cat (C08 - C48 - D08 - D48) (De 09-1985 Até 08-1991) 44kW 60CV 1297cc Hatchback OPEL KADETT E Hatchback (T85) 1.3 S (C08 - C48 - D08 - D48) (De 09-1984 Até 08-1987) 55kW 75CV 1297cc Hatchback OPEL KADETT E Hatchback (T85) 1.4 i (C08 - C48 - D08 - D48) ...</p>		<p>UMB84029 NO. 2060946 TAMPÃO BLOCO MOTOR OPEL KADETT E Hatchback (T85) 1.2 (C08, C48, D08, D48) (09.84 A 07.86) 55cv 1196cc Hatchback - OPEL KADETT E Combo (T85) 1.7 D (C25, D25) (07.92 A 07.94) 60cv 1700cc Caixa</p>
	<p>UTR0626 NO. 1326003 TAMPÃO RADIADOR OPEL KADETT B 1.7 (De 1967.08 Até 1971.08) 55kW 75cv 1698cm3 três volumes -</p>		<p>UTR0800 NO. 1304240 - 1304654 - 1304659 - 1304660 - 1304661 - 1304665 - 1304666 - 1304667 - 1304853 - 90352470 - ... TAMPÃO RESERVATÓRIO LIQUIDO REFRIGERAÇÃO OPEL KADETT D (31_-34_, 41_-44_) 1.2 08.79 - 07.82 39 53 1196 Hatchback OPEL KADETT D (31_-34_, 41_-44_) 1.2 08.82 - 08.84 40 55 1196 Hatchback OPEL KADETT D (31_-34_, 41_-44_) 1.2 S 08.79 - 08.84 44 60 1196 Hatchback OPEL KADETT D (31_-34_, 41_-44_) 1.3 N 08.79 - 08.84 44 60 1297 Hatchback OPEL KADETT D (31_-34_, 41_-44_) 1.3 S 08.79 - 08.84 55 75 1297 Hatchback OPEL KADETT D (31_-34_, 41_-44_) 1.3 S 08.79 - 08.84 55 75 1297 Hatchback OPEL KADETT D (31_-34_, 41_-44_) 1...</p>
	<p>UTR0800 NO. 1304240 - 1304654 - 1304659 - 1304660 - 1304661 - 1304665 - 1304666 - 1304667 - 1304853 - 90352470 - ... TAMPÃO RESERVATÓRIO LIQUIDO REFRIGERAÇÃO OPEL KADETT E Hatchback 1.2 (09.84 A 07.86) 55cv 1196cc Hatchback - OPEL KADETT E Hatchback 1.3 N (09.84 A 08.91) 60cv 1297cc Hatchback - OPEL KADETT E Hatchback 1.3 i Cat (09.85 A 08.91) 60cv 1297cc Hatchback - OPEL KADETT E Hatchback 1.3 S (09.84 A 08.87) 75cv 1297cc Hatchback - OPEL KADETT E Hatchback 1.4 i (01.90 A 08.91) 60cv 1389cc Hatchback - OPEL KADETT E Hatchback 1.4 S (01.90 ...</p>		<p>UTR0800 NO. 1304240 - 1304654 - 1304659 - 1304660 - 1304661 - 1304665 - 1304666 - 1304667 - 1304853 - 90352470 - ... TAMPÃO RESERVATÓRIO LIQUIDO REFRIGERAÇÃO OPEL SINTRA 2.2 I 16V 11.96 - 04.99 104 141 2198 Veículo multiuso OPEL SINTRA 3.0 i 24V 11.96 - 04.99 148 201 2962 Veículo multiuso OPEL SINTRA 2.2 DTI 07.97 - 04.99 85 116 2171 Veículo multiuso</p>
	<p>UTR0811 NO. 1304659 - 1304660 - 1304661 - 1304666 - 1304666 - 1304853 - 4395513 - 90352470 - 90409256 - 90409257... TAMPÃO RESERVATÓRIO LIQUIDO REFRIGERAÇÃO OPEL KADETT E Hatchback (09.84 A 07.86) 55cv 1196cc Hatchback - OPEL KADETT E Hatchback (09.84 A 08.91) 60cv 1297cc Hatchback 4/9 - OPEL KADETT E Hatchback (09.85 A 08.91) 60cv 1297cc Hatchback - OPEL KADETT E Hatchback (09.84 A 08.87) 75cv 1297cc Hatchback - OPEL KADETT E Hatchback (01.90 A 08.91) 60cv 1389cc Hatchback - OPEL KADETT E Hatchback 1.4 S (01.90 A 08.91) 75cv 1389cc Hatchbac...</p>		<p>UTR0820 NO. 90352470 - 90409256 - 90409257 - 9041032690497472 - 90467473 TAMPÃO RESERVATÓRIO LIQUIDO REFRIGERAÇÃO OPEL KADETT D (31_-34_, 41_-44_) 1.2 (08.79 A 07.82) 53cv 1196cc Hatchback OPEL KADETT D (31_-34_, 41_-44_) 1.2 (08.82 A 08.84) 55cv 1196cc Hatchback - OPEL KADETT D (31_-34_, 41_-44_) 1.2 S (08.79 A 08.84) 60cv 1196cc Hatchback - OPEL KADETT D (31_-34_, 41_-44_) 1.3 N (08.79 A 08.84) 60cv 1297cc Hatchback - OPEL KADETT D (31_-34_, 41_-44_) 1.3 S (08.79 A 08.84) 75cv 1297cc Hatchback - ...</p>

	<p>UTR0820 NO. 90352470 - 90409256 - 90409257 - 9041032690497472 - 90467473</p> <p>TAMPÃO RESERVATÓRIO LIQUIDO REFRIGERAÇÃO</p> <p>OPEL KADETT E Hatchback (33_, 34_, 43_, 44_) 1.2 (09.84 A 07.86) 55cv 1196cc Hatchback - OPEL KADETT E Hatchback (33_, 34_, 43_, 44_) 1.3 N (09.84 A 08.91) 60cv 1297cc Hatchback - OPEL KADETT E Hatchback (33_, 34_, 43_, 44_) 1.3 i Cat (09.85 A 08.91) 60cv 1297cc Hatchback - OPEL KADETT E Hatchback (33_, 34_, 43_, 44_) 1.3 S (09.84 A 08.87) 75cv 1297cc Hatchback - OPEL KADETT E Hatchback (33...</p> <p>d62x23mm 1f-d53x12mm</p>		<p>UTR0820 NO. 90352470 - 90409256 - 90409257 - 9041032690497472 - 90467473</p> <p>TAMPÃO RESERVATÓRIO LIQUIDO REFRIGERAÇÃO</p> <p>OPEL SINTRA 2.2 i 16V (11.96 A 04.99) 141cv 2198cc Veículo multiuso - OPEL SINTRA 3.0 i 24V (11.96 A 04.99) 201cv 2962cc Veículo multiuso - OPEL SINTRA 2.2 DTI (07.97 A 04.99) 116cv 2171cc Veículo multiuso</p> <p>d62x23mm 1f-d53x12mm</p>
	<p>UTR0859 NO. 1650630 - 94539597 - 96293957 - 96312510 - 96351578 - 96420303 - 96536649</p> <p>TAMPÃO RESERVATÓRIO LIQUIDO REFRIGERAÇÃO</p> <p>OPEL KADETT D 1.2 (08.79 A 07.82) 53cv 1196cc Hatchback - OPEL KADETT D 1.2 (08.82 A 08.84) 55cv 1196cc Hatchback - OPEL KADETT D 1.2 S (08.79 A 08.84) 60cv 1196cc Hatchback - OPEL KADETT D 1.3 N (08.79 A 08.84) 60cv 1297cc Hatchback - OPEL KADETT D 1.3 S (08.79 A 08.84) 75cv 1297cc Hatchback - OPEL KADETT D 1.6 S (09.81 A 08.84) 90cv 1598cc Hatchback - OPEL KADETT D 1.8 G T / E (02.83...</p> <p>d63x23mm 1f-d53x11mm</p>		<p>UTR0859 NO. 1650630 - 94539597 - 96293957 - 96312510 - 96351578 - 96420303 - 96536649</p> <p>TAMPÃO RESERVATÓRIO LIQUIDO REFRIGERAÇÃO</p> <p>OPEL KADETT E Hatchback (T85) 1.2 (09.84 A 07.86) 55cv 1196cc Hatchback - OPEL KADETT E Hatchback (T 85) 1.3 N (09.84 A 08.91) 60cv 1297cc Hatchback - OPEL KADETT E Hatchback (T 85) 1.3 i Cat (09.85 A 08.91) 60cv 1297cc Hatchback - OPEL KADETT E Hatchback (T 85) 1.3 S (09.84 A 08.87) 75cv 1297cc Hatchback - OPEL KADETT E Hatchback (T 85) 1.4 i (01.90 A 08.91) 60cv 1389cc Hatchback - ...</p> <p>d63x23mm 1f-d53x11mm</p>
	<p>UTR1305 NO. 0650089 - 650089</p> <p>TAMPÃO DO RESERVATÓRIO ÓLEO</p> <p>OPEL KADETT E (T85) 1.2 (C19, D19) (09.1984 -07.1986) 40kw 55cv 1196cm3 três volumes OPEL KADETT E (T85) 1.3 N (C19, D19) (09.1984 -08.1989) 44kw 60cv 1297cm3 três volumes OPEL KADETT E (T85) 1.3 S (C19, D19) (09.1984 -08.1987) 55kw 75cv 1297cm3 três volumes OPEL KADETT E (T85) 1.3 i Cat (C19, D19) (09.1985 -08.1991) 44kw 60cv 1297cm3 três volumes OPEL KADETT E (T85) 1.4 S (C19, D19) (01.1990 -08....</p> <p>d61x23mm d32x19mm</p>		<p>UTR1305 NO. 0650089 - 650089</p> <p>TAMPÃO DO RESERVATÓRIO ÓLEO</p> <p>OPEL KADETT E Cabriolet (T85) 1.3 S (03.1987 -02.1993) 55kw 75cv 1297cm3 Cabriolet OPEL KADETT E Cabriolet (T85) 1.4 S (08.1990 -02.1993) 55kw 75cv 1389cm3 Cabriolet OPEL KADETT E Cabriolet (T85) 1.4 i (01.1990 -08.1991) 44kw 60cv 1389cm3 Cabriolet OPEL KADETT E Cabriolet (T85) 1.6 i (10.1986 -02.1993) 55kw 75cv 1598cm3 Cabriolet OPEL KADETT E Cabriolet (T85) 1.6 i (07.1989 -02.1993) 60kw 82cv 159...</p> <p>d61x23mm d32x19mm</p>
	<p>UTR1305 NO. 0650089 - 650089</p> <p>TAMPÃO DO RESERVATÓRIO ÓLEO</p> <p>OPEL KADETT E Caixa/Combi (T85) 1.2 (C70, D70) (09.1984 -07.1986) 40kw 55cv 1196cm3 Caixa/Combi OPEL KADETT E Caixa/Combi (T85) 1.3 N (C70, D70) (09.1984 -07.1989) 44kw 60cv 1297cm3 Caixa/Combi OPEL KADETT E Caixa/Combi (T85) 1.4 i (C70, D70) (01.1990 -08.1991) 44kw 60cv 1389cm3 Caixa/Combi OPEL KADETT E Caixa/Combi (T85) 1.6 D (C70, D70) (08.1984 -08.1988) 40kw 54cv 1598cm3 Caixa/Combi OPEL KADETT...</p> <p>d61x23mm d32x19mm</p>		<p>UTR1305 NO. 0650089 - 650089</p> <p>TAMPÃO DO RESERVATÓRIO ÓLEO</p> <p>OPEL KADETT E Combo (T85) 1.3 N (C25, D25) (01.1986 -12.1989) 44kw 60cv 1297cm3 Caixa/Combi OPEL KADETT E Combo (T85) 1.3 S (C25, D25) (01.1986 -12.1989) 55kw 75cv 1297cm3 Caixa/Combi OPEL KADETT E Combo (T85) 1.4 S (C25, D25) (07.1989 -08.1991) 55kw 75cv 1389cm3 Caixa/Combi OPEL KADETT E Combo (T85) 1.4 i (C25, D25) (08.1991 -07.1994) 44kw 60cv 1389cm3 Caixa/Combi OPEL KADETT E Combo (T85) 1.6 (C...)</p> <p>d61x23mm d32x19mm</p>
	<p>UTR1305 NO. 0650089 - 650089</p> <p>TAMPÃO DO RESERVATÓRIO ÓLEO</p> <p>OPEL KADETT E Hatchback (T85) 1.2 (C08, C48, D08, D48) (09.1984 -07.1986) 40kw 55cv 1196cm3 Hatchback OPEL KADETT E Hatchback (T85) 1.3 N (C08, C48, D08, D48) (09.1984 -08.1991) 44kw 60cv 1297cm3 Hatchback OPEL KADETT E Hatchback (T85) 1.3 S (C08, C48, D08, D48) (09.1984 -08.1987) 55kw 75cv 1297cm3 Hatchback OPEL KADETT E Hatchback (T85) 1.3 i Cat (C08, C48, D08, D48) (09.1985 -08.1991) 44kw 60cv ...</p> <p>d61x23mm d32x19mm</p>		<p>UTV83011 NO. 0652475 - 09275631 - 652475 - 652491 - 90409376 - 9275631 - N90288901</p> <p>TAMPÃO VEDAÇÃO BUJÃO</p> <p>OPEL KADETT E Hatchback (T85) 1.2 (C08 - C48 - D08 - D48) (De 09-1984 Até 07-1986) 40kW 55CV 1196cc Hatchback OPEL KADETT E Hatchback (T85) 1.3 i Cat (C08 - C48 - D08 - D48) (De 09-1985 Até 08-1991) 44kW 60CV 1297cc Hatchback OPEL KADETT E Hatchback (T85) 1.3 S (C08 - C48 - D08 - D48) (De 09-1984 Até 08-1987) 55kW 75CV 1297cc Hatchback OPEL KADETT E Hatchback (T85) 1.4 i (C08 - C48 - D08 - D48) (D...)</p> <p>19x18mm c12mm d14mm</p>
	<p>W5045 NO. 5614417 - 614457 - 614637 - 97011870 - 97129070</p> <p>POLIE DA CAMBOTA (1+1+1 PISTAS)</p> <p>OPEL KADETT E Hatchback (T85): 1.5 TD (C08, C48, D08, D48) 07.1988/08.1991 53KW 72CV 1488CC - OPEL KADETT E (T85): 1.5 TD (C19, D19) 07.1988/08.1991 53KW 72CV 1488CC</p> <p>d139mm d48mm</p>		<p>W5069 NO. 614654</p> <p>POLIE DA CAMBOTA (6 PISTAS)</p> <p>OPEL SINTRA 2.2i 16v MOTOR X22XE (11-1996 A 04-1999)</p> <p>d140/141mm d42mm</p>
	<p>W5178 NO. 614473 - 90448439</p> <p>POLIE DA CAMBOTA (1+1 PISTAS)</p> <p>OPEL KADETT E Combo (T85): 1.7 D (C25, D25) 07.1992/07.1994 44KW 60CV 1700C</p> <p>d146mm d41mm</p>		<p>W5185 NO. 614473 - 90448439</p> <p>POLIE DA CAMBOTA (1+1 PISTAS)</p> <p>OPEL KADETT E Combo (T85): 1.7 D (C25, D25) 07.1992/07.1994 44KW 60CV 1700C</p> <p>d146mm d42mm</p>
	<p>Y3000 NO. 854917 - 854977 - 854980 - 90128081</p> <p>PARAFUSO MOLA DE ESCAPE</p> <p>OPEL KADETT E (1984 A 1993)</p> <p>82x13mm 1p-d10-20mm</p>		<p>Y3004 NO. 854982 - 90128082</p> <p>PARAFUSO ESCAPE</p> <p>OPEL KADETT E (1984 A 1991)</p> <p>d19x65mm d12mm 1r-d10mm</p>

	Y3212	NO. 1008501 - 1008504 - 4709077		Y3212	NO. 1008501 - 1008504 - 4709077
	PARAFUSO PERNO RODA CHAVE 17 M12X1,50X48MM (BASE CONICA PARA JANTES AÇO E LIGA LEVE) OPEL KADETT D (31_-34_, 41_-44_) 1.2 (08.1979 - 07.1982) 39kw 53cv 1196cm3 Hatchback OPEL KADETT D (31_-34_, 41_-44_) 1.2 (08.1982 - 08.1984) 40kw 55cv 1196cm3 Hatchback OPEL KADETT D (31_-34_, 41_-44_) 1.2 S (08.1979 - 08.1984) 44kw 60cv 1196cm3 Hatchback OPEL KADETT D (31_-34_, 41_-44_) 1.3 N (08.1979 - 08.1984) 44kw 60cv 1297cm3 Hatchback OPEL KADETT D (31_-34_, 41_-44_) 1.3 S (08.1979 - 08.198...			PARAFUSO PERNO RODA CHAVE 17 M12X1,50X48MM (BASE CONICA PARA JANTES AÇO E LIGA LEVE) OPEL KADETT E (T85) 1.2 (C19, D19) 09.1984 - 07.1986) 40kw 55cv 1196cm3 três volumes OPEL KADETT E (T85) 1.3 N (C19, D19) 09.1984 - 08.1989) 44kw 60cv 1297cm3 três volumes OPEL KADETT E (T85) 1.3 S (C19, D19) 09.1984 - 08.1987) 55kw 75cv 1297cm3 três volumes OPEL KADETT E (T85) 1.3 i Cat (C19, D19) 09.1985 - 08.1991) 44kw 60cv 1297cm3 três volumes OPEL KADETT E (T85) 1.4 S (C19, D19) 01.1990 - 08....	
C48mm (Ch-17mm)		M12x1,50x22mm	C48mm (Ch-17mm)		M12x1,50x22mm
	Z55237	NO. 090087290		Z80458	NO.
	MOLA DE FIXAÇÃO CAVA DE RODA OPEL KADETT			Mola de painel OPEL KADETT (E)	
F8mm T16mm S1-2mm H11mm L8mm S1mm Z23mm			d14x10mm		1p-d9-5mm
	Z80477	NO. 174833		Z80540	NO. 2240861 - 90022049
	Mola de friso OPEL KADETT (E) (Após 1979)			Mola de painel OPEL KADETT (E)	
39x34.5x7mm			d12x14.3mm		1p-d7-12.3mm
	Z80655	NO. 2338955 - 2338961 - 2346824 - 8964.57 - 8964.81 - 90283614 - 90431553		Z80661	NO. 1218601 - 90181010
	MOLA REVESTIMENTO DO HABITÁCULO OPEL KADETT E Hatchback (T85): 1.2 (C08, C48, D08, D48) 09.1984/07.1986 40KW 55CV 1196CC - OPEL KADETT E Hatchback (T85): 1.3 N (C08, C48, D08, D48) 09.1984/08.1991 44KW 60CV 1297CC - OPEL KADETT E Hatchback (T85): 1.3 i Cat (C08, C48, D08, D48) 09.1985/08.1991 44KW 60CV 1297CC - OPEL KADETT E Hatchback (T85): 1.3 S (C08, C48, D08, D48) 09.1984/08.1987 55KW 75CV 1297CC - OPEL KADETT E Hatchback (T...			MOLA SUPORTE FAROL PRINCIPAL (GASTA 2 UNIDADES) OPEL KADETT E Hatchback (T85): 1.2 (C08, C48, D08, D48) 09.1984/07.1986 40KW 55CV 1196CC - OPEL KADETT E Hatchback (T85): 1.3 N (C08, C48, D08, D48) 09.1984/08.1991 44KW 60CV 1297CC - OPEL KADETT E Hatchback (T85): 1.3 i Cat (C08, C48, D08, D48) 09.1985/08.1991 44KW 60CV 1297CC - OPEL KADETT E Hatchback (T85): 1.3 S (C08, C48, D08, D48) 09.1984/08.1987 55KW 75CV 1297CC - OPEL KADETT E Hatchback (T...	
d14x17.5mm		1p-d8-15.5mm	27.5x22x20mm		
	Z9000	NO. 25501711 - 854880 - 854881 - 854884 - 858884 - 90234204		Z9011	NO. 1261479 - 1449282600 - 4709339 - 4711509 - 854880
	MOLA DE ESCAPE 42mm OPEL KADETT E (1984 A 1991) - KADETT D (1979 A 1984)			MOLA DE ESCAPE OPEL KADETT D	
d18x26mm			d23x42mm		
	Z9011	NO. 1261479 - 1449282600 - 4709339 - 4711509 - 854880			
	MOLA DE ESCAPE OPEL KADETT E				
d23x42mm					

OPEL AGILA

	E0037	NO. 09161012 - 4500712 - 4500762 - 9161012 - 9161062		E0601-M	NO. 50510781 - 55703436
	ESTICADOR SUPORTE DE ESCAPE OPEL AGILA (B) (H08) 1.0 (F68) 04.2008/06.2011 48KW 65CV 996CC K10B 0035A1M			ESTICADOR SUPORTE APOIO MOTOR TRAS OPEL AGILA (B) (H08): 1.3 CDTI (F68) 04.2008/04.2010 55KW 75CV 1248CC	
50x50x28mm			210x97x46mm		1f-d12mm 1f-d13mm 1r-d10mm

	F1820-I NO. 4705777 FOLE DE TRANSMISSAO LADO DA CAIXA TRIPODE OPEL AGILA (A) (H00): 1.0 12V (F68) 09.2000/12.2007 43KW 58CV 973CC - OPEL AGILA (A) (H00): 1.0 (F68) 08.2003/12.2007 44KW 60CV 998CC - OPEL AGILA (A) (H00): 1.2 16V (F68) 09.2000/12.2007 55KW 75CV 1199CC d85x88mm 1f-d73mm 1f-d19mm		F1829H-I NO. 1603005 - 20424726 - 26067603 - 26070498 FOLE DA TRANSMISSÃO JUNTO À RODA OPEL AGILA 1.0i 12V - 1.2i 16v (APÓS 2000) d90x130mm 1f-d72mm 1f-d23mm
	KF2371-T NO. 1603005 - 20424726 - 26067603 - 26070498 KIT DE FOLE DO CARDAN JUNTO À RODA OPEL AGILA 1.0i 12V - 1.2i 16v (APÓS 2000) d88x126mm 1f-d72mm 1f-d23mm		M6019 NO. 4709341 JUNTA DE ESCAPE OPEL AGILA (B) (H08): 1.0 (F68) 04.2008/06.2011 48KW 65CV 996CC - OPEL AGILA (B) (H08): 1.0 LPG (F68) 01.2010/06.2011 48KW 65CV 996CC - OPEL AGILA (B) (H08): 1.0 (F68) 07.2011/07.2014 50KW 68CV 996CC - OPEL AGILA (B) (H08): 1.2 (F68) 04.2008/10.2012 63KW 86CV 1242CC - OPEL AGILA (B) (H08): 1.2 LPG (F68) 04.2008/10.2010 63KW 86CV 1242CC - OPEL AGILA (B) (H08): 1.2 (F68) 04.2010/10.2014 69KW 94CV 124... d51x4mm 1f-d43.6mm
	Q2009 NO. UNIÃO DE ESCAPE 47/52,5x90mm OPEL - AGILA (A) (H00) - 1.3 CDTI (08.03 - 12.07) 70cv 1248cc Hatchback 90x58x78mm 1f-d47mm		R017112 NO. 5851946 - 93177469 TUBO DA VALVULA REGULADORA DE VELOCIDADE OPEL AGILA (A) (H00): 1.3 CDTI (F68) 08.2003/12.2007 51KW 70CV 1248CC - OPEL AGILA (B) (H08): 1.3 CDTI (F68) 04.2008/04.2010 55KW 75CV 1248CC B133-14/14mm 39x64x29x51mm
	R019213 NO. 55245385 TUBO EXTRATOR COMBUSTIVEL OPEL AGILA (B) (H08): 1.3 CDTI (F68) 04.2008/04.2010 55KW 75CV 1248CC B-340/3mm 4p-d5x10mm		R019214 NO. 0817329 - 093177371 - 817329 - 93177371 - 93177414 - 93190052 - GM93177371 TUBO EXTRATOR DE COMBUSTIVEL OPEL AGILA (A) (H00) 1.3 CDTI (F68) 08.2003/12.2007 51KW 70CV 1248CF Z 13 DT 0035518 0035AHS B455-3mm 4p-d5x10mm
	R221743 NO. 055351522 - 05656121 - 0656092 - 55578995 - 5656121 - 656092 TUBO RESPIRO DO CARTER CAMBOTA OPEL AGILA (A) (H00) 1.0 (F68) (08.2003 - 12.2007) 44kw 60cv 998cm3 Hatchback OPEL AGILA (A) (H00) 1.0 12V (F68) (09.2000 - 12.2007) 43kw 58cv 973cm3 Hatchback OPEL AGILA (A) (H00) 1.2 16V Twinport (F68) (07.2004 - 12.2007) 59kw 80cv 1229cm3 Hatchback boca a boca175mmd1-15mm d220mm 73		R221748 NO. 5851946 - 93177469 TUBO DA VALVULA REGULADORA DE VELOCIDADE OPEL AGILA (A) (H00) 1.3 CDTI (F68) 08.2003/12.2007 51KW 70CV 1248CC Z 13 DT 0035518 0035AHS B140-17/17mm 70x30x80x35mm
	R222830 NO. 4707177 - 9214220 TUBO INFERIOR DO RADIADOR OPEL AGILA (A) (H00) 1.3 CDTI (F68) (De 08.2003 Até 12.2007) 51kW 70cv 1248cm3 Hatchback - B193-d25/d27mm 64-60-70mm		R222857 NO. 13157694 - 6818559 TUBO DO PERMUTADOR DO CALOR DO AQUECIMENTO OPEL AGILA (A) (H00) 1.3 CDTI (F68) (De 2003.08 Até 2007.12) 51kW 70cv 1248cm3 Hatchback - B213-19/21mm 46x51x65x66mm
	RT08932 NO. 4700362 - 5155083E00 - 9204000 TUBO DE TRAVÃO FRENTE LH-RH OPEL AGILA TT APÓS 09-2000 440mm FB52 - OR31		RT08933 NO. 4701124 - 5157076G00 - 5177076G00 - 9206661 TUBO DE TRAVÃO TRÁS LH-RH OPEL AGILA TT APÓS 09-2000 305mm FB52 - FB52
	S1299 NO. 4705163 SILENT-BLOC DAS MOLAS TRÁS PARTE DA FRENTE OPEL AGILA d46x64mm c50mm 1f-d12mm		S1806 NO. 4705163 SILENT-BLOC OSCILANTE SUSPENSÃO FRENTE OPEL AGILA (A) (H00): 1.0 12V (F68) 09.2000/12.2007 43KW 58CV 973CC - OPEL AGILA (A) (H00): 1.0 (F68) 08.2003/12.2007 44KW 60CV 998CC - OPEL AGILA (A) (H00): 1.2 16V (F68) 09.2000/12.2007 55KW 75CV 1199CC - OPEL AGILA (A) (H00): 1.2 16V Twinport (F68) 07.2004/12.2007 59KW 80CV 1229CC - OPEL AGILA (A) (H00): 1.3 CDTI (F68) 08.2003/12.2007 51KW 70CV 1248CC d46x64mm c50mm 1f-d12mm



	<p>UAP81292 NO. 0821038 - 0821074 - 0821437 - 0821675 - 4708869 - 4809347 - 821038 - 821074 - 821437 - 821675</p> <p>ANILHA PROTEÇÃO TÉRMICA INJECTORES</p> <p>OPEL AGILA (A) (H00) 1.3 CDTI (F68) (De 08-2003 Até 12-2007) 51kW 70CV 1248cc Hatchback OPEL AGILA (B) (H08) 1.3 CDTI (F68) (De 04-2008 Até 04-2010) 55kW 75CV 1248cc Hatchback</p> <p>d16x1mm 1f-d7mm</p>		<p>UAP81292 NO. 0821038 - 0821074 - 0821437 - 0821675 - 4708869 - 4809347 - 821038 - 821074 - 821437 - 821675</p> <p>ANILHA PROTEÇÃO TÉRMICA INJECTORES</p> <p>OPEL AGILA (A) (H00) 1.3 CDTI (F68) (De 08-2003 Até 12-2007) 51kW 70CV 1248cc Hatchback OPEL AGILA (B) (H08) 1.3 CDTI (F68) (De 04-2008 Até 04-2010) 55kW 75CV 1248cc Hatchback</p> <p>d16x1mm 1f-d7mm</p>
	<p>UTR0604 NO. 4709376 - 93194271</p> <p>TAMPÃO DO RADIADOR (1,1 BAR)</p> <p>OPEL AGILA (B) (H08) 1.0 (F68) (De 2008.04 Até 2011.06) 48kW 65cv 996cm3 Hatchback - OPEL AGILA (B) (H08) 1.0 LPG (F68) (De 2010.01 Até 2011.06) 48kW 65cv 996cm3 Hatchback - OPEL AGILA (B) (H08) 1.0 (F68) (De 2011.07 Até 2014.07) 50kW 68cv 996cm3 Hatchback - OPEL AGILA (B) (H08) 1.2 (F68) (De 2008.04 Até 2012.10) 63kW 86cv 1242cm3 Hatchback - OPEL AGILA (B) (H08) 1.2 (F68) (De 2012.11 Até 2014.07) 63kW 86cv 1242cm3 Hatchback</p> <p>d64x45x24mm d28x21mm</p>		<p>UTR0605 NO. 4707263</p> <p>TAMPÃO DO RADIADOR</p> <p>OPEL AGILA (A) (H00) 1.3 CDTI (F68) (De 08.2003 Até 12.2007) 51kW 70cv 1248cm3 Hatchback -</p> <p>d64x45x24mm d28x21mm</p>
	<p>UTR0800 NO. 1304240 - 1304654 - 1304659 - 1304660 - 1304661 - 1304665 - 1304666 - 1304667 - 1304853 - 90352470 - ...</p> <p>TAMPÃO RESERVATÓRIO LIQUIDO REFRIGERAÇÃO</p> <p>OPEL AGILA (A) (H00) 1.0 12V (09.00 A 12.07) 58cv 973cc Hatchback - OPEL AGILA (A) (H00) 1.0 (08.03 A 12.07) 60cv 998cc Hatchback - OPEL AGILA (A) (H00) 1.2 16V (09.00 A 12.07) 75cv 1199cc Hatchback - OPEL AGILA (A) (H00) 1.2 16V Twinport (07.04 A 12.07) 80cv 1229cc Hatchback</p> <p>d62x25mm 1f-d53x14mm</p>		<p>UTR0820 NO. 90352470 - 90409256 - 90409257 - 9041032690497472 - 90467473</p> <p>TAMPÃO RESERVATÓRIO LIQUIDO REFRIGERAÇÃO</p> <p>OPEL AGILA (A) (H00) 1.0 12V (09.00 A 12.07) 58cv 973cc Hatchback - OPEL AGILA (A) (H00) 1.0 (08.03 A 12.07) 60cv 998cc Hatchback - OPEL AGILA (A) (H00) 1.2 16V (09.00 A 12.07) 75cv 1199cc Hatchback - OPEL AGILA (A) (H00) 1.2 16V Twinport (07.04 A 12.07) 80cv 1229cc Hatchback - OPEL AGILA (A) (H00) 1.3 CDTI (08.03 A 12.07) 70cv 1248cc Hatchback</p> <p>d62x23mm 1f-d53x12mm</p>
	<p>UTR0838 NO. 09040925 - 1304654 - 1304659 - 1304660 - 1304661 - 1304665 - 1304666 - 1304667 - 1304853 - 90352470 - ...</p> <p>TAMPÃO RESERVATÓRIO LIQUIDO REFRIGERAÇÃO</p> <p>OPEL AGILA (A) (H00) 1.0 (08.03 A 12.07) 60cv 998cc Hatchback - OPEL AGILA (A) (H00) 1.2 16V (09.00 A 12.07) 75cv 1199cc Hatchback - OPEL AGILA (A) (H00) 1.2 16V Twinport (07.04 A 12.07) 80cv 1229cc Hatchback</p> <p>62x19mm 1f-d53x12mm</p>		<p>UTR1300 NO. 00650090 - 05650831</p> <p>TAMPÃO RESERVATÓRIO DO OLEO</p> <p>OPEL AGILA (A) (H00) 1.2 16V (F68) (De 09-2000 Até 12-2007) 55kW 75CV 1199cc Hatchback</p> <p>d59x31mm d45x12mm</p>
	<p>UTR1305 NO. 0650089 - 650089</p> <p>TAMPÃO DO RESERVATÓRIO ÓLEO</p> <p>OPEL AGILA (A) (H00) 1.0 (F68) 08.2003/12.2007 44KW 60CV 998CC Z 10 XEP 0035517 0035AHR - OPEL AGILA (A) (H00) 1.0 12V (F68) 09.2000/12.2007 43KW 58CV 973CC Z 10 XE 0035388 - OPEL AGILA (A) (H00) 1.2 16V (F68) 09.2000/12.2007 55KW 75CV 1199CC Z 12 XE 0035389 - OPEL AGILA (A) (H00) 1.2 16V Twinport (F68) 07.2004/12.2007 59KW 80CV 1229CC Z 12 XEP 0035533 0035AHT - OPEL AGILA (A) (H00) 1.3 CDTI (F68)...</p> <p>d61x23mm d32x19mm</p>		<p>UTV83019 NO. 0652315 - 0652477 - 652315 - 652477 - 90502556 - 96023264</p> <p>TAMPÃO VEDAÇÃO BUJÃO</p> <p>OPEL AGILA (A) (H00) 1.0 12V (F68) (De 09-2000 Até 12-2007) 43kW 58CV 973cc Hatchback OPEL AGILA (A) (H00) 1.0 (F68) (De 08-2003 Até 12-2007) 44kW 60CV 998cc Hatchback OPEL AGILA (A) (H00) 1.2 16V (F68) (De 09-2000 Até 12-2007) 55kW 75CV 1199cc Hatchback OPEL AGILA (A) (H00) 1.2 16V Twinport (F68) (De 07-2004 Até 12-2007) 59kW 80CV 1229cc Hatchback</p> <p>d25x14mm c9mm d13mm</p>
	<p>W5054 NO. 0614150 - 5614438 - 614150 - 93177317 - 93194443</p> <p>POLIE DA CABBOTA (6 PISTAS)</p> <p>OPEL AGILA 1.3 CDTI 16v APÓS 08-2003 - Mtr Z13DT (70CV)</p> <p>d165mm d35mm</p>		<p>W5201 NO. 5614423 - 90572867</p> <p>POLIE DA CABBOTA (5 PISTAS)</p> <p>OPEL AGILA (A) (H00): 1.0 12V (F68) 09.2000/12.2007 43KW 58CV 973CC - OPEL AGILA (A) (H00): 1.0 (F68) 08.2003/12.2007 44KW 60CV 998CC - OPEL AGILA (A) (H00): 1.2 16V (F68) 09.2000/12.2007 55KW 75CV 1199CC - OPEL AGILA (A) (H00): 1.2 16V Twinport (F68) 07.2004/12.2007 59KW 80CV 1229CC</p> <p>d152mm d39mm</p>
	<p>Y3212 NO. 1008501 - 1008504 - 4709077</p> <p>PARAFUSO PERNO RODA CHAVE 17 M12X1,50X48MM (BASE CONICA PARA JANTES AÇO E LIGA LEVE)</p> <p>OPEL AGILA (A) (H00) 1.0 (F68) (08.2003 - 12.2007) 44kw 60cv 998cm3 Hatchback OPEL AGILA (A) (H00) 1.0 12V (F68) (09.2000 - 12.2007) 43kw 58 973cm3 Hatchback OPEL AGILA (A) (H00) 1.2 16V (F68) (09.2000 - 12.2007) 55kw 75cv 1199cm3 Hatchback OPEL AGILA (A) (H00) 1.2 16V Twinport (F68) 07.2004 - 12.2007) 59kw 80cv 1229cm3 Hatchback OPEL AGILA (A) (H00) 1.3 CDTI (F68) (08.2003 - 12.2007) 51kw 70cv 12...</p> <p>C48mm (Ch-17mm) M12x1,50x22mm</p>		<p>Z9011 NO. 1261479 - 1449282600 - 4709339 - 4711509 - 854880</p> <p>MOLA DE ESCAPE</p> <p>OPEL AGILA</p> <p>d23x42mm</p>

	<p>U0314 NO. 0424761</p> <p>ANILHA DA SUSPENSÃO DAS MOLAS DE TRÁS INFERIOR</p> <p>OPEL AMPERA (R12) EV 150 (11.2011 - 03.2015) 111KW 151CV 1398CM3 Hatchback</p>		<p>UTR0856 NO. 1305248 - 13502353</p> <p>TAMPÃO RESERVATÓRIO LIQUIDO REFRIGERAÇÃO</p> <p>OPEL AMPERA (R12) EV 150 (De 11-2011 Até .1-20 -) 111KW 151CV 1398cc Hatchback</p>
	<p>UTR0862 NO. 1305248 - 13502353</p> <p>TAMPÃO RESERVATÓRIO LIQUIDO REFRIGERAÇÃO</p> <p>OPEL AMPERA (R12) EV 150 (De 11-2011 Até 03-2015) 111KW 151CV 1398cc Hatchback</p>		<p>Y3227 NO. 0328004 - 09595179 - 09599302 - 11611063 - 15651585 - 9595179</p> <p>PARAFUSO DA RODA CAVILHA</p> <p>OPEL AMPERA (R12) EV 150 (11.2011 - 03.2015) 111kw 151cv 1398cm3 Hatchback</p>
	<p>Z55280 NO. 2228839</p> <p>MOLA PAINEL REVESTIMENTO DAS PORTAS</p> <p>OPEL AMPERA (R12) EV 150 11.2011/03.2015 111KW 151CV 1398CC A 14 XFL 0035ARU 0035AYJ 0035BES</p>		
F-G-mm	T-27L-18H-12S-5mm		

OPEL ANTARA - GRANDLAND - GRANDLAND X

	<p>A2478 NO. 4813909</p> <p>APOIO DO MOTOR PARTE DE TRÁS</p> <p>OPEL ANTARA A (L07): 2.4 07.2006/12.2011 104KW 141CV 2405CC - OPEL ANTARA A (L07): 2.4 09.2008/12.2011 103KW 140CV 2405CC - OPEL ANTARA A (L07): 2.4 12.2010/12.2011 123KW 167CV 2384CC - OPEL ANTARA A (L07): 2.4 4x4 12.2010/12.2011 123KW 167CV 2384CC - OPEL ANTARA A (L07): 2.0 CDTI 03.2007/12.2011 93KW 127CV 1991CC - OPEL ANTARA A (L07): 2.0 CDTI 09.2008/12.2011 93KW 127CV 1991CC - OPEL ANTARA A (L07): 2.0 CDTI 01.2016/08.2017 125KW 170CV 1956CC B 20 DTH 0035BII - OPEL ANTARA A (L07): 2.0 CDTI 4x4 08.2006/12.2011 110KW 150CV 1991CC Z 20 DMH 0035AKG</p>		<p>A2658 NO. 0446073 - 20781756 - 20992595 - 20992596 - 4807201 - 4813841 - 96624771 - 96624772</p> <p>APOIO DA TRANSMISSÃO LONGITUDINAL</p> <p>OPEL ANTARA A (L07) 2.0 CDTI 08.2006/12.2011 110KW 150CV 1991CC Z 20 DMH 0035AKG - OPEL ANTARA A (L07) 2.0 CDTI 03.2007/12.2011 93KW 127CV 1991CC Z 20 S 0035AHQ - OPEL ANTARA A (L07) 2.0 CDTI 09.2008/12.2011 93KW 127CV 1991CC Z 20 DM 0035AJB - OPEL ANTARA A (L07) 2.0 CDTI 01.2016/08.2017 125KW 170CV 1956CC B 20 DTH 0035BII - OPEL ANTARA A (L07) 2.0 CDTI 4x4 08.2006/12.2011 110KW 150CV 1991CC Z 20 DMH 0035AKG</p>
	<p>A2660 NO. 0446073 - 20781756 - 20781756 - 446073 - 4807201 - 4813841</p> <p>APOIO DA TRANSMISSÃO</p> <p>OPEL ANTARA A (L07) 2.0 CDTI 08.2006/12.2011 110KW 150CV 1991CC Z 20 DMH 0035AKG - OPEL ANTARA A (L07) 2.0 CDTI 03.2007/12.2011 93KW 127CV 1991CC Z 20 S 0035AHQ - OPEL ANTARA A (L07) 2.0 CDTI 09.2008/12.2011 93KW 127CV 1991CC Z 20 DM 0035AJB - OPEL ANTARA A (L07) 2.0 CDTI 01.2016/08.2017 125KW 170CV 1956CC B 20 DTH 0035BII - OPEL ANTARA A (L07) 2.0 CDTI 4x4 08.2006/12.2011 110KW 150CV 1991CC Z 20 DMH 0035AKG</p>		<p>E0321 NO. 4804642 - 96626150 - 96996460</p> <p>ESTICADOR BARRA ESTABILIZADORA TRAS (GASTA 2 UNIDADES)</p> <p>OPEL ANTARA A (L07) 2.0 CDTI 08.2006/12.2011 110KW 150CV 1991CC Z 20 DMH 0035AKG - OPEL ANTARA A (L07) 2.0 CDTI 03.2007/12.2011 93KW 127CV 1991CC Z 20 S 0035AHQ - OPEL ANTARA A (L07) 2.0 CDTI 09.2008/12.2011 93KW 127CV 1991CC Z 20 DM 0035AJB - OPEL ANTARA A (L07) 2.0 CDTI desde 01.2016 125KW 170CV 1956CC B 20 DTH 0035BII - OPEL ANTARA A (L07) 2.0 CDTI 4x4 07.2006/12.2011 110KW 150CV 1991CC Z 20 DMH 0035AKG</p>
	<p>E1012 NO. 4805945</p> <p>ESTICADOR DE ESCAPE</p> <p>OPEL ANTAR</p>		<p>F4289 NO. 4803246</p> <p>FOLE DIREÇÃO (GASTA 2 UNIDADES)</p> <p>OPEL ANTARA A (L07) 2.0 CDTI 08.2006/12.2011 110KW 150CV 1991CC Z 20 DMH 0035AKG - OPEL ANTARA A (L07) 2.0 CDTI 03.2007/12.2011 93KW 127CV 1991CC Z 20 S 0035AHQ - OPEL ANTARA A (L07) 2.0 CDTI 09.2008/12.2011 93KW 127CV 1991CC Z 20 DM 0035AJB - OPEL ANTARA A (L07) 2.0 CDTI desde 01.2016 125KW 170CV 1956CC B 20 DTH 0035BII - OPEL ANTARA A (L07) 2.0 CDTI 4x4 07.2006/12.2011 110KW 150CV 1991CC Z 20 DMH 0035AKG</p>
	<p>R221498 NO. 4805187 - 96629079</p> <p>TUBO SUPERIOR DO RADIADOR</p> <p>OPEL ANTARA A (L07) 2.0 CDTI 08.2006/12.2011 110KW 150CV 1991CC Z 20 DMH 0035AKG - OPEL ANTARA A (L07) 2.0 CDTI 03.2007/12.2011 93KW 127CV 1991CC Z 20 S 0035AHQ - OPEL ANTARA A (L07) 2.0 CDTI 09.2008/12.2011 93KW 127CV 1991CV Z 20 DM 0035AJB - OPEL ANTARA A (L07) 2.0 CDTI 4x4 07.2006/12.2011 110KW 150CV 1991CC Z 20 DMH 0035AFX</p>		<p>R222781 NO. 4805190 - 96629082</p> <p>TUBO INFERIOR DO RADIADOR</p> <p>OPEL ANTARA A (L07) 2.0 CDTI 08.2006/12.2011 110KW 150CV 1991CC Z 20 DMH 0035AKG - OPEL ANTARA A (L07) 2.0 CDTI 03.2007/12.2011 93KW 127CV 1991CC Z 20 S 0035AHQ - OPEL ANTARA A (L07) 2.0 CDTI 09.2008/12.2011 93KW 127CV 1991CC Z 20 DM 0035AJB - OPEL ANTARA A (L07) 2.0 CDTI 4x4 07.2006/12.2011 110KW 150CV 1991CC Z 20 DMH 0035AFX</p>
B305-d32/d32mm	68-116-89mm		B620-d29/d31mm 63-69-175-235-142mm









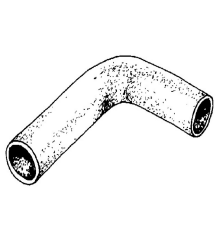
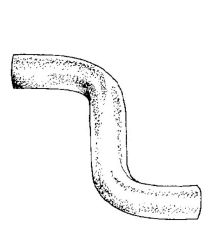
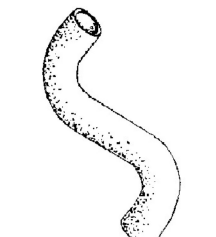

	<p>R222782 NO. 4805191 - 96629083</p> <p>TUBO INFERIOR DO RADIADOR</p> <p>OPEL ANTARA A (L07) 2.4 07.2006/12.2011 104KW 141CV 2405CC Z 24 XE 0035AFV - OPEL ANTARA A (L07) 2.4 desde 12.2010 123KW 167CV 2384CC A 24 XE A 24 XF 0035ARC 0035ARI</p> <p>B575-d32/d32mm 59-63-107-112-105-78-57mm</p>		<p>R224220 NO. 0382PJ</p> <p>TUBO DO AR SOBREALIMENTAÇÃO</p> <p>OPEL GRANDLAND / GRANDLAND X (A18, P1UO) 1.6 Turbo D (75) desde 06.2017 88KW 120CV 1560CC B 16 DTH (DV6FC) 0035BLB 1844AAM</p> <p>B124-46/46mm 124mm</p>
	<p>R225493 NO. 3647457 - 9820100780</p> <p>TUBO DO AR SOBREALIMENTAÇÃO</p> <p>OPEL GRANDLAND / GRANDLAND X (A18, P1UO) 1.2 (75) (06.2017 -) 96kw 131cv 1199cm3 SUV OPEL GRANDLAND / GRANDLAND X (A18, P1UO) 1.5 Turbo D (75) (06.2018 - 07.2021) 75kw 102cv 1499cm3 SUV OPEL GRANDLAND / GRANDLAND X (A18, P1UO) 1.5 Turbo D (75) (04.2018 -) 96kw 131cv 1499cm3 SUV OPEL GRANDLAND / GRANDLAND X (A18, P1UO) 1.6 Turbo D (75) (06.2017 - 07.2021) 88kw 120cv 1560cm3 SUV</p> <p>boca a boca290mmd1-46mm/d32mm118-85-83-62-156-77</p>		<p>R225493 NO. 3647457 - 9820100780</p> <p>TUBO DO AR SOBREALIMENTAÇÃO</p> <p>OPEL GRANDLAND X Van 1.5 (75) (04.2018 - 07.2021) 96kw 131cv 1499cm3 Caixa/SUV</p> <p>boca a boca290mmd1-46mm/d32mm118-85-83-62-156-77</p>
	<p>R227016 NO. 4805198 - 96629118</p> <p>TUBO DE LIGAÇÃO À BOMBA DE ÁGUA</p> <p>OPEL ANTARA A (L07) 2.0 CDTI 08.2006/12.2011 110KW 150CV 1991CC Z 20 DMH 0035AKG - OPEL ANTARA A (L07) 2.0 CDTI 09.2008/12.2011 93KW 127CV 1991CC Z 20 DM 0035AJB - OPEL ANTARA A (L07) 2.0 CDTI 4x4 07.2006/12.2011 110KW 150CV 1991CF Z 20 DMH 0035AFX</p> <p>B106-d34/d34mm mm</p>		<p>S1965 NO. 4804655 - 4804808 - 96626433 - 96626434</p> <p>SILENT-BLOC DO BRAÇO SUSPENSÃO TRANSVERSAL PARTE DE CIMA</p> <p>OPEL ANTARA A (L07): 2.4 07.2006/12.2011 104KW 141CV 2405CC - OPEL ANTARA A (L07): 2.4 09.2008/12.2011 103KW 140CV 2405CC - OPEL ANTARA A (L07): 2.4 12.2010/»» 123KW 167CV 2384CC - OPEL ANTARA A (L07): 2.4 4x4 12.2010/»» 123KW 167CV 2384CC - OPEL ANTARA A (L07): 3.0 11.2010/12.2015 190KW 258CV 2997CC - OPEL ANTARA A (L07): 3.2 V6 07.2006/12.2011 167KW 227CV 3195CC - OPEL ANTARA A (L07): 2.0 CDTI...</p> <p>d37x55mm c40mm 1f-d14mm</p>
	<p>S1980 NO. 4802540 - 4802541 - 4806300 - 4806301 - 4810831 - 4812870 - 4817777 - 4817778</p> <p>SILENT-BLOC DO BRAÇO SUSPENSÃO FRENTE PARTE FRENTE</p> <p>OPEL ANTARA A (L07): 2.4 07.2006/12.2011 104KW 141CV 2405CC - OPEL ANTARA A (L07): 2.4 09.2008/12.2011 103KW 140CV 2405CC - OPEL ANTARA A (L07): 2.4 4x4 08.2006/12.2011 103KW 140CV 2405CC - OPEL ANTARA A (L07): 2.4 LPG 10.2008/»» 103KW 140CV 2405CC - OPEL ANTARA A (L07): 2.4 LPG 4x4 08.2006/12.2010 103KW 140CV 2405CC - OPEL ANTARA A (L07): 2.4 LPG 4x4 08.2006/12.2010 103KW 140CV 2405CC - OPEL ANTARA A (L07): 2.4 12.2010/»» 123KW 167CV 2384CC - OPEL ANTARA A (L07):...</p> <p>d41x60mm d34mm 1f-d14mm</p>		<p>S2048 NO. 15146381 - 15146385 - 20756281 - 20756282 - 20763133 - 20763134 - 20763135 - 20763136 - 20830781 - 2...</p> <p>SILENT-BLOC DO BRAÇO SUSPENSÃO INFERIOR DA SUSPENSÃO TRÁS INTERIOR</p> <p>OPEL ANTARA A (L07) 2.0 CDTI (De 03.2007 Até 12.2011) 93kW 127cv 1991cm3 SUV - OPEL ANTARA A (L07) 2.0 CDTI (De 03.2007 Até 12.2011) 25504kW 93cv 127cm3 1991 - OPEL ANTARA A (L07) 2.0 CDTI (De 03.2007 Até 12.2011) 25504kW 93cv 127cm3 1991 - OPEL ANTARA A (L07) 2.0 CDTI (De 03.2007 Até 12.2011) 25504kW 93cv 127cm3 1991 - OPEL ANTARA A (L07) 2.0 CDTI (De 03.2007 Até 12.2011) 25504kW 93cv 127cm3 1991...</p> <p>d32x65mm c58mm 1f-d12mm</p>
	<p>S2125 NO. 4804653 - 4804807</p> <p>SILENT-BLOC DO BRAÇO SUSPENSÃO TRÁS SUPERIOR</p> <p>OPEL ANTARA A (L07) 2.0 CDTI (03.2007 - 12.2011) 93kw 127cv 1991cm3 SUV OPEL ANTARA A (L07) 2.0 CDTI (09.2008 - 12.2011) 93kw 127cv 1991cm3 SUV OPEL ANTARA A (L07) 2.0 CDTI (08.2006 - 12.2011) 110kw 150cv 1991cm3 SUV OPEL ANTARA A (L07) 2.0 CDTI (01.2016 -) 125kw 170cv 1956cm3 SUV OPEL ANTARA A (L07) 2.0 CDTI 4x4 (07.2006 - 12.2011) 110kw 150cv 1991cm3 SUV OPEL ANTARA A (L07) 2.0 CDTI 4x4 (01.2016...</p> <p>d39x52mm c45mm-1f-d14mm</p>		<p>S2126 NO. 4804807</p> <p>SILENT-BLOC DO BRAÇO SUSPENSÃO TRÁS INFERIOR</p> <p>OPEL ANTARA A (L07) 2.0 CDTI (03.2007 - 12.2011) 93kw 127cv 1991cm3 SUV OPEL ANTARA A (L07) 2.0 CDTI (09.2008 - 12.2011) 93kw 127cv 1991cm3 SUV OPEL ANTARA A (L07) 2.0 CDTI (08.2006 - 12.2011) 110kw 150cv 1991cm3 SUV OPEL ANTARA A (L07) 2.0 CDTI (01.2016 -) 125kw 170cv 1956cm3 SUV OPEL ANTARA A (L07) 2.0 CDTI 4x4 (07.2006 - 12.2011) 110kw 150cv 1991cm3 SUV OPEL ANTARA A (L07) 2.0 CDTI 4x4 (01.2016...</p> <p>d39x57mm c37mm-1f-d14mm</p>
	<p>S2131 NO. 4801822 - 4801823 - 4802563 - 4802564 - 4804655 - 4804808</p> <p>SILENT-BLOC DO EIXO SUSPENSÃO TRÁS SUPERIOR</p> <p>OPEL ANTARA A (L07) 2.0 CDTI (03.2007 - 12.2011) 93kw 127cv 1991cm3 SUV OPEL ANTARA A (L07) 2.0 CDTI (03.2007 - 12.2011) 93kw 127cv 1991cm3 SUV OPEL ANTARA A (L07) 2.0 CDTI (03.2007 - 12.2011) 93kw 127cv 1991cm3 SUV OPEL ANTARA A (L07) 2.0 CDTI (03.2007 - 12.2011) 93kw 127cv 1991cm3 SUV OPEL ANTARA A (L07) 2.0 CDTI (03.2007 - 12.2011) 93kw 127cv 1991cm3 SUV OPEL ANTARA A (L07) 2.0 CDTI (03.2007 - 12.2011) 93kw 127cv 1991cm3 SUV OPEL ANTARA A (L07) 2.0 CDTI (03.2007 - ...</p> <p>d35x52mm c40mm-1f-d14mm</p>		<p>S2167 NO. 4802180 - 4806299 - 4813822 - 4819804</p> <p>SILENT-BLOC DO EIXO SUSPENSÃO TRÁS INFERIOR</p> <p>OPEL ANTARA A (L07) 2.0 CDTI (03.2007 - 12.2011) 93kw 127cv 1991cm3 SUV OPEL ANTARA A (L07) 2.0 CDTI (03.2007 - 12.2011) 93kw 127cv 1991cm3 SUV OPEL ANTARA A (L07) 2.0 CDTI (03.2007 - 12.2011) 93kw 127cv 1991cm3 SUV OPEL ANTARA A (L07) 2.0 CDTI (03.2007 - 12.2011) 93kw 127cv 1991cm3 SUV OPEL ANTARA A (L07) 2.0 CDTI (03.2007 - 12.2011) 93kw 127cv 1991cm3 SUV OPEL ANTARA A (L07) 2.0 CDTI (03.2007 - ...</p> <p>d83x66mm c-36mm-dc-56mm-1f-d17mm</p>
	<p>S2168 NO. 4802180 - 4806299 - 4813822 - 4819804</p> <p>SILENT-BLOC DO EIXO SUSPENSÃO TRÁS INFERIOR</p> <p>OPEL ANTARA A (L07) 2.0 CDTI (03.2007 - 12.2011) 93kw 127cv 1991cm3 SUV OPEL ANTARA A (L07) 2.0 CDTI (03.2007 - 12.2011) 93kw 127cv 1991cm3 SUV OPEL ANTARA A (L07) 2.0 CDTI (03.2007 - 12.2011) 93kw 127cv 1991cm3 SUV OPEL ANTARA A (L07) 2.0 CDTI (03.2007 - 12.2011) 93kw 127cv 1991cm3 SUV OPEL ANTARA A (L07) 2.0 CDTI (03.2007 - 12.2011) 93kw 127cv 1991cm3 SUV OPEL ANTARA A (L07) 2.0 CDTI (03.2007 - ...</p> <p>d83x76mm c-36mm-dc-56mm-1f-d15mm</p>		<p>UAP81292 NO. 0821038 - 0821074 - 0821437 - 0821675 - 4708869 - 4809347 - 821038 - 821074 - 821437 - 821675</p> <p>ANILHA PROTEÇÃO TÉRMICA INJECTORES</p> <p>OPEL ANTARA (L07) 2.0 CDTI (De 03-2007 Até 12-2011) 93kW 127CV 1991cc Veículo todo-terreno fechado OPEL ANTARA (L07) 2.0 CDTI (De 09-2008 Até 12-2011) 93kW 127CV 1991cc Veículo todo-terreno fechado OPEL ANTARA (L07) 2.0 CDTI (De 08-2006 Até 12-2011) 110kW 150CV 1991cc Veículo todo-terreno fechado OPEL ANTARA (L07) 2.0 CDTI 4x4 (De 07-2006 Até 12-2011) 110kW 150CV 1991cc Veículo todo-terreno ...</p> <p>d16x1mm 1f-d7mm</p>
	<p>UAP81292 NO. 0821038 - 0821074 - 0821437 - 0821675 - 4708869 - 4809347 - 821038 - 821074 - 821437 - 821675</p> <p>ANILHA PROTEÇÃO TÉRMICA INJECTORES</p> <p>OPEL ANTARA (L07) 2.0 CDTI (De 03-2007 Até 12-2011) 93kW 127CV 1991cc Veículo todo-terreno fechado OPEL ANTARA (L07) 2.0 CDTI (De 09-2008 Até 12-2011) 93kW 127CV 1991cc Veículo todo-terreno fechado OPEL ANTARA (L07) 2.0 CDTI (De 08-2006 Até 12-2011) 110kW 150CV 1991cc Veículo todo-terreno fechado OPEL ANTARA (L07) 2.0 CDTI 4x4 (De 07-2006 Até 12-2011) 110kW 150CV 1991cc Veículo todo-terreno ...</p> <p>d16x1mm 1f-d7mm</p>		<p>UAP83244 NO. 055565375 - 55565375</p> <p>ANILHA PROTEÇÃO TÉRMICA INJECTORES</p> <p>OPEL ANTARA (L07) 2.0 CDTI (De 01-2016 Até 1-20 -) 125kW 170CV 1956cc Veículo todo-terreno fechado OPEL ANTARA (L07) 2.0 CDTI 4x4 (De 01-2016 Até 1-20 -) 125kW 170CV 1956cc Veículo todo-terreno fechado</p> <p>d15x2mm 1f-d7mm</p>

	N2335	NO. 175538		UTR0837	NO. 1793284CT0 - 2151600QAA - 2151600QAB - 4402429 - 7700805031 - 7700808836 - 9110429
	ANEL ESCAPE OPEL ARENA			TAMPÃO RESERVATÓRIO LÍQUIDO REFRIGERAÇÃO OPEL ARENA Caixa (A97): 1.9 D (TF1J/L, THBJ/L) 01.1997/12.2001 44KW 60CV 1870CC - OPEL ARENA Caixa (A97): 2.5 D (TF1G/M, THBG/M) 01.1997/12.2001 55KW 75CV 2499CC - OPEL ARENA Autocarro (A97): 1.9 D (TF1G/M, THBJ/L) 01.1997/12.2001 44KW 60CV 1870CC - OPEL ARENA Autocarro (A97): 2.5 D (TF1G/M, THBG/M) 01.1997/12.2001 55KW 75CV 2499CC	
	d65x15mm	1f-d36mm		52x22mm	1f-d45x10mm

OPEL ASCONA (A)-(B)-(C)

	A1191	NO. 0684197 - 684197 - 90184001		A1406	NO. 0650702 - 90233962
	APOIO DE MOTOR DIREITO OPEL ASCONA C Hatchback (J82): 1.6 D (F68, M68) 03.1982/08.1988 40KW 54CV 1598CC - OPEL ASCONA C (J82): 1.6 D (F11, M11, F68, M68) 03.1982/08.1988 40KW 54CV 1598CC			APOIO MOTOR ESQUERDO OPEL ASCONA C	
	115x90x84mm	2f-d10mm 3r-d10mm		d20x15mm	1p-d6-10mm 1p-d6-15mm
	A1634	NO. 0684234 - 24416555 - 684189 - 684234 - 90189477		A2242	NO. 0817744 - 817744 - 90080552
	APOIO DO MOTOR PARTE DA FRENTE ESQUERDO OPEL ASCONA C (J82) 1.6 (F11, F68, M11, M68) 09.1986/08.1988 60KW 82CV 1598CC 16 SV 0039668 - OPEL ASCONA C (J82) 1.6 (F11, M11, F68, M68) 09.1981/09.1987 55KW 75CV 1598CC 16 N 0039598 - OPEL ASCONA C (J82) 1.6 i (F11, M11, F68, M68) 09.1987/08.1988 55KW 75CV 1598CC E 16 LZ E 16 NZ 0039598 - OPEL ASCONA C (J82) 1.6 S (F11, M11, F68, M68) 09.1981/08.1986 66KW 90CV 1598CC 16 SH 0039599 - OPEL ASCONA...			APOIO DA BOMBA DO COMBUSTIVEL OPEL ASCONA C Hatchback (J82) 1.8 (F68, M68) (De 1987.09 Até 1988.08) 62KW 84cv 1796cm3 Hatchback - OPEL ASCONA C Hatchback (J82) 1.8 E (F68, M68) (De 1985.01 Até 1986.08) 74KW 100cv 1796cm3 Hatchback - OPEL ASCONA C Hatchback (J82) 1.8 i (F68, M68) (De 1982.09 Até 1986.08) 85KW 115cv 1796cm3 Hatchback - OPEL ASCONA C Hatchback (J82) 2.0 i (F68, M68) (De 1986.09 Até 1988.08) 85...	
	110x90x65mm	2p-d10-26mm 2r-d10mm		19x21mm	2p-d8x14mm
	A2557	NO. 0684248 - 684185 - 684248 - 90121917 - 90184728		C0233	NO. 1160724 - 90054143
	APOIO DO MOTOR LADO ESQUERDO À FRENTE OPEL ASCONA C (J82) 1.3 N (F11, M11, F69) (De 09.1981 Até 08.1986) 44KW 60cv 1297cm3 três volumes - OPEL ASCONA C (J82) 1.3 S (F11, M11, F68, M68) (De 09.1981 Até 08.1988) 55KW 75cv 1297cm3 três volumes - OPEL ASCONA C (J82) 1.6 (F11, F68, M11, M68) (De 09.1986 Até 08.1988) 60KW 82cv 1598cm3 três volumes - OPEL ASCONA C (J82) 1.6 (F11, M11, F68, M68) (De 09.1981 Até 09.1987) 55KW 75cv 1598cm3 três...			BOTÃO AFINAÇÃO CAPÔT OPEL ASCONA C (81_86_87_88_) 1.3 N (09.81 A 08.86) 60cv 1297cc três volumes - OPEL ASCONA C (81_86_87_88_) 1.3 S (09.81 A 08.88) 75cv 1297cc três volumes - OPEL ASCONA C (81_86_87_88_) 1.6 (09.81 A 09.87) 75cv 1598cc três volumes - OPEL ASCONA C (81_86_87_88_) 1.6 i (09.87 A 08.88) 75cv 1598cc três volumes - OPEL ASCONA C (81_86_87_88_) 1.6 i Cat (09.86 A 08.88) 75cv 1598cc...	
	143x92x64mm	2p-d10x22mm 2r-d8mm		d19x31mm	
	E0035	NO. 856524		E1003	NO. 0856519 - 856519 - 9281771
	ESTICADOR DE ESCAPE OPEL ASCONA C 1.3 (1981 A 1989)			ESTICADOR SUPORTE TRÁS DO ESCAPE OPEL ASCONA B (81_86_87_88_) 1.2 08.1976/02.1979 40KW 55CV 1196CC - OPEL ASCONA B (81_86_87_88_) 1.2 S 09.1975/02.1979 44KW 60CV 1196CC - OPEL ASCONA B (81_86_87_88_) 1.3 N 03.1979/08.1981 44KW 60CV 1297CC - OPEL ASCONA B (81_86_87_88_) 1.3 S 08.1979/08.1981 55KW 75CV 1297CC - OPEL ASCONA B (81_86_87_88_) 1.6 N 09.1975/08.1981 44KW 60CV 1584CC - OPEL ASCONA B (81...	
	58x42x42mm			50x44x42mm	2f-d5mm 2f-18x9mm
	F0460-I	NO. 322506		F0465-I	NO. 322501
	FOLE DIREÇÃO DIREITO/ESQUERDO (GASTA 2 UNIDADES) OPEL ASCONA B (81_86_87_88_) 1.2 08.1976/02.1979 40KW 55CV 1196CC 12 N 0039523 - OPEL ASCONA B (81_86_87_88_) 1.2 S 09.1975/02.1979 44KW 60CV 1196CC 12 S 0039500 - OPEL ASCONA B (81_86_87_88_) 1.3 N 03.1979/08.1981 44KW 60CV 1297CC 13 N 0039572 - OPEL ASCONA B (81_86_87_88_) 1.3 S 08.1979/08.1981 55KW 75CV 1297CC 13 S 0039589 - OPEL ASCONA B (81_86_87_88_) 1.6 N 09.19...			FOLE DIREÇÃO DIREITO/ESQUERDO (GASTA 2 UNIDADES) OPEL ASCONA A (81_86_87_88_) 1900 1.2 S 04.1972/08.1975 44KW 60CV 1196CC 12 S 0039207 0039208 - OPEL ASCONA B (81_86_87_88_) 1.2 08.1976/02.1979 40KW 55CV 1196CC 12 N 0039523	
	d70x190mm	1f-d22mm 1f-d40mm		d75x160mm	d52mm 1f-d40mm 1f-d33mm
	F0466-I	NO. 90090811 - 902825 - 902828 - 9105983		F0481-I	NO. 374019 - 90095087
	FOLE DIREÇÃO DIREITO/ESQUERDO (GASTA 2 UNIDADES) OPEL ASCONA C (J82) 1.3 N (F11, M11, F69) 09.1981/08.1986 44KW 60CV 1297CC 13 N 0039596 - OPEL ASCONA C (J82) 1.3 S (F11, M11, F68, M68) 09.1981/08.1988 55KW 75CV 1297CC 13 S 0039597 - OPEL ASCONA C (J82) 1.6 (F11, F68, M11, M68) 09.1986/08.1988 60KW 82CV 1598CC 16 SV 0039668 - OPEL ASCONA C (J82) 1.6 (F11, M11, F68, M68) 09.1981/09.1987 55KW 75CV 1598CC 16 N 0039598 - OPEL ASCONA C (J82) 1.6 D (F...			FOLE DO SEMI-EIXO EXTERNO OPEL ASCONA (C) 1.0 - 1.2 - C1.3 1.3S - 1.6 - 1.8 (8-79 a 83)	
	d78x165mm	1f-d41mm 1f-d51mm		d100x80mm	1f-d20mm1f-d75mm

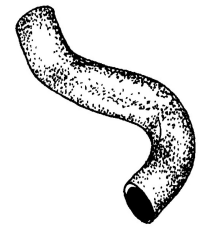
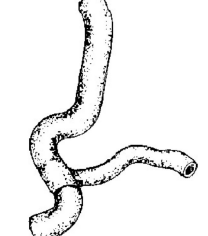
	F0519-I NO. 374040 - 90112609 - 90129014 FOLE DO SEMI-EIXO LADO DA CAIXA DE VELOCIDADES OPEL ASCONA (C) 1.6 (1981 A 1988) - 1.6i (1982 A 1988) - 1.8 (1987 A 1988) - 1.8i (1982 A 1986)		F0520-I NO. 374018 - 90095162 FOLE DO SEMI-EIXO INTERNO (F1026) OPEL ASCONA (C) 1.3S (1981 A 1988) - 1.3N (1981 A 1986)
	F1029 NO. 0402637 - 402637 FOLE APOIO SUPORTE REPARAÇÃO TRANSMISSÃO OPEL ASCONA B		F1305-I NO. 0902828 - 1609074 - 26024585 FOLE DA DIRECÇÃO ASSISTIDA LADO DIREITO E ESQUERDO OPEL ASCONA (C) 1.3S - 1.3N - 1.6S - 1.6D - 1.8 - 1.8E - 2.0i - 2.0iGT
	F1373-I NO. 1603141 - 374040 - 90009020 - 90112609 - 90421756 FOLE DA TRANSMISSÃO JUNTO À CAIXA OPEL ASCONA C 1.6 - 1.6S - 1.6i - 1.8 - 1.8i - 2.0i - 2.0iGT (81 A 88)		KF2300 NO. 374019 - 6152107500002 - 90095087 FOLE DO LADO DA RODA OPEL ASCONA (C) 1.0 - 1.2 - 1.3 C
	KF2310 NO. 374040 FOLE DO LADO DA RODA OPEL ASCONA C - DIESEL - 1.6 - 1.8 PETROL		L3020 NO. 0856700 - 856700 - 9275758 CASQUILHO DE ESCAPE OPEL ASCONA C Hatchback (J82): 1.3 S (F68, M68) 09.1981/08.1988 55KW 75CV 1297CC - OPEL ASCONA C (J82): 1.3 S (F11, M11, F68, M68) 09.1981/08.1988 55KW 75CV 1297CC - OPEL ASCONA C (J82): 1.6 (F11, M11, F68, M68) 09.1981/09.1987 55KW 75CV 1598CC - OPEL ASCONA C (J82): 1.6 i (F11, M11, F68, M68) 09.1987/08.1988 55KW 75CV 1598CC - OPEL ASCONA C (J82): 1.6 i Cat (F11, M11, F68, M68) 09.1986/08.198... d29x12mm d26/di19x8mm 1f-d9mm
	L3020 NO. 0856700 - 856700 - 9275758 CASQUILHO DE ESCAPE OPEL ASCONA A		L3020 NO. 0856700 - 856700 - 9275758 CASQUILHO DE ESCAPE OPEL ASCONA B
	M6036 NO. 02886093 - 02886931 - 854926 JUNTA DE ESCAPE OPEL ASCONA (B) (1971 A 1979)		M6041 NO. 854929 - 90091769 JUNTA DE ESCAPE OPEL ASCONA (B) (1979 A 1982) - ASCONA (C) (1981 A 1986)
	N2001 NO. 852707 - 852712 ANEL DE ESCAPE TRÁS OPEL ASCONA (A) (1972 A 1975)		N2335 NO. 0852713 - 09275338 - 852713 - 9275338 ANEL ESCAPE OPEL ASCONA C Hatchback (J82): 1.3 N (F68, M68) 09.1981/08.1986 44KW 60CV 1297CC - OPEL ASCONA C Hatchback (J82): 1.3 S (F68, M68) 09.1981/08.1988 55KW 75CV 1297CC - OPEL ASCONA C Hatchback (J82): 1.6 i (F68, M68) 09.1987/08.1988 55KW 75CV 1598CC - OPEL ASCONA C Hatchback (J82): 1.6 i Cat (F68, M68) 09.1986/08.1988 55KW 75CV 1598CC - OPEL ASCONA C Hatchback (J82): 1.8 E (F68, M68) 01.1985/08.1986 ... d70x14mm 1f-d46mm
	N2336 NO. 852711 - 9275338 ANEL ESCAPE OPEL ASCONA A (81_, 86_, 87_, 88_): 1.2 S 04.1972/08.1975 44KW 60CV 1196CC - OPEL ASCONA A (81_, 86_, 87_, 88_): 1.6 N 03.1975/08.1975 44KW 60CV 1584CC - OPEL ASCONA A (81_, 86_, 87_, 88_): 1.6 S 03.1975/08.1975 55KW 75CV 1584CC - OPEL ASCONA C Hatchback (J82): 2.0 i GT (F68, M68) 03.1987/08.1988 95KW 130CV 1998CC - OPEL ASCONA C (J82): 2.0 i GT (F11, M11, F68, M68) 03.1987/08.1988 95KW 130CV 1998... d62x14mm 1f-d36mm		N2336 NO. 852711 ANEL ESCAPE OPEL ASCONA A (81_, 86_, 87_, 88_): 1.2 S 04.1972/08.1975 44KW 60CV 1196CC - OPEL ASCONA A (81_, 86_, 87_, 88_): 1.6 N 03.1975/08.1975 44KW 60CV 1584CC - OPEL ASCONA A (81_, 86_, 87_, 88_): 1.6 N 10.1970/02.1975 50KW 68CV 1584CC - OPEL ASCONA A (81_, 86_, 87_, 88_): 1.6 S 03.1975/08.1975 55KW 75CV 1584CC - OPEL ASCONA A (81_, 86_, 87_, 88_): 1.6 S 10.1970/02.1975 59KW 80CV 1584CC - OPEL ASCONA A (... d62x14mm 1f-d36mm

	<p>N4021 NO. 852713</p> <p>ANEL DE ESCAPE</p> <p>OPEL ASCONA (B) (1975 A 1982) - ASCONA (C) (1981 A 1988)</p> <p>d60x14mm 1f-d33mm</p>		<p>P1012 NO. 0560808 - 560808 - 90105172</p> <p>CAPA PEDAL EMBRAIAGEM/TRAVAO (GASTA 2 UNIDADES)</p> <p>OPEL ASCONA C Hatchback (J82): 1.3 N (F68, M68) 09.1981/08.1986 44KW 60CV 1297CC - OPEL ASCONA C Hatchback (J82): 1.3 S (F68, M68) 09.1981/08.1988 55KW 75CV 1297CC - OPEL ASCONA C Hatchback (J82): 1.6 i Cat (F68, M68) 09.1986/08.1988 55KW 75CV 1598CC - OPEL ASCONA C Hatchback (J82): 1.6 (F68, M68) 09.1986/08.1988 60KW 82CV 1598CC - OPEL ASCONA C Hatchback (J82): 1.6 S (F68, M68) 09.1981/08.1986 66...</p> <p>60x55x9mm</p>
	<p>R0609 NO. 1336250 - 1336316 - 90091138 - 90169012</p> <p>TUBO SUPERIOR DO RADIADOR</p> <p>OPEL ASCONA C (J82) 1.3 N (F11, M11, F69) 09.1981/08.1986 44KW 60CV 1297CC 13 N 0039596</p> <p>B235-d34/34mm 180-145mm</p>		<p>R0615-M NO. 1336791 - 1336839 - 1336848 - M-220073</p> <p>TUBO SUPERIOR DO RADIADOR</p> <p>OPEL ASCONA A (81_, 86_, 87_, 88_) 1.2 S 04.1972/08.1975 44KW 60CV 1196CC 12 S 0039207 0039208</p> <p>B290-d38/34mm 105-175-90mm</p>
	<p>R220073 NO. 1336782 - 1336791 - 1336839 - 1336844 - 90121917</p> <p>TUBO DE RADIADOR SUPERIOR</p> <p>OPEL ASCONA A (81_, 86_, 87_, 88_) : 1.6 N 03.1975/08.1975 44KW 60CV 1584CC - OPEL ASCONA A (81_, 86_, 87_, 88_) : 1.6 N 10.1970/02.1975 50KW 68CV 1584CC - OPEL ASCONA A (81_, 86_, 87_, 88_) : 1.6 S 03.1975/08.1975 55KW 75CV 1584CC - OPEL ASCONA A (81_, 86_, 87_, 88_) : 1.6 S 10.1970/02.1975 59KW 80CV 1584CC - OPEL ASCONA A (81_, 86_, 87_, 88_) : 1.9 SR 03.1975/08.1975 65KW 88CV 1897CC - OPEL ASCONA A ...</p> <p>B340-d34/38mm 115-160-140mm</p>		<p>R220235 NO. 1336238 - 90106060</p> <p>TUBO DE LIGAÇÃO TERMOSTATO Á BOMBA DE ÁGUA</p> <p>OPEL ASCONA A (81_, 86_, 87_, 88_) 1900 1.2 S 04.1972/08.1975 44KW 60CV 1196CC 12 S 0039207 0039208 - OPEL ASCONA B (81_, 86_, 87_, 88_) 1.2 08.1976/02.1979 40KW 55CV 1196CC 12 N 0039523</p> <p>B340-d30/38mm 51x65x34mm</p>
	<p>R220235 NO. 1336238 - 90106060</p> <p>TUBO DE LIGAÇÃO TERMOSTATO Á BOMBA DE ÁGUA</p> <p>OPEL ASCONA C (J82) 1.3 N (F11, M11, F69) 09.1981/08.1986 44KW 60CV 1297CC 13 N 0039596</p> <p>B340-d30/38mm 51x65x34mm</p>		<p>R220237 NO. 1336212 - 1336864</p> <p>TUBO DE RADIADOR INFERIOR</p> <p>OPEL ASCONA B (81_, 86_, 87_, 88_) 1.2 08.1976/02.1979 40KW 55CV 1196CC 12 N 0039523</p>
	<p>R220254 NO. 1336749 - 1336783 - 90424150</p> <p>TUBO INFERIOR SAÍDA ÁGUA DO RADIADOR</p> <p>OPEL ASCONA A (81_, 86_, 87_, 88_) : 1.2 S 04.1972/08.1975 44KW 60CV 1196CC - OPEL ASCONA A (81_, 86_, 87_, 88_) : 1.6 N 03.1975/08.1975 44KW 60CV 1584CC - OPEL ASCONA A (81_, 86_, 87_, 88_) : 1.6 N 10.1970/02.1975 50KW 68CV 1584CC - OPEL ASCONA A (81_, 86_, 87_, 88_) : 1.6 S 03.1975/08.1975 55KW 75CV 1584CC - OPEL ASCONA A (81_, 86_, 87_, 88_) : 1.6 S 10.1970/02.1975 59KW 80CV 1584CC - OPEL ASCONA A (...)</p> <p>B250-d45/35mm 75-175-85mm</p>		<p>R220255 NO. 1336863 - 9281830</p> <p>TUBO DE RADIADOR SUPERIOR</p> <p>OPEL ASCONA B (81_, 86_, 87_, 88_) 1.2 08.1976/02.1979 40KW 55CV 1196CC 12 N 0039523</p> <p>B360-d40/40mm 125-240-80mm</p>
	<p>R220260 NO. 1336788</p> <p>TUBO DE RADIADOR SUPERIOR</p> <p>OPEL ASCONA A (81_, 86_, 87_, 88_) 1.2 S 04.1972/08.1975 44KW 60CV 1196CC 12 S 0039207 0039208</p> <p>B260-d34/34mm 60-150-115-75mm</p>		<p>R220260 NO. 1336788</p> <p>TUBO DE RADIADOR SUPERIOR</p> <p>OPEL ASCONA B (81_, 86_, 87_, 88_) 1.2 08.1976/02.1979 40KW 55CV 1196CC 12 N 0039523</p> <p>B260-d34/34mm 60-150-115-75mm</p>
	<p>R220284 NO. 1336250 - 1336251 - 1336316 - 90091138 - 90169012</p> <p>TUBO DE RADIADOR SUPERIOR</p> <p>OPEL ASCONA C Hatchback (J82): 1.3 N (F68, M68) 09.1981/08.1986 44KW 60CV 1297CC - OPEL ASCONA C Hatchback (J82): 1.3 S (F68, M68) 09.1981/08.1988 55KW 75CV 1297CC - OPEL ASCONA C (J82): 1.3 N (F11, M11, F69) 09.1981/08.1986 44KW 60CV 1297CC - OPEL ASCONA C (J82): 1.3 S (F11, M11, F68, M68) 09.1981/08.1988 55KW 75CV 1297CC</p> <p>B225-d34/34mm 120-80-115mm</p>		<p>R220535 NO. 60-210-80-115-80mm + ch d18 50-30-</p> <p>TUBO DE RADIADOR INFERIOR COM 3 VIAS</p> <p>OPEL ASCONA C (J82) 1.6 D (F11, M11, F68, M68) 03.1982/08.1988 40KW 54CV 1598CC 16 DA16 D 0039608 - OPEL ASCONA C Hatchback (J82) 1.6 D (F68, M68) 03.1982/08.1988 40KW 54CV 1598CC 16 DA16 D 0039609</p> <p>B480-d31/31mm 60-210-80-115-80mm + ch d18 50-30-35-70-70mm</p>
	<p>R222719 NO. 1336294 - 1337395 - 90128078 - 90166058 - 90570030</p> <p>TUBO DE LIGAÇÃO TERMOSTATO Á BOMBA DE ÁGUA</p> <p>OPEL ASCONA C (J82) 1.6 D (F11, M11, F68, M68) 03.1982/08.1988 40KW 54CV 1598CC 16 DA16 D 0039608 - OPEL ASCONA C Hatchback (J82) 1.6 D (F68, M68) 03.1982/08.1988 40KW 54CV 1598CC 16 DA16 D 0039609</p> <p>boca a boca 137 mm d1 31mm d2 32mm</p>		<p>R8080 NO. 1336294 - 1337395 - 2101-1303090 - 90128078 - 90166058 - 90570030 - 90916-01013</p> <p>TUBO DO RADIADOR Á BOMBA DE ÁGUA</p> <p>OPEL ASCONA C (J82) 1.6 D (F11, M11, F68, M68) 03.1982/08.1988 40KW 54CV 1598CC 16 DA 16 D 0039608 - OPEL ASCONA C Hatchback (J82) 1.6 D (F68, M68) 03.1982/08.1988 40KW 54CV 1598CC 16 DA 16 D 0039609</p> <p>B140-d34/34mm 85-75mm</p>

	<p>RT08545 NO. 562345 - 562350 - 562358 - 90235568 - 90374106 - 90468316 - 90468319</p> <p>TUBO DE TRAVÃO FRENTE LH-RH</p> <p>OPEL ASCONA C Hatchback (J82): 1.3 N (F68, M68) 09.1981/08.1986 44KW 60CV 1297CC - OPEL ASCONA C Hatchback (J82): 1.3 S (F68, M68) 09.1981/08.1988 55KW 75CV 1297CC - OPEL ASCONA C Hatchback (J82): 1.6 (F68, M68) 09.1981/08.1988 55KW 75CV 1598CC - OPEL ASCONA C Hatchback (J82): 1.6 i (F68, M68) 09.1987/08.1988 55KW 75CV 1598CC - OPEL ASCONA C Hatchback (J82): 1.6 i Cat (F68, M68) 09.1986/08.1988 55...</p> <p>310mm FB3/1 - OR1</p>		<p>S1275 NO. 402642 - 90189050</p> <p>SILENT-BLOC DA SUSPENSÃO DE TRÁS</p> <p>OPEL ASCONA C Hatchback (J82): 1.3 N (F68, M68) 09.1981/08.1986 44KW 60CV 1297CC - OPEL ASCONA C Hatchback (J82): 1.3 S (F68, M68) 09.1981/08.1988 55KW 75CV 1297CC - OPEL ASCONA C Hatchback (J82): 1.6 (F68, M68) 09.1981/08.1988 55KW 75CV 1598CC - OPEL ASCONA C Hatchback (J82): 1.6 i (F68, M68) 09.1987/08.1988 55KW 75CV 1598CC - OPEL ASCONA C Hatchback (J82): 1.6 i Cat (F68, M68) 09.1986/08.1988 55...</p> <p>d56x 75mm c-63mm dc-48mm1f-d12mm</p>
	<p>UMB84011 NO. 031126</p> <p>TAMPÃO BLOCO MOTOR</p> <p>OPEL ASCONA C Hatchback (J82) 1.3 S (F68 - M68) (De 09-1981 Até 08-1988) 55kW 75CV 1297cc Hatchback OPEL ASCONA C Hatchback (J82) 1.6 i Cat (F68 - M68) (De 09-1986 Até 08-1988) 55kW 75CV 1598cc Hatchback OPEL ASCONA C Hatchback (J82) 1.6 (F68 - M68) (De 09-1986 Até 08-1988) 60kW 82CV 1598cc Hatchback OPEL ASCONA C Hatchback (J82) 1.6 S (F68 - M68) (De 09-1981 Até 08-1986) 66kW 90CV 1598cc Hatchba...</p> <p>d-18x8mm di-16mm</p>		<p>UMB84011L NO. 11062402 - 2060675</p> <p>TAMPÃO BLOCO DE MOTOR (RELAS)</p> <p>OPEL ASCONA C Hatchback (J82) 1.3 S (F68 - M68) (De 09-1981 Até 08-1988) 55kW 75CV 1297cc Hatchback OPEL ASCONA C Hatchback (J82) 1.6 i Cat (F68 - M68) (De 09-1986 Até 08-1988) 55kW 75CV 1598cc Hatchback OPEL ASCONA C Hatchback (J82) 1.6 (F68 - M68) (De 09-1986 Até 08-1988) 60kW 82CV 1598cc Hatchback OPEL ASCONA C Hatchback (J82) 1.6 S (F68 - M68) (De 09-1981 Até 08-1986) 66kW 90CV 1598cc Hatchba...</p> <p>d-18x8mm di-16mm</p>
	<p>UMB84019 NO. 2060668</p> <p>TAMPÃO BLOCO MOTOR</p> <p>OPEL ASCONA C Hatchback (J82) 1.6 (F68 - M68) (De 09-1981 Até 08-1988) 55kW 75CV 1598cc Hatchback OPEL ASCONA C Hatchback (J82) 1.6 i Cat (F68 - M68) (De 09-1986 Até 08-1988) 55kW 75CV 1598cc Hatchback OPEL ASCONA C Hatchback (J82) 1.6 i Cat (F68 - M68) (De 09-1986 Até 08-1988) 55kW 75CV 1598cc Hatchback OPEL ASCONA C Hatchback (J82) 1.6 (F68 - M68) (De 09-1986 Até 08-1988) 60kW 82CV 1598cc Hatchba...</p> <p>d-26x9,5mm di-23,3mm</p>		<p>UMB84019L NO. 2060668</p> <p>TAMPÃO BLOCO DE MOTOR (RELAS)</p> <p>OPEL ASCONA C Hatchback (J82) 1.6 (F68 - M68) (De 09-1981 Até 08-1988) 55kW 75CV 1598cc Hatchback OPEL ASCONA C Hatchback (J82) 1.6 i Cat (F68 - M68) (De 09-1986 Até 08-1988) 55kW 75CV 1598cc Hatchback OPEL ASCONA C Hatchback (J82) 1.6 i Cat (F68 - M68) (De 09-1986 Até 08-1988) 55kW 75CV 1598cc Hatchback OPEL ASCONA C Hatchback (J82) 1.6 (F68 - M68) (De 09-1986 Até 08-1988) 60kW 82CV 1598cc Hatchback ...</p> <p>d-26x9,5mm di-23,3mm</p>
	<p>UMB84021 NO. 2060673</p> <p>TAMPÃO BLOCO MOTOR</p> <p>OPEL ASCONA C Hatchback (J82) 1.3 N (F68, M68) - OPEL ASCONA C Hatchback (J82) 1.6 (F68, M68) - OPEL ASCONA C Hatchback (J82) 1.6 i (F68, M68) - OPEL ASCONA C Hatchback (J82) 1.6 S (F68, M68) - OPEL ASCONA C Hatchback (J82) 1.8 (F68, M68) - OPEL ASCONA C Hatchback (J82) 1.8 i (F68, M68) - OPEL ASCONA C Hatchback (J82) 2.0 i (F68, M68) - OPEL ASCONA C Hatc...</p> <p>d-28x7mm di-25,6mm</p>		<p>UMB84021L NO. 2060673</p> <p>TAMPÃO BLOCO DE MOTOR (RELAS)</p> <p>OPEL ASCONA C Hatchback (J82) 1.3 N (F68, M68) - OPEL ASCONA C Hatchback (J82) 1.6 (F68, M68) - OPEL ASCONA C Hatchback (J82) 1.6 i (F68, M68) - OPEL ASCONA C Hatchback (J82) 1.6 S (F68, M68) - OPEL ASCONA C Hatchback (J82) 1.8 (F68, M68) - OPEL ASCONA C Hatchback (J82) 1.8 i (F68, M68) - OPEL ASCONA C Hatchback (J82) 2.0 i (F68, M68) - OPEL ASCONA C Hatc...</p> <p>d-28x7mm di-25,6mm</p>
	<p>UMB84026L NO. 11056093 - 2060665</p> <p>TAMPÃO BLOCO DE MOTOR (RELAS)</p> <p>OPEL ASCONA C</p> <p>d-34x13mm di-31,2mm</p>		<p>UMB84029 NO. 2060946</p> <p>TAMPÃO BLOCO MOTOR</p> <p>OPEL ASCONA C Hatchback (J82) 1.3 N (F68, M68) (09.81 A 08.86) 60cv 1297cc Hatchback - OPEL ASCONA C (J82) 1.6 D (F11, M11, F68, M68) (03.82 A 08.88) 54cv 1598cc três volumes</p> <p>d36x10mm di-32mm</p>
	<p>UTR0811 NO. 1304659 - 1304660 - 1304661 - 1304665 - 1304666 - 1304665 - 4395513 - 90352470 - 90409256 - 90409257...</p> <p>TAMPÃO RESERVATÓRIO LÍQUIDO REFRIGERAÇÃO</p> <p>OPEL ASCONA C 1.6 i (09.87 A 08.88) 75cv 1598cc três volumes</p> <p>60x25mm 1f-d52x14mm</p>		<p>UTR0820 NO. 90352470 - 90409256 - 90409257 - 9041032690497472 - 90467473</p> <p>TAMPÃO RESERVATÓRIO LÍQUIDO REFRIGERAÇÃO</p> <p>OPEL ASCONA B (81_, 86_, 87_, 88_) 2.0 N (08.77 A 08.81) 90cv 1979cc três volumes - OPEL ASCONA B (81_, 86_, 87_, 88_) 2.0 E (08.79 A 08.81) 110cv 1979cc três volumes - OPEL ASCONA B (81_, 86_, 87_, 88_) 2.0 D (08.78 A 08.81) 58cv 1998cc três volumes</p> <p>d62x23mm 1f-d53x12mm</p>
	<p>UTR0820 NO. 90352470 - 90409256 - 90409257 - 9041032690497472 - 90467473</p> <p>TAMPÃO RESERVATÓRIO LÍQUIDO REFRIGERAÇÃO</p> <p>OPEL ASCONA C Hatchback (84_, 89_) 1.3 N (09.81 A 08.86) 60cv 1297cc Hatchback - OPEL ASCONA C Hatchback (84_, 89_) 1.3 S (09.81 A 08.88) 75cv 1297cc Hatchback - OPEL ASCONA C Hatchback (84_, 89_) 1.6 (09.81 A 08.88) 75cv 1598cc Hatchback - OPEL ASCONA C Hatchback (84_, 89_) 1.6 i (09.87 A 08.88) 75cv 1598cc Hatchback - OPEL ASCONA C Hatchback (84_, 89_) 1.6 i Cat (09.86 A 08.88) 75cv 159...</p> <p>d62x23mm 1f-d53x12mm</p>		<p>UTR0838 NO. 09040925 - 1304654 - 1304659 - 1304660 - 1304661 - 1304665 - 1304666 - 1304667 - 1304853 - 90352470 ...</p> <p>TAMPÃO RESERVATÓRIO LÍQUIDO REFRIGERAÇÃO</p> <p>OPEL ASCONA B (81_, 86_, 87_, 88_) 2.0 E (08.79 A 08.81) 110cv 1979cc três volumes - OPEL ASCONA B (81_, 86_, 87_, 88_) 2.0 D (08.78 A 08.81) 58cv 1998cc três volumes</p> <p>62x19mm 1f-d53x12mm</p>
	<p>UTR0838 NO. 09040925 - 1304654 - 1304659 - 1304660 - 1304661 - 1304665 - 1304666 - 1304667 - 1304853 - 90352470 ...</p> <p>TAMPÃO RESERVATÓRIO LÍQUIDO REFRIGERAÇÃO</p> <p>OPEL ASCONA C Hatchback (J82) 1.6 (09.81 A 08.88) 75cv 1598cc Hatchback - OPEL ASCONA C Hatchback (J82) 1.6 i (09.87 A 08.88) 75cv 1598cc Hatchback - OPEL ASCONA C Hatchback (J82) 1.6 i Cat (09.86 A 08.88) 75cv 1598cc Hatchback - OPEL ASCONA C Hatchback (J82) 1.6 (09.86 A 08.88) 82cv 1598cc Hatchback - OPEL ASCONA C Hatchback (J82) 1.6 S (09.81 A 08.86) 90cv 1598cc Hatchback - OPEL ASCON...</p> <p>62x19mm 1f-d53x12mm</p>		<p>UTR0859 NO. 1650630 - 94539597 - 96293957 - 96312510 - 96351578 - 96420303 - 96536649</p> <p>TAMPÃO RESERVATÓRIO LÍQUIDO REFRIGERAÇÃO</p> <p>OPEL ASCONA C Hatchback (J82) 1.3 N (09.81 A 08.86) 60cv 1297cc Hatchback - OPEL ASCONA C Hatchback (J82) 1.3 S (09.81 A 08.88) 75cv 1297cc Hatchback - OPEL ASCONA C Hatchback (J82) 1.6 (09.81 A 08.88) 75cv 1598cc Hatchback - OPEL ASCONA C Hatchback (J82) 1.6 i (09.87 A 08.88) 75cv 1598cc Hatchback - OPEL ASCONA C Hatchback (J82) 1.6 i Cat (09.86 A 08.88) 75cv 1598cc Hatchback - OPEL ASCON...</p> <p>d63x23mm 1f-d53x11mm</p>

	<p>UTR1305 NO. 0650089 - 650089</p> <p>TAMPÃO DO RESERVATÓRIO ÓLEO</p> <p>OPEL ASCONA C (J82) 1.3 N (F11, M11, F69) 09.1981/08.1986 44KW 60CV 1297CC 13 N 0039596 - OPEL ASCONA C (J82) 1.3 S (F11, M11, F68, M68) 09.1981/08.1988 55KW 75CV 1297CC 13 S 0039597 - OPEL ASCONA C (J82) 1.6 (F11, F68, M11, M68) 09.1986/08.1988 60KW 82CV 1598CC 16 SV 0039668 - OPEL ASCONA C (J82) 1.6 (F11, M11, F68, M68) 09.1981/09.1987 55KW 75CV 1598CC 16 N 0039598 - OPEL ASCONA C (J82) 1.6 D (F...</p> <p>d61x23mm d32x19mm</p>		<p>UTV83011 NO. 0652475 - 09275631 - 652475 - 652491 - 90409376 - 9275631 - N90288901</p> <p>TAMPÃO VEDAÇÃO BUJÃO</p> <p>OPEL ASCONA C Hatchback (J82) 1.3 N (F68 - M68) (De 09-1981 Até 08-1986) 44kW 60CV 1297cc Hatchback OPEL ASCONA C Hatchback (J82) 1.3 S (F68 - M68) (De 09-1981 Até 08-1988) 55kW 75CV 1297cc Hatchback OPEL ASCONA C Hatchback (J82) 1.6 i Cat (F68 - M68) (De 09-1986 Até 08-1988) 55kW 75CV 1598cc Hatchback OPEL ASCONA C Hatchback (J82) 1.6 (F68 - M68) (De 09-1986 Até 08-1988) 60kW 82CV 1598cc Hatch...</p> <p>19x18mm c12mm d14mm</p>
	<p>Y3000 NO. 854917 - 854977 - 854980 - 90128081</p> <p>PARAFUSO MOLA DE ESCAPE</p> <p>OPEL ASCONA C (1981 A 1989)</p> <p>82x13mm 1p-d10-20mm</p>		<p>Y3004 NO. 854982 - 90128082</p> <p>PARAFUSO ESCAPE</p> <p>OPEL ASCONA (C) (1986 A 1988)</p> <p>d19x65mm d12mm 1r-d10mm</p>
	<p>Y3212 NO. 1008501 - 1008504 - 4709077</p> <p>PARAFUSO PERNO RODA CHAVE 17 M12X1,50X48MM (BASE CONICA PARA JANTES AÇO E LIGA LEVE)</p> <p>OPEL ASCONA C (J82) 1.3 N (F11, M11, F69) (09.1981 - 08.1986) 44kw 60cv 1297cm3 três volumes OPEL ASCONA C (J82) 1.3 S (F11, M11, F68, M68) (09.1981 - 08.1988) 55kw 75cv 1297cm3 três volumes OPEL ASCONA C (J82) 1.6 (F11, F68, M11, M68) (09.1986 - 08.1988) 60kw 82cv 1598cm3 três volumes OPEL ASCONA C (J82) 1.6 (F11, M11, F68, M68) (09.1981 - 09.1987) 55kw 75cv 1598cm3 três volumes OPEL ASCONA C (J8...</p> <p>C48mm (Ch-17mm) M12x1,50x22mm</p>		<p>Z55237 NO. 090087290</p> <p>MOLA DE FIXAÇÃO CAVA DE RODA</p> <p>OPEL ASCONA</p> <p>F8mm T16mm S1-2mm H11mm L8mm S1mm Z23mm</p>
	<p>Z55254 NO. 2317703</p> <p>MOLA REBITE FIXAÇÃO</p> <p>OPEL ASCONA</p> <p>d5.5x 16mm f-d11mm</p>		<p>Z80554 NO. 0174843 - 174837 - 174843 - 90119995</p> <p>Mola de friso</p> <p>OPEL ASCONA (C) (Após 1982)</p> <p>56x38.5x5mm</p>
	<p>Z9000 NO. 25501711 - 854880 - 854881 - 854884 - 858884 - 90234204</p> <p>MOLA DE ESCAPE 42mm</p> <p>OPEL ASCONA (C) (1982 A 1988)</p> <p>d18x26mm</p>		<p>Z9011 NO. 1261479 - 1449282600 - 4709339 - 4711509 - 854880</p> <p>MOLA DE ESCAPE</p> <p>OPEL ASCONA</p> <p>d23x42mm</p>

OPEL ASTRA

	<p>A1406 NO. 0650702 - 90233962</p> <p>APOIO MOTOR ESQUERDO</p> <p>OPEL ASTRA</p> <p>d20x15mm 1p-d6-10mm 1p-d6-15mm</p>		<p>A2339 NO. 13159996 - 5684654</p> <p>APOIO DO MOTOR LADO ESQUERDO</p> <p>OPEL ASTRA H (A04) 1.7 CDTI (L48) (De 03.2004 Até 10.2010) 74kW 100cv 1686cm3 Hatchback - OPEL ASTRA H (A04) 1.7 CDTI (L48) (De 02.2007 Até 05.2014) 81kW 110cv 1686cm3 Hatchback - OPEL ASTRA H (A04) 1.7 CDTI (L48) (De 02.2007 Até 05.2014) 92kW 125cv 1686cm3 Hatchback - OPEL ASTRA H (A04) 1.8 (L48) (De 01.2004 Até 10.2010) 92kW 125cv 1796cm3 Hatchback - OPEL ASTRA H (A04) 1.8 (L48) (De 01.2006 Até...</p> <p>146x120x66mm 1p-d8x14mm 4f-d9mm 1f-d12mm</p>
	<p>F0481-I NO. 90095087</p> <p>FOLE DO SEMI-EIXO LADO DA RODA</p> <p>OPEL ASTRA 1.3 (DESDE 82)</p> <p>d100x80mm 1f-d20mm1f-d75mm</p>		<p>H770 NO.</p> <p>PALA ORIGINAL</p> <p>OPEL ASTRA VAN</p> <p>480x220mm</p>

	<p>M6008 NO. 854943</p> <p><i>JUNTA DE ESCAPE</i></p> <p>OPEL ASTRA F Hatchback (T92): 1.7 TDS (F08, M08, F68, M68) 12.1991/01.1998 60KW 82CV 1686CC - OPEL ASTRA G Hatchback (T98): 1.7 TD (F08, F48) 02.1998/08.2000 50KW 68CV 1700CC</p> <p>d65x5mm 1f-d50mm</p>		<p>R221427 NO. 13117572 - 1337734</p> <p><i>TUBO SUPERIOR DO RADIADOR</i></p> <p>OPEL ASTRA H (A04) 1.9 CDTI (L48) 06.2004/10.2010 88KW 120CV 1910CC Z 19 DT 0035539 0035AMK 0035ACY - OPEL ASTRA H (A04) 1.9 CDTI (L48) 09.2004/10.2010 110KW 150CV 1910CC Z 19 DTH 0035540 0035AML 0035ACZ - OPEL ASTRA H (A04) 1.9 CDTI (L48) 09.2005/10.2010 74KW 100CV 1910CC Z 19 DTL 0035570 0035AMJ 0035ACX - OPEL ASTRA H (A04) 1.9 CDTI 16V (L48) 04.2004/10.2010 88KW 120CV 1910CC Z 19 DTJ 0035539 00...</p> <p>B245-31/32mm 52x49x58x79x56mm</p>
	<p>R225493 NO. 3647457 - 9820100780</p> <p><i>TUBO DO AR SOBRELIMENTAÇÃO</i></p> <p>OPEL ASTRA L (OV5) 1.2 (FPHNPJ) (10.2021 -) 81kw 110cv 1199cm3 Hatchback OPEL ASTRA L (OV5) 1.2 (FPHNSL, FPHNSR) (10.2021 -) 96kw 131cv 1199cm3 Hatchback OPEL ASTRA L Sports Tourer (OV5) 1.2 (FRHNPJ) (10.2021 -) 81kw 110cv 1199cm3 Combi OPEL ASTRA L Sports Tourer (OV5) 1.2 (FRHNSL, FRHNSR) (10.2021 -) 96kw 131cv 1199cm3 Combi</p> <p>boca a boca290mmd1-46mm d290mm 18-85-83-62-156-77</p>		<p>R8078 NO. 1336328 - 1337393 - 90322911 - 90570033</p> <p><i>TUBO DE LIGAÇÃO À BOMBA DE ÁGUA</i></p> <p>OPEL ASTRA F (T92) 2.0 i 16V (F19, M19) 02.1995/09.1998 100KW 136CV 1998CC X 20 XEV 0039939 0035306 - OPEL ASTRA F Combi (T92) 2.0 i 16V (F35, M35) 03.1993/01.1998 110KW 150CV 1998CC C 20 XE 0039898 - OPEL ASTRA F Hatchback (T92) 2.0 GSI 16V (F08, M08, F68, M68) 09.1991/01.1998 110KW 150CV 1998CC C 20 XE 0039867</p> <p>B171-d40/34mm d27mm 45-90-45mm 85-80mm</p>
	<p>W5159 NO. 055575960 - 0614172 - 0614758 - 098022837 - 098039173 - 55575960 - 5614450 - 614172 - 614758 - 99922</p> <p><i>POLIE CAMBOTA 6 PISTAS</i></p> <p>OPEL ASTRA H (A04) 1.7 CDTI (L48) 02.2007/05.2014 81KW 110CV 1686CC A 17 DTJ Z 17 DTJ 0035AHK 0035AMH - OPEL ASTRA H (A04) 1.7 CDTI (L48) 02.2007/05.2014 92KW 125CV 1686CC Z 17 DTR A 17 DTR 0035AHL 0035AMI - OPEL ASTRA H Caixa/Combi (L70) 1.7 CDTI (L70) 02.2007/10.2010 81KW 110CV 1686CC Z 17 DTJ A 17 DTJ 0035AQK - OPEL ASTRA H Caixa/Combi (L70) 1.7 CDTI (L70) 02.2007/10.2010 92KW 125CV 1686CC Z 17...</p> <p>d154mm d48mm</p>		<p>Z55254 NO. 2317703</p> <p><i>MOLA REBITE FIXAÇÃO</i></p> <p>OPEL ASTRA</p> <p>d5.5x 16mm f-d11mm</p>
	<p>Z57101 NO. 13252119</p> <p><i>MOLA DO PAINEL DA PORTA</i></p> <p>OPEL ASTRA (A partir de 2010)</p> <p>F9mm T17mm L15mm H20mm S1-6mm</p>		<p>Z71500 NO. 13252118</p> <p><i>MOLA DO PAINEL DA PORTA</i></p> <p>OPEL ASTRA (A partir de 2010)</p> <p>F9mm T17mm L14mm H20mm S1-7mm</p>
	<p>Z80743 NO. 2345957</p> <p><i>Mola de painel</i></p> <p>OPEL ASTRA</p> <p>d17x19mm 1p-d9-13mm</p>		<p>Z80747 NO. 1406925</p> <p><i>Mola de fixação</i></p> <p>OPEL ASTRA</p> <p>d16x21.5mm 1p-d6-10.5mm</p>
	<p>Z80822 NO. 0912466 - 90335715 - 912466</p> <p><i>Mola de painel</i></p> <p>OPEL ASTRA</p> <p>d14x15mm 1p-d5.5-13mm</p>		

OPEL ASTRA F

	<p>A1210 NO. 682556 - 682601 - 684648</p> <p><i>APOIO TRÁS DE MOTOR</i></p> <p>OPEL ASTRA F (T92) 1.4 (F19, M19) 09.1991/09.1993 55KW 75CV 1389CC 14 NV - OPEL ASTRA F (T92) 1.4 (F19, M19) 09.1992/09.1998 60KW 82CV 1389CC 14 SE - OPEL ASTRA F (T92) - OPEL ASTRA F (T92) 1.4 i (F19, M19) 09.1991/09.1998 44KW 60CV 1389CC X 14 NZC 14 NZ 0035300 0039873 - OPEL ASTRA F (T92) 1.4 i 16V (F19, M19) 02.1996/09.1998 66KW 90CV 1389CC X 14 XE 0035302 0039955 - OPEL ASTRA F (T92) 1.4 Si (F...</p> <p>150x98x57mm 2p-d10-20mm 2f-d10mm</p>		<p>A1213 NO. 682504 - 682558 - 682566</p> <p><i>APOIO TRÁS DE MOTOR</i></p> <p>OPEL ASTRA F (T92) 1.4 (F19, M19) 09.1991/09.1993 55KW 75CV 1389CC 14 NV - OPEL ASTRA F (T92) 1.4 (F19, M19) 09.1992/09.1998 60KW 82CV 1389CC 14 SE - OPEL ASTRA F (T92) - OPEL ASTRA F (T92) 1.4 i (F19, M19) 09.1991/09.1998 44KW 60CV 1389CC X 14 NZC 14 NZ 0035300 0039873 - OPEL ASTRA F (T92) 1.4 i 16V (F19, M19) 02.1996/09.1998 66KW 90CV 1389CC X 14 XE 0035302 0039955 - OPEL AST...</p> <p>150x98x57mm 2p-d10-20mm 2f-d10mm</p>
--	---	--	---







	<p>A1216 NO. 0344517 - 0344531 - 0926614001 - 344517 - 344517S1 - 344518 - 344524 - 344531 - 90345330 - 90374844...</p> <p>APOIO SUPORTE AMORTECEDOR FRENTE (GASTA 2 UNIDADES)</p> <p>OPEL ASTRA F Hatchback (T92): 1.4 i (F08, M08, F68, M68) 09.1991/01.1998 44KW 60CV 1389CC - OPEL ASTRA F Hatchback (T92): 1.4 (F08, M08, F68, M68) 09.1991/09.1993 55KW 75CV 1389CC - OPEL ASTRA F Hatchback (T92): 1.4 Si (F08, M08, F68, M68) 03.1992/01.1998 60KW 82CV 1389CC - OPEL ASTRA F Hatchback (T92): 1.4 (F08, M08, F68, M68) 09.1992/01.1998 60KW 82CV 1389CC - OPEL ASTRA F Hatchback (T92): 1.4 i...</p> <p>150x130x43mm 1f-d32mm 1f-d14mm</p>		<p>A1216-A NO. 0344517 - 0344531 - 0926614001 - 344517 - 344518 - 344531 - 90345330 - 90374844 - 90496637 - 9453523...</p> <p>Apoio do amortecedor da frente</p> <p>OPEL ASTRA F Hatchback (T92): 1.4 i (F08, M08, F68, M68) 09.1991/01.1998 44KW 60CV 1389CC - OPEL ASTRA F Hatchback (T92): 1.4 (F08, M08, F68, M68) 09.1991/09.1993 55KW 75CV 1389CC - OPEL ASTRA F Hatchback (T92): 1.4 Si (F08, M08, F68, M68) 03.1992/01.1998 60KW 82CV 1389CC - OPEL ASTRA F Hatchback (T92): 1.4 (F08, M08, F68, M68) 09.1992/01.1998 60KW 82CV 1389CC - OPEL ASTRA F Hatchback (T92): 1.4 i...</p> <p>150x130x46mm 1f-d37mm 2p-d8-15mm</p>
	<p>A1216-C NO. 0344517 - 0344531 - 0926614001 - 344517 - 344518 - 344531 - 90345330 - 90374844 - 90496637 - 9453523...</p> <p>APOIO SUPORTE AMORTECEDOR FRENTE (GASTA 2 UNIDADES)</p> <p>OPEL ASTRA F Hatchback (T92): 1.4 i (F08, M08, F68, M68) 09.1991/01.1998 44KW 60CV 1389CC - OPEL ASTRA F Hatchback (T92): 1.4 (F08, M08, F68, M68) 09.1991/09.1993 55KW 75CV 1389CC - OPEL ASTRA F Hatchback (T92): 1.4 Si (F08, M08, F68, M68) 03.1992/01.1998 60KW 82CV 1389CC - OPEL ASTRA F Hatchback (T92): 1.4 (F08, M08, F68, M68) 09.1992/01.1998 60KW 82CV 1389CC - OPEL ASTRA F Hatchback (T92): 1.4 i...</p> <p>152x131x48mm 1f-d32mm 1f-d14mm 2p-d8/15mm</p>		<p>A1392 NO. 684282 - 684291 - 6844282 - 6844283 - 684667</p> <p>APOIO DO MOTOR FRENTE DIREITO</p> <p>OPEL ASTRA (F) 1.4 - 1.4i - 1.6i 16v - 1.7 DIESEL - 1.8i 16v - 2.0i 16v (1991 A 1997)</p> <p>185x95x67mm 2f-d11mm</p>
	<p>A1394 NO. 684646 - 90372425</p> <p>APOIO MOTOR FRENTE DIREITO</p> <p>OPEL ASTRA (F) 1.8i - 1.8i 16v - 2.0i - 2.0i 16v - (1991 A 2001)</p> <p>175x95x60mm 1f-d12mm</p>		<p>A1553 NO. 0684644 - 684644 - 90335498</p> <p>APOIO DO MOTOR FRENTE LADO DIREITO</p> <p>OPEL ASTRA (F) (91 A 98) 1.7 TD - 1.7TDS</p> <p>180x95x80mm</p>
	<p>A1646 NO. 0684681 - 684681 - 90497967</p> <p>APOIO DO MOTOR PARTE DA FRENTE ESQUERDO</p> <p>OPEL ASTRA (F) 1.8 - 2.0</p> <p>d105x135mm 1p-d10-44mm 1p-d10-25mm</p>		<p>A2674 NO. 1310958 - 90501086</p> <p>APOIO SUPORTE RADIADOR SUPERIOR</p> <p>OPEL ASTRA F Combi (T92) 1.7 TDS (F35, M35) 12.1991/01.1998 60KW 82CV 1686CC 17 DT X 17 DT 0035326 0039860 - OPEL ASTRA F Hatchback (T92) KADETT 1.7 TDS (F08, M08, F68, M68) 12.1991/01.1998 60KW 82CV 1686CC 17 DT X 17 DT 0035317 0039869 - OPEL ASTRA F três volumes (T92) ASTRA CLASSIC OPTIMA INFORMAÇÕES 1.7 TDS (F19, M19) 03.1992/09.1998 60KW 82CV 1686CC 17 TD X 17 DT 17 DT 0035308 0039879</p> <p>d36x23mm c18mm 1f-d9mm</p>
	<p>C0233 NO. 1160724 - 90054143</p> <p>BOTÃO AFINAÇÃO CAPÔT</p> <p>OPEL ASTRA F Hatchback (53_54_58_59_) 1.4 i (03.92 A 01.98) 60cv 1389cc Hatchback - OPEL ASTRA F Hatchback (53_54_58_59_) 1.4 (09.91 A 09.93) 75cv 1389cc Hatchback - OPEL ASTRA F Hatchback (53_54_58_59_) 1.4 Si (03.92 A 01.98) 82cv 1389cc Hatchback - OPEL ASTRA F Hatchback (53_54_58_59_) 1.4 (09.92 A 01.98) 82cv 1389cc Hatchback - OPEL ASTRA F Hatchback (53_54_58_59_) 1.4 i...</p> <p>d19x31mm</p>		<p>E0016 NO. 0852719 - 852719 - 90128194</p> <p>ESTICADOR SUPORTE CENTRAL E TRÁS DO ESCAPE</p> <p>OPEL ASTRA F Hatchback (T92): 1.4 i (F08, M08, F68, M68) 09.1991/01.1998 44KW 60CV 1389CC - OPEL ASTRA F Hatchback (T92): 1.4 (F08, M08, F68, M68) 09.1991/09.1993 55KW 75CV 1389CC - OPEL ASTRA F Hatchback (T92): 1.4 Si (F08, M08, F68, M68) 03.1992/01.1998 60KW 82CV 1389CC - OPEL ASTRA F Hatchback (T92): 1.4 (F08, M08, F68, M68) 09.1992/01.1998 60KW 82CV 1389CC - OPEL ASTRA F Hatchback (T92): 1.4 i...</p> <p>105x35x33mm</p>
	<p>E0085 NO. 350261 - 90278577 - 0350261S</p> <p>ESTICADOR BARRA ESTABILIZADORA FRENTE FURO 18MM (GASTA 2 UNIDADES)</p> <p>OPEL ASTRA F Cabriolet (T92) 1.4 i 16V 01.1996/03.2001 66KW 90CV 1389CC X 14 XE 0035327 0039958 - OPEL ASTRA F Cabriolet (T92) 1.4 Si 05.1993/03.2001 60KW 82CV 1389CC C 14 SE 0039895 - OPEL ASTRA F Cabriolet (T92) 1.6 i 03.1993/08.1996 52KW 71CV 1598CC X 16 SZ 0039897 - OPEL ASTRA F Cabriolet (T92) 1.6 i 01.1996/03.2001 55KW 75CV 1598CC X 16 SZR 0035328 0039959 - OPEL ASTRA F Cabriolet (T92) 1.8 i...</p> <p>110x40x35mm</p>		<p>E0128 NO. 0350263 - 350263 - 4544599 - 90495045</p> <p>ESTICADOR DA BARRA ESTABILIZADORA DA FRENTE</p> <p>OPEL ASTRA (F) TT</p> <p>105x34x34mm 1p-d12-25mm</p>
	<p>E0147 NO. 350260 - 90278579 - 90278586</p> <p>ESTICADOR DA BARRA ESTABILIZADORA DA FRENTE</p> <p>OPEL ASTRA (F) TT</p> <p>100x50x35mm 1f-d21mm 1p-d8-28mm</p>		<p>E1007 NO. 852722</p> <p>ESTICADOR SUPORTE DE ESCAPE</p> <p>OPEL ASTRA (F) 1.4 - 1.6 - 1.8 - 2.0 - ASTRA DIESEL 1.7 - ASTRA TURBO DIESEL 1.7 (1991 A 1998)</p> <p>70x47x40mm</p>
	<p>E23401-V NO. 0758801 - 758801 - 90250156</p> <p>ESTICADOR MANETE CAIXA DE VELOCIDADES</p> <p>OPEL ASTRA F Hatchback (T92) 1.4 i (F08 - M08 - F68 - M68) (De 09-1991 Até 01-1998) 44KW 60CV 1389cc Hatchback OPEL ASTRA F Hatchback (T92) 1.4 (F08 - M08 - F68 - M68) (De 09-1991 Até 09-1993) 55KW 75CV 1389cc Hatchback OPEL ASTRA F Hatchback (T92) 1.4 Si (F08 - M08 - F68 - M68) (De 03-1992 Até 01-1998) 60KW 82CV 1389cc Hatchback OPEL ASTRA F Hatchback (T92) 1.4 (F08 - M08 - F68 - M68) (De 09-1...</p> <p>207x17x18mm 2f-d11mm</p>		<p>F0466-I NO. 90090811 - 902825 - 902828 - 9105983</p> <p>FOLE DIREÇÃO DIREITO/ESQUERDO (GASTA 2 UNIDADES)</p> <p>OPEL ASTRA F CLASSIC Combi (T92) 1.4 i (F35, M35) 01.1998/01.2005 44KW 60CV 1389CC X 14 NZ - OPEL ASTRA F CLASSIC Combi (T92) 1.6 i (F35, M35) 01.1998/01.2005 55KW 75CV 1598CC X 16 SZR - OPEL ASTRA F CLASSIC Combi (T92) 1.6 i 16V (F35, M35) 01.1998/01.2005 74KW 101CV 1598CC X 16 XEL - OPEL ASTRA F CLASSIC Hatchback (T92) 1.4 i (M08, M68, F08, F68) 01.1998/08.2002 44KW 60CV 1389CC X 14 NZ ...</p> <p>d78x165mm 1f-d41mm 1f-d51mm</p>

	<p>F0519-I NO. 374040 - 90112609 - 90129014</p> <p>FOLE DO SEMI-EIXO LADO DA CAIXA DE VELOCIDADES</p> <p>OPEL ASTRA (F) 1.4i - 1.4iSi - 1.6 - 1.6i - 1.6i 16v - 1.6iSi 16v - 1.8i - 1.8i 16v - 2.0i - 2.0i 16v (1991 A 2001)</p> <p>d88x97mm 1f-d66mm 1f-d21mm</p>		<p>F0520-I NO. 374018 - 90095162</p> <p>FOLE DO SEMI-EIXO INTERNO (F1026)</p> <p>OPEL ASTRA (F) CLASSIC 1.4i - CLASSIC 1.6i - CLASSIC 1.6i 16v - 1.7D - 1.7TD (1998 A 2003)</p> <p>d72x94mm 1f-d54mm 1f-d19mm</p>
	<p>F1305-I NO. 0902828 - 1609074 - 26024585</p> <p>FOLE DA DIRECÇÃO ASSISTIDA LADO DIREITO E ESQUERDO</p> <p>OPEL ASTRA (F) CLASSIC 1.4i - 1.6i - 1.6i 16v - (1998 A 2003)</p> <p>d78x170mm 1f-d54mm 1f-d42mm</p>		<p>F1337-I NO. 902829</p> <p>FOLE DA DIRECÇÃO ASSISTIDA (CAIXA ZF)</p> <p>OPEL ASTRA (F) 1.4i - 1.4i & Si - 1.6i - 1.6i 16v - 1.6i Si 16v - 1.7D - 1.7TD - 1.7TDS - 1.8i - 1.8i 16v - 2.0i - 2.0i 16v (1991 A 2001)</p> <p>d57x425mm 2f-d51mm</p>
	<p>F1338-I NO. 1609076 - 90442111</p> <p>FOLE DA CREMALHEIRA DA DIRECÇÃO (CREMALHEIRA ZF)</p> <p>OPEL ASTRA (F) 1.4i - 1.4i 16v - 1.4i Si - 1.6i - 1.6i 16v - 1.7D - 1.7TD - 1.7TDS - 1.8i - 1.8i 16v - 2.0i - 2.0i 16v - 2.0i Gsi 16v (1991 A 2001)</p> <p>d80x360mm 1f-d58mm 1f-d42mm</p>		<p>F1350-I NO. 1609045 - 1609073 - 90188878 - 90398968 - 9943449</p> <p>FOLE DA DIRECÇÃO ASSISTIDA LADO DIREITO E ESQUERDO</p> <p>OPEL ASTRA F Cabriolet (T92) 1.4 i 16V 01.1996/03.2001 66KW 90CV 1389CC X 14 XE 0035327 0039958 - OPEL ASTRA F Cabriolet (T92) 1.4 Si 05.1993/03.2001 60KW 82CV 1389CC C 14 SE 0039895 - OPEL ASTRA F Cabriolet (T92) 1.8 i 16V 11.1994/03.2001 85KW 116CV 1799CC C 18 XEL X 18 XE 0039938 0035329 - OPEL ASTRA F Caixa/Combi (T92) 1.7 D (F70) 07.1992/01.1999 44KW 60CV 1699CC 17 DR 0039121 - OPEL ASTRA F Ca...</p> <p>d74/63x125mm 1f-d50mm 1f-d38mm</p>
	<p>F1373-I NO. 1603141 - 374040 - 90009020 - 90112609 - 90421756</p> <p>FOLE DA TRANSMISSÃO JUNTO À CAIXA</p> <p>OPEL ASTRA F 1.4i - 1.4i & Si - 1.6i - 1.6i 16V - 1.6i Si 16V - 1.8i - 1.8i 16V - 2.0i - 2.0i 16V (91 A 01)</p> <p>d87x99mm 1f-d65mm 1f-d22mm</p>		<p>F1848-I NO. 1603014 - 1603183 - 1603238 - 374014 - 374319 - 374429 - 90543336</p> <p>FOLE DA TRANSMISSÃO JUNTO À CAIXA</p> <p>OPEL ASTRA (F) 1.7 CDTi 16v - 1.7D - 1.7 TDS - 1.8i 16v - 2.2i 16v (1991 A 1998)</p> <p>d95x100mm 1f-d65mm 1f-d24mm</p>
	<p>F4094 NO. 0738978 - 5738414 - 738978 - 90373314 - 90437426</p> <p>FOLE ALAVANCA VELOCIDADES</p> <p>OPEL ASTRA F Hatchback (T92): 1.4 i (F08, M08, F68, M68) 09.1991/01.1998 44KW 60CV 1389CC - OPEL ASTRA F Hatchback (T92): 1.4 (F08, M08, F68, M68) 09.1991/09.1993 55KW 75CV 1389CC - OPEL ASTRA F Hatchback (T92): 1.4 Si (F08, M08, F68, M68) 03.1992/01.1998 60KW 82CV 1389CC - OPEL ASTRA F Hatchback (T92): 1.4 (F08, M08, F68, M68) 09.1992/01.1998 60KW 82CV 1389CC - OPEL ASTRA F Hatchback (T92): 1.4 i...</p> <p>170x120x220mm 1f-160x105mm 1f-d50mm</p>		<p>F4140 NO. 0578412 - 578412 - 90437203</p> <p>FOLE ALAVANCA TRAVÃO DE MÃO</p> <p>OPEL ASTRA F CLASSIC Hatchback (T92): 1.6 i 16V (F08, M08, F68, M68) 01.1998/08.2002 74KW 101CV 1598CC - OPEL ASTRA F CLASSIC três volumes (T92): 1.6 i 16V (F19, M19) 01.1998/08.2002 74KW 101CV 1598CC</p> <p>215x69x226mm 1f-d11mm</p>
	<p>F4233 NO. 93329526</p> <p>FOLE ALAVANCA VELOCIDADES C/ ARO CROMADO</p> <p>OPEL ASTRA F CLASSIC Hatchback (T92): 1.4 i (M08, M68, F08, F68) 01.1998/08.2002 44KW 60CV 1389CC - OPEL ASTRA F CLASSIC Hatchback (T92): 1.6 i (F08, M08, F68, M68) 01.1998/08.2002 55KW 75CV 1598CC - OPEL ASTRA F CLASSIC Hatchback (T92): 1.6 i 16V (F08, M08, F68, M68) 01.1998/08.2002 74KW 101CV 1598CC - OPEL ASTRA F CLASSIC três volumes (T92): 1.4 i (F19, M19) 01.1998/08.2002 44KW 60CV 1389CC - OP...</p> <p>157x166x143mm 1f-123x132mm</p>		<p>H756 NO.</p> <p>PALA ORIGINAL OPEL ASTRA</p> <p>OPEL ASTRA (F)</p> <p>460x210mm</p>
	<p>KF2340 NO. 1603179 - 374050 - 90125491</p> <p>FOLE DO LADO DA RODA</p> <p>OPEL ASTRA (F) 1.4 Si - 1.6i - 1.6i 16v - 1.6i Si 16v - 1.7D - 1.7TD - 1.7TDS - 1.8i - 1.8i 16v - 2.0 - 2.0i 16v (1991 A 2001)</p> <p>d103x78mm 1f-d22mm 1f-d82mm</p>		<p>KL80449 NO. 198283 - 607813 - 90412865</p> <p>KIT CASQUILHOS COBERTURA TAMPA MOTOR</p> <p>OPEL ASTRA F Hatchback (T92): 1.4 i 16V (F08, M08, F68, M68) 09.1996/02.1998 66KW 90CV 1389CC - OPEL ASTRA F Hatchback (T92): 1.6 i 16V (F08, M08, F68, M68) 08.1994/01.1998 74KW 100CV 1598CC - OPEL ASTRA F (T92): 1.4 i 16V (F19, M19) 02.1996/09.1998 66KW 90CV 1389CC - OPEL ASTRA F (T92): 1.6 i 16V (F19, M19) 08.1994/09.1998 74KW 100CV 1598CC - OPEL ASTRA F Combi (T92): 1.4 i 16V (F35, M35) 02.1996...</p> <p>d16x10mm 1f-d6mm</p>
	<p>L3020 NO. 0856700 - 856700 - 9275758</p> <p>CASQUILHO DE ESCAPE</p> <p>OPEL ASTRA F Hatchback (T92): 1.6 Si (F08, M08, F68, M68) 03.1992/12.1994 74KW 101CV 1598CC - OPEL ASTRA F Hatchback (T92): 1.8 i (F08, M08, F68, M68) 09.1991/01.1998 66KW 90CV 1796CC - OPEL ASTRA F Hatchback (T92): 2.0 i (F08, M08, F68, M68) 09.1991/01.1998 85KW 115CV 1998CC - OPEL ASTRA F (T92): 1.6 i (F19, M19) 03.1992/09.1998 55KW 75CV 1598CC - OPEL ASTRA F (T92): 1.6 (F19, M19) 09.1995/09.199...</p> <p>d29x12mm d26/di19x8mm 1f-d9mm</p>		<p>L3182 NO. 0444325 - 0444326 - 0444336 - 0444348 - 444325 - 444336 - 444348 - 6655341 - 8971400891 - 90343305 ...</p> <p>CASQUILHO DA BARRA ESTABILIZADORA DE TRÁS</p> <p>OPEL ASTRA F</p> <p>d26x28mm d24mm 1f-d13mm</p>

	<p>M6003 NO. 854952</p> <p>JUNTA DE ESCAPE</p> <p>OPEL ASTRA (F) 1.4 - 1.6 KAT (1991 A 2001)</p> <p>d59x13.5mm 1f-d45mm</p>		<p>M6041 NO. 854929 - 90091769</p> <p>JUNTA DE ESCAPE</p> <p>OPEL ASTRA (F) 1.7D - 1.7TD - 1.7 TDS (APÓS 1991)</p> <p>142x68mm 2f-d50mm</p>
	<p>M6045 NO. 854936 - 90231063</p> <p>JUNTA DE ESCAPE</p> <p>OPEL ASTRA (F) (APÓS 1991)</p> <p>95x92mm 1f-d55mm</p>		<p>M6082 NO. 854943 - 854944 - 854955 - 97069287</p> <p>JUNTA DE ESCAPE</p> <p>OPEL ASTRA (F) (APÓS 1991)</p> <p>d64x5mm 1f-d53mm</p>
	<p>P1012 NO. 0560808 - 560808 - 90105172</p> <p>CAPA PEDAL EMBRAIAGEM/TRAVAO (GASTA 2 UNIDADES)</p> <p>OPEL ASTRA F Hatchback (T92): 1.4 i (F08, M08, F68, M68) 09.1991/01.1998 44KW 60CV 1389CC - OPEL ASTRA F Hatchback (T92): 1.4 (F08, M08, F68, M68) 09.1991/09.1993 55KW 75CV 1389CC - OPEL ASTRA F Hatchback (T92): 1.4 Si (F08, M08, F68, M68) 03.1992/01.1998 60KW 82CV 1389CC - OPEL ASTRA F Hatchback (T92): 1.4 (F08, M08, F68, M68) 09.1992/01.1998 60KW 82CV 1389CC - OPEL ASTRA F Hatchback (T92): 1.4 i...</p> <p>60x55x9mm</p>		<p>P1070 NO. 0560194 - 0560811 - 560194 - 560811 - 904687790</p> <p>CAPA PEDAL TRAVÃO (VEÍCULOS CAIXA AUTOMÁTICA)</p> <p>OPEL ASTRA F Cabriolet (T92) 1.4 i 16V 01.1996/03.2001 66KW 90CV 1389CC X 14 XE 0035327 0039958 - OPEL ASTRA F Cabriolet (T92) 1.4 Si 05.1993/03.2001 60KW 82CV 1389CC C 14 SE 0039895 - OPEL ASTRA F Cabriolet (T92) 1.6 i 03.1993/08.1996 52KW 71CV 1598CC X 16 SZ 0039897 - OPEL ASTRA F Cabriolet (T92) 1.6 i 01.1996/03.2001 55KW 75CV 1598CC X 16 SZR 0035328 0039959 - OPEL ASTRA F Cabriolet (T92) 1.8 i...</p> <p>110x65x14mm</p>
	<p>P1081 NO. 0842736 - 842736 - 90232022</p> <p>CAPA PEDAL ACELADOR</p> <p>OPEL ASTRA F (T92) OPTIMA 1.4 (F19, M19) 09.1991/09.1993 55KW 75CV 1389CC 14 NV - OPEL ASTRA F (T92) OPTIMA 1.4 (F19, M19) 09.1992/09.1998 60KW 82CV 1389CC 14 SE - OPEL ASTRA F (T92) OPTIMA 1.4 i (F19, M19) 09.1991/09.1993 55KW 75CV 1389CC X 14 NZ C 14 NZ 0035300 0039873 - OPEL ASTRA F (T92) OPTIMA 1.4 i 16V (F19, M19) 02.1996/09.1998 66KW 90CV 1389CC X 14 XE 0035302 0039955 - OPEL ASTRA F...</p> <p>132x53x14mm</p>		<p>R080255 NO. 300-98mm 1f-d12mm 3f-d6mm 1p-d18x3</p> <p>TUBO RIGIDO REFRIGERAÇÃO</p> <p>OPEL ASTRA F Hatchback (T92) 1.4 (F08 - M08 - F68 - M68) (De 09-1991 Até 09-1993) 55kW 75CV 1389cc Hatchback OPEL ASTRA F Hatchback (T92) 1.4 (F08 - M08 - F68 - M68) (De 09-1992 Até 01-1998) 60kW 82CV 1389cc Hatchback OPEL ASTRA F Hatchback (T92) 1.6 (F08 - M08 - F68 - M68) (De 09-1995 Até 01-1998) 55kW 75CV 1598cc Hatchback OPEL ASTRA F (T92) 1.4 (F19 - M19) (De 09-1991 Até 09-1993) 55KW 75CV ...</p> <p>B330-34/34mm 300-98mm 1f-d12mm 3f-d6mm 1p-d18x3mm 1p-</p>
	<p>R221402 NO. 90-80-115-230-150mm + ch-d7mm 40-5</p> <p>TUBO DE LIGAÇÃO AO DEPÓSITO DO ARREFECIMENTO</p> <p>OPEL ASTRA F Hatchback (T92): 1.4 i (F08, M08, F68, M68) 09.1991/01.1998 44KW 60CV 1389CC - OPEL ASTRA F Hatchback (T92): 1.4 (F08, M08, F68, M68) 09.1991/09.1993 55KW 75CV 1389CC - OPEL ASTRA F Hatchback (T92): 1.4 (F08, M08, F68, M68) 09.1992/01.1998 60KW 82CV 1389CC - OPEL ASTRA F Hatchback (T92): 1.6 i (F08, M08, F68, M68) 05.1993/07.1996 52KW 71CV 1598CC - OPEL ASTRA F Hatchback (T92): 1.6 i...</p> <p>B400-d19/15mm 90-80-115-230-150mm + ch-d7mm 40-55</p>		<p>R221420 NO. 1337106 - 90421900</p> <p>TUBO SUPERIOR DE ENTRADA DE ÁGUA DO RADIADOR</p> <p>OPEL ASTRA F (T92) 1.7 D (F19, M19) 03.1992/09.1992 42KW 57CV 1699CC 17 D 0039878 - OPEL ASTRA F (T92) 1.7 D (F19, M19) 07.1992/09.1998 44KW 60CV 1699CC 17 DR 0039888 - OPEL ASTRA F Caixa/Combi (T92) 1.7 D (F70) 12.1991/09.1992 42KW 57CV 1699CC 17 D 0039119 - OPEL ASTRA F Caixa/Combi (T92) 1.7 D (F70) 07.1992/01.1999 44KW 60CV 1699CC 17 DR 0039121 - OPEL ASTRA F Combi (T92) 1.7 D (F35, M35) 12.199...</p> <p>B135-d34mm 100-120-70mm</p>
	<p>R221421 NO. 1337111 - 90421905</p> <p>TUBO INFERIOR DE SAÍDA DE ÁGUA DO RADIADOR</p> <p>OPEL ASTRA F (T92) 1.7 D (F19, M19) 03.1992/09.1992 42KW 57CV 1699CC 17 D 0039878 - OPEL ASTRA F (T92) 1.7 D (F19, M19) 07.1992/09.1998 44KW 60CV 1699CC 17 DR 0039888 - OPEL ASTRA F Caixa/Combi (T92) 1.7 D (F70) 12.1991/09.1992 42KW 57CV 1699CC 17 D 0039119 - OPEL ASTRA F Caixa/Combi (T92) 1.7 D (F70) 07.1992/01.1999 44KW 60CV 1699CC 17 DR 0039121 - OPEL ASTRA F Combi (T92) 1.7 D (F35, M35) 12.199...</p> <p>B480-d38/34mm 70-135-255-70mm</p>		<p>R221422 NO. 1818159</p> <p>TUBO DE ENTRADA DE ÁGUA DE AQUECIMENTO</p> <p>OPEL ASTRA F (T92) 1.7 D (F19, M19) 03.1992/09.1992 42KW 57CV 1699CC 17 D 0039878 - OPEL ASTRA F (T92) 1.7 D (F19, M19) 07.1992/09.1998 44KW 60CV 1699CC 17 DR 0039888 - OPEL ASTRA F Caixa/Combi (T92) 1.7 D (F70) 12.1991/09.1992 42KW 57CV 1699CC 17 D 0039119 - OPEL ASTRA F Caixa/Combi (T92) 1.7 D (F70) 07.1992/01.1999 44KW 60CV 1699CC 17 DR 0039121 - OPEL ASTRA F Combi (T92) 1.7 D (F35, M35) 12.199...</p> <p>B450-d20/14mm 45-50-135-225-85-135-55mm</p>
	<p>R221423 NO. 1818202 - 90409599</p> <p>TUBO RETORNO DE ÁGUA DE AQUECIMENTO</p> <p>OPEL ASTRA F (T92) 1.7 D (F19, M19) 03.1992/09.1992 42KW 57CV 1699CC 17 D 0039878 - OPEL ASTRA F (T92) 1.7 D (F19, M19) 07.1992/09.1998 44KW 60CV 1699CC 17 DR 0039888 - OPEL ASTRA F Caixa/Combi (T92) 1.7 D (F70) 12.1991/09.1992 42KW 57CV 1699CC 17 D 0039119 - OPEL ASTRA F Caixa/Combi (T92) 1.7 D (F70) 07.1992/01.1999 44KW 60CV 1699CC 17 DR 0039121 - OPEL ASTRA F Combi (T92) 1.7 D (F35, M35) 12.199...</p> <p>B340-d20/15mm 55-55-5550-80-60-90-75mm</p>		<p>R221430 NO. 1337107</p> <p>TUBO SUPERIOR DE ENTRADA DE ÁGUA NO RADIADOR</p> <p>OPEL ASTRA F (T92) 1.7 TD (F19, M19) 11.1994/09.1998 50KW 68CV 1699CC X 17 DTL 0039937 0035307 - OPEL ASTRA F Caixa/Combi (T92) 1.7 TD (F70) 08.1994/01.1999 50KW 68CV 1699CC X 17 DTL 0039127 - OPEL ASTRA F Combi (T92) 1.7 TD (F35, M35) 11.1994/01.1998 50KW 68CV 1699CC X 17 DTL 0039936 0035325 - OPEL ASTRA F Hatchback (T92) 1.7 TD (F08, M08, F68, M68) 11.1994/01.1998 50KW 68CV 1699CC X 17 DTL 00399...</p> <p>B315-d34/31mm 40-80-120-75mm</p>
	<p>R221431 NO. 1337098 - 90421810</p> <p>TUBO INFERIOR DA SAÍDA DE ÁGUA DO RADIADOR</p> <p>OPEL ASTRA F (T92) 1.7 TD (F19, M19) 11.1994/09.1998 50KW 68CV 1699CC X 17 DTL 0039937 0035307 - OPEL ASTRA F Caixa/Combi (T92) 1.7 TD (F70) 08.1994/01.1999 50KW 68CV 1699CC X 17 DTL 0039127 - OPEL ASTRA F Combi (T92) 1.7 TD (F35, M35) 11.1994/01.1998 50KW 68CV 1699CC X 17 DTL 0039936 0035325 - OPEL ASTRA F Combi (T92) 1.7 TDS (F35, M35) 12.1991/01.1998 60KW 82CV 1686CC 17 TD X17TD 17 DT 0035326 ...</p> <p>B290-d35/30mm 65-140-100-50-ch85-d14mm</p>		<p>R221451 NO. 1337193 - 90410065 - 90444477</p> <p>TUBO DE RADIADOR INFERIOR</p> <p>OPEL ASTRA F Cabriolet (T92) 1.4 i 16V 01.1996/03.2001 66KW 90CV 1389CC X 14 XE 0035327 0039958 - OPEL ASTRA F Cabriolet (T92) 1.4 Si 05.1993/03.2001 60KW 82CV 1389CC C 14 SE 0039895</p> <p>B360-d37/33mm 125-205-65mm</p>

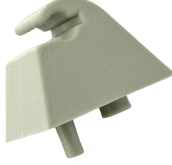

	<p>R221485 NO. 1336812 - 1337463 - 90265803 - 90530796</p> <p>TUBO DE LIGAÇÃO Á BOMBA DE ÁGUA</p> <p>OPEL ASTRA F (T92) 1.6 (F19, M19) (De 1995.09 Até 1998.09) 55kW 75cv 1598cm3 três volumes - OPEL ASTRA F (T92) 1.6 i (F19, M19) (De 1993.05 Até 1996.07) 52kW 71cv 1598cm3 três volumes - OPEL ASTRA F (T92) 1.6 i (F19, M19) (De 1992.03 Até 1998.09) 55kW 75cv 1598cm3 três volumes - OPEL ASTRA F (T92) 1.8 i (F19, M19) (De 1992.03 Até 1998.09) 66kW 90cv 1796cm3 três volumes -</p> <p>B165-32/38mm 47x47x55mm</p>		<p>R222719 NO. 1336294 - 1337395 - 90128078 - 90166058 - 90570030</p> <p>TUBO DE LIGAÇÃO TERMOSTATO Á BOMBA DE ÁGUA</p> <p>OPEL ASTRA F Hatchback (T92): 1.7 D (F08, M08, F68, M68) 12.1991/09.1992 42kW 57CV 1699CC - OPEL ASTRA F Hatchback (T92): 1.7 D (F08, M08, F68, M68) 07.1992/01.1998 44kW 60CV 1699CC - OPEL ASTRA F (T92): 1.7 D (F19, M19) 03.1992/09.1998 42kW 57CV 1699CC - OPEL ASTRA F (T92): 1.7 D (F19, M19) 07.1992/09.1998 44kW 60CV 1699CC - OPEL ASTRA F Combi (T92): 1.7 D (F35, M35) 12.1991/09.1992 42kW 57CV 1699CC</p> <p>boca a boca 137 mm d1 31mmd2 32mm</p>
	<p>R222740 NO. 1337095 - 90354836</p> <p>TUBO LIGAÇÃO TERMOSTATO BOMBA DE ÁGUA</p> <p>OPEL ASTRA F Hatchback (T92) 1.4 i (F08 - M08 - F68 - M68) (De 09-1991 Até 01-1998) 44kW 60CV 1389cc Hatchback OPEL ASTRA F Hatchback (T92) 1.4 (F08 - M08 - F68 - M68) (De 09-1991 Até 09-1993) 55kW 75CV 1389cc Hatchback OPEL ASTRA F Hatchback (T92) 1.4 Si (F08 - M08 - F68 - M68) (De 03-1992 Até 01-1998) 60kW 82CV 1389cc Hatchback OPEL ASTRA F Hatchback (T92) 1.4 (F08 - M08 - F68 - M68) (De 09-1991...</p> <p>B138-28/38mm 32-57-51mm</p>		<p>R222769 NO. 1336509 - 1337465 - 90351806 - 90530799</p> <p>TUBO DE LIGAÇÃO AO TERMOSTATO</p> <p>OPEL ASTRA F (T92) 2.0 i (F19, M19) 03.1992/09.1998 85kW 115CV 1998CC C 20 NE 0039877 - OPEL ASTRA F Cabriolet (T92) 2.0 i 03.1993/10.1994 85kW 115CV 1998CC C 20 NE 0039896 - OPEL ASTRA F Combi (T92) 2.0 i (F35, M35) 09.1991/07.1994 85kW 115CV 1998CC C 20 NE 0039858 - OPEL ASTRA F Hatchback (T92) 2.0 i (F08, M08, F68, M68) 09.1991/01.1998 85kW 115CV 1998CC C 20 NE 0039866</p> <p>B220-d20/20mm 80-70-60-70-60mm</p>
	<p>R222799 NO. 0836770 - 836770 - 90351553</p> <p>TUBO ADMISSÃO FILTRO DE AR</p> <p>OPEL ASTRA F Hatchback (T92): 1.4 i (F08, M08, F68, M68) 09.1991/01.1998 44kW 60CV 1389CC OPEL ASTRA F Hatchback (T92): 1.6 i (F08, M08, F68, M68) 05.1993/07.1996 52kW 71CV 1598CC - OPEL ASTRA F Hatchback (T92): 1.6 i (F08, M08, F68, M68) 09.1991/01.1998 55kW 75CV 1598CC - OPEL ASTRA F Hatchback (T92): 1.6 i (F08, M08, F68, M68) 09.1995/01.1998 55kW 75CV 1598CC - OPEL ASTRA F Hatchback (T92): 1.8 i ...</p> <p>boca a boca 204 mm d1 59mmd2 61mm</p>		<p>R222803 NO. 836772 - 90351561</p> <p>TUBO DE AMISSÃO FILTRO DE AR</p> <p>OPEL ASTRA F (T92) 1.4 Si (F19, M19) (De 03.1992 Até 09.1998) 60kW 82cv 1389cm3 três volumes - OPEL ASTRA F (T92) 1.6 Si (F19, M19) (De 05.1992 Até 12.1994) 74kW 100cv 1598cm3 três volumes - OPEL ASTRA F Cabriolet (T92) 1.4 Si (De 05.1993 Até 03.2001) 60kW 82cv 1389cm3 Cabriolet - OPEL ASTRA F Combi (T92) 1.4 Si (F35, M35) (De 03.1992 Até 01.1998) 60kW 82cv 1389cm3 Combi - OPEL ASTRA F Combi (T92)...</p> <p>boca a boca 170 mm d1 64mmd2 66mm</p>
	<p>R222811 NO. 650872</p> <p>TUBO DE LIGAÇÃO AO TERMOSTATO</p> <p>OPEL ASTRA F (T92) 1.7 D (F19, M19) 03.1992/09.1992 42kW 57CV 1699CC 17 D 0039878 - OPEL ASTRA F (T92) 1.7 D (F19, M19) 07.1992/09.1998 44kW 60CV 1699CC 17 DR 0039888 - OPEL ASTRA F (T92): 1.6 i (F08, M08, F68, M68) 05.1993/07.1996 52kW 71CV 1598CC 17 TD X 17 DT 0035308 0039879 - OPEL ASTRA F Combi (T92) 1.7 D (F35, M35) 12.1991/09.1992 42kW 57CV 1699CC 17 D 0039859 - OPEL ASTRA F Combi (T92) 1.7 D (F35, M...)</p> <p>B57-15/15mm 50x22x50mm</p>		<p>R222812 NO. 650873</p> <p>TUBO LIGAÇÃO TERMOSTATO</p> <p>OPEL ASTRA F Hatchback (T92) 1.7 D (F08 - M08 - F68 - M68) (De 12-1991 Até 09-1992) 42kW 57CV 1700cc Hatchback OPEL ASTRA F Hatchback (T92) 1.7 D (F08 - M08 - F68 - M68) (De 07-1992 Até 01-1998) 44kW 60CV 1700cc Hatchback OPEL ASTRA F Hatchback (T92) 1.7 TDS (F08 - M08 - F68 - M68) (De 12-1991 Até 01-1998) 60kW 82CV 1686cc Hatchback OPEL ASTRA F (T92) 1.7 D (F19 - M19) (De 03-1992 Até 09-1992) ...</p> <p>B97-14/14mm 60-41mm</p>
	<p>R222871 NO. 650872 - 650873</p> <p>TUBOS DE LIGAÇÃO AO TERMOSTATO</p> <p>OPEL ASTRA F (T92) OPTIMA 1.7 TDS (F19, M19) 03.1992/09.1998 60kW 82CV 1686CC 17 TD X 17 DT 0035308 0039879 - OPEL ASTRA F Combi (T92) 1.7 TDS (F35, M35) 12.1991/01.1998 60kW 82CV 1686CC 17 DT X 17 DT 0035326 0039860 - OPEL ASTRA F Hatchback (T92) 1.7 TDS (F08, M08, F68, M68) 12.1991/01.1998 60kW 82CV 1686CC 17 DT X 17 DT 0035317 0039869</p> <p>B113-14/14mm B56-16/16mm 40x59mm 40x1540mm</p>		<p>R225254 NO. 1337233 - 97086694</p> <p>TUBO LIGAÇÃO TERMOSTATO</p> <p>OPEL ASTRA F (T92) 1.7 TD (F19 - M19) (De 11-1994 Até 09-1998) 50kW 68CV 1700cc três volumes</p> <p>B78-15-15mm 48-47mm</p>
	<p>R8150 NO. 0836791 - 836791 - 90411677</p> <p>TUBO ADMISSÃO FILTRO DE AR</p> <p>OPEL ASTRA F Cabriolet (T92) 1.8 i 16V 11.1994/03.2001 85kW 116CV 1799CC C 18 XEL X 18 XE 0039938 0035329 - OPEL ASTRA F Combi (T92) 1.8 i 16V (F35, M35) 06.1993/01.1998 92kW 125CV 1799CC C 18 XE 0039899 - OPEL ASTRA F Combi (T92) 1.8 i 16V (F35, M35) 07.1994/01.1998 85kW 116CV 1799CC X 18 XE C 18 XEL 0039920 0035323 - OPEL ASTRA F Combi (T92) 2.0 i 16V (F35, M35) 02.1995/01.1998 100kW 136CV 1998CC...</p> <p>B215-62/72mm 85-128mm ch-d18x42mm</p>		<p>R8151 NO. 0838276 - 838276 - 90470097</p> <p>TUBO LIGAÇÃO COLECTOR ADMISSÃO</p> <p>OPEL ASTRA F CLASSIC Combi (T92) 1.6 i 16V (F35, M35) 01.1998/01.2005 74kW 101CV 1598CC X 16 XEL - OPEL ASTRA F CLASSIC Hatchback (T92) 1.6 i 16V (F08, M08, F68, M68) 01.1998/08.2002 74kW 101CV 1598CC X 16 XEL - OPEL ASTRA F CLASSIC três volumes (T92) 1.6 i 16V (F19, M19) 01.1998/08.2002 74kW 101CV 1598CC X 16 XEL - OPEL ASTRA F Combi (T92) 1.6 i 16V (F35, M35) 08.1994/01.1998 74kW 100CV 1598CC X ...</p> <p>d76x49mm 1f-d67mm</p>
	<p>RF80245 NO. 0606401 - 606401</p> <p>TUBO DE FERRO REFRIGERAÇÃO</p> <p>OPEL ASTRA F Hatchback (T92) 1.8 i (F08 - M08 - F68 - M68) (De 09-1991 Até 01-1998) 66kW 90CV 1796cc Hatchback OPEL ASTRA F Hatchback (T92) 1.8 i 16V (F08 - M08 - F68 - M68) (De 09-1994 Até 01-1998) 85kW 116CV 1799cc Hatchback OPEL ASTRA F Hatchback (T92) 1.8 i 16V (F08 - M08 - F68 - M68) (De 06-1993 Até 08-1994) 92kW 125CV 1799cc Hatchback OPEL ASTRA F Hatchback (T92) 2.0 i (F08 - M08 - F68 - ...)</p> <p>d35x51mm c45mm 1f-d31</p>		<p>RF80248 NO. ch-d30-25mm ch-d15-25mm ch-d13-25m</p> <p>TUBO DE FERRO REFRIGERAÇÃO</p> <p>OPEL ASTRA F Hatchback (T92) 1.7 D (F08 - M08 - F68 - M68) (De 12-1991 Até 09-1992) 42kW 57CV 1700cc Hatchback OPEL ASTRA F Hatchback (T92) 1.7 D (F08 - M08 - F68 - M68) (De 07-1992 Até 01-1998) 44kW 60CV 1700cc Hatchback OPEL ASTRA F (T92) 1.7 D (F19 - M19) (De 03-1992 Até 09-1992) 42kW 57CV 1700cc três volumes OPEL ASTRA F (T92) 1.7 D (F19 - M19) (De 07-1992 Até 09-1998) 44kW 60CV 1700cc três...</p> <p>B470-28/34mm ch-d30-25mm ch-d15-25mm ch-d13-25mm 2f-9mm...</p>
	<p>RT08541 NO. 4565719 - 562346 - 90235999 - 96179489</p> <p>TUBO DE TRAVÃO TRÁS LH-RH</p> <p>OPEL ASTRA F TT (09-1991 A 09-1998) - OPEL CALIBRA TT (10-1989 A 07-1992) - OPEL CORSA A TT (08-1985 A 03-1993) - CORSA B TT (03-1993 A 09-2000) - OPEL KADETT E TT (08-1985 A 09-1991) - OPEL TIGRA TT (APÓS 07-1994) - OPEL VECTRA A TT (09-1988 A 11-1995) -</p> <p>195mm FB3/1 - FB3/1</p>		<p>RT08545 NO. 562345 - 562350 - 562358 - 90235568 - 90374106 - 90468316 - 90468319</p> <p>TUBO DE TRAVÃO FRENTE LH-RH</p> <p>OPEL ASTRA F Hatchback (T92): 1.4 i (F08, M08, F68, M68) 09.1991/01.1998 44kW 60CV 1389CC - OPEL ASTRA F Hatchback (T92): 1.4 (F08, M08, F68, M68) 09.1991/09.1993 55kW 75CV 1389CC - OPEL ASTRA F Hatchback (T92): 1.4 Si (F08, M08, F68, M68) 03.1992/01.1998 60kW 82CV 1389CC - OPEL ASTRA F Hatchback (T92): 1.4 (F08, M08, F68, M68) 09.1992/01.1998 60kW 82CV 1389CC - OPEL ASTRA F Hatchback (T92): 1.4 i...</p> <p>310mm FB3/1 - OR1</p>

	<p>RT08614 NO. 4483285 - 562352 - 562359 - 90425239 - 90468320</p> <p>TUBO DE TRAVÃO TRÁS LH-RH</p> <p>OPEL ASTRA F TT (BERLINA - SALOON) (09-1991 A 09-1998) - OPEL CALIBRA (08-1992 A 07-1997)</p>		<p>S1127 NO. 352300 - 352346</p> <p>SILENT-BLOC DO BRAÇO DA SUSPENSÃO FRENTE DIAM.12mm</p> <p>OPEL ASTRA (F) 1.4 - 1.6 - 1.8 - 2.0 - ASTRA DIESEL 1.7 - ASTRA TURBO DIESEL 1.7</p>
	<p>S1128 NO. 90268463 - 0352348 - 352347 - 352348 - 353460 - 90250709</p> <p>SILENT-BLOC EXTERIOR DO BRAÇO DA SUSPENSÃO FRENTE DIAM.16mm</p> <p>OPEL ASTRA (F) 1.4 - 1.6 - 1.8 - 2.0 - ASTRA DIESEL 1.7 - 1.7TD</p>		<p>S1275 NO. 402642 - 90189050</p> <p>SILENT-BLOC DA SUSPENSÃO DE TRÁS</p> <p>OPEL ASTRA F Hatchback (T92): 1.4 i (F08, M08, F68, M68) 09.1991/01.1998 44KW 60CV 1389CC - OPEL ASTRA F Hatchback (T92): 1.4 (F08, M08, F68, M68) 09.1991/09.1993 55KW 75CV 1389CC - OPEL ASTRA F Hatchback (T92): 1.4 Si (F08, M08, F68, M68) 03.1992/01.1998 60KW 82CV 1389CC - OPEL ASTRA F Hatchback (T92): 1.4 (F08, M08, F68, M68) 09.1992/01.1998 60KW 82CV 1389CC - OPEL ASTRA F Hatchback (T92): 1.4 ...</p>
	<p>UMB84011 NO. 031126</p> <p>TAMPÃO BLOCO MOTOR</p> <p>OPEL ASTRA F Hatchback (T92) 1.4 i (F08 - M08 - F68 - M68) (De 03-1992 Até 01-1998) 44KW 60CV 1389cc Hatchback OPEL ASTRA F Hatchback (T92) 1.4 (F08 - M08 - F68 - M68) (De 09-1991 Até 09-1993) 55kW 75CV 1389cc Hatchback OPEL ASTRA F Hatchback (T92) 1.4 i 16V (F08 - M08 - F68 - M68) (De 01-1996 Até 01-1998) 66kW 90CV 1389cc Hatchback OPEL ASTRA F Hatchback (T92) 1.6 i (F08 - M08 - F68 - M68) (De...</p>		<p>UMB84011L NO. 11062402 - 2060675</p> <p>TAMPÃO BLOCO DE MOTOR (RELAS)</p> <p>OPEL ASTRA F Hatchback (T92) 1.4 i (F08 - M08 - F68 - M68) (De 03-1992 Até 01-1998) 44KW 60CV 1389cc Hatchback OPEL ASTRA F Hatchback (T92) 1.4 (F08 - M08 - F68 - M68) (De 09-1991 Até 09-1993) 55kW 75CV 1389cc Hatchback OPEL ASTRA F Hatchback (T92) 1.4 i 16V (F08 - M08 - F68 - M68) (De 01-1996 Até 01-1998) 66kW 90CV 1389cc Hatchback OPEL ASTRA F Hatchback (T92) 1.6 i (F08 - M08 - F68 - M68) (De 05...</p>
	<p>UMB84019 NO. 2060668</p> <p>TAMPÃO BLOCO MOTOR</p> <p>OPEL ASTRA F Hatchback (T92) 1.4 i (F08 - M08 - F68 - M68) (De 03-1992 Até 01-1998) 44KW 60CV 1389cc Hatchback OPEL ASTRA F Hatchback (T92) 1.4 (F08 - M08 - F68 - M68) (De 09-1991 Até 09-1993) 55kW 75CV 1389cc Hatchback OPEL ASTRA F Hatchback (T92) 1.4 i 16V (F08 - M08 - F68 - M68) (De 01-1996 Até 01-1998) 66kW 90CV 1389cc Hatchback OPEL ASTRA F Hatchback (T92) 1.6 i (F08 - M08 - F68 - M68) (De...</p>		<p>UMB84019L NO. 2060668</p> <p>TAMPÃO BLOCO DE MOTOR (RELAS)</p> <p>OPEL ASTRA F Hatchback (T92) 1.4 i (F08 - M08 - F68 - M68) (De 03-1992 Até 01-1998) 44KW 60CV 1389cc Hatchback OPEL ASTRA F Hatchback (T92) 1.4 (F08 - M08 - F68 - M68) (De 09-1991 Até 09-1993) 55kW 75CV 1389cc Hatchback OPEL ASTRA F Hatchback (T92) 1.4 i 16V (F08 - M08 - F68 - M68) (De 01-1996 Até 01-1998) 66kW 90CV 1389cc Hatchback OPEL ASTRA F Hatchback (T92) 1.6 i (F08 - M08 - F68 - M68) (De 05...</p>
	<p>UMB84021 NO. 2060673</p> <p>TAMPÃO BLOCO MOTOR</p> <p>OPEL ASTRA F Hatchback (T92) 1.4 i (F08 - M08 - F68 - M68) (De 03-1992 Até 01-1998) 44KW 60CV 1389cc Hatchback OPEL ASTRA F Hatchback (T92) 1.4 (F08 - M08 - F68 - M68) (De 09-1991 Até 09-1993) 55kW 75CV 1389cc Hatchback OPEL ASTRA F Hatchback (T92) 1.4 Si (F08 - M08 - F68 - M68) (De 03-1992 Até 01-1998) 60kW 82CV 1389cc Hatchback OPEL ASTRA F Hatchback (T92) 1.4 (F08 - M08 - F68 - M68) (De 09-1992...</p>		<p>UMB84021L NO. 2060673</p> <p>TAMPÃO BLOCO DE MOTOR (RELAS)</p> <p>OPEL ASTRA F Hatchback (T92) 1.4 i (F08 - M08 - F68 - M68) (De 03-1992 Até 01-1998) 44KW 60CV 1389cc Hatchback OPEL ASTRA F Hatchback (T92) 1.4 (F08 - M08 - F68 - M68) (De 09-1991 Até 09-1993) 55kW 75CV 1389cc Hatchback OPEL ASTRA F Hatchback (T92) 1.4 Si (F08 - M08 - F68 - M68) (De 03-1992 Até 01-1998) 60kW 82CV 1389cc Hatchback OPEL ASTRA F Hatchback (T92) 1.4 (F08 - M08 - F68 - M68) (De 09-1992...</p>
	<p>UMB84029 NO. 2060946</p> <p>TAMPÃO BLOCO MOTOR</p> <p>OPEL ASTRA F Hatchback (T92) 1.4 i (F08, M08, F68, M68) (09.91 A 01.98) 60cv 1389cc Hatchback - OPEL ASTRA F Van (T92) 1.7 TD (F70) (08.94 A 01.99) 68cv 1700cc Caixa</p>		<p>UMV25433 NO. 5738983</p> <p>MANETE PUNHO TOPO ALAVANCA MUDANÇAS 5 VELOCIDADES F19MM</p> <p>OPEL ASTRA F (T92) 1.4 (F19, M19) (De 09.1991 Até 09.1993) 55kW 75cv 1389cm3 três volumes - OPEL ASTRA F (T92) 1.4 (F19, M19) (De 09.1992 Até 09.1998) 60kW 82cv 1389cm3 três volumes - OPEL ASTRA F (T92) 1.4 Si (F19, M19) (De 03.1992 Até 09.1998) 60kW 82cv 1389cm3 três volumes - OPEL ASTRA F (T92) 1.4 i (F19, M19) (De 09.1991 Até 09.1998) 44kW 60cv 1389cm3 três volumes - OPEL ASTRA F (T92) 1.4 i 16...</p>
	<p>UMV26806 NO. 5738736 - 90511219</p> <p>MANETE PUNHO TOPO ALAVANCA MUDANÇAS 5 VELOCIDADES F19MM</p> <p>OPEL ASTRA F Hatchback (T92): 1.4 i (F08, M08, F68, M68) 09.1991/01.1998 44KW 60CV 1389CC - OPEL ASTRA F Hatchback (T92): 1.4 i 16V (F08, M08, F68, M68) 09.1996/02.1998 66KW 90CV 1389CC - OPEL ASTRA F Hatchback (T92): 1.6 i (F08, M08, F68, M68) 05.1993/07.1996 52KW 71CV 1598CC - OPEL ASTRA F Hatchback (T92): 1.6 (F08, M08, F68, M68) 09.1995/01.1998 55KW 75CV 1598CC - OPEL ASTRA F Hatchback (T92): ...</p>		<p>UMV26809 NO. 5738737 - 90540619 - 9200972</p> <p>MANETE PUNHO TOPO ALAVANCA MUDANÇAS 5 VELOCIDADES F32MM</p> <p>OPEL ASTRA F Hatchback (T92): 1.4 i (F08, M08, F68, M68) 09.1991/01.1998 44KW 60CV 1389CC - OPEL ASTRA F Hatchback (T92): 1.4 i 16V (F08, M08, F68, M68) 09.1996/02.1998 66KW 90CV 1389CC - OPEL ASTRA F Hatchback (T92): 1.6 i (F08, M08, F68, M68) 05.1993/07.1996 52KW 71CV 1598CC - OPEL ASTRA F Hatchback (T92): 1.6 (F08, M08, F68, M68) 09.1995/01.1998 55KW 75CV 1598CC - OPEL ASTRA F Hatchback (T92): ...</p>
	<p>UTR0800 NO. 1304240 - 1304654 - 1304659 - 1304660 - 1304661 - 1304665 - 1304666 - 1304667 - 1304853 - 90352470 - ...</p> <p>TAMPÃO RESERVATÓRIO LÍQUIDO REFRIGERAÇÃO</p> <p>OPEL ASTRA F Hatchback 1.4 i (03.92 A 01.98) 60cv 1389cc Hatchback - OPEL ASTRA F Hatchback 1.4 (09.91 A 09.93) 75cv 1389cc Hatchback - OPEL ASTRA F Hatchback 1.4 Si (03.92 A 01.98) 82cv 1389cc Hatchback - OPEL ASTRA F Hatchback 1.4 (09.92 A 01.98) 82cv 1389cc Hatchback - OPEL ASTRA F Hatchback 1.4 i 16V (01.96 A 01.98) 90cv 1389cc Hatchback OPEL ASTRA F Hatchback 1.6 i (05.93 A 07.96) 7...</p>		<p>UTR0811 NO. 1304659 - 1304660 - 1304661 - 1304665 - 1304666 - 1304853 - 4395513 - 90352470 - 90409256 - 90409257...</p> <p>TAMPÃO RESERVATÓRIO LÍQUIDO REFRIGERAÇÃO</p> <p>OPEL ASTRA F Hatchback 1.4 i (03.92 A 01.98) 60cv 1389cc Hatchback - OPEL ASTRA F Hatchback 1.4 (09.91 A 09.93) 75cv 1389cc Hatchback - OPEL ASTRA F Hatchback 1.4 Si (03.92 A 01.98) 82cv 1389cc Hatchback - OPEL ASTRA F Hatchback 1.4 (09.92 A 01.98) 82cv 1389cc Hatchback - OPEL ASTRA F Hatchback 1.6 i (05.93 A 07.96) 71cv 1598cc Hatchback - OPEL ASTRA F Hatchback 1.6 i (09.91 A 01.98) 7...</p>

















	Y3212	NO. 1008501 - 1008504 - 4709077		Y3212	NO. 1008501 - 1008504 - 4709077
	<p>PARAFUSO PERNO RODA CHAVE 17 M12X1,50X48MM (BASE CONICA PARA JANTES AÇO E LIGA LEVE)</p> <p>OPEL ASTRA F (T92) 1.4 (F19, M19) (09.1991 - 09.1993) 55kw 75cv 1389cm3 três volumes OPEL ASTRA F (T92) 1.4 (F19, M19) (09.1992 - 09.1998) 60kw 82cv 1389cm3 três volumes OPEL ASTRA F (T92) 1.4 Si (F19, M19) (03.1992 - 09.1998) 60kw 82cv 1389cm3 três volumes OPEL ASTRA F (T92) 1.4 i (F19, M19) (09.1991 - 09.1998) 44kw 60cv 1389cm3 três volumes OPEL ASTRA F (T92) 1.4 i 16V (F19, M19) (02.1996 - 09.1...</p>			<p>PARAFUSO PERNO RODA CHAVE 17 M12X1,50X48MM (BASE CONICA PARA JANTES AÇO E LIGA LEVE)</p> <p>OPEL ASTRA F Cabriolet (T92) 1.4 Si (05.1993 - 03.2001) 60kw 82cv 1389cm3 Cabriolet OPEL ASTRA F Cabriolet (T92) 1.4 i 16V (01.1996 - 03.2001) 66kw 90cv 1389cm3 Cabriolet OPEL ASTRA F Cabriolet (T92) 1.6 i (03.1993 - 08.1996) 52kw 71cv 1598cm3 Cabriolet OPEL ASTRA F Cabriolet (T92) 1.6 i (01.1996 - 03.2001) 55kw 75cv 1598cm3 Cabriolet OPEL ASTRA F Cabriolet (T92) 1.8 i 16V (11.1994 - 03.2001) 85kw...</p>	
C48mm (Ch-17mm)		M12x1,50x22mm	C48mm (Ch-17mm)		M12x1,50x22mm
	Y3212	NO. 1008501 - 1008504 - 4709077		Y3212	NO. 1008501 - 1008504 - 4709077
	<p>PARAFUSO PERNO RODA CHAVE 17 M12X1,50X48MM (BASE CONICA PARA JANTES AÇO E LIGA LEVE)</p> <p>OPEL ASTRA F Caixa/Combi (T92) 1.4 i (F70) (10.1991 - 01.1999) 44kw 60cv 1389cm3 Caixa/Combi OPEL ASTRA F Caixa/Combi (T92) 1.6 i (F70) (10.1991 - 02.1998) 55kw 75cv 1598cm3 Caixa/Combi OPEL ASTRA F Caixa/Combi (T92) 1.6 i (F70) (02.1993 - 07.1996) 52kw 71cv 1598cm3 Caixa/Combi OPEL ASTRA F Caixa/Combi (T92) 1.7 D (F70) (12.1991 - 09.1992) 42kw 57cv 1699cm3 Caixa/Combi OPEL ASTRA F Caixa/Combi (T9...</p>			<p>PARAFUSO PERNO RODA CHAVE 17 M12X1,50X48MM (BASE CONICA PARA JANTES AÇO E LIGA LEVE)</p> <p>OPEL ASTRA F Hatchback (T92) 1.4 (F08, M08, F68, M68) 09.1991 - 09.1993) 55kw 75cv 1389cm3 Hatchback OPEL ASTRA F Hatchback (T92) 1.4 (F08, M08, F68, M68) 09.1992 - 01.1998) 60kw 82cv 1389cm3 Hatchback OPEL ASTRA F Hatchback (T92) 1.4 Si (F08, M08, F68, M68) 03.1992 - 01.1998) 60kw 82cv 1389cm3 Hatchback OPEL ASTRA F Hatchback (T92) 1.4 i (F08, M08, F68, M68) 09.1991 - 01.1998) 44kw 60cv 1389cm3 H...</p>	
C48mm (Ch-17mm)		M12x1,50x22mm	C48mm (Ch-17mm)		M12x1,50x22mm
	Z80846	NO. 1104881 - 1104882 - 90450482		Z86001	NO. 1438336 - 90332334
	<p>Rebite</p> <p>OPEL ASTRA F</p>			<p>MOLA FIXAÇÃO PALA TAPA-SOL</p> <p>OPEL ASTRA F</p>	
d19x29mm		1p-d8-15.2mm	34x24x24mm		1f-d4mm 1-pino d4x10mm
	Z9004	NO. 856563		Z9011	NO. 1261479 - 1449282600 - 4709339 - 4711509 - 854880
	<p>MOLA DE ESCAPE</p> <p>OPEL ASTRA (F) (APÓS 1991)</p>			<p>MOLA DE ESCAPE</p> <p>OPEL ASTRA F</p>	
25x22x5mm			d23x42mm		

OPEL ASTRA G

	A1630	NO. 0684226 - 0684694 - 684226 - 684694 - 90575186 - 92085608		A1631	NO. 0682502 - 09191558 - 24427641 - 5682534 - 682502 - 9191558
	<p>APOIO DO MOTOR PARTE DA FRENTE CENTRAL</p> <p>OPEL ASTRA G Cabriolet (T98) 1.6 (F67) 01.2003/10.2005 76KW 103CV 1598CC Z 16 XEP 0035472 - OPEL ASTRA G Cabriolet (T98) 1.6 16V (F67) 03.2001/10.2005 74KW 101CV 1598CC Z 16 XE 0035423 - OPEL ASTRA G Cabriolet (T98) 1.8 16V (F67) 03.2001/10.2005 92KW 125CV 1796CC Z 18 XE 0035422 - OPEL ASTRA G Caixa/Combi (F70) 1.6 (F70) 01.1999/09.2000 55KW 75CV 1598CC X 16 SZR 0039131 - OPEL ASTRA G C...</p>			<p>APOIO DO MOTOR PARTE DE TRÁS</p> <p>OPEL ASTRA (G) 2.0 Dti - 2.0 OPC - 2.2 16v</p>	
220x120x80mm		1f-d16mm	130x150x90mm		1f-d13/19mm 1f-d12mm
	A1632	NO. 0684696 - 684696 - 90575192		A1632	NO. 0684696 - 684696 - 90575192
	<p>APOIO DO MOTOR PARTE DA FRENTE</p> <p>OPEL ASTRA (G) (COM CAIXA AUTOMÁTICA) 2.0 16v - 2.0Di - 2.0DTi 16v</p>			<p>APOIO DO MOTOR PARTE DA FRENTE</p> <p>OPEL ASTRA (G) (COM CAIXA AUTOMÁTICA) 2.0 16v - 2.0Di - 2.0DTi 16v - ZAFIRA 2.0 Dti 16v (09-2000 A 06-2005) (COM CAIXA AUTOMÁTICA)</p>	
150x110x80mm		1f-d16mm	150x110x80mm		1f-d16mm
	A1643	NO. 5684048 - 5684049 - 90575459 - 90575460		A1644	NO. 5684045 - 5684046 - 90575456 - 90575457
	<p>APOIO DO MOTOR PARTE DA FRENTE ESQUERDO</p> <p>OPEL ASTRA G Cabriolet (T98) 2.0 OPC (F67) 03.2002/10.2005 141KW 192CV 1998CC Z 20 LET 0035451 - OPEL ASTRA G Cabriolet (T98) 2.2 16V (F67) 03.2001/10.2005 108KW 147CV 2198CC Z 22 SE 0035421 - OPEL ASTRA G Caixa/Combi (F70) 2.0 Di (F70) 01.1999/04.2005 60KW 82CV 1995CC X 20 DTL Y 20 DTL 0039133 - OPEL ASTRA G Combi (T98) 2.0 16V (F35) 02.1998/07.2004 100KW 136CV 1998CC X 20 XEV 0035357 - OPEL ASTR...</p>			<p>APOIO DO MOTOR PARTE DA FRENTE ESQUERDO</p> <p>OPEL ASTRA (G) 1.2 - 1.4 -1.6 - 1.7DTi - 1.8</p>	
160x120x70mm		1f-d13mm	170x105x70mm		1f-d13mm

	<p>A1647 NO. 5684051 - 5684053 - 5684054 - 90575772</p> <p>APOIO DO MOTOR PARTE DA FRENTE DIREITO</p> <p>OPEL ASTRA G Cabriolet (T98) 1.6 (F67) 01.2003/10.2005 76KW 103CV 1598CC Z 16 XEP 0035472 - OPEL ASTRA G Cabriolet (T98) 1.6 16V (F67) 03.2001/10.2005 74KW 101CV 1598CC Z 16 XE 0035423 - OPEL ASTRA G Cabriolet (T98) 1.8 16V (F67) 03.2001/10.2005 92KW 125CV 1796CC Z 18 XE 0035422 - OPEL ASTRA G Caixa/Combi (F70) 1.6 (F70) 01.1999/09.2000 55KW 75CV 1598CC X 16 SZR 0039131 - OPEL ASTRA G Caixa/Combi ...</p> <p>170x140x120mm 1f-d12 - 7mm</p>		<p>A1651 NO. 0684692 - 684692 - 90576047</p> <p>APOIO DO MOTOR PARTE DA FRENTE CENTRAL</p> <p>OPEL ASTRA (G) 1.2 - 1.6 - 1.7 DTi - 1.7 TD</p> <p>230x130x80mm 1f-d16mm</p>
	<p>A1685 NO. 684693</p> <p>APOIO DO MOTOR PARTE DA FRENTE</p> <p>OPEL ASTRA (G) 1.4 16v - 1.6 - 1.6 16v - 1.8 16v (COM TRANSMISSÃO AUTOMÁTICA)</p> <p>145x125x75mm 1f-d16mm</p>		<p>A1691 NO. 0684697 - 684697 - 90576048</p> <p>APOIO DO MOTOR PARTE DA FRENTE</p> <p>OPEL ASTRA G Combi (T98) 2.0 DI (F35) 02.1998/07.2004 60KW 82CV 1995CC Y 20 DTLX 20 DTL 0035356 - OPEL ASTRA G Combi (T98) 2.0 DTI 16V (F35) 08.1999/07.2004 74KW 101CV 1995CC Y 20 DTH 0035377 - OPEL ASTRA G Hatchback (T98) 2.0 DI (F08, F48) 02.1998/01.2005 60KW 82CV 1995CC X 20 DTLY 20 DTL 0035348 - OPEL ASTRA G Hatchback (T98) 2.0 DTI 16V (F08, F48) 08.1999/01.2005 74KW 101CV 1995CC Y 20 DTH 0035...</p> <p>170x123x75mm 1f-d16mm</p>
	<p>A1692 NO. 5682519 - 90538582</p> <p>APOIO DO MOTOR PARTE DE TRÁS</p> <p>OPEL ASTRA G</p> <p>155x125x92mm 1f-d12mm</p>		<p>A1694 NO. 0684168 - 0684695 - 09156951 - 09191564 - 5684162 - 684168 - 684695 - 90575190 - 9156951 - 91915...</p> <p>APOIO DO MOTOR PARTE DA FRENTE CENTRAL</p> <p>OPEL ASTRA (G) 2.0 16v - 2.0 OPC - 2.0 16v TURBO - 2.2 16v</p> <p>170x120x75mm 1f-d16mm</p>
	<p>A1943 NO. 0344523 - 344523 - 90468554</p> <p>APOIO SUPORTE AMORTECEDOR FRENTE (GASTA 2 UNIDADES)</p> <p>OPEL ASTRA G Hatchback (F48_, F08_) 1.2 16V (02.98 A 09.00) 65cv 1199cc Hatchback - OPEL ASTRA G Hatchback (F48_, F08_) 1.2 16V (09.00 A 01.05) 75cv 1199cc Hatchback - OPEL ASTRA G Hatchback (F48_, F08_) 1.4 (09.07 A 12.09) 90cv 1364cc Hatchback - OPEL ASTRA G Hatchback (F48_, F08_) 1.4 16V (02.98 A 01.05) 90cv 1389cc Hatchback - OPEL ASTRA G Hatchback (F48_, F08_) 1.6 (02.98 A 09.00) 75cv...</p> <p>d115x45mm 1f-d12mm</p>		<p>A2545 NO. 5684644</p> <p>APOIO DO MOTOR PARTE DA FRENTE LADO DIREITO</p> <p>OPEL ASTRA G Caixa/Combi (F70) 1.7 TD (F70) (De 01.1999 Até 04.2005) 50KW 68cv 1699cm3 Caixa/Combi - OPEL ASTRA G Combi (T98) 1.7 CDTI (F35) (De 04.2003 Até 05.2004) 59KW 80cv 1686cm3 Combi - OPEL ASTRA G Combi (T98) 1.7 DTI 16V (F35) (De 02.2000 Até 07.2004) 55KW 75cv 1686cm3 Combi - OPEL ASTRA G Combi (T98) 1.7 TD (F35) (De 02.1998 Até 08.2000) 50KW 68cv 1699cm3 Combi - OPEL ASTRA G Combi (T98) ...</p> <p>170x65x114mm 2f-d10mm 1f-d12mm 1f-d13mm</p>
	<p>B450 NO. 164987</p> <p>ABRAÇADEIRA DO REVESTIMENTO DO HABITÁCULO</p> <p>OPEL ASTRA G CLASSIC (T98) 1.4 16V (F08, F48) (05.2004 - 07.2009) 66kw 90cv 1389cm3 Hatchback OPEL ASTRA G CLASSIC (T98) 1.6 (F08, F48) (03.2006 - 06.2008) 76kw 103cv 1598cm3 Hatchback OPEL ASTRA G CLASSIC (T98) 1.6 16V (F08, F48) (05.2004 - 02.2006) 74kw 101cv 1598 Hatchback OPEL ASTRA G CLASSIC (T98) 1.7 CDTI (F08, F48) (06.2004 - 07.2009) 59kw 80cv 1686 Hatchback OPEL ASTRA G CLASSIC Caravan (...)</p> <p>245x38x11mm</p>		<p>B450 NO. 164987</p> <p>ABRAÇADEIRA DO REVESTIMENTO DO HABITÁCULO</p> <p>OPEL ASTRA G Cabriolet (T98) 1.6 (F67) (01.2003 - 10.2005) 76kw 103cv 1598cm3 Cabriolet OPEL ASTRA G Cabriolet (T98) 1.6 16V (F67) (03.2001 - 10.2005) 74kw 101cv 1598cm3 Cabriolet OPEL ASTRA G Cabriolet (T98) 1.8 16V (F67) (03.2001 - 10.2005) 92kw 125cv 1796cm3 Cabriolet OPEL ASTRA G Cabriolet (T98) 2.0 16V Turbo (F67) (11.2002 - 10.2005) 147kw 200cv 1998cm3 Cabriolet OPEL ASTRA G Cabriolet (T98)...</p> <p>245x38x11mm</p>
	<p>B450 NO. 164987</p> <p>ABRAÇADEIRA DO REVESTIMENTO DO HABITÁCULO</p> <p>OPEL ASTRA G Caixa/Combi (F70) 1.6 (F70) (01.1999 - 09.2000) 55kw 75cv 1598cm3 Caixa/Combi OPEL ASTRA G Caixa/Combi (F70) 1.6 (F70) (09.2000 - 04.2005) 62kw 84cv 1598cm3 Caixa/Combi OPEL ASTRA G Caixa/Combi (F70) 1.6 (F70) (09.1998 - 01.2004) 74kw 101cv 1598cm3 Caixa/Combi OPEL ASTRA G Caixa/Combi (F70) 1.6 (F70) (02.2004 - 11.2004) 76kw 103cv 1598cm3 Caixa/Combi OPEL ASTRA G Caixa/Combi (F70) 1....</p> <p>245x38x11mm</p>		<p>B450 NO. 164987</p> <p>ABRAÇADEIRA DO REVESTIMENTO DO HABITÁCULO</p> <p>OPEL ASTRA G Coupé (T98) 1.6 16V (F07) (03.2000 - 05.2005) 74kw 101cv 1598cm3 Coupé OPEL ASTRA G Coupé (T98) 1.6 16V (F07) (03.2000 - 05.2005) 76kw 103cv 1598cm3 Coupé OPEL ASTRA G Coupé (T98) 1.8 16V (F07) (03.2000 - 10.2000) 85kw 116cv 1796cm3 Coupé OPEL ASTRA G Coupé (T98) 1.8 16V (F07) (09.2000 - 05.2005) 92kw 125cv 1796cm3 Coupé OPEL ASTRA G Coupé (T98) 2.0 16V Turbo (F07) (09.2000 - 08.2001)...</p> <p>245x38x11mm</p>
	<p>B450 NO. 164987</p> <p>ABRAÇADEIRA DO REVESTIMENTO DO HABITÁCULO</p> <p>OPEL ASTRA G Hatchback (T98) 1.2 16V (F08, F48) (02.1998 - 09.2000) 48kw 65cv 1199cm3 Hatchback OPEL ASTRA G Hatchback (T98) 1.2 16V (F08, F48) (09.2000 - 01.2005) 55kw 75cv 1199cm3 Hatchback OPEL ASTRA G Hatchback (T98) 1.4 (F08, F48) (09.2007 - 12.2009) 66kw 90cv 1364cm3 Hatchback OPEL ASTRA G Hatchback (T98) 1.4 16V (F08, F48) (02.1998 - 01.2005) 66kw 90cv 1389cm3 Hatchback OPEL ASTRA G Hatchb...</p> <p>245x38x11mm</p>		<p>B450 NO. 164987</p> <p>ABRAÇADEIRA DO REVESTIMENTO DO HABITÁCULO</p> <p>OPEL ASTRA G três volumes (T98) 1.2 16V (F69) (09.1998 - 09.2000) 48kw 65cv 1199cm3 três volumes OPEL ASTRA G três volumes (T98) 1.2 16V (F69) (09.2000 - 01.2005) 55kw 75cv 1199cm3 três volumes OPEL ASTRA G três volumes (T98) 1.4 (F69) (09.2007 - 12.2009) 66kw 90cv 1364cm3 três volumes OPEL ASTRA G três volumes (T98) 1.4 16V (F69) (09.1998 - 01.2005) 66kw 90cv 1389cm3 três volumes OPEL ASTRA G tr...</p> <p>245x38x11mm</p>
	<p>C0233 NO. 1160724 - 90054143</p> <p>BOTÃO AFINAÇÃO CAPÔT</p> <p>OPEL ASTRA G Hatchback (F48_ F08_) 1.2 16V (02.98 A 09.00) 65cv 1199cc Hatchback - OPEL ASTRA G Hatchback (F48_ F08_) 1.2 16V (09.00 A 01.05) 75cv 1199cc Hatchback - OPEL ASTRA G Hatchback (F48_ F08_) 1.4 (09.07 A 12.09) 90cv 1364cc Hatchback - OPEL ASTRA G Hatchback (F48_ F08_) 1.4 16V (02.98 A 01.05) 90cv 1389cc Hatchback - OPEL ASTRA G Hatchback (F48_ F08_) 1.6 (02.98 A 09.00) 75cv 159...</p> <p>d19x31mm</p>		<p>E0163 NO. 0350611 - 0350614 - 13169439 - 350611 - 350614 - 90498745</p> <p>ESTICADOR DA BARRA ESTABILIZADORA DA FRENTE</p> <p>OPEL ASTRA G Hatchback (T98): 1.2 16V (F08, F48) 02.1998/09.2000 48KW 65CV 1199CC - OPEL ASTRA G Hatchback (T98): 1.2 16V (F08, F48) 09.2000/01.2005 55KW 75CV 1199CC - OPEL ASTRA G Hatchback (T98): 1.4 (F08, F48) 09.2007/12.2009 66KW 90CV 1364CC - OPEL ASTRA G Hatchback (T98): 1.4 16V (F08, F48) 02.1998/01.2005 66KW 90CV 1389CC - OPEL ASTRA G Hatchback (T98): 1.6 (F08, F48) 02.1998/09.2000 55...</p> <p>340x37x37mm 2p-d12-25mm</p>

	<p>E1092 NO. 0852726 - 13276148 - 852577 - 852726 - 90466668</p> <p>ESTICADOR DE ESCAPE</p> <p>OPEL ASTRA G Hatchback (T98): 1.2 16V (F08, F48) 02.1998/09.2000 48KW 65CV 1199CC - OPEL ASTRA G Hatchback (T98): 1.2 16V (F08, F48) 09.2000/01.2005 55KW 75CV 1199CC - OPEL ASTRA G Hatchback (T98): 1.4 16V (F08, F48) 02.1998/01.2005 66KW 90CV 1389CC - OPEL ASTRA G Hatchback (T98): 1.6 (F08, F48) 02.1998/09.2000 55KW 75CV 1598CC - OPEL ASTRA G Hatchback (T98): 1.6 16V (F08, F48) 02.1998/01.2005 74K...</p> <p>55x40x35mm</p>		<p>E23401-V NO. 0758801 - 758801 - 90250156</p> <p>ESTICADOR MANETE CAIXA DE VELOCIDADES</p> <p>OPEL ASTRA G Hatchback (T98) 1.2 16V (F08 - F48) (De 02-1998 Até 09-2000) 48KW 65CV 1199cc Hatchback OPEL ASTRA G Hatchback (T98) 1.2 16V (F08 - F48) (De 09-2000 Até 01-2005) 55KW 75CV 1199cc Hatchback OPEL ASTRA G Hatchback (T98) 1.4 (F08 - F48) (De 09-2007 Até 12-2009) 66KW 90CV 1364cc Hatchback OPEL ASTRA G Hatchback (T98) 1.4 16V (F08 - F48) (De 02-1998 Até 01-2005) 66KW 90CV 1389cc Hatchba...</p> <p>207x17x18mm 2f-d11mm</p>
	<p>F0520-I NO. 374018 - 90095162</p> <p>FOLE DO SEMI-EIXO INTERNO (F1026)</p> <p>OPEL ASTRA (G) 1.4i 16v - 1.6i - 1.6i 16v - 1.7 Dti 16v - 1.7 TD (1998 A 2004)</p> <p>d72x94mm 1f-d54mm 1f-d19mm</p>		<p>F1650A-I NO. 1604252 - 1604300 - 90510398</p> <p>FOLE DA TRANSMISSÃO JUNTO À CAIXA</p> <p>OPEL ASTRA G 1.8i 16V - 2.0 Di 16V - 2.0 DTi 16V - 2.0i 16V - 2.2i 16V (1998 A 2003)</p> <p>d110x125mm 1f-d108mm 1f-d25mm</p>
	<p>F1848-I NO. 1603014 - 1603183 - 1603238 - 374014 - 374319 - 374429 - 90543336</p> <p>FOLE DA TRANSMISSÃO JUNTO À CAIXA</p> <p>OPEL ASTRA (G) 1.8i - 2.2i (1998 A 2003)</p> <p>d95x100mm 1f-d65mm 1f-d24mm</p>		<p>F4097 NO. 0738394 - 0738415 - 24430525 - 738394 - 738415</p> <p>FOLE ALAVANCA VELOCIDADES</p> <p>OPEL ASTRA G Hatchback (T98): 1.2 16V (F08, F48) 02.1998/09.2000 48KW 65CV 1199CC - OPEL ASTRA G Hatchback (T98): 1.2 16V (F08, F48) 09.2000/01.2005 55KW 75CV 1199CC - OPEL ASTRA G Hatchback (T98): 1.4 (F08, F48) 09.2007/12.2009 66KW 90CV 1364CC - OPEL ASTRA G Hatchback (T98): 1.4 16V (F08, F48) 02.1998/01.2005 66KW 90CV 1389CC - OPEL ASTRA G Hatchback (T98): 1.6 (F08, F48) 02.1998/09.2000 55KW ...</p> <p>160x120x170mm 1f-d50mm 1f-140x95mm</p>
	<p>F4113 NO. 5738392 - 93173990</p> <p>FOLE ALAVANCA VELOCIDADES</p> <p>OPEL ASTRA G Hatchback (T98) 1.2 16V (02.98 A 09.00) 65cv 1199cc Hatchback - OPEL ASTRA G Hatchback (T98) 1.2 16V (09.00 A 01.05) 75cv 1199cc Hatchback - OPEL ASTRA G Hatchback (T98) 1.4 (09.07 A 12.09) 90cv 1364cc Hatchback - OPEL ASTRA G Hatchback (T98) 1.4 16V (02.98 A 01.05) 90cv 1389cc Hatchback - OPEL ASTRA G Hatchback (T98) 1.6 (02.98 A 09.00) 75cv 1598cc Hatchback - OPEL ASTRA G ...</p> <p>180x150x110mm 1f-d45mm 1f-140x100x80mm</p>		<p>F4138 NO. 0578424 - 13122456 - 578424</p> <p>FOLE ALAVANCA TRAVÃO DE MÃO</p> <p>OPEL ASTRA G Hatchback (T98): 1.6 (F08, F48) 11.2002/01.2005 76KW 103CV 1598CC</p> <p>189x58x150mm 1f-d8mm</p>
	<p>F4140 NO. 0578412 - 578412 - 90437203</p> <p>FOLE ALAVANCA TRAVÃO DE MÃO</p> <p>OPEL ASTRA G Hatchback (T98): 1.4 16V (F08, F48) 02.1998/01.2005 66KW 90CV 1389CC - OPEL ASTRA G Hatchback (T98): 1.6 (F08, F48) 09.2000/01.2005 62KW 84CV 1598CC - OPEL ASTRA G Hatchback (T98): 1.6 16V (F08, F48) 02.1998/01.2005 74KW 101CV 1598CC - OPEL ASTRA G três volumes (T98): 1.4 16V (F69) 09.1998/01.2005 66KW 90CV 1389CC - OPEL ASTRA G três volumes (T98): 1.6 (F69) 09.2000/01.2005 62KW 84C...</p> <p>215x69x226mm 1f-d11mm</p>		<p>F4269 NO. 759607 - 9118424</p> <p>FOLE ALAVANCA VELOCIDADES</p> <p>OPEL ASTRA G CLASSIC (T98) 1.4 16V (F08, F48) (De 05.2004 Até 07.2009) 66KW 90cv 1389cm3 Hatchback - OPEL ASTRA G CLASSIC (T98) 1.6 (F08, F48) (De 03.2006 Até 06.2008) 76kW 103cv 1598cm3 Hatchback - OPEL ASTRA G CLASSIC (T98) 1.6 16V (F08, F48) (De 05.2004 Até 02.2006) 74kW 101cv 1598cm3 Hatchback - OPEL ASTRA G CLASSIC (T98) 1.7 CDTi (F08, F48) (De 06.2004 Até 07.2009) 59kW 80cv 1686cm3 Hatchback...</p> <p>180x150x70mm 1f-127x47mm</p>
	<p>KF2271-T NO. 1603259 - 374434</p> <p>KIT DE FOLE DO CARDAN JUNTO À RODA</p> <p>OPEL ASTRA (G) 1.8i 16v (1998 A 2003)</p> <p>d105x125mm 1f-d83mm 1f-d25mm</p>		<p>KF2340 NO. 1603179 - 374050 - 90125491</p> <p>FOLE DO LADO DA RODA</p> <p>OPEL ASTRA (G) 1.8i 16v - 2.0 Di 16v - 2.0 Dti 16v (1998 A 2003)</p> <p>d103x78mm 1f-d22mm 1f-d82mm</p>
	<p>KF3480 NO. 09198502 - 09200338 - 1603011 - 1603220 - 1603221</p> <p>KIT DE FOLE DO CARDAN JUNTO À RODA</p> <p>OPEL ASTRA G HATCHBACK 2.0 OPC 192CV (09-2002 A 01-2005) - 2.0 OPC 200CV (11-2002 A 01-2005) - 2.2 DTi 125CV (09-2002 A 01-2005) - ASTRA G TRÊS VOLUMES 2.2 DTi 125CV (09-2002 A 01-2005) - COMBI 2.0 OPC 192CV (09-2002 A 07-2004) - COMBI 2.0 OPC 200CV (11-2</p> <p>d93x98mm 1f-d26mm 1f-d83mm</p>		<p>KL80449 NO. 198283 - 607813 - 90412865</p> <p>KIT CASQUILHOS COBERTURA TAMPA MOTOR</p> <p>OPEL ASTRA G Hatchback (T98): 1.4 16V (F08, F48) 02.1998/01.2005 66KW 90CV 1389CC - OPEL ASTRA G Hatchback (T98): 1.6 16V (F08, F48) 02.1998/01.2005 74KW 101CV 1598CC - OPEL ASTRA G Hatchback (T98): 1.8 16V (F08, F48) 02.1998/09.2000 85KW 116CC 1796CC - OPEL ASTRA G Hatchback (T98): 2.0 DI (F08, F48) 02.1998/01.2005 60KW 82CV 1995CC - OPEL ASTRA G Hatchback (T98): 2.0 DTi 16V (F08, F48) 08.1999 - ...</p> <p>d16x10mm 1f-d6mm</p>
	<p>M6082 NO. 854943 - 854944 - 854955 - 97069287</p> <p>JUNTA DE ESCAPE</p> <p>OPEL ASTRA (G)</p> <p>d64x5mm 1f-d53mm</p>		<p>R080253 NO. 06336007 - 090448853 - 090536339 - 09128719 - 1336145 - 6336007 - 90448853 - 90536339 - 9128719</p> <p>TUBO LÍQUIDO REFRIGERAÇÃO</p> <p>OPEL ASTRA G Cabriolet (T98) 1.6 (F67) 01.2003/10.2005 76KW 103CV 1598CC Z 16 XEP 0035472 - OPEL ASTRA G Cabriolet (T98) 1.6 16V (F67) 03.2001/10.2005 74KW 101CV 1598CC Z 16 XE 0035423 - OPEL ASTRA G Caixa/Combi (F70) 1.4 (F70) 09.1998/04.2005 66KW 90CV 1389CC Z 14 XE X 14 XE - OPEL ASTRA G Caixa/Combi (F70) 1.6 (F70) 09.1998/01.2004 74KW 101CV 1598CC Z 16 XE C 16 SEL - OPEL ASTRA G Caixa/Combi (F...</p> <p>B340-30/35mm ch-d13-29mm ch-d13-30mm</p>





	<p>R080256 NO. 95-285mm 3f-d6mm 1f-d13mm 1p-d8x30</p> <p>TUBO RIGIDO REFRIGERAÇÃO</p> <p>OPEL ASTRA G Hatchback (T98) 1.4 (F08 - F48) (De 09-2007 Até 12-2009) 66kW 90CV 1364cc Hatchback OPEL ASTRA G Hatchback (T98) 1.4 16V (F08 - F48) (De 02-1998 Até 01-2005) 66kW 90CV 1389cc Hatchback OPEL ASTRA G Hatchback (T98) 1.6 (F08 - F48) (De 02-1998 Até 09-2000) 55kW 75CV 1598cc Hatchback OPEL ASTRA G Hatchback (T98) 1.6 (F08 - F48) (De 09-2000 Até 01-2005) 62kW 84CV 1598cc Hatchback OPEL...</p> <p>B340-34/33mm 95-285mm 3f-d6mm 1f-d13mm 1p-d8x30</p>		<p>R221743 NO. 055351522 - 05656121 - 0656092 - 55578995 - 5656121 - 656092</p> <p>TUBO RESPIRO DO CARTER CAMBOTA</p> <p>OPEL ASTRA G CLASSIC Caravan (F35) 1.4 (F35) (10.2007 - 07.2009) 66kw 90cv 1364cm3 Combi OPEL ASTRA G Hatchback (T98) 1.4 (F08, F48) (09.2007 - 12.2009) 66kw 90cv 1364cm3 Hatchback OPEL ASTRA G três volumes (T98) 1.4 (F69) (09.2007 - 12.2009) 66kw 90cv 1364cm3 três volumes OPEL ASTRA H (A04) 1.2 (L48) (08.2005 - 10.2010) 59kw 80cv 1229cm3 Hatchback</p> <p>boca a boca175mmd1-15mmx20mm75-73</p>
	<p>R222701 NO. 1337552 - 9202877</p> <p>TUBO INFERIOR RADIADOR</p> <p>OPEL ASTRA G Hatchback (T98) 1.2 16V (F08 - F48) (De 02-1998 Até 09-2000) 48kW 65CV 1199cc Hatchback OPEL ASTRA G Hatchback (T98) 1.2 16V (F08 - F48) (De 09-2000 Até 01-2005) 55kW 75CV 1199cc Hatchback OPEL ASTRA G três volumes (T98) 1.2 16V (F69) (De 09-1998 Até 09-2000) 48kW 65CV 1199cc três volumes OPEL ASTRA G três volumes (T98) 1.2 16V (F69) (De 09-2000 Até 01-2005) 55kW 75CV 1199cc três v...</p> <p>B310-30/40mm 60-160-90-80mm ch-d18-1005mm</p>		<p>R222703 NO. 1337582 - 24413975</p> <p>TUBO SUPERIOR DO RADIADOR</p> <p>OPEL ASTRA G Cabriolet (T98) 1.6 (F67) 01.2003/10.2005 76KW 103CV 1598CC Z 16 XEP 0035472 - OPEL ASTRA G Cabriolet (T98) 1.6 16V (F67) 03.2001/10.2005 74KW 101CV 1598CC Z 16 XE 0035423 - OPEL ASTRA G Caixa/Combi (F70) 1.6 (F70) 01.1999/09.2000 55KW 75CV 1598CC X 16 SZR 0039131 - OPEL ASTRA G Caixa/Combi (F70) 1.6 (F70) 09.2000/04.2005 62KW 84CV 1598CC Z 16 SE - OPEL ASTRA G Combi (T98) 1.4 16V (F3...</p> <p>B190-d34/34mm 55-70-90-80-50-60mm</p>
	<p>R222704 NO. 1337556 - 9202896</p> <p>TUBO INFERIOR DO RADIADOR</p> <p>OPEL ASTRA G Cabriolet (T98) 1.6 (F67) 01.2003/10.2005 76KW 103CV 1598CC Z 16 XEP 0035472 - OPEL ASTRA G Cabriolet (T98) 1.6 16V (F67) 03.2001/10.2005 74KW 101CV 1598CC Z 16 XE 0035423 - OPEL ASTRA G Caixa/Combi (F70) 1.6 (F70) 01.1999/09.2000 55KW 75CV 1598CC X 16 SZR 0039131 - OPEL ASTRA G Caixa/Combi (F70) 1.6 (F70) 09.2000/04.2005 62KW 84CV 1598CC Z 16 SE - OPEL ASTRA G Combi (T98) 1.4 16V (F3...</p> <p>B455-d38/33mm 255-60-100-70-70mm</p>		<p>R222707 NO. 1337521 - 9129152</p> <p>TUBO DE LIGAÇÃO TERMOSTATO Á BOMBA DE ÁGUA</p> <p>OPEL ASTRA G Hatchback (T98) 1.4 16V (F08, F48) (De 1998.02 Até 2005.01) 66kW 90cv 1389cm3 Hatchback - OPEL ASTRA G Hatchback (T98) 1.6 (F08, F48) (De 1998.02 Até 2000.09) 55kW 75cv 1598cm3 Hatchback - OPEL ASTRA G Hatchback (T98) 1.6 (F08, F48) (De 2000.09 Até 2005.01) 62kW 84cv 1598cm3 Hatchback - OPEL ASTRA G Hatchback (T98) 1.6 16V (F08, F48) (De 1998.02 Até 2005.01) 74kW 101c...</p> <p>B156-28/36mm 61x75x37mm ch-d26x50x42mm</p>
	<p>R222715 NO. 1377542</p> <p>TUBO SUPERIOR DO RADIADOR</p> <p>OPEL ASTRA G Caixa/Combi (F70) 1.7 TD (F70) 01.1999/04.2005 50KW 68CV 1699CC X 17 DTL 0039132 - OPEL ASTRA G Combi (T98) 1.7 TD (F35) 02.1998/08.2000 50KW 68CV 1699CC X 17 DTL 0035354 - OPEL ASTRA G Hatchback (T98) 1.7 TD (F08, F48) 02.1998/08.2000 50KW 68CV 1699CC X 17 DTL 0035346 - OPEL ASTRA G três volumes (T98) 1.7 TD (F69) 09.1998/08.2000 50KW 68CV 1699CC X 17 DTL 0035364</p> <p>B320-d34/34mm 80-110-150-120mm</p>		<p>R222716 NO. 1337543 - 9128909</p> <p>TUBO INFERIOR DO RADIADOR</p> <p>OPEL ASTRA G Caixa/Combi (F70) 1.7 DTI 16V (F70) 02.2000/04.2005 55KW 75CV 1686CC Y 17 DT - OPEL ASTRA G Combi (T98) 1.7 DTI 16V (F35) 02.2000/07.2004 55KW 75CV 1686CC Y 17 DT 0035376 - OPEL ASTRA G Hatchback (T98) 1.7 DTI 16V (F08, F48) 02.2000/01.2005 55KW 75CV 1686CC Y 17 DT 0035378 - OPEL ASTRA G três volumes (T98) 1.7 DTI 16V (F69) 02.2000/01.2005 55KW 75CV 1686CC Y 17 DT 0035380</p> <p>B300-d32/32mm 130-190-100-50mm+ch1125-d20mm</p>
	<p>R222717 NO. 1818511 - 24412304</p> <p>TUBO PERMUTADOR DO AQUECIMENTO</p> <p>OPEL ASTRA G Hatchback (T98) 1.7 DTI 16V (F08, F48) (De 2000.02 Até 2005.01) 55kW 75cv 1686cm3 Hatchback - OPEL ASTRA G Hatchback (T98) 1.7 CDTI (F08, F48) (De 2003.04 Até 2009.12) 59kW 80cv 1686cm3 Hatchback - OPEL ASTRA G três volumes (T98) 1.7 DTI 16V (F69) (De 2000.02 Até 2005.01) 55kW 75cv 1686cm3 três volumes - OPEL ASTRA G três volumes (T98) 1.7 CDTI (F69) (De 2003.04 Até ...</p> <p>B285-17/20mm 49x37x32x52x45x61mm</p>		<p>R222719 NO. 1336294 - 1337395 - 90128078 - 90166058 - 90570030</p> <p>TUBO DE LIGAÇÃO TERMOSTATO Á BOMBA DE ÁGUA</p> <p>OPEL ASTRA G Hatchback (T98): 1.7 TD (F08, F48) 02.1998/08.2000 50KW 68CC 1699CC - OPEL ASTRA G três volumes (T98): 1.7 TD (F69) 09.1998/08.2000 50KW 68CV 1699CC - OPEL ASTRA G Combi (T98): 1.7 TD (F35) 02.1998/08.2000 50KW 68CV 1699CC - OPEL ASTRA G Caixa/Combi (F70): 1.7 TD (F70) 01.1999/04.2005 50KW 68CV 1699CC - OPEL ASTRA G Hatchback (T98): 1.7 DTI 16V (F08, F48) 02.2000/01.2005 55KW 75CV 1686CC...</p> <p>boca a boca 137 mm d1 31mmd2 32mm</p>
	<p>R222720 NO. 1337484 - 1337586 - 90573847</p> <p>TUBO SUPERIOR DO RADIADOR</p> <p>OPEL ASTRA G Combi (T98) 1.7 DTI 16V (F35) 02.2000/07.2004 55KW 75CV 1686CC Y 17 DT 0035376 - OPEL ASTRA G Combi (T98) 1.7 TD (F35) 02.1998/08.2000 50KW 68CV 1699CC X 17 DTL 0035354 - OPEL ASTRA G Hatchback (T98) 1.7 DTI 16V (F08, F48) 02.2000/01.2005 55KW 75CV 1686CC Y 17 DT 0035378 - OPEL ASTRA G Hatchback (T98) 1.7 TD (F08, F48) 02.1998/08.2000 50KW 68CV 1699CC X 17 DTL 0035346 - OPEL ASTRA G t...</p> <p>B255-d36/34mm 90-130-150-70-95mm</p>		<p>R222721 NO. 1337466 - 90530679</p> <p>TUBO INFERIOR DO RADIADOR</p> <p>OPEL ASTRA G Combi (T98) 1.7 DTI 16V (F35) 02.2000/07.2004 55KW 75CV 1686CC Y 17 DT 0035376 - OPEL ASTRA G Combi (T98) 1.7 TD (F35) 02.1998/08.2000 50KW 68CV 1699CC X 17 DTL 0035354 - OPEL ASTRA G Hatchback (T98) 1.7 DTI 16V (F08, F48) 02.2000/01.2005 55KW 75CV 1686CC Y 17 DT 0035378 - OPEL ASTRA G Hatchback (T98) 1.7 TD (F08, F48) 02.1998/08.2000 50KW 68CV 1699CC X 17 DTL 0035346 - OPEL ASTRA G t...</p> <p>B465-d34/38mm 70-80-150-40-110-140-90mm</p>
	<p>R222723 NO. 1337565 - 24421116</p> <p>TUBO SUPERIOR DO RADIADOR</p> <p>OPEL ASTRA G Combi (T98) 2.0 DI (F35) 02.1998/07.2004 60KW 82CV 1995CC Y 20 DTLX 20 DTL 0035356 - OPEL ASTRA G Combi (T98) 2.0 DTI 16V (F35) 08.1999/07.2004 74KW 101CV 1995CC Y 20 DTH 0035377 - OPEL ASTRA G Hatchback (T98) 2.0 DI (F08, F48) 02.1998/01.2005 60KW 82CV 1995CC X 20 DTLY 20 DTL 0035348 - OPEL ASTRA G Hatchback (T98) 2.0 DTI 16V (F08, F48) 08.1999/01.2005 74KW 101CV 1995CC Y 20 DTH 0035...</p> <p>B170-d34/34mm 70-60-100-60-85mm</p>		<p>R222724 NO. 1337502 - 90573220 - 91156066</p> <p>TUBO INFERIOR DO RADIADOR</p> <p>OPEL ASTRA G Combi (T98) 2.0 DI (F35) 02.1998/07.2004 60KW 82CV 1995CC Y 20 DTLX 20 DTL 0035356 - OPEL ASTRA G Combi (T98) 2.0 DTI 16V (F35) 08.1999/07.2004 74KW 101CV 1995CC Y 20 DTH 0035377 - OPEL ASTRA G Hatchback (T98) 2.0 DI (F08, F48) 02.1998/01.2005 60KW 82CV 1995CC X 20 DTLY 20 DTL 0035348 - OPEL ASTRA G Hatchback (T98) 2.0 DTI 16V (F08, F48) 08.1999/01.2005 74KW 101CV 1995CC Y 20 DTH 0035...</p> <p>B220-d33/33mm 60-100-35-60-60mm</p>
	<p>R222731 NO. 1337588</p> <p>TUBO INFERIOR DO RADIADOR</p> <p>OPEL ASTRA G Cabriolet (T98) 2.0 OPC (F67) (De 03.2002 Até 10.2005) 141kW 192cv 1998cm3 Cabriolet - OPEL ASTRA G Combi (T98) 2.0 16V (F35) (De 02.1998 Até 07.2004) 100kW 136cv 1998cm3 Combi - OPEL ASTRA G Combi (T98) 2.0 OPC (F35) (De 09.2002 Até 07.2004) 141kW 192cv 1998cm3 Combi - OPEL ASTRA G Combi (T98) 2.0 OPC (F35) (De 11.2002 Até 07.2004) 147kW 200cv 1998cm3 Combi - OPEL ASTRA G Hatchback (...</p> <p>B440-33/41m 58x56x85x54x105x40x58mm</p>		<p>R222779 NO. 1337519 - 1337583 - 24413976 - 9129413</p> <p>TUBO SUPERIOR DO RADIADOR LADO DA ADMISSÃO</p> <p>OPEL ASTRA G Cabriolet (T98) 1.6 (F67) (De 01.2003 Até 10.2005) 76kW 103cv 1598cm3 Cabriolet - OPEL ASTRA G Cabriolet (T98) 1.6 16V (F67) (De 03.2001 Até 10.2005) 74kW 101cv 1598cm3 Cabriolet - OPEL ASTRA G Caixa/Combi (F70) 1.6 (F70) (De 01.1999 Até 09.2000) 55kW 75cv 1598cm3 Caixa/Combi - OPEL ASTRA G Caixa/Combi (F70) 1.6 (F70) (De 09.2000 Até 04.2005) 62kW 84cv 1598cm3 Caixa/Combi - OPEL ASTRA...</p> <p>B140-32/33mm 103x97x87x28x44mm</p>

	<p>R222799 NO. 0836770 - 836770 - 90351553</p> <p>TUBO ADMISSÃO FILTRO DE AR</p> <p>OPEL ASTRA G Hatchback (T98): 1.6 (F08, F48) 02.1998/09.2000 55KW 75CV 1598CC - OPEL ASTRA G três volumes (T98): 1.6 (F69) 09.1998/09.2000 55KW 75CV 1598CC - OPEL ASTRA G Combi (T98): 1.6 (F35) 02.1998/09.2000 55KW 75CV 1598CC - OPEL ASTRA G Caixa/Combi (F70): 1.6 (F70) 01.1999/09.2000 55KW 75CV 1598CC</p> <p>boca a boca 204 mm d1 59mmd2 61mm</p>		<p>R222827 NO. 6336084 - 97300149</p> <p>TUBO LIGAÇÃO TERMOSTATO</p> <p>OPEL ASTRA G Hatchback (T98) 1.7 CDTI (F08 - F48) (De 04-2003 Até 12-2009) 59KW 80CV 1686cc Hatchback OPEL ASTRA G três volumes (T98) 1.7 CDTI (F69) (De 04-2003 Até 12-2009) 59KW 80CV 1686cc três volumes OPEL ASTRA G Combi (T98) 1.7 CDTI (F35) (De 04-2003 Até 07-2009) 59KW 80CV 1686cc Combi</p> <p>B115-15/15mm 39-45-39mm</p>
	<p>R222828 NO. 97351101</p> <p>TUBO DO RADIADOR</p> <p>OPEL ASTRA G Hatchback (T98) 1.7 DTI 16V (F08 - F48) (De 02-2000 Até 01-2005) 55kW 75CV 1686cc Hatchback OPEL ASTRA G Hatchback (T98) 1.7 CDTI (F08 - F48) (De 04-2003 Até 12-2009) 59kW 80CV 1686cc Hatchback OPEL ASTRA G três volumes (T98) 1.7 DTI 16V (F69) (De 02-2000 Até 01-2005) 55kW 75CV 1686cc três volumes OPEL ASTRA G três volumes (T98) 1.7 CDTI (F69) (De 04-2003 Até 12-2009) 59kW 80CV 1686cc</p> <p>B165-13/13mm 34-41-47-51mm</p>		<p>R225245 NO. 1337517 - 9157129</p> <p>TUBO CHAUFAGEM CONEXÃO PARA O MOTOR</p> <p>OPEL ASTRA G Caixa/Combi (F70) 2.0 DI (F70) (De 01.1999 Até 04.2005) 60kW 82cv 1995cm3 Caixa/Combi - OPEL ASTRA G Combi (T98) 2.0 DI (F35) (De 02.1998 Até 07.2004) 60kW 82cv 1995cm3 Combi - OPEL ASTRA G Combi (T98) 2.0 DTI 16V (F35) (De 08.1999 Até 07.2004) 74kW 101cv 1995cm3 Combi - OPEL ASTRA G Hatchback (T98) 2.0 DI (F08, F48) (De 02.1998 Até 01.2005) 60kW 82cv 1995cm3 Hatchback - OPEL ASTRA G...</p> <p>B225-d13/d18mm mm</p>
	<p>R225254 NO. 1337233 - 97086694</p> <p>TUBO LIGAÇÃO TERMOSTATO</p> <p>OPEL ASTRA G Hatchback (T98) 1.7 DTI 16V (F08 - F48) (De 02-2000 Até 01-2005) 55kW 75CV 1686cc Hatchback OPEL ASTRA G Hatchback (T98) 1.7 TD (F08 - F48) (De 02-1998 Até 08-2000) 50kW 68CV 1700cc Hatchback</p> <p>B78-15-15mm 48-47mm</p>		<p>R225642 NO. 13026005 - 24451329 - 55559701 - 5860500</p> <p>TUBO DO AR SOBREALIMENTAÇÃO</p> <p>OPEL ASTRA G Combi (T98) 2.0 DTI 16V (F35) 08.1999/07.2004 74KW 101CV 1995CC Y 20 DTH 0035377</p> <p>B238-41/50mm 65-70-29-61mm</p>
	<p>R225642 NO. 13026005 - 24451329 - 55559701 - 5860500</p> <p>TUBO DO AR SOBREALIMENTAÇÃO</p> <p>OPEL ASTRA G Hatchback (T98) 2.0 DTI 16V (F08, F48) 08.1999/01.2005 74KW 101CV 1995CC Y 20 DTH 0035379</p> <p>B238-41/50mm 65-70-29-61mm</p>		<p>RT08545 NO. 562345 - 562350 - 562358 - 90235568 - 90374106 - 90468316 - 90468319</p> <p>TUBO DE TRAVÃO FRENTE LH-RH</p> <p>OPEL ASTRA G Caixa/Combi (F70): 1.6 (F70) 01.1999/09.2000 55KW 75CV 1598CC</p> <p>310mm FB3/1 - OR1</p>
	<p>RT08934 NO. 562377 - 90498319</p> <p>TUBO DE TRAVÃO FRENTE LH-RH</p> <p>OPEL ASTRA G TT (APÓS 02-1998)</p> <p>396mm F8 - OR30</p>		<p>RT08935 NO. 5662078 - 90498330</p> <p>TUBO DE TRAVÃO TRÁS LH-RH</p> <p>OPEL ASTRA G TT1.2 16V - 1.4 16V - 1.6 16V - 1.7 TD - 1.7 TDI (APÓS 02-1998)</p> <p>207mm F8 - F8</p>
	<p>S1333 NO. 3523.65 - 90498740</p> <p>SILENT-BLOC DO BRAÇO SUSPENSÃO FRENTE(PARTE DE TRÁS)</p> <p>OPEL ASTRA G Hatchback (T98): 1.2 16V (F08, F48) 02.1998/09.2000 48KW 65CV 1199CC - OPEL ASTRA G Hatchback (T98): 1.2 16V (F08, F48) 09.2000/01.2005 55KW 75CV 1199CC - OPEL ASTRA G Hatchback (T98): 1.4 16V (F08, F48) 02.1998/01.2005 66KW 90CV 1389CC - OPEL ASTRA G Hatchback (T98): 1.6 (F08, F48) 02.1998/09.2000 55KW 75CV 1598CC - OPEL ASTRA G Hatchback (T98): 1.6 (F08, F48) 09.2000/01.2005 62KW 84...</p> <p>d60x60mm d47mm 1f-d12mm</p>		<p>S1473 NO. 0352364 - 352364 - 90498738</p> <p>SILENT BLOC DO BRAÇO SA SUSPENSÃO DA FRENTE</p> <p>OPEL ASTRA G 1.2 16V - 1.4 16V - 1.6 - 1.6 16V - 1.7TD - 1.7TDI 16V - 1.7CDTI - 1.8 16V - 2.0 OPC - 2.0 OPC 16V - 2.0Di - 2.0 16V - 2.0DTI 16V - 2.0 16V - 2.2DTI (1998 A 2005)</p> <p>d44x60mm d35mm 1f-d12mm</p>
	<p>S1714 NO. 0302275 - 0302290 - 09223022 - 302275 - 302290 - 90498689 - 9223022</p> <p>SILENT-BLOC DA SUSPENSÃO SUB-CHASSI DA FRENTE</p> <p>OPEL ASTRA G Hatchback (T98) 1.2 16V (F08, F48) (De 1998.02 Até 2000.09) 48kW 65cv 1199cm3 Hatchback - OPEL ASTRA G Hatchback (T98) 1.2 16V (F08, F48) (De 2000.09 Até 2005.01) 55kW 75cv 1199cm3 Hatchback - OPEL ASTRA G Hatchback (T98) 1.4 (F08, F48) (De 2007.09 Até 2009.12) 66kW 90cv 1364cm3 Hatchback - OPEL ASTRA G Hatchback (T98) 1.4 16V (F08, F48) (De 1998.02 Até 2005.01) 66...</p> <p>d45x35mm c29mm 1f-d14mm</p>		<p>S1715 NO. 0302067 - 13107328 - 302067</p> <p>SILENT-BLOC DA SUSPENSÃO SUB-CHASSI FRENTE</p> <p>OPEL ASTRA G Hatchback (T98) 1.2 16V (F08, F48) (De 1998.02 Até 2000.09) 48kW 65cv 1199cm3 Hatchback - OPEL ASTRA G Hatchback (T98) 1.2 16V (F08, F48) (De 2000.09 Até 2005.01) 55kW 75cv 1199cm3 Hatchback - OPEL ASTRA G Hatchback (T98) 1.4 (F08, F48) (De 2007.09 Até 2009.12) 66kW 90cv 1364cm3 Hatchback - OPEL ASTRA G Hatchback (T98) 1.4 16V (F08, F48) (De 1998.02 Até 2005.01) ...</p> <p>d46x 35mm c-25mm dc-38mm1f-d14mm</p>
	<p>S1978 NO. 0352324</p> <p>SILENT-BLOC DO BRAÇO SUSPENSÃO FRENTE PARTE DE TRÁS</p> <p>OPEL ASTRA G CLAA1:E47SSIC (T98) 1.4 16V (F08, F48) (De 05.2004 Até 07.2009) 66kW 90cv 1389cm3 Hatchback - OPEL ASTRA G CLASSIC (T98) 1.6 (F08, F48) (De 03.2006 Até 06.2008) 76kW 103cv 1598cm3 Hatchback - OPEL ASTRA G CLASSIC (T98) 1.6 16V (F08, F48) (De 05.2004 Até 02.2006) 74kW 101cv 1598cm3 Hatchback - OPEL ASTRA G CLASSIC (T98) 1.7 CDTI (F08, F48) (De 06.2004 Até 07.2009) 59kW 80cv 1686cm3 Hat...</p> <p>d60x 59mm c-45mm dc-46mm1f-d12mm</p>		<p>T0645-I NO. 0344417 - 0344417 - 344417 - 90468644</p> <p>BATENTE SUSPENSÃO DA FRENTE</p> <p>OPEL ASTRA G Hatchback (F48_ - F08_) 1.2 16V (02.98 A 09.00) 65cv 1199cc Hatchback - OPEL ASTRA G Hatchback (F48_ - F08_) 1.2 16V (09.00 A 01.05) 75cv 1199cc Hatchback OPEL ASTRA G Hatchback (F48_ - F08_) 1.4 16V (02.98 A 01.05) 90cv 1389cc Hatchback - OPEL ASTRA G Hatchback (F48_ - F08_) 1.6 (02.98 A 09.00) 75cv 1598cc Hatchback - OPEL ASTRA G Hatchback (F48_ - F08_) 1.6 (09.00 A 01.05) 84cv...</p> <p>d50x64mm 1f-d18mm 1f-d23mm</p>

	<p>T0739-I NO. 13173321 - 22697919 - 24411014 - 90095608 - 90216605 - 90216613 - 90250393</p> <p>BATENTE APOIO DE SUSPENSÃO TRÁS (GASTA 2 UNIDADES)</p> <p>OPEL ASTRA G CLASSIC Caravan (F35) 1.4 (F35) (De 10.2007 Até 07.2009) 66kW 90cv 1364cm3 Combi - OPEL ASTRA G Cabriolet (T98) 1.6 (F67) (De 01.2003 Até 10.2005) 76kW 103cv 1598cm3 Cabriolet - OPEL ASTRA G Cabriolet (T98) 1.6 16V (F67) (De 03.2001 Até 10.2005) 74kW 101cv 1598cm3 Cabriolet - OPEL ASTRA G Cabriolet (T98) 1.8 16V (F67) (De 03.2001 Até 10.2005) 92kW 125cv 1796cm3 Cabriolet - OPEL ASTRA ...</p> <p>d126x49mm 1f-d15mm</p>		<p>T1076 NO. 0350087 - 0350093 - 350087 - 350093 - 9223176</p> <p>BATENTE DA BARRA ESTABILIZADORA FRENTE</p> <p>OPEL ASTRA G Hatchback (T98): 1.2 16V (F08, F48) 02.1998/09.2000 48KW 65CV 1199CC - OPEL ASTRA G Hatchback (T98): 1.2 16V (F08, F48) 09.2000/01.2005 55KW 75CV 1199CC - OPEL ASTRA G Hatchback (T98): 1.4 (F08, F48) 09.2007/12.2009 66KW 90CV 1364CC - OPEL ASTRA G Cabriolet (T98): 1.4 16V (F08, F48) 02.1998/01.2005 66KW 90CV 1389CC - OPEL ASTRA G Hatchback (T98): 1.6 (F08, F48) 02.1998/09.2000 55KW 75...</p> <p>40x41x36mm 1f-d20mm</p>
	<p>U0314 NO. 0424761</p> <p>ANILHA DA SUSPENSÃO DAS MOLAS DE TRÁS INFERIOR</p> <p>OPEL ASTRA G CLASSIC (T98) 1.4 16V (F08, F48) (05.2004 - 07.2009) 66kW 90cv 1389cm3 Hatchback OPEL ASTRA G CLASSIC (T98) 1.6 (F08, F48) (03.2006 - 06.2008) 76kW 103cv 1598cm3 Hatchback OPEL ASTRA G CLASSIC (T98) 1.6 16V (F08, F48) (05.2004 - 02.2006) 74kW 101cv 1598cm3 Hatchback OPEL ASTRA G CLASSIC (T98) 1.7 CDTI (F08, F48) (06.2004 - 07.2009) 59kW 80cv 1686cm3 Hatchback OPEL ASTRA G CLASSIC três...</p> <p>d132x22mm 1f-d33mm</p>		<p>U0314 NO. 0424761</p> <p>ANILHA DA SUSPENSÃO DAS MOLAS DE TRÁS INFERIOR</p> <p>OPEL ASTRA G Cabriolet (T98) 1.6 (F67) (01.2003 - 10.2005) 76kW 103cv 1598cm3 Cabriolet OPEL ASTRA G Cabriolet (T98) 1.6 16V (F67) (03.2001 - 10.2005) 74kW 101cv 1598cm3 Cabriolet OPEL ASTRA G Cabriolet (T98) 1.8 16V (F67) (03.2001 - 10.2005) 92kW 125cv 1796cm3 Cabriolet OPEL ASTRA G Cabriolet (T98) 2.0 16V Turbo (F67) (11.2002 - 10.2005) 147kW 200cv 1998cm3 Cabriolet OPEL ASTRA G Cabriolet (T98) ...</p> <p>d132x22mm 1f-d33mm</p>
	<p>U0314 NO. 0424761</p> <p>ANILHA DA SUSPENSÃO DAS MOLAS DE TRÁS INFERIOR</p> <p>OPEL ASTRA G Caixa/Combi (F70) 1.4 (F70) (09.1998 - 04.2005) 66kW 90cv 1389cm3 Caixa/Combi OPEL ASTRA G Caixa/Combi (F70) 1.6 (F70) (01.1999 - 09.2000) 55kW 75cv 1598cm3 Caixa/Combi OPEL ASTRA G Caixa/Combi (F70) 1.6 (F70) (09.2000 - 04.2005) 62kW 84cv 1598cm3 Caixa/Combi OPEL ASTRA G Caixa/Combi (F70) 1.6 (F70) (09.1998 - 01.2004) 74kW 101cv 1598cm3 Caixa/Combi OPEL ASTRA G Caixa/Combi (F70) 1.6 ...</p> <p>d132x22mm 1f-d33mm</p>		<p>U0314 NO. 0424761</p> <p>ANILHA DA SUSPENSÃO DAS MOLAS DE TRÁS INFERIOR</p> <p>OPEL ASTRA G Coupé (T98) 1.6 16V (F07) (03.2000 - 05.2005) 74kW 101cv 1598cm3 Coupé OPEL ASTRA G Coupé (T98) 1.6 16V (F07) (03.2000 - 05.2005) 76kW 103cv 1598cm3 Coupé OPEL ASTRA G Coupé (T98) 1.8 16V (F07) (03.2000 - 10.2000) 85kW 116cv 1796cm3 Coupé OPEL ASTRA G Coupé (T98) 1.8 16V (F07) (09.2000 - 05.2005) 92kW 125cv 1796cm3 Coupé OPEL ASTRA G Coupé (T98) 2.0 16V Turbo (F07) (09.2000 - 08.2001)...</p> <p>d132x22mm 1f-d33mm</p>
	<p>U0314 NO. 0424761</p> <p>ANILHA DA SUSPENSÃO DAS MOLAS DE TRÁS INFERIOR</p> <p>OPEL ASTRA G Hatchback (T98) 1.2 16V (F08, F48) (02.1998 - 09.2000) 48kW 65cv 1199cm3 Hatchback OPEL ASTRA G Hatchback (T98) 1.2 16V (F08, F48) (09.2000 - 01.2005) 55kW 75cv 1199cm3 Hatchback OPEL ASTRA G Hatchback (T98) 1.4 (F08, F48) (09.2007 - 12.2009) 66kW 90cv 1364cm3 Hatchback OPEL ASTRA G Hatchback (T98) 1.4 16V (F08, F48) (02.1998 - 01.2005) 66kW 90cv 1389cm3 Hatchback OPEL ASTRA G Hatchba...</p> <p>d132x22mm 1f-d33mm</p>		<p>U0314 NO. 0424761</p> <p>ANILHA DA SUSPENSÃO DAS MOLAS DE TRÁS INFERIOR</p> <p>OPEL ASTRA G três volumes (T98) 1.2 16V (F69) (09.1998 - 09.2000) 48kW 65cv 1199cm3 três volumes OPEL ASTRA G três volumes (T98) 1.2 16V (F69) (09.2000 - 01.2005) 55kW 75cv 1199cm3 três volumes OPEL ASTRA G três volumes (T98) 1.4 (F69) (09.2007 - 12.2009) 66kW 90cv 1364cm3 três volumes OPEL ASTRA G três volumes (T98) 1.4 16V (F69) (09.1998 - 01.2005) 66kW 90cv 1389cm3 três volumes OPEL ASTRA G três...</p> <p>d132x22mm 1f-d33mm</p>
	<p>UAP81292 NO. 0821038 - 0821074 - 0821437 - 0821675 - 4708869 - 4809347 - 821038 - 821074 - 821437 - 821675</p> <p>ANILHA PROTEÇÃO TÉRMICA INJECTORES</p> <p>OPEL ASTRA G Hatchback (T98) 2.0 DI (F08 - F48) (De 02-1998 Até 01-2005) 60kW 82CV 1995cc Hatchback OPEL ASTRA G Hatchback (T98) 2.0 DTI 16V (F08 - F48) (De 08-1999 Até 01-2005) 74kW 101CV 1995cc Hatchback OPEL ASTRA G Hatchback (T98) 2.2 DTI (F08 - F48) (De 09-2002 Até 01-2005) 92kW 125CV 2172cc Hatchback OPEL ASTRA G três volumes (T98) 2.0 DI (F69) (De 09-1998 Até 01-2005) 60kW 82CV 1995cc tr...</p> <p>d16x1mm 1f-d7mm</p>		<p>UAP81292 NO. 0821038 - 0821074 - 0821437 - 0821675 - 4708869 - 4809347 - 821038 - 821074 - 821437 - 821675</p> <p>ANILHA PROTEÇÃO TÉRMICA INJECTORES</p> <p>OPEL ASTRA G Hatchback (T98) 2.0 DI (F08 - F48) (De 02-1998 Até 01-2005) 60kW 82CV 1995cc Hatchback OPEL ASTRA G Hatchback (T98) 2.0 DTI 16V (F08 - F48) (De 08-1999 Até 01-2005) 74kW 101CV 1995cc Hatchback OPEL ASTRA G Hatchback (T98) 2.2 DTI (F08 - F48) (De 09-2002 Até 01-2005) 92kW 125CV 2172cc Hatchback OPEL ASTRA G três volumes (T98) 2.0 DI (F69) (De 09-1998 Até 01-2005) 60kW 82CV 1995cc tr...</p> <p>d16x1mm 1f-d7mm</p>
	<p>UCRZ1057 NO. 0905122</p> <p>CRUZETA VEIO DIREÇÃO D15X38MM</p> <p>OPEL ASTRA G CLASSIC (T98) 1.4 16V (F08, F48) (De 05.2004 Até 07.2009) 66kW 90cv 1389cm3 Hatchback - OPEL ASTRA G CLASSIC (T98) 1.4 16V (F08, F48) (De 05.2004 Até 07.2009) 66kW 90cv 1389cm3 Hatchback - OPEL ASTRA G CLASSIC (T98) 1.4 16V (F08, F48) (De 05.2004 Até 07.2009) 66kW 90cv 1389cm3 Hatchback - OPEL ASTRA G CLASSIC (T98) 1.4 16V (F08, F48) (De 05.2004 Até 07.2009) 66kW 90cv 1389cm3 Hatchback...</p> <p>d15x28x41mm</p>		<p>UMB84011 NO. 031126</p> <p>TAMPÃO BLOCO MOTOR</p> <p>OPEL ASTRA G Hatchback (T98) 1.4 16V (F08 - F48) (De 02-1998 Até 01-2005) 66kW 90CV 1389cc Hatchback OPEL ASTRA G Hatchback (T98) 1.6 (F08 - F48) (De 02-1998 Até 09-2000) 55kW 75CV 1598cc Hatchback OPEL ASTRA G Hatchback (T98) 1.6 16V (F08 - F48) (De 02-1998 Até 01-2005) 74kW 101CV 1598cc Hatchback OPEL ASTRA G Hatchback (T98) 1.6 (F08 - F48) (De 12-2002 Até 12-2009) 76kW 103CV 1598cc Hatchback...</p> <p>d-18x8mm di-16mm</p>
	<p>UMB84011L NO. 11062402 - 2060675</p> <p>TAMPÃO BLOCO DE MOTOR (RELAS)</p> <p>OPEL ASTRA G Hatchback (T98) 1.4 16V (F08 - F48) (De 02-1998 Até 01-2005) 66kW 90CV 1389cc Hatchback OPEL ASTRA G Hatchback (T98) 1.6 (F08 - F48) (De 02-1998 Até 09-2000) 55kW 75CV 1598cc Hatchback OPEL ASTRA G Hatchback (T98) 1.6 16V (F08 - F48) (De 02-1998 Até 01-2005) 74kW 101CV 1598cc Hatchback OPEL ASTRA G Hatchback (T98) 1.6 (F08 - F48) (De 12-2002 Até 12-2009) 76kW 103CV 1598cc Hatchback OP...</p> <p>d-18x8mm di-16mm</p>		<p>UMB84019 NO. 2060668</p> <p>TAMPÃO BLOCO MOTOR</p> <p>OPEL ASTRA G Hatchback (T98) 1.4 16V (F08 - F48) (De 02-1998 Até 01-2005) 66kW 90CV 1389cc Hatchback OPEL ASTRA G Hatchback (T98) 1.6 (F08 - F48) (De 02-1998 Até 09-2000) 55kW 75CV 1598cc Hatchback OPEL ASTRA G Hatchback (T98) 1.6 (F08 - F48) (De 02-1998 Até 01-2005) 74kW 101CV 1598cc Hatchback OPEL ASTRA G Hatchback (T98) 1.6 16V (F08 - F48) (De 02-1998 Até 01-2005) 74kW 101CV 1598cc Hatchback ...</p> <p>d-26x9,5mm di-23,3mm</p>
	<p>UMB84019L NO. 2060668</p> <p>TAMPÃO BLOCO DE MOTOR (RELAS)</p> <p>OPEL ASTRA G Hatchback (T98) 1.4 16V (F08 - F48) (De 02-1998 Até 01-2005) 66kW 90CV 1389cc Hatchback OPEL ASTRA G Hatchback (T98) 1.6 (F08 - F48) (De 02-1998 Até 09-2000) 55kW 75CV 1598cc Hatchback OPEL ASTRA G Hatchback (T98) 1.6 (F08 - F48) (De 02-1998 Até 01-2005) 74kW 101CV 1598cc Hatchback OPEL ASTRA G Hatchback (T98) 1.6 16V (F08 - F48) (De 02-1998 Até 01-2005) 74kW 101CV 1598cc Hatchback OPE...</p> <p>d-26x9,5mm di-23,3mm</p>		<p>UMB84021 NO. 2060673</p> <p>TAMPÃO BLOCO MOTOR</p> <p>OPEL ASTRA G Hatchback (T98) 1.4 16V (F08 - F48) (De 02-1998 Até 01-2005) 66kW 90CV 1389cc Hatchback OPEL ASTRA G Hatchback (T98) 1.6 (F08 - F48) (De 02-1998 Até 09-2000) 55kW 75CV 1598cc Hatchback OPEL ASTRA G Hatchback (T98) 1.6 (F08 - F48) (De 02-1998 Até 01-2005) 74kW 101CV 1598cc Hatchback OPEL ASTRA G Hatchback (T98) 1.6 16V (F08 - F48) (De 02-1998 Até 01-2005) 74kW 101CV 1598cc Hatchback ...</p> <p>d-28x7mm di-25,6mm</p>

	<p>UMB84021L NO. 2060673</p> <p>TAMPÃO BLOCO DE MOTOR (RELAS)</p> <p>OPEL ASTRA G Hatchback (T98) 1.4 16V (F08 - F48) (De 02-1998 Até 01-2005) 66kW 90CV 1389cc Hatchback OPEL ASTRA G Hatchback (T98) 1.6 (F08 - F48) (De 02-1998 Até 09-2000) 55kW 75CV 1598cc Hatchback OPEL ASTRA G Hatchback (T98) 1.6 (F08 - F48) (De 09-2000 Até 01-2005) 62kW 84CV 1598cc Hatchback OPEL ASTRA G Hatchback (T98) 1.6 16V (F08 - F48) (De 02-1998 Até 01-2005) 74kW 101CV 1598cc Hatchback OPE...</p> <p>d-28x7mm di-25,6mm</p>		<p>UMB84029 NO. 2060946</p> <p>TAMPÃO BLOCO MOTOR</p> <p>OPEL ASTRA G Hatchback (T98) 1.4 16V (F08, F48) (02.98 A 01.05) 90cv 1389cc Hatchback - OPEL ASTRA G Caixa (F70) 1.7 TD (F70) (01.99 A 04.05) 68cv 1700cc Caixa</p> <p>d36x10mm di-32mm</p>
	<p>UMV25431 NO. 5738741</p> <p>MANETE PUNHO TOPO ALAVANCA MUDANÇAS 5 VELOCIDADES F33MM</p> <p>OPEL ASTRA G Cabriolet (T98) 1.6 (F67) 01.2003/10.2005 76KW 103CV 1598CC Z 16 XEP 0035472 - OPEL ASTRA G Cabriolet (T98) 1.6 16V (F67) 03.2001/10.2005 74KW 101CV 1598CC Z 16 XE 0035423 - OPEL ASTRA G Cabriolet (T98) 1.8 16V (F67) 03.2001/10.2005 92KW 125CV 1796CC Z 18 XE 0035422 - OPEL ASTRA G Cabriolet (T98) 2.0 16V Turbo (F67) 11.2002/10.2005 147KW 200CV 1998CC Z 20 LET 0035474 - OPEL ASTRA G Ca...</p> <p>d50x53mm 1f-d33mm</p>		<p>UMV26809 NO. 5738737 - 90540619 - 9200972</p> <p>MANETE PUNHO TOPO ALAVANCA MUDANÇAS 5 VELOCIDADES F32MM</p> <p>OPEL ASTRA G Hatchback (T98): 1.4 16V (F08, F48) 02.1998/01.2005 66KW 90CV 1389CC - OPEL ASTRA G Hatchback (T98): 1.6 (F08, F48) 02.1998/09.2000 55KW 75CV 1598CC - OPEL ASTRA G Hatchback (T98): 1.6 (F08, F48) 09.2000/01.2005 62KW 84CV 1598CC - OPEL ASTRA G Hatchback (T98): 1.6 16V (F08, F48) 02.1998/01.2005 74KW 101CV 1598CC - OPEL ASTRA G três volumes (T98): 1.4 16V (F69) 09.1998/01.2005 66KW 90CV...</p> <p>d50x51mm 1f-d32mm</p>
	<p>UTR0800 NO. 1304240 - 1304654 - 1304659 - 1304660 - 1304661 - 1304665 - 1304666 - 1304667 - 1304853 - 90352470 - ...</p> <p>TAMPÃO RESERVATÓRIO LIQUIDO REFRIGERAÇÃO</p> <p>OPEL ASTRA G Hatchback (T98) 1.2 16V 02.98 - 09.00 48 65 1199 Hatchback OPEL ASTRA G Hatchback (T98) 1.2 16V 09.00 - 01.05 55 75 1199 Hatchback OPEL ASTRA G Hatchback (T98) 1.4 09.07 - 12.09 66 90 1364 Hatchback OPEL ASTRA G Hatchback (T98) 1.4 16V 02.98 - 01.05 66 90 1389 Hatchback OPEL ASTRA G Hatchback (T98) 1.6 02.98 - 09.00 55 75 1598 Hatchback OPEL ASTRA G Hatchback (T98) 1.6 09.00 - 01.05 6...</p> <p>d62x25mm 1f-d53x14mm</p>		<p>UTR0820 NO. 90352470 - 90409256 - 90409257 - 9041032690497472 - 90467473</p> <p>TAMPÃO RESERVATÓRIO LIQUIDO REFRIGERAÇÃO</p> <p>OPEL ASTRA G Hatchback (F48_, F08_) 1.2 16V (02.98 A 09.00) 65cv 1199cc Hatchback - OPEL ASTRA G Hatchback (F48_, F08_) 1.2 16V (09.00 A 01.05) 75cv 1199cc Hatchback - OPEL ASTRA G Hatchback (F48_, F08_) 1.4 (09.07 A 12.09) 90cv 1364cc Hatchback - OPEL ASTRA G Hatchback (F48_, F08_) 1.4 16V (02.98 A 01.05) 90cv 1389cc Hatchback - OPEL ASTRA G Hatchback (F48_, F08_) 1.6 (02.98 A 09.00) 75c...</p> <p>d62x23mm 1f-d53x12mm</p>
	<p>UTR1300 NO. 00650090 - 05650831</p> <p>TAMPÃO RESERVATÓRIO DO OLEO</p> <p>OPEL ASTRA G Hatchback (T98) 1.4 (F08 - F48) (De 09-2007 Até 12-2009) 66kW 90CV 1364cc Hatchback OPEL ASTRA G Hatchback (T98) 1.6 (F08 - F48) (De 12-2002 Até 12-2009) 76kW 103CV 1598cc Hatchback OPEL ASTRA G Hatchback (T98) 1.7 DTI 16V (F08 - F48) (De 02-2000 Até 01-2005) 55kW 75CV 1686cc Hatchback OPEL ASTRA G três volumes (T98) 1.6 (F69) (De 12-2002 Até 12-2009) 76kW 103CV 1598cc três volumes</p> <p>d59x31mm d45x12mm</p>		<p>UTR1305 NO. 0650089 - 650089</p> <p>TAMPÃO DO RESERVATÓRIO ÓLEO</p> <p>OPEL ASTRA G Cabriolet (T98) 1.6 (F67) 01.2003/10.2005 76KW 103CV 1598CC Z 16 XEP 0035472 - OPEL ASTRA G Cabriolet (T98) 1.6 16V (F67) 03.2001/10.2005 74KW 101CV 1598CC Z 16 XE 0035423 - OPEL ASTRA G Cabriolet (T98) 1.8 16V (F67) 03.2001/10.2005 92KW 125CV 1796CC Z 18 XE 0035422 - OPEL ASTRA G Cabriolet (T98) 2.0 16V Turbo (F67) 11.2002/10.2005 147KW 200CV 1998CC Z 20 LET 0035474 - OPEL ASTRA G Ca...</p> <p>d61x23mm d32x19mm</p>
	<p>UTR1305 NO. 0650089 - 650089</p> <p>TAMPÃO DO RESERVATÓRIO ÓLEO</p> <p>OPEL ASTRA G Caixa/Combi (F70) 1.6 (F70) 01.1999/09.2000 55KW 75CV 1598CC X 16 SZR 0039131 - OPEL ASTRA G Caixa/Combi (F70) 1.6 (F70) 09.2000/04.2005 62KW 84CV 1598CC Z 16 SE 1.7 TD (F70) 01.1999/04.2005 50KW 68CV 1699CC X 17 DTL 0039132 - OPEL ASTRA G Caixa/Combi (F70) 2.0 DI (F70) 01.1999/04.2005 60KW 82CV 1995CC X 20 DTL Y 20 DTL 0039133 - OPEL ASTRA G Combi (T98) 1.2 16V (F35) 02.1998/09.2000 ...</p> <p>d61x23mm d32x19mm</p>		<p>UTR1305 NO. 0650089 - 650089</p> <p>TAMPÃO DO RESERVATÓRIO ÓLEO</p> <p>OPEL ASTRA G Coupé (T98) 1.6 16V (F07) 03.2000/05.2005 76KW 103CV 1598CC Z 16 XEP 0035473 - OPEL ASTRA G Coupé (T98) 1.8 16V (F07) 03.2000/10.2000 85KW 116CV 1796CC X 18 XE1 0035385 - OPEL ASTRA G Coupé (T98) 1.8 16V (F07) 09.2000/05.2005 92KW 125CV 1796CC Z 18 XE 0035398 - OPEL ASTRA G Coupé (T98) 2.0 16V Turbo (F07) 09.2000/08.2001 140KW 190CV 1998CC Z 20 LET 0035399 - OPEL ASTRA G Coupé (T98) 2...</p> <p>d61x23mm d32x19mm</p>
	<p>UTR1305 NO. 0650089 - 650089</p> <p>TAMPÃO DO RESERVATÓRIO ÓLEO</p> <p>OPEL ASTRA G Hatchback (T98) 1.2 16V (F08, F48) 02.1998/09.2000 48KW 65CV 1199CC X 12 XE 0035342 - OPEL ASTRA G Hatchback (T98) 1.2 16V (F08, F48) 09.2000/01.2005 55KW 75CV 1199CC Z 12 XE 0035406 - OPEL ASTRA G Hatchback (T98) 1.4 16V (F08, F48) 02.1998/01.2005 66KW 90CV 1389CC X 14 XE Z 14 XE 0035343 - OPEL ASTRA G Hatchback (T98) 1.6 (F08, F48) 02.1998/09.2000 55KW 75CV 1598CC X 16 SZR 0035344 - ...</p> <p>d61x23mm d32x19mm</p>		<p>UTR1305 NO. 0650089 - 650089</p> <p>TAMPÃO DO RESERVATÓRIO ÓLEO</p> <p>OPEL ASTRA G três volumes (T98) 1.2 16V (F69) 09.1998/09.2000 48KW 65CV 1199CC X 12 XE 0035360 - OPEL ASTRA G três volumes (T98) 1.2 16V (F69) 09.2000/01.2005 55KW 75CV 1199CC Z 12 XE 0035403 - OPEL ASTRA G três volumes (T98) 1.4 16V (F69) 09.1998/01.2005 66KW 90CV 1389CC Z 14 XE X 14 XE 0035361 - OPEL ASTRA G três volumes (T98) 1.6 (F69) 09.1998/09.2000 55KW 75CV 1598CC X 16 SZR 0035362 - OPEL AS...</p> <p>d61x23mm d32x19mm</p>
	<p>UTR1404 NO. 0808211 - 09117533 - 808211</p> <p>TAMPÃO DEPÓSITO COMBUSTIVEL</p> <p>OPEL ASTRA G Hatchback (T98): 1.2 16V (F08, F48) 02.1998/09.2000 48KW 65CV 1199CC - OPEL ASTRA G Hatchback (T98): 1.2 16V (F08, F48) 09.2000 - 01.2005 55 75 1199 ASTRA G Hatchback (T98): 1.4 (F08, F48) 09.2007 - 12.2009 66 90 1364 ASTRA G Hatchback (T98): 1.4 16V (F08, F48) 02.1998 - 01.2005 66 90 1389 ASTRA G Hatchback (T98): 1.6 (F08, F48) 02.1998 - 09.2000 55 75 1598</p> <p>d41x45mm</p>		<p>UTV83011 NO. 0652475 - 09275631 - 652475 - 652491 - 90409376 - 9275631 - N90288901</p> <p>TAMPÃO VEDAÇÃO BUJÃO</p> <p>OPEL ASTRA G Hatchback (T98) 1.4 16V (F08 - F48) (De 02-1998 Até 01-2005) 66kW 90CV 1389cc Hatchback OPEL ASTRA G Hatchback (T98) 1.6 (F08 - F48) (De 02-1998 Até 09-2000) 55kW 75CV 1598cc Hatchback OPEL ASTRA G Hatchback (T98) 1.6 (F08 - F48) (De 09-2000 Até 01-2005) 62kW 84CV 1598cc Hatchback OPEL ASTRA G Hatchback (T98) 1.6 16V (F08 - F48) (De 02-1998 Até 01-2005) 74kW 101CV 1598cc Hatchback ...</p> <p>19x18mm c12mm d14mm</p>
	<p>UTV83019 NO. 0652315 - 0652477 - 652315 - 652477 - 90502556 - 96023264</p> <p>TAMPÃO VEDAÇÃO BUJÃO</p> <p>OPEL ASTRA G Hatchback (T98) 1.2 16V (F08 - F48) (De 02-1998 Até 09-2000) 48kW 65CV 1199cc Hatchback OPEL ASTRA G Hatchback (T98) 1.2 16V (F08 - F48) (De 09-2000 Até 01-2005) 55kW 75CV 1199cc Hatchback OPEL ASTRA G Hatchback (T98) 1.4 (F08 - F48) (De 09-2007 Até 12-2009) 66kW 90CV 1364cc Hatchback OPEL ASTRA G Hatchback (T98) 1.6 16V (F08 - F48) (De 02-1998 Até 01-2005) 74kW 101CV 1598cc Hatchb...</p> <p>d25x14mm c9mm d13mm</p>		<p>UVD21057 NO. 0905122 - 9223059</p> <p>VEIO DA DIREÇÃO</p> <p>OPEL ASTRA G CLASSIC (T98) 1.4 16V (F08, F48) 05.2004/07.2009 66KW 90CV 1389CC Z 14 XE - OPEL ASTRA G CLASSIC (T98) 1.6 (F08, F48) 03.2006/06.2008 76KW 103CV 1598CC Z 16 XEP - OPEL ASTRA G CLASSIC (T98) 1.6 16V (F08, F48) 05.2004/02.2006 74KW 101CV 1598CC Z 16 XE - OPEL ASTRA G CLASSIC (T98) 1.7 CDTI (F08, F48) 06.2004/07.2009 59KW 80CV 1686CC Z 17 DTL - OPEL ASTRA G CLASSIC três volumes (T98) 1.4...</p> <p>247x42x42mm 1r-d7mm 1r-d8mm</p>



	UVD21057 NO. 0905122 - 9223059 VEIO DA DIREÇÃO OPEL ASTRA G Cabriolet (T98) 1.6 (F67) 01.2003/10.2005 76KW 103CV 1598CC Z 16 XEP 0035472 - OPEL ASTRA G Cabriolet (T98) 1.6 16V (F67) 03.2001/10.2005 74KW 101CV 1598CC Z 16 XE 0035423 - OPEL ASTRA G Cabriolet (T98) 1.8 16V (F67) 03.2001/10.2005 92KW 125CV 1796CC Z 18 XE 0035422 - OPEL ASTRA G Cabriolet (T98) 2.0 16V Turbo (F67) 11.2002/10.2005 147KW 200CV 1998CC Z 20 LET 0035474 - OPEL ASTRA G Ca... 247x42x42mm 1r-d7mm 1r-d8mm		UVD21057 NO. 0905122 - 9223059 VEIO DA DIREÇÃO OPEL ASTRA G Caixa/Combi (F70) 1.4 (F70) 09.1998/04.2005 66KW 90CV 1389CC Z 14 XE X 14 XE - OPEL ASTRA G Caixa/Combi (F70) 1.6 (F70) 09.1998/01.2004 74KW 101CV 1598CC Z 16 XE C 16 SEL - OPEL ASTRA G Caixa/Combi (F70) 1.6 (F70) 01.1999/09.2000 55KW 75CV 1598CC X 16 SZR 0039131 - OPEL ASTRA G Caixa/Combi (F70) 1.6 (F70) 09.2000/04.2005 62KW 84CV 1598CC Z 16 SE - OPEL ASTRA G Caixa/Combi (F70) 1.6 (F... 247x42x42mm 1r-d7mm 1r-d8mm
	UVD21057 NO. 0905122 - 9223059 VEIO DA DIREÇÃO OPEL ASTRA G Combi (T98) 1.2 16V (F35) 02.1998/09.2000 48KW 65CV 1199CC X 12 XE 0035350 - OPEL ASTRA G Combi (T98) 1.2 16V (F35) 09.2000/07.2004 55KW 75CV 1199CC Z 12 XE 0035409 - OPEL ASTRA G Combi (T98) 1.4 16V (F35) 06.1998/07.2004 66KW 90CV 1389CC X 14 XE Z 14 XE 0035351 - OPEL ASTRA G Combi (T98) 1.4 LPG (F35) 03.1998/07.2004 66KW 90CV 1389CC Z 14 XE X 14 XE - OPEL ASTRA G Combi (T98) 1.6 (F3... 247x42x42mm 1r-d7mm 1r-d8mm		UVD21057 NO. 0905122 - 9223059 VEIO DA DIREÇÃO OPEL ASTRA G Coupé (T98) 1.6 16V (F07) 03.2000/05.2005 74KW 101CV 1598CC Z 16 XE 0035428 - OPEL ASTRA G Coupé (T98) 1.6 16V (F07) 03.2000/05.2005 76KW 103CV 1598CC Z 16 XEP 0035473 - OPEL ASTRA G Coupé (T98) 1.8 16V (F07) 03.2000/10.2000 85KW 116CV 1796CC X 18 XE1 0035385 - OPEL ASTRA G Coupé (T98) 1.8 16V (F07) 09.2000/05.2005 92KW 125CV 1796CC Z 18 XE 0035398 - OPEL ASTRA G Coupé (T98) 2.0 16V T... 247x42x42mm 1r-d7mm 1r-d8mm
	UVD21057 NO. 0905122 - 9223059 VEIO DA DIREÇÃO OPEL ASTRA G Hatchback (T98) 1.2 16V (F08, F48) 02.1998/09.2000 48KW 65CV 1199CC X 12 XE 0035342 - OPEL ASTRA G Hatchback (T98) 1.2 16V (F08, F48) 09.2000/01.2005 55KW 75CV 1199CC Z 12 XE 0035406 - OPEL ASTRA G Hatchback (T98) 1.4 (F08, F48) 09.2007/12.2009 66KW 90CV 1364CC Z 14 XEP 0035AHY - OPEL ASTRA G Hatchback (T98) 1.4 16V (F08, F48) 02.1998/01.2005 66KW 90CV 1389CC X 14 XE Z 14 XE 0035343 -... 247x42x42mm 1r-d7mm 1r-d8mm		UVD21057 NO. 0905122 - 9223059 VEIO DA DIREÇÃO OPEL ASTRA G três volumes (T98) 1.2 16V (F69) 09.1998/09.2000 48KW 65CV 1199CC X 12 XE 0035360 - OPEL ASTRA G três volumes (T98) 1.2 16V (F69) 09.2000/01.2005 55KW 75CV 1199CC Z 12 XE 0035403 - OPEL ASTRA G três volumes (T98) 1.4 (F69) 09.2007/12.2009 66KW 90CV 1364CC Z 14 XEP 0035AHV - OPEL ASTRA G três volumes (T98) 1.4 16V (F69) 09.1998/01.2005 66KW 90CV 1389CC Z 14 XE X 14 XE 0035361 - OPEL AS... 247x42x42mm 1r-d7mm 1r-d8mm
	W5051 NO. 0614411 - 09128177 - 09544461 - 55351711 - 5535171169 - 5614415 - 5614437 - 614411 - 614444 - 9... POLIE DA CAMBOTA (6 PISTAS) OPEL ASTRA G Cabriolet (T98) 2.2 DTI (F67) 09.2002/10.2005 92KW 125CV 2172CC Y 22 DTR 0035466 - OPEL ASTRA G Caixa/Combi (F70) 2.0 DI (F70) 01.1999/04.2005 60KW 82CV 1995CC X 20 DTLX 20 DTL 0039133 - OPEL ASTRA G Caixa/Combi (F70) 2.0 DTI (F70) 09.2000/04.2005 74KW 101CV 1995CC Y 20 DTH - OPEL ASTRA G Combi (T98) 2.0 DI (F35) 02.1998/07.2004 60KW 82CV 1995CC Y 20 DTLX 20 DTL 0035356 - OPEL ASTRA G... d153mm d35mm		W5080 NO. 5614441 - 5614442 - 97229044 - 97353964 POLIE DA CAMBOTA (6 PISTAS) OPEL ASTRA G Caixa/Combi (F70) 1.7 CDTI (F70) 07.2003/11.2004 59KW 80CV 1686CC Z 17 DTL - OPEL ASTRA G CLASSIC (T98) 1.7 CDTI (F08, F48) 06.2004/07.2009 59KW 80CV 1686CC Z 17 DTL - OPEL ASTRA G CLASSIC Caravan (F35) 1.7 CDTI 05.2004/07.2009 59KW 80CV 1686CC Z 17 DTL 0035AIC - OPEL ASTRA G Combi (T98) 1.7 CDTI (F35) 04.2003/05.2004 59KW 80CV 1686CC Z 17 DTL 0035500 - OPEL ASTRA G Hatchback (T98) 1... d152mm d48mm
	W5082 NO. 0614426 - 5614444 - 614426 - 97251975 - 97361525 POLIE DA CAMBOTA (6 PISTAS) OPEL ASTRA G Caixa/Combi (F70) 1.7 DTI 16V (F70) 02.2000/04.2005 55KW 75CV 1686CC Y 17 DT - OPEL ASTRA G Combi (T98) 1.7 DTI 16V (F35) 02.2000/07.2004 55KW 75CV 1686CC Y 17 DT 0035376 - OPEL ASTRA G Hatchback (T98) 1.7 DTI 16V (F08, F48) 02.2000/01.2005 55KW 75CV 1686CC Y 17 DT 0035378 - OPEL ASTRA G três volumes (T98) 1.7 DTI 16V (F69) 02.2000/01.2005 55KW 75CV 1686CC Y 17 DT 0035380 d139/141mm d48mm		W5092 NO. 615029 POLIE DA CAMBOTA (5 PISTAS) OPEL ASTRA (G) 2.0 (G)ASOLINA d147mm d42mm
	W5098 NO. 5614427 - 90531583 POLIE DA CAMBOTA (4 PISTAS + 1 PISTA) OPEL ASTRA G Hatchback (T98): 1.7 TD (F08, F48) 02.1998/08.2000 50KW 68CV 1700CC - OPEL ASTRA G três volumes (T98): 1.7 TD (F69) 09.1998/08.2000 50KW 68CV 1700CC - OPEL ASTRA G Combi (T98): 1.7 TD (F35) 02.1998/08.2000 50KW 68CV 1700CC - OPEL ASTRA G Caixa (F70): 1.7 TD (F70) 01.1999/04.2005 50KW 68CV 1700CC d144mm d42mm		W5107 NO. 5614425 - 5614431 - 9129209 POLIE DA CAMBOTA (5 PISTAS) OPEL ASTRA G 2 VOLUMI - CODA SPIOVENTE 1.4 Z 14 XEP 90CV (09-2007 A 12-2009) - 1.4 16V X 14 XE - Z 14 XE 90CV (02-1998 A 01-2005) - 1.6 Z 16 XEP 103CV (12-2002 A 01-2005) - 1.6 16V X16 XEL - Z 16 XE 101CV (02-1998 A 01-2005) - 1.8 16V X18 XE1 116CV (02-1998) d160m 1f-d26mm
	W5107 NO. 5614425 - 5614431 - 9129209 POLIE DA CAMBOTA (5 PISTAS) OPEL ASTRA G STATION WAGON 1.4 16V X 14 XE - Z 14 XE 90CV (06-1998 A 07-2004) - 1.6 Z 16 XEP 103CV (12-2002 A 07-2009) - 1.6 16V X 16 XEL - Z 16 XE 101CV (02-1998 A 07-2004) - 1.8 16V X 18 XE1 116CV (02-1998 A 09-2000) - 1.8 16V Z 18 XE 125CV (09-2000 A 07-20... d160m 1f-d26mm		W5178 NO. 614473 - 90448439 POLIE DA CAMBOTA (1+1 PISTAS) OPEL ASTRA G Hatchback (T98): 1.7 TD (F08, F48) 02.1998/08.2000 50KW 68CV 1700CC - OPEL ASTRA G Combi (T98): 1.7 TD (F35) 02.1998/08.2000 50KW 68CV 1700CC d146mm d41mm
	W5185 NO. 614473 - 90448439 POLIE DA CAMBOTA (1+1 PISTAS) OPEL ASTRA G Hatchback (T98): 1.7 TD (F08, F48) 02.1998/08.2000 50KW 68CV 1700CC - OPEL ASTRA G Combi (T98): 1.7 TD (F35) 02.1998/08.2000 50KW 68CV 1700CC d146mm d42mm		W5201 NO. 5614423 - 90572867 POLIE DA CAMBOTA (5 PISTAS) OPEL ASTRA G Hatchback (T98): 1.2 16V (F08, F48) 02.1998/09.2000 48KW 65CV 1199CC - OPEL ASTRA G Hatchback (T98): 1.2 16V (F08, F48) 09.2000/01.2005 55KW 75CV 1199CC - OPEL ASTRA G Hatchback (T98): 1.4 (F08, F48) 09.2007/12.2009 66KW 90CV 1364CC - OPEL ASTRA G três volumes (T98): 1.2 16V (F69) 09.1998/09.2000 48KW 65CV 1199CC - OPEL ASTRA G três volumes (T98): 1.2 16V (F69) 09.2000/01.2005 55KW 75... d152mm d39mm

	Y3212	NO. 1008501 - 1008504 - 4709077		Y3212	NO. 1008501 - 1008504 - 4709077
	<p>PARAFUSO PERNO RODA CHAVE 17 M12X1,50X48MM (BASE CONICA PARA JANTES AÇO E LIGA LEVE)</p> <p>OPEL ASTRA G Cabriolet (T98) 1.6 (F67) (01.2003 - 10.2005) 76kw 103cv 1598cm3 Cabriolet OPEL ASTRA G Cabriolet (T98) 1.6 16V (F67) (03.2001 - 10.2005) 74kw 101cv 1598cm3 Cabriolet OPEL ASTRA G Cabriolet (T98) 1.8 16V (F67) (03.2001 - 10.2005) 92kw 125cv 1796cm3 Cabriolet OPEL ASTRA G Cabriolet (T98) 2.0 16V Turbo (F67) (11.2002 - 10.2005) 147kw 200cv 1998cm3 Cabriolet OPEL ASTRA G Cabriolet (T98) ...</p>			<p>PARAFUSO PERNO RODA CHAVE 17 M12X1,50X48MM (BASE CONICA PARA JANTES AÇO E LIGA LEVE)</p> <p>OPEL ASTRA G Caixa/Combi (F70) 1.6 (F70) (01.1999 - 09.2000) 55kw 75cv 1598cm3 Caixa/Combi OPEL ASTRA G Caixa/Combi (F70) 1.6 (F70) (09.2000 - 04.2005) 62kw 84cv 1598cm3 Caixa/Combi OPEL ASTRA G Caixa/Combi (F70) 1.7 TD (F70) (01.1999 - 04.2005) 50kw 68cv 1699cm3 Caixa/Combi OPEL ASTRA G Caixa/Combi (F70) 2.0 DI (F70) (01.1999 - 04.2005) 60kw 82cv 1995cm3 Caixa/Combi OPEL ASTRA G Combi (T98) 1.2 1.2...</p>	
C48mm (Ch-17mm)		M12x1,50x22mm	C48mm (Ch-17mm)		M12x1,50x22mm
	Y3212	NO. 1008501 - 1008504 - 4709077		Y3212	NO. 1008501 - 1008504 - 4709077
	<p>PARAFUSO PERNO RODA CHAVE 17 M12X1,50X48MM (BASE CONICA PARA JANTES AÇO E LIGA LEVE)</p> <p>OPEL ASTRA G Coupé (T98) 1.6 16V (F07) (03.2000 - 05.2005) 74kw 101cv 1598cm3 Coupé OPEL ASTRA G Coupé (T98) 1.6 16V (F07) (03.2000 - 05.2005) 76kw 103cv 1598cm3 Coupé OPEL ASTRA G Coupé (T98) 1.8 16V (F07) (03.2000 - 10.2000) 85kw 116cv 1796cm3 Coupé OPEL ASTRA G Coupé (T98) 1.8 16V (F07) (09.2000 - 05.2005) 92kw 125cv 1796cm3 Coupé OPEL ASTRA G Coupé (T98) 2.0 16V Turbo (F07) (09.2000 - 08.2001)...</p>			<p>PARAFUSO PERNO RODA CHAVE 17 M12X1,50X48MM (BASE CONICA PARA JANTES AÇO E LIGA LEVE)</p> <p>OPEL ASTRA G Hatchback (T98) 1.2 16V (F08, F48) (02.1998 - 09.2000) 48kw 65cv 1199cm3 Hatchback OPEL ASTRA G Hatchback (T98) 1.2 16V (F08, F48) (09.2000 - 01.2005) 55kw 75cv 1199cm3 Hatchback OPEL ASTRA G Hatchback (T98) 1.4 (F08, F48) (09.2007 - 12.2009) 66kw 90cv 1364cm3 Hatchback OPEL ASTRA G Hatchback (T98) 1.4 16V (F08, F48) (02.1998 - 01.2005) 66kw 90cv 1389cm3 Hatchback OPEL ASTRA G Hatchba...</p>	
C48mm (Ch-17mm)		M12x1,50x22mm	C48mm (Ch-17mm)		M12x1,50x22mm
	Y3212	NO. 1008501 - 1008504 - 4709077		Z80540	NO. 2240861 - 90022049
	<p>PARAFUSO PERNO RODA CHAVE 17 M12X1,50X48MM (BASE CONICA PARA JANTES AÇO E LIGA LEVE)</p> <p>OPEL ASTRA G três volumes (T98) 1.2 16V (F69) (09.1998 - 09.2000) 48kw 65cv 1199cm3 três volumes OPEL ASTRA G três volumes (T98) 1.2 16V (F69) (09.2000 - 01.2005) 55kw 75cv 1199cm3 três volumes OPEL ASTRA G três volumes (T98) 1.4 (F69) (09.2007 - 12.2009) 66kw 90cv 1364cm3 três volumes OPEL ASTRA G três volumes (T98) 1.4 16V (F69) (09.1998 - 01.2005) 66kw 90cv 1389cm3 três volumes OPEL ASTRA G três...</p>			<p>Mola de painel</p> <p>OPEL ASTRA G</p>	
C48mm (Ch-17mm)		M12x1,50x22mm	d12x14.3mm		1p-d7-12.3mm
	Z80846	NO. 1104881 - 1104882 - 90450482		Z9011	NO. 1261479 - 1449282600 - 4709339 - 4711509 - 854880
	<p>Rebite</p> <p>OPEL ASTRA G</p>			<p>MOLA DE ESCAPE</p> <p>OPEL ASTRA G</p>	
d19x29mm		1p-d8-15.2mm	d23x42mm		













OPEL ASTRA GTC

	Y3212	NO. 1008501 - 1008504 - 4709077		
	<p>PARAFUSO PERNO RODA CHAVE 17 M12X1,50X48MM (BASE CONICA PARA JANTES AÇO E LIGA LEVE)</p> <p>OPEL ASTRA H GTC (A04) 1.3 CDTI (L08) (04.2005 - 10.2010) 66kw 90cv 1248cm3 Hatchback OPEL ASTRA H GTC (A04) 1.4 (L08) (03.2005 - 10.2010) 55kw 75cv 1364cm3 Hatchback OPEL ASTRA H GTC (A04) 1.4 (L08) (03.2005 - 10.2010) 66kw 90cv 1364cm3 Hatchback OPEL ASTRA H GTC (A04) 1.6 (L08) (03.2005 - 10.2010) 77kw 105cv 1598cm3 Hatchback OPEL ASTRA H GTC (A04) 1.6 (L08) (12.2006 - 10.2010) 85kw 116cv 1598cm...</p>			
C48mm (Ch-17mm)		M12x1,50x22mm		

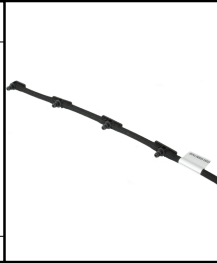
OPEL ASTRA H

	A1685	NO. 684693		A1692	NO. 5682519 - 90538582
	<p>APOIO DO MOTOR PARTE DA FRENTE</p> <p>OPEL ASTRA (H) 1.8 (COM TRANSMISSÃO AUTOMÁTICA)</p>			<p>APOIO DO MOTOR PARTE DE TRÁS</p> <p>OPEL ASTRA H</p>	
145x125x75mm		1f-d16mm	155x125x92mm		1f-d12mm

	<p>A1944 NO. 13159993 - 5684651</p> <p>APOIO MOTOR ESQUERDO</p> <p>OPEL ASTRA H (L48) 1.4 (04.04 A 10.04) 75cv 1364cc Hatchback - OPEL ASTRA H (L48) 1.4 (03.04 A 10.10) 90cv 1364cc Hatchback - OPEL ASTRA H (L48) 1.4 LPG (08.09 A 10.10) 90cv 1364cc Hatchback - OPEL ASTRA H GTC (L08) 1.4 (03.05 A 10.10) 75cv 1364cc Hatchback - OPEL ASTRA H GTC (L08) 1.4 (03.05 A 10.10) 90cv 1364cc Hatchback - OPEL ASTRA H Combi (L35) 1.4 (08.04 A 10.10) 75cv 1364cc Combi...</p> <p>165x110x70mm 1f-d13mm 4f-d9mm 1p-8x18mm</p>		<p>A2059 NO. 24459803 - 5684137</p> <p>APOIO DO MOTOR PARTE DA FRENTE</p> <p>OPEL ASTRA H (A04) 1.4 (L48) (De 04-2004 Até 10-2004) 55kW 75CV 1364cc Hatchback OPEL ASTRA H (A04) 1.4 (L48) (De 03-2004 Até 10-2010) 66kW 90CV 1364cc Hatchback OPEL ASTRA H (A04) 1.4 LPG (L48) (De 08-2009 Até 10-2010) 66kW 90CV 1364cc Hatchback OPEL ASTRA H (A04) 1.6 (L48) (De 03-2004 Até 10-2010) 77kW 105CV 1598cc Hatchback OPEL ASTRA H (A04) 1.6 (L48) (De 12-2006 Até 05-2014) 85kW 116CV 1598cc...</p> <p>222x91x74mm 2f-d13mm 1f-d16mm</p>
	<p>A2060 NO. 13125635 - 13125635JH - 511671286 - 5684130 - 5684130</p> <p>APOIO DO MOTOR PARTE DA FRENTE</p> <p>OPEL ASTRA H (A04) 1.7 CDTI (L48) (De 03-2004 Até 10-2010) 59kW 80CV 1686cc Hatchback OPEL ASTRA H (A04) 1.7 CDTI (L48) (De 03-2004 Até 10-2010) 74kW 100CV 1686cc Hatchback OPEL ASTRA H (A04) 1.7 CDTI (L48) (De 02-2007 Até 05-2014) 81kW 110CV 1686cc Hatchback OPEL ASTRA H (A04) 1.7 CDTI (L48) (De 02-2007 Até 05-2014) 92kW 125CV 1686cc Hatchback OPEL ASTRA H GTC (A04) 1.7 CDTI (L08) (De 03-2005 Até...</p> <p>209x140x75mm 2f-d13mm 1f-d16mm</p>		<p>A2545 NO. 5684644</p> <p>APOIO DO MOTOR PARTE DA FRENTE LADO DIREITO</p> <p>OPEL ASTRA H (A04) 1.7 CDTI (L48) (De 03.2004 Até 10.2010) 59kW 80cv 1686cm3 Hatchback - OPEL ASTRA H (A04) 1.7 CDTI (L48) (De 03.2004 Até 10.2010) 74kW 100cv 1686cm3 Hatchback - OPEL ASTRA H (A04) 1.7 CDTI (L48) (De 02.2007 Até 05.2014) 81kW 110cv 1686cm3 Hatchback - OPEL ASTRA H (A04) 1.7 CDTI (L48) (De 02.2007 Até 05.2014) 92kW 125cv 1686cm3 Hatchback - OPEL ASTRA H (A04) 1.9 CDTI (L48) (De 09....</p> <p>170x65x114mm 2f-d10mm 1f-d12mm 1f-d13mm</p>
	<p>C0233 NO. 1160724 - 90054143</p> <p>BOTÃO AFINAÇÃO CAPÔT</p> <p>OPEL ASTRA H (L48) 1.4 (04.04 A 10.04) 75cv 1364cc Hatchback - OPEL ASTRA H (L48) 1.4 (03.04 A 10.10) 90cv 1364cc Hatchback - OPEL ASTRA H (L48) 1.4 LPG (08.09 A 10.10) 90cv 1364cc Hatchback - OPEL ASTRA H (L48) 1.6 (03.04 A 10.10) 105cv 1598cc Hatchback - OPEL ASTRA H (L48) 1.6 (12.06 A 05.14) 116cv 1598cc Hatchback - OPEL ASTRA H (L48) 1.6 Turbo (02.07 A 10.10) 180cv 1598cc Hatchback ...</p> <p>d19x31mm</p>		<p>C0233 NO. 1160724 - 90054143</p> <p>BOTÃO AFINAÇÃO CAPÔT</p> <p>OPEL ASTRA J 1.4 (A Partir de 12.09) 87cv 1398cc Hatchback - OPEL ASTRA J 1.4 (A Partir de 12.09) 100cv 1398cc Hatchback - OPEL ASTRA J 1.4 Turbo (A Partir de 10.10) 120cv 1364cc Hatchback - OPEL ASTRA J 1.4 Turbo (A Partir de 12.09) 140cv 1364cc Hatchback - OPEL ASTRA J 1.4 LPG (A Partir de 01.12) 140cv 1364cc Hatchback - OPEL ASTRA J 1.6 (A Partir de 12.09) 115cv 1598cc Hatchback - ...</p> <p>d19x31mm</p>
	<p>C0233 NO. 1160724 - 90054143</p> <p>BOTÃO AFINAÇÃO CAPÔT</p> <p>OPEL CASCADA (W13) 1.4 (A Partir de 03.13) 120cv 1362cc Cabriolet - OPEL CASCADA (W13) 1.4 Turbo (A Partir de 03.13) 140cv 1362cc Cabriolet - OPEL CASCADA (W13) 1.6 SIDI (A Partir de 03.13) 170cv 1598cc Cabriolet - OPEL CASCADA (W13) 2.0 CDTI (A Partir de 03.13) 165cv 1956cc Cabriolet - OPEL CASCADA (W13) 2.0 CDTI (A Partir de 03.13) 194cv 1956cc Cabriolet</p> <p>d19x31mm</p>		<p>E0163 NO. 0350611 - 0350614 - 13169439 - 350611 - 350614 - 90498745</p> <p>ESTICADOR DA BARRA ESTABILIZADORA DA FRENTE</p> <p>OPEL ASTRA H (A04): 1.4 (L48) 04.2004/10.2004 55KW 75CV 1364CC - OPEL ASTRA H (A04): 1.4 (L48) 03.2004/10.2010 66KW 90CV 1364CC - OPEL ASTRA H (A04): 1.4 LPG (L48) 08.2009/10.2010 66KW 90CV 1364CC - OPEL ASTRA H (A04): 1.6 (L48) 03.2004/10.2010 77KW 105CV 1598CC - OPEL ASTRA H (A04): 1.6 (L48) 03.2004/10.2010 77KW 105CV 1598CC - OPEL ASTRA H (A04): 1.6 (L48) 12.2006/05.2014 85KW 116CV 1598CC - OPEL ASTRA H (A04): 1.6 Turbo (L48) 02.2007/10.2010 132KW 180CV 1598C...</p> <p>340x37x37mm 2p-d12-25mm</p>
	<p>E1092 NO. 0852726 - 13276148 - 852577 - 852726 - 90466668</p> <p>ESTICADOR DE ESCAPE</p> <p>OPEL ASTRA H (A04): 1.4 (L48) 03.2004/10.2010 66KW 90CV 1364CC - OPEL ASTRA H (A04): 1.4 LPG (L48) 08.2009/10.2010 66KW 90CV 1364CC - OPEL ASTRA H (A04): 1.6 (L48) 03.2004/10.2010 77KW 105CV 1598CC - OPEL ASTRA H (A04): 1.6 (L48) 12.2006/05.2014 85KW 116CV 1598CC - OPEL ASTRA H (A04): 1.8 (L48) 01.2004/10.2010 92KW 125CV 1796CC - OPEL ASTRA H (A04): 1.8 (L48) 01.2006/10.2010 103KW 140CV 1796CC - O...</p> <p>55x40x35mm</p>		<p>E23401-V NO. 0758801 - 758801 - 90250156</p> <p>ESTICADOR MANETE CAIXA DE VELOCIDADES</p> <p>OPEL ASTRA H (A04) 1.4 (L48) (De 04-2004 Até 10-2004) 55kW 75CV 1364cc Hatchback OPEL ASTRA H (A04) 1.4 (L48) (De 03-2004 Até 10-2010) 66kW 90CV 1364cc Hatchback OPEL ASTRA H (A04) 1.4 LPG (L48) (De 08-2009 Até 10-2010) 66kW 90CV 1364cc Hatchback OPEL ASTRA H (A04) 1.6 (L48) (De 03-2004 Até 10-2010) 77kW 105CV 1598cc Hatchback OPEL ASTRA H (A04) 1.6 (L48) (De 03-2004 Até 10-2010) 77kW 105CV 1598cc Hatchback OPEL ASTRA H (A04) 1.6 (L48) (De 12-2006 Até 05-2014) 85kW 116CV 1598cc...</p> <p>207x17x18mm 2f-d11mm</p>
	<p>F0520-I NO. 374018 - 90095162</p> <p>FOLE DO SEMI-EIXO INTERNO (F1026)</p> <p>OPEL ASTRA (H) 1.4i 16v - 1.6i 16v (APÓS 03-2004)</p> <p>d72x94mm 1f-d54mm 1f-d19mm</p>		<p>F1848-I NO. 1603014 - 1603183 - 1603238 - 374014 - 374319 - 374429 - 90543336</p> <p>FOLE DA TRANSMISSÃO JUNTO À CAIXA</p> <p>OPEL ASTRA (H) 1.7CDTI - 1.8i (APÓS 2004)</p> <p>d95x100mm 1f-d65mm 1f-d24mm</p>
	<p>F3773-T NO. 39241BM525 - 39241BM526 - 39241BM527</p> <p>FOLE TRANSMISSÃO JUNTO À RODA</p> <p>OPEL ASTRA H (A04): 1.4 (L48) 04.2004/10.2004 55KW 75CV 1364CC - OPEL ASTRA H (A04): 1.4 (L48) 03.2004/10.2010 66KW 90CV 1364CC - OPEL ASTRA H (A04): 1.4 LPG (L48) 08.2009/10.2010 66KW 90CV 1364CC - OPEL ASTRA H (A04): 1.6 (L48) 03.2004/10.2010 77KW 105CV 1598CC - OPEL ASTRA H (A04): 1.6 (L48) 12.2006/05.2014 85KW 116CV 1598CC - OPEL ASTRA H GTC (A04): 1.4 (L08) 03.2005/10.2010 55KW 75CV 1364CC - ...</p> <p>d93x121mm 1f-d76mm 1f-d23mm</p>		<p>F4138 NO. 0578424 - 13122456 - 578424</p> <p>FOLE ALAVANCA TRAVÃO DE MÃO</p> <p>OPEL ASTRA H (A04): 1.6 (L48) 03.2004/10.2010 77KW 105CV 1598CC - OPEL ASTRA H (A04): 1.6 (L48) 12.2006/05.2014 85KW 116CV 1598CC - OPEL ASTRA H (A04): 1.3 CDTI (L48) 08.2005/10.2010 66KW 90CV 1248CC - OPEL ASTRA H GTC (A04): 1.3 CDTI (L08) 04.2005/10.2010 66KW 90CV 1248CC - OPEL ASTRA H Combi (A04): 1.6 (L35) 08.2004/10.2010 77KW 105CV 1598CC</p> <p>189x58x150mm 1f-d8mm</p>
	<p>F4142 NO. 5738025 - 93180984</p> <p>FOLE ALAVANCA VELOCIDADES</p> <p>OPEL ASTRA H (A04): 1.2 (L48) 08.2005/10.2010 59KW 80CV 1229CC - OPEL ASTRA H (A04): 1.4 (L48) 04.2004/10.2004 55KW 75CV 1364CC - OPEL ASTRA H (A04): 1.6 (L48) 12.2006/05.2014 85KW 116CV 1598CC - OPEL ASTRA H (A04): 1.8 (L48) 01.2006/10.2010 103KW 140CV 1796CC - OPEL ASTRA H (A04): 1.7 CDTI (L48) 03.2004/10.2010 74KW 100CV 1686CC - OPEL ASTRA H (A04): 1.7 CDTI (L48) 02.2007/05.2014 81KW 110CV 1686...</p> <p>155x133x160mm 1f-d22mm</p>		<p>F4303 NO. 55351706 - H55351706</p> <p>FOLE ALAVANCA VELOCIDADES C/ MANETE PUNHO TOPO COMPLETO 5 VELOCIDADES</p> <p>OPEL ASTRA H GTC (A04) 1.3 CDTI (L08) 04.2005/10.2010 66KW 90CV 1248CC Z 13 DTH 0035AEI 0035556 0035567</p> <p>250x156x131mm 1f-114x153mm</p>

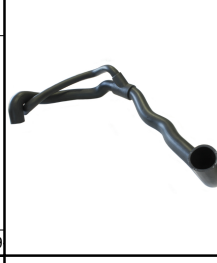
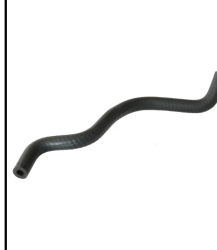
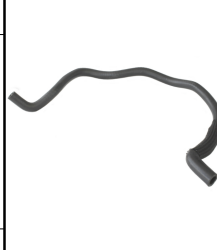
	<p>KF2362-T NO. 1603232 - 1603278 - 1603281 - 1603284 - 93182574</p> <p>KIT DE FOLE DO CARDAN JUNTO Á RODA</p> <p>OPEL ASTRA H (APÓS 2004) 1.9CDTi 16V - 1.9CDTi 8V - 2.0i 16V</p> <p>d104x130mm 1f-d91mm 1f-d27mm</p>		<p>KF3760-T NO. 09201727 - 1603012 - 96391553 - 96489655</p> <p>KIT DE FOLE DO CARDAN JUNTO Á RODA</p> <p>OPEL ASTRA H</p> <p>d106x122mm 1f-d82mm 1f-d24mm</p>
	<p>KF3788-T NO. 1603277</p> <p>KIT DE FOLE DO CARDAN JUNTO Á RODA</p> <p>OPEL ASTRA (H) 1.7 CDTi 16v - 1.8i 16v (APÓS 2004)</p> <p>d100x122mm 1f-d83mm 1f-d25mm</p>		<p>KL80449 NO. 198283 - 607813 - 90412865</p> <p>KIT CASQUILHOS COBERTURA TAMPA MOTOR</p> <p>OPEL ASTRA H (A04): 1.8 (L48) 01.2004/10.2010 92KW 125CV 1796CC - OPEL ASTRA H GTC (A04): 1.8 (L08) 03.2005/10.2010 92KW 125CV 1796CC - OPEL ASTRA H Combi (A04): 1.8 (L35) 08.2004/10.2010 92KW 125CV 1796CC - OPEL ASTRA H TwinTop (A04): 1.8 (L67) 09.2005/10.2010 92KW 125CV 1796CC</p> <p>d16x10mm 1f-d6mm</p>
	<p>KL80932 NO. 1p-d6-10mm d-20/10mm 1f-d14mm 1f-d</p> <p>KIT CASQUILHO COBERTURA TAMPA MOTOR</p> <p>OPEL ASTRA H (A04): 1.3 CDTi (L48) 08.2005/10.2010 66KW 90CV 1248CC - OPEL ASTRA H GTC (A04): 1.3 CDTi (L08) 04.2005/10.2010 66KW 90CV 1248CC - OPEL ASTRA H Combi (A04): 1.3 CDTi (L35) 08.2005/10.2010 66KW 90CV 1248CC - OPEL ASTRA H Caixa/Combi (L70): 1.3 CDTi (L70) 08.2005/10.2010 66KW 90CV 1248CC</p> <p>d30/75mm d-33/19mm d-39/26mm d-20/10mm 1f-d14mm 1f-d2</p>		<p>P1081 NO. 0842736 - 842736 - 90232022</p> <p>CAPA PEDAL ACELADOR</p> <p>OPEL ASTRA G Cabriolet (T98) 1.6 (F67) 01.2003/10.2005 76KW 103CV 1598CC Z 16 XEP 0035472 - OPEL ASTRA G Cabriolet (T98) 1.6 16V (F67) 03.2001/10.2005 74KW 101CV 1598CC Z 16 XE 0035423 - OPEL ASTRA G Cabriolet (T98) 1.8 16V (F67) 03.2001/10.2005 92KW 125CV 1796CC Z 18 XE 0035422 - OPEL ASTRA G Cabriolet (T98) 2.0 16V Turbo (F67) 11.2002/10.2005 147KW 200CV 1998CC Z 20 LET 0035474 - OPEL ASTRA G Ca...</p> <p>132x53x14mm</p>
	<p>R017112 NO. 5851946 - 93177469</p> <p>TUBO DA VALVULA REGULADORA DE VELOCIDADE</p> <p>OPEL ASTRA H (A04): 1.3 CDTi (L48) 08.2005/10.2010 66KW 90CV 1248CC - OPEL ASTRA H GTC (A04): 1.3 CDTi (L08) 04.2005/10.2010 66KW 90CV 1248CC - OPEL ASTRA H Combi (A04): 1.3 CDTi (L35) 08.2005/10.2010 66KW 90CV 1248CC - OPEL ASTRA H Caixa/Combi (L70): 1.3 CDTi (L70) 08.2005/10.2010 66KW 90CV 1248CC</p> <p>B133-14/14mm 39x64x29x51mm</p>		<p>R019213 NO. 55245385</p> <p>TUBO EXTRATOR COMBUSTIVEL</p> <p>OPEL ASTRA H (A04): 1.3 CDTi (L48) 08.2005/10.2010 66KW 90CV 1248CC - OPEL ASTRA H GTC (A04): 1.3 CDTi (L08) 04.2005/10.2010 66KW 90CV 1248CC - OPEL ASTRA H Combi (A04): 1.3 CDTi (L35) 08.2005/10.2010 66KW 90CV 1248CC - OPEL ASTRA H Caixa/Combi (L70): 1.3 CDTi (L70) 08.2005/10.2010 66KW 90CV 1248CC</p> <p>B-340/3mm 4p-d5x10mm</p>
	<p>R221424 NO. 13165972 - 1337745</p> <p>TUBO SUPERIOR DO RADIADOR</p> <p>OPEL ASTRA H (A04): 1.3 CDTi (L48) 08.2005/10.2010 66KW 90CV 1248CC - OPEL ASTRA H GTC (A04): 1.3 CDTi (L08) 04.2005/10.2010 66KW 90CV 1248CC - OPEL ASTRA H três volumes (A04): 1.3 CDTi (L69) 02.2007/10.2010 66KW 90CV 1248CC - OPEL ASTRA H Combi (A04): 1.3 CDTi (L35) 08.2005/10.2010 66KW 90CV 1248CC - OPEL ASTRA H Caixa/Combi (L70): 1.3 CDTi (L70) 08.2005/10.2010 66KW 90CV 1248CC</p> <p>B286-29/33mm 85x70x87x76x102x90x110mm</p>		<p>R221426 NO. 13150294 - 1337727</p> <p>TUBO SUPERIOR RADIADOR</p> <p>OPEL ASTRA H (A04) 1.7 CDTi (L48) 03.2004/10.2010 74KW 100CV 1686CC Z 17 DTH 0035032 0035AMG 0035ACW - OPEL ASTRA H Combi (A04) 1.7 CDTi (L35) 08.2004/10.2010 74KW 101CV 1686CC Z 17 DTH 0035ADI 0035047 0035ADJ - OPEL ASTRA H GTC (A04) 1.7 CDTi (L08) 03.2005/10.2010 74KW 101CV 1686CC Z 17 DTH 0035ADZ 0035561 0035550</p> <p>B350-32/32mm 52-64-51-106-41mm</p>
	<p>R221428 NO. 13126139 - 1337720</p> <p>TUBO SUPERIOR RADIADOR</p> <p>OPEL ASTRA H (A04) 1.2 (L48) 08.2005/10.2010 59KW 80CV 1229CC Z 12 XEP - OPEL ASTRA H (A04) 1.4 (L48) 03.2004/10.2010 66KW 90CV 1364CC Z 14 XEP 0035031 0035ALS 0035ADB - OPEL ASTRA H (A04) 1.4 (L48) 04.2004/10.2004 55KW 75CV 1364CC Z 14 XEL 0035036 0035ADA - OPEL ASTRA H (A04) 1.4 LPG (L48) 08.2009/10.2010 66KW 90CV 1364CC Z 14 XEP 0035AKK 0035AMM - OPEL ASTRA H Combi (A04) 1.4 (L35) 08.2004/10.20...</p> <p>B180-32/33mm 53x58x53mm</p>		<p>R221438 NO. 121-112-72mm ch-d19-83-150-111-310</p> <p>TUBO INFERIOR DO RADIADOR</p> <p>OPEL ASTRA H (A04) 1.3 CDTi (L48) (De 08-2005 Até 10-2010) 66kW 90CV 1248cc Hatchback OPEL ASTRA H GTC (A04) 1.3 CDTi (L08) (De 04-2005 Até 10-2010) 66kW 90CV 1248cc Hatchback OPEL ASTRA H Combi (A04) 1.3 CDTi (L35) (De 08-2005 Até 10-2010) 66kW 90CV 1248cc Combi OPEL ASTRA H Caixa (L70) 1.3 CDTi (L70) (De 08-2005 Até 10-2010) 66kW 90CV 1248cc Caixa</p> <p>B250-28/34mm 121-112-72mm ch-d19-83-150-111-310-105-44-54</p>
	<p>R221440 NO. 137-117-37mm ch-d19-55-350-233-46-</p> <p>TUBO INFERIOR RADIADOR</p> <p>OPEL ASTRA H (A04) 1.7 CDTi (L48) 03.2004/10.2010 74KW 100CV 1686CC Z 17 DTH 0035032 0035AMG 0035ACW - OPEL ASTRA H Combi (A04) 1.7 CDTi (L35) 08.2004/10.2010 74KW 101CV 1686CC Z 17 DTH 0035ADI 0035047 0035ADJ - OPEL ASTRA H GTC (A04) 1.7 CDTi (L08) 03.2005/10.2010 74KW 101CV 1686CC Z 17 DTH 0035ADZ 0035561 0035550</p> <p>B305-34/34mm 137-117-37mm ch-d19-55-350-233-46-39</p>		<p>R221442 NO. 58x87x95x104x119x72x59x46x123x71mm</p> <p>TUBO INFERIOR DO RADIADOR</p> <p>OPEL ASTRA H (A04) 1.4 (L48) (De 03.2004 Até 10.2010) 66kW 90cv 1364cm3 Hatchback - OPEL ASTRA H (A04) 1.4 LPG (L48) (De 08.2009 Até 10.2010) 66kW 90cv 1364cm3 Hatchback - OPEL ASTRA H Combi (A04) 1.4 (L35) (De 08.2004 Até 10.2010) 66kW 90cv 1364cm3 Combi OPEL ASTRA H GTC (A04) 1.4 (L08) (De 03.2005 Até 10.2010) 66kW 90cv 1364cm3 Hatchback -</p> <p>B655-30/39mm 58x87x95x104x119x72x59x46x123x71mm ch-d19</p>
	<p>R221727 NO. 13128923 - 6336120</p> <p>TUBO LIGAÇÃO TERMOSTATO AO DEPÓSITO EXPANSÃO</p> <p>OPEL ASTRA H (A04) 1.3 CDTi (L48) 08.2005/10.2010 66KW 90CV 1248CC Z 13 DTH 0035541 0035AMF 0035ACU - OPEL ASTRA H Combi (A04) 1.3 CDTi (L35) 08.2005/10.2010 66KW 90CV 1248CC Z 13 DTH 0035542 0035ADG - OPEL ASTRA H GTC (A04) 1.3 CDTi (L08) 04.2005/10.2010 66KW 90CV 1248CC Z 13 DTH 0035AEI 0035556 0035567</p> <p>B260-7/7mm 31x66x85x37x32mm</p>		<p>R221729 NO. 13184738 - 1337743</p> <p>TUBO LIGAÇÃO DEPÓSITO EXPANSÃO AO RADIADOR</p> <p>OPEL ASTRA H (A04) 1.3 CDTi (L48) (De 2005.08 Até 2010.10) 66kW 90cv 1248cm3 Hatchback - OPEL ASTRA H GTC (A04) 1.3 CDTi (L08) (De 2005.04 Até 2010.10) 66kW 90cv 1248cm3 Hatchback - OPEL ASTRA H Combi (A04) 1.3 CDTi (L35) (De 2005.08 Até 2010.10) 66kW 90cv 1248cm3 Combi - OPEL ASTRA H Caixa (L70) 1.3 CDTi (L70) (De 2005.08 Até 2010.10) 66kW 90cv 1248cm3 Caixa -</p> <p>B560-7/11mm 30x38x81x59x89x44x85x96x37mm</p>

	R221743 NO. 055351522 - 05656121 - 0656092 - 55578995 - 5656121 - 656092 TUBO RESPIRO DO CARTER CAMBOTA OPEL ASTRA H (A04) 1.2 (L48) (08.2005 - 10.2010) 59kw 80cv 1229cm3 Hatchback OPEL ASTRA H (A04) 1.4 (L48) (04.2004 - 10.2004) 55kw 75cv 1364cm3 Hatchback OPEL ASTRA H (A04) 1.4 (L48) (03.2004 - 10.2010) 66kw 90cv 1364cm3 Hatchback OPEL ASTRA H (A04) 1.4 LPG (L48) (08.2009 - 10.2010) 66kw 90cv 1364cm3 Hatchback boca a boca175mmd1-15mmx25mm75-73		R221743 NO. 055351522 - 05656121 - 0656092 - 55578995 - 5656121 - 656092 TUBO RESPIRO DO CARTER CAMBOTA OPEL ASTRA H Combi (A04) 1.4 (L35) (08.2004 - 10.2010) 55kw 75cv 1364cm3 Combi OPEL ASTRA H Combi (A04) 1.4 (L35) (08.2004 - 10.2010) 66kw 90cv 1364cm3 Combi OPEL ASTRA H Combi (A04) 1.4 LPG (L35) (08.2009 - 10.2010) 66kw 90cv 1364cm3 Combi boca a boca175mmd1-15mmx25mm75-73
	R221743 NO. 055351522 - 05656121 - 0656092 - 55578995 - 5656121 - 656092 TUBO RESPIRO DO CARTER CAMBOTA OPEL ASTRA H GTC (A04) 1.4 (L08) (03.2005 - 10.2010) 55kw 75cv 1364cm3 Hatchback OPEL ASTRA H GTC (A04) 1.4 (L08) (03.2005 - 10.2010) 66kw 90cv 1364cm3 Hatchback boca a boca175mmd1-15mmx25mm75-73		R221748 NO. 5851946 - 93177469 TUBO DA VALVULA REGULADORA DE VELOCIDADE OPEL ASTRA H (A04) 1.3 CDTI (L48) 08.2005/10.2010 66KW 90CV 1248CC Z 13 DTH 0035541 0035AMF 0035ACU - OPEL ASTRA H Combi (A04) 1.3 CDTI (L35) 08.2005/10.2010 66KW 90CV 1248CC Z 13 DTH 0035542 0035ADG - OPEL ASTRA H GTC (A04) 1.3 CDTI (L08) 04.2005/10.2010 66KW 90CV 1248CC Z 13 DTH 0035AEI 0035556 0035567 B140-17/17mm 70x30x80x35mm
	R222749 NO. 055353829 - 06302612 - 1302574 - 55353831 - 55557037 - 6302611 TUBO DO AR SOBRELIMENTAÇÃO OPEL ASTRA H (A04) 1.9 CDTI (L48) (09.2005 - 10.2010) 74kw 100cv 1910cm3 Hatchback OPEL ASTRA H (A04) 1.9 CDTI (L48) (06.2004 - 10.2010) 88kw 120cv 1910cm3 Hatchback OPEL ASTRA H (A04) 1.9 CDTI (L48) (09.2004 - 10.2010) 110kw 150cv 1910cm3 Hatchback boca a boca253mmd1-39mmx253mm60-47		R222749 NO. 055353829 - 06302612 - 1302574 - 55353831 - 55557037 - 6302611 TUBO DO AR SOBRELIMENTAÇÃO OPEL ASTRA H Combi (A04) 1.9 CDTI (L35) (09.2005 - 10.2010) 88kw 120cv 1910cm3 Combi OPEL ASTRA H Combi (A04) 1.9 CDTI (L35) (09.2004 - 10.2010) 110kw 150cv 1910cm3 Combi boca a boca253mmd1-39mmx253mm60-47
	R222749 NO. 055353829 - 06302612 - 1302574 - 55353831 - 55557037 - 6302611 TUBO DO AR SOBRELIMENTAÇÃO OPEL ASTRA H GTC (A04) 1.9 CDTI (L08) (09.2005 - 10.2010) 88kw 120cv 1910cm3 Hatchback OPEL ASTRA H GTC (A04) 1.9 CDTI (L08) (03.2005 - 10.2010) 110kw 150cv 1910cm3 Hatchback boca a boca253mmd1-39mmx253mm60-47		R222749 NO. 055353829 - 06302612 - 1302574 - 55353831 - 55557037 - 6302611 TUBO DO AR SOBRELIMENTAÇÃO OPEL ASTRA H TwinTop (A04) 1.9 CDTI (L67) (09.2005 - 10.2010) 110kw 150cv 1910cm3 Cabriolet boca a boca253mmd1-39mmx253mm60-47
	R222796 NO. 13128921 - 6818587 TUBO SUPERIOR RADIADOR OPEL ASTRA H (A04) 1.3 CDTI (L48) (De 08-2005 Até 10-2010) 66kW 90CV 1248cc Hatchback OPEL ASTRA H GTC (A04) 1.3 CDTI (L08) (De 04-2005 Até 10-2010) 66kW 90CV 1248cc Hatchback OPEL ASTRA H Combi (A04) 1.3 CDTI (L35) (De 08-2005 Até 10-2010) 66kW 90CV 1248cc Combi OPEL ASTRA H Caixa (L70) 1.3 CDTI (L70) (De 08-2005 Até 10-2010) 66kW 90CV 1248cc Caixa B257-18/22mm 50-37-57-45-27mm		R222797 NO. 13128922 - 6818587 TUBO SUPERIOR RADIADOR OPEL ASTRA H (A04) 1.3 CDTI (L48) (De 08-2005 Até 10-2010) 66kW 90CV 1248cc Hatchback OPEL ASTRA H GTC (A04) 1.3 CDTI (L08) (De 04-2005 Até 10-2010) 66kW 90CV 1248cc Hatchback OPEL ASTRA H Combi (A04) 1.3 CDTI (L35) (De 08-2005 Até 10-2010) 66kW 90CV 1248cc Combi OPEL ASTRA H Caixa (L70) 1.3 CDTI (L70) (De 08-2005 Até 10-2010) 66kW 90CV 1248cc Caixa B255-18/23mm 59-77-47-32mm
	R222798 NO. 13118275 TUBO SUPERIOR RADIADOR OPEL ASTRA H (A04) 1.6 (L48) (De 03-2004 Até 10-2010) 77kW 105CV 1598cc Hatchback OPEL ASTRA H GTC (A04) 1.6 (L08) (De 03-2005 Até 10-2010) 77kW 105CV 1598cc Hatchback OPEL ASTRA H Combi (A04) 1.6 (L35) (De 08-2004 Até 10-2010) 77kW 105CV 1598cc Combi OPEL ASTRA H TwinTop (A04) 1.6 (L67) (De 09-2005 Até 10-2010) 77kW 105CV 1598cc Cabriolet B320-18/23mm 96-75-75-40mm		R222827 NO. 6336084 - 97300149 TUBO LIGAÇÃO TERMOSTATO OPEL ASTRA H (A04) 1.7 CDTI (L48) (De 03-2004 Até 10-2010) 59kW 80CV 1686cc Hatchback OPEL ASTRA H (A04) 1.7 CDTI (L48) (De 03-2004 Até 10-2010) 74kW 100CV 1686cc Hatchback OPEL ASTRA H GTC (A04) 1.7 CDTI (L08) (De 03-2005 Até 10-2010) 74kW 101CV 1686cc Hatchback OPEL ASTRA H Combi (A04) 1.7 CDTI (L35) (De 08-2004 Até 10-2010) 59kW 80CV 1686cc Combi OPEL ASTRA H Combi (A04) 1.7 CDTI (L35) (De 08-2004 Até 10-2010) 74kW 100CV 1686cc Combi B115-15/15mm 39-45-39mm
	R222828 NO. 97351101 TUBO DO RADIADOR OPEL ASTRA H (A04) 1.7 CDTI (L48) (De 03-2004 Até 10-2010) 59kW 80CV 1686cc Hatchback OPEL ASTRA H (A04) 1.7 CDTI (L48) (De 03-2004 Até 10-2010) 74kW 100CV 1686cc Hatchback OPEL ASTRA H GTC (A04) 1.7 CDTI (L08) (De 03-2005 Até 10-2010) 74kW 101CV 1686cc Hatchback OPEL ASTRA H Combi (A04) 1.7 CDTI (L35) (De 08-2004 Até 10-2010) 59kW 80CV 1686cc Combi OPEL ASTRA H Combi (A04) 1.7 CDTI (L35) (De 08-2004 Até 10-2010) 74kW 100CV 1686cc Combi B165-13/13mm 34-41-47-51mm		R222835 NO. 0835542 - 13251949 - 55355059 - 55561450 - 5835878 - 5835929 - 835542 TUBO LIGAÇÃO FILTRO DE AR OPEL ASTRA H (A04) 1.3 CDTI (L48) 08.2005/10.2010 66KW 90CV 1248CC Z 13 DTH 0035541 0035AMF 0035ACU - OPEL ASTRA H Caixa/Combi (L70) 1.3 CDTI (L70) 08.2005/10.2010 66KW 90CV 1248CC Z 13 DTH 0035AQJ - OPEL ASTRA H Combi (A04) 1.3 CDTI (L35) 08.2005/10.2010 66KW 90CV 1248CC Z 13 DTH 0035542 0035ADG - OPEL ASTRA H GTC (A04) 1.3 CDTI (L08) 04.2005/10.2010 66KW 90CV 1248CC Z 13 DTH 0035AEI 0035556 0035556... B104-33/41mm 56-90mm
	R222836 NO. 055350898 - 0836176 - 55350898 - 55350899 - 55559222 - 835645 - 836176 TUBO LIGAÇÃO FILTRO DE AR OPEL ASTRA H (A04) 1.3 CDTI (L48) 08.2005/10.2010 66KW 90CV 1248CC Z 13 DTH 0035541 0035AMF 0035ACU - OPEL ASTRA H Caixa/Combi (L70) 1.3 CDTI (L70) 08.2005/10.2010 66KW 90CV 1248CC Z 13 DTH 0035AQJ - OPEL ASTRA H Combi (A04) 1.3 CDTI (L35) 08.2005/10.2010 66KW 90CV 1248CC Z 13 DTH 0035542 0035ADG - OPEL ASTRA H GTC (A04) 1.3 CDTI (L08) 04.2005/10.2010 66KW 90CV 1248CC Z 13 DTH 0035AEI 0035556 0035556... B178-32/47mm 170-100-66-157		R222839 NO. 055556012 - 06302613 - 55556012 - 6302613 TUBO DO AR SOBREALIMENTAÇÃO OPEL ASTRA H (A04) 1.3 CDTI (L48) 08.2005/10.2010 66KW 90CV 1248CC Z 13 DTH 0035541 0035AMF 0035ACU - OPEL ASTRA H Caixa/Combi (L70) 1.3 CDTI (L70) 08.2005/10.2010 66KW 90CV 1248CC Z 13 DTH 0035AQJ - OPEL ASTRA H Combi (A04) 1.3 CDTI (L35) 08.2005/10.2010 66KW 90CV 1248CC Z 13 DTH 0035542 0035ADG - OPEL ASTRA H GTC (A04) 1.3 CDTI (L08) 04.2005/10.2010 66KW 90CV 1248CC Z 13 DTH 0035AEI 0035556 0035556... B385-42/42mm 51-56-270mm

	S1473 NO. 0352364 - 352364 - 90498738 SILENT BLOC DO BRAÇO SA SUSPENSÃO DA FRENTE OPEL ASTRA H 1.4 - GTC 1.4 - 1.6 - GTC 1.6 - 1.7 CDTi - GTC 1.7 CDTi - 1.8 - GTC 1.8 - 1.9CDTi - GTC 1.9CDTi - 2.0 TURBO - GTC 2.0 TURBO - (APOS 2004) - TWIN TOP 1.6 - 1.8 - 1.9CDTi - 2.0 TURBO (APOS 09-2005) d44x60mm d35mm 1f-d12mm		S1714 NO. 0302275 - 0302290 - 09223022 - 302275 - 302290 - 90498689 - 9223022 SILENT-BLOC DA SUSPENSÃO SUB-CHASSI DA FRENTE OPEL ASTRA H (A04) 1.4 (L48) (De 2004.04 Até 2004.10) 55kW 75cv 1364cm3 Hatchback - OPEL ASTRA H (A04) 1.4 (L48) (De 2004.03 Até 2010.10) 66kW 90cv 1364cm3 Hatchback - OPEL ASTRA H (A04) 1.4 LPG (L48) (De 2009.08 Até 2010.10) 66kW 90cv 1364cm3 Hatchback - OPEL ASTRA H (A04) 1.6 (L48) (De 2004.03 Até 2010.10) 77kW 105cv 1598cm3 Hatchback - OPEL ASTRA H (A04) 1.6 (L48) (De 2009.08 Até 2010.10) 66kW 90cv 1364cm3 Hatchback - d44x60mm d35mm 1f-d12mm
	S1715 NO. 0302067 - 13107328 - 302067 SILENT-BLOC DA SUSPENSÃO SUB-CHASSI FRENTE OPEL ASTRA H TwinTop (A04) 2.0 Turbo (L67) (De 2005.09 Até 2010.10) 147kW 200cv 1998cm3 Cabriolet - OPEL ASTRA H TwinTop (A04) 1.9 CDTi (L67) (De 2005.09 Até 2010.10) 110kW 150cv 1910cm3 Cabriolet - OPEL ASTRA H Caixa (L70) 1.3 CDTi (L70) (De 2005.08 Até 2010.10) 66kW 90cv 1248cm3 Caixa - OPEL ASTRA H Caixa (L70) 1.7 CDTi (L70) (De 2004.12 Até 2007.07) 59kW 80cv 1686cm3 C... d46x 35mm c-25mm dc-38mm1f-d14mm		S1978 NO. 0352324 SILENT-BLOC DO BRAÇO SUSPENSÃO FRENTE PARTE DE TRÁS OPEL ASTRA H (A04) 1.2 (L48) (De 08.2005 Até 10.2010) 59kW 80cv 1229cm3 Hatchback - OPEL ASTRA H (A04) 1.3 CDTi (L48) (De 08.2005 Até 10.2010) 66kW 90cv 1248cm3 Hatchback - OPEL ASTRA H (A04) 1.4 (L48) (De 04.2004 Até 10.2004) 55kW 75cv 1364cm3 Hatchback - OPEL ASTRA H (A04) 1.4 (L48) (De 03.2004 Até 10.2010) 66kW 90cv 1364cm3 Hatchback - OPEL ASTRA H (A04) 1.4 LPG (L48) (De 08.2009 Até 10.2010) 66kW 90cv 1364cm3 Hatchback - OPEL ASTRA H (A04) 1.4 LPG (L48) (De 08.2009 Até 10.2010) 6... d60x 59mm c-45mm dc-46mm1f-d12mm
	S1990 NO. 0402952 - 13110418 - 13267215 - 13267216 - 402952 - 5402637 - 5402639 SILENT-BLOC DO EIXO DA SUSPENSÃO DE TRÁS DIREITO E ESQUERDO OPEL ASTRA H (A04) 1.2 (L48) (De 08.2005 Até 10.2010) 59kW 80cv 1229cm3 Hatchback - OPEL ASTRA H (A04) 1.3 CDTi (L48) (De 08.2005 Até 10.2010) 66kW 90cv 1248cm3 Hatchback - OPEL ASTRA H (A04) 1.4 (L48) (De 03.2004 Até 10.2010) 66kW 90cv 1364cm3 Hatchback - OPEL ASTRA H (A04) 1.4 LPG (L48) (De 08.2009 Até 10.2010) 66kW 90cv 1364cm3 Hatchback - OPEL ASTRA H (A04) 1.6 (L48) (De 03.2004 Até 10.2010) 7... d85x 90mm c-55mm dc-70mm1f-d13mm		T0739-I NO. 13173321 - 22697919 - 24411014 - 90095608 - 90216605 - 90216613 - 90250393 BATENTE APOIO DE SUSPENSÃO TRÁS (GASTA 2 UNIDADES) OPEL ASTRA H (A04) 1.2 (L48) (De 08.2005 Até 10.2010) 59kW 80cv 1229cm3 Hatchback - OPEL ASTRA H (A04) 1.3 CDTi (L48) (De 08.2005 Até 10.2010) 66kW 90cv 1248cm3 Hatchback - OPEL ASTRA H (A04) 1.4 (L48) (De 04.2004 Até 10.2004) 55kW 75cv 1364cm3 Hatchback - OPEL ASTRA H (A04) 1.4 (L48) (De 03.2004 Até 10.2010) 66kW 90cv 1364cm3 Hatchback - OPEL ASTRA H (A04) 1.4 LPG (L48) (De 08.2009 Até 10.2010) 6... d126x49mm 1f-d15mm
	U0314 NO. 0424761 ANILHA DA SUSPENSÃO DAS MOLAS DE TRÁS INFERIOR OPEL ASTRA H (A04) 1.2 (L48) (08.2005 - 10.2010) 59kw 80cv 1229cm3 Hatchback OPEL ASTRA H (A04) 1.3 CDTi (L48) (08.2005 - 10.2010) 66kw 90cv 1248cm3 Hatchback OPEL ASTRA H (A04) 1.4 (L48) (04.2004 - 10.2004) 55kw 75cv 1364cm3 Hatchback OPEL ASTRA H (A04) 1.4 (L48) (03.2004 - 10.2010) 66kw 90cv 1364cm3 Hatchback OPEL ASTRA H (A04) 1.4 LPG (L48) (08.2009 - 10.2010) 66kw 90cv 1364cm3 Hatchback OPEL A... d132x22mm 1f-d33mm		U0314 NO. 0424761 ANILHA DA SUSPENSÃO DAS MOLAS DE TRÁS INFERIOR OPEL ASTRA H CLASSIC Combi (A04) 1.4 (L35) (01.2009 -) 66kw 90cv 1364cm3 Combi OPEL ASTRA H CLASSIC Combi (A04) 1.6 (L35) (12.2006 - 05.2014) 85kw 116cv 1598cm3 Combi OPEL ASTRA H CLASSIC Combi (A04) 1.7 CDTi (L35) (01.2009 -) 92kw 125cv 1686cm3 Combi OPEL ASTRA H CLASSIC Combi (A04) 1.7 CDTi (L35) (01.2009 -) 81kw 110cv 1686cm3 Combi d132x22mm 1f-d33mm
	U0314 NO. 0424761 ANILHA DA SUSPENSÃO DAS MOLAS DE TRÁS INFERIOR OPEL ASTRA H CLASSIC Hatchback (A04) 1.3 CDTi (L48) (01.2009 -) 66kw 90cv 1248cm3 Hatchback OPEL ASTRA H CLASSIC Hatchback (A04) 1.4 (L48) (01.2009 -) 66kw 90cv 1364cm3 Hatchback OPEL ASTRA H CLASSIC Hatchback (A04) 1.6 (L48) (01.2009 -) 85kw 116cv 1598cm3 Hatchback OPEL ASTRA H CLASSIC Hatchback (A04) 1.7 CDTi (L48) (01.2009 -) 81kw 110cv 1686cm3 Hatchback OPEL ASTRA H CLASSIC Hatchback (A04) 1.7... d132x22mm 1f-d33mm		U0314 NO. 0424761 ANILHA DA SUSPENSÃO DAS MOLAS DE TRÁS INFERIOR OPEL ASTRA H CLASSIC três volumes (A04) 1.6 (L69) (01.2009 - 05.2014) 85kw 116cv 1598cm3 três volumes OPEL ASTRA H CLASSIC três volumes (A04) 1.7 CDTi (L69) (01.2009 -) 92kw 125cv 1686cm3 três volumes OPEL ASTRA H CLASSIC três volumes (A04) 1.7 CDTi (L69) (01.2009 -) 81kw 110cv 1686cm3 três volumes OPEL ASTRA H CLASSIC três volumes (A04) 1.8 (L69) (02.2007 - 09.2012) 103kw 140cv 1796cm3 três volum... d132x22mm 1f-d33mm
	U0314 NO. 0424761 ANILHA DA SUSPENSÃO DAS MOLAS DE TRÁS INFERIOR OPEL ASTRA H Caixa/Combi (L70) 1.3 CDTi (L70) (08.2005 - 10.2010) 66kw 90cv 1248cm3 Caixa/Combi OPEL ASTRA H Caixa/Combi (L70) 1.6 EcoTec (L70) (02.2004 - 11.2004) 76kw 103cv 1598cm3 Caixa/Combi OPEL ASTRA H Caixa/Combi (L70) 1.6 EcoTec (L70) (10.2006 - 12.2010) 85kw 116cv 1598cm3 Caixa/Combi OPEL ASTRA H Caixa/Combi (L70) 1.7 CDTi (L70) (12.2004 - 07.2007) 59kw 80cv 1686cm3 Caixa/Combi OPEL ASTRA... d132x22mm 1f-d33mm		U0314 NO. 0424761 ANILHA DA SUSPENSÃO DAS MOLAS DE TRÁS INFERIOR OPEL ASTRA H GTC (A04) 1.3 CDTi (L08) 04.2005 - 10.2010 66kw 90cv 1248cm3 Hatchback OPEL ASTRA H GTC (A04) 1.4 (L08) 03.2005 - 10.2010 55kw 75cv 1364cm3 Hatchback OPEL ASTRA H GTC (A04) 1.4 (L08) 03.2005 - 10.2010 66kw 90cv 1364cm3 Hatchback OPEL ASTRA H GTC (A04) 1.6 (L08) 03.2005 - 10.2010 77kw 105cv 1598cm3 Hatchback OPEL ASTRA H GTC (A04) 1.6 (L08) 12.2006 - 10.2010 85kw 116cv 1598cm3 Hatchbac... d132x22mm 1f-d33mm
	U0314 NO. 0424761 ANILHA DA SUSPENSÃO DAS MOLAS DE TRÁS INFERIOR OPEL ASTRA H TwinTop (A04) 1.6 (L67) (09.2005 - 10.2010) 77kw 105cv 1598cm3 Cabriolet OPEL ASTRA H TwinTop (A04) 1.6 (L67) (12.2006 - 10.2010) 85kw 116cv 1598cm3 Cabriolet OPEL ASTRA H TwinTop (A04) 1.6 Turbo (L67) (02.2007 - 10.2010) 132kw 180cv 1598cm3 Cabriolet OPEL ASTRA H TwinTop (A04) 1.8 (L67) (09.2005 - 10.2010) 92kw 125cv 1796cm3 Cabriolet OPEL ASTRA H TwinTop (A04) 1.8 (L67) (09.2005 - 1... d132x22mm 1f-d33mm		U0314 NO. 0424761 ANILHA DA SUSPENSÃO DAS MOLAS DE TRÁS INFERIOR OPEL ASTRA H três volumes (A04) 1.3 CDTi (L69) (02.2007 - 10.2010) 66kw 90cv 1248cm3 três volumes OPEL ASTRA H três volumes (A04) 1.4 (L69) (02.2007 - 06.2010) 66kw 90cv 1364cm3 três volumes OPEL ASTRA H três volumes (A04) 1.6 (L69) (02.2007 - 06.2010) 77kw 105cv 1598cm3 três volumes OPEL ASTRA H três volumes (A04) 1.6 (L69) (02.2007 - 05.2014) 85kw 116cv 1598cm3 três volumes OPEL ASTRA H três vol... d132x22mm 1f-d33mm
	UAP81292 NO. 0821038 - 0821074 - 0821437 - 0821675 - 4708869 - 4809347 - 821038 - 821074 - 821437 - 821675 ANILHA PROTEÇÃO TÉRMICA INJECTORES OPEL ASTRA H (A04) 1.3 CDTi (L48) (De 08-2005 Até 10-2010) 66kW 90CV 1248cc Hatchback OPEL ASTRA H GTC (A04) 1.3 CDTi (L08) (De 04-2005 Até 10-2010) 66kW 90CV 1248cc Hatchback OPEL ASTRA H Combi (A04) 1.3 CDTi (L35) (De 08-2005 Até 10-2010) 66kW 90CV 1248cc Combi OPEL ASTRA H Caixa (L70) 1.3 CDTi (L70) (De 08-2005 Até 10-2010) 66kW 90CV 1248cc Caixa d16x1mm 1f-d7mm		UAP81292 NO. 0821038 - 0821074 - 0821437 - 0821675 - 4708869 - 4809347 - 821038 - 821074 - 821437 - 821675 ANILHA PROTEÇÃO TÉRMICA INJECTORES OPEL ASTRA H (A04) 1.3 CDTi (L48) (De 08-2005 Até 10-2010) 66kW 90CV 1248cc Hatchback OPEL ASTRA H GTC (A04) 1.3 CDTi (L08) (De 04-2005 Até 10-2010) 66kW 90CV 1248cc Hatchback OPEL ASTRA H Combi (A04) 1.3 CDTi (L35) (De 08-2005 Até 10-2010) 66kW 90CV 1248cc Combi OPEL ASTRA H Caixa (L70) 1.3 CDTi (L70) (De 08-2005 Até 10-2010) 66kW 90CV 1248cc Caixa d16x1mm 1f-d7mm

	<p>UCRZ1057 NO. 0905122</p> <p>CRUZETA VEIO DIREÇÃO D15X38MM</p> <p>OPEL ASTRA H (A04) 1.2 (L48) (De 08.2005 Até 10.2010) 59kW 80cv 1229cm3 Hatchback - OPEL ASTRA H (A04) 1.3 CDTI (L48) (De 08.2005 Até 10.2010) 66kW 90cv 1248cm3 Hatchback - OPEL ASTRA H (A04) 1.4 (L48) (De 04.2004 Até 10.2004) 55kW 75cv 1364cm3 Hatchback - OPEL ASTRA H (A04) 1.4 (L48) (De 03.2004 Até 10.2010) 66kW 90cv 1364cm3 Hatchback - OPEL ASTRA H (A04) 1.4 LPG (L48) (De 08.2009 Até 10.2010) 6...</p> <p>d15x28x41mm</p>		<p>UCRZ1096 NO. 0374365 - 0374415 - 0374489 - 0374576 - 0374579 - 0374649 - 0374916 - 13250828 - 13250832 - 13271554...</p> <p>CRUZETA TRANSMISSÃO TRIPOIDE D40MM/23 DENTES</p> <p>OPEL ASTRA H (A04) 1.8 (L48) 01.2004/10.2010 92KW 125CV 1796CC Z 18 XE 0035034 0035ADD - OPEL ASTRA H (A04) 1.8 (L48) 01.2006/10.2010 103KW 140CV 1796CC A 18 XER Z 18 XER 0035AAZ 0035AMD - OPEL ASTRA H CLASSIC três volumes (A04) ASTRA H FAMILY 1.8 (L69) 02.2007/09.2012 103KW 140CV 1796CC Z 18 XER - OPEL ASTRA H Combi (A04) 1.8 (L35) 08.2004/10.2010 92KW 125CV 1796CC Z 18 XE 0035ADT 0035ADU 00350...</p> <p>d40mm (23 dentes)</p>
	<p>UMB84019 NO. 2060668</p> <p>TAMPÃO BLOCO MOTOR</p> <p>OPEL ASTRA H (A04) 1.8 (L48) (De 01-2004 Até 10-2010) 92kW 125CV 1796cc Hatchback OPEL ASTRA H GTC (A04) 1.8 (L08) (De 03-2005 Até 10-2010) 92kW 125CV 1796cc Hatchback OPEL ASTRA H Combi (A04) 1.8 (L35) (De 08-2004 Até 10-2010) 92kW 125CV 1796cc Combi OPEL ASTRA H TwinTop (A04) 1.8 (L67) (De 09-2005 Até 10-2010) 92kW 125CV 1796cc Cabriolet</p> <p>d-26x9,5mm di-23,3mm</p>		<p>UMB84019L NO. 2060668</p> <p>TAMPÃO BLOCO DE MOTOR (RELAS)</p> <p>OPEL ASTRA H (A04) 1.8 (L48) (De 01-2004 Até 10-2010) 92kW 125CV 1796cc Hatchback OPEL ASTRA H GTC (A04) 1.8 (L08) (De 03-2005 Até 10-2010) 92kW 125CV 1796cc Hatchback OPEL ASTRA H Combi (A04) 1.8 (L35) (De 08-2004 Até 10-2010) 92kW 125CV 1796cc Combi OPEL ASTRA H TwinTop (A04) 1.8 (L67) (De 09-2005 Até 10-2010) 92kW 125CV 1796cc Cabriolet</p> <p>d-26x9,5mm di-23,3mm</p>
	<p>UMB84021 NO. 2060673</p> <p>TAMPÃO BLOCO MOTOR</p> <p>OPEL ASTRA H (A04) 1.8 (L48) (De 01-2004 Até 10-2010) 92kW 125CV 1796cc Hatchback OPEL ASTRA H GTC (A04) 1.8 (L08) (De 03-2005 Até 10-2010) 92kW 125CV 1796cc Hatchback OPEL ASTRA H Combi (A04) 1.8 (L35) (De 08-2004 Até 10-2010) 92kW 125CV 1796cc Combi OPEL ASTRA H TwinTop (A04) 1.8 (L67) (De 09-2005 Até 10-2010) 92kW 125CV 1796cc Cabriolet</p> <p>d-28x7mm di-25,6mm</p>		<p>UMB84021L NO. 2060673</p> <p>TAMPÃO BLOCO DE MOTOR (RELAS)</p> <p>OPEL ASTRA H (A04) 1.8 (L48) (De 01-2004 Até 10-2010) 92kW 125CV 1796cc Hatchback OPEL ASTRA H GTC (A04) 1.8 (L08) (De 03-2005 Até 10-2010) 92kW 125CV 1796cc Hatchback OPEL ASTRA H Combi (A04) 1.8 (L35) (De 08-2004 Até 10-2010) 92kW 125CV 1796cc Combi OPEL ASTRA H TwinTop (A04) 1.8 (L67) (De 09-2005 Até 10-2010) 92kW 125CV 1796cc Cabriolet</p> <p>d-28x7mm di-25,6mm</p>
	<p>UMB84026L NO. 11056093 - 2060665</p> <p>TAMPÃO BLOCO DE MOTOR (RELAS)</p> <p>OPEL ASTRA H</p> <p>d-34x13mm di-31,2mm</p>		<p>UMB84029 NO. 2060946</p> <p>TAMPÃO BLOCO MOTOR</p> <p>OPEL ASTRA H (A04) 1.6 (L48) (03.04 A 10.10) 105cv 1598cc Hatchback - OPEL ASTRA H TwinTop (A04) 2.0 Turbo (L67) (09.05 A 10.10) 200cv 1998cc Cabriolet</p> <p>d36x10mm di-32mm</p>
	<p>UMV25436 NO. 55351706 - H55351706</p> <p>MANETE PUNHO TOPO ALAVANCA MUDANÇAS C/ ASTE 5 VELOCIDADES</p> <p>OPEL ASTRA H GTC (A04) 1.3 CDTI (L08) 04.2005/10.2010 66KW 90CV 1248CC Z 13 DTH 0035AEI 0035556 0035567</p> <p>d51x203mm</p>		<p>UMV25437 NO. 55351706 - H55351706</p> <p>MANETE PUNHO TOPO ALAVANCA MUDANÇAS C/ ASTE 6 VELOCIDADES</p> <p>OPEL ASTRA H GTC (A04) 1.3 CDTI (L08) 04.2005/10.2010 66KW 90CV 1248CC Z 13 DTH 0035AEI 0035556 0035567</p> <p>d51x203mm</p>
	<p>UMV26807 NO. 5738025 - 5738036P - 738536P - 93180984 - 5738036 - 55354140 - 55568376 - 738536 - 5555718 - 5556836...</p> <p>MANETE PUNHO TOPO ALAVANCA MUDANÇAS 5 VELOCIDADES F12MM</p> <p>OPEL ASTRA-H 2004 1.4 75HP 55kW Hatchback Z14XEL - OPEL ASTRA-H 2004/2010 1.4 90HP 66kW Hatchback Z14XEP - OPEL ASTRA-H 2004/2010 1.6 105HP 77kW Hatchback Z16XEP - OPEL ASTRA-H 2004/2010 1.7 CDTI 100HP 74kW Hatchback Z17DTH - OPEL ASTRA-H 2004/2010 1.7 CDTI 101HP 74kW KUTU Z17DTH - OPEL ASTRA-H 2004/2010 1.7 CDTI 80HP 59kW Hatchback Z17DTL - OPEL ASTRA-H 2004/2010 1.8 125HP 92kW Hatchback Z18XE - ...</p> <p>d52x88mm 1f-d12mm</p>		<p>UMV26812 NO. 5738040 - 93185666</p> <p>MANETE PUNHO TOPO ALAVANCA MUDANÇAS 6 VELOCIDADES F12MM</p> <p>OPEL ASTRA H (A04) 1.3 CDTI (L48) 08.2005/10.2010 66KW 90CV 1248CC Z 13 DTH 0035541 0035AMF 0035ACU - OPEL ASTRA H CLASSIC Hatchback (A04) 1.3 CDTI (L48) desde 01.2009 66KW 90CV 1248CC Z 13 DTH - OPEL ASTRA H três volumes (A04) 1.3 CDTI (L69) 02.2007/10.2010 66KW 90CV 1248CC Z 13 DTH 0035AIG</p> <p>d52x86mm 1f-d12mm</p>
	<p>UTR0817 NO. 21430-AX300 - 21430-AX600 - 21430AX30A - 4408066 - 7700805131 - 8200048024 - 91166192</p> <p>TAMPÃO RESERVATÓRIO LÍQUIDO REFRIGERAÇÃO</p> <p>OPEL ASTRA H (L48) 1.8 (01.06 A 10.10) 140cv 1796cc Hatchback - OPEL ASTRA H GTC (L08) 1.8 (01.06 A 10.10) 140cv 1796cc Hatchback - OPEL ASTRA H GTC (L08) 1.3 CDTI (04.05 A 10.10) 90cv 1248cc Hatchback - OPEL ASTRA H GTC (L08) 1.9 CDTI (01.06 A 10.10) 101cv 1910cc Hatchback - OPEL ASTRA H TwinTop (L67) 1.8 (09.05 A 10.10) 140cv 1796cc Cabriolet</p> <p>53x36mm 1f-d46x18mm</p>		<p>UTR0820 NO. 90352470 - 90409256 - 90409257 - 9041032690497472 - 90467473</p> <p>TAMPÃO RESERVATÓRIO LÍQUIDO REFRIGERAÇÃO</p> <p>OPEL ASTRA H (L 4 8) 1.4 (03.04 A 10.10) 90cv 1364cc Hatchback - OPEL ASTRA H Combi - (L 35) 1.4 (08.04 A 10.10) 90cv 1364cc Combi</p> <p>d62x23mm 1f-d53x12mm</p>
	<p>UTR0821 NO. 1304677 - 9202799</p> <p>TAMPÃO RESERVATÓRIO LÍQUIDO REFRIGERAÇÃO</p> <p>OPEL ASTRA H (L48) 1.4 (04.04 A 10.04) 75cv 1364cc Hatchback - OPEL ASTRA H (L48) 1.4 (03.04 A 10.10) 90cv 1364cc Hatchback - OPEL ASTRA H (L48) 1.4 LPG (08.09 A 10.10) 90cv 1364cc Hatchback - OPEL ASTRA H (L48) 1.6 (03.04 A 10.10) 105cv 1598cc Hatchback - OPEL ASTRA H (L48) 1.6 (12.06 A 05.14) 116cv 1598cc Hatchback - OPEL ASTRA H (L48) 1.6 Turbo (02.07 A 10.10) 180cv 1598cc Hatchback ...</p> <p>61x35mm 1f-d52x15mm</p>		<p>UTR1202 NO. 13118170 - 6450562</p> <p>TAMPÃO RESERVATÓRIO LAVA VIDROS</p> <p>OPEL ASTRA H (A04): 1.6 (L48) 03.2004/10.2010 77KW 105CV 1598CC - OPEL ASTRA H (A04): 1.6 (L48) 12.2006/05.2014 85KW 116CV 1598CC - OPEL ASTRA H (A04): 1.3 CDTI (L48) 08.2005/10.2010 66KW 90CV 1248CC - OPEL ASTRA H GTC (A04): 1.6 (L08) 03.2005/10.2010 77KW 105CV 1598CC - OPEL ASTRA H GTC (A04): 1.3 CDTI (L08) 04.2005/10.2010 66KW 90CV 1248CC - OPEL ASTRA H Combi (A04): 1.6 (L35) 08.2004/10.2010 77...</p> <p>50x35x7mm c133mm di-43x29mm</p>

	<p>UTR1300 NO. 00650090 - 05650831</p> <p>TAMPÃO RESERVATÓRIO DO ÓLEO</p> <p>OPEL ASTRA H (A04) 1.6 (L48) (De 03-2004 Até 10-2010) 77KW 105CV 1598cc Hatchback OPEL ASTRA H (A04) 1.6 (L48) (De 12-2006 Até 05-2014) 85KW 116CV 1598cc Hatchback OPEL ASTRA H GTC (A04) 1.6 (L08) (De 03-2005 Até 10-2010) 77KW 105CV 1598cc Hatchback OPEL ASTRA H Combi (A04) 1.6 (L35) (De 08-2004 Até 10-2010) 77KW 105CV 1598cc Combi OPEL ASTRA H TwinTop (A04) 1.6 Turbo (L67) (De 02-2007 Até 10-2010...</p> <p>d59x31mm d45x12mm</p>		<p>UTR1305 NO. 0650089 - 650089</p> <p>TAMPÃO DO RESERVATÓRIO ÓLEO</p> <p>OPEL ASTRA H (A04) 1.3 CDTI (L48) 08.2005/10.2010 66KW 90CV 1248CC Z 13 DTH 0035541 0035AMF 0035ACU - OPEL ASTRA H (A04) 1.4 (L48) 03.2004/10.2010 66KW 90CV 1364CC Z 14 XEP 0035031 0035ALS 0035ADB - OPEL ASTRA H (A04) 1.6 (L48) 03.2004/10.2010 77KW 105CV 1598CC Z 16 XE1 Z 16 XEP 0035033 0035ADC - OPEL ASTRA H (A04) 1.7 CDTI (L48) 03.2004/10.2010 59KW 80CV 1686CC Z 17 DTL 0035030 0035ACV - OPEL AST...</p> <p>d61x23mm d32x19mm</p>
	<p>UTR1305 NO. 0650089 - 650089</p> <p>TAMPÃO DO RESERVATÓRIO ÓLEO</p> <p>OPEL ASTRA H Combi (A04) 1.3 CDTI (L35) 08.2005/10.2010 66KW 90CV 1248CC Z 13 DTH 0035542 0035ADG - OPEL ASTRA H Combi (A04) 1.4 (L35) 08.2004/10.2010 66KW 90CV 1364CC Z 14 XEP 0035ADQ 0035041 0035ADP - OPEL ASTRA H Combi (A04) 1.6 (L35) 08.2004/10.2010 77KW 105CV 1598CC Z 16 XE1 Z 16 XEP 0035ADR 0035ADS 0035042 - OPEL ASTRA H Combi (A04) 1.7 CDTI (L35) 08.2004/10.2010 59KW 80CV 1686CC Z 17 DTL 00...</p> <p>d61x23mm d32x19mm</p>		<p>UTR1305 NO. 0650089 - 650089</p> <p>TAMPÃO DO RESERVATÓRIO ÓLEO</p> <p>OPEL ASTRA H GTC (A04) 1.3 CDTI (L08) 04.2005/10.2010 66KW 90CV 1248CC Z 13 DTH 0035AEI 0035556 0035567 - OPEL ASTRA H GTC (A04) 1.4 (L08) 03.2005/10.2010 66KW 90CV 1364CC Z 14 XEP 0035AED 0035557 0035546 - OPEL ASTRA H GTC (A04) 1.6 (L08) 03.2005/10.2010 77KW 105CV 1598CC Z 16 XE1 Z 16 XEP 0035AEE 0035558 0035547 - OPEL ASTRA H GTC (A04) 1.7 CDTI (L08) 03.2005/10.2010 74KW 101CV 1686CC Z 17 DTH 0...</p> <p>d61x23mm d32x19mm</p>
	<p>UTR1305 NO. 0650089 - 650089</p> <p>TAMPÃO DO RESERVATÓRIO ÓLEO</p> <p>OPEL ASTRA H TwinTop (A04) 1.6 (L67) 09.2005/10.2010 77KW 105CV 1598CC Z 16 XE1 Z 16 XEP 0035AAM - OPEL ASTRA H TwinTop (A04) 1.8 (L67) 09.2005/10.2010 92KW 125CV 1796CC Z 18 XE - OPEL ASTRA H TwinTop (A04) 1.8 (L67) 09.2005/10.2010 103KW 140CV 1796CC A 18 XER Z 18 XER 0035AAN - OPEL ASTRA H TwinTop (A04) 1.9 CDTI (L67) 09.2005/10.2010 110KW 150CV 1910CC Z 19 DTH 0035AAL - OPEL ASTRA H TwinTop (A0...</p> <p>d61x23mm d32x19mm</p>		<p>UVD21057 NO. 0905122 - 9223059</p> <p>VEIO DA DIREÇÃO</p> <p>OPEL ASTRA H (A04) 1.2 (L48) 08.2005/10.2010 59KW 80CV 1229CC Z 12 XEP - OPEL ASTRA H (A04) 1.3 CDTI (L48) 08.2005/10.2010 66KW 90CV 1248CC Z 13 DTH 0035541 0035AMF 0035ACU - OPEL ASTRA H (A04) 1.4 (L48) 03.2004/10.2010 66KW 90CV 1364CC Z 14 XEP 0035031 0035ALS 0035ADB - OPEL ASTRA H (A04) 1.4 (L48) 04.2004/10.2004 55KW 75CV 1364CC Z 14 XEL 0035036 0035ADA - OPEL ASTRA H (A04) 1.4 LPG (L48) 08.200...</p> <p>247x42x42mm 1r-d7mm 1r-d8mm</p>
	<p>UVD21057 NO. 0905122 - 9223059</p> <p>VEIO DA DIREÇÃO</p> <p>OPEL ASTRA H CLASSIC Combi (A04) 1.4 (L35) desde 01.2009 66KW 90CV 1364CC Z 14 XEP - OPEL ASTRA H CLASSIC Combi (A04) 1.6 (L35) 12.2006/05.2014 85KW 116CV 1598CC Z 16 XER - OPEL ASTRA H CLASSIC Combi (A04) 1.7 CDTI (L35) desde 01.2009 81KW 110CV 1686CC Z 17 DTJ - OPEL ASTRA H CLASSIC Combi (A04) 1.7 CDTI (L35) desde 01.2009 92KW 125CV 1686CC A 17 DTR Z 17 DTR - OPEL ASTRA H CLASSIC Hatchback (A0...</p> <p>247x42x42mm 1r-d7mm 1r-d8mm</p>		<p>UVD21057 NO. 0905122 - 9223059</p> <p>VEIO DA DIREÇÃO</p> <p>OPEL ASTRA H Caixa/Combi (L70) 1.3 CDTI (L70) 08.2005/10.2010 66KW 90CV 1248CC Z 13 DTH 0035AQJ - OPEL ASTRA H Caixa/Combi (L70) 1.6 EcoTec (L70) 02.2004/11.2004 76KW 103CV 1598CC Z 16 XEP - OPEL ASTRA H Caixa/Combi (L70) 1.6 EcoTec (L70) 10.2006/12.2010 85KW 116CV 1598CC Z 16 XER - OPEL ASTRA H Caixa/Combi (L70) 1.7 CDTI (L70) 03.2004/10.2010 74KW 101CV 1686CC Z 17 DTH 0035AQG - OPEL ASTRA H Caixa...</p> <p>247x42x42mm 1r-d7mm 1r-d8mm</p>
	<p>UVD21057 NO. 0905122 - 9223059</p> <p>VEIO DA DIREÇÃO</p> <p>OPEL ASTRA H Combi (A04) 1.3 CDTI (L35) 08.2005/10.2010 66KW 90CV 1248CC Z 13 DTH 0035542 0035ADG - OPEL ASTRA H Combi (A04) 1.4 (L35) 08.2004/10.2010 55KW 75CV 1364CC Z 14 XEL 0035040 0035ADN 0035ADO - OPEL ASTRA H Combi (A04) 1.4 (L35) 08.2004/10.2010 66KW 90CV 1364CC Z 14 XEP 0035ADQ 0035041 0035ADP - OPEL ASTRA H Combi (A04) 1.4 LPG (L35) 08.2009/10.2010 66KW 90CV 1364CC Z 14 XEP 0035ADQ 0035A...</p> <p>247x42x42mm 1r-d7mm 1r-d8mm</p>		<p>UVD21057 NO. 0905122 - 9223059</p> <p>VEIO DA DIREÇÃO</p> <p>OPEL ASTRA H GTC (A04) 1.3 CDTI (L08) 04.2005/10.2010 66KW 90CV 1248CC Z 13 DTH 0035AEI 0035556 0035567 - OPEL ASTRA H GTC (A04) 1.4 (L08) 03.2005/10.2010 55KW 75CV 1364CC Z 14 XEL 0035AEC 0035553 0035564 - OPEL ASTRA H GTC (A04) 1.4 (L08) 03.2005/10.2010 66KW 90CV 1364CC Z 14 XEP 0035AED 0035557 0035546 - OPEL ASTRA H GTC (A04) 1.6 (L08) 03.2005/10.2010 77KW 105CV 1598CC Z 16 XE1 Z 16 XEP 0035AEE...</p> <p>247x42x42mm 1r-d7mm 1r-d8mm</p>
	<p>UVD21057 NO. 0905122 - 9223059</p> <p>VEIO DA DIREÇÃO</p> <p>OPEL ASTRA H TwinTop (A04) 1.6 (L67) 09.2005/10.2010 77KW 105CV 1598CC Z 16 XE1 Z 16 XEP 0035AAM - OPEL ASTRA H TwinTop (A04) 1.6 (L67) 12.2006/10.2010 85KW 116CV 1598CC Z 16 XER 0035AHB - OPEL ASTRA H TwinTop (A04) 1.6 Turbo (L67) 02.2007/10.2010 132KW 180CV 1598CC Z 16 LET A 16 LET 0035AHC - OPEL ASTRA H TwinTop (A04) 1.8 (L67) 09.2005/10.2010 92KW 125CV 1796CC Z 18 XE - OPEL ASTRA H TwinTop (A0...</p> <p>247x42x42mm 1r-d7mm 1r-d8mm</p>		<p>UVD21057 NO. 0905122 - 9223059</p> <p>VEIO DA DIREÇÃO</p> <p>OPEL ASTRA H três volumes (A04) 1.3 CDTI (L69) 02.2007/10.2010 66KW 90CV 1248CC Z 13 DTH 0035AIG - OPEL ASTRA H três volumes (A04) 1.4 (L69) 02.2007/06.2010 66KW 90CV 1364CC Z 14 XEP - OPEL ASTRA H três volumes (A04) 1.6 (L69) 02.2007/06.2010 77KW 105CV 1598CC Z 16 XEP - OPEL ASTRA H três volumes (A04) 1.6 (L69) 02.2007/05.2014 85KW 116CV 1598CC Z 16 XER 0035AIH - OPEL ASTRA H três volumes (A04) 1...</p> <p>247x42x42mm 1r-d7mm 1r-d8mm</p>
	<p>UVD21057 NO. 0905122 - 9223059</p> <p>VEIO DA DIREÇÃO</p> <p>OPEL ZAFIRA A Veículo multiuso (T98) 1.6 (F75) 10.2003/06.2005 76KW 103CV 1598CC Z 16 XE - OPEL ZAFIRA A Veículo multiuso (T98) 1.6 16V (F75) 04.1999/06.2005 74KW 101CV 1598CC Z 16 XE X 16 XEL 0035373 - OPEL ZAFIRA A Veículo multiuso (T98) 1.6 CNG (F75) 09.2001/06.2005 71KW 97CV 1598CC Z 16 YNG 0035442 - OPEL ZAFIRA A Veículo multiuso (T98) 1.8 16V (F75) 04.1999/09.2000 85KW 116CV 1796CC X 18 XE1 ...</p> <p>247x42x42mm 1r-d7mm 1r-d8mm</p>		<p>W5054 NO. 0614150 - 5614438 - 614150 - 93177317 - 93194443</p> <p>POLIE DA CAMBOTA (6 PISTAS)</p> <p>OPEL ASTRA (H) 1.3 CDTI 16v APÓS 08-2005 - Mtr Z13DT(H) (90CV)</p> <p>d165mm d35mm</p>
	<p>W5080 NO. 5614441 - 5614442 - 97229044 - 97353964</p> <p>POLIE DA CAMBOTA (6 PISTAS)</p> <p>OPEL ASTRA H (A04) 1.7 CDTI (L48) 03.2004/10.2010 59KW 80CV 1686CC Z 17 DTL 0035030 0035ACV - OPEL ASTRA H (A04) 1.7 CDTI (L48) 03.2004/10.2010 74KW 100CV 1686CC Z 17 DTH 0035032 0035AMG 0035ACW - OPEL ASTRA H Caixa/Combi (L70) 1.7 CDTI (L70) 03.2004/10.2010 74KW 101CV 1686CC Z 17 DTH 0035AQG - OPEL ASTRA H Caixa/Combi (L70) 1.7 CDTI (L70) 12.2004/07.2007 59KW 80CV 1686CC Z 17 DTL - OPEL ASTRA H C...</p> <p>d152mm d48mm</p>		<p>W5082 NO. 0614426 - 5614444 - 614426 - 97251975 - 97361525</p> <p>POLIE DA CAMBOTA (6 PISTAS)</p> <p>OPEL ASTRA H (A04) 1.7 CDTI (L48) 03.2004/10.2010 74KW 100CV 1686CC Z 17 DTH 0035032 0035AMG 0035ACW - OPEL ASTRA H Combi (A04) 1.7 CDTI (L35) 08.2004/10.2010 74KW 101CV 1686CC Z 17 DTH 0035ADI 0035047 0035ADJ</p> <p>d139/141mm d48mm</p>





	<p>W5107 NO. 5614425 - 5614431 - 9129209</p> <p>POLIE DA CAMBOTA (5 PISTAS)</p> <p>OPEL ASTRA H 1.8 Z 18 XE 125CV (APÓS 03-2004) - 1.8 Z 18 XER 140CV (APÓS 01-2006) - OPEL ASTRA H GTC 1.8 Z 18 XE 125 (APÓS 03-2005) - OPEL ASTRA H STATION WAGON 1.8 Z 18 XE 125CV (APÓS 08-2004) - OPEL ASTRA H TWIN TOP 1.8 Z 18 XE 125CV (APÓS 09-2005)</p> <p>d160mm 1f-d26mm</p>		<p>W5145 NO. 93178819 - 0614359 - 614359 - 93192547</p> <p>POLIE DA CAMBOTA 6 PISTAS</p> <p>OPEL ASTRA H (L48) 1.9 CDTI (09.05 A 10.10) 100cv 1910cc Hatchback - OPEL ASTRA H (L48) 1.9 CDTI (06.04 A 10.10) 120cv 1910cc Hatchback - OPEL ASTRA H GTC (L08) 1.9 CDTI (01.06 A 10.10) 101cv 1910cc Hatchback - OPEL ASTRA H GTC (L08) 1.9 CDTI (09.05 A 10.10) 120cv 1910cc Hatchback - OPEL ASTRA H Combi (L35) 1.9 CDTI (09.05 A 10.10) 100cv 1910cc Combi - OPEL ASTRA H Combi (L35) 1.9 CDTI (09.05...)</p> <p>d169mm d30,5mm</p>
	<p>W5166 NO. 0614584 - 55564573 - 614584</p> <p>POLIE DA CAMBOTA (6 PISTAS)</p> <p>OPEL ASTRA H (A04) 1.9 CDTI (L48) 09.2004/10.2010 110KW 150CV 1910CC Z 19 DTH 0035540 0035AML 0035ACZ - OPEL ASTRA H (A04) 1.9 CDTI 16V (L48) 04.2004/10.2010 88KW 120CV 1910CC Z 19 DTJ 0035539 0035AMK 0035ACY - OPEL ASTRA H Caixa/Combi (L70) 1.9 CDTI (L70) 09.2004/10.2010 110KW 150CV 1910CC Z 19 DTH 0035AQH - OPEL ASTRA H Caixa/Combi (L70) 1.9 CDTI 16V (L70) 08.2004/10.2010 88KW 120CV 1910CC Z 19 ...</p> <p>d165mm d30mm</p>		<p>W5201 NO. 5614423 - 90572867</p> <p>POLIE DA CAMBOTA (5 PISTAS)</p> <p>OPEL ASTRA H (A04): 1.4 (L48) 04.2004/10.2004 55KW 75CV 1364CC - OPEL ASTRA H (A04): 1.4 (L48) 03.2004/10.2010 66KW 90CV 1364CC</p> <p>d152mm d39mm</p>
	<p>Y3212 NO. 1008501 - 1008504 - 4709077</p> <p>PARAFUSO PERNO RODA CHAVE 17 M12X1,50X48MM (BASE CONICA PARA JANTES AÇO E LIGA LEVE)</p> <p>OPEL ASTRA H (A04) 1.2 (L48) (08.2005 - 10.2010) 59kw 80cv 1229cm3 Hatchback OPEL ASTRA H (A04) 1.3 CDTI (L48) (08.2005 - 10.2010) 66kw 90cv 1248cm3 Hatchback OPEL ASTRA H (A04) 1.4 (L48) (03.2004 - 10.2010) 66kw 90cv 1364cm3 Hatchback OPEL ASTRA H (A04) 1.4 LPG (L48) (08.2009 - 10.2010) 66kw 90cv 1364cm3 Hatchback OPEL ASTRA H (A04) 1.6 (L48) (03.2004 - 10.2010) 77kw 105cv 1598cm3 Hatchback OPEL ...</p> <p>C48mm (Ch-17mm) M12x1,50x22mm</p>		<p>Y3212 NO. 1008501 - 1008504 - 4709077</p> <p>PARAFUSO PERNO RODA CHAVE 17 M12X1,50X48MM (BASE CONICA PARA JANTES AÇO E LIGA LEVE)</p> <p>OPEL ASTRA H TwinTop (A04) 1.6 (L67) (09.2005 - 10.2010) 77kw 105cv 1598cm3 Cabriolet OPEL ASTRA H TwinTop (A04) 1.6 (L67) (12.2006 - 10.2010) 85kw 116cv 1598cm3 Cabriolet OPEL ASTRA H TwinTop (A04) 1.6 Turbo (L67) (02.2007 - 10.2010) 132kw 180cv 1598cm3 Cabriolet OPEL ASTRA H TwinTop (A04) 1.8 (L67) (09.2005 - 10.2010) 92kw 125cv 1796cm3 Cabriolet OPEL ASTRA H TwinTop (A04) 1.8 (L67) (09.2005 - 1...)</p> <p>C48mm (Ch-17mm) M12x1,50x22mm</p>
	<p>Z55280 NO. 2228839</p> <p>MOLA PAINEL REVESTIMENTO DAS PORTAS</p> <p>OPEL ASTRA H (A04) 1.2 (L48) 08.2005/10.2010 59KW 80CV 1229CC Z 12 XEP - OPEL ASTRA H (A04) 1.3 CDTI (L48) 08.2005/10.2010 66KW 90CV 1248CC Z 13 DTH 0035541 0035AMF 0035ACU - OPEL ASTRA H (A04) 1.4 (L48) 03.2004/10.2010 66KW 90CV 1364CC Z 14 XEP 0035031 0035ALS 0035ADB - OPEL ASTRA H (A04) 1.4 (L48) 04.2004/10.2004 55KW 75CV 1364CC Z 14 XEL 0035036 0035ADA - OPEL ASTRA H (A04) 1.4 LPG (L48) 08.200...)</p> <p>F-G-mm T-27L-18H-12S-5mm</p>		<p>Z55280 NO. 2228839</p> <p>MOLA PAINEL REVESTIMENTO DAS PORTAS</p> <p>OPEL ASTRA H Caixa/Combi (L70) 1.3 CDTI (L70) 08.2005/10.2010 66KW 90CV 1248CC Z 13 DTH 0035AQJ - OPEL ASTRA H Caixa/Combi (L70) 1.6 EcoTec (L70) 02.2004/11.2004 76KW 103CV 1598CC Z 16 XEP - OPEL ASTRA H Caixa/Combi (L70) 1.6 EcoTec (L70) 10.2006/12.2010 85KW 116CV 1598CC Z 16 XER - OPEL ASTRA H Caixa/Combi (L70) 1.7 CDTI (L70) 03.2004/10.2010 74KW 101CV 1686CC Z 17 DTH 0035AQQ - OPEL ASTRA H Caixa...</p> <p>F-G-mm T-27L-18H-12S-5mm</p>
	<p>Z55280 NO. 2228839</p> <p>MOLA PAINEL REVESTIMENTO DAS PORTAS</p> <p>OPEL ASTRA H CLASSIC Combi (A04) ASTRA H FAMILY 1.4 (L35) desde 01.2009 66KW 90CV 1364CC Z 14 XEP - OPEL ASTRA H CLASSIC Combi (A04) ASTRA H FAMILY 1.6 (L35) 12.2006/05.2014 85KW 116CV 1598CC Z 16 XER - OPEL ASTRA H CLASSIC Combi (A04) ASTRA H FAMILY 1.7 CDTI (L35) desde 01.2009 81KW 110CV 1686CC Z 17 DTJ - OPEL ASTRA H CLASSIC Combi (A04) ASTRA H FAMILY 1.7 CDTI (L35) desde 01.2009 92KW 1...)</p> <p>F-G-mm T-27L-18H-12S-5mm</p>		<p>Z55280 NO. 2228839</p> <p>MOLA PAINEL REVESTIMENTO DAS PORTAS</p> <p>OPEL ASTRA H CLASSIC Hatchback (A04) ASTRA H FAMILY 1.3 CDTI (L48) desde 01.2009 66KW 90CV 1248CC Z 13 DTH - OPEL ASTRA H CLASSIC Hatchback (A04) ASTRA H FAMILY 1.4 (L48) desde 01.2009 66KW 90CV 1364CC Z 14 XEP - OPEL ASTRA H CLASSIC Hatchback (A04) ASTRA H FAMILY 1.6 (L48) desde 01.2009 85KW 116CV 1598CC Z 16 XER - OPEL ASTRA H CLASSIC Hatchback (A04) ASTRA H FAMILY 1.7 CDTI (L48) desde 01...)</p> <p>F-G-mm T-27L-18H-12S-5mm</p>
	<p>Z55280 NO. 2228839</p> <p>MOLA PAINEL REVESTIMENTO DAS PORTAS</p> <p>OPEL ASTRA H CLASSIC três volumes (A04) ASTRA H FAMILY 1.6 (L69) 01.2009/05.2014 85KW 116CV 1598CC Z 16 XER - OPEL ASTRA H CLASSIC três volumes (A04) ASTRA H FAMILY 1.7 CDTI (L69) desde 01.2009 81KW 110CV 1686CC Z 17 DTJ - OPEL ASTRA H CLASSIC três volumes (A04) ASTRA H FAMILY 1.7 CDTI (L69) desde 01.2009 92KW 125CV 1686CC A 17 DTR Z 17 DTR - OPEL ASTRA H CLASSIC três volumes (A04) ASTRA H...</p> <p>F-G-mm T-27L-18H-12S-5mm</p>		<p>Z55280 NO. 2228839</p> <p>MOLA PAINEL REVESTIMENTO DAS PORTAS</p> <p>OPEL ASTRA H Combi (A04) 1.3 CDTI (L35) 08.2005/10.2010 66K2 90CV 1248CC Z 13 DTH 0035542 0035ADG - OPEL ASTRA H Combi (A04) 1.4 (L35) 08.2004/10.2010 55KW 75CV 1364CC Z 14 XEL 0035040 0035ADN 0035ADO - OPEL ASTRA H Combi (A04) 1.4 (L35) 08.2004/10.2010 66KW 90CV 1364CC Z 14 XEP 0035ADQ 0035041 0035ADP - OPEL ASTRA H Combi (A04) 1.4 LPG (L35) 08.2009/10.2010 66KW 90CV 1364CC Z 14 XEP 0035ADQ 0035A...</p> <p>F-G-mm T-27L-18H-12S-5mm</p>
	<p>Z55280 NO. 2228839</p> <p>MOLA PAINEL REVESTIMENTO DAS PORTAS</p> <p>OPEL ASTRA H GTC (A04) 1.3 CDTI (L08) 04.2005/10.2010 66KW 90CV 1248CC Z 13 DTH 0035AEI 0035556 0035567 - OPEL ASTRA H GTC (A04) 1.4 (L08) 03.2005/10.2010 55KW 75CV 1364CC Z 14 XEL 0035AEC 0035553 0035564 - OPEL ASTRA H GTC (A04) 1.4 (L08) 03.2005/10.2010 66KW 90CV 1364CC Z 14 XEP 0035AED 0035557 0035546 - OPEL ASTRA H GTC (A04) 1.6 (L08) 03.2005/10.2010 77KW 105CV 1598CC Z 16 XE1 Z 16 XEP 0035AEE...</p> <p>F-G-mm T-27L-18H-12S-5mm</p>		<p>Z55280 NO. 2228839</p> <p>MOLA PAINEL REVESTIMENTO DAS PORTAS</p> <p>OPEL ASTRA H três volumes (A04) ASTRA A+ 1.3 CDTI (L69) 02.2007/10.2010 66KW 90CV 1248CC Z 13 DTH 0035AIG - OPEL ASTRA H três volumes (A04) ASTRA A+ 1.4 (L69) 02.2007/06.2010 66KW 90CV 1364CC Z 14 XEP - OPEL ASTRA H três volumes (A04) ASTRA A+ 1.6 (L69) 02.2007/06.2010 77KW 105CV 1598CC Z 16 XEP - OPEL ASTRA H três volumes (A04) ASTRA A+ 1.6 (L69) 02.2007/05.2014 85KW 116CV 1598CC Z 16 XER...</p> <p>F-G-mm T-27L-18H-12S-5mm</p>
	<p>Z55280 NO. 2228839</p> <p>MOLA PAINEL REVESTIMENTO DAS PORTAS</p> <p>OPEL ASTRA H TwinTop (A04) 1.6 (L67) 09.2005/10.2010 77KW 105CV 1598CC Z 16 XE1 Z 16 XEP 0035AAM - OPEL ASTRA H TwinTop (A04) 1.6 (L67) 12.2006/10.2010 85KW 116CV 1598CC Z 16 XER 0035AHB - OPEL ASTRA H TwinTop (A04) 1.6 Turbo (L67) 02.2007/10.2010 132KW 180CV 1598CC Z 16 LET A 16 LET 0035AHC - OPEL ASTRA H TwinTop (A04) 1.8 (L67) 09.2005/10.2010 92KW 125CV 1796CC Z 18 XE - OPEL ASTRA H TwinTop (A0...)</p> <p>F-G-mm T-27L-18H-12S-5mm</p>		<p>Z80846 NO. 1104881 - 1104882 - 90450482</p> <p>Rebite</p> <p>OPEL ASTRA H</p> <p>d19x29mm 1p-d8-15.2mm</p>

	<p>A2288 NO. 13252362</p> <p>APOIO SUPORTE AMORTECEDOR TRÁS (GASTA 2 UNIDADES)</p> <p>OPEL ASTRA J Sports Tourer (P10): 1.6 (35) 10.2010/10.2015 85KW 116CV 1598CC</p> <p>137x75x47mm 1f-d10mm 2f-d13mm</p>		<p>BE22 NO. 4401363 - 4501620 - 860151</p> <p>ABRAÇADEIRA ESCAPE</p> <p>OPEL ASTRA J (P10): 1.3 CDTI (68) 12.2009/10.2015 70KW 95CV 1248CC - OPEL ASTRA J três volumes: 1.3 CDTI (69) 06.2012/10.2015 70KW 95CV 1248CC - OPEL ASTRA J Sports Tourer (P10): 1.3 CDTI (35) 10.2010/10.2014 70KW 95CV 1248CC - OPEL ASTRA J Caixa/Combi (P10): 1.3 CDTI (35) 10.2012/10.2015 70KW 95CV 1248CC</p> <p>96x100x18mm 1p-d10-75mm</p>
	<p>E0601-M NO. 50510781 - 55703436</p> <p>ESTICADOR SUPORTE APOIO MOTOR TRÁS</p> <p>OPEL ASTRA J (P10): 1.4 (68) 12.2009/10.2015 64KW 87CV 1398CC - OPEL ASTRA J (P10): 1.4 (68) 12.2009/10.2015 74KW 100CV 1398CC - OPEL ASTRA J (P10): 1.3 CDTI (68) 12.2009/10.2015 70KW 95CV 1248CC - OPEL ASTRA J Sports Tourer (P10): 1.4 (35) 10.2010/10.2015 74KW 101CV 1398CC - OPEL ASTRA J Sports Tourer (P10): 1.3 CDTI (35) 10.2010/10.2014 70KW 95CV 1248CC</p> <p>210x97x46mm 1f-d12mm 1f-d13mm 1r-d10mm</p>		<p>E1092 NO. 0852726 - 13276148 - 852577 - 852726 - 90466668</p> <p>ESTICADOR DE ESCAPE</p> <p>OPEL ASTRA J (P10): 1.4 (68) 12.2009/10.2015 64KW 87CV 1398CC - OPEL ASTRA J (P10): 1.4 (68) 12.2009/10.2015 74KW 100CV 1398CC - OPEL ASTRA J (P10): 1.4 Turbo (68) 10.2010/10.2015 88KW 120CV 1364CC - OPEL ASTRA J (P10): 1.4 Turbo (68) 12.2009/10.2015 103KW 140CV 1364CC - OPEL ASTRA J (P10): 1.4 LPG (68) 01.2012/10.2015 103KW 140CV 1364CC - OPEL ASTRA J (P10): 1.6 (68) 12.2009/10.2015 85KW 115CV 1... </p> <p>55x40x35mm</p>
	<p>F3773-T NO. 39241BM525 - 39241BM526 - 39241BM527</p> <p>FOLE TRANSMISSÃO JUNTO À RODA</p> <p>OPEL ASTRA J (P10): 1.4 (68) 12.2009/10.2015 64KW 87CV 1398CC - OPEL ASTRA J (P10): 1.4 (68) 12.2009/10.2015 74KW 100CV 1398CC - OPEL ASTRA J (P10): 1.6 (68) 12.2009/10.2015 85KW 115CV 1598CC - OPEL ASTRA J três volumes: 1.4 (69) 06.2012/10.2015 74KW 101CV 1398CC - OPEL ASTRA J três volumes: 1.4 Turbo (69) 06.2012/10.2015 88KW 120CV 1364CC - OPEL ASTRA J três volumes: 1.6 (69) 06.2012/10.2015 85KW 116...</p> <p>d93x121mm 1f-d76mm 1f-d23mm</p>		<p>F4138 NO. 0578424 - 13122456 - 578424</p> <p>FOLE ALAVANCA TRAVÃO DE MÃO</p> <p>OPEL ASTRA J (P10): 1.3 CDTI (68) 12.2009/10.2015 70KW 95CV 1248CC</p> <p>189x58x150mm 1f-d8mm</p>
	<p>KF3760-T NO. 09201727 - 1603012 - 96391553 - 96489655</p> <p>KIT DE FOLE DO CARDAN JUNTO À RODA</p> <p>OPEL ASTRA J</p> <p>d106x122mm 1f-d82mm 1f-d24mm</p>		<p>KUBT3023 NO. 1f-d39mm(x2) 1f-d48mm(x2) 1f-d5mm</p> <p>KIT BORRACHAS TRAVAO PINÇA TRÁS BRENBO 40MM</p> <p>OPEL ASTRA J (P10) 1.3 CDTI (68) 12.2009/10.2015 70KW 95CV 1248CC A 13 DTE 0035AXO 0035AQC 0035AVM 0035ALA - OPEL ASTRA J (P10) 1.4 (68) 12.2009/10.2015 64KW 87CV 1398CC A 14 XEL 0035AXD 0035ALF - OPEL ASTRA J (P10) 1.4 (68) 12.2009/10.2015 74KW 100CV 1398CC B 14 XERA 14 XER 0035AXE 0035AXF 0035AVY 0035AKY - OPEL ASTRA J (P10) 1.4 LPG (68) 01.2012/10.2015 103KW 140CV 1364CC A 14 NET 0035AXK 0035BFX...</p> <p>d59x12mm(x2) d54x3mm(x2) d50mm(x2) 1f-d48mm(x2) 1f-d5mm 1p-d10x17mm</p>
	<p>P1118 NO. 05 60 136 - 13281359 - 560136 - 90222351</p> <p>CAPA PEDAL EMBRAIAGEM/TRAVAO (GASTA 2 UNIDADES)</p> <p>OPEL ASTRA J (P10) 1.4 (68) (De 12-2009 Até 10-2015) 64KW 87CV 1398cc Hatchback OPEL ASTRA J (P10) 1.4 (68) (De 12-2009 Até 10-2015) 74KW 100CV 1398cc Hatchback OPEL ASTRA J (P10) 1.4 Turbo (68) (De 10-2010 Até 10-2015) 88KW 120CV 1364cc Hatchback OPEL ASTRA J (P10) 1.4 Turbo (68) (De 12-2009 Até 10-2015) 103KW 140CV 1364cc Hatchback OPEL ASTRA J (P10) 1.4 LPG (68) (De 01-2012 Até 10-2015) 103KW 1...</p> <p>52x55x12mm 32x42x12mm</p>		<p>U0314 NO. 0424761</p> <p>ANILHA DA SUSPENSÃO DAS MOLAS DE TRÁS INFERIOR</p> <p>OPEL ASTRA J (P10) 1.3 CDTI (68) (12.2009 - 10.2015) 70kw 95cv 1248cm3 Hatchback OPEL ASTRA J (P10) 1.4 (68) (12.2009 - 10.2015) 64kw 87cv 1398cm3 Hatchback OPEL ASTRA J (P10) 1.4 (68) (12.2009 - 10.2015) 74kw 100cv 1398cm3 Hatchback OPEL ASTRA J (P10) 1.4 LPG (68) (01.2012 - 10.2015) 103kw 140cv 1364cm3 Hatchback OPEL ASTRA J (P10) 1.4 Turbo (68) (10.2010 - 10.2015) 88kw 120cv 1364cm3 Hatchback O...</p> <p>d132x22mm 1f-d33mm</p>
	<p>U0314 NO. 0424761</p> <p>ANILHA DA SUSPENSÃO DAS MOLAS DE TRÁS INFERIOR</p> <p>OPEL ASTRA J GTC 1.4 (08) (10.2011 - 10.2020) 74kw 101cv 1398cm3 Hatchback OPEL ASTRA J GTC 1.4 (08) (10.2011 - 10.2020) 88kw 120cv 1364cm3 Hatchback OPEL ASTRA J GTC 1.4 Turbo (08) 10.2011 - 10.2020) 103kw 140cv 1364cm3 Hatchback OPEL ASTRA J GTC 1.6 CDTI (08) 07.2014 - 10.2020) 81kw 110cv 1598cm3 Hatchback OPEL ASTRA J GTC 1.6 CDTI (08) 07.2014 - 10.2020) 100kw 136cv 1598cm3 Hatchback OPEL ASTRA...</p> <p>d132x22mm 1f-d33mm</p>		<p>U0314 NO. 0424761</p> <p>ANILHA DA SUSPENSÃO DAS MOLAS DE TRÁS INFERIOR</p> <p>OPEL ASTRA J Sports Tourer (P10) 1.3 CDTI (35) (10.2010 - 10.2014) 70kw 95cv 1248cm3 Combi OPEL ASTRA J Sports Tourer (P10) 1.4 (35) (10.2010 - 10.2015) 64kw 87cv 1398cm3 Combi OPEL ASTRA J Sports Tourer (P10) 1.4 (35) (10.2010 - 10.2015) 74kw 101cv 1398cm3 Combi OPEL ASTRA J Sports Tourer (P10) 1.4 LPG (35) (12.2011 - 10.2015) 103kw 140cv 1364cm3 Combi OPEL ASTRA J Sports Tourer (P10) 1.4 Turbo (...</p> <p>d132x22mm 1f-d33mm</p>
	<p>UAP81292 NO. 0821038 - 0821074 - 0821437 - 0821675 - 4708869 - 4809347 - 821038 - 821074 - 821437 - 821675</p> <p>ANILHA PROTEÇÃO TÉRMICA INJECTORES</p> <p>OPEL ASTRA J (P10) 1.3 CDTI (68) (De 12-2009 Até 10-2015) 70kW 95CV 1248cc Hatchback OPEL ASTRA J três volumes 1.3 CDTI (69) (De 06-2012 Até 10-2015) 70kW 95CV 1248cc três volumes OPEL ASTRA J Sports Tourer (P10) 1.3 CDTI (35) (De 10-2010 Até 10-2014) 70kW 95CV 1248cc Combi</p> <p>d16x1mm 1f-d7mm</p>		<p>UAP81292 NO. 0821038 - 0821074 - 0821437 - 0821675 - 4708869 - 4809347 - 821038 - 821074 - 821437 - 821675</p> <p>ANILHA PROTEÇÃO TÉRMICA INJECTORES</p> <p>OPEL ASTRA J (P10) 1.3 CDTI (68) (De 12-2009 Até 10-2015) 70kW 95CV 1248cc Hatchback OPEL ASTRA J três volumes 1.3 CDTI (69) (De 06-2012 Até 10-2015) 70kW 95CV 1248cc três volumes OPEL ASTRA J Sports Tourer (P10) 1.3 CDTI (35) (De 10-2010 Até 10-2014) 70kW 95CV 1248cc Combi</p> <p>d16x1mm 1f-d7mm</p>
	<p>UCRZ1055 NO. 0905000 - 0905005 - 0905009 - 5905104</p> <p>CRUZETA VEIO DIREÇÃO D16X39MM</p> <p>OPEL ASTRA J (P10) 1.3 CDTI (68) (De 12.2009 Até 10.2015) 70kw 95cv 1248cm3 Hatchback - OPEL ASTRA J (P10) 1.4 (68) (De 12.2009 Até 10.2015) 64kW 87cv 1398cm3 Hatchback - OPEL ASTRA J (P10) 1.4 (68) (De 12.2009 Até 10.2015) 74kW 100cv 1398cm3 Hatchback - OPEL ASTRA J (P10) 1.4 LPG (68) (De 01.2012 Até 10.2015) 103kW 140cv 1364cm3 Hatchback - OPEL ASTRA J (P10) 1.4 Turbo (68) (De 10.2010 Até 10.20...</p> <p>d16x28x41mm</p>		<p>UCRZ1083 NO. 0374679 - 0374899 - 0374900</p> <p>CRUZETA VEIO TRANSMISSÃO TRIPODE D43,20MM/26 DENTES</p> <p>OPEL ASTRA J (P10) 1.4 LPG (68) (De 01.2012 Até 10.2015) 103kW 140cv 1364cm3 Hatchback - OPEL ASTRA J (P10) 1.4 Turbo (68) (De 10.2010 Até 10.2015) 88kW 120cv 1364cm3 Hatchback - OPEL ASTRA J (P10) 1.4 Turbo (68) (De 12.2009 Até 10.2015) 103kW 140cv 1364cm3 Hatchback - OPEL ASTRA J (P10) 1.6 CDTI (68) (De 02.2014 Até 10.2015) 81kW 110cv 1598cm3 Hatchback - OPEL ASTRA J (P10) 1.6 CDTI (68) (De 11.2...</p> <p>d43,2mm 26 dentes</p>

	<p>UCRZ1096 NO. 0374690 - 0374691 - 0374880 - 0374883 - 0374884 - 0374894 - 0374902 - 0374917 - 13307853 - 13335127 ...</p> <p>CRUZETA TRANSMISSÃO TRIPOIDE D40MM/23 DENTES</p> <p>OPEL ASTRA J (P10) 1.4 LPG (68) 01.2012/10.2015 103KW 140CV 1364CC A 14 NET 0035AXK 0035BFX 0035AVD - OPEL ASTRA J (P10) 1.4 Turbo (68) 12.2009/10.2015 103KW 140CV 1364CC A 14 NET B 14 NET 0035AXI 0035AXJ 0035ANF 0035AKZ 0035ALT 0035BCV - OPEL ASTRA J (P10) 1.4 Turbo (68) 10.2010/10.2015 88KW 120CV 1364CC B 14 NEL A 14 NEL 0035AXG 0035AXH 0035ANO 0035AOE - OPEL ASTRA J (P10) 1.6 (68) 12.2009/10.20...</p> <p>d40mm (23 dentes)</p>		<p>UMB84029 NO. 2060946</p> <p>TAMPÃO BLOCO MOTOR</p> <p>OPEL ASTRA J (P10) 1.6 (68) (12.09 A 10.15) 115cv 1598cc Hatchback - OPEL ASTRA J Sports Tourer (P10) 1.6 Turbo (35) (10.10 A 10.15) 180cv 1598cc Combi</p> <p>d36x10mm di-32mm</p>
	<p>UMV26814 NO. 13360795 - 784018 - 784051</p> <p>MANETE PUNHO TOPO ALAVANCA MUDANÇAS CAIXA AUTOMÁTICA F13MM</p> <p>OPEL ASTRA J (P10): 1.4 (68) 12.2009/10.2015 64KW 87CV 1398CC - OPEL ASTRA J (P10): 1.4 (68) 12.2009/10.2015 74KW 100CV 1398CC - OPEL ASTRA J (P10): 1.4 Turbo (68) 12.2009/10.2015 103KW 140CV 1364CC - OPEL ASTRA J (P10): 1.6 (68) 12.2009/10.2015 85KW 115CV 1598CC - OPEL ASTRA J (P10): 1.6 Turbo (68) 12.2009/10.2015 132KW 180CV 1598CC - OPEL ASTRA J (P10): 1.3 CDTI (68) 12.2009/10.2015 70KW 95CV 12...</p> <p>105x57x47mm 1f-d13mm</p>		<p>UTR0856 NO. 1305248 - 13502353</p> <p>TAMPÃO RESERVATÓRIO LÍQUIDO REFRIGERAÇÃO</p> <p>OPEL ASTRA J (P10) 1.4 (A Partir de 12.09) 87cv 1398cc Hatchback - OPEL ASTRA J (P10) 1.4 (A Partir de 12.09) 100cv 1398cc Hatchback - OPEL ASTRA J (P10) 1.4 Turbo (A Partir de 10.10) 120cv 1364cc Hatchback - OPEL ASTRA J (P10) 1.4 Turbo (A Partir de 12.09) 140cv 1364cc Hatchback - OPEL ASTRA J (P10) 1.4 LPG (A Partir de 01.12) 140cv 1364cc Hatchback - OPEL ASTRA J (P10) 1.6 (A Partir de...</p> <p>65x35mm 1f-d52x10mm</p>
	<p>UTR0856 NO. 1305248 - 13502353</p> <p>TAMPÃO RESERVATÓRIO LÍQUIDO REFRIGERAÇÃO</p> <p>OPEL ASTRA J (P10) 1.4 (68) (De 12-2009 Até ...) 64KW 87CV 1398cc Hatchback OPEL ASTRA J (P10) 1.4 (68) (De 12-2009 Até ...) 74KW 100CV 1398cc Hatchback OPEL ASTRA J (P10) 1.4 Turbo (68) (De 10-2010 Até .1-20 -) 88KW 120CV 1364cc Hatchback OPEL ASTRA J (P10) 1.4 Turbo (68) (De 12-2009 Até ...) 103KW 140CV 1364cc Hatchback OPEL ASTRA J (P10) 1.4 LPG (68) (De 01-2012 Até .1-20 -) 103KW 140CV 1364cc ...</p> <p>65x35mm 1f-d52x10mm</p>		<p>UTR0862 NO. 1305248 - 13502353</p> <p>TAMPÃO RESERVATÓRIO LÍQUIDO REFRIGERAÇÃO</p> <p>OPEL ASTRA J (P10) 1.4 (68) (De 12-2009 Até 10-2015) 64KW 87CV 1398cc Hatchback OPEL ASTRA J (P10) 1.4 (68) (De 12-2009 Até 10-2015) 74KW 100CV 1398cc Hatchback OPEL ASTRA J (P10) 1.4 Turbo (68) (De 10-2010 Até 10-2015) 88KW 120CV 1364cc Hatchback OPEL ASTRA J (P10) 1.4 Turbo (68) (De 12-2009 Até 10-2015) 103KW 140CV 1364cc Hatchback OPEL ASTRA J (P10) 1.4 LPG (68) (De 01-2012 Até 10-2015) 103KW 1...</p> <p>d65x35mm d48x15mm 1p-d39x32mm</p>
	<p>UTR1300 NO. 00650090 - 05650831</p> <p>TAMPÃO RESERVATÓRIO DO OLEO</p> <p>OPEL ASTRA J (P10) 1.4 (68) (De 12-2009 Até 10-2015) 64KW 87CV 1398cc Hatchback OPEL ASTRA J (P10) 1.4 (68) (De 12-2009 Até 10-2015) 74KW 100CV 1398cc Hatchback OPEL ASTRA J (P10) 1.4 Turbo (68) (De 12-2009 Até 10-2015) 103KW 140CV 1364cc Hatchback OPEL ASTRA J Sports Tourer (P10) 1.4 (35) (De 10-2010 Até 10-2015) 74KW 101CV 1398cc Combi OPEL ASTRA J Sports Tourer (P10) 1.4 Turbo (35) (De 10-2010 ...</p> <p>d59x31mm d45x12mm</p>		<p>UTV83019 NO. 0652315 - 0652477 - 652315 - 652477 - 90502556 - 96023264</p> <p>TAMPÃO VEDAÇÃO BUJÃO</p> <p>OPEL ASTRA J (P10) 1.4 (68) (De 12-2009 Até 10-2015) 64KW 87CV 1398cc Hatchback OPEL ASTRA J (P10) 1.4 (68) (De 12-2009 Até 10-2015) 74KW 100CV 1398cc Hatchback OPEL ASTRA J (P10) 1.4 Turbo (68) (De 10-2010 Até 10-2015) 88KW 120CV 1364cc Hatchback OPEL ASTRA J (P10) 1.4 Turbo (68) (De 12-2009 Até 10-2015) 103KW 140CV 1364cc Hatchback OPEL ASTRA J (P10) 1.4 LPG (68) (De 01-2012 Até 10-2015) 103KW 1...</p> <p>d25x14mm c9mm d13mm</p>
	<p>W5159 NO. 055575960 - 0614172 - 0614758 - 098022837 - 098039173 - 55575960 - 5614450 - 614172 - 614758 - 98022...</p> <p>POLIE CAMBOTA 6 PISTAS</p> <p>OPEL ASTRA J (P10) 1.3 CDTI (68) 12.2009/10.2015 70KW 95CV 1248CC A 13 DTE 0035AXO 0035AQC 0035AVM 0035ALA - OPEL ASTRA J (P10) 1.7 CDTI (68) 09.2009/10.2015 81KW 110CV 1686CC A 17 DTC A 17 DTE A 17 DTJ 0035AQY 0035AXQ 0035AKN - OPEL ASTRA J (P10) 1.7 CDTI (68) 12.2009/10.2015 92KW 125CV 1686CC A 17 DTR 0035AQX 0035AXR 0035AKO 0035AMI - OPEL ASTRA J (P10) 1.7 CDTI (68) 07.2011/10.2015 96KW 131CV 1...</p> <p>d154mm d48mm</p>		<p>Y3212 NO. 1008501 - 1008504 - 4709077</p> <p>PARAFUSO PERNO RODA CHAVE 17 M12X1,50X48MM (BASE CONICA PARA JANTES AÇO E LIGA LEVE)</p> <p>OPEL ASTRA J (P10) 1.3 CDTI (68) (12.2009 - 10.2015) 70kw 95cv 1248cm3 Hatchback OPEL ASTRA J (P10) 1.4 (68) (12.2009 - 10.2015) 64kw 87cv 1398cm3 Hatchback OPEL ASTRA J (P10) 1.4 (68) (12.2009 - 10.2015) 74kw 100cv 1398cm3 Hatchback OPEL ASTRA J (P10) 1.4 (68) (12.2009 - 10.2015) 103kw 140cv 1364cm3 Hatchback OPEL ASTRA J (P10) 1.4 Turbo (68) (12.2009 - 10.2015) 88kw 120cv 1364cm3 Hatchback OPEL ASTRA J (P10) 1.4 Turbo (68) (12.2009 - 10.2015) 103kw 140cv 1364cm3 Hatchback OPEL ASTRA J (P10) 1.4 LPG (68) (12.2009 - 10.2015) 85kw 115cv 1598cm3 Hatchback OPEL ...</p> <p>C48mm (Ch-17mm) M12x1,50x22mm</p>
	<p>Y3227 NO. 0328004 - 09595179 - 09599302 - 11611063 - 15651585 - 9595179</p> <p>PARAFUSO DA RODA CAVILHA</p> <p>OPEL ASTRA J (P10) 1.4 (68) (12.2009 - 10.2015) 64kw 87cv 1398cm3 Hatchback OPEL ASTRA J (P10) 1.4 (68) (12.2009 - 10.2015) 74kw 100cv 1398cm3 Hatchback OPEL ASTRA J (P10) 1.4 LPG (68) (01.2012 - 10.2015) 103kw 140cv 1364cm3 Hatchback OPEL ASTRA J (P10) 1.4 Turbo (68) (10.2010 - 10.2015) 88kw 120cv 1364cm3 Hatchback OPEL ASTRA J (P10) 1.4 Turbo (68) (12.2009 - 10.2015) 103kw 140cv 1364cm3 Hatchbac...</p> <p>c56mm M12x1mm</p>		<p>Y3227 NO. 0328004 - 09595179 - 09599302 - 11611063 - 15651585 - 9595179</p> <p>PARAFUSO DA RODA CAVILHA</p> <p>OPEL ASTRA J GTC 1.4 (08) (10.2011 - 10.2015) 74kw 101cv 1398cm3 Hatchback OPEL ASTRA J GTC 1.4 (08) (10.2011 -) 88kw 120cv 1364cm3 Hatchback OPEL ASTRA J GTC 1.4 (08) (10.2011 -) 103kw 140cv 1364cm3 Hatchback OPEL ASTRA J GTC 1.6 (08) (10.2011 -) 132kw 180cv 1598cm3 Hatchback OPEL ASTRA J GTC 1.6 CDTI (08) (07.2014 -) 81kw 110cv 1598cm3 Hatchback OPEL ASTRA J GTC 1.6 CDTI (08) (07.2014 -) 100kw 1...</p> <p>c56mm M12x1mm</p>
	<p>Y3227 NO. 0328004 - 09595179 - 09599302 - 11611063 - 15651585 - 9595179</p> <p>PARAFUSO DA RODA CAVILHA</p> <p>OPEL ASTRA J Sports Tourer (P10) 1.3 CDTI (35) (10.2010 - 10.2014) 70kw 95cv 1248cm3 Combi OPEL ASTRA J Sports Tourer (P10) 1.4 (35) (10.2010 - 10.2015) 64kw 87cv 1398cm3 Combi OPEL ASTRA J Sports Tourer (P10) 1.4 (35) (10.2010 - 10.2015) 74kw 101cv 1398cm3 Combi OPEL ASTRA J Sports Tourer (P10) 1.4 LPG (35) (12.2011 - 10.2015) 103kw 140cv 1364cm3 Combi OPEL ASTRA J Sports Tourer (P10) 1.4 Turbo (...</p> <p>c56mm M12x1mm</p>		<p>Z50130 NO. 4811301 - YQ00159480</p> <p>MOLA REBITE FIXAÇÃO</p> <p>OPEL ASTRA J (P10) 1.3 CDTI (68) (12.2009 - 10.2015) 70kw 95cv 1248cm3 Hatchback OPEL ASTRA J (P10) 1.4 (68) (12.2009 - 10.2015) 64kw 87cv 1398cm3 Hatchback OPEL ASTRA J (P10) 1.4 (68) (12.2009 - 10.2015) 74kw 100cv 1398cm3 Hatchback OPEL ASTRA J (P10) 1.4 LPG (68) (01.2012 - 10.2015) 103kw 140cv 1364cm3 Hatchback OPEL ASTRA J (P10) 1.4 Turbo (68) (10.2010 - 10.2015) 88kw 120cv 1364cm3 Hatchback O...</p> <p>d6x 18mm f-d17mm</p>
	<p>Z50130 NO. 4811301 - YQ00159480</p> <p>MOLA REBITE FIXAÇÃO</p> <p>OPEL ASTRA J GTC 1.4 (08) (10.2011 - 11.2013) 74kw 101cv 1398cm3 Hatchback OPEL ASTRA J GTC 1.4 (08) (10.2011 - 04.2018) 88kw 120cv 1364cm3 Hatchback OPEL ASTRA J GTC 1.4 Turbo (08) (10.2011 - 04.2018) 103kw 140cv 1364cm3 Hatchback OPEL ASTRA J GTC 1.6 CDTI (08) (07.2014 - 04.2018) 81kw 110cv 1598cm3 Hatchback OPEL ASTRA J GTC 1.6 CDTI (08) (07.2014 - 04.2018) 100kw 136cv 1598cm3 Hatchback OPEL AS...</p> <p>d6x 18mm f-d17mm</p>		<p>Z50130 NO. 4811301 - YQ00159480</p> <p>MOLA REBITE FIXAÇÃO</p> <p>OPEL ASTRA J Sports Tourer (P10) 1.3 CDTI (35) (10.2010 - 10.2014) 70kw 95cv 1248cm3 Combi OPEL ASTRA J Sports Tourer (P10) 1.4 (35) (10.2010 - 10.2015) 64kw 87cv 1398cm3 Combi OPEL ASTRA J Sports Tourer (P10) 1.4 (35) (10.2010 - 10.2015) 74kw 101cv 1398cm3 Combi OPEL ASTRA J Sports Tourer (P10) 1.4 LPG (35) (12.2011 - 10.2015) 103kw 140cv 1364cm3 Combi OPEL ASTRA J Sports Tourer (P10) 1.4 Turbo (...</p> <p>d6x 18mm f-d17mm</p>



OPEL ASTRA J

Rafri, Lda.





	Z50130 NO. 4811301 - YQ00159480 MOLA REBITE FIXAÇÃO OPEL ASTRA J três volumes 1.3 CDTI (69) (06.2012 - 10.2015) 70kw 95cv 1248cm3 três volumes OPEL ASTRA J três volumes 1.4 (69) (06.2012 - 10.2015) 74kw 101cv 1398cm3 três volumes OPEL ASTRA J três volumes 1.4 LPG (69) (07.2014 -) 103kw 140cv 1364cm3 três volumes OPEL ASTRA J três volumes 1.4 Turbo (69) (06.2012 - 10.2015) 88kw 120cv 1364cm3 três volumes OPEL ASTRA J três volumes 1.4 Turbo (69) (06.... d6x 18mm f-d17mm		Z55280 NO. 2228839 MOLA PAINEL REVESTIMENTO DAS PORTAS OPEL ASTRA J (P10) 1.3 CDTI (68) 12.2009/10.2015 70KW 95CV 1248CC A 13 DTE 0035AXO 0035AQC 0035AVM 0035ALA - OPEL ASTRA J (P10) 1.4 (68) 12.2009/10.2015 64KW 87CV 1398CC A 14 XEL 0035AXD 0035ALF - OPEL ASTRA J (P10) 1.4 (68) 12.2009/10.2015 74KW 100CV 1398CC B 14 XER A 14 XER 0035AXE 0035AXF 0035AVY 0035AKY - OPEL ASTRA J (P10) 1.4 LPG (68) 01.2012/10.2015 103KW 140CV 1364CC A ... F-G-mm T-27L-18H-12S-5mm
	Z55280 NO. 2228839 MOLA PAINEL REVESTIMENTO DAS PORTAS OPEL ASTRA J GTC 1.4 (08) 10.2011/11.2013 74KW 101CV 1398CC A 14 XER 0035ATR - OPEL ASTRA J GTC 1.4 (08) 10.2011/04.2018 88KW 120CV 1364CC B 14 NEL A 14 NEL 0035ATS 1844AFN - OPEL ASTRA J GTC 1.4 Turbo (08) 10.2011/04.2018 103KW 140CV 1364CC B 14 NET A 14 NET 0035ATT 1844AFO - OPEL ASTRA J GTC 1.6 CDTI (08) 07.2014/04.2018 81KW 110CV 1598CC B 16 DTL 0035BDV 1844AFQ - OPEL ASTRA J GTC 1.6 CDTI (08)... F-G-mm T-27L-18H-12S-5mm		Z55280 NO. 2228839 MOLA PAINEL REVESTIMENTO DAS PORTAS OPEL ASTRA J Sports Tourer (P10) 1.3 CDTI (35) 10.2010/10.2014 70KW 95CV 1248CC A 13 DTE 0035ASR 0035ANJ - OPEL ASTRA J Sports Tourer (P10) 1.4 (35) 10.2010/10.2015 64KW 87CV 1398CC A 14 XEL - OPEL ASTRA J Sports Tourer (P10) 1.4 (35) 10.2010/10.2015 74KW 101CV 1398CC B 14 XER A 14 XER 0035ASK 0035ANA - OPEL ASTRA J Sports Tourer (P10) 1.4 LPG (35) 12.2011/10.2015 103KW 140CV 1364CC A 14 NET 0035A... F-G-mm T-27L-18H-12S-5mm
	Z55280 NO. 2228839 MOLA PAINEL REVESTIMENTO DAS PORTAS OPEL ASTRA J três volumes 1.3 CDTI (69) 06.2012/10.2015 70KW 95CV 1248CC A 13 DTE 0035AWQ - OPEL ASTRA J três volumes 1.4 (69) 06.2012/10.2015 74KW 101CV 1398CC B 14 XER A 14 XER 0035AWM - OPEL ASTRA J três volumes 1.4 LPG (69) desde 07.2014 103KW 140CV 1364CC A 14 NET 0035BJG 0035BDT 1844AFJ - OPEL ASTRA J três volumes 1.4 Turbo (69) 06.2012/10.2015 88KW 120CV 1364CC B 14 NEL A 14 NEL - OPEL ASTRA... F-G-mm T-27L-18H-12S-5mm		

OPEL ASTRA K - CASCADA

	E1092 NO. 0852726 - 13276148 - 852577 - 852726 - 90466668 ESTICADOR DE ESCAPE OPEL ASTRA K (B16): 1.0 Turbo (68) 06.2015/»» 77KW 105CV 999CC - OPEL ASTRA K (B16): 1.4 (68) 06.2015/»» 74KW 100CV 1399CC - OPEL ASTRA K (B16): 1.4 Turbo (68) 06.2015/»» 92KW 125CV 1399CC - OPEL ASTRA K (B16): 1.6 CDTI (68) 06.2015/»» 70KW 95CV 1598CC - OPEL ASTRA K (B16): 1.6 CDTI (68) 06.2015/»» 81KW 110CV 1598CC - OPEL ASTRA K (B16): 1.6 CDTI (68) 06.2015/»» 100KW 136CV 1598CC 55x40x35mm		E1092 NO. 0852726 - 13276148 - 852577 - 852726 - 90466668 ESTICADOR DE ESCAPE OPEL CASCADA (W13): 1.4 (67) 04.2013/04.2018 88KW 120CV 1364CC - OPEL CASCADA (W13): 1.4 Turbo (67) 03.2013/04.2018 103KW 140CV 1364CC - OPEL CASCADA (W13): 1.6 SIDI (67) 04.2013/04.2019 125KW 170CV 1598CC - OPEL CASCADA (W13): 1.6 (67) 11.2013/04.2018 147KW 200CV 1598CC - OPEL CASCADA (W13): 2.0 CDTI (67) 04.2013/06.2015 121KW 165CV 1956CC - OPEL CASCADA (W13): 2.0 CDTI (67) 04.2013/06.2015 143KW... 55x40x35mm
	U0314 NO. 0424761 ANILHA DA SUSPENSÃO DAS MOLAS DE TRÁS INFERIOR OPEL CASCADA (W13) 1.4 (67) (04.2013 - 04.2018) 88kw 120cv 1364cm3 Cabriolet - OPEL CASCADA (W13) 1.4 Turbo (67) (03.2013 - 04.2018) 103kw 140cv 1364cm3 Cabriolet - OPEL CASCADA (W13) 1.6 (67) (05.2018 - 04.2019) 100kw 136cv 1598cm3 Cabriolet - OPEL CASCADA (W13) 1.6 (67) (11.2013 - 04.2018) 147kw 200cv 1598cm3 Cabriolet - OPEL CASCADA (W13) 1.6 SIDI (67) (04.2013 - 04.2019) 125kw 170cv 1598cm3 Cabriolet ... d132x22mm 1f-d33mm		UAP83244 NO. 055565375 - 55565375 ANILHA PROTEÇÃO TÉRMICA INJECTORES OPEL CASCADA (W13) 2.0 CDTI (De 07-2015 Até .1-20 -) 125kW 170CV 1956cc Cabriolet d15x2mm 1f-d7mm
	UCRZ1055 NO. 0905000 - 0905005 - 0905009 - 5905104 CRUZETA VEIO DIREÇÃO D16X39MM OPEL CASCADA (W13) 1.4 (67) (De 04.2013 Até 04.2018) 88kw 120cv 1364cm3 Cabriolet - OPEL CASCADA (W13) 1.4 Turbo (67) (De 03.2013 Até 04.2018) 103kw 140cv 1364cm3 Cabriolet - OPEL CASCADA (W13) 1.6 (67) (De 05.2018 Até 04.2019) 100kw 136cv 1598cm3 Cabriolet - OPEL CASCADA (W13) 1.6 (67) (De 11.2013 Até 04.2018) 147KW 200cv 1598cm3 Cabriolet - OPEL CASCADA (W13) 1.6 SIDI (67) (De 04.2013 Até 04.2018) 125KW 170CV 1598CC Cabriolet - OPEL CASCADA (W13) 1.6 SIDI (67) (De 04.2013 Até 04.2018) 125KW 170CV 1598CC Cabriolet ... d16x28x41mm		UCRZ1083 NO. 0374679 - 0374899 - 0374900 CRUZETA VEIO TRANSMISSÃO TRIPODE D43,20MM/26 DENTES OPEL CASCADA (W13) 1.4 (67) (De 04.2013 Até 04.2018) 88kw 120cv 1364cm3 Cabriolet - OPEL CASCADA (W13) 1.4 Turbo (67) (De 03.2013 Até 04.2018) 103kw 140cv 1364cm3 Cabriolet - OPEL CASCADA (W13) 1.6 (67) (De 11.2013 Até 04.2018) 147KW 200cv 1598cm3 Cabriolet - OPEL CASCADA (W13) 1.6 SIDI (67) (De 04.2013 Até 04.2019) 125KW 170CV 1598CC Cabriolet - OPEL CASCADA (W13) 1.6 SIDI (67) (De 04.2013 Até 04.2019) 125KW 170CV 1598CC Cabriolet ... d43.2mm 26 dentes
	UTR0856 NO. 1305248 - 13502353 TAMPÃO RESERVATÓRIO LIQUIDO REFRIGERAÇÃO OPEL ASTRA K (B16) 1.0 (68) (De 06-2015 Até .1-20 -) 77kW 105CV 999cc Hatchback - OPEL ASTRA K (B16) 1.4 (68) (De 06-2015 Até .1-20 -) 74KW 100CV 1399cc Hatchback - OPEL ASTRA K (B16) 1.4 Turbo (68) (De 06-2015 Até .1-20 -) 92KW 125CV 1399cc Hatchback - OPEL ASTRA K (B16) 1.4 Turbo (68) (De 06-2015 Até .1-20 -) 110KW 150CV 1399cc Hatchback - OPEL ASTRA K (B16) 1.6 Turbo (68) (De 11-2015 Até .1-20 -) 147KW... 65x35mm 1f-d52x10mm		UTR0856 NO. 1305248 - 13502353 TAMPÃO RESERVATÓRIO LIQUIDO REFRIGERAÇÃO OPEL CASCADA (W13) 1.4 (De 03-2013 Até .1-20 -) 88KW 120CV 1362cc Cabriolet - OPEL CASCADA (W13) 1.4 Turbo (De 03-2013 Até .1-20 -) 103KW 140CV 1364cc Cabriolet - OPEL CASCADA (W13) 1.6 SIDI (De 03-2013 Até .1-20 -) 125KW 170CV 1598cc Cabriolet - OPEL CASCADA (W13) 1.6 (De 11-2013 Até .1-20 -) 147KW 200CV 1598cc Cabriolet - OPEL CASCADA (W13) 2.0 CDTI (De 03-2013 Até .1-20 -) 121KW 165CV 1956cc Cabriolet ... 65x35mm 1f-d52x10mm

	<p>UTR0862 NO. 1305248 - 13502353</p> <p>TAMPÃO RESERVATÓRIO LIQUIDO REFRIGERAÇÃO</p> <p>OPEL ASTRA K (B16) 1.0 Turbo (68) (De 06-2015 Até .1-20 -) 77kW 105CV 999cc Hatchback OPEL ASTRA K (B16) 1.4 Turbo (68) (De 06-2015 Até .1-20 -) 74kW 100CV 1399cc Hatchback OPEL ASTRA K (B16) 1.4 CNG (68) (De 10-2017 Até .1-20 -) 81kW 110CV 1399cc Hatchback OPEL ASTRA K (B16) 1.4 Turbo (68) (De 06-2015 Até .1-20 -) 92kW 125CV 1399cc Hatchback OPEL ASTRA K (B16) 1.4 Turbo (68) (De 06-2015 Até .1-20...</p> <p>d65x35mm d48x15mm 1p-d39x32mm</p>		<p>UTR0862 NO. 1305248 - 13502353</p> <p>TAMPÃO RESERVATÓRIO LIQUIDO REFRIGERAÇÃO</p> <p>OPEL CASCADA (W13) 1.4 (67) (De 04-2013 Até .1-20 -) 88kW 120CV 1364cc Cabriolet OPEL CASCADA (W13) 1.4 Turbo (67) (De 03-2013 Até .1-20 -) 103kW 140CV 1364cc Cabriolet OPEL CASCADA (W13) 1.6 SIDI (67) (De 04-2013 Até .1-20 -) 125kW 170CV 1598cc Cabriolet OPEL CASCADA (W13) 1.6 (67) (De 11-2013 Até .1-20 -) 147kW 200CV 1598cc Cabriolet OPEL CASCADA (W13) 2.0 CDTI (67) (De 04-2013 Até .1-20 -) 121k...</p> <p>d65x35mm d48x15mm 1p-d39x32mm</p>
	<p>UTV83019 NO. 0652315 - 0652477 - 652315 - 652477 - 90502556 - 96023264</p> <p>TAMPÃO VEDAÇÃO BUJÃO</p> <p>OPEL CASCADA (W13) 1.4 (67) (De 04-2013 Até .1-20 -) 88kW 120CV 1364cc Cabriolet OPEL CASCADA (W13) 1.4 Turbo (67) (De 03-2013 Até .1-20 -) 103kW 140CV 1364cc Cabriolet</p> <p>d25x14mm c9mm d13mm</p>		<p>Y3227 NO. 0328004 - 09595179 - 09599302 - 11611063 - 15651585 - 9595179</p> <p>PARAFUSO DA RODA CAVILHA</p> <p>OPEL CASCADA (W13) 1.4 (67) (04.2013 - 04.2018) 88kw 120cv 1364cm3 Cabriolet OPEL CASCADA (W13) 1.4 Turbo (67) (03.2013 - 04.2018) 103kw 140cv 1364cm3 Cabriolet OPEL CASCADA (W13) 1.6 (67) (05.2018 - 04.2019) 100kw 136cv 1598cm3 Cabriolet OPEL CASCADA (W13) 1.6 (67) (11.2013 - 04.2018) 147kw 200cv 1598cm3 Cabriolet OPEL CASCADA (W13) 1.6 SIDI (67) (04.2013 - 04.2019) 125kw 170cv 1598cm3 Cabriolet ...</p> <p>c56mm M12x1mm</p>
	<p>Z50130 NO. 4811301 - YQ00159480</p> <p>MOLA REBITE FIXAÇÃO</p> <p>OPEL CASCADA (W13) 1.4 (67) (04.2013 - 04.2018) 88kw 120cv 1364cm3 Cabriolet OPEL CASCADA (W13) 1.4 Turbo (67) (03.2013 - 04.2018) 103kw 140cv 1364cm3 Cabriolet OPEL CASCADA (W13) 1.6 (67) (05.2018 - 04.2019) 100kw 136cv 1598cm3 Cabriolet OPEL CASCADA (W13) 1.6 (67) (11.2013 - 04.2018) 147kw 200cv 1598cm3 Cabriolet OPEL CASCADA (W13) 1.6 SIDI (67) (04.2013 - 04.2019) 125kw 170cv 1598cm3 Cabriolet ...</p> <p>d6x 18mm f-d17mm</p>		<p>Z55280 NO. 2228839</p> <p>MOLA PAINEL REVESTIMENTO DAS PORTAS</p> <p>OPEL CASCADA (W13) 1.4 (67) (04.2013/04.2018) 88KW 120CV 1364CC B 14 NEL A 14 NEL 0035AYA 1844AGO - OPEL CASCADA (W13) 1.4 Turbo (67) 03.2013/04.2018 103KW 140CV 1364CC B 14 NET A 14 NET 0035AYB 1844AGP - OPEL CASCADA (W13) 1.6 (67) 11.2013/04.2018 147KW 200CV 1598CC A 16 SHT B 16 SHT D 16 SHT 0035BBB 1844AGQ - OPEL CASCADA (W13) 1.6 (67) 05.2018/04.2019 100KW 136CV 1598CC D 16 SHJ 1844AJL - OPEL CA...</p> <p>F-G-mm T-27L-18H-12S-5mm</p>
	<p>Z57101 NO. 13252119</p> <p>MOLA DO PAINEL DA PORTA</p> <p>OPEL ASTRA K (A partir de 2016)</p> <p>F9mm T17mm L15mm H20mm S1-6mm</p>		<p>Z57101 NO. 13252119</p> <p>MOLA DO PAINEL DA PORTA</p> <p>OPEL CASCADA (A partir de 2013)</p> <p>F9mm T17mm L15mm H20mm S1-6mm</p>
	<p>Z71500 NO. 13252118</p> <p>MOLA DO PAINEL DA PORTA</p> <p>OPEL ASTRA K (A partir de 2016)</p> <p>F9mm T17mm L14mm H20mm S1-7mm</p>		<p>Z71500 NO. 13252118</p> <p>MOLA DO PAINEL DA PORTA</p> <p>OPEL CASCADA (A partir de 2013)</p> <p>F9mm T17mm L14mm H20mm S1-7mm</p>

OPEL CALIBRA



	<p>A1219 NO. 0344514 - 0344520 - 344514 - 344520 - 90289421 - 90468447</p> <p>APOIO DO AMOTECEDOR DA FRENTE</p> <p>OPEL CALIBRA (A) 2.0i - 2.0i 16v - 2.0i 16v 4x4 - 2.0i TURBO 4x4 (1990 A 1997)</p> <p>d113x42mm 1f-d12mm</p>		<p>A1392 NO. 684282 - 684291 - 6844282 - 6844283 - 684667</p> <p>APOIO DO MOTOR FRENTE DIREITO</p> <p>OPEL CALIBRA (A) 2.0i (1990 A 1997)</p> <p>185x95x67mm 2f-d11mm</p>
	<p>A1394 NO. 684646 - 90372425</p> <p>APOIO MOTOR FRENTE DIREITO</p> <p>OPEL CALIBRA (A) 2.0i - 2.0i 16v - 2.0i 16v 4x4 (1990 A 1997)</p> <p>175x95x60mm 1f-d12mm</p>		<p>A1406 NO. 0650702 - 90233962</p> <p>APOIO MOTOR ESQUERDO</p> <p>OPEL CALIBRA</p> <p>d20x15mm 1p-d6-10mm 1p-d6-15mm</p>

	<p>A2360 NO. 0344513 - 344513 - 90268464</p> <p>APOIO SUPORTE AMORTECEDOR FRENTE (GASTA 2 UNIDADES)</p> <p>OPEL CALIBRA A (C89) 2.0 i 16V (M07) (De 02.1994 Até 07.1997) 4095kW 100cv 136cm³ 1998 - OPEL CALIBRA A (C89) 2.0 i 16V 4x4 (M07) (De 02.1994 Até 07.1997) 4094kW 100cv 136cm³ 1998 -</p> <p>d113x44mm 1f-d15mm</p>		<p>C0233 NO. 1160724 - 90054143</p> <p>BOTÃO AFINAÇÃO CAPÔT</p> <p>OPEL CALIBRA A (85_) 2.0 i (06.90 A 07.97) 115cv 1998cc Coupé - OPEL CALIBRA A (85_) 2.0 i 4x4 (06.90 A 07.97) 115cv 1998cc Coupé - OPEL CALIBRA A (85_) 2.0 i 16V (02.94 A 07.97) 136cv 1998cc Coupé - OPEL CALIBRA A (85_) 2.0 i 16V 4x4 (02.94 A 07.97) 136cv 1998cc Coupé - OPEL CALIBRA A (85_) 2.0 i 16V (06.90 A 02.94) 150cv 1998cc Coupé - OPEL CALIBRA A (85_) 2.0 i 16V 4x4 (06.90 A 02.94)...</p> <p>d19x31mm</p>
	<p>E0128 NO. 0350263 - 350263 - 4544599 - 90495045</p> <p>ESTICADOR DA BARRA ESTABILIZADORA DA FRENTE</p> <p>OPEL CALIBRA (A) 2.0i - 2.0i 16v - 2.0i 16v 4x4 - 2.5i V6</p> <p>105x34x34mm 1p-d12-25mm</p>		<p>E1071 NO. 852723 - 90352773</p> <p>ESTICADOR DE ESCAPE</p> <p>OPEL CALIBRA (A) 2.0i - 2.0i 16v - 2.0i TURBO 4x4 (APÓS 1990)</p> <p>72x61x20mm</p>
	<p>E23401-V NO. 0758801 - 758801 - 90250156</p> <p>ESTICADOR MANETE CAIXA DE VELOCIDADES</p> <p>OPEL CALIBRA A (C89) 2.0 i (M07) (De 08-1989 Até 12-1996) 85KW 115CV 1998cc Coupé OPEL CALIBRA A (C89) 2.0 i 4x4 (M07) (De 06-1990 Até 07-1997) 85KW 115CV 1998cc Coupé OPEL CALIBRA A (C89) 2.0 i 16V (M07) (De 02-1994 Até 07-1997) 100KW 136CV 1998cc Coupé OPEL CALIBRA A (C89) 2.0 i 16V 4x4 (M07) (De 02-1994 Até 07-1997) 100KW 136CV 1998cc Coupé OPEL CALIBRA A (C89) 2.0 i 16V (M07) (De 06-1990 Até 0...</p> <p>207x17x18mm 2f-d11mm</p>		<p>F1338-I NO. 1609076 - 90442111</p> <p>FOLE DA CREMALHEIRA DA DIREÇÃO (CREMALHEIRA ZF)</p> <p>OPEL CALIBRA (A) 2.0i - 2.0i 16v - 2.0i 16v 4x4 - 2.0i 4x4 - 2.0i T 16v 4x4 - 2.5i V6 (1990 A 1997)</p> <p>d80x360mm 1f-d58mm 1f-d42mm</p>
	<p>F1350-I NO. 1609045 - 1609073 - 90188878 - 90398968 - 9943449</p> <p>FOLE DA DIREÇÃO ASSISTIDA LADO DIREITO E ESQUERDO</p> <p>OPEL CALIBRA A (C89) 2.0 i (M07) 08.1989/12.1996 85KW 115CV 1998CC C 20 NE 0039844 - OPEL CALIBRA A (C89) 2.0 i 16V (M07) 06.1990/02.1994 110KW 150CV 1998CC C 20 XE 0039845 - OPEL CALIBRA A (C89) 2.0 i 16V (M07) 02.1994/07.1997 100KW 136CV 1998CC X 20 XEV 0039922 - OPEL CALIBRA A (C89) 2.0 i 16V 4x4 (M07) 06.1990/02.1994 110KW 150CV 1998CC C 20 XE 0039843 - OPEL CALIBRA A (C89) 2.0 i 16V 4x4 (M07)...</p> <p>d74/63x125mm 1f-d50mm 1f-d38mm</p>		<p>F1373-I NO. 1603141 - 374040 - 90009020 - 90112609 - 90421756</p> <p>FOLE DA TRANSMISSÃO JUNTO À CAIXA</p> <p>OPEL CALIBRA A 2.0i - 2.0i 16V - 2.0iT 16V 4X4 - 2.5i V6 (90 A 97)</p> <p>d87x99mm 1f-d65mm 1f-d22mm</p>
	<p>F4094 NO. 0738978 - 5738414 - 738978 - 90373314 - 90437426</p> <p>FOLE ALAVANCA VELOCIDADES</p> <p>OPEL CALIBRA A (C89): 2.0 i (M07) 08.1989/12.1996 85KW 115CV 1998CC - OPEL CALIBRA A (C89): 2.0 i 4x4 (M07) 06.1990/07.1997 85KW 115CV 1998CC - OPEL CALIBRA A (C89): 2.0 i 16V (M07) 02.1994/07.1997 100KW 136CV 1998CC - OPEL CALIBRA A (C89): 2.0 i 16V 4x4 (M07) 02.1994/07.1997 100KW 136CV 1998CC - OPEL CALIBRA A (C89): 2.0 i 16V (M07) 06.1990/02.1994 110KW 150CV 1998CC - OPEL CALIBRA A (C89): 2.0 i...</p> <p>170x120x220mm 1f-160x105mm 1f-d50mm</p>		<p>F4094 NO. 0738978 - 5738414 - 738978 - 90373314 - 90437426</p> <p>FOLE ALAVANCA VELOCIDADES</p> <p>OPEL SINTRA (APV): 2.2 i 16V (OUN16, Y94) 11.1996/04.1999 104KW 141CV 2198CC - OPEL SINTRA (APV): 3.0 i 24V (OUN16, Y94) 11.1996/04.1999 148KW 201CV 2962CC - OPEL SINTRA (APV): 2.2 DTI 07.1997/04.1999 85KW 116CV 2171CC</p> <p>170x120x220mm 1f-160x105mm 1f-d50mm</p>
	<p>KF2340 NO. 1603179 - 374050 - 90125491</p> <p>FOLE DO LADO DA RODA</p> <p>OPEL CALIBRA (A) 2.0i - 2.0i 16v - 2.0i 16v 4x4 - 2.0i 4x4 - 2.0i T 4x4 - 2.5i V6 (1990 A 1997)</p> <p>d103x78mm 1f-d22mm 1f-d82mm</p>		<p>L3020 NO. 0856700 - 856700 - 9275758</p> <p>CASQUILHO DE ESCAPE</p> <p>OPEL CALIBRA A (C89): 2.0 i (M07) 08.1989/12.1996 85KW 115CV 1998CC</p> <p>d29x12mm d26/di19x8mm 1f-d9mm</p>
	<p>L3182 NO. 0444325 - 0444326 - 0444336 - 0444348 - 444325 - 444336 - 444348 - 6655341 - 8971400891 - 90343305 - ...</p> <p>CASQUILHO DA BARRA ESTABILIZADORA DE TRÁS</p> <p>OPEL CALIBRA A</p> <p>d26x28mm d24mm 1f-d13mm</p>		<p>M6045 NO. 854936 - 90231063</p> <p>JUNTA DE ESCAPE</p> <p>OPEL CALIBRA (APÓS 1990)</p> <p>95x92mm 1f-d55mm</p>
	<p>M6060 NO. 854948 - 90423152</p> <p>JUNTA DE ESCAPE</p> <p>OPEL CALIBRA (APÓS 1989)</p> <p>93x95mm 1f-d60mm</p>		<p>N2335 NO. 175538</p> <p>ANEL ESCAPE</p> <p>OPEL CLIBRA</p> <p>d65x15mm 1f-d36mm</p>

	<p>N2336 NO. 852711</p> <p>ANEL ESCAPE</p> <p>OPEL CALIBRA A (C89): 2.0 i (M07) 08.1989/12.1996 85K 115CV 1998CC - OPEL CALIBRA A (C89): 2.0 i 16V (M07) 06.1990/02.1994 110KW 150CV 1998CC</p> <p>d62x14mm 1f-d36mm</p>		<p>P1012 NO. 0560808 - 560808 - 90105172</p> <p>CAPA PEDAL EMBRAIAGEM/TRAVAO (GASTA 2 UNIDADES)</p> <p>OPEL CALIBRA A (C89): 2.0 i (M07) 08.1989/12.1996 85KW 115CV 1998CC - OPEL CALIBRA A (C89): 2.0 i 4x4 (M07) 06.1990/07.1997 85KW 115CV 1998CC - OPEL CALIBRA A (C89): 2.0 i 16V (M07) 02.1994/07.1997 100KW 136CV 1998CC - OPEL CALIBRA A (C89): 2.0 i 16V 4x4 (M07) 02.1994/07.1997 100KW 136CV 1998CC - OPEL CALIBRA A (C89): 2.0 i 16V (M07) 06.1990/02.1994 110KW 150CV 1998CC - OPEL CALIBRA A (C89): 2.0 i...</p> <p>60x55x9mm</p>
	<p>R080249 NO. 1336062 - 90265800 - 90322216</p> <p>TUBO RÍGIDO REFRIGERAÇÃO</p> <p>OPEL CALIBRA A (C89) 2.0 i (M07) 08.1989/12.1996 85KW 115CV 1998CC C 20 NE 0039844 - OPEL CALIBRA A (C89) 2.0 i 4x4 (M07) 06.1990/07.1997 85KW 115CV 1998CC C 20 NE 0039842</p> <p>B325-34/32mm 284-80mm 2f-d7mm 3p-d15x26mm</p>		<p>R8078 NO. 1336328 - 1337393 - 90322911 - 90570033</p> <p>TUBO DE LIGAÇÃO À BOMBA DE ÁGUA</p> <p>OPEL CALIBRA A (C89) 2.0 i 16V (M07) 06.1990/02.1994 110KW 150CV 1998CC C 20 XE 0039845 - OPEL CALIBRA A (C89) 2.0 i 16V 4x4 (M07) 06.1990/02.1994 110KW 150CV 1998CC C 20 XE 0039843 - OPEL CALIBRA A (C89) 2.0 i Turbo 4x4 (M07) 08.1991/07.1997 150KW 204CV 1998CC C 20 LET 0039870</p> <p>B171-d40/34mm d27mm 45-90-45mm 85-80mm</p>
	<p>RT08545 NO. 562345 - 562350 - 562358 - 90235568 - 90374106 - 90468316 - 90468319</p> <p>TUBO DE TRAVÃO FRENTE LH-RH</p> <p>OPEL CALIBRA A (C89): 2.0 i (M07) 08.1989/12.1996 85KW 115CV 1998CC - OPEL CALIBRA A (C89): 2.0 i 4x4 (M07) 06.1990/07.1997 85KW 115CV 1998CC - OPEL CALIBRA A (C89): 2.0 i 16V (M07) 02.1994/07.1997 100KW 136CV 1998CC - OPEL CALIBRA A (C89): 2.0 i 16V 4x4 (M07) 02.1994/07.1997 100KW 136CV 1998CC - OPEL CALIBRA A (C89): 2.0 i 16V (M07) 06.1990/02.1994 110KW 150CV 1998CC - OPEL CALIBRA A (C89): 2.0 i...</p> <p>310mm FB3/1 - OR1</p>		<p>S1127 NO. 352300 - 352346</p> <p>SILENT-BLOC DO BRAÇO DA SUSPENSÃO FRENTE DIAM. 12mm</p> <p>OPEL CALIBRA (A) 2.0i - 2.0i 16v</p> <p>d43x60mm d38mm 1f-d12mm</p>
	<p>S1128 NO. 90268463 - 0352348 - 352347 - 352348 - 353460 - 90250709</p> <p>SILENT-BLOC EXTERIOR DO BRAÇO DA SUSPENSÃO FRENTE DIAM. 16mm</p> <p>OPEL CALIBRA (A) 2.0i (06-1990 A 09-1997)</p> <p>d68x58mm d60mm 1f-d16mm</p>		<p>S1688 NO. 402937</p> <p>SILENT-BLOC DO EIXO DA SUSPENSÃO DE TRÁS</p> <p>OPEL CALIBRA A (C89) 2.0 i (M07) (De 08-1989 Até 12-1996) 85KW 115CV 1998cc Coupé OPEL CALIBRA A (C89) 2.0 i 4x4 (M07) (De 06-1990 Até 07-1997) 85KW 115CV 1998cc Coupé OPEL CALIBRA A (C89) 2.0 i 16V (M07) (De 02-1994 Até 07-1997) 100KW 136CV 1998cc Coupé OPEL CALIBRA A (C89) 2.0 i 16V 4x4 (M07) (De 02-1994 Até 07-1997) 100KW 136CV 1998cc Coupé OPEL CALIBRA A (C89) 2.0 i 16V (M07) (De 06-1990 Até 0...</p> <p>d121x80mm c46mm 1f-d19mm</p>
	<p>T1049F24 NO. 0350125 - 447869</p> <p>BATENTE DO CENTRO DA BARRA ESTABILIZADORA</p> <p>OPEL CALIBRA (A) 2.0i (06-1990 A 09-1997)</p> <p>40x47x40mm 1f-d22mm</p>		<p>UMB84011 NO. 031126</p> <p>TAMPÃO BLOCO MOTOR</p> <p>OPEL CALIBRA A (C89) 2.0 i 16V (M07) (De 02-1994 Até 07-1997) 100KW 136CV 1998cc Coupé OPEL CALIBRA A (C89) 2.0 i 16V 4x4 (M07) (De 02-1994 Até 07-1997) 100KW 136CV 1998cc Coupé OPEL CALIBRA A (C89) 2.0 i 16V (M07) (De 06-1990 Até 02-1994) 110KW 150CV 1998cc Coupé OPEL CALIBRA A (C89) 2.0 i 16V 4x4 (M07) (De 06-1990 Até 02-1994) 110KW 150CV 1998cc Coupé OPEL CALIBRA A (C89) 2.0 i Turbo 4x4 (M07) (...)</p> <p>d-18x8mm di-16mm</p>
	<p>UMB84011L NO. 11062402 - 2060675</p> <p>TAMPÃO BLOCO DE MOTOR (RELAS)</p> <p>OPEL CALIBRA A (C89) 2.0 i 16V (M07) (De 02-1994 Até 07-1997) 100KW 136CV 1998cc Coupé OPEL CALIBRA A (C89) 2.0 i 16V 4x4 (M07) (De 02-1994 Até 07-1997) 100KW 136CV 1998cc Coupé OPEL CALIBRA A (C89) 2.0 i 16V (M07) (De 06-1990 Até 02-1994) 110KW 150CV 1998cc Coupé OPEL CALIBRA A (C89) 2.0 i 16V 4x4 (M07) (De 06-1990 Até 02-1994) 110KW 150CV 1998cc Coupé OPEL CALIBRA A (C89) 2.0 i Turbo 4x4 (M07) (...)</p> <p>d-18x8mm di-16mm</p>		<p>UMB84019 NO. 2060668</p> <p>TAMPÃO BLOCO MOTOR</p> <p>OPEL CALIBRA A (C89) 2.0 i (M07) (De 06-1990 Até 07-1997) 85KW 115CV 1998cc Coupé OPEL CALIBRA A (C89) 2.0 i 4x4 (M07) (De 06-1990 Até 07-1997) 85KW 115CV 1998cc Coupé</p> <p>d-26x9,5mm di-23,3mm</p>
	<p>UMB84019L NO. 2060668</p> <p>TAMPÃO BLOCO DE MOTOR (RELAS)</p> <p>OPEL CALIBRA A (C89) 2.0 i (M07) (De 06-1990 Até 07-1997) 85KW 115CV 1998cc Coupé OPEL CALIBRA A (C89) 2.0 i 4x4 (M07) (De 06-1990 Até 07-1997) 85KW 115CV 1998cc Coupé</p> <p>d-26x9,5mm di-23,3mm</p>		<p>UMB84021 NO. 2060673</p> <p>TAMPÃO BLOCO MOTOR</p> <p>OPEL CALIBRA A (C89) 2.0 i (M07) (De 06-1990 Até 07-1997) 85KW 115CV 1998cc Coupé OPEL CALIBRA A (C89) 2.0 i 4x4 (M07) (De 06-1990 Até 07-1997) 85KW 115CV 1998cc Coupé</p> <p>d-28x7mm di-25,6mm</p>
	<p>UMB84021L NO. 2060673</p> <p>TAMPÃO BLOCO DE MOTOR (RELAS)</p> <p>OPEL CALIBRA A (C89) 2.0 i (M07) (De 06-1990 Até 07-1997) 85KW 115CV 1998cc Coupé OPEL CALIBRA A (C89) 2.0 i 4x4 (M07) (De 06-1990 Até 07-1997) 85KW 115CV 1998cc Coupé</p> <p>d-28x7mm di-25,6mm</p>		<p>UMB84026L NO. 11056093 - 2060665</p> <p>TAMPÃO BLOCO DE MOTOR (RELAS)</p> <p>OPEL CALIBRA A</p> <p>d-34x13mm di-31,2mm</p>

	<p>UMB84029 NO. 2060946</p> <p>TAMPÃO BLOCO MOTOR</p> <p>OPEL CALIBRA A (C89) 2.0 i (M07) (08.89 A 12.96) 115cv 1998cc Coupé - OPEL CALIBRA A (C89) 2.0 i Turbo 4x4 (M07) (08.91 A 07.97) 204cv 1998cc Coupé</p> <p>d36x10mm di-32mm</p>		<p>UTR0800 NO. 1304240 - 1304654 - 1304659 - 1304660 - 1304661 - 1304665 - 1304666 - 1304667 - 1304853 - 90352470 - ...</p> <p>TAMPÃO RESERVATÓRIO LIQUIDO REFRIGERAÇÃO</p> <p>OPEL CALIBRA A (85_) 2.0 i (06.90 A 07.97) 115cv 1998cc Coupé - OPEL CALIBRA A (85_) 2.0 i 4x4 (06.90 A 07.97) 115cv 1998cc Coupé - OPEL CALIBRA A (85_) 2.0 i 16V (02.94 A 07.97) 136cv 1998cc Coupé - OPEL CALIBRA A (85_) 2.0 i 16V 4x4 (02.94 A 07.97) 136cv 1998cc Coupé - OPEL CALIBRA A (85_) 2.0 i 16V (06.90 A 02.94) 150cv 1998cc Coupé - OPEL CALIBRA A (85_) 2.0 i 16V 4x4 (06.90 A 02.94)...</p> <p>d62x25mm 1f-d53x14mm</p>
	<p>UTR0811 NO. 1304659 - 1304660 - 1304661 - 1304665 - 1304666 - 1304853 - 4395513 - 90352470 - 90409256 - 90409257...</p> <p>TAMPÃO RESERVATÓRIO LIQUIDO REFRIGERAÇÃO</p> <p>OPEL CALIBRA A 2.5 i V6 (04.93 A 07.97) 170cv 2498cc Coupé</p> <p>60x25mm 1f-d52x14mm</p>		<p>UTR0820 NO. 90352470 - 90409256 - 90409257 - 9041032690497472 - 90467473</p> <p>TAMPÃO RESERVATÓRIO LIQUIDO REFRIGERAÇÃO</p> <p>OPEL CALIBRA A (85_) 2.0 i (06.90 A 07.97) 115cv 1998cc Coupé - OPEL CALIBRA A (85_) 2.0 i 4x4 (06.90 A 07.97) 115cv 1998cc Coupé - OPEL CALIBRA A (85_) 2.0 i 16V (02.94 A 07.97) 136cv 1998cc Coupé - OPEL CALIBRA A (85_) 2.0 i 16V 4x4 (02.94 A 07.97) 136cv 1998cc Coupé - OPEL CALIBRA A (85_) 2.0 i 16V (06.90 A 02.94) 150cv 1998cc Coupé - OPEL CALIBRA A (85_) 2.0 i 16V 4x4 (06.90 A 02.94)...</p> <p>d62x23mm 1f-d53x12mm</p>
	<p>UTR1305 NO. 0650089 - 650089</p> <p>TAMPÃO DO RESERVATÓRIO ÓLEO</p> <p>OPEL CALIBRA A (C89) 2.0 i (M07) 08.1989/12.1996 85KW 115CV 1998CC C 20 NE 0039844 - OPEL CALIBRA A (C89) 2.0 i 16V (M07) 06.1990/02.1994 110KW 150CV 1998CC C 20 XE 0039845 - OPEL CALIBRA A (C89) 2.0 i 16V (M07) 02.1994/07.1997 100KW 136CV 1998CC X 20 XEV 0039922 - OPEL CALIBRA A (C89) 2.0 i 16V 4x4 (M07) 06.1990/02.1994 110KW 150CV 1998CC C 20 XE 0039843 - OPEL CALIBRA A (C89) 2.0 i 16V 4x4 (M07)...</p> <p>d61x23mm d32x19mm</p>		<p>UTV83011 NO. 0652475 - 09275631 - 652475 - 652491 - 90409376 - 9275631 - N90288901</p> <p>TAMPÃO VEDAÇÃO BUJÃO</p> <p>OPEL CALIBRA A (C89) 2.0 i (M07) (De 08-1989 Até 12-1996) 85kW 115CV 1998cc Coupé OPEL CALIBRA A (C89) 2.0 i 4x4 (M07) (De 06-1990 Até 07-1997) 85kW 115CV 1998cc Coupé OPEL CALIBRA A (C89) 2.0 i 16V (M07) (De 02-1994 Até 07-1997) 100kW 136CV 1998cc Coupé OPEL CALIBRA A (C89) 2.0 i 16V 4x4 (M07) (De 02-1994 Até 07-1997) 100kW 136CV 1998cc Coupé OPEL CALIBRA A (C89) 2.0 i 16V 4x4 (M07) (De 02-1994 Até 07-1997) 100kW 136CV 1998cc Coupé OPEL CALIBRA A (C89) 2.0 i 16V (M07) (De 06-1990 Até 0...</p> <p>19x18mm c12mm d14mm</p>
	<p>UTV83019 NO. 0652315 - 0652477 - 652315 - 652477 - 90502556 - 96023264</p> <p>TAMPÃO VEDAÇÃO BUJÃO</p> <p>OPEL CALIBRA A (C89) 2.0 i 16V (M07) (De 02-1994 Até 07-1997) 100kW 136CV 1998cc Coupé OPEL CALIBRA A (C89) 2.0 i 16V 4x4 (M07) (De 02-1994 Até 07-1997) 100kW 136CV 1998cc Coupé</p> <p>d25x14mm c9mm d13mm</p>		<p>W5034 NO. 614654</p> <p>POLIE DA CAMBOTA (6 PISTAS)</p> <p>OPEL CALIBRA (A) 2.0i 16v 4x4 Motor X20 XEV (02-1994 A 07-1997)</p> <p>d138mm d42mm</p>
	<p>Y3212 NO. 1008501 - 1008504 - 4709077</p> <p>PARAFUSO PERNO RODA CHAVE 17 M12X1,50X48MM (BASE CONICA PARA JANTES AÇO E LIGA LEVE)</p> <p>OPEL CALIBRA A (C89) 2.0 i (M07) (08.1989 - 12.1996) 85kw 115cv 1998cm3 Coupé OPEL CALIBRA A (C89) 2.0 i 16V (M07) (02.1994 - 07.1997) 100kw 136cv 1998cm3 Coupé OPEL CALIBRA A (C89) 2.0 i 16V (M07) (06.1990 - 02.1994) 110kw 150cv 1998cm3 Coupé OPEL CALIBRA A (C89) 2.0 i 16V 4x4 (M07) (02.1994 - 07.1997) 100kw 136cv 1998cm3 Coupé OPEL CALIBRA A (C89) 2.0 i 16V 4x4 (M07) (06.1990 - 02.1994) 110kw 15...</p> <p>C48mm (Ch-17mm) M12x1,50x22mm</p>		<p>Z80540 NO. 2240861 - 90022049</p> <p>Mola de painel</p> <p>OPEL CALIBRA</p> <p>d12x14.3mm 1p-d7-12.3mm</p>
	<p>Z9004 NO. 856563</p> <p>MOLA DE ESCAPE</p> <p>OPEL CALIBRA (APÓS 1993)</p> <p>25x22x5mm</p>		<p>Z9011 NO. 1261479 - 1449282600 - 4709339 - 4711509 - 854880</p> <p>MOLA DE ESCAPE</p> <p>OPEL CALIBRA</p> <p>d23x42mm</p>

OPEL CAMPO

	<p>A1237 NO. 1-08900-039-0 - 8-94202521-0 - 8-942045211 - 8-94222-972-0</p> <p>APOIO DE TRANSMISSÃO COM ROLAMENTO 25MM</p> <p>OPEL CAMPO</p> <p>135x120x60mm 1f-d25mm</p>		<p>A1373 NO. 8-942239-3 - 8-94459-452-2</p> <p>APOIO BATENTE DE MOLA TRÁS (GASTA 2 UNIDADES)</p> <p>OPEL CAMPO (TF0, TF1): 2.3 (TFR16) 08.1991/08.1994 69KW 94CV 2255CC - OPEL CAMPO (TF0, TF1): 2.3 4x4 (TFS16) 08.1991/08.1994 69KW 94CV 2255CC - OPEL CAMPO (TF0, TF1): 2.3 (TFR16) 08.1994/09.1996 72KW 98CV 2254CC - OPEL CAMPO (TF0, TF1): 2.3 4x4 (TFS16) 08.1994 - 09.1996 72KW 98CV 2254CC - OPEL CAMPO (TF0, TF1): 2.5 D (TFR54) 08.1991/06.1994 56KW 76CV 2499CC - OPEL CAMPO (TF0, TF1): 2.5 D 4x4 (TFS5...</p> <p>150x75x65mm</p>
--	--	--	---

	<p>A1416 NO. 8-94259-086-0 - 8-94259-086-A</p> <p>APOIO BATENTE BRAÇO DE SUSPENSÃO FRENTE SUPERIOR (GASTA 2 UNIDADES) OPEL CAMPO PICK-UP TBR54 2.5 11.1996/»»»</p>		<p>A1422 NO. 91162338 - 5684105 - 8-97910-967-0 - 97149837</p> <p>APOIO DE MOTOR ESQUERDO</p> <p>OPEL CAMPO 2.5D - OPEL CAMPO 2.8D</p>
	<p>A1425 NO. 8-97910-966-0 - 8-97916-330-0 - 91162337</p> <p>APOIO DE MOTOR DIREITO</p> <p>OPEL CAMPO 2.5D - OPEL CAMPO 2.8D</p>		<p>A1493 NO. 8-94202520-0 - 8-94204-521-0 - 8-94222-970-0</p> <p>APOIO DE TRANSMISSÃO COM ROLAMENTO 25MM</p> <p>OPEL CAMPO 2300</p>
	<p>A1494 NO. 8-94328-799-0 - 8-94386-854-0</p> <p>APOIO DE TRANSMISSÃO COM ROLAMENTO 30MM</p> <p>OPEL CAMPO (KB): 2.0 (KB28) 06.1985/12.1988 58KW 79CV 1950CC - OPEL CAMPO (KB): 2.0 4WD (KB48) 06.1985/12.1988 58KW 79CV 1950CC - OPEL CAMPO (KB): 2.2 D (KBD27) 04.1986/12.1990 39KW 53CV 2238CC - OPEL CAMPO (KB): 2.2 D 4WD (KBD42, KBD47) 01.1983/12.1990 39KW 53CV 2238CC - OPEL CAMPO (KB): 2.2 D (KBD27) 01.1983/12.1991 45KW 61CV 2238CC - OPEL CAMPO (KB): 2.5 D (KB27) 01.1983/12.1990 55KW 75CV 2499C...</p>		<p>A1495 NO. 89040334</p> <p>APOIO DE TRANSMISSÃO COM ROLAMENTO 30MM</p> <p>OPEL P/UP CAMPO 2.3 - OPEL P/UP CAMPO 2.5 - OPEL P/UP CAMPO 2500DI</p>
	<p>A1543 NO. 8-94334-159-0 - 8-94434-207-1 - 8-94482-408-0 - 8-97976-331-0</p> <p>APOIO DE MOTOR ESQUERDO</p> <p>OPEL CAMPO 2WD TFR/ TFS## 88-96 (MOTOR 4JB1)</p>		<p>A1544 NO. 8-94334-158-0 - 8-94482-407-0</p> <p>APOIO DE MOTOR DIREITO</p> <p>OPEL CAMPO 2WD TFR/ TFS## 88-96 (MOTOR 4JB1)</p>
	<p>A2009 NO. 5684105 - 8-97039-190-2 - 8-97039-190-3 - 8-97086-076-1 - 8-97910-967-0 - 8-97916-331-0 - 8-97941-90-0</p> <p>APOIO DE MOTOR ESQUERDO</p> <p>OPEL CAMPO 2.5D - OPEL CAMPO 2.8D</p>		<p>A2010 NO. 8-97910-966-0 - 8-97916-330-0 - 91162337 - 97149836</p> <p>APOIO DE MOTOR DIREITO</p> <p>OPEL CAMPO 2.5D - OPEL CAMPO 2.8D</p>
	<p>E0078 NO. 8-94223-156-0</p> <p>ESTICADOR BARRA ESTABILIZADORA FRENTE (GASTA 2 UNIDADES)</p> <p>OPEL CAMPO (TF0, TF1): 2.3 (TFR16) 08.1991/08.1994 69KW 94CV 2255CC - OPEL CAMPO (TF0, TF1): 2.3 4x4 (TFS16) 08.1991/08.1994 69KW 94CV 2255CC - OPEL CAMPO (TF0, TF1): 2.3 (TFR16) 08.1994/09.1996 72KW 98CV 2254CC - OPEL CAMPO (TF0, TF1): 2.3 4x4 (TFS16) 08.1994 - 09.1996 72KW 98CV 2254CC - OPEL CAMPO (TF0, TF1): 2.5 D (TFR54) 08.1991/06.1994 56KW 76CV 2499CC - OPEL CAMPO (TF0, TF1): 2.5 D 4x4 (TFS5...</p>		<p>E1054 NO. 852725 - 97023183</p> <p>ESTICADOR DE ESCAPE</p> <p>OPEL CAMPO (1988 A 1994)</p>
	<p>E1075 NO. 4295700</p> <p>ESTICADOR ESCAPE</p> <p>OPEL CAMPO (1988 A 1994)</p>		<p>E1117 NO. 4410148 - 4422016 - 91166194 - 93865793</p> <p>ESTICADOR DO ESCAPE</p> <p>OPEL CAMPO (TF_) 2.3 (TFR16) (08.91 A 08.94) 94cv 2255cc Pick-up - OPEL CAMPO (TF_) 2.5 D (TFR54) (08.91 A 06.94) 76cv 2499cc Pick-up</p>
	<p>KF1612 NO. 0374075 - 301710 - 374075 - 8-97138981-1 - 97138981 - 97148749</p> <p>KIT DE FOLE DO CARDAN LADO DA RODA</p> <p>OPEL CAMPO 3.1 TDIC (APÓS 10-1996)</p>		<p>KF2326 NO. 301403 - 94312680</p> <p>KIT DE FOLE LADO DA RODA</p> <p>OPEL CAMPO 2.5 DTi (APÓS 1987)</p>

	<p>KF2327 NO. 94312678</p> <p>KIT DE FOLE TRANSMISSAO</p> <p>OPEL P/UP CAMPO (KB): 2.2 D 4WD (KBD42, KBD47) 01.1983/12.1990 39KW 53CV 2238CC - OPEL P/UP CAMPO (KB): 2.5 D (KB27) 01.1983/12.1990 55KW 75CV 2499CC - OPEL P/UP CAMPO (KB): 2.5 D 4WD (KBD47) 01.1983/12.1990 55KW 75CV 2499CC - OPEL P/UP CAMPO (TF0, TF1): 2.3 (TFR16) 08.1991/08.1994 69KW 94CV 2255CC - OPEL P/UP CAMPO (TF0, TF1): 2.3 4x4 (TFS16) 08.1991/08.1994 69KW 94CV 2255CC - OPEL P/UP CAMPO (TF...)</p> <p>d86x84mm 1f-d76mm 1f-d22mm</p>		<p>KL3068 NO. 8-944-33-672-0K - 8-94433-672-0</p> <p>KIT CASQUILHOS DE ESTICADOR DE SUSPENSAO (GASTA 2 UNIDADES)</p> <p>OPEL CAMPO (WSZYSTKIE) 2.2 - 2.3 - 2.5 TD - 3.1 08.1987/12.2000 - Isuzu Pickup 1987 2.3 L4 From 12-1987 - Isuzu Pickup 1988-1990 2.3 L4 RWD, From 12-1987 - Isuzu Pickup 1988 S 2WD, From 12-1987 - Isuzu Pickup 1988-1990 LS 2.6 L4 From 12-1987 - Isuzu Pickup 1988-1990 1 Ton 2WD From 12-1987 - Isuzu Pickup 1989 XS 2.6 L4 - Isuzu Pickup 1989-1990 S 2.6 L4 - Isuzu Pickup 1990 XS 2WD - Isuzu Pickup 1991...</p> <p>d54x30mm d62x7mm d22x16x52mm 1f-d18mm 1f-d18mm</p>
	<p>KL3115 NO. 8-94223-0 - 8-94223-699-0 - 9-51631-619-1</p> <p>KIT CASQUILHOS DE ESTICADOR DE SUSPENSAO (GASTA 2 UNIDADES)</p> <p>ISUZU P/UP BRAVA 1989/1996 - ISUZU P/UP KBZ</p> <p>d42x19mm d52x4mm d52x17x42mm d14mm 1f-d21mm 1f-d14mm</p>		<p>KM0404 NO. 98005814</p> <p>KIT BRINCOS DE MOLAS TRÁS PARTE DE TRAS (GASTA 2 UNIDADES)</p> <p>OPEL CAMPO (KB): 2.0 4WD (KB48) 06.1985/12.1988 58KW 79CV 1950CC - OPEL CAMPO (KB): 2.2 D (KBD27) 04.1986/12.1990 39KW 53CV 2238CC - OPEL CAMPO (KB): 2.2 D 4WD (KBD42, KBD47) 01.1983/12.1990 39KW 53CV 2238CC - OPEL CAMPO (TF0, TF1): 2.3 (TFR16) 08.1994/09.1996 72KW 98CV 2254CC - OPEL CAMPO (TF0, TF1): 2.3 4x4 (TFS16) 08.1991/08.1994 69KW 94CV 2254CC - OPEL CAMPO (TF0, TF1): 2.5 D (TFR54) 08.1991/0...</p> <p>132x90x40mm d30mm</p>
	<p>KM0417 NO. 94223167</p> <p>KIT BRINCOS DE MOLAS TRÁS PARTE DE TRAS (GASTA 2 UNIDADES)</p> <p>OPEL CAMPO (TF0, TF1) 2.3 4x4 (TFS16) 08.1991/08.1994 69KW 94CV 2254CC 4 ZD1 7115003</p> <p>128x95x41mm 2d-18mm 2p-d13.8-22mm</p>		<p>KMEX0001 NO. 0308456 - 0308575 - 0308700 - 308456 - 308575 - 308700 - 94407708 - 94407718 - 97123691</p> <p>KIT REPARAÇÃO MANGA DE EIXO</p> <p>OPEL CAMPO (TF0, TF1) 2.3 (TFR16) 08.1991/08.1994 69KW 94CV 2254CC 4 ZD1 7115001 - OPEL CAMPO (TF0, TF1) 2.3 (TFR16) 08.1994/09.1996 72KW 98CV 2254CC 4 ZD1 7115008 - OPEL CAMPO (TF0, TF1) 2.3 4x4 (TFS16) 08.1991/08.1994 69KW 94CV 2254CC 4 ZD1 7115003 - OPEL CAMPO (TF0, TF1) 2.3 4x4 (TFS16) 08.1994/09.1996 72KW 98CV 2254CC 4 ZD1 7115007 - OPEL CAMPO (TF0, TF1) 2.5 D (TFR54) 08.1991/06.1994 56KW 76...</p> <p>d87x18mm d53x2mm d37x16x52mm 1f-d34mm 1f-d30mm</p>
	<p>L1013 NO. 00432751 - 0432751 - 094234319 - 432751 - 5-51151-007-0 - 8-94234-190-0 - 8-94234-319-0 - 8-97332-6...</p> <p>CASQUILHO DE MOLAS DE TRÁS PARTE DE TRAS (8 UNIDADES)</p> <p>OPEL CAMPO (KB): 2.0 4WD (KB48) 06.1985/12.1988 58KW 79CV 1950CC - OPEL CAMPO (KB): 2.2 D (KBD27) 04.1986/12.1990 39KW 53CV 2238CC - OPEL CAMPO (KB): 2.2 D 4WD (KBD42, KBD47) 01.1983/12.1990 39KW 53CV 2238CC - OPEL CAMPO (TF0, TF1): 2.3 (TFR16) 08.1994/09.1996 72KW 98CV 2254CC - OPEL CAMPO (TF0, TF1): 2.3 4x4 (TFS16) 08.1991/08.1994 69KW 94CV 2254CC - OPEL CAMPO (TF0, TF1): 2.5 D (TFR54) 08.1991/0...</p> <p>d36x38mm d30mm 1f-d18mm</p>		<p>L1042 NO. 894223-168-0</p> <p>CASQUILHO DE MOLAS DE TRÁS PARTE DA FRENTE (4 UNIDADES)</p> <p>OPEL CAMPO (KB): 2.0 4WD (KB48) 06.1985/12.1988 58KW 79CV 1950CC - OPEL CAMPO (KB): 2.2 D (KBD27) 04.1986/12.1990 39KW 53CV 2238CC - OPEL CAMPO (KB): 2.2 D 4WD (KBD42, KBD47) 01.1983/12.1990 39KW 53CV 2238CC - OPEL CAMPO (TF0, TF1): 2.3 (TFR16) 08.1994/09.1996 72KW 98CV 2254CC - OPEL CAMPO (TF0, TF1): 2.3 4x4 (TFS16) 08.1991/08.1994 69KW 94CV 2254CC - OPEL CAMPO (TF0, TF1): 2.5 D (TFR54) 08.1991/0...</p> <p>d45x35mm d40mm 1f-d18mm</p>
	<p>L3068 NO. 4301733 - 8944336720</p> <p>CASQUILHO DO ESTICADOR DA SUSPENSAO (GASTA 4 UNIDADES)</p> <p>OPEL CAMPO (WSZYSTKIE) 2.2 - 2.3 - 2.5 TD - 3.1 08.1987/12.2000 - Isuzu Pickup 1987 2.3 L4 From 12-1987 - Isuzu Pickup 1988-1990 2.3 L4 RWD, From 12-1987 - Isuzu Pickup 1988 S 2WD, From 12-1987 - Isuzu Pickup 1988-1990 LS 2.6 L4 From 12-1987 - Isuzu Pickup 1988-1990 1 Ton 2WD From 12-1987 - Isuzu Pickup 1989 XS 2.6 L4 - Isuzu Pickup 1989-1990 S 2.6 L4 - Isuzu Pickup 1990 XS 2WD - Isuzu Pickup 1991...</p> <p>d53x31mm d39mm 1f-d22mm</p>		<p>L3109 NO. 0423751 - 094234319 - 423751 - 8-94234-190-0 - 8-94234-319-0 - 8-97332-642-0 - 8-97357-492-0 - 94234...</p> <p>CASQUILHO DE MOLAS DE TRÁS PARTE DE TRAS (8 UNIDADES)</p> <p>OPEL CAMPO (TF0, TF1): 2.3 (TFR16) 08.1991/08.1994 69KW 94CV 2255CC - OPEL CAMPO (TF0, TF1): 2.3 4x4 (TFS16) 08.1991/08.1994 69KW 94CV 2255CC - OPEL CAMPO (TF0, TF1): 2.3 (TFR16) 08.1994/09.1996 72KW 98CV 2254CC - OPEL CAMPO (TF0, TF1): 2.3 4x4 (TFS16) 08.1991/08.1994 69KW 94CV 2254CC - OPEL CAMPO (TF0, TF1): 2.5 D (TFR54) 08.1991/06.1994 56KW 76CV 2499CC - OPEL CAMPO (TF0, TF1): 2.5 D 4x4 (TFS54) ...</p> <p>d36x36mm d30mm 1f-d18mm</p>
	<p>L3115 NO. 8942236990 - 9516316191</p> <p>CASQUILHO DO ESTICADOR DA SUSPENSAO (GASTA 4 UNIDADES)</p> <p>OPEL P/UP CAMPO 1989/1996</p> <p>d41x19mm 1f-d17mm</p>		<p>L3182 NO. 0444325 - 0444326 - 0444336 - 0444348 - 444325 - 444336 - 444348 - 6655341 - 8971400891 - 90343305 ...</p> <p>CASQUILHO DA BARRA ESTABILIZADORA DE TRAS</p> <p>OPEL CAMPO</p> <p>d26x28mm d24mm 1f-d13mm</p>
	<p>M6008 NO. 854943</p> <p>JUNTA DE ESCAPE</p> <p>OPEL CAMPO (KB): 2.2 D (KBD27) 04.1986/12.1990 39KW 53CV 2238CC - OPEL CAMPO (KB): 2.2 D 4WD (KBD42, KBD47) 01.1983/12.1990 39KW 53CV 2238CC - OPEL CAMPO (KB): 2.2 D (KBD27) 01.1983/12.1991 45KW 61CV 2238CC</p> <p>d65x5mm 1f-d50mm</p>		<p>M6082 NO. 854943 - 854944 - 854955 - 97069287</p> <p>JUNTA DE ESCAPE</p> <p>OPEL CAMPO (1989 A 1990)</p> <p>d64x5mm 1f-d53mm</p>
	<p>M6089 NO. 4292557 - 854954</p> <p>JUNTA DE ESCAPE</p> <p>OPEL CAMPO (1990 A 1994)</p> <p>108x68x1.5mm 1f-d58mm</p>		<p>M6100 NO. 852803 - 94328352</p> <p>JUNTA DE ESCAPE</p> <p>OPEL CAMPO (1990 A 1994)</p> <p>116x80x2mm 1f-d65mm</p>

	<p>P1041 NO. 97318799</p> <p>CAPA PEDAL EMBRAIAGEM/TRAVAO (GASTA 2 UNIDADES)</p> <p>OPEL CAMPO (KB): 2.0 4WD (KB48) 06.1985/12.1988 58KW 79CV 1950CC - OPEL CAMPO (KB): 2.2 D (KBD27) 04.1986/12.1990 39KW 53CV 2238CC - OPEL CAMPO (KB): 2.2 D 4WD (KBD42, KBD47) 01.1983/12.1990 39KW 53CV 2238CC - OPEL CAMPO (TF0, TF1): 2.3 (TFR16) 08.1994/09.1996 72KW 98CV 2254CC - OPEL CAMPO (TF0, TF1): 2.3 4x4 (TFS16) 08.1994/09.1996 72KW 98CV 2254CC - OPEL CAMPO (TF0, TF1): 2.5 D (TFR54) 08.1991/0...</p> <p>62x53x11mm</p>		<p>S1244 NO. 0302411 - 0310400 - 29041-40K00 - 302292 - 302411 - 8-94408-840-0 - 8-94408-840-1 - 8-94408-840-2 - ...</p> <p>SILENT-BLOC DO BRAÇO DA SUSPENSÃO SUPERIOR (GASTA 4 UNIDADES)</p> <p>OPEL CAMPO (TF0, TF1): 2.3 (TFR16) 08.1991/08.1994 69KW 94CV 2255CC - OPEL CAMPO (TF0, TF1): 2.3 4x4 (TFS16) 08.1991/08.1994 69KW 94CV 2255CC - OPEL CAMPO (TF0, TF1): 2.3 (TFR16) 08.1994/09.1996 72KW 98CV 2254CC - OPEL CAMPO (TF0, TF1): 2.3 4x4 (TFS16) 08.1994/09.1996 72KW 98CV 2254CC - OPEL CAMPO (TF0, TF1): 2.5 D (TFR54) 08.1991/06.1994 56KW 76CV 2499CC - OPEL CAMPO (TF0, TF1): 2.5 D 4x4 (TFS54)...</p> <p>d50x45mm c33mm d38mm 1f-d18mm</p>
	<p>S1484 NO. 8-97104-178-0 - 0302411 - 0310400 - 29041-40K00 - 302292 - 302411 - 8-94408-840-0 - 8-94408-840-2 - ...</p> <p>SILENT-BLOC DO BRAÇO DA SUSPENSÃO SUPERIOR (GASTA 4 UNIDADES)</p> <p>OPEL CAMPO (TF0, TF1): 2.3 (TFR16) 08.1991/08.1994 69KW 94CV 2255CC - OPEL CAMPO (TF0, TF1): 2.3 4x4 (TFS16) 08.1991/08.1994 69KW 94CV 2255CC - OPEL CAMPO (TF0, TF1): 2.3 (TFR16) 08.1994/09.1996 72KW 98CV 2254CC - OPEL CAMPO (TF0, TF1): 2.3 4x4 (TFS16) 08.1994/09.1996 72KW 98CV 2254CC - OPEL CAMPO (TF0, TF1): 2.5 D (TFR54) 08.1991/06.1994 56KW 76CV 2499CC - OPEL CAMPO (TF0, TF1): 2.5 D 4x4 (TFS54)...</p> <p>d49.5x45mm c35mm d38mm 1f-d18.4mm</p>		<p>S1697 NO. 0302411 - 0310400 - 302292 - 97138388</p> <p>SILENT-BLOC DO BRAÇO DA SUSPENSÃO SUPERIOR (GASTA 4 UNIDADES)</p> <p>OPEL CAMPO (TF0 - TF1) 2.3 (TFR16) (De 08-1991 Até 08-1994) 69KW 94CV 2255cc Pick-up OPEL CAMPO (TF0 - TF1) 2.3 4x4 (TFS16) (De 08-1991 Até 08-1994) 69KW 94CV 2255cc Pick-up OPEL CAMPO (TF0 - TF1) 2.3 (TFR16) (De 08-1994 Até 09-1996) 72KW 98CV 2254cc Pick-up OPEL CAMPO (TF0 - TF1) 2.3 4x4 (TFS16) (De 08-1994 Até 09-1996) 72KW 98CV 2254cc Pick-up OPEL CAMPO (TF0 - TF1) 2.2 D (TFR52) (De 08-1991 Até...</p> <p>d49x45mm d38mm c32mm 1f-d18mm</p>
	<p>T1033 NO. 0350667 - 350667 - 8-94459-459-1 - 91132005</p> <p>BATENTE DA BARRA ESTABILIZADORA (CENTRO)</p> <p>OPEL CAMPO</p> <p>42x38x38mm 1f-d25mm</p>		<p>UTR0957 NO. 1326000 - 1326004 - 1326026 - 1326027 - 1326028 - 1326030 - 1326031 - 1326032</p> <p>TAMPÃO DO RADIADOR</p> <p>OPEL CAMPO (TF0, TF1) 2.3 (TFR16) (De 08.1991 Até 08.1994) 69KW 94CV 2254cm3 Pick-up - OPEL CAMPO (TF0, TF1) 2.3 (TFR16) (De 08.1994 Até 09.1996) 72KW 98CV 2254cm3 Pick-up - OPEL CAMPO (TF0, TF1) 2.3 4x4 (TFS16) (De 08.1991 Até 08.1994) 69KW 94CV 2254cm3 Pick-up - OPEL CAMPO (TF0, TF1) 2.3 4x4 (TFS16) (De 08.1994 Até 09.1996) 72KW 98CV 2254cm3 Pick-up - OPEL CAMPO (TF0, TF1) 2.5 D (TFR54) (De 08.1...</p> <p>d45x25mm d28x22mm</p>
	<p>UTR0958 NO. 1326000 - 1326004 - 1326026 - 1326027 - 1326028 - 1326030 - 1326031 - 1326032</p> <p>TAMPÃO RADIADOR</p> <p>OPEL CAMPO (TF0, TF1) 2.3 (TFR16) (De 08.1991 Até 08.1994) 69KW 94CV 2254cm3 Pick-up - OPEL CAMPO (TF0, TF1) 2.3 (TFR16) (De 08.1994 Até 09.1996) 72KW 98CV 2254cm3 Pick-up - OPEL CAMPO (TF0, TF1) 2.3 4x4 (TFS16) (De 08.1991 Até 08.1994) 69KW 94CV 2254cm3 Pick-up - OPEL CAMPO (TF0, TF1) 2.3 4x4 (TFS16) (De 08.1994 Até 09.1996) 72KW 98CV 2254cm3 Pick-up - OPEL CAMPO (TF0, TF1) 2.5 D (TFR54) (De 08.1...</p> <p>d45x29mm d28x21mm</p>		







OPEL COMBO

	<p>A1069 NO. 0682555 - 0682600 - 0682603 - 682555 - 682600 - 682603 - 90304647 - 90473837 - 90538063</p> <p>APOIO SUPORTE TRASEIRO DO MOTOR (CAIXA)</p> <p>OPEL COMBO Caixa/monovolume (71_) 1.2 07.1994/10.2001 33KW 45CV 1195CC X 12 SZ C 12 NZ 0039929 7526327 7526506 - OPEL COMBO Caixa/monovolume (71_) 1.4 07.1994/10.2001 44KW 60CV 1389CC X 14 SZ C 14 NZ 0039930 0039124 0039155 7526328 7526507 - OPEL COMBO Caixa/monovolume (71_) 1.4 07.1994/10.2001 60KW 82CV 1389CC C 14 SE 0039931 7526329 7526508 - OPEL COMBO Caixa/monovolume (71_) 1.7 D 07.1994/10.20...</p> <p>145x90x66mm 1f-d10mm</p>		<p>A1208 NO. 0684160 - 684160 - 90269291 - 90445304</p> <p>APOIO DE MOTOR (LADO DIREITO)</p> <p>OPEL COMBO Caixa/monovolume (71_) 1.2 07.1994/10.2001 33KW 45CV 1195CC X 12 SZ C 12 NZ 0039929 7526327 7526506 - OPEL COMBO Caixa/monovolume (71_) 1.4 07.1994/10.2001 44KW 60CV 1389CC X 14 SZ C 14 NZ 0039930 0039124 0039155 7526328 7526507 - OPEL COMBO Caixa/monovolume (71_) 1.4 07.1994/10.2001 60KW 82CV 1389CC C 14 SE 0039931 7526329 7526508 - OPEL COMBO Caixa/monovolume (71_) 1.7 D 07.1994/10.20...</p> <p>165x92x80mm 2f-d10mm</p>
	<p>A1209 NO. 0684661 - 0684665 - 0684671 - 684661 - 684665 - 684671 - 90444514 - 90444515 - 90444522 - 90444525 - ...</p> <p>APOIO FRENTE ESQUERDO DE MOTOR</p> <p>OPEL COMBO Caixa/monovolume (71_) 1.2 07.1994/10.2001 33KW 45CV 1195CC X 12 SZ C 12 NZ 0039929 7526327 7526506 - OPEL COMBO Caixa/monovolume (71_) 1.4 07.1994/10.2001 44KW 60CV 1389CC X 14 SZ C 14 NZ 0039930 0039124 0039155 7526328 7526507 - OPEL COMBO Caixa/monovolume (71_) 1.4 07.1994/10.2001 60KW 82CV 1389CC C 14 SE 0039931 7526329 7526508</p> <p>200x90x60mm 2r-d10mm</p>		<p>A1218 NO. 0344519 - 344502 - 344519 - 90445207 - 90445208</p> <p>APOIO DO AMORTECEDOR DE TRÁS</p> <p>OPEL COMBO Caixa/monovolume (71_) 1.2 07.1994/10.2001 33KW 45CV 1195CC - OPEL COMBO Caixa/monovolume (71_) 1.4 07.1994/10.2001 44KW 60CV 1389CC - OPEL COMBO Caixa/monovolume (71_) 1.4 07.1994/10.2001 60KW 82CV 1389CC - OPEL COMBO Caixa/monovolume (71_) 1.7 D 07.1994/10.2001 44KW 60CV 1686CC - OPEL COMBO Tour: 1.4 10.2004/12.2011 66KW 90CV 1364CC - OPEL COMBO Tour: 1.6 10.2001/09.2006 64KW 87CV...</p> <p>135x110x40mm 1f-d34mm</p>
	<p>A1314 NO. 344519 - 90445207</p> <p>APOIO DE AMORTECEDOR DA FRENTE</p> <p>OPEL COMBO Caixa/monovolume (71_) 1.2 07.1994/10.2001 33KW 45CV 1195CC - OPEL COMBO Caixa/monovolume (71_) 1.4 07.1994/10.2001 44KW 60CV 1389CC - OPEL COMBO Caixa/monovolume (71_) 1.4 07.1994/10.2001 60KW 82CV 1389CC - OPEL COMBO Caixa/monovolume (71_) 1.7 D 07.1994/10.2001 44KW 60CV 1686CC - OPEL COMBO Tour: 1.4 10.2004/12.2011 66KW 90CV 1364CC - OPEL COMBO Tour: 1.6 10.2001/09.2006 64KW 87CV...</p> <p>136x109x38mm 2p-d8-17mm 1f-d37mm</p>		<p>A2069 NO. 0684238 - 184398A - 24416545 - 684238 - 93302281</p> <p>APOIO MOTOR FRENTE CENTRO</p> <p>OPEL COMBO Tour 1.4 (De 10-2004 Até ...) 66kW 90CV 1364cc Veículo multiuso OPEL COMBO Tour 1.6 (De 10-2001 Até ...) 64kW 87CV 1598cc Veículo multiuso OPEL COMBO Tour 1.6 CNG (De 06-2006 Até ...) 69kW 94CV 1598cc Veículo multiuso OPEL COMBO Tour 1.6 CNG (De 04-2005 Até ...) 71kW 97CV 1598cc Veículo multiuso OPEL COMBO Tour 1.3 CDTI 16V (De 10-2004 Até ...) 51kW 69CV 1248cc Veículo multiuso OPE...</p> <p>204x94x84mm 1f-d16mm 2f-d12mm</p>

	<p>A2301 NO. 0684180 - 0684181 - 09227878 - 09227879 - 13125209 - 5684168 - 5684170</p> <p>APOIO DO MOTOR LADO DIREITO</p> <p>OPEL COMBO Caixa/Combi 1.4 16V (De 2005.08 -) 66kW 90cv 1364cm³ Caixa/Combi -</p> <p>175x117x100mm 2f-d11mm 2f-d17mm</p>		<p>A2594 NO. 13109203 - 5684761</p> <p>APOIO DO MOTOR PARTE DA FRENTE LADO ESQUERDO</p> <p>OPEL COMBO Caixa/monovolume 1.3 CDTI 16V (De 08.2005 -) 51kW 69cv 1248cm³ Caixa/monovolume - OPEL COMBO Caixa/monovolume 1.3 CDTI 16V (De 10.2005 Até 12.2012) 55kW 75cv 1248cm³ Caixa/monovolume - OPEL COMBO Caixa/monovolume 1.7 DI 16V (De 10.2001 -) 48kW 65cv 1686cm³ Caixa/monovolume - OPEL COMBO Caixa/monovolume 1.7 DTI 16V (De 10.2001 -) 55kW 75cv 1686cm³ Caixa/monovolume - OPEL COMBO Tour 1.3 C...</p> <p>175x114x140mm 2f-d19mm 4f-d9mm</p>
	<p>A2595 NO. 344811 - 344896 - 345070 - 345174 - 95511352 - 95514538 - 95516717 - 95521001</p> <p>APOIO DO AMORTECEDOR DA FRENTE LADO DIREITO</p> <p>OPEL COMBO Caixa/monovolume (X12) 1.3 CDTI (B05) (De 02.2012 -) 66kW 90cv 1248cm³ Caixa/monovolume - OPEL COMBO Caixa/monovolume (X12) 1.3 CDTI (B05) (De 03.2016 -) 70kW 95cv 1248cm³ Caixa/monovolume - OPEL COMBO Caixa/monovolume (X12) 1.4 (B05) (De 02.2012 -) 70kW 95cv 1368cm³ Caixa/monovolume - OPEL COMBO Caixa/monovolume (X12) 1.4 (B05) (De 02.2012 -) 88kW 120cv 1368cm³ Caixa/monovolume - OPEL ...</p> <p>131x118x58mm 1f-d12mm 3p-d8x17mm</p>		<p>A2596 NO. 344812 - 344897 - 95511353 - 95514539</p> <p>APOIO DO AMORTECEDOR DA FRENTE LADO ESQUERDO</p> <p>OPEL COMBO Caixa/monovolume (X12) 1.3 CDTI (B05) (De 02.2012 -) 66kW 90cv 1248cm³ Caixa/monovolume - OPEL COMBO Caixa/monovolume (X12) 1.3 CDTI (B05) (De 03.2016 -) 70kW 95cv 1248cm³ Caixa/monovolume - OPEL COMBO Caixa/monovolume (X12) 1.4 (B05) (De 02.2012 -) 70kW 95cv 1368cm³ Caixa/monovolume - OPEL COMBO Caixa/monovolume (X12) 1.4 (B05) (De 02.2012 -) 88kW 120cv 1368cm³ Caixa/monovolume - OPEL...</p> <p>131x118x61mm 1f-d12mm 3p-d8x18mm</p>
	<p>C0233 NO. 1160724 - 90054143</p> <p>BOTÃO AFINAÇÃO CAPÔT</p> <p>OPEL COMBO (71_) 1.2 (07.94 A 10.01) 45cv 1195cc Caixa - OPEL COMBO (71_) 1.4 (07.94 A 10.01) 60cv 1389cc Caixa - OPEL COMBO (71_) 1.4 (07.94 A 10.01) 82cv 1389cc Caixa - OPEL COMBO (71_) 1.7 D (07.94 A 10.01) 60cv 1686cc Caixa - OPEL COMBO Tour 1.4 (A Partir de 10.04) 90cv 1364cc Veículo multiuso - OPEL COMBO Tour 1.6 (A Partir de 10.01) 87cv 1598cc Veículo multiuso - OPEL COMBO T...</p> <p>d19x31mm</p>		<p>E0016 NO. 0852719 - 852719 - 90128194</p> <p>ESTICADOR SUPORTE CENTRAL E TRÁS DO ESCAPE</p> <p>OPEL COMBO Caixa/monovolume (71_) 1.2 07.1994/10.2001 33KW 45CV 1195CC - OPEL COMBO Caixa/monovolume (71_) 1.4 07.1994/10.2001 44KW 60CV 1389CC - OPEL COMBO Caixa/monovolume (71_) 1.4 07.1994/10.2001 60KW 82CV 1389CC - OPEL COMBO Caixa/monovolume (71_) 1.7 D 07.1994/10.2001 44KW 60CV 1686CC</p> <p>105x35x33mm</p>
	<p>E0605-M NO. 0846000 - 09227883 - 24463130 - 8 46 083 - 846000 - 9227883 - 93302286</p> <p>ESTICADOR SUPORTE APOIO MOTOR TRAS</p> <p>OPEL COMBO Caixa/monovolume 1.4 16V desde 08.2005 66KW 90CV 1364CC Z 14 XEP 0035AEV 0035096 0035AMS - OPEL COMBO Caixa/monovolume 1.6 desde 10.2001 64KW 87CV 1598CC Z 16 SE 0035437 0035003 - OPEL COMBO Caixa/monovolume 1.7 DI 16V desde 10.2001 48KW 65CV 1686CC Y 17 DTL 0035005 - OPEL COMBO Caixa/monovolume 1.7 DTI 16V desde 10.2001 55KW 75CV 1686CC Y 17 DT 0035438 0035004 - OPEL COMBO 1.4 10.2004/...</p> <p>220x100x50mm 2f-d12mm 1f-12x18mm</p>		<p>E0639-M NO. 0846034 - 13143386 - 846034</p> <p>ESTICADOR SUPORTE APOIO MOTOR TRAS</p> <p>OPEL COMBO Caixa/monovolume 1.3 CDTI 16V desde 08.2005 51KW 69CV 1248CC Z 13 DT 0035AEX 0035097 0035536 - OPEL COMBO Caixa/monovolume 1.3 CDTI 16V 10.2005/12.2012 55KW 75CV 1248CC Z 13 DTJ 0035AGW 0035AEZ 0035AMU 0035BBQ 0035BBR - OPEL COMBO Caixa/monovolume 1.6 CNG 16V desde 04.2005 71KW 97CV 1598CC Z 16 YNG 0035113 - OPEL COMBO Caixa/monovolume 1.6 CNG 16V desde 06.2006 69KW 94CV 1598CC Z 16 YNG...</p> <p>223x111x57mm 2f-d12mm 1f-13x19mm</p>
	<p>E0653-M NO. 0684717 - 13117088 - 684717</p> <p>ESTICADOR DO MOTOR PARTE DE TRÁS</p> <p>OPEL COMBO Caixa/monovolume 1.3 CDTI 16V (08.2005 -) 51kw 69cv 1248cm³ Caixa/monovolume OPEL COMBO Caixa/monovolume 1.3 CDTI 16V (10.2005 - 12.2012) 55kw 75cv 1248cm³ Caixa/monovolume OPEL COMBO Caixa/monovolume 1.6 CNG 16V (06.2006 -) 69kw 94cv 1598cm³ Caixa/monovolume OPEL COMBO Caixa/monovolume 1.6 CNG 16V (04.2005 -) 71kw 97cv 1598cm³ Caixa/monovolume</p> <p>215x101x44mm 1f-d12mm 1r-d10mm 1f-d12mm</p>		<p>E0653-M NO. 0684717 - 13117088 - 684717</p> <p>ESTICADOR DO MOTOR PARTE DE TRÁS</p> <p>OPEL COMBO Tour 1.3 CDTI 16V (06.2004 - 01.2011) 51kw 69cv 1248cm³ Veículo multiuso OPEL COMBO Tour 1.3 CDTI 16V (10.2005 - 12.2011) 55kw 75cv 1248cm³ Veículo multiuso OPEL COMBO Tour 1.6 CNG (06.2006 - 12.2011) 69kw 94cv 1598cm³ Veículo multiuso OPEL COMBO Tour 1.6 CNG (04.2005 - 01.2011) 71kw 97cv 1598cm³ Veículo multiuso</p> <p>215x101x44mm 1f-d12mm 1r-d10mm 1f-d12mm</p>
	<p>E1027 NO. 852673</p> <p>ESTICADOR DE ESCAPE PARTE DE TRÁS</p> <p>OPEL COMBO</p> <p>95x35x25mm</p>		<p>E1092 NO. 0852726 - 13276148 - 852577 - 852726 - 90466668</p> <p>ESTICADOR DE ESCAPE</p> <p>OPEL COMBO Tour: 1.6 10.2001/09.2006 64KW 87CV 1598CC - OPEL COMBO Tour: 1.3 CDTI 16V 06.2004/01.2011 51KW 69CV 1248CC - OPEL COMBO Tour: 1.3 CDTI 16V 10.2005/12.2011 55KW 75CV 1248CC - OPEL COMBO Tour: 1.7 DI 16V 10.2001/06.2004 48KW 65CV 1686CC - OPEL COMBO Tour: 1.7 DTI 16V 10.2001/06.2004 55KW 75CV 1686CC - OPEL COMBO Tour: 1.7 CDTI 16V 07.2004/12.2011 74KW 101CV 1686CC - OPEL COMBO Caixa/mono...</p> <p>55x40x35mm</p>
	<p>F0520-I NO. 374018 - 90095162</p> <p>FOLE DO SEMI-EIXO INTERNO (F1026)</p> <p>OPEL COMBO 1.4i - 1.5D - 1.5TD - 1.7D - 1.7TD (1993 A 2001)</p> <p>d72x94mm 1f-d54mm 1f-d19mm</p>		<p>F1845-I NO. 1603004 - 1603230 - 26073421 - 26094870</p> <p>FOLE DA TRANSMISSÃO LADO DA CAIXA</p> <p>OPEL COMBO - TOUR 1.4i 1.6i (APÓS 2001)</p> <p>d81x95mm 1f-d72mm 1f-d22mm</p>
	<p>F4093 NO. 0738423 - 09200970 - 738423 - 9200970</p> <p>FOLE ALAVANCA VELOCIDADES</p> <p>OPEL COMBO Tour: 1.4 10.2004/12.2011 66KW 90CV 1364CC - OPEL COMBO Tour: 1.6 10.2001/09.2006 64KW 87CV 1598CC - OPEL COMBO Tour: 1.6 CNG 06.2006/12.2011 69KW 94CV 1598CC - OPEL COMBO Tour: 1.6 CNG 04.2005/01.2011 71KW 97CV 1598CC - OPEL COMBO Tour: 1.3 CDTI 16V 06.2004/01.2011 51KW 69CV 1248CC - OPEL COMBO Tour: 1.3 CDTI 16V 10.2005/12.2011 55KW 75CV 1248CC - OPEL COMBO Tour: 1.7 DI 16V 10.2001/06...</p> <p>160x110x170mm 1f-d50mm</p>		<p>F4094 NO. 0738978 - 5738414 - 738978 - 90373314 - 90437426</p> <p>FOLE ALAVANCA VELOCIDADES</p> <p>OPEL COMBO (71_) 1.2 07.1994/10.2001 33KW 45CV 1195CC - OPEL COMBO (71_) 1.4 07.1994/10.2001 44KW 60CV 1389CC - OPEL COMBO (71_) 1.4 07.1994/10.2001 60KW 82CV 1389CC - OPEL COMBO (71_) 1.7 D 07.1994/10.2001 44KW 60CV 1686CC</p> <p>170x120x220mm 1f-160x105mm 1f-d50mm</p>

	<table border="1"> <tr> <td>F4139</td> <td>NO. 24411991 - 578518</td> </tr> <tr> <td colspan="2"><i>FOLE ALAVANCA TRAVÃO DE MÃO</i></td> </tr> <tr> <td colspan="2"> <p>OPEL COMBO Tour: 1.7 CDTI 16V 07.2004/12.2011 74KW 101CV 1686CC - OPEL COMBO Caixa/monovolume: 1.4 16V 08.2005 >>> 66KW 90CV 1364CC - OPEL COMBO Caixa/monovolume: 1.6 10.2001 >>> 64KW 87CV 1598CC - OPEL COMBO Caixa/monovolume: 1.3 CDTI 16V 10.2005/12.2012 55KW 75CV 1248CC - OPEL COMBO Caixa/monovolume: 1.7 DI 16V 10.2001 >>> 48KW 65CV 1686CC - OPEL COMBO Caixa/monovolume: 1.7 DTI 16V 10.2001 - 55KW...</p> </td> </tr> <tr> <td>180x93x214mm</td> <td>1f-d11mm</td> </tr> </table>	F4139	NO. 24411991 - 578518	<i>FOLE ALAVANCA TRAVÃO DE MÃO</i>		<p>OPEL COMBO Tour: 1.7 CDTI 16V 07.2004/12.2011 74KW 101CV 1686CC - OPEL COMBO Caixa/monovolume: 1.4 16V 08.2005 >>> 66KW 90CV 1364CC - OPEL COMBO Caixa/monovolume: 1.6 10.2001 >>> 64KW 87CV 1598CC - OPEL COMBO Caixa/monovolume: 1.3 CDTI 16V 10.2005/12.2012 55KW 75CV 1248CC - OPEL COMBO Caixa/monovolume: 1.7 DI 16V 10.2001 >>> 48KW 65CV 1686CC - OPEL COMBO Caixa/monovolume: 1.7 DTI 16V 10.2001 - 55KW...</p>		180x93x214mm	1f-d11mm		<table border="1"> <tr> <td>KF1845-I</td> <td>NO. 1603004 - 1603230 - 26073421 - 26094870</td> </tr> <tr> <td colspan="2"><i>KIT FOLE TRANSMISSÃO JUNTO À CAIXA</i></td> </tr> <tr> <td colspan="2"> <p>OPEL COMBO Tour 1.6 (A Partir de 10.01) 87cv 1598cc Veículo multiuso - OPEL COMBO Tour 1.6 CNG (A Partir de 06.06) 94cv 1598cc Veículo multiuso - OPEL COMBO Tour 1.6 CNG (A Partir de 04.05) 97cv 1598cc Veículo multiuso - OPEL COMBO Tour 1.7 DI 16V (A Partir de 10.01) 65cv 1686cc Veículo multiuso - OPEL COMBO Caixa/Combi 1.4 16V (A Partir de 08.05) 90cv 1364cc Caixa/Combi - OPEL COMBO Caix...</p> </td> </tr> <tr> <td>d81x95mm</td> <td>1f-d72mm 1f-d22mm</td> </tr> </table>	KF1845-I	NO. 1603004 - 1603230 - 26073421 - 26094870	<i>KIT FOLE TRANSMISSÃO JUNTO À CAIXA</i>		<p>OPEL COMBO Tour 1.6 (A Partir de 10.01) 87cv 1598cc Veículo multiuso - OPEL COMBO Tour 1.6 CNG (A Partir de 06.06) 94cv 1598cc Veículo multiuso - OPEL COMBO Tour 1.6 CNG (A Partir de 04.05) 97cv 1598cc Veículo multiuso - OPEL COMBO Tour 1.7 DI 16V (A Partir de 10.01) 65cv 1686cc Veículo multiuso - OPEL COMBO Caixa/Combi 1.4 16V (A Partir de 08.05) 90cv 1364cc Caixa/Combi - OPEL COMBO Caix...</p>		d81x95mm	1f-d72mm 1f-d22mm
F4139	NO. 24411991 - 578518																		
<i>FOLE ALAVANCA TRAVÃO DE MÃO</i>																			
<p>OPEL COMBO Tour: 1.7 CDTI 16V 07.2004/12.2011 74KW 101CV 1686CC - OPEL COMBO Caixa/monovolume: 1.4 16V 08.2005 >>> 66KW 90CV 1364CC - OPEL COMBO Caixa/monovolume: 1.6 10.2001 >>> 64KW 87CV 1598CC - OPEL COMBO Caixa/monovolume: 1.3 CDTI 16V 10.2005/12.2012 55KW 75CV 1248CC - OPEL COMBO Caixa/monovolume: 1.7 DI 16V 10.2001 >>> 48KW 65CV 1686CC - OPEL COMBO Caixa/monovolume: 1.7 DTI 16V 10.2001 - 55KW...</p>																			
180x93x214mm	1f-d11mm																		
KF1845-I	NO. 1603004 - 1603230 - 26073421 - 26094870																		
<i>KIT FOLE TRANSMISSÃO JUNTO À CAIXA</i>																			
<p>OPEL COMBO Tour 1.6 (A Partir de 10.01) 87cv 1598cc Veículo multiuso - OPEL COMBO Tour 1.6 CNG (A Partir de 06.06) 94cv 1598cc Veículo multiuso - OPEL COMBO Tour 1.6 CNG (A Partir de 04.05) 97cv 1598cc Veículo multiuso - OPEL COMBO Tour 1.7 DI 16V (A Partir de 10.01) 65cv 1686cc Veículo multiuso - OPEL COMBO Caixa/Combi 1.4 16V (A Partir de 08.05) 90cv 1364cc Caixa/Combi - OPEL COMBO Caix...</p>																			
d81x95mm	1f-d72mm 1f-d22mm																		
	<table border="1"> <tr> <td>KF2527-T</td> <td>NO. 1603189</td> </tr> <tr> <td colspan="2"><i>KIT DE FOLE DO CARDAN JUNTO À RODA</i></td> </tr> <tr> <td colspan="2"> <p>OPEL COMBO 1.4i - 1.5 TD - 1.7D - 1.7 TD (1994 A 2001)</p> </td> </tr> <tr> <td>d95x130mm</td> <td>1f-d78mm 1f-d23mm</td> </tr> </table>	KF2527-T	NO. 1603189	<i>KIT DE FOLE DO CARDAN JUNTO À RODA</i>		<p>OPEL COMBO 1.4i - 1.5 TD - 1.7D - 1.7 TD (1994 A 2001)</p>		d95x130mm	1f-d78mm 1f-d23mm		<table border="1"> <tr> <td>KL80932</td> <td>NO. 1p-d6-10mm d-20/10mm 1f-d14mm 1f-d</td> </tr> <tr> <td colspan="2"><i>KIT CASQUILHO COBERTURA TAMPA MOTOR</i></td> </tr> <tr> <td colspan="2"> <p>OPEL COMBO Tour: 1.3 CDTI 16V 06.2004/01.2011 51KW 69CV 1248CC - OPEL COMBO Tour: 1.3 CDTI 16V 10.2005/12.2011 55KW 75CV 1248CC - OPEL COMBO Caixa/monovolume: 1.3 CDTI 16V 08.2005/>>> 51KW 69CV 1248CC - OPEL COMBO Caixa/monovolume: 1.3 CDTI 16V 10.2005/12.2012 55KW 75CV 1248CC</p> </td> </tr> <tr> <td>d30/75mm d-33/19mm d-39/26mm d-20/10mm 1f-d14mm 1f-d22mm...</td> <td></td> </tr> </table>	KL80932	NO. 1p-d6-10mm d-20/10mm 1f-d14mm 1f-d	<i>KIT CASQUILHO COBERTURA TAMPA MOTOR</i>		<p>OPEL COMBO Tour: 1.3 CDTI 16V 06.2004/01.2011 51KW 69CV 1248CC - OPEL COMBO Tour: 1.3 CDTI 16V 10.2005/12.2011 55KW 75CV 1248CC - OPEL COMBO Caixa/monovolume: 1.3 CDTI 16V 08.2005/>>> 51KW 69CV 1248CC - OPEL COMBO Caixa/monovolume: 1.3 CDTI 16V 10.2005/12.2012 55KW 75CV 1248CC</p>		d30/75mm d-33/19mm d-39/26mm d-20/10mm 1f-d14mm 1f-d22mm...	
KF2527-T	NO. 1603189																		
<i>KIT DE FOLE DO CARDAN JUNTO À RODA</i>																			
<p>OPEL COMBO 1.4i - 1.5 TD - 1.7D - 1.7 TD (1994 A 2001)</p>																			
d95x130mm	1f-d78mm 1f-d23mm																		
KL80932	NO. 1p-d6-10mm d-20/10mm 1f-d14mm 1f-d																		
<i>KIT CASQUILHO COBERTURA TAMPA MOTOR</i>																			
<p>OPEL COMBO Tour: 1.3 CDTI 16V 06.2004/01.2011 51KW 69CV 1248CC - OPEL COMBO Tour: 1.3 CDTI 16V 10.2005/12.2011 55KW 75CV 1248CC - OPEL COMBO Caixa/monovolume: 1.3 CDTI 16V 08.2005/>>> 51KW 69CV 1248CC - OPEL COMBO Caixa/monovolume: 1.3 CDTI 16V 10.2005/12.2012 55KW 75CV 1248CC</p>																			
d30/75mm d-33/19mm d-39/26mm d-20/10mm 1f-d14mm 1f-d22mm...																			
	<table border="1"> <tr> <td>KUR28282</td> <td>NO. 1f-d16mm 1f-d15mm 1f-d18mm 1f-d25m</td> </tr> <tr> <td colspan="2"><i>KIT REPARAÇÃO ALAVANCA DE VELOCIDADES</i></td> </tr> <tr> <td colspan="2"> <p>OPEL COMBO Caixa/monovolume 1.3 CDTI 16V (08.2005 -) 51kw 69cv 1248cm3 Caixa/monovolume OPEL COMBO Caixa/monovolume 1.3 CDTI 16V (10.2005 - 12.2012) 55kw 75cv 1248cm3 Caixa/monovolume OPEL COMBO Caixa/monovolume 1.4 16V (08.2005 -) 66kw 90cv 1364cm3 Caixa/monovolume OPEL COMBO Caixa/monovolume 1.6 (10.2001 -) 64kw 87cv 1598cm3 Caixa/monovolume OPEL COMBO Caixa/monovolume 1.6 CNG 16V (06.2006 -) 69...</p> </td> </tr> <tr> <td>33x35x28mm(x2) d22x19mm (f-d) d41x41mm(x2) d22x19mm d32x20mm</td> <td></td> </tr> </table>	KUR28282	NO. 1f-d16mm 1f-d15mm 1f-d18mm 1f-d25m	<i>KIT REPARAÇÃO ALAVANCA DE VELOCIDADES</i>		<p>OPEL COMBO Caixa/monovolume 1.3 CDTI 16V (08.2005 -) 51kw 69cv 1248cm3 Caixa/monovolume OPEL COMBO Caixa/monovolume 1.3 CDTI 16V (10.2005 - 12.2012) 55kw 75cv 1248cm3 Caixa/monovolume OPEL COMBO Caixa/monovolume 1.4 16V (08.2005 -) 66kw 90cv 1364cm3 Caixa/monovolume OPEL COMBO Caixa/monovolume 1.6 (10.2001 -) 64kw 87cv 1598cm3 Caixa/monovolume OPEL COMBO Caixa/monovolume 1.6 CNG 16V (06.2006 -) 69...</p>		33x35x28mm(x2) d22x19mm (f-d) d41x41mm(x2) d22x19mm d32x20mm			<table border="1"> <tr> <td>KUR28282</td> <td>NO. 1f-d16mm 1f-d15mm 1f-d18mm 1f-d25m</td> </tr> <tr> <td colspan="2"><i>KIT REPARAÇÃO ALAVANCA DE VELOCIDADES</i></td> </tr> <tr> <td colspan="2"> <p>OPEL COMBO Tour 1.3 CDTI 16V (06.2004 - 01.2011) 51kw 69cv 1248cm3 Veículo multiuso OPEL COMBO Tour 1.3 CDTI 16V (10.2005 - 12.2011) 55kw 75cv 1248cm3 Veículo multiuso OPEL COMBO Tour 1.6 (10.2001 - 09.2006) 64kw 87cv 1598cm3 Veículo multiuso OPEL COMBO Tour 1.6 CNG (06.2006 - 12.2011) 69kw 94cv 1598cm3 Veículo multiuso OPEL COMBO Tour 1.6 CNG (04.2005 - 01.2011) 71kw 97cv 1598cm3 Veículo multiuso...</p> </td> </tr> <tr> <td>33x35x28mm(x2) d22x19mm (f-d) d41x41mm(x2) d22x19mm d32x20mm</td> <td></td> </tr> </table>	KUR28282	NO. 1f-d16mm 1f-d15mm 1f-d18mm 1f-d25m	<i>KIT REPARAÇÃO ALAVANCA DE VELOCIDADES</i>		<p>OPEL COMBO Tour 1.3 CDTI 16V (06.2004 - 01.2011) 51kw 69cv 1248cm3 Veículo multiuso OPEL COMBO Tour 1.3 CDTI 16V (10.2005 - 12.2011) 55kw 75cv 1248cm3 Veículo multiuso OPEL COMBO Tour 1.6 (10.2001 - 09.2006) 64kw 87cv 1598cm3 Veículo multiuso OPEL COMBO Tour 1.6 CNG (06.2006 - 12.2011) 69kw 94cv 1598cm3 Veículo multiuso OPEL COMBO Tour 1.6 CNG (04.2005 - 01.2011) 71kw 97cv 1598cm3 Veículo multiuso...</p>		33x35x28mm(x2) d22x19mm (f-d) d41x41mm(x2) d22x19mm d32x20mm	
KUR28282	NO. 1f-d16mm 1f-d15mm 1f-d18mm 1f-d25m																		
<i>KIT REPARAÇÃO ALAVANCA DE VELOCIDADES</i>																			
<p>OPEL COMBO Caixa/monovolume 1.3 CDTI 16V (08.2005 -) 51kw 69cv 1248cm3 Caixa/monovolume OPEL COMBO Caixa/monovolume 1.3 CDTI 16V (10.2005 - 12.2012) 55kw 75cv 1248cm3 Caixa/monovolume OPEL COMBO Caixa/monovolume 1.4 16V (08.2005 -) 66kw 90cv 1364cm3 Caixa/monovolume OPEL COMBO Caixa/monovolume 1.6 (10.2001 -) 64kw 87cv 1598cm3 Caixa/monovolume OPEL COMBO Caixa/monovolume 1.6 CNG 16V (06.2006 -) 69...</p>																			
33x35x28mm(x2) d22x19mm (f-d) d41x41mm(x2) d22x19mm d32x20mm																			
KUR28282	NO. 1f-d16mm 1f-d15mm 1f-d18mm 1f-d25m																		
<i>KIT REPARAÇÃO ALAVANCA DE VELOCIDADES</i>																			
<p>OPEL COMBO Tour 1.3 CDTI 16V (06.2004 - 01.2011) 51kw 69cv 1248cm3 Veículo multiuso OPEL COMBO Tour 1.3 CDTI 16V (10.2005 - 12.2011) 55kw 75cv 1248cm3 Veículo multiuso OPEL COMBO Tour 1.6 (10.2001 - 09.2006) 64kw 87cv 1598cm3 Veículo multiuso OPEL COMBO Tour 1.6 CNG (06.2006 - 12.2011) 69kw 94cv 1598cm3 Veículo multiuso OPEL COMBO Tour 1.6 CNG (04.2005 - 01.2011) 71kw 97cv 1598cm3 Veículo multiuso...</p>																			
33x35x28mm(x2) d22x19mm (f-d) d41x41mm(x2) d22x19mm d32x20mm																			
	<table border="1"> <tr> <td>M6005</td> <td>NO. 854949 - 94139609 - 94344459</td> </tr> <tr> <td colspan="2"><i>JUNTA DE ESCAPE</i></td> </tr> <tr> <td colspan="2"> <p>OPEL COMBO</p> </td> </tr> <tr> <td>d57x5mm</td> <td>1f-d45mm</td> </tr> </table>	M6005	NO. 854949 - 94139609 - 94344459	<i>JUNTA DE ESCAPE</i>		<p>OPEL COMBO</p>		d57x5mm	1f-d45mm		<table border="1"> <tr> <td>P1012</td> <td>NO. 0560808 - 560808 - 90105172</td> </tr> <tr> <td colspan="2"><i>CAPA PEDAL EMBRAIAGEM/TRAVAO (GASTA 2 UNIDADES)</i></td> </tr> <tr> <td colspan="2"> <p>OPEL COMBO Caixa/monovolume (71_) : 1.2 07.1994/10.2001 33KW 45CV 1195CC - OPEL COMBO Caixa/monovolume (71_) : 1.4 07.1994/10.2001 44KW 60CV 1389CC - OPEL COMBO Caixa/monovolume (71_) : 1.4 07.1994/10.2001 60KW 82CV 1389CC - OPEL COMBO Caixa/monovolume (71_) : 1.7 D 07.1994/10.2001 44KW 60CV 1686CC</p> </td> </tr> <tr> <td>60x55x9mm</td> <td></td> </tr> </table>	P1012	NO. 0560808 - 560808 - 90105172	<i>CAPA PEDAL EMBRAIAGEM/TRAVAO (GASTA 2 UNIDADES)</i>		<p>OPEL COMBO Caixa/monovolume (71_) : 1.2 07.1994/10.2001 33KW 45CV 1195CC - OPEL COMBO Caixa/monovolume (71_) : 1.4 07.1994/10.2001 44KW 60CV 1389CC - OPEL COMBO Caixa/monovolume (71_) : 1.4 07.1994/10.2001 60KW 82CV 1389CC - OPEL COMBO Caixa/monovolume (71_) : 1.7 D 07.1994/10.2001 44KW 60CV 1686CC</p>		60x55x9mm	
M6005	NO. 854949 - 94139609 - 94344459																		
<i>JUNTA DE ESCAPE</i>																			
<p>OPEL COMBO</p>																			
d57x5mm	1f-d45mm																		
P1012	NO. 0560808 - 560808 - 90105172																		
<i>CAPA PEDAL EMBRAIAGEM/TRAVAO (GASTA 2 UNIDADES)</i>																			
<p>OPEL COMBO Caixa/monovolume (71_) : 1.2 07.1994/10.2001 33KW 45CV 1195CC - OPEL COMBO Caixa/monovolume (71_) : 1.4 07.1994/10.2001 44KW 60CV 1389CC - OPEL COMBO Caixa/monovolume (71_) : 1.4 07.1994/10.2001 60KW 82CV 1389CC - OPEL COMBO Caixa/monovolume (71_) : 1.7 D 07.1994/10.2001 44KW 60CV 1686CC</p>																			
60x55x9mm																			
	<table border="1"> <tr> <td>R015005</td> <td>NO. ch-d8(f-d3mm)x260mm 4bicos-d6mm(f-d</td> </tr> <tr> <td colspan="2"><i>TUBO EXTRACTOR COMBUSTIVEL INJECTORES</i></td> </tr> <tr> <td colspan="2"> <p>OPEL COMBO Caixa/monovolume 1.7 CDTI 16V (De 12.2004 -) 74kW 101cv 1686cm3 Caixa/monovolume - OPEL COMBO Tour 1.7 CDTI 16V (De 07.2004 Até 12.2011) 74kW 101cv 1686cm3 Veículo multiuso -</p> </td> </tr> <tr> <td>324mm</td> <td>ch-d8(f-d3mm)x260mm 4bicos-d6mm(f-d</td> </tr> </table>	R015005	NO. ch-d8(f-d3mm)x260mm 4bicos-d6mm(f-d	<i>TUBO EXTRACTOR COMBUSTIVEL INJECTORES</i>		<p>OPEL COMBO Caixa/monovolume 1.7 CDTI 16V (De 12.2004 -) 74kW 101cv 1686cm3 Caixa/monovolume - OPEL COMBO Tour 1.7 CDTI 16V (De 07.2004 Até 12.2011) 74kW 101cv 1686cm3 Veículo multiuso -</p>		324mm	ch-d8(f-d3mm)x260mm 4bicos-d6mm(f-d		<table border="1"> <tr> <td>R016261</td> <td>NO. 55240933 - 860334 - 860415 - 861021</td> </tr> <tr> <td colspan="2"><i>TUBO DO OLEO DO COMPRESSOR</i></td> </tr> <tr> <td colspan="2"> <p>OPEL COMBO Caixa/monovolume (X12) 1.3 CDTI (B05) desde 02.2012 59KW 80CV 1248CC A 13 FD 0035BIM - OPEL COMBO Caixa/monovolume (X12) 1.3 CDTI (B05) desde 02.2012 66KW 90CV 1248CC A 13 FD 0035AZN 0035AZT 0035ARW 0035AVQ - OPEL COMBO Caixa/monovolume (X12) 1.3 CDTI (B05) desde 03.2016 70KW 95CV 1248CC A 13 FD 0035BIN - OPEL COMBO Tour (X12) 1.3 CDTI (C26, D26, E26, C05) desde 02.2012 66KW 90CV 1248CC...</p> </td> </tr> <tr> <td>B105-14/15mm</td> <td>40x40x39mm</td> </tr> </table>	R016261	NO. 55240933 - 860334 - 860415 - 861021	<i>TUBO DO OLEO DO COMPRESSOR</i>		<p>OPEL COMBO Caixa/monovolume (X12) 1.3 CDTI (B05) desde 02.2012 59KW 80CV 1248CC A 13 FD 0035BIM - OPEL COMBO Caixa/monovolume (X12) 1.3 CDTI (B05) desde 02.2012 66KW 90CV 1248CC A 13 FD 0035AZN 0035AZT 0035ARW 0035AVQ - OPEL COMBO Caixa/monovolume (X12) 1.3 CDTI (B05) desde 03.2016 70KW 95CV 1248CC A 13 FD 0035BIN - OPEL COMBO Tour (X12) 1.3 CDTI (C26, D26, E26, C05) desde 02.2012 66KW 90CV 1248CC...</p>		B105-14/15mm	40x40x39mm
R015005	NO. ch-d8(f-d3mm)x260mm 4bicos-d6mm(f-d																		
<i>TUBO EXTRACTOR COMBUSTIVEL INJECTORES</i>																			
<p>OPEL COMBO Caixa/monovolume 1.7 CDTI 16V (De 12.2004 -) 74kW 101cv 1686cm3 Caixa/monovolume - OPEL COMBO Tour 1.7 CDTI 16V (De 07.2004 Até 12.2011) 74kW 101cv 1686cm3 Veículo multiuso -</p>																			
324mm	ch-d8(f-d3mm)x260mm 4bicos-d6mm(f-d																		
R016261	NO. 55240933 - 860334 - 860415 - 861021																		
<i>TUBO DO OLEO DO COMPRESSOR</i>																			
<p>OPEL COMBO Caixa/monovolume (X12) 1.3 CDTI (B05) desde 02.2012 59KW 80CV 1248CC A 13 FD 0035BIM - OPEL COMBO Caixa/monovolume (X12) 1.3 CDTI (B05) desde 02.2012 66KW 90CV 1248CC A 13 FD 0035AZN 0035AZT 0035ARW 0035AVQ - OPEL COMBO Caixa/monovolume (X12) 1.3 CDTI (B05) desde 03.2016 70KW 95CV 1248CC A 13 FD 0035BIN - OPEL COMBO Tour (X12) 1.3 CDTI (C26, D26, E26, C05) desde 02.2012 66KW 90CV 1248CC...</p>																			
B105-14/15mm	40x40x39mm																		
	<table border="1"> <tr> <td>R019107</td> <td>NO. 0860294 - 860294 - 861062 - 95510213 - 95520002 - 95523071</td> </tr> <tr> <td colspan="2"><i>TUBO DO AR SOBREALIMENTAÇÃO</i></td> </tr> <tr> <td colspan="2"> <p>OPEL COMBO Caixa/monovolume (X12) 1.3 CDTI (B05) desde 02.2012 59KW 80CV 1248CC A 13 FD 0035BIM - OPEL COMBO Caixa/monovolume (X12) 1.3 CDTI (B05) desde 02.2012 66KW 90CV 1248CC A 13 FD 0035AZN 0035AZT 0035ARW 0035AVQ - OPEL COMBO Caixa/monovolume (X12) 1.3 CDTI (B05) desde 03.2016 70KW 95CV 1248CC A 13 FD 0035BIN</p> </td> </tr> <tr> <td>B180-d44/d48mm</td> <td>51-60-71mm</td> </tr> </table>	R019107	NO. 0860294 - 860294 - 861062 - 95510213 - 95520002 - 95523071	<i>TUBO DO AR SOBREALIMENTAÇÃO</i>		<p>OPEL COMBO Caixa/monovolume (X12) 1.3 CDTI (B05) desde 02.2012 59KW 80CV 1248CC A 13 FD 0035BIM - OPEL COMBO Caixa/monovolume (X12) 1.3 CDTI (B05) desde 02.2012 66KW 90CV 1248CC A 13 FD 0035AZN 0035AZT 0035ARW 0035AVQ - OPEL COMBO Caixa/monovolume (X12) 1.3 CDTI (B05) desde 03.2016 70KW 95CV 1248CC A 13 FD 0035BIN</p>		B180-d44/d48mm	51-60-71mm		<table border="1"> <tr> <td>R019107</td> <td>NO. 0860294 - 860294 - 861062 - 95510213 - 95520002 - 95523071</td> </tr> <tr> <td colspan="2"><i>TUBO DO AR SOBREALIMENTAÇÃO</i></td> </tr> <tr> <td colspan="2"> <p>OPEL COMBO Tour (X12) 1.3 CDTI (C26, D26, E26, C05) desde 02.2012 66KW 90CV 1248CC A 13 FD - OPEL COMBO Tour (X12) 1.3 CDTI (C26, D26, E26, C05) desde 03.2015 59KW 80CV 1248CC A 13 FD - OPEL COMBO Tour (X12) 1.3 CDTI (C26, D26, E26, C05) desde 03.2016 70KW 95CV 1248CC A 13 FD</p> </td> </tr> <tr> <td>B180-d44/d48mm</td> <td>51-60-71mm</td> </tr> </table>	R019107	NO. 0860294 - 860294 - 861062 - 95510213 - 95520002 - 95523071	<i>TUBO DO AR SOBREALIMENTAÇÃO</i>		<p>OPEL COMBO Tour (X12) 1.3 CDTI (C26, D26, E26, C05) desde 02.2012 66KW 90CV 1248CC A 13 FD - OPEL COMBO Tour (X12) 1.3 CDTI (C26, D26, E26, C05) desde 03.2015 59KW 80CV 1248CC A 13 FD - OPEL COMBO Tour (X12) 1.3 CDTI (C26, D26, E26, C05) desde 03.2016 70KW 95CV 1248CC A 13 FD</p>		B180-d44/d48mm	51-60-71mm
R019107	NO. 0860294 - 860294 - 861062 - 95510213 - 95520002 - 95523071																		
<i>TUBO DO AR SOBREALIMENTAÇÃO</i>																			
<p>OPEL COMBO Caixa/monovolume (X12) 1.3 CDTI (B05) desde 02.2012 59KW 80CV 1248CC A 13 FD 0035BIM - OPEL COMBO Caixa/monovolume (X12) 1.3 CDTI (B05) desde 02.2012 66KW 90CV 1248CC A 13 FD 0035AZN 0035AZT 0035ARW 0035AVQ - OPEL COMBO Caixa/monovolume (X12) 1.3 CDTI (B05) desde 03.2016 70KW 95CV 1248CC A 13 FD 0035BIN</p>																			
B180-d44/d48mm	51-60-71mm																		
R019107	NO. 0860294 - 860294 - 861062 - 95510213 - 95520002 - 95523071																		
<i>TUBO DO AR SOBREALIMENTAÇÃO</i>																			
<p>OPEL COMBO Tour (X12) 1.3 CDTI (C26, D26, E26, C05) desde 02.2012 66KW 90CV 1248CC A 13 FD - OPEL COMBO Tour (X12) 1.3 CDTI (C26, D26, E26, C05) desde 03.2015 59KW 80CV 1248CC A 13 FD - OPEL COMBO Tour (X12) 1.3 CDTI (C26, D26, E26, C05) desde 03.2016 70KW 95CV 1248CC A 13 FD</p>																			
B180-d44/d48mm	51-60-71mm																		
	<table border="1"> <tr> <td>R019213</td> <td>NO. 55245385</td> </tr> <tr> <td colspan="2"><i>TUBO EXTRATOR COMBUSTIVEL</i></td> </tr> <tr> <td colspan="2"> <p>OPEL COMBO Tour: 1.3 CDTI 16V 10.2005/12.2011 55KW 75CV 1248CC - OPEL COMBO Caixa/monovolume: 1.3 CDTI 16V 10.2005/12.2012 55KW 75CV 1248CC</p> </td> </tr> <tr> <td>B-340/3mm</td> <td>4p-d5x10mm</td> </tr> </table>	R019213	NO. 55245385	<i>TUBO EXTRATOR COMBUSTIVEL</i>		<p>OPEL COMBO Tour: 1.3 CDTI 16V 10.2005/12.2011 55KW 75CV 1248CC - OPEL COMBO Caixa/monovolume: 1.3 CDTI 16V 10.2005/12.2012 55KW 75CV 1248CC</p>		B-340/3mm	4p-d5x10mm		<table border="1"> <tr> <td>R019214</td> <td>NO. 817329 - 93177371</td> </tr> <tr> <td colspan="2"><i>TUBO EXTRATOR DE COMBUSTIVEL</i></td> </tr> <tr> <td colspan="2"> <p>OPEL COMBO Caixa/monovolume 1.3 CDTI 16V desde 08.2005 51KW 69CV 1248CC Z 13 DT 0035AEX 0035097 0035536 - OPEL COMBO Caixa/monovolume 1.3 CDTI 16V 10.2005/12.2012 55KW 75CV 1248CC Z 13 DTJ 0035AQW 0035AEZ 0035AMU 0035BBQ 0035BBR - OPEL COMBO Caixa/monovolume (X12) 1.3 CDTI (B05) desde 02.2012 59KW 80CV 1248CC A 13 FD 0035BIM - OPEL COMBO Caixa/monovolume (X12) 1.3 CDTI (B05) desde 02.2012 66KW 90CV...</p> </td> </tr> <tr> <td>B455-3mm</td> <td>4p-d5x10mm</td> </tr> </table>	R019214	NO. 817329 - 93177371	<i>TUBO EXTRATOR DE COMBUSTIVEL</i>		<p>OPEL COMBO Caixa/monovolume 1.3 CDTI 16V desde 08.2005 51KW 69CV 1248CC Z 13 DT 0035AEX 0035097 0035536 - OPEL COMBO Caixa/monovolume 1.3 CDTI 16V 10.2005/12.2012 55KW 75CV 1248CC Z 13 DTJ 0035AQW 0035AEZ 0035AMU 0035BBQ 0035BBR - OPEL COMBO Caixa/monovolume (X12) 1.3 CDTI (B05) desde 02.2012 59KW 80CV 1248CC A 13 FD 0035BIM - OPEL COMBO Caixa/monovolume (X12) 1.3 CDTI (B05) desde 02.2012 66KW 90CV...</p>		B455-3mm	4p-d5x10mm
R019213	NO. 55245385																		
<i>TUBO EXTRATOR COMBUSTIVEL</i>																			
<p>OPEL COMBO Tour: 1.3 CDTI 16V 10.2005/12.2011 55KW 75CV 1248CC - OPEL COMBO Caixa/monovolume: 1.3 CDTI 16V 10.2005/12.2012 55KW 75CV 1248CC</p>																			
B-340/3mm	4p-d5x10mm																		
R019214	NO. 817329 - 93177371																		
<i>TUBO EXTRATOR DE COMBUSTIVEL</i>																			
<p>OPEL COMBO Caixa/monovolume 1.3 CDTI 16V desde 08.2005 51KW 69CV 1248CC Z 13 DT 0035AEX 0035097 0035536 - OPEL COMBO Caixa/monovolume 1.3 CDTI 16V 10.2005/12.2012 55KW 75CV 1248CC Z 13 DTJ 0035AQW 0035AEZ 0035AMU 0035BBQ 0035BBR - OPEL COMBO Caixa/monovolume (X12) 1.3 CDTI (B05) desde 02.2012 59KW 80CV 1248CC A 13 FD 0035BIM - OPEL COMBO Caixa/monovolume (X12) 1.3 CDTI (B05) desde 02.2012 66KW 90CV...</p>																			
B455-3mm	4p-d5x10mm																		
	<table border="1"> <tr> <td>R220256</td> <td>NO. 1818546 - 24423509</td> </tr> <tr> <td colspan="2"><i>TUBO DO PERMUTADOR DE CALOR DO ARREFECIMENTO</i></td> </tr> <tr> <td colspan="2"> <p>OPEL COMBO Caixa/monovolume 1.6 desde 10.2001 64KW 87CV 1598CC Z 16 SE 0035437 0035003 - OPEL COMBO Caixa/monovolume 1.6 CNG 16V desde 04.2005 71KW 97CV 1598CC Z 16 YNG 0035113 - OPEL COMBO Caixa/monovolume 1.6 CNG 16V desde 06.2006 69KW 94CV 1598CC Z 16 YNG 0035AFY 0035AMV - OPEL COMBO Caixa/monovolume (71_) : 1.4 07.1994/10.2001 44KW 60CV 1389CC X 14 SZ C 14 NZ 0039930 0039124 0039155 7526328 7526...</p> </td> </tr> <tr> <td>B257x18/19mm</td> <td>89x79x38x42x60mm</td> </tr> </table>	R220256	NO. 1818546 - 24423509	<i>TUBO DO PERMUTADOR DE CALOR DO ARREFECIMENTO</i>		<p>OPEL COMBO Caixa/monovolume 1.6 desde 10.2001 64KW 87CV 1598CC Z 16 SE 0035437 0035003 - OPEL COMBO Caixa/monovolume 1.6 CNG 16V desde 04.2005 71KW 97CV 1598CC Z 16 YNG 0035113 - OPEL COMBO Caixa/monovolume 1.6 CNG 16V desde 06.2006 69KW 94CV 1598CC Z 16 YNG 0035AFY 0035AMV - OPEL COMBO Caixa/monovolume (71_) : 1.4 07.1994/10.2001 44KW 60CV 1389CC X 14 SZ C 14 NZ 0039930 0039124 0039155 7526328 7526...</p>		B257x18/19mm	89x79x38x42x60mm		<table border="1"> <tr> <td>R221446</td> <td>NO. 49x90x150x138x95x86x93x100x72x41x7</td> </tr> <tr> <td colspan="2"><i>TUBO INFERIOR DO RADIADOR</i></td> </tr> <tr> <td colspan="2"> <p>OPEL COMBO Caixa/monovolume 1.3 CDTI 16V desde 08.2005 51KW 69CV 1248CC Z 13 DT 0035AEX 0035097 0035536 - OPEL COMBO Caixa/monovolume 1.3 CDTI 16V 10.2005/12.2012 55KW 75CV 1248CC Z 13 DTJ 0035AQW 0035AEZ 0035AMU 0035BBQ 0035BBR - OPEL COMBO Tour 1.3 CDTI 16V 06.2004/01.2011 51KW 69CV 1248CC Z 13 DT Z 13 DT 0035536 - OPEL COMBO Tour 1.3 CDTI 16V 10.2005/12.2011 55KW 75CV 1248CC Z 13 DTJ 0035AAP 00...</p> </td> </tr> <tr> <td>B780-18/29mm</td> <td>49x90x150x138x95x86x93x100x72x41x7</td> </tr> </table>	R221446	NO. 49x90x150x138x95x86x93x100x72x41x7	<i>TUBO INFERIOR DO RADIADOR</i>		<p>OPEL COMBO Caixa/monovolume 1.3 CDTI 16V desde 08.2005 51KW 69CV 1248CC Z 13 DT 0035AEX 0035097 0035536 - OPEL COMBO Caixa/monovolume 1.3 CDTI 16V 10.2005/12.2012 55KW 75CV 1248CC Z 13 DTJ 0035AQW 0035AEZ 0035AMU 0035BBQ 0035BBR - OPEL COMBO Tour 1.3 CDTI 16V 06.2004/01.2011 51KW 69CV 1248CC Z 13 DT Z 13 DT 0035536 - OPEL COMBO Tour 1.3 CDTI 16V 10.2005/12.2011 55KW 75CV 1248CC Z 13 DTJ 0035AAP 00...</p>		B780-18/29mm	49x90x150x138x95x86x93x100x72x41x7
R220256	NO. 1818546 - 24423509																		
<i>TUBO DO PERMUTADOR DE CALOR DO ARREFECIMENTO</i>																			
<p>OPEL COMBO Caixa/monovolume 1.6 desde 10.2001 64KW 87CV 1598CC Z 16 SE 0035437 0035003 - OPEL COMBO Caixa/monovolume 1.6 CNG 16V desde 04.2005 71KW 97CV 1598CC Z 16 YNG 0035113 - OPEL COMBO Caixa/monovolume 1.6 CNG 16V desde 06.2006 69KW 94CV 1598CC Z 16 YNG 0035AFY 0035AMV - OPEL COMBO Caixa/monovolume (71_) : 1.4 07.1994/10.2001 44KW 60CV 1389CC X 14 SZ C 14 NZ 0039930 0039124 0039155 7526328 7526...</p>																			
B257x18/19mm	89x79x38x42x60mm																		
R221446	NO. 49x90x150x138x95x86x93x100x72x41x7																		
<i>TUBO INFERIOR DO RADIADOR</i>																			
<p>OPEL COMBO Caixa/monovolume 1.3 CDTI 16V desde 08.2005 51KW 69CV 1248CC Z 13 DT 0035AEX 0035097 0035536 - OPEL COMBO Caixa/monovolume 1.3 CDTI 16V 10.2005/12.2012 55KW 75CV 1248CC Z 13 DTJ 0035AQW 0035AEZ 0035AMU 0035BBQ 0035BBR - OPEL COMBO Tour 1.3 CDTI 16V 06.2004/01.2011 51KW 69CV 1248CC Z 13 DT Z 13 DT 0035536 - OPEL COMBO Tour 1.3 CDTI 16V 10.2005/12.2011 55KW 75CV 1248CC Z 13 DTJ 0035AAP 00...</p>																			
B780-18/29mm	49x90x150x138x95x86x93x100x72x41x7																		

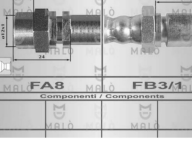
	<p>R221710 NO. 24457200 - 6818561</p> <p>TUBO DO PERMUTADOR DE CALOR DO AQUECIMENTO</p> <p>OPEL COMBO Tour 1.7 CDTI 16V (De 2004.07 Até 2011.12) 74kW 101cv 1686cm3 Veículo multiuso - OPEL COMBO Caixa/Combi 1.7 CDTI 16V (De 2004.12 -) 74kW 101cv 1686cm3 Caixa/Combi -</p> <p>B330-18/22mm 36x66x125x36x70mm ch-d22x43x22x30mm</p>		<p>R222739 NO. 1337188</p> <p>TUBO SUPERIOR DO RADIADOR</p> <p>OPEL COMBO (71_) 1.4 (De 07-1994 Até 10-2001) 44kW 60CV 1389cc Caixa OPEL COMBO (71_) 1.4 (De 07-1994 Até 10-2001) 60kW 82CV 1389cc Caixa</p> <p>B195-32/39mm 55-42-70mm</p>
	<p>R222740 NO. 1337095 - 90354836</p> <p>TUBO LIGAÇÃO TERMOSTATO BOMBA DE ÁGUA</p> <p>OPEL COMBO (71_) 1.2 (De 07-1994 Até 10-2001) 33kW 45CV 1195cc Caixa OPEL COMBO (71_) 1.4 (De 07-1994 Até 10-2001) 44kW 60CV 1389cc Caixa OPEL COMBO (71_) 1.4 (De 07-1994 Até 10-2001) 60kW 82CV 1389cc Caixa</p> <p>B138-28/38mm 32-57-51mm</p>		<p>R222752 NO. 1337573 - 9128354</p> <p>TUBO SUPERIOR DO RADIADOR</p> <p>OPEL COMBO Tour 1.4 10.2004/12.2011 66KW 90CV 1364CC Z 14 XEP 0035AEU 0035AET 0035535</p> <p>B170-d34/34mm 110-85mm</p>
	<p>R222755 NO. 1336243 - 9128764</p> <p>TUBO INFERIOR RADIADOR</p> <p>OPEL COMBO Tour 1.6 10.2001/09.2006 64KW 87CV 1598CC Z 16 SE 0035437 - OPEL COMBO Tour 1.6 CNG 04.2005/01.2011 71KW 97CV 1598CC Z 16 YNG 0035112 - OPEL COMBO Tour 1.6 CNG 06.2006/12.2011 69KW 94CV 1598CC Z 16 YNG 0035AGB</p> <p>B470-d39/34mm 120-100-150-110-95mm</p>		<p>R222760 NO. 1337574 - 9128807</p> <p>TUBO SUPERIOR DO RADIADOR</p> <p>OPEL COMBO Caixa/monovolume 1.7 DI 16V desde 10.2001 48KW 65CV 1686CC Y 17 DTL 0035005</p> <p>B300-d33/37mm 70-80-90-50-85mm</p>
	<p>R222761 NO. 50-70-30-30-60mm + ch-d20mm 90-140</p> <p>TUBO INFERIOR RADIADOR</p> <p>OPEL COMBO Caixa/monovolume 1.7 DI 16V desde 10.2001 48KW 65CV 1686CC Y 17 DTL 0035005 - OPEL COMBO Tour 1.7 DTI 16V 10.2001/06.2004 55KW 75CV 1686CC Y 17 DT 0035438</p> <p>B220-d32/32mm 50-70-30-30-60mm + ch-d20mm 90-140-3</p>		<p>R222763 NO. 09202288 - 5860742 - 9202288</p> <p>TUBO DO AR SOBREALIMENTAÇÃO</p> <p>OPEL COMBO Tour 1.7 DTI 16V 10.2001/06.2004 55KW 75CV 1686CC Y 17 DT 0035438</p> <p>B132-35/35mm 180-65-180mm</p>
	<p>R222811 NO. 650872</p> <p>TUBO DE LIGAÇÃO AO TERMOSTATO</p> <p>OPEL COMBO (71_) 1.7 D (De 1994.07 Até 2001.10) 44kW 60cv 1686cm3 Caixa -</p> <p>B57-15/15mm 50x22x50mm</p>		<p>R222812 NO. 650873</p> <p>TUBO LIGAÇÃO TERMOSTATO</p> <p>OPEL COMBO (71_) 1.7 D (De 07-1994 Até 10-2001) 44kW 60CV 1686cc Caixa</p> <p>B97-14/14mm 60-41mm</p>
	<p>R222827 NO. 6336084 - 97300149</p> <p>TUBO LIGAÇÃO TERMOSTATO</p> <p>OPEL COMBO Caixa/Combi 1.7 CDTI 16V (De 12-2004 Até ...) 74kW 101CV 1686cc Caixa/Combi</p> <p>B115-15/15mm 39-45-39mm</p>		<p>R222828 NO. 97351101</p> <p>TUBO DO RADIADOR</p> <p>OPEL COMBO Caixa/Combi 1.7 DI 16V (De 10-2001 Até ...) 48kW 65CV 1686cc Caixa/Combi OPEL COMBO Caixa/Combi 1.7 DTI 16V (De 10-2001 Até ...) 55kW 75CV 1686cc Caixa/Combi OPEL COMBO Caixa/Combi 1.7 CDTI 16V (De 12-2004 Até ...) 74kW 101CV 1686cc Caixa/Combi</p> <p>B165-13/13mm 34-41-47-51mm</p>
	<p>R222848 NO. 55559258 - 555592582 - 58605472</p> <p>TUBO DO AR SOBREALIMENTAÇÃO</p> <p>OPEL COMBO Tour 1.7 DTI 16V (De 2001.10 Até 2004.06) 55kW 75cv 1686cm3 Veículo multiuso - OPEL COMBO Caixa/Combi 1.7 DTI 16V (De 2001.10 -) 55kW 75cv 1686cm3 Caixa/Combi -</p> <p>B220-24/36mm 61x27x170mm</p>		<p>R222871 NO. 650872 - 650873</p> <p>TUBOS DE LIGAÇÃO AO TERMOSTATO</p> <p>OPEL COMBO Caixa/monovolume (71_) 1.7 D 07.1994/10.2001 44KW 60CV 1686CC X 17 D (4EE1) 17 D (4EE1) 0039932 0039126 0039154 7526330 7526509</p> <p>B113-14/14mm B56-16/16mm 45x59mm 40x1540mm</p>
	<p>R224220 NO. 0382PJ</p> <p>TUBO DO AR SOBREALIMENTAÇÃO</p> <p>OPEL COMBO Caixa/monovolume (K9) 1.6 D desde 06.2018 55KW 75CV 1560CC B 16 DTL (DV6FE) 1844AHL - OPEL COMBO Caixa/monovolume (K9) 1.6 D desde 06.2018 73KW 99CV 1560CC B 16 DT (DV6FD) 1844AIP</p> <p>B124-46/46mm 124mm</p>		<p>R224316 NO. 24423514 - 6818533</p> <p>TUBO DO PERMUTADOR DE CALOR DO AQUECIMENTO</p> <p>OPEL COMBO Tour 1.7 DI 16V (De 2001.10 Até 2004.06) 48kW 65cv 1686cm3 Veículo multiuso - OPEL COMBO Tour 1.7 DTI 16V (De 2001.10 Até 2004.06) 55kW 75cv 1686cm3 Veículo multiuso - OPEL COMBO Caixa/Combi 1.7 DI 16V (De 2001.10 -) 48kW 65cv 1686cm3 Caixa/Combi - OPEL COMBO Caixa/Combi 1.7 DTI 16V (De 2001.10 -) 55kW 75cv 1686cm3 Caixa/Combi -</p> <p>B335-17/18mm 129x125x76mm ch-d28x80mm</p>

	<p>R224318 NO. 24423511 - 6818531</p> <p>TUBO LIGAÇÃO PERMUTADOR AQUECIMENTO</p> <p>OPEL COMBO Caixa/monovolume 1.7 DI 16V desde 10.2001 48KW 65CV 1686CC Y 17 DTL 0035005 - OPEL COMBO Caixa/monovolume 1.7 DTI 16V desde 10.2001 55KW 75CV 1686CC Y 17 DT 0035438 0035004 - OPEL COMBO Tour 1.7 DI 16V 10.2001/06.2004 48KW 65CV 1686CC Y 17 DTL 0035439 - OPEL COMBO Tour 1.7 DTI 16V 10.2001/06.2004 55KW 75CV 1686CC Y 17 DT 0035438</p> <p>B260-19-27mm 79-150-38mm</p>		<p>R225266 NO. 13101637 - 5860817</p> <p>TUBO DO AR SOBREALIMENTAÇÃO</p> <p>OPEL COMBO Caixa/monovolume 1.7 CDTI 16V (De 12.2004 -) 74KW 101cv 1686cm3 Caixa/monovolume - OPEL COMBO Tour 1.7 CDTI 16V (De 07.2004 Até 12.2011) 74kW 101cv 1686cm3 Veículo multiuso -</p> <p>B105-35/36mm 44x121x51x97mm</p>
	<p>R225298 NO. 5835870 - 93329873</p> <p>TUBO DO AR SOBREALIMENTAÇÃO</p> <p>OPEL COMBO Caixa/monovolume 1.7 CDTI 16V (12.2004 -) 74kw 101cv 1686cm3 Caixa/monovolume OPEL COMBO Tour 1.7 CDTI 16V (07.2004 - 12.2011) 74kw 101cv 1686cm3 Veículo multiuso</p> <p>B545-d38/d39mm 71-66-150-74-108-87mm</p>		<p>R225493 NO. 3647457 - 9820100780</p> <p>TUBO DO AR SOBREALIMENTAÇÃO</p> <p>OPEL COMBO Caixa/monovolume (K9) 1.2 (02.2019 -) 81kw 110cv 1199cm3 Caixa/monovolume OPEL COMBO Caixa/monovolume (K9) 1.2 (09.2019 -) 96kw 131cv 1199cm3 Caixa/monovolume OPEL COMBO Caixa/monovolume (K9) 1.5 D (08.2018 -) 56kw 76cv 1499cm3 Caixa/monovolume OPEL COMBO Caixa/monovolume (K9) 1.5 D (08.2018 -) 75kw 102cv 1499cm3 Caixa/monovolume OPEL COMBO Caixa/monovolume (K9) 1.5 D (08.2018 -) 96kw 11...</p> <p>boca a boca290mmd1-46mm280mm118-85-83-62-156-77</p>
	<p>R225493 NO. 3647457 - 9820100780</p> <p>TUBO DO AR SOBREALIMENTAÇÃO</p> <p>OPEL COMBO E Tour / Life (K9) 1.2 (06.2018 -) 81kw 110cv 1199cm3 Veículo multiuso OPEL COMBO E Tour / Life (K9) 1.2 (07.2019 -) 96kw 131cv 1199cm3 Veículo multiuso OPEL COMBO E Tour / Life (K9) 1.5 (06.2018 -) 56kw 76cv 1499cm3 Veículo multiuso OPEL COMBO E Tour / Life (K9) 1.5 (06.2018 -) 75kw 102cv 1499cm3 Veículo multiuso OPEL COMBO E Tour / Life (K9) 1.5 (06.2018 -) 96kw 131cv 1499cm3 Veículo ...</p> <p>boca a boca290mmd1-46mm280mm118-85-83-62-156-77</p>		<p>R225612 NO. 63-108-57-65mm 63-35-140-40-79mm c</p> <p>TUBO DO PERMUTADOR DO AQUECIMENTO</p> <p>OPEL COMBO Caixa/monovolume 1.7 CDTI 16V desde 12.2004 74KW 101CV 1686CC Z 17 DTH 0035AEY 0035098 0035AMT - OPEL COMBO Tour 1.7 CDTI 16V 07.2004/12.2011 74KW 101CV 1686CC Z 17 DTH 0035AJQ 0035AEV 0035537</p> <p>B305-20/24mm B333-18/22mm 63-108-57-65mm 63-35-140-40-79mm ch-d21x52</p>
	<p>R8082 NO. 65-70-90-155-65mm 175-220-130-100-</p> <p>TUBO INFERIOR DO RADIADOR</p> <p>OPEL COMBO Caixa/monovolume (71_) 1.7 D 07.1994/10.2001 44KW 60CV 1686CC X 17 D (4EE1) 17 D (4EE1) 0039932 0039126 0039154 7526330 7526509</p> <p>B300-d34/31mm d18mm 65-70-90-155-65mm 175-220-130-100-13</p>		<p>R8100 NO. 1337192 - 1337252 - 1337285 - 1337381 - 90444476 - 90487614 - 90510393 - 90570023</p> <p>TUBO SUPERIOR DO RADIADOR</p> <p>OPEL COMBO Caixa/monovolume (71_) 1.7 D 07.1994/10.2001 44KW 60CV 1686CC</p> <p>B350-d34/34mm 200-90-110mm</p>
	<p>R8197 NO. 806137 - 90467441</p> <p>TUBO DO RESPIRO DO DEPÓSITO COMBUSTIVEL</p> <p>OPEL COMBO Caixa/monovolume (71_) INFORMAÇÕES TIPO ANO DE CONSTRUÇÃO KW HP CC</p> <p>B003-09/19mm MOTOR 96-220-80mm</p>		<p>RF80242 NO. 82-110-150-66mm ch-d18-24mm 2r-d5m</p> <p>TUBO DE FERRO REFRIGERAÇÃO</p> <p>OPEL CORSA B (S93) 1.5 D (F08, F68, M68) 03.1993/09.2000 37KW 50CV 1488CC 15 D 0039925 7526324 - OPEL CORSA B (S93) 1.7 D (F08, F68, M68) 02.1996/09.2000 44KW 60CV 1686CC X 17 D (4EE1) 17 D (4EE1) 0039164 0039163 0039956 - OPEL CORSA B Caixa/parte traseira inclinada (S93) 1.7 D (F08, W5L) 08.1999/09.2000 44KW 60CV 1686CC X 17 D (4EE1) 17 D (4EE1) 0039130</p> <p>B350-13/22mm 82-110-150-66mm ch-d18-24mm 2r-d5mm 1f-d7m</p>
	<p>RT08545 NO. 562345 - 562350 - 562358 - 90235668 - 90374106 - 90445101 - 9053185 - 9048976 C 12 NZ 0039929 7526327 7526506</p> <p>TUBO DE TRAVÃO FRENTE LH-RH</p> <p>OPEL COMBO Caixa/monovolume (71_) 1.4 07.1994/10.2001 44KW 60CV 1389CC - OPEL COMBO Caixa/monovolume (71_) 1.4 07.1994/10.2001 44KW 60CV 1389CC - OPEL COMBO Caixa/monovolume (71_) 1.4 07.1994/10.2001 60KW 82CV 1389CC</p> <p>310mm FB3/1 - OR1</p>		<p>RT08937 NO. 5562230 - 9191262</p> <p>TUBO DE TRAVÃO FRENTE LH-RH</p> <p>OPEL COMBO 1.3 CDTi 16V (APÓS 10-2004) - 1.4 (APÓS 10-2004) - 1.4 16V (APÓS 08-2005) - 1.6 (APÓS 10-2001) - 1.7 CDTI 16V (APÓS 12-2004) - 1.7 Di 16V (APÓS 10-2001)</p> <p>320mm F8 - OR29</p>
	<p>RT80333 NO. 562342 - 562357 - 582357 - 90217551 - 90445761</p> <p>TUBO TRAVÃO TRÁS RH-LH</p> <p>OPEL COMBO (71_) 1.2 (De 1994.07 Até 2001.10) 33kW 45cv 1195cm3 Caixa - OPEL COMBO (71_) 1.4 (De 1994.07 Até 2001.10) 44kW 60cv 1389cm3 Caixa - OPEL COMBO (71_) 1.4 (De 1994.07 Até 2001.10) 60kW 82cv 1389cm3 Caixa - OPEL COMBO (71_) 1.7 D (De 1994.07 Até 2001.10) 44kW 60cv 1686cm3 Caixa -</p> <p>410mm FA8 - FB3/1</p>		<p>S1616-D NO. 0353280 - 09191299 - 353280 - 353283 - 353284 - 90445101 - 90539059 - 9191299</p> <p>SILENT-BLOC BRAÇO SUSPENSÃO FRENTE DIREITO</p> <p>OPEL COMBO Caixa/monovolume (71_) 1.2 07.1994/10.2001 33KW 45CV 1195CC X 12 SZ C 12 NZ 0039929 7526327 7526506 - OPEL COMBO Caixa/monovolume (71_) 1.4 07.1994/10.2001 44KW 60CV 1389CC X 14 SZ C 14 NZ 0039930 0039124 0039155 7526328 7526507 - OPEL COMBO Caixa/monovolume (71_) 1.4 07.1994/10.2001 60KW 82CV 1389CC C 14 SE 0039931 7526329 7526508 - OPEL COMBO Caixa/monovolume (71_) 1.7 D 07.1994/10.20...</p> <p>170x130x60mm 1f-d14mm 3f-d14mm 2f-d9mm</p>
	<p>S1616-E NO. 0353281 - 0353282 - 0353285 - 09191298 - 353281 - 353282 - 353285 - 90445100 - 90539058</p> <p>SILENT-BLOC BRAÇO SUSPENSÃO FRENTE ESQUERDO</p> <p>OPEL COMBO Caixa/monovolume (71_) 1.2 07.1994/10.2001 33KW 45CV 1195CC X 12 SZ C 12 NZ 0039929 7526327 7526506 - OPEL COMBO Caixa/monovolume (71_) 1.4 07.1994/10.2001 44KW 60CV 1389CC X 14 SZ C 14 NZ 0039930 0039124 0039155 7526328 7526507 - OPEL COMBO Caixa/monovolume (71_) 1.4 07.1994/10.2001 60KW 82CV 1389CC C 14 SE 0039931 7526329 7526508 - OPEL COMBO Caixa/monovolume (71_) 1.7 D 07.1994/10.20...</p> <p>170x130x60mm 1f-d14mm 3f-d14mm 2f-d9mm</p>		<p>S2032 NO. 353283 - 353562 - 90539057 - 90539058 - 90539059</p> <p>SILENT-BLOC DO BRAÇO SUSPENSÃO DA FRENTE PARTE INFERIOR</p> <p>OPEL COMBO Caixa/monovolume (71_) 1.2 07.1994/10.2001 33KW 45CV 1195CC X 12 SZ C 12 NZ 0039929 7526327 7526506 - OPEL COMBO Caixa/monovolume (71_) 1.4 07.1994/10.2001 44KW 60CV 1389CC X 14 SZ C 14 NZ 0039930 0039124 0039155 7526328 7526507 - OPEL COMBO Caixa/monovolume (71_) 1.4 07.1994/10.2001 60KW 82CV 1389CC C 14 SE 0039931 7526329 7526508 - OPEL COMBO Caixa/monovolume (71_) 1.7 D 07.1994/10.20...</p> <p>d62x 35mm c-24mm dc-58mm 1f-d14mm</p>

	<p>T0039 NO. 0350127 - 350109 - 350119 - 350127 - 90168602 - 90236108 - 90447946</p> <p>BATENTE DO CENTRO DA BARRA ESTABILIZADORA</p> <p>OPEL COMBO (71_) : 1.2 07.1994/10.2001 33KW 45CV 1195CC - OPEL COMBO (71_) : 1.4 07.1994/10.2001 44KW 60CV 1389CC - OPEL COMBO (71_) : 1.4 07.1994/10.2001 60KW 82CV 1389CC - OPEL COMBO (71_) : 1.7 D 07.1994/10.2001 44KW 60CV 1686CC</p> <p>40x37x34mm 1f-d21mm</p>		<p>UAP81292 NO. 0821038 - 0821074 - 0821437 - 0821675 - 4708869 - 4809347 - 821038 - 821074 - 821437 - 821675</p> <p>ANILHA PROTEÇÃO TÉRMICA INJECTORES</p> <p>OPEL COMBO Tour 1.3 CDTI 16V (De 06-2004 Até 01-2011) 51kW 69CV 1248cc Veículo multiuso OPEL COMBO Tour 1.3 CDTI 16V (De 10-2005 Até 12-2011) 55kW 75CV 1248cc Veículo multiuso OPEL COMBO Caixa/Combi 1.3 CDTI 16V (De 08-2005 Até ...) 51kW 69CV 1248cc Caixa/Combi OPEL COMBO Caixa/Combi 1.3 CDTI 16V (De 10-2005 Até 12-2012) 55kW 75CV 1248cc Caixa/Combi OPEL COMBO Combi / Tour (X12) 1.3 CDTI (C26 ...</p> <p>d16x1mm 1f-d7mm</p>
	<p>UAP81292 NO. 0821038 - 0821074 - 0821437 - 0821675 - 4708869 - 4809347 - 821038 - 821074 - 821437 - 821675</p> <p>ANILHA PROTEÇÃO TÉRMICA INJECTORES</p> <p>OPEL COMBO Tour 1.3 CDTI 16V (De 06-2004 Até 01-2011) 51kW 69CV 1248cc Veículo multiuso OPEL COMBO Tour 1.3 CDTI 16V (De 10-2005 Até 12-2011) 55kW 75CV 1248cc Veículo multiuso OPEL COMBO Caixa/Combi 1.3 CDTI 16V (De 08-2005 Até ...) 51kW 69CV 1248cc Caixa/Combi OPEL COMBO Caixa/Combi 1.3 CDTI 16V (De 10-2005 Até 12-2012) 55kW 75CV 1248cc Caixa/Combi OPEL COMBO Combi / Tour (X12) 1.3 CDTI (C26 ...</p> <p>d16x1mm 1f-d7mm</p>		<p>UMB84011 NO. 031126</p> <p>TAMPÃO BLOCO MOTOR</p> <p>OPEL COMBO (71_) 1.2 (De 07-1994 Até 10-2001) 33kW 45CV 1195cc Caixa OPEL COMBO (71_) 1.4 (De 07-1994 Até 10-2001) 44kW 60CV 1389cc Caixa OPEL COMBO Tour 1.6 CNG (De 06-2006 Até ...) 69kW 94CV 1598cc Veículo multiuso OPEL COMBO Tour 1.6 CNG (De 04-2005 Até ...) 71kW 97CV 1598cc Veículo multiuso OPEL COMBO Caixa/Combi 1.6 CNG 16V (De 06-2006 Até ...) 69kW 94CV 1598cc Caixa/Combi OPEL COMBO Cai...</p> <p>d-18x8mm di-16mm</p>
	<p>UMB84011L NO. 11062402 - 2060675</p> <p>TAMPÃO BLOCO DE MOTOR (RELAS)</p> <p>OPEL COMBO (71_) 1.2 (De 07-1994 Até 10-2001) 33kW 45CV 1195cc Caixa OPEL COMBO (71_) 1.4 (De 07-1994 Até 10-2001) 44kW 60CV 1389cc Caixa OPEL COMBO Tour 1.6 CNG (De 06-2006 Até ...) 69kW 94CV 1598cc Veículo multiuso OPEL COMBO Tour 1.6 CNG (De 04-2005 Até ...) 71kW 97CV 1598cc Veículo multiuso OPEL COMBO Caixa/Combi 1.6 CNG 16V (De 06-2006 Até ...) 69kW 94CV 1598cc Caixa/Combi OPEL COMBO Caixa/Co...</p> <p>d-18x8mm di-16mm</p>		<p>UMB84019 NO. 2060668</p> <p>TAMPÃO BLOCO MOTOR</p> <p>OPEL COMBO Tour 1.6 CNG (De 06-2006 Até ...) 69kW 94CV 1598cc Veículo multiuso OPEL COMBO Tour 1.6 CNG (De 04-2005 Até ...) 71kW 97CV 1598cc Veículo multiuso OPEL COMBO Caixa/Combi 1.6 CNG 16V (De 06-2006 Até ...) 69kW 94CV 1598cc Caixa/Combi OPEL COMBO Caixa/Combi 1.6 CNG 16V (De 04-2005 Até ...) 71kW 97CV 1598cc Caixa/Combi</p> <p>d-26x9,5mm di-23,3mm</p>
	<p>UMB84019L NO. 2060668</p> <p>TAMPÃO BLOCO DE MOTOR (RELAS)</p> <p>OPEL COMBO Tour 1.6 CNG (De 06-2006 Até ...) 69kW 94CV 1598cc Veículo multiuso OPEL COMBO Tour 1.6 CNG (De 04-2005 Até ...) 71kW 97CV 1598cc Veículo multiuso OPEL COMBO Caixa/Combi 1.6 CNG 16V (De 06-2006 Até ...) 69kW 94CV 1598cc Caixa/Combi OPEL COMBO Caixa/Combi 1.6 CNG 16V (De 04-2005 Até ...) 71kW 97CV 1598cc Caixa/Comb</p> <p>d-26x9,5mm di-23,3mm</p>		<p>UMB84021 NO. 2060673</p> <p>TAMPÃO BLOCO MOTOR</p> <p>OPEL COMBO (71_) 1.2 (De 07-1994 Até 10-2001) 33kW 45CV 1195cc Caixa OPEL COMBO (71_) 1.4 (De 07-1994 Até 10-2001) 44kW 60CV 1389cc Caixa OPEL COMBO Tour 1.6 CNG (De 06-2006 Até ...) 69kW 94CV 1598cc Veículo multiuso OPEL COMBO Tour 1.6 CNG (De 04-2005 Até ...) 71kW 97CV 1598cc Veículo multiuso OPEL COMBO Caixa/Combi 1.6 CNG 16V (De 06-2006 Até ...) 69kW 94CV 1598cc Caixa/Combi OPEL COMBO Cai...</p> <p>d-28x7mm di-25,6mm</p>
	<p>UMB84021L NO. 2060673</p> <p>TAMPÃO BLOCO DE MOTOR (RELAS)</p> <p>OPEL COMBO (71_) 1.2 (De 07-1994 Até 10-2001) 33kW 45CV 1195cc Caixa OPEL COMBO (71_) 1.4 (De 07-1994 Até 10-2001) 44kW 60CV 1389cc Caixa OPEL COMBO Tour 1.6 CNG (De 06-2006 Até ...) 69kW 94CV 1598cc Veículo multiuso OPEL COMBO Tour 1.6 CNG (De 04-2005 Até ...) 71kW 97CV 1598cc Veículo multiuso OPEL COMBO Caixa/Combi 1.6 CNG 16V (De 06-2006 Até ...) 69kW 94CV 1598cc Caixa/Combi OPEL COMBO Caixa/Co...</p> <p>d-28x7mm di-25,6mm</p>		<p>UMB84029 NO. 2060946</p> <p>TAMPÃO BLOCO MOTOR</p> <p>OPEL COMBO (71_) 1.2 (07.94 A 10.01) 45cv 1195cc Caixa - OPEL COMBO Caixa/Combi 1.6 CNG 16V (A Partir de 04.05) 97cv 1598cc Caixa/Combi</p> <p>d36x10mm di-32mm</p>
	<p>UMV25431 NO. 5738741</p> <p>MANETE PUNHO TOPO ALAVANCA MUDANÇAS 5 VELOCIDADES F33MM</p> <p>OPEL COMBO Caixa/monovolume 1.3 CDTI 16V desde 08.2005 51KW 69CV 1248CC Z 13 DT 0035AEX 0035097 0035536 - OPEL COMBO Caixa/monovolume 1.3 CDTI 16V 10.2005/12.2012 55KW 75CV 1248CC Z 13 DTJ 0035AQW 0035AEZ 0035AMU 0035BBQ 0035BBR - OPEL COMBO Caixa/monovolume 1.4 16V desde 08.2005 66KW 90CV 1364CC Z 14 XEP 0035AEW 0035096 0035AMS - OPEL COMBO Caixa/monovolume 1.6 desde 10.2001 64KW 87CV 1598CC Z 16...</p> <p>d50x53mm 1f-d33mm</p>		<p>UMV26812 NO. 5738040 - 93185666</p> <p>MANETE PUNHO TOPO ALAVANCA MUDANÇAS 6 VELOCIDADES F12MM</p> <p>OPEL COMBO Caixa/monovolume 1.3 CDTI 16V desde 08.2005 51KW 69CV 1248CC Z 13 DT 0035AEX 0035097 0035536 - OPEL COMBO Caixa/monovolume 1.3 CDTI 16V 10.2005/12.2012 55KW 75CV 1248CC Z 13 DTJ 0035AQW 0035AEZ 0035AMU 0035BBQ 0035BBR - OPEL COMBO Caixa/monovolume 1.4 16V desde 08.2005 66KW 90CV 1364CC Z 14 XEP 0035AEW 0035096 0035AMS - OPEL COMBO Caixa/monovolume 1.6 desde 10.2001 64KW 87CV 1598CC Z 16...</p> <p>d52x86mm 1f-d12mm</p>
	<p>UTR0800 NO. 1304240 - 1304654 - 1304659 - 1304660 - 1304661 - 1304665 - 1304666 - 1304667 - 1304853 - 90352470 - ...</p> <p>TAMPÃO RESERVATÓRIO LÍQUIDO REFRIGERAÇÃO</p> <p>OPEL COMBO (71_) 1.2 (07.94 A 10.01) 45cv 1195cc Caixa - OPEL COMBO (71_) 1.4 (07.94 A 10.01) 60cv 1389cc Caixa - OPEL COMBO (71_) 1.4 (07.94 A 10.01) 82cv 1389cc Caixa - OPEL COMBO (71_) 1.7 D (07.94 A 10.01) 60cv 1686cc Caixa - OPEL COMBO Caixa/Combi 1.4 16V (APÓS 08.05) 90cv 1364cc Caixa/Combi - OPEL COMBO Caixa/Combi 1.3 CDTI 16V (APÓS 08.05) 69cv 1248cc Caixa/Combi - OPEL COMBO C...</p> <p>d62x25mm 1f-d53x14mm</p>		<p>UTR0811 NO. 1304659 - 1304660 - 1304661 - 1304665 - 1304666 - 1304853 - 4395513 - 90352470 - 90409256 - 90409257...</p> <p>TAMPÃO RESERVATÓRIO LÍQUIDO REFRIGERAÇÃO</p> <p>OPEL COMBO 1.2 (07.94 A 10.01) 45cv 1195cc Caixa</p> <p>60x25mm 1f-d52x14mm</p>
	<p>UTR0820 NO. 90352470 - 90409256 - 90409257 - 9041032690497472 - 90467473</p> <p>TAMPÃO RESERVATÓRIO LÍQUIDO REFRIGERAÇÃO</p> <p>OPEL COMBO (71_) 1.2 (07.94 A 10.01) 45cv 1195cc Caixa - OPEL COMBO (71_) 1.4 (07.94 A 10.01) 60cv 1389cc Caixa - OPEL COMBO (71_) 1.4 (07.94 A 10.01) 82cv 1389cc Caixa - OPEL COMBO (71_) 1.7 D (07.94 A 10.01) 60cv 1686cc Caixa - OPEL COMBO Tour 1.4 (A Partir de 10.04) 90cv 1364cc Veículo multiuso - OPEL COMBO Tour 1.6 (A Partir de 10.01) 87cv 1598cc Veículo multiuso - OPEL COMBO Tour ...</p> <p>d62x23mm 1f-d53x12mm</p>		<p>UTR1300 NO. 00650090 - 05650831</p> <p>TAMPÃO RESERVATÓRIO DO OLEO</p> <p>OPEL COMBO Tour 1.7 CDTI 16V (De 07-2004 Até 12-2011) 74KW 101CV 1686cc Veículo multiuso OPEL COMBO Caixa/Combi 1.4 16V (De 08-2005 Até ...) 66kW 90CV 1364cc Caixa/Combi OPEL COMBO Caixa/Combi 1.7 D 16V (De 10-2001 Até ...) 48kW 65CV 1686cc Caixa/Combi OPEL COMBO Caixa/Combi 1.7 DTI 16V (De 10-2001 Até ...) 55kW 75CV 1686cc Caixa/Combi OPEL COMBO Caixa/Combi 1.7 CDTI 16V (De 12-2004 Até ...) ...</p> <p>d59x31mm d45x12mm</p>







	<p>UTR1404 NO. 0808211 - 09117533 - 808211</p> <p>TAMPÃO DEPÓSITO COMBUSTIVEL</p> <p>OPEL COMBO Caixa/monovolume 1.3 CDTI 16V (De 08.2005 -) 51kW 69cv 1248cm3 Caixa/monovolume - OPEL COMBO Caixa/monovolume 1.3 CDTI 16V (De 10.2005 Até 2012.2012) 55kW 75cv 1248cm3 Caixa/monovolume - OPEL COMBO Caixa/monovolume 1.4 16V (De 08.2005 -) 66kW 90cv 1364cm3 Caixa/monovolume - OPEL COMBO Caixa/monovolume 1.6 (De 10.2001 -) 64kW 87cv 1598cm3 Caixa/monovolume - OPEL COMBO Caixa/monovolume 1....</p> <p>d67x62mm d41x45mm</p>		<p>UTV83011 NO. 0652475 - 09275631 - 652475 - 652491 - 90409376 - 9275631 - N90288901</p> <p>TAMPÃO VEDAÇÃO BUJÃO</p> <p>OPEL COMBO (71_) 1.2 (De 07-1994 Até 10-2001) 33kW 45CV 1195cc Caixa OPEL COMBO (71_) 1.4 (De 07-1994 Até 10-2001) 44kW 60CV 1389cc Caixa OPEL COMBO (71_) 1.4 (De 07-1994 Até 10-2001) 60kW 82CV 1389cc Caixa OPEL COMBO Tour 1.6 CNG (De 06-2006 Até 12-2011) 69kW 94CV 1598cc Veículo multiuso OPEL COMBO Tour 1.6 CNG (De 04-2005 Até 01-2011) 71kW 97CV 1598cc Veículo multiuso OPEL COMBO Caixa/Combi...</p> <p>19x18mm c12mm d14mm</p>
	<p>UTV83019 NO. 0652315 - 0652477 - 652315 - 652477 - 90502556 - 96023264</p> <p>TAMPÃO VEDAÇÃO BUJÃO</p> <p>OPEL COMBO Tour 1.4 (De 10-2004 Até 12-2011) 66kW 90CV 1364cc Veículo multiuso OPEL COMBO Tour 1.6 (De 10-2001 Até 09-2006) 64kW 87CV 1598cc Veículo multiuso OPEL COMBO Caixa/Combi 1.4 16V (De 08-2005 Até ...) 66kW 90CV 1364cc Caixa/Combi OPEL COMBO Caixa/Combi 1.6 (De 10-2001 Até ...) 64kW 87CV 1598cc Caixa/Combi</p> <p>d25x14mm c9mm d13mm</p>		<p>W5045 NO. 5614417 - 614457 - 614637 - 97011870 - 97129070</p> <p>POLIE DA CAMBOTA (1+1+1 PISTAS)</p> <p>OPEL COMBO Caixa/monovolume (71_) 1.7 D 07.1994/10.2001 44KW 60CV 1686CC</p> <p>d139mm d48mm</p>
	<p>W5082 NO. 0614426 - 5614444 - 614426 - 97251975 - 97361525</p> <p>POLIE DA CAMBOTA (6 PISTAS)</p> <p>OPEL COMBO Caixa/monovolume 1.7 DI 16V desde 10.2001/>>>> 48KW 65CV 1686CC Y 17 DTL 0035005 - OPEL COMBO Caixa/monovolume 1.7 DTI 16V 10.2001/>>>> 55KW 75CV 1686CC Y 17 DT 0035438, 0035004 - OPEL COMBO Tour 1.7 DI 16V 10.2001/06.2004 48KW 65CV 1686CC Y 17 DTL 0035439 - OPEL COMBO Tour 1.7 DTI 16V 10.2001/06.2004 55KW 75CV 1686CC Y 17 DT 0035438</p> <p>d139/141mm d48mm</p>		<p>Y3212 NO. 1008501 - 1008504 - 4709077</p> <p>PARAFUSO PERNO RODA CHAVE 17 M12X1,50X48MM (BASE CONICA PARA JANTES AÇO E LIGA LEVE)</p> <p>OPEL COMBO Caixa/monovolume (71_) 1.2 (07.1994 - 10.2001) 33kw 45cv 1195cm3 Caixa/monovolume OPEL COMBO Caixa/monovolume (71_) 1.4 (07.1994 - 10.2001) 44kw 60cv 1389cm3 Caixa/monovolume OPEL COMBO Caixa/monovolume (71_) 1.4 (07.1994 - 10.2001) 60kw 82cv 1389cm3 Caixa/monovolume OPEL COMBO Caixa/monovolume (71_) 1.7 D (07.1994 - 10.2001) 44kw 60cv 1686cm3 Caixa/monovolume OPEL COMBO Caixa/monovolum...</p> <p>C48mm (Ch-17mm) M12x1,50x22mm</p>
	<p>Z55280 NO. 2228839</p> <p>MOLA PAINEL REVESTIMENTO DAS PORTAS</p> <p>OPEL COMBO Caixa/monovolume 1.3 CDTI 16V desde 08.2005 51KW 69CV 1248CC Z 13 DT 0035AEX 0035097 0035536 - OPEL COMBO Caixa/monovolume 1.3 CDTI 16V 10.2005/12.2012 55KW 75CV 1248CC Z 13 DTJ 0035AQW 0035AEZ 0035AMU 0035BBQ 0035BBR - OPEL COMBO Caixa/monovolume 1.4 16V desde 08.2005 66KW 90CV 1364CC Z 14 XEP 0035AEW 0035096 0035AMS - OPEL COMBO Caixa/monovolume 1.6 desde 10.2001 64KW 87CV 1598CC Z 16...</p> <p>F-G-mm T-27L-18H-12S-5mm</p>		<p>Z80540 NO. 2240861 - 90022049</p> <p>Mola de painel</p> <p>OPEL COMBO</p> <p>d12x14.3mm 1p-d7-12.3mm</p>
	<p>Z80662 NO. 1218604 - 90386374</p> <p>MOLA SUPORTE FAROL PRINCIPAL (GASTA 2 UNIDADES)</p> <p>OPEL COMBO Caixa/monovolume (71_) 1.2 07.1994/10.2001 33KW 45CV 1195CC - OPEL COMBO Caixa/monovolume (71_) 1.4 07.1994/10.2001 44KW 60CV 1389CC - OPEL COMBO Caixa/monovolume (71_) 1.4 07.1994/10.2001 60KW 82CV 1389CC - OPEL COMBO Caixa/monovolume (71_) 1.7 D 07.1994/10.2001 44KW 60CV 1686CC</p> <p>26x23.4x20mm</p>		<p>Z9011 NO. 1261479 - 1449282600 - 4709339 - 4711509 - 854880</p> <p>MOLA DE ESCAPE</p> <p>OPEL COMBO</p> <p>d23x42mm</p>



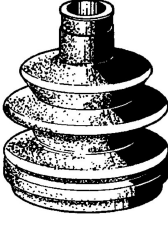
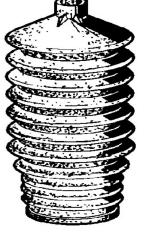



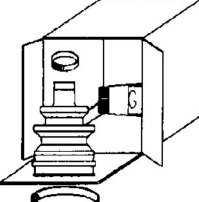





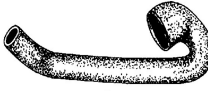

OPEL CORSA







	<p>E1007 NO. 852722</p> <p>ESTICADOR SUPORTE DE ESCAPE</p> <p>OPEL CORSA</p> <p>70x47x40mm</p>		<p>E1007 NO. 852722</p> <p>ESTICADOR SUPORTE DE ESCAPE</p> <p>OPEL CORSA</p> <p>70x47x40mm</p>
	<p>M6008 NO. 854943</p> <p>JUNTA DE ESCAPE</p> <p>OPEL CORSA A Hatchback (S83): 1.5 TD (F08, M08, F68, M68) 03.1988/03.1993 49KW 67CV 1488CC</p> <p>d65x5mm 1f-d50mm</p>		<p>R2470 NO. 1336323 - M-220543</p> <p>TUBO INFERIOR DO RADIADOR</p> <p>OPEL CORSA A Hatchback (S83): 1.2 (F08, M08, F68, M68) 09.1982/08.1990 33KW 45CV 1196CC - OPEL CORSA A Hatchback (S83): 1.2 i (F08, M08, F68, M68) 09.1989/03.1993 33KW 45CV 1195CC - OPEL CORSA A Hatchback (S83): 1.2 N (F08, M08, F68, M68) 01.1990/03.1993 38KW 52CV 1196CC - OPEL CORSA A Hatchback (S83): 1.2 S (F08, M08, F68, M68) 09.1982/02.1990 40KW 55CV 1196CC - OPEL CORSA A Hatchback (S83): 1.2 ...</p> <p>B440-d35/35mm 115-205-100-110-70mm</p>

	<p>RT80583 NO. 5562247</p> <p>TUBO DE TRAVÃO TRÁS LH (COM DISCO)</p> <p>OPEL CORSA 1.0 (motor Z 10 XEP) (APÓS 07-2006) - 1.2 (motor Z 12 XEP) (APÓS 07-2006) - 1.3 CDTi (motor Z 13 DTH) (APÓS 07-2006) - 1.3 CDTi (motor Z 13 DTJ) (APÓS 07-2006) - 1.4 (motor Z 14 XEP) (APÓS 07-2006) - 1.6 TURBO (motor Z 16 LEL) (APÓS 02-2007) -</p> <p>760mm</p>		<p>U7004 NO. 5817552 - 90541910</p> <p>ORING DE VÁLVULA INJETORA (Di 7,52 - De 14,58 - E 3,53)</p> <p>OPEL CORSA F (P2JO) 1.2 (68) (07.2019 -) 55kw 75cv 1199cm3 Hatchback</p> <p>d14x3mm 1f-d8mm</p>
	<p>Y3218 NO. 9818845080</p> <p>PARAFUSO PERNO RODA CHAVE 17 M12X1,25X48MM (BASE CONICA PARA JANTES DE AÇO E LIGA LEVE)</p> <p>OPEL CORSA F (P2JO) 1.2 (68) 07.2019 -) 55kw 75cv 1199cm3 Hatchback OPEL CORSA F (P2JO) 1.2 (68) 07.2019 -) 74kw 101cv 1199cm3 Hatchback OPEL CORSA F (P2JO) 1.2 (68) 07.2019 -) 96kw 131cv 1199cm3 Hatchback OPEL CORSA F (P2JO) 1.5 (68) 07.2019 -) 75kw 102cv 1499cm3 Hatchback OPEL CORSA F (P2JO) CORSA-e (68) 07.2019 -) 100kw 136cv Hatchback OPEL CORSA F Caixa/parte traseira inclinada 1.2 (68) 07.201...</p> <p>C48mm (Ch-17mm) M12x1,25x24mm</p>		<p>Z55237 NO. 090087290</p> <p>MOLA DE FIXAÇÃO CAVA DE RODA</p> <p>OPEL CORSA</p> <p>F8mm T16mm S1-2mm H11mm L8mm S1mm Z23mm</p>
	<p>Z80628 NO. 2240582</p> <p>Mola de painel</p> <p>OPEL CORSA</p> <p>d17x18mm 1p-d8.5-12mm</p>		<p>Z80655 NO. 2338955 - 2338961 - 2346824 - 8964.57 - 8964.81 - 90283614 - 90431553</p> <p>MOLA REVESTIMENTO DO HABITÁCULO</p> <p>OPEL CORSA A Hatchback (S83): 1.0 (F08, M08, F68, M68) 09.1982/03.1993 33KW 45CV 993CC - OPEL CORSA A Hatchback (S83): 1.2 (F08, M08, F68, M68) 09.1982/08.1990 33KW 45CV 1196CC - OPEL CORSA A Hatchback (S83): 1.2 i (F08, M08, F68, M68) 09.1989/03.1993 33KW 45CV 1195CC - OPEL CORSA A Hatchback (S83): 1.2 S (F08, M08, F68, M68) 09.1982/02.1990 40KW 55CV 1196CC - OPEL CORSA A Hatchback (S83): 1.3 (F0...</p> <p>d14x17.5mm 1p-d8-15.5mm</p>
	<p>Z80660 NO. 1217801 - 90321482</p> <p>MOLA SUPORTE FAROL PRINCIPAL (GASTA 2 UNIDADES)</p> <p>OPEL CORSA A Caixa/parte traseira inclinada (S83) 1.0 (F08, W5L) 02.1986/04.1989 33KW 45CV 993CC 10 S 7526500 - OPEL CORSA A Caixa/parte traseira inclinada (S83) 1.2 (F08, W5L) 02.1986/04.1989 33KW 45CV 1196CC E 12 GV 12 NC 7526501 - OPEL CORSA A Caixa/parte traseira inclinada (S83) 1.2 (F08, W5L) 02.1986/04.1989 40KW 54CV 1196CC 12 ST 7526502 - OPEL CORSA A Caixa/parte traseira inclinada (S83) 1....</p> <p>30x25x32mm 1p-12x11-9mm</p>		<p>Z80662 NO. 1218604 - 90386374</p> <p>MOLA SUPORTE FAROL PRINCIPAL (GASTA 2 UNIDADES)</p> <p>OPEL CORSA B (S93): 1.0 i 12V (F08, F68, M68) 11.1996/09.2000 40KW 54CV 973CC - OPEL CORSA B (S93): 1.2 i (F08, F68, M68) 03.1993/09.2000 33KW 45CV 1195CC - OPEL CORSA B (S93): 1.2 i (F08, F68, M68) 03.1993/09.2000 33KW 45CV 1195CC - OPEL CORSA B (S93): 1.2 i 16V (F08, F68, M68) 03.1998/09.2000 48KW 65CV 1199CC - OPEL CORSA B (S93): 1.4 i (F08, F68, M68) 03.1993/09.2000 44KW 60CV 1389CC - OPEL COR...</p> <p>26x23.4x20mm</p>
	<p>Z80730 NO. 1406984</p> <p>Mola de fixação</p> <p>OPEL CORSA</p> <p>d18x25.5mm 1p-8x10-23.5mm 1f-d5.5mm</p>		<p>Z80739 NO. 1400806 - 51111964186</p> <p>Mola de fixação</p> <p>OPEL CORSA</p> <p>d20x41mm 1p-d6.5-20.5mm</p>
	<p>Z80743 NO. 2345957</p> <p>Mola de painel</p> <p>OPEL CORSA</p> <p>d17x19mm 1p-d9-13mm</p>		<p>Z80792 NO. 174864</p> <p>Mola de painel</p> <p>OPEL CORSA</p> <p>d17.6x18.8mm 1p-d8.5-14.5mm</p>
	<p>Z80863 NO. 122920 - 9114743</p> <p>MOLA DE FRISO</p> <p>OPEL CORSA</p> <p>F-9T-12mm L-9H-13S1-2mm</p>		

	<p>A0100 NO. 0684195 - 0684263 - 684195 - 684263 - 90135339 - 90217259 - 90250348 - 90250434 - 96227425</p> <p>APOIO SUPORTE FRENTE DIREITO DO MOTOR</p> <p>OPEL CORSA A Hatchback (S83): 1.0 (F08, M08, F68, M68) 09.1982/03.1993 33KW 45CV 993CC - OPEL CORSA A Hatchback (S83): 1.2 (F08, M08, F68, M68) 09.1982/08.1990 33KW 45CV 1196CC - OPEL CORSA A Hatchback (S83): 1.2 i (F08, M08, F68, M68) 09.1989/03.1993 33KW 45CV 1195CC - OPEL CORSA A Hatchback (S83): 1.2 S (F08, M08, F68, M68) 09.1982/02.1990 40KW 55CV 1196CC - OPEL CORSA A Hatchback (S83): 1.3 (F0...</p> <p>114x91x56mm 2p-d9-25mm 2r-d8mm</p>		<p>A0100 NO. 0684195 - 0684263 - 684195 - 684263 - 90135339 - 90217259 - 90250348 - 90250434 - 96227425</p> <p>APOIO SUPORTE FRENTE DIREITO DO MOTOR</p> <p>OPEL CORSA A TR (S83): 1.0 (F11, M11, F19, M19) 09.1982/09.1992 33KW 45CV 993CC - OPEL CORSA A TR (S83): 1.2 N (F11, M11, F19, M19) 01.1985/10.1987 33KW 45CV 1196CC - OPEL CORSA A TR (S83): 1.2 i (F11, M11, F19, M19) 09.1989/03.1993 33KW 45CV 1195CC - OPEL CORSA A TR (S83): 1.2 S (F11, M11, F19, M19) 09.1982/03.1993 40KW 55CV 1196CC - OPEL CORSA A TR (S83): 1.2 S (F11, M11, F19, M19) 09.1982/10.19...</p> <p>114x91x56mm 2p-d9-25mm 2r-d8mm</p>
	<p>A0101 NO. 0684262 - 684242 - 684262 - 90223323</p> <p>APOIO SUPORTE FRENTE ESQUERDO DO MOTOR</p> <p>OPEL CORSA A Caixa/parte traseira inclinada (S83) 1.0 (F08, W5L) 02.1986/04.1989 33KW 45CV 993CC 10 S 7526500 - OPEL CORSA A Caixa/parte traseira inclinada (S83) 1.2 (F08, W5L) 02.1986/04.1989 33KW 45CV 1196CC E 12 GV12 NC 7526501 - OPEL CORSA A Caixa/parte traseira inclinada (S83) 1.2 (F08, W5L) 02.1986/04.1989 40KW 54CV 1196CC 12 ST 7526502 - OPEL CORSA A Caixa/parte traseira inclinada (S83) 1....</p> <p>89x83x70mm 1p-d10-20mm 1f-d10mm</p>		<p>A1055 NO. 0684280 - 684280 - 90304644</p> <p>APOIO SUPORTE ESQUERDO DO MOTOR (CAIXA DE VELOCIDADES)</p> <p>OPEL CORSA A Caixa/parte traseira inclinada (S83) 1.5 D (F08, W5L) 06.1987/04.1989 37KW 50CV 1488CC 15 D (4EC1) 7526505 - OPEL CORSA A Hatchback (S83) 1.5 D (F08, M08, F68, M68) 09.1987/03.1993 37KW 50CV 1488CC 15 D (4EC1) 7526310 - OPEL CORSA A Hatchback (S83) 1.5 TD (F08, M08, F68, M68) 03.1988/03.1993 49KW 67CV 1488CC 15 DT (T4EC1) 7526312 - OPEL CORSA A TR (S83) 1.5 D (F11, M11, F19, M19) 10.1...</p> <p>89x85x70mm 1p-d10-20mm 1f-d10mm</p>
	<p>A1069 NO. 0682555 - 0682600 - 0682603 - 682555 - 682600 - 682603 - 90304647 - 90473837 - 90538063</p> <p>APOIO SUPORTE TRASEIRO DO MOTOR (CAIXA)</p> <p>OPEL CORSA A Caixa/parte traseira inclinada (S83) 1.5 D (F08, W5L) 06.1987/04.1989 37KW 50CV 1488CC 15 D (4EC1) 7526505 - OPEL CORSA A Hatchback (S83) 1.5 D (F08, M08, F68, M68) 09.1987/03.1993 37KW 50CV 1488CC 15 D (4EC1) 7526310 - OPEL CORSA A Hatchback (S83) 1.5 TD (F08, M08, F68, M68) 03.1988/03.1993 49KW 67CV 1488CC 15 DT (T4EC1) 7526312 - OPEL CORSA A TR (S83) 1.5 D (F11, M11, F19, M19) 10.1...</p> <p>145x90x66mm 1f-d10mm</p>		<p>A1206 NO. 682549</p> <p>APOIO ESQUERDO DE MOTOR TRÁS</p> <p>OPEL CORSA A 1.4i - 1.4S - 1.4Si (1990 A 1993)</p> <p>158x90x60mm 2r-d10mm</p>
	<p>A1214 NO. 682552</p> <p>APOIO DE MOTOR (PARTE DE TRÁS)</p> <p>OPEL CORSA A 1.0 - 1.2 - 1.3 - 1.4i - 1.4S (09-1982 A 03-1993)</p> <p>145x85x66mm 1f-d10mm 1f-d8mm</p>		<p>A1218 NO. 0344519 - 344502 - 344519 - 90445207 - 90445208</p> <p>APOIO DO AMOTECEDOR DE TRÁS</p> <p>OPEL CORSA A Hatchback (S83): 1.0 (F08, M08, F68, M68) 09.1982/03.1993 33KW 45CV 993CC - OPEL CORSA A Hatchback (S83): 1.2 (F08, M08, F68, M68) 09.1982/08.1990 33KW 45CV 1196CC - OPEL CORSA A Hatchback (S83): 1.2 i (F08, M08, F68, M68) 09.1989/03.1993 33KW 45CV 1195CC - OPEL CORSA A Hatchback (S83): 1.2 N (F08, M08, F68, M68) 01.1990/03.1993 38KW 52CV 1196CC - OPEL CORSA A Hatchback (S83): 1.2 S (...)</p> <p>135x110x40mm 1f-d34mm</p>
	<p>A1314 NO. 344519 - 90445207</p> <p>APOIO DE AMORTECEDOR DA FRENTE</p> <p>OPEL CORSA A Hatchback (S83): 1.0 (F08, M08, F68, M68) 09.1982/03.1993 33KW 45CV 993CC - OPEL CORSA A Hatchback (S83): 1.2 (F08, M08, F68, M68) 09.1982/08.1990 33KW 45CV 1196CC - OPEL CORSA A Hatchback (S83): 1.2 i (F08, M08, F68, M68) 09.1989/03.1993 33KW 45CV 1195CC - OPEL CORSA A Hatchback (S83): 1.2 N (F08, M08, F68, M68) 01.1990/03.1993 38KW 52CV 1196CC - OPEL CORSA A Hatchback (S83): 1.2 S (...)</p> <p>136x109x38mm 2p-d8-17mm 1f-d37mm</p>		<p>A1398 NO. 0684281 - 684281 - 90289721</p> <p>APOIO SUPORTE DE MOTOR DIREITO</p> <p>OPEL CORSA A Caixa/parte traseira inclinada (S83) 1.5 D (F08, W5L) 06.1987/04.1989 37KW 50CV 1488CC 15 D (4EC1) 7526505 - OPEL CORSA A Hatchback (S83) 1.5 D (F08, M08, F68, M68) 09.1987/03.1993 37KW 50CV 1488CC 15 D (4EC1) 7526310 - OPEL CORSA A Hatchback (S83) 1.5 TD (F08, M08, F68, M68) 03.1988/03.1993 49KW 67CV 1488CC 15 DT (T4EC1) 7526312 - OPEL CORSA A TR (S83) 1.5 D (F11, M11, F19, M19) 10.1...</p> <p>180x113x95mm 1p-d10-45mm</p>
	<p>A2322 NO. 0682561 - 682561</p> <p>APOIO DO MOTOR PARTE DE TRÁS</p> <p>OPEL CORSA A Hatchback (S83) 1.4 i (F08, M08, F68, M68) 01.1990/03.1993 44KW 60CV 1389CC C 14 NZ 7526317 - OPEL CORSA A Hatchback (S83) 1.4 S (F08, M08, F68, M68) 01.1990/03.1993 53KW 72CV 1389CC 14 NV 7526316 - OPEL CORSA A Hatchback (S83) 1.4 Si (F08, M08, F68, M68) 09.1991/03.1993 60KW 82CV 1389CC C 14 SE 7526320 - OPEL CORSA A TR (S83) 1.4 i (F11, M11, F19, M19) 10.1989/03.1993 44KW 60CV 1389C...</p> <p>139x66x73mm 1f-d10mm 2f-11x15mm</p>		<p>A2557 NO. 0684248 - 684185 - 684248 - 90121917 - 90184728</p> <p>APOIO DO MOTOR LADO ESQUERDO Á FRENTE</p> <p>OPEL CORSA A Caixa/parte traseira inclinada (S83) 1.2 (F08, W5L) (De 02.1986 Até 04.1989) 33kW 45cv 1196cm3 Caixa/parte traseira inclinada - OPEL CORSA A Hatchback (S83) 1.0 (F08, M08, F68, M68) (De 09.1982 Até 03.1993) 33kW 45cv 993cm3 Hatchback - OPEL CORSA A Hatchback (S83) 1.2 (F08, M08, F68, M68) (De 09.1982 Até 08.1990) 33kW 45cv 1196cm3 Hatchback - OPEL CORSA A Hatchback (S83) 1.2 (F08, M08, ...)</p> <p>143x92x64mm 2p-d10x22mm 2r-d8mm</p>
	<p>BB24 NO. 350376</p> <p>ABRACADEIRA BARRA ESTABILIZADORA (GASTA 2 UNIDADES)</p> <p>OPEL CORSA A Hatchback (S83): 1.0 (F08, M08, F68, M68) 09.1982/03.1993 33KW 45CV 993CC - OPEL CORSA A Hatchback (S83): 1.2 (F08, M08, F68, M68) 09.1982/08.1990 33KW 45CV 1196CC - OPEL CORSA A Hatchback (S83): 1.2 i (F08, M08, F68, M68) 09.1989/03.1993 33KW 45CV 1195CC - OPEL CORSA A Hatchback (S83): 1.2 N (F08, M08, F68, M68) 01.1990/03.1993 38KW 52CV 1196CC - OPEL CORSA A Hatchback (S83): 1.2 S (...)</p> <p>73x29x30mm 2p-d8-23mm</p>		<p>E0013 NO. 852715 - 852716 - 852720</p> <p>ESTICADOR DE ESCAPE</p> <p>OPEL CORSA A 1.0 - 1.2 - 1.3 - 1.5D - 1.5TD - (1982 A 1993)</p> <p>66x56x13mm</p>
	<p>E0048 NO. 852506</p> <p>ESTICADOR DE ESCAPE</p> <p>OPEL CORSA A (09-1982 A 03-1993)</p> <p>59x40x28mm 2f-d14mm</p>		<p>E1003 NO. 0856519 - 856519 - 9281771</p> <p>ESTICADOR SUPORTE TRÁS DO ESCAPE</p> <p>OPEL CORSA A Hatchback (S83): 1.0 (F08, M08, F68, M68) 09.1982/03.1993 33KW 45CV 993CC - OPEL CORSA A Hatchback (S83): 1.2 (F08, M08, F68, M68) 09.1982/08.1990 33KW 45CV 1196CC - OPEL CORSA A Hatchback (S83): 1.2 i (F08, M08, F68, M68) 09.1989/03.1993 33KW 45CV 1195CC - OPEL CORSA A Hatchback (S83): 1.2 N (F08, M08, F68, M68) 01.1990/03.1993 38KW 52CV 1196CC - OPEL CORSA A Hatchback (S83): 1.2 S (...)</p> <p>50x44x42mm 2f-d5mm 2f-18x9mm</p>



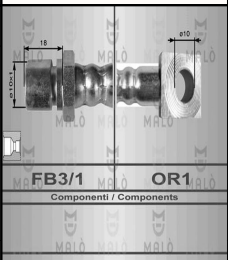
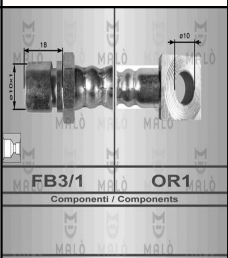
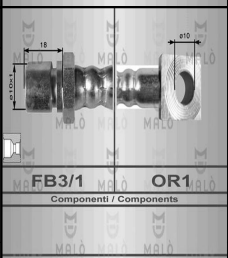
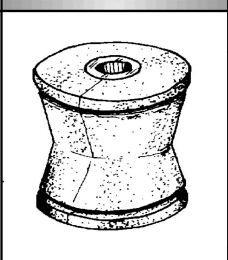
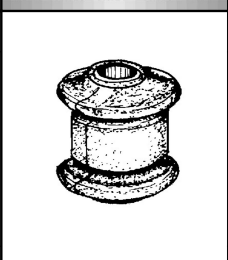
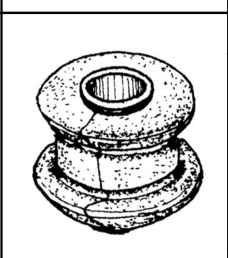
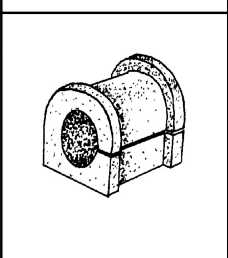
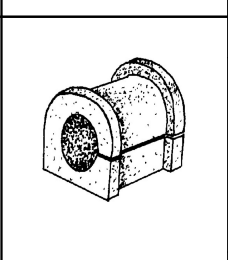
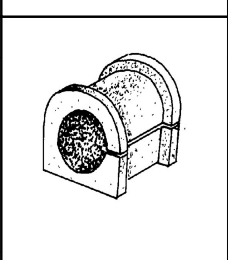



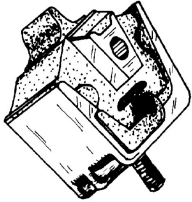

	F0517-I NO. 374093 - 374101 FOLE DO SEMI-EIXO INTERNO OPEL CORSA A 1.0 - 1.2 - 1.3 - 1.4 - 1.5D - 1.5TD - 1.6GSi (1982 A 1993)		F0518-I NO. 374094 FOLE DO SEMI-EIXO EXTERNO OPEL CORSA A 1.0 - 1.2 - 1.3 - 1.5D - 1.5TD - 1.6GSi (1982 A 1993)
	F0684-I NO. 902826 - 902827 FOLE DA CREMALHEIRA DA DIREÇÃO ESQUERDO E DIREITO OPEL CORSA A Caixa/parte traseira inclinada (S83) 1.2 (F08, W5L) 02.1986/04.1989 33KW 45CV 1196CC E 12 GV 12 NC 7526501 - OPEL CORSA A Hatchback (S83) 1.0 (F08, M08, F68, M68) 09.1982/03.1993 33KW 45CV 993CC 10 S 7526303 - OPEL CORSA A Hatchback (S83) 1.2 (F08, M08, F68, M68) 09.1982/08.1990 33KW 45CV 1196CC E 12 GV 12 NC 7526309 - OPEL CORSA A Hatchback (S83) 1.2 (F08, M08, F68, M68) 09.1982/08.1...		F4001 NO. 0738416 - 738416 - 90168233 FOLE ALAVANCA VELOCIDADES OPEL CORSA A Hatchback (S83): 1.0 (F08, M08, F68, M68) 09.1982/03.1993 33KW 45CV 993CC OPEL CORSA A Hatchback (S83): 1.2 (F08, M08, F68, M68) 09.1982/08.1990 33KW 45CV 1196CC - OPEL CORSA A Hatchback (S83): 1.2 i (F08, M08, F68, M68) 09.1989/03.1993 33KW 45CV 1195CC - OPEL CORSA A Hatchback (S83): 1.2 N (F08, M08, F68, M68) 01.1990/03.1993 38KW 52CV 1196CC - OPEL CORSA A Hatchback (S83): 1.2 S (F0...
	H740 NO. PALA ORIGINAL OPEL CORSA A (1991)		H755 NO. PALA ORIGINAL OPEL CORSA A (1982 A 1993)
	H771 NO. PALA GM OPEL CORSA A TR (1982 A 1993)		KF2330 NO. 374094 FOLE DO LADO DA RODA OPEL CORSA A 1.0 - 1.2 - 1.3 - 1.5D . 1.5TD - 1.6GSi (1982 A 1993)
	L3020 NO. 0856700 - 856700 - 9275758 CASQUILHO DE ESCAPE OPEL CORSA A Hatchback (S83): 1.3 (F08, M08, F68, M68) 09.1985/10.1989 44KW 60CV 1297CC - OPEL CORSA A Hatchback (S83): 1.3 S (F08, M08, F68, M68) 09.1982/10.1989 51KW 70CV 1297CC - OPEL CORSA A Hatchback (S83): 1.4 S (F08, M08, F68, M68) 01.1990/03.1993 53KW 72CV 1389CC - OPEL CORSA A TR (S83): 1.3 (F11, F19, M11, M19) 09.1985/10.1987 44KW 60CV 1297CC - OPEL CORSA A TR (S83): 1.3 S (F11, M11, F19...		M6003 NO. 854952 JUNTA DE ESCAPE OPEL CORSA A (1982 A 1993)
	M6004 NO. 854934 JUNTA DE ESCAPE OPEL CORSA A 1000 S - 1200 N (APÓS 1983)		M6005 NO. 854949 - 94139609 - 94344459 JUNTA DE ESCAPE OPEL CORSA A
	M6041 NO. 854842 - 90091769 JUNTA DE ESCAPE OPEL CORSA A (1983 A 1990)		M6054 NO. 854949 - 94344459 JUNTA DE ESCAPE OPEL CORSA A
	M6082 NO. 854943 - 854944 - 854955 - 97069287 JUNTA DE ESCAPE OPEL CORSA A (APÓS 1988)		P1012 NO. 0560808 - 560808 - 90105172 CAPA PEDAL EMBRAIAGEM/TRAVAO (GASTA 2 UNIDADES) OPEL CORSA A Hatchback (S83): 1.0 (F08, M08, F68, M68) 09.1982/03.1993 33KW 45CV 993CC - OPEL CORSA A Hatchback (S83): 1.2 (F08, M08, F68, M68) 09.1982/08.1990 33KW 45CV 1196CC - OPEL CORSA A Hatchback (S83): 1.2 i (F08, M08, F68, M68) 09.1989/03.1993 33KW 45CV 1195CC - OPEL CORSA A Hatchback (S83): 1.2 N (F08, M08, F68, M68) 01.1990/03.1993 38KW 52CV 1196CC - OPEL CORSA A Hatchback (S83): 1.2 S (...

	<p>P3668-C NO.</p> <p>CAPA DE PEDAL TRAVA/EMBRAIAGEM (GASTA 2 UNIDADES)</p> <p>OPEL CORSA A Hatchback (S83): 1.0 (F08, M08, F68, M68) 09.1982/03.1993 33KW 45CV 993CC - OPEL CORSA A Hatchback (S83): 1.2 (F08, M08, F68, M68) 09.1982/08.1990 33KW 45CV 1196CC - OPEL CORSA A Hatchback (S83): 1.2 i (F08, M08, F68, M68) 09.1989/03.1993 33KW 45CV 1195CC - OPEL CORSA A Hatchback (S83): 1.2 S (F08, M08, F68, M68) 09.1982/02.1990 40KW 55CV 1196CC - OPEL CORSA A Hatchback (S83): 1.3 (F0...</p> <p>53x43x10mm</p>		<p>R021101 NO. 1818521</p> <p>TUBO DE LIGAÇÃO DA BOMBA DE ÁGUA AO COLECTOR</p> <p>OPEL CORSA A Caixa/parte traseira inclinada (S83) 1.2 (F08, W5L) 02.1986/04.1989 33KW 45CV 1196CC E 12 GV12 NC 7526501 - OPEL CORSA A Hatchback (S83) 1.2 (F08, M08, F68, M68) 09.1982/08.1990 33KW 45CV 1196CC E 12 GV12 NC 7526309 - OPEL CORSA A Hatchback (S83) 1.2 (F08, M08, F68, M68) 09.1982/08.1990 44KW 60CV 1196CC 12S</p> <p>B165-d14/14mm 55-145mm</p>
	<p>R021525 NO. 102283 - 11530788160 - 11531258300 - 1818521 - 4057134 - 60502989 - 7595759</p> <p>TUBO RETORNO DE ÁGUA AO DEPÓSITO DE ARREFECIMENTO</p> <p>OPEL CORSA A Caixa/parte traseira inclinada (S83) 1.2 (F08, W5L) 02.1986/04.1989 33KW 45CV 1196CC E 12 GV12 NC 7526501 - OPEL CORSA A Hatchback (S83) 1.2 (F08, M08, F68, M68) 09.1982/08.1990 33KW 45CV 1196CC E 12 GV12 NC 7526309 - OPEL CORSA A Hatchback (S83) 1.2 (F08, M08, F68, M68) 09.1982/08.1990 44KW 60CV 1196CC 12S</p> <p>B200-d15/15mm 185-80mm</p>		<p>R080240 NO. 113x61x190mm 19-d16x23mm 1p-d19x25</p> <p>TUBO DE FERRO LIQUIDO REFRIGERAÇÃO</p> <p>OPEL CORSA A Caixa/parte traseira inclinada (S83) 1.3 (F08, W5L) 02.1986/04.1989 44KW 60CV 1297CC 13 NB 7526503 - OPEL CORSA A Caixa/parte traseira inclinada (S83) 1.3 (F08, W5L) 02.1986/04.1989 51KW 69CV 1297CC 13 SB 7526504 - OPEL CORSA A Hatchback (S83) 1.3 (F08, M08, F68, M68) 09.1985/10.1989 44KW 60CV 1297CF 13 NB 7526307 - OPEL CORSA A Hatchback (S83) 1.3 i (F08, M08, F68, M68) 09.1986/09.19...</p> <p>B310-31/32mm 113x61x190mm 19-d16x23mm 1p-d19x25mm 2f-</p>
	<p>R220539 NO. 1336745 - 90350621 - 90352373</p> <p>TUBO DE RADIADOR INFERIOR</p> <p>OPEL CORSA A Hatchback (S83) 1.0 (F08, M08, F68, M68) 09.1982/03.1993 33KW 45CV 993CC 10 S 7526303</p> <p>B320-d32/32mm 70-200-50-65mm</p>		<p>R220540 NO. 1336319 - 90128693</p> <p>TUBO DE RADIADOR SUPERIOR</p> <p>OPEL CORSA A Hatchback (S83) 1.0 (F08, M08, F68, M68) 09.1982/03.1993 33KW 45CV 993CC 10 S 7526303</p> <p>B340-d34/54mm 110-330-140-80mm</p>
	<p>R220541 NO. 1336384 - 90183672</p> <p>TUBO DE RADIADOR INFERIOR</p> <p>OPEL CORSA A Hatchback (S83) 1.0 (F08, M08, F68, M68) 09.1982/03.1993 33KW 45CV 993CC 10 S 7526303</p> <p>B310-d35/35mm 75-180-50-95mm</p>		<p>R220542 NO. 1336320 - 90128695</p> <p>TUBO DE RADIADOR SUPERIOR</p> <p>OPEL CORSA A Hatchback (S83) 1.2 (F08, M08, F68, M68) 09.1982/08.1990 33KW 45CV 1196CC E 12 GV12 NC 7526309 - OPEL CORSA A Hatchback (S83) 1.2 (F08, M08, F68, M68) 09.1982/08.1990 44KW 60CV 1196CC 12 S</p> <p>B225-d34/34mm 105-80-100mm</p>
	<p>R220543 NO. 1336323 - 1336410 - 1336486 - 90128699 - 90215368 - 90265772</p> <p>TUBO RADIADOR INFERIOR</p> <p>OPEL CORSA A Hatchback (S83): 1.2 (F08, M08, F68, M68) 09.1982/08.1990 33KW 45CV 1196CC - OPEL CORSA A Hatchback (S83): 1.2 i (F08, M08, F68, M68) 09.1989/03.1993 33KW 45CV 1195CC - OPEL CORSA A Hatchback (S83): 1.2 N (F08, M08, F68, M68) 01.1990/03.1993 38KW 52CV 1196CC - OPEL CORSA A Hatchback (S83): 1.2 S (F08, M08, F68, M68) 09.1982/02.1990 40KW 55CV 1196CC - OPEL CORSA A Hatchback (S83): 1.2...</p> <p>B460-d35/35mm 70-110-120-200-40-100mm</p>		<p>R220544 NO. 1336291 - 90144524</p> <p>TUBO DE LIGAÇÃO DA BOMBA AO RADIADOR</p> <p>OPEL CORSA A Caixa/parte traseira inclinada (S83) 1.2 (F08, W5L) 02.1986/04.1989 33KW 45CV 1196CC E 12 GV12 NC 7526501 - OPEL CORSA A Hatchback (S83) 1.2 (F08, M08, F68, M68) 09.1982/08.1990 33KW 45CV 1196CC E 12 GV12 NC 7526309 - OPEL CORSA A Hatchback (S83) 1.2 (F08, M08, F68, M68) 09.1982/08.1990 44KW 60CV 1196CC 12 S</p> <p>B175-d35/33mm 55-90-55mm</p>
	<p>R220546 NO. 1336431 - 90264448 - 90271497</p> <p>TUBO SUPERIOR DO RADIADOR</p> <p>OPEL CORSA A Hatchback (S83) 1.3 (F08, M08, F68, M68) 09.1985/10.1989 44KW 60CV 1297CC 13 NB 7526307 - OPEL CORSA A TR (S83) 1.3 (F11, F19, M11, M19) 09.1985/10.1987 44KW 60CV 1297CC 13 NBC 13 N 7526306</p> <p>B210-d37-d32mm 105-110-70mm</p>		<p>R222740 NO. 1337095 - 90354836</p> <p>TUBO LIGAÇÃO TERMOSTATO BOMBA DE ÁGUA</p> <p>OPEL CORSA A Hatchback (S83) 1.4 i (F08 - M08 - F68 - M68) (De 01-1990 Até 03-1993) 44kW 60CV 1389cc Hatchback OPEL CORSA A Hatchback (S83) 1.4 S (F08 - M08 - F68 - M68) (De 01-1990 Até 03-1993) 53kW 72CV 1389cc Hatchback OPEL CORSA A Hatchback (S83) 1.4 Si (F08 - M08 - F68 - M68) (De 09-1991 Até 03-1993) 60kW 82CV 1389cc Hatchback OPEL CORSA A Hatchback (S83) 1.6 GSI (F08 - M08 - M68 - F68) (D...</p> <p>B138-28/38mm 32-57-51mm</p>
	<p>R222811 NO. 650872</p> <p>TUBO DE LIGAÇÃO AO TERMOSTATO</p> <p>OPEL CORSA A Hatchback (S83) 1.5 TD (F08, M08, F68, M68) (De 1988.03 Até 1993.03) 49kW 67cv 1488cm3 Hatchback - OPEL CORSA A TR (S83) 1.5 TD (F11, M11, F19, M19) (De 1987.10 Até 1993.03) 49kW 67cv 1488cm3 três volumes -</p> <p>B57-15/15mm 50x22x50mm</p>		<p>R222812 NO. 650873</p> <p>TUBO LIGAÇÃO TERMOSTATO</p> <p>OPEL CORSA A Hatchback (S83) 1.5 TD (F08 - M08 - F68 - M68) (De 03-1988 Até 03-1993) 49kW 67CV 1488cc Hatchback OPEL CORSA A TR (S83) 1.5 TD (F11 - M11 - F19 - M19) (De 10-1987 Até 03-1993) 49kW 67CV 1488cc três volumes OPEL CORSA B (S93) 1.5 TD (F08 - F68 - M68) (De 03-1993 Até 09-2000) 49kW 67CV 1488cc Hatchback</p> <p>B97-14/14mm 60-41mm</p>
	<p>R222871 NO. 650872 - 650873</p> <p>TUBOS DE LIGAÇÃO AO TERMOSTATO</p> <p>OPEL CORSA A Hatchback (S83) 1.5 TD (F08, M08, F68, M68) 03.1988/03.1993 49KW 67CV 1488CC 15 DT (T4EC1) 7526312 - OPEL CORSA A TR (S83) 1.5 TD (F11, M11, F19, M19) 10.1987/03.1993 49KW 67CV 1488CC 15 DT (T4EC1)</p> <p>B113-14/14mm B56-16/16mm 45x59mm 40x1540mm</p>		<p>R8072 NO. 1818335 - 1818361 - 838526</p> <p>TUBO DE CHAUFAGEM DO COLECTOR AO CARBURADOR</p> <p>OPEL CORSA A 1.3 - 1.4</p> <p>B200-d16/16mm d10mm 65-145-100-60mm 340mm</p>

	<p>R8073 NO. 1818527 - 1818330</p> <p>TUBO DE CHAUFAGEM DO CARBURADOR</p> <p>OPEL CORSA A Hatchback (S83): 1.3 S (F08, M08, F68, M68) 09.1982/10.1989 51KW 70CV 1297CC - OPEL CORSA A Hatchback (S83): 1.4 S (F08, M08, F68, M68) 01.1990/03.1993 53KW 72CV 1389CC</p> <p>B135-d20/17mm d9mm 65-170-110-90mm 440mm</p>		<p>R8083 NO. 1336467 - 1336484 - 90296942 - 90297639 - 90298564 - 90299114</p> <p>TUBO INFERIOR DO RADIADOR</p> <p>OPEL CORSA A Caixa/parte traseira inclinada (S83) 1.5 D (F08, W5L) 06.1987/04.1989 37KW 50CV 1488CC 15 D (4EC1) 7526505 - OPEL CORSA A Hatchback (S83) 1.5 D (F08, M08, F68, M68) 09.1987/03.1993 37KW 50CV 1488CC 15 D (4EC1) 7526310 - OPEL CORSA A Hatchback (S83) 1.5 TD (F08, M08, F68, M68) 03.1988/03.1993 49KW 67CV 1488CC 15 DT (T4EC1) 7526312 - OPEL CORSA A TR (S83) 1.5 D (F11, M11, F19, M19) 10.1...</p> <p>B190-d33/33mm d20mm 70-85-75-65mm 55-75-85mm</p>
	<p>R8175 NO. 57x160x103x41mm ch-d18x50x65x51x58</p> <p>TUBO DO PERMUTADOR DO CALOR</p> <p>OPEL CORSA A Caixa/parte traseira inclinada (S83) 1.5 D (F08, W5L) 06.1987/04.1989 37KW 50CV 1488CC 15 D (4EC1) 7526505 - OPEL CORSA A Hatchback (S83) 1.5 D (F08, M08, F68, M68) 09.1987/03.1993 37KW 50CV 1488CC 15 D (4EC1) 7526310 - OPEL CORSA A Hatchback (S83) 1.5 TD (F08, M08, F68, M68) 03.1988/03.1993 49KW 67CV 1488CC 15 DT (T4EC1) 7526312 - OPEL CORSA A TR (S83) 1.5 D (F11, M11, F19, M19) 10.1...</p> <p>B350-22/23mm 57x160x103x41mm ch-d18x50x65x51x58</p>		<p>RF80241 NO. 215-150- 1f-d12mm 2f-d11mm ch-d13</p> <p>TUBO DE FERRO REFRIGERAÇÃO</p> <p>OPEL CORSA A Caixa/parte traseira inclinada (S83) 1.2 (F08, W5L) 02.1986/04.1989 33KW 45CV 1196CC E 12 GV 12 NC 7526501 - OPEL CORSA A Caixa/parte traseira inclinada (S83) 1.2 (F08, W5L) 02.1986/04.1989 40KW 54CV 1196CC 12 ST 7526502 - OPEL CORSA A Caixa/parte traseira inclinada (S83) 1.2 (F08, W5L) 02.1986/07.1990 44KW 60CV 1196CC 12 S - OPEL CORSA A Hatchback (S83) 1.2 (F08, M08, F68, M68) 09.19...</p> <p>B323-31/31mm 215-150- 1f-d12mm 2f-d11mm ch-d13-22mm ch-d13-</p>
	<p>RF80245 NO. 0606401 - 606401</p> <p>TUBO DE FERRO REFRIGERAÇÃO</p> <p>OPEL CORSA A Hatchback (S83) 1.5 D (F08 - M08 - F68 - M68) (De 09-1987 Até 03-1993) 37kW 50CV 1488cc Hatchback OPEL CORSA A Hatchback (S83) 1.5 TD (F08 - M08 - F68 - M68) (De 03-1988 Até 03-1993) 49kW 67CV 1488cc Hatchback OPEL CORSA A TR (S83) 1.5 D (F11 - M11 - F19 - M19) (De 10-1987 Até 11-1992) 37kW 50CV 1488cc três volumes OPEL CORSA A TR (S83) 1.5 TD (F11 - M11 - F19 - M19) (De 10-1987 At...</p> <p>d35x51mm c45mm 1f-d31</p>		<p>RT08540 NO. 532343 - 562343 - 90010524 - 90235567</p> <p>TUBO DE TRAVÃO FRENTE LH-RH</p> <p>OPEL CORSA A 2 Volumi - Coda spiovente (93_ - 94_ - 98_ - 99_) 1.0 (10 S) 45CV (09-1982 A 03-1993) - 1.2 (12 NC - E 12 GV) 45CV (09-1982 A 08-1990) - 1.2 (12 S) 60CV (09-1982 A 08-1990) - 1.2 i (C 12 NZ) 45CV (09-1989 A 03-1993) - 1.2 N (12 NV) 52CV (01-1990 A</p> <p>305mm FB3/1 - OR1</p>
	<p>RT08540 NO. 532343 - 562343 - 90010524 - 90235567</p> <p>TUBO DE TRAVÃO FRENTE LH-RH</p> <p>OPEL CORSA A Furgonato 1.0 (10 S) 45CV (02-1986 A 04-1989) - 1.2 (12 NC - E 12 GV) 45CV (02-1986 A 04-1989) - 1.2 (12 S) 60CV (02-1986 A 07-1990) - 1.2 (12 ST) 54CV (02-1986 A 04-1989) - 1.3 (13 NB) 60CV (02-1986 A 04-1989) - 1.3 (13 SB) 69CV (02-1986 A 04-</p> <p>305mm FB3/1 - OR1</p>		<p>RT08540 NO. 532343 - 562343 - 90010524 - 90235567</p> <p>TUBO DE TRAVÃO FRENTE LH-RH</p> <p>OPEL CORSA A TR (91_ - 92_ - 96_ - 97_) 1.0 (10 S) 45CV (09-1982 A 09-1992) - 1.2 i (C 12NZ) 45CV (09-1989 A 03-1993) - 1.2 N (12 NC - E 12 GV) 45CV (01-1985 A 10-1987) - 1.2 S (12 S) 58CV (09-1982 A 10-1987) - 1.2 S (12 ST) 55CV (09-1982 A 03-1993) - 1.3 (13 NB -</p> <p>305mm FB3/1 - OR1</p>
	<p>S1072 NO. 402643</p> <p>SILENT-BLOC DO ESTABILIZADOR</p> <p>OPEL CORSA A 1.0 - 1.2 - 1.3 - 1.4 - 1.5D - 1.5TD (1982 A 1993)</p> <p>d52x65mm d39mm 1f-d10mm</p>		<p>S1073 NO. 352327</p> <p>SILENT-BLOC DO BRAÇO DA SUSPENSÃO</p> <p>OPEL CORSA A Caixa/parte traseira inclinada (S83) 1.0 (F08, W5L) 02.1986/04.1989 33KW 45CV 993CC 10 S 7526500 - OPEL CORSA A Caixa/parte traseira inclinada (S83) 1.2 (F08, W5L) 02.1986/04.1989 33KW 45CV 1196CC E 12 GV 12 NC 7526501 - OPEL CORSA A Caixa/parte traseira inclinada (S83) 1.2 (F08, W5L) 02.1986/04.1989 40KW 54CV 1196CC 12 ST 7526502 - OPEL CORSA A Caixa/parte traseira inclinada (S83) 1.2...</p> <p>d43x52mm d34mm 1f-d10mm</p>
	<p>S1076 NO. 353560</p> <p>SILENT-BLOC DO ESTICADOR DA SUSPENSÃO</p> <p>OPEL CORSA A 1.0 - 1.2 - 1.3 - 1.4 - 1.5D - 1.5TD (1982 A 1993)</p> <p>d46x36mm d42mm d32mm 1f-d14mm</p>		<p>T0038F16 NO. 350109 - 90168602</p> <p>BATERIA DE ESTABILIZADOR FURO 16 mm</p> <p>OPEL CORSA A Hatchback (S83): 1.0 (F08, M08, F68, M68) 09.1982/03.1993 33KW 45CV 993CC - OPEL CORSA A Hatchback (S83): 1.2 (F08, M08, F68, M68) 09.1982/08.1990 33KW 45CV 1196CC - OPEL CORSA A Hatchback (S83): 1.2 i (F08, M08, F68, M68) 09.1989/03.1993 33KW 45CV 1195CC - OPEL CORSA A Hatchback (S83): 1.2 N (F08, M08, F68, M68) 01.1990/03.1993 38KW 52CV 1196CV - OPEL CORSA A Hatchback (S83): 1.2 S (...)</p> <p>40x37x34mm 1f-16mm</p>
	<p>T0038F19 NO.</p> <p>BATERIA DE ESTABILIZADOR FURO 19 mm</p> <p>OPEL CORSA A Hatchback (S83): 1.0 (F08, M08, F68, M68) 09.1982/03.1993 33KW 45CV 993CC - OPEL CORSA A Hatchback (S83): 1.2 (F08, M08, F68, M68) 09.1982/08.1990 33KW 45CV 1196CC - OPEL CORSA A Hatchback (S83): 1.2 i (F08, M08, F68, M68) 09.1989/03.1993 33KW 45CV 1195CC - OPEL CORSA A Hatchback (S83): 1.2 N (F08, M08, F68, M68) 01.1990/03.1993 38KW 52CV 1196CV - OPEL CORSA A Hatchback (S83): 1.2 S (...)</p> <p>40x37x34mm 1f-19mm</p>		<p>T0039 NO. 0350127 - 350109 - 350119 - 350127 - 90168602 - 90236108 - 90447946</p> <p>BATERIA DO CENTRO DA BARRA ESTABILIZADORA</p> <p>OPEL CORSA A Hatchback (S83): 1.0 (F08, M08, F68, M68) 09.1982/03.1993 33KW 45CV 993CC - OPEL CORSA A Hatchback (S83): 1.2 (F08, M08, F68, M68) 09.1982/08.1990 33KW 45CV 1196CC - OPEL CORSA A Hatchback (S83): 1.2 i (F08, M08, F68, M68) 09.1989/03.1993 33KW 45CV 1195CC - OPEL CORSA A Hatchback (S83): 1.2 N (F08, M08, F68, M68) 01.1990/03.1993 38KW 52CV 1196CC - OPEL CORSA A Hatchback (S83): 1.2 S (...)</p> <p>40x37x34mm 1f-d21mm</p>
	<p>UMB84011 NO. 031126</p> <p>TAMPÃO BLOCO MOTOR</p> <p>OPEL CORSA A Hatchback (S83) 1.2 i (F08 - M08 - F68 - M68) (De 09-1989 Até 03-1993) 33kW 45CV 1195cc Hatchback OPEL CORSA A Hatchback (S83) 1.2 N (F08 - M08 - F68 - M68) (De 01-1990 Até 03-1993) 38kW 52CV 1196cc Hatchback OPEL CORSA A Hatchback (S83) 1.2 S (F08 - M08 - F68 - M68) (De 09-1982 Até 02-1990) 40kW 55CV 1196cc Hatchback OPEL CORSA A Hatchback (S83) 1.3 (F08 - M08 - F68 - M68) (De 09-...</p> <p>d-18x8mm di-16mm</p>		<p>UMB84011L NO. 11062402 - 2060675</p> <p>TAMPÃO BLOCO DE MOTOR (RELAS)</p> <p>OPEL CORSA A Hatchback (S83) 1.2 i (F08 - M08 - F68 - M68) (De 09-1989 Até 03-1993) 33kW 45CV 1195cc Hatchback OPEL CORSA A Hatchback (S83) 1.2 N (F08 - M08 - F68 - M68) (De 01-1990 Até 03-1993) 38kW 52CV 1196cc Hatchback OPEL CORSA A Hatchback (S83) 1.2 S (F08 - M08 - F68 - M68) (De 09-1982 Até 02-1990) 40kW 55CV 1196cc Hatchback OPEL CORSA A Hatchback (S83) 1.3 (F08 - M08 - F68 - M68) (De 09-198...</p> <p>d-18x8mm di-16mm</p>

	W5045	NO. 5614417 - 614457 - 614637 - 97011870 - 97129070		Y3000	NO. 854917 - 854977 - 854980 - 90128081
	POLIE DA CAMBOTA (1+1+1 PISTAS)			PARAFUSO MOLA DE ESCAPE	
OPEL CORSA A Hatchback (S83): 1.5 D (F08, M08, F68, M68) 09.1987/03.1993 37KW 50CV 1488CC - OPEL CORSA A Hatchback (S83): 1.5 TD (F08, M08, F68, M68) 03.1988/03.1993 49KW 67CV 1488CC - OPEL CORSA A TR (S83): 1.5 D (F11, M11, F19, M19) 10.1987/11.1992 37KW 50CV 1488CC - OPEL CORSA A TR (S83): 1.5 TD (F11, M11, F19, M19) 10.1987/03.1993 49KW 67CV 1488CC - OPEL CORSA A Caixa/parte traseira inclinada ...			OPEL CORSA A (1983 A 1992)		
d139mm		d48mm	82x13mm		1p-d10-20mm
	Z80503	NO. 174846		Z80540	NO. 2240861 - 90022049
	Mola de friso			Mola de painel	
OPEL CORSA A			OPEL CORSA A		
56x39x5.6mm			d12x14.3mm		1p-d7-12.3mm
	Z9011	NO. 1261479 - 1449282600 - 4709339 - 4711509 - 854880			
	MOLA DE ESCAPE				
OPEL CORSA A					
d23x42mm					

OPEL CORSA B

	A0101	NO. 0684262 - 684242 - 684262 - 90223323		A1055	NO. 0684280 - 684280 - 90304644
	APOIO SUPORTE FRENTE ESQUERDO DO MOTOR			APOIO SUPORTE ESQUERDO DO MOTOR (CAIXA DE VELOCIDADES)	
OPEL CORSA B (S93) 1.2 i (F08, F68, M68) 03.1993/09.2000 33KW 45CV 1195CC C 12 NZX 12 SZ 0039923, 0039156, 0039157, 7526321 - OPEL CORSA B (S93) 1.2 i (F08, F68, M68) 03.1993/09.2000 33KW 45CV 1195CC 12 NZ - OPEL CORSA B (S93) 1.2 i 16V (F08, F68, M68) 03.1998/09.2000 48KW 65CV 1199CC X 12 XE 0039176, 0039175 - OPEL CORSA B (S93) - OPEL CORSA B (S93) 1.4 i (F08, F68, M68) 03.1993/09.2000 44KW 60CV ...			OPEL CORSA B 1500 DIESEL - CORSA B 1500 TURBO DIESEL		
89x83x70mm		1p-d10-20mm 1f-d10mm	89x85x70mm		1p-d10-20mm 1f-d10mm
	A1069	NO. 0682555 - 0682600 - 0682603 - 682555 - 682600 - 682603 - 90304647 - 90473837 - 90538063		A1204	NO. 684126 - 90250437
	APOIO SUPORTE TRASEIRO DO MOTOR (CAIXA)			APOIO DE MOTOR (LADO ESQUERDO)	
OPEL CORSA B (S93) 1.0 i 12V (F08, F68, M68) 11.1996/09.2000 40KW 54CV 973CC X 10 XE 0039167, 0039168 - OPEL CORSA B (S93) 1.2 i (F08, F68, M68) 03.1993/09.2000 33KW 45CV 1195CC C 12 NZX 12 SZ 0039923, 0039156, 0039157, 7526321 - OPEL CORSA B (S93) 1.2 i 16V (F08, F68, M68) 03.1998/09.2000 48KW 65CV 1199CC X 12 XE 0039176, 0039175 - OPEL CORSA B (S93) 1.4 i (F08, F68, M68) 03.1993/09.2000 44KW 60CV...			OPEL CORSA B COMBO Caixa/monovolume (71_) 1.7 D 07.1994/10.2001 44KW 60CV 1686CC X 17 D (4EE1) 17 D (4EE1) 0039932, 0039126, 0039154, 7526330, 7526509 - OPEL CORSA B (S93) 1.5 D (F08, F68, M68) 03.1993/09.2000 37KW 50CV 1488CC 15 D (4EC1) 15 D 0039925, 7526324 - OPEL CORSA B (S93) 1.5 TD (F08, F68, M68) 03.1993/09.2000 49KW 67CV 1488CC X 15 DT (T4EC1) 15 DT (T4EC1) 15 TD X 15 TD X 15 DT 0039926...		
145x90x66mm		1f-d10mm	153x90x60mm		2r-d10mm
	A1205	NO. 0684666 - 684666 - 90445300		A1208	NO. 0684160 - 684160 - 90269291 - 90445304
	APOIO DE MOTOR FRENTE DIREITO			APOIO DE MOTOR (LADO DIREITO)	
OPEL CORSA B (S93) 1.0 i 12V (F08, F68, M68) 11.1996/09.2000 40KW 54CV 973CC X 10 XE 0039167, 0039168 - OPEL CORSA B (S93) 1.2 i (F08, F68, M68) 03.1993/09.2000 33KW 45CV 1195CC C 12 NZX 12 SZ 0039923, 0039156, 0039157, 7526321 - OPEL CORSA B (S93) 1.2 i (F08, F68, M68) 03.1993/09.2000 33KW 45CV 1195CC 12 NZ - OPEL CORSA B (S93) 1.2 i 16V (F08, F68, M68) 03.1998/09.2000 48KW 65CV 1199CC X 12 XE 0039176, 0039175 - OPEL CORSA B (S93) 1.4 i (F08, F68, M68) 03.1993/09.2000 44KW 60CV...			OPEL CORSA B (S93) 1.5 D (F08, F68, M68) 03.1993/09.2000 37KW 50CV 1488CC 15 D 0039925 7526324 - OPEL CORSA B (S93) 1.5 TD (F08, F68, M68) 03.1993/09.2000 49KW 67CV 1488CC 15 TD X 15 TD X 15 DT 0039926 0039159 0039158 7526325 - OPEL CORSA B (S93) 1.7 D (F08, F68, M68) 02.1996/09.2000 44KW 60CV 1686CC X 17 D (4EE1) 17 D (4EE1) 0039164 0039163 0039956 - OPEL CORSA B Caixa/parte traseira inclinada...		
160x100x100mm		1p-d10-45mm 1r-d9mm	165x92x80mm		2f-d10mm
	A1209	NO. 0684661 - 0684665 - 0684671 - 684661 - 684665 - 684671 - 90444514 - 90444515 - 90444522 - 90444525...		A1211	NO. 0684671 - 684671 - 684687 - 90445523 - 90445524 - 90495170
	APOIO FRENTE ESQUERDO DE MOTOR			APOIO FRENTE ESQUERDO DE MOTOR	
OPEL CORSA B (S93) 1.2 i (F08, F68, M68) 03.1993/09.2000 33KW 45KW 1195CC C 12 NZX 12 SZ 0039923 0039156 0039157 7526321 - OPEL CORSA B (S93) 1.2 i (F08, F68, M68) 03.1993/09.2000 33KW 45CV 1195CC 12 NZ - OPEL CORSA B (S93) 1.4 (F08, F68, M68) 04.1993/08.1994 54KW 73CV 1389CC C 14 SE - OPEL CORSA B (S93) 1.4 i (F08, F68, M68) 03.1993/09.2000 40KW 54CV 1389CC X 14 SZC 14 NZ 0039169 0039170 - OPEL C...			OPEL CORSA B (S93) 1.2 i (F08, F68, M68) 03.1993/09.2000 33KW 45CV 1195CC C 12 NZX 12 SZ 0039923 0039156 0039157 7526321 - OPEL CORSA B (S93) 1.2 i 16V (F08, F68, M68) 03.1998/09.2000 48KW 65CV 1199CC X 12 XE 0039176 0039175 - OPEL CORSA B (S93) 1.4 i (F08, F68, M68) 03.1993/09.2000 44KW 60CV 1686CC C 14 NZX 14 SZ 0039924 0039165 0039166 7526322 - OPEL CORSA B (S93) 1.4 i 16V (F08, F68, M68) 09.1...		
200x90x60mm		2r-d10mm	200x90x60mm		2r-d10mm

	<p>A1212 NO. 684659 - 684669</p> <p>APOIO FRENTE ESQUERDO DE MOTOR</p> <p>OPEL CORSA B 1.2 - 1.4 - 1.6i 16v (APÓS 1993)</p> <p>157x90x60mm 2r-d10mm</p>		<p>A1214 NO. 682552</p> <p>APOIO DE MOTOR (PARTE DE TRÁS)</p> <p>OPEL CORSA B 1.2i - 1.4i - 1.4i 16v - 1.6i 16v (03-1993 A 09-2000)</p> <p>145x85x66mm 1f-d10mm 1f-d8mm</p>
	<p>A1215 NO. 684294</p> <p>APOIO DE MOTOR FRENTE DIREITO</p> <p>OPEL CORSA B 1.0i 12v - 1.2 - 1.4 - 1.6i 16v - (VEÍCULOS COM DIRECÇÃO ASSISTIDA) (03-1993 A 09-2000)</p> <p>160x95x60mm 2r-d10mm</p>		<p>A1218 NO. 0344519 - 344502 - 344519 - 90445207 - 90445208</p> <p>APOIO DO AMORTECEDOR DE TRÁS</p> <p>OPEL CORSA B (S93): 1.0 i 12V (F08, F68, M68) 11.1996/09.2000 40KW 54CV 973CC - OPEL CORSA B (S93): 1.2 i (F08, F68, M68) 03.1993/09.2000 33KW 45CV 1195CC - OPEL CORSA B (S93): 1.2 i (F08, F68, M68) 03.1993/09.2000 33KW 45CV 1195CC - OPEL CORSA B (S93): 1.2 i 16V (F08, F68, M68) 03.1998/09.2000 48KW 65CV 1199CC - OPEL CORSA B (S93): 1.4 i (F08, F68, M68) 03.1993/09.2000 40KW 54CV 1389CC - OPEL COR...</p> <p>135x110x40mm 1f-d34mm</p>
	<p>A1314 NO. 344519 - 90445207</p> <p>APOIO DE AMORTECEDOR DA FRENTE</p> <p>OPEL CORSA B (S93): 1.0 i 12V (F08, F68, M68) 11.1996/09.2000 40KW 54CV 973CC - OPEL CORSA B (S93): 1.2 i (F08, F68, M68) 03.1993/09.2000 33KW 45CV 1195CC - OPEL CORSA B (S93): 1.2 i (F08, F68, M68) 03.1993/09.2000 33KW 45CV 1195CC - OPEL CORSA B (S93): 1.2 i 16V (F08, F68, M68) 03.1998/09.2000 48KW 65CV 1199CC - OPEL CORSA B (S93): 1.4 i (F08, F68, M68) 03.1993/09.2000 40KW 54CV 1389CC - OPEL COR...</p> <p>136x109x38mm 2p-d8-17mm 1f-d37mm</p>		<p>BB24 NO. 350376</p> <p>ABRÇAÇEIRA BARRA ESTABILIZADORA (GASTA 2 UNIDADES)</p> <p>OPEL CORSA B (S93): 1.0 i 12V (F08, F68, M68) 11.1996/09.2000 40KW 54CV 973CC - OPEL CORSA B (S93): 1.0 i 12V (F08, F68, M68) 11.1996/09.2000 40KW 54CV 973CC - OPEL CORSA B (S93): 1.2 i (F08, F68, M68) 03.1993/09.2000 33KW 45CV 1195CC - OPEL CORSA B (S93): 1.2 i (F08, F68, M68) 03.1993/09.2000 33KW 45CV 1195CC - OPEL CORSA B (S93): 1.2 i 16V (F08, F68, M68) 03.1998/09.2000 48KW 65CV 1199CC - OPEL CORSA B (S93): 1.2 i 16V (F08, F68, M68) 03.1998/09.2000 48KW 65CV 1199CC - OPEL ...</p> <p>73x29x30mm 2p-d8-23mm</p>
	<p>C0233 NO. 1160724 - 90054143</p> <p>BOTÃO AFINAÇÃO CAPÔT</p> <p>OPEL CORSA B (73_78_79_) 1.0 i 12V (11.96 A 09.00) 54cv 973cc Hatchback - OPEL CORSA B (73_78_79_) 1.2 i (03.93 A 09.00) 45cv 1195cc Hatchback - OPEL CORSA B (73_78_79_) 1.2 i (03.93 A 09.00) 45cv 1195cc Hatchback - OPEL CORSA B (73_78_79_) 1.2 i (03.93 A 09.00) 45cv 1195cc Hatchback - OPEL CORSA B (73_78_79_) 1.2 i 16V (03.98 A 09.00) 65cv 1199cc Hatchback - OPEL CORSA B (73_78_79_) 1.4 i (03.93 A 09.00) 60cv 1389cc Hatchback - OPEL CORSA B (73_...</p> <p>d19x31mm</p>		<p>E0013 NO. 852715 - 852716 - 852720</p> <p>ESTICADOR DE ESCAPE</p> <p>OPEL CORSA B 1.0i 12v - 1.2i - 1.4i - 1.5D - 1.6i - 1.7D (1993 A 2000)</p> <p>66x56x13mm</p>
	<p>E0016 NO. 0852719 - 852719 - 90128194</p> <p>ESTICADOR SUPORTE CENTRAL E TRÁS DO ESCAPE</p> <p>OPEL CORSA B (S93): 1.7 D (F08, F68, M68) 02.1996/09.2000 44KW 60CV 1686CC - OPEL CORSA B Caixa/parte traseira inclinada (S93): 1.7 D (F08, W5L) 08.1999/09.2000 44KW 60CV 1686CC</p> <p>105x35x33mm</p>		<p>E1003 NO. 0856519 - 856519 - 9281771</p> <p>ESTICADOR SUPORTE TRÁS DO ESCAPE</p> <p>OPEL CORSA B (S93): 1.2 i (F08, F68, M68) 03.1993/09.2000 33KW 45CV 1195CC - OPEL CORSA B (S93): 1.2 i (F08, F68, M68) 03.1993/09.2000 33KW 45CV 1195CC - OPEL CORSA B (S93): 1.2 i 16V (F08, F68, M68) 03.1998/09.2000 48KW 65CV 1199CC - OPEL CORSA B (S93): 1.4 i (F08, F68, M68) 03.1993/09.2000 44KW 60CV 1389CC - OPEL CORSA B (S93): 1.4 i 16V (F08, F68, M68) 03.1998/09.2000 48KW 65CV 1389CC - OPEL CO...</p> <p>50x44x42mm 2f-d5mm 2f-18x9mm</p>
	<p>E1031 NO. 0852516 - 852516 - 90467447</p> <p>ESTICADOR DE ESCAPE</p> <p>OPEL CORSA B 1.0i 12v - 1.2i - 1.2i 16v - 1.4i - 1.5 - 1.5TD - 1.6i 16v - 1.7D (1993 A 2000)</p> <p>68x44x42mm</p>		<p>E1071 NO. 852723 - 90352773</p> <p>ESTICADOR DE ESCAPE</p> <p>OPEL CORSA B COMBO (APÓS 1993)</p> <p>72x61x20mm</p>
	<p>F0517-I NO. 374093 - 374101</p> <p>FOLE DO SEMI-EIXO INTERNO</p> <p>OPEL CORSA B 1.2i - 1.4i - 1.5TD - 1.7D (1992 A 2000)</p> <p>d90x103mm 1f-d74mm 1f-d22mm</p>		<p>F0518-I NO. 374094</p> <p>FOLE DO SEMI-EIXO EXTERNO</p> <p>OPEL CORSA B 1.2i - 1.4i - 1.5D - 1.6i - 1.7D (1993 A 2000)</p> <p>d86x108mm 1f-d22mm 1f-d77mm</p>
	<p>F0520-I NO. 374018 - 90095162</p> <p>FOLE DO SEMI-EIXO INTERNO (F1026)</p> <p>OPEL CORSA (B) 1.2i - 1.4i - 1.4i 16v - 1.4iSi - 1.4TD - 1.5D - 1.5TD - 1.6 - 1.6 16v - 1.6 Gsi 16v (1993 A 2000)</p> <p>d72x94mm 1f-d54mm 1f-d19mm</p>		<p>F0684-I NO. 902826 - 902827</p> <p>FOLE DA CREMALHEIRA DA DIRECÇÃO ESQUERDO E DIREITO</p> <p>OPEL CORSA B (S93) 1.0 i 12V (F08, F68, M68) 11.1996/09.2000 40KW 54CV 973CC X 10 XE 0039167 0039168 - OPEL CORSA B (S93) 1.2 i (F08, F68, M68) 03.1993/09.2000 33KW 45CV 1195CC C 12 NZ X 12 SZ 0039923 0039156 0039157 7526321 - OPEL CORSA B (S93) 1.2 i (F08, F68, M68) 03.1993/09.2000 33KW 45CV 1195CC 12 NZ - OPEL CORSA B (S93) 1.2 i 16V (F08, F68, M68) 03.1998/09.2000 48KW 65CV 1199CC X 12 XE 00391...</p> <p>d68x172mm 1f-d48mm 1f-d12mm</p>

	<p>F1617-I NO. 1609087 - 26032286</p> <p>FOLE DE DIREÇÃO ASSISTIDA DIREITO E ESQUERDO</p> <p>OPEL CORSA B (1993 A 2000)</p> <p>d62x184mm 1f-d11mm 1f-d48mm</p>		<p>F1829H-I NO. 1603005 - 20424726 - 26067603 - 26070498</p> <p>FOLE DA TRANSMISSÃO JUNTO À RODA</p> <p>OPEL CORSA B 1.0i 12V - 1.2i 16v (1993 A 2000)</p> <p>d90x130mm 1f-d72mm 1f-d23mm</p>
	<p>F1845-I NO. 1603004 - 1603230 - 26073421 - 26094870</p> <p>FOLE DA TRANSMISSÃO LADO DA CAIXA</p> <p>OPEL CORSA B 1.0i 12V AUTOM. X10XE54 (02-1997 A 11-2000)</p> <p>d81x95mm 1f-d72mm 1f-d22mm</p>		<p>F4094 NO. 0738978 - 5738414 - 738978 - 90373314 - 90437426</p> <p>FOLE ALAVANCA VELOCIDADES</p> <p>OPEL CORSA B (S93): 1.0 i 12V (F08, F68, M68) 11.1996/09.2000 40KW 54CV 973CC - OPEL CORSA B (S93): 1.2 i (F08, F68, M68) 03.1993/09.2000 33KW 45CV 1195CC - OPEL CORSA B (S93): 1.2 i (F08, F68, M68) 03.1993/09.2000 33KW 45CV 1195CC - OPEL CORSA B (S93): 1.2 i 16V (F08, F68, M68) 03.1998/09.2000 48KW 65CV 1199CC - OPEL CORSA B (S93): 1.4 i (F08, F68, M68) 03.1993/09.2000 44KW 60CV 1389CC - OPEL ...</p> <p>170x120x220mm 1f-160x105mm 1f-d50mm</p>
	<p>H750 NO.</p> <p>PALA ORIGINAL</p> <p>OPEL CORSA B (1993 A 2000)</p> <p>350x205mm</p>		<p>KF2330 NO. 374094</p> <p>FOLE DO LADO DA RODA</p> <p>OPEL CORSA B 1.2i - 1.4i - 1.5D - 1.6i - 1.7D (1993 A 2000)</p> <p>d90x110mm 1f-d23mm 1f-d78mm</p>
	<p>KF2335 NO. 1603188 - 90446236</p> <p>KIT DE FOLE JUNTO À RODA</p> <p>OPEL CORSA B 1.2i - 1.4i - 1.5D - 1.5TD - 1.6i - 1.7D (APÓS 10-1993)</p> <p>d98x112mm 1f-d76mm 1f-d22mm</p>		<p>KF2371-T NO. 1603005 - 20424726 - 26067603 - 26070498</p> <p>KIT DE FOLE DO CARDAN JUNTO À RODA</p> <p>OPEL CORSA B 1.0i 12V - 1.2i 16v (1993 A 2000)</p> <p>d88x126mm 1f-d72mm 1f-d23mm</p>
	<p>KF2527-T NO. 1603189</p> <p>KIT DE FOLE DO CARDAN JUNTO À RODA</p> <p>OPEL CORSA B 1.2i - 1.4i - 1.4i 16v - 1.5 TD - 1.7D - 1.7 Di 16v - 1.7 DTi 16v (1993 A 2000)</p> <p>d95x130mm 1f-d78mm 1f-d23mm</p>		<p>KL80449 NO. 198283 - 607813 - 90412865</p> <p>KIT CASQUILHOS COBERTURA TAMPA MOTOR</p> <p>OPEL CORSA B (S93): 1.4 i 16V (F08, F68, M68) 09.1994/09.2000 66KW 90CV 1389CC - OPEL CORSA B (S93): 1.6 i 16V (F08, F68, M68) 09.1994/09.2000 78KW 106CV 1598CC - OPEL CORSA B (S93): 1.6 GSI 16V (F08, F68, M68) 03.1993/09.2000 80KW 109CV 1598CC</p> <p>d16x10mm 1f-d6mm</p>
	<p>L3020 NO. 0856700 - 856700 - 9275758</p> <p>CASQUILHO DE ESCAPE</p> <p>OPEL CORSA B</p> <p>d29x12mm d26/di19x8mm 1f-d9mm</p>		<p>L3188 NO. 430051</p> <p>CASQUILHO DAS MOLAS LÂMINA PARTE DE TRÁS</p> <p>OPEL CORSA B (S93) 1.2 i 16V (F08, F68, M68) (De 03.1998 Até 09.2000) 48kW 65cv 1199cm3 Hatchback -</p> <p>d28x45mm d21mm 1f-d11mm</p>
	<p>M6003 NO. 854952</p> <p>JUNTA DE ESCAPE</p> <p>OPEL CORSA B (1993 A 2000)</p> <p>d59x13.5mm 1f-d45mm</p>		<p>M6054 NO. 854949 - 94344459</p> <p>JUNTA DE ESCAPE</p> <p>OPEL CORSA B (1993 A 2000)</p> <p>d54x5mm 1f-d44mm</p>
	<p>M6075 NO. 854825 - 97180750</p> <p>JUNTA DE ESCAPE</p> <p>OPEL CORSA B TURBO DIESEL</p> <p>d64x5mm 1f-d51mm</p>		<p>M6082 NO. 854943 - 854944 - 854955 - 97069287</p> <p>JUNTA DE ESCAPE</p> <p>OPEL CORSA B 1.5TD (APÓS 03-1993)</p> <p>d64x5mm 1f-d53mm</p>

	<p>P1012 NO. 0560808 - 560808 - 90105172</p> <p>CAPA PEDAL EMBRAIAGEM/TRAVAO (GASTA 2 UNIDADES)</p> <p>OPEL CORSA B (S93): 1.0 i 12V (F08, F68, M68) 11.1996/09.2000 40KW 54CV 973CC - OPEL CORSA B (S93): 1.2 i (F08, F68, M68) 03.1993/09.2000 33KW 45CV 1195CC - OPEL CORSA B (S93): 1.2 i (F08, F68, M68) 03.1993/09.2000 33KW 45CV 1195CC - OPEL CORSA B (S93): 1.2 i (F08, F68, M68) 03.1993/09.2000 33KW 45CV 1195CC - OPEL CORSA B (S93): 1.2 i (F08, F68, M68) 03.1998/09.2000 48KW 65CV 1199CC - OPEL CORSA B (S93): 1.4 i (F08, F68, M68) 03.1993/09.2000 44KW 60CV 1389CC - OPEL COR...</p> <p>60x55x9mm</p>		<p>Q2009 NO.</p> <p>UNIÃO DE ESCAPE 47/52,5x90mm</p> <p>OPEL - CORSA B (73_ - 78_ - 79_) - 1.2 i 16V (03.98 - 09.00) 65cv 1199cc Hatchback</p> <p>90x58x78mm 1f-d47mm</p>
	<p>R080240 NO. 113x61x190mm 19-d16x23mm 1p-d19x25</p> <p>TUBO DE FERRO LIQUIDO REFRIGERAÇÃO</p> <p>OPEL CORSA B (S93) 1.5 D (F08, F68, M68) 03.1993/09.2000 37KW 50CV 1488CC 15 D 0039925 7526324 - OPEL CORSA B (S93) 1.5 TD (F08, F68, M68) 03.1993/09.2000 49KW 67CV 1488CC 15 TD X 15 TD X 15 DT 15 DT 0039926 0039159 0039158 7526325 - OPEL CORSA B (S93) 1.7 D (F08, F68, M68) 02.1996/09.2000 44KW 60CV 1686CC X 17 D (4EE1) 17 D (4EE1) 0039164 0039163 0039956</p> <p>B310-31/32mm 113x61x190mm 19-d16x23mm 1p-d19x25</p>		<p>R080252 NO. 80-300mm ch-d20-30mm ch-d20-30mm c</p> <p>TUBO RIGIDO REFRIGERAÇÃO</p> <p>OPEL CORSA B (S93) 1.4 i 16V (F08, F68, M68) (De 1994.09 Até 2000.09) 66KW 90cv 1389cm3 Hatchback - OPEL CORSA B (S93) 1.6 i 16V (F08, F68, M68) (De 1994.09 Até 2000.09) 78KW 106cv 1598cm3 Hatchback - OPEL CORSA B (S93) 1.6 GSI 16V (F08, F68, M68) (De 1993.03 Até 2000.09) 80KW 109cv 1598cm3 Hatchback -</p> <p>B315-32/35mm 80-300mm ch-d20-30mm ch-d20-30mm c</p>
	<p>R080254 NO. 1336086</p> <p>TUBO RIGIDO REFRIGERAÇÃO</p> <p>OPEL CORSA B (S93) 1.2 i (F08 - F68 - M68) (De 03-1993 Até 09-2000) 33KW 45CV 1195cc Hatchback OPEL CORSA B (S93) 1.4 i (F08 - F68 - M68) (De 03-1993 Até 09-2000) 44KW 60CV 1389cc Hatchback</p> <p>B340-32/34mm 117-265mm 1f-d6mm 1f-d13mm 2p-d</p>		<p>R221450 NO. 1337186 - 90444463</p> <p>TUBO SUPERIOR RADIADOR</p> <p>OPEL CORSA B (S93) 1.2 i (F08, F68, M68) 03.1993/09.2000 33KW 45CV 1195CC C 12 NZX 12 SZ 0039923 0039156 0039157 7526321 - OPEL CORSA B (S93) 1.2 i (F08, F68, M68) 03.1993/09.2000 33KW 45CV 1195CC 12 NZ - OPEL CORSA B (S93) 1.2 i 16V (F08, F68, M68) 03.1998/09.2000 48KW 65CV 1199CC X 12 XE 0039176 0039175 - OPEL CORSA B (S93) 1.4 i (F08, F68, M68) 03.1993/09.2000 44KW 60CV 1389CC C 14 NZX 14 SZ ...</p> <p>B185-d40/34mm 120-100-80mm</p>
	<p>R221451 NO. 1337193 - 90410065 - 90444477</p> <p>TUBO DE RADIADOR INFERIOR</p> <p>OPEL CORSA B (S93) 1.2 i (F08, F68, M68) 03.1993/09.2000 33KW 45CV 1195CC C 12 NZX 12 SZ 0039923 0039156 0039157 7526321 - OPEL CORSA B (S93) 1.2 i (F08, F68, M68) 03.1993/09.2000 33KW 45CV 1195CC 12 NZ - OPEL CORSA B (S93) 1.2 i 16V (F08, F68, M68) 03.1998/09.2000 48KW 65CV 1199CC X 12 XE 0039176 0039175 - OPEL CORSA B (S93) 1.4 i (F08, F68, M68) 03.1993/09.2000 44KW 60CV 1389CC C 14 NZX 14 SZ ...</p> <p>B360-d37/33mm 125-205-65mm</p>		<p>R221452 NO. 1818243 - 90448308</p> <p>TUBO DO PERMUTADOR DO CALOR</p> <p>OPEL CORSA B (S93) 1.2 i (F08, F68, M68) (De 1993.03 Até 2000.09) 33KW 45cv 1195cm3 Hatchback - OPEL CORSA B (S93) 1.2 i (F08, F68, M68) (De 1993.03 Até 2000.09) 33KW 45cv 1195cm3 Hatchback - OPEL CORSA B (S93) 1.2 i 16V (F08, F68, M68) (De 1998.03 Até 2000.09) 48KW 65cv 1199cm3 Hatchback - OPEL CORSA B (S93) 1.4 i (F08, F68, M68) (De 1993.03 Até 2000.09) 44KW 60cv 1389cm3 H...</p> <p>B180-14/19mm 57x89x62mm</p>
	<p>R222727 NO. 6818302</p> <p>TUBO DO PERMUTADOR DO CALOR</p> <p>OPEL CORSA B (S93) 1.5 D (F08, F68, M68) (De 03.1993 Até 09.2000) 37KW 50cv 1488cm3 Hatchback - OPEL CORSA B (S93) 1.5 TD (F08, F68, M68) (De 03.1993 Até 09.2000) 49KW 67cv 1488cm3 Hatchback - OPEL CORSA B (S93) 1.7 D (F08, F68, M68) (De 02.1996 Até 09.2000) 44KW 60cv 1686cm3 Hatchback -</p> <p>B320-14/17mm 43x160x104x32mm ch-d9x32x80x53x33n</p>		<p>R222738 NO. 1336110 - 1336160 - 90573834 - 9128484</p> <p>TUBO INFERIOR RADIADOR</p> <p>OPEL CORSA B (S93) 1.0 i 12V (F08, F68, M68) (11.96 A 09.00) 54cv 973cc Hatchback</p> <p>B310-32/38mm 60-20-45-146-48-59mm ch-d15-59-82mm</p>
	<p>R222739 NO. 1337188</p> <p>TUBO SUPERIOR DO RADIADOR</p> <p>OPEL CORSA B (S93) 1.2 i (F08 - F68 - M68) (De 03-1993 Até 09-2000) 33KW 45CV 1195cc Hatchback OPEL CORSA B (S93) 1.2 i (F08 - F68 - M68) (De 03-1993 Até 09-2000) 33KW 45CV 1195cc Hatchback OPEL CORSA B (S93) 1.2 i 16V (F08 - F68 - M68) (De 03-1998 Até 09-2000) 48KW 65CV 1199cc Hatchback OPEL CORSA B (S93) 1.4 i (F08 - F68 - M68) (De 03-1993 Até 09-2000) 44KW 60CV 1389cc Hatchback OPEL CORSA B (S9...</p> <p>B195-32/39mm 55-42-70mm</p>		<p>R222740 NO. 1337095 - 90354836</p> <p>TUBO LIGAÇÃO TERMOSTATO BOMBA DE ÁGUA</p> <p>OPEL CORSA B (S93) 1.2 i (F08 - F68 - M68) (De 03-1993 Até 09-2000) 33KW 45CV 1195cc Hatchback OPEL CORSA B (S93) 1.2 i (F08 - F68 - M68) (De 03-1993 Até 09-2000) 33KW 45CV 1195cc Hatchback OPEL CORSA B (S93) 1.2 i 16V (F08 - F68 - M68) (De 03-1998 Até 09-2000) 48KW 65CV 1199cc Hatchback OPEL CORSA B (S93) 1.4 i (F08 - F68 - M68) (De 03-1993 Até 09-2000) 44KW 60CV 1389cc Hatchback OPEL CORSA B (S9...</p> <p>B138-28/38mm 32-57-51mm</p>
	<p>R222741 NO. 1818256</p> <p>TUBO DE LIGAÇÃO AO DEPÓSITO EXPANSÃO</p> <p>OPEL CORSA B (S93) 1.2 i (F08, F68, M68) (De 1993.03 Até 2000.09) 33KW 45cv 1195cm3 Hatchback - OPEL CORSA B (S93) 1.2 i (F08, F68, M68) (De 1998.03 Até 2000.09) 48KW 65cv 1199cm3 Hatchback - OPEL CORSA B (S93) 1.4 i (F08, F68, M68) (De 1993.03 Até 2000.09) 44KW 60cv 1389cm3 Hatchback - OPEL CORSA B (S93) 1.4 i 16V (F08, F68, M68) (De 1994.09 Até 2000.09) 66KW 90cv 1389cm3 Ha...</p> <p>B250-29/29mm 86x42x104mm</p>		<p>R222786 NO. 1337453 - 1337455</p> <p>TUBO DE LIGAÇÃO AO DEPÓSITO REFRIGERAÇÃO</p> <p>OPEL CORSA B (S93) VITA 1.0 i 12V (F08, F68, M68) 11.1996/09.2000 40KW 54CV 973CC X 10 XE 0039167 0039168 - OPEL CORSA B (S93) VITA 1.2 i (F08, F68, M68) 03.1993/09.2000 33KW 45CV 1195CC C 12 NZ X 12 SZ 0039923 0039156 0039157 7526321 - OPEL CORSA B (S93) VITA 1.2 i (F08, F68, M68) 03.1993/09.2000 33KW 45CV 1195CC 12 NZ - OPEL CORSA B (S93) VITA 1.2 i 16V (F08, F68, M68) 03.1998/09.2000 48...</p> <p>B185-14/14mm 147x27x57mm</p>
	<p>R222811 NO. 650872</p> <p>TUBO DE LIGAÇÃO AO TERMOSTATO</p> <p>OPEL CORSA B (S93) 1.5 TD (F08, F68, M68) (De 1993.03 Até 2000.09) 49KW 67cv 1488cm3 Hatchback - OPEL CORSA B (S93) 1.7 D (F08, F68, M68) (De 1996.02 Até 2000.09) 44KW 60cv 1686cm3 Hatchback - OPEL CORSA B Caixa (S93) 1.7 D (F08, W5L) (De 1999.08 Até 2000.09) 44KW 60cv 1686cm3 Caixa -</p> <p>B57-15/15mm 50x22x50mm</p>		<p>R222812 NO. 650873</p> <p>TUBO LIGAÇÃO TERMOSTATO</p> <p>OPEL CORSA B (S93) 1.7 D (F08 - F68 - M68) (De 02-1996 Até 09-2000) 44KW 60CV 1686cc Hatchback OPEL CORSA B Caixa (S93) 1.7 D (F08 - W5L) (De 08-1999 Até 09-2000) 44KW 60CV 1686cc Caixa</p> <p>B97-14/14mm 60-41mm</p>

	<p>R222871 NO. 650872 - 650873</p> <p>TUBOS DE LIGAÇÃO AO TERMOSTATO</p> <p>OPEL CORSA B (S93) VITA 1.5 TD (F08, F68, M68) 03.1993/09.2000 49KW 67CV 1488CC X 15 DT 15 DT 0039926 0039159 0039158 7526325 - OPEL CORSA B (S93) VITA 1.7 D (F08, F68, M68) 02.1996/09.2000 44KW 60CV 1686CC X 17 D (4EE1) 17 D (4EE1) 0039164 0039163 0039956 - OPEL CORSA B Caixa/parte traseira inclinada (S93) 1.7 D (F08, W5L) 08.1999/09.2000 44KW 60CV 1686CC X 17 D (4EE1) 17 D (4EE1) 0039130</p> <p>B113-14/14mm B56-16/16mm 59mm 40x1540mm</p>		<p>R8081 NO. 1818256</p> <p>TUBO DO ARREFECIMENTO</p> <p>OPEL CORSA B (S93) 1.2 i (F08, F68, M68) 03.1993/09.2000 33KW 45CV 1195CC C 12 NZX 12 SZ 0039923 0039156 0039157 7526321 - OPEL CORSA B (S93) 1.2 i (F08, F68, M68) 03.1993/09.2000 33KW 45CV 1195CC 12 NZ - OPEL CORSA B (S93) 1.2 i 16V (F08, F68, M68) 03.1998/09.2000 48KW 65CV 1199CC X 12 XE 0039176 0039175 - OPEL CORSA B (S93) 1.4 i (F08, F68, M68) 03.1993/09.2000 44KW 60CV 1389CC C 14 NZX 14 SZ ...</p> <p>B195-d18/18mm 75-95-75mm</p>
	<p>R8082 NO. 65-70-90-155-65mm 175-220-130-100-</p> <p>TUBO INFERIOR DO RADIADOR</p> <p>OPEL CORSA B (S93) 1.5 D (F08, F68, M68) 03.1993/09.2000 37KW 50CV 1488CC 15 D 0039925 7526324 - OPEL CORSA B (S93) 1.5 TD (F08, F68, M68) 03.1993/09.2000 49KW 67CV 1488CC 15 TD X 15 DT 15 DT 0039926 0039159 0039158 7526325 - OPEL CORSA B (S93) 1.7 D (F08, F68, M68) 02.1996/09.2000 44KW 60CV 1686CC X 17 D (4EE1) 17 D (4EE1) 0039164 0039163 0039956 - OPEL CORSA B Caixa/parte traseira inclinada (...)</p> <p>B300-d34/31mm d18mm 65-70-90-155-65mm 175-220-130-100-13</p>		<p>R8084 NO. 1337190 - 90444470</p> <p>TUBO SUPERIOR DO RADIADOR</p> <p>OPEL CORSA B (S93) 1.4 i (F08, F68, M68) 03.1993/09.2000 44KW 60CV 1389CC C 14 NZX 14 SZ 0039924 0039165 0039166 7526322 - OPEL CORSA B (S93) 1.4 i 16V (F08, F68, M68) 09.1994/09.2000 66KW 90CV 1389CC X 14 XE 0039927 0039160 0039161 - OPEL CORSA B (S93) 1.4 i 16V (F08, F68, M68) 08.1997/09.2000 63KW 86CV 1389CC C 14 SEL - OPEL CORSA B (S93) 1.6 GSI 16V (F08, F68, M68) 03.1993/09.2000 80KW 109CV 15... </p> <p>B160-d34/34mm 145-180-95mm</p>
	<p>R8085 NO. 1337191 - 90444475</p> <p>TUBO SUPERIOR DO RADIADOR</p> <p>OPEL CORSA B (S93) 1.6 i 16V (F08, F68, M68) 09.1994/09.2000 78KW 106CV 1598CC X 16 XE 0039928 0039162 - OPEL CORSA B (S93) 1.6 i 16V (F08, F68, M68) 08.1997/09.2000 74KW 100CV 1598CC C 16 SEL</p> <p>B185-d32/32mm</p>		<p>R8100 NO. 1337192 - 1337252 - 1337285 - 1337381 - 90444476 - 90487614 - 90510393 - 90570023</p> <p>TUBO SUPERIOR DO RADIADOR</p> <p>OPEL CORSA B (S93): 1.5 D (F08, F68, M68) 03.1993/09.2000 37KW 50CV 1488CC - OPEL CORSA B (S93): 1.5 TD (F08, F68, M68) 03.1993/09.2000 49KW 67CV 1488CC - OPEL CORSA B (S93): 1.7 D (F08, F68, M68) 02.1996/09.2000 44KW 60CV 1686CC - OPEL CORSA B Caixa/parte traseira inclinada (S93): 1.5 D (F08, W5L) 09.1994/05.1997 37KW 50CV 1488CC - OPEL CORSA B Caixa/parte traseira inclinada (S93): 1.7 D (F08, W5L) ...</p> <p>B350-d34/34mm 200-90-110mm</p>
	<p>R8136 NO. 6818182</p> <p>TUBO DEPÓSITO COMPENSAÇÃO AO TUBO ÁGUA RÍGIDO</p> <p>OPEL CORSA B (73_... 78_... 79_) 1.4 i 16V (09.94 A 09.00) 90cv 1389cc Hatchback - OPEL CORSA B (73_... 78_... 79_) 1.4 i 16V (09.94 A 09.00) 91cv 1389cc Hatchback - OPEL CORSA B (73_... 78_... 79_) 1.6 i 16V (09.94 A 09.00) 106cv 1598cc Hatchback - OPEL CORSA B (73_... 78_... 79_) 1.6 GSI 16V (03.93 A 09.00) 109cv 1598cc Hatchback</p> <p>B340-17/17mm 60-80-100-60-60-180mm</p>		<p>R8137 NO. 140-70-50-130-90-40-40-60-50-60-13</p> <p>TUBO PERMUTADOR AQUECIMENTO</p> <p>OPEL CORSA B (73_... 78_... 79_) 1.2 i 16V (03.98 A 09.00) 65cv 1199cc Hatchback</p> <p>B190-19/19mm 140-70-50-130-90-40-40-60-50-60-130mm</p>
	<p>R8151 NO. 838276 - 90470097</p> <p>TUBO LIGAÇÃO COLECTOR ADMISSÃO</p> <p>OPEL CORSA B (S93) VITA 1.4 i 16V (F08, F68, M68) 09.1994/09.2000 66KW 90CV 1389CC X 14 XE 0039927 0039160 0039161 - OPEL CORSA B (S93) VITA 1.4 i 16V (F08, F68, M68) 08.1997/09.2000 63KW 86CV 1389CC C 14 SEL - OPEL CORSA B (S93) VITA 1.6 i 16V (F08, F68, M68) 09.1994/09.2000 78KW 106CV 1598CC X 16 XE 0039928 0039162 - OPEL CORSA B (S93) VITA 1.6 i 16V (F08, F68, M68) 08.1997/09.2000 74KW ...</p> <p>d76x49mm 1f-d67mm</p>		<p>R8175 NO. 57x160x103x41mm ch-d18x50x65x51x58mm...</p> <p>TUBO DO PERMUTADOR DO CALOR</p> <p>OPEL CORSA B (S93) 1.5 D (F08, F68, M68) 03.1993/09.2000 37KW 50CV 1488CC 15 D 0039925 7526324 - OPEL CORSA B (S93) 1.5 TD (F08, F68, M68) 03.1993/09.2000 49KW 67CV 1488CC 15 TD X 15 DT X 15 DT 0039926 0039159 0039158 7526325 - OPEL CORSA B (S93) 1.7 D (F08, F68, M68) 02.1996/09.2000 44KW 60CV 1686CC X 17 D (4EE1) 17 D (4EE1) 0039164 0039163 0039956 - OPEL CORSA B Caixa/parte traseira inclinada...</p> <p>B350-22/23mm 57x160x103x41mm ch-d18x50x65x51x58mm...</p>
	<p>R8197 NO. 806137 - 90467441</p> <p>TUBO DO RESPIRO DO DEPÓSITO COMBUSTIVEL</p> <p>OPEL CORSA B (S93) 1.0 i 12V (F08, F68, M68) 11.1996/09.2000 40KW 54CV 973CC X 10 XE 0039167 0039168 - OPEL CORSA B (S93) 1.2 i (F08, F68, M68) 03.1993/09.2000 33KW 45CV 1195CC C 12 NZ X 12 SZ 0039923 0039156 0039157 7526321 - OPEL CORSA B (S93) 1.2 i (F08, F68, M68) 03.1993/09.2000 33KW 45CV 1195CC 12 NZ - OPEL CORSA B (S93) 1.2 i 16V (F08, F68, M68) 03.1998/09.2000 48KW 65CV 1199CC X 12 XE 00391...</p> <p>B405-d37/d37mm 96-220-80mm</p>		<p>RF80245 NO. 0606401 - 606401</p> <p>TUBO DE FERRO REFRIGERAÇÃO</p> <p>OPEL CORSA B (S93) 1.5 D (F08 - F68 - M68) (De 03-1993 Até 09-2000) 37kW 50CV 1488cc Hatchback OPEL CORSA B (S93) 1.5 TD (F08 - F68 - M68) (De 03-1993 Até 09-2000) 49kW 67CV 1488cc Hatchback OPEL CORSA B (S93) 1.7 D (F08 - F68 - M68) (De 02-1996 Até 09-2000) 44kW 60CV 1686cc Hatchback OPEL CORSA B Caixa (S93) 1.7 D (F08 - W5L) (De 08-1999 Até 09-2000) 44kW 60CV 1686cc Caixa</p> <p>d35x51mm c45mm 1f-d31</p>
	<p>RF80247 NO. 1336122 - 97103748</p> <p>TUBO DE FERRO RADIADOR REFRIGERAÇÃO</p> <p>OPEL CORSA B (S93) 1.5 TD (F08, F68, M68) (De 03.1993 Até 09.2000) 49KW 67cv 1488cm3 Hatchback - R</p> <p>B393-15/24mm 54x59x120x108x87mm ch-d18x34mm</p>		<p>RT08615 NO. 562095 - 90473452 - 96212323</p> <p>TUBO DE TRAVÃO FRENTE LH-RH</p> <p>OPEL CORSA B TT (03-1993 A 09-2000) - OPEL TIGRA TT (APÓS 07-1994)</p> <p>340mm FB3/1 - OR19</p>
	<p>S1072 NO. 402643</p> <p>SILENT-BLOC DO ESTABILIZADOR</p> <p>OPEL CORSA B 1.0i - 1.2i - 1.4i - 1.5D - 1.5TD - 1.7D (1992 A 2000)</p> <p>d52x65mm d39mm 1f-d10mm</p>		<p>S1126 NO. 352301 - 904445097</p> <p>SILENT-BLOC DA SUSPENSÃO</p> <p>OPEL CORSA B 1.0i - 1.2i - 1.4i - 1.5D - 1.5TD - 1.7D - 1.7TD (1993 A 2000)</p> <p>d45x52mm d38mm 1f-d10mm</p>

	<p>S1508 NO. 0353561 - 353561 - 90445098</p> <p>SILENT BLOCO DO BRAÇO DA SUSPENSÃO DA FRENTE</p> <p>OPEL CORSA B (73_ - 78_ - 79_) 1.0 i 12V (X 10 XE) 54CV (11-1996 A 09-2000) - 1.2 i (12 NZ) 45CV (03-1993 A 09-2000) - 1.2 i (C 12 NZ - X 12 SZ) 45CV (03-1993 A 09-2000) - 1.2 i 16V (X 12 XE) 65CV (03-1998 A 09-2000) - 1.4 i (C 14 NZ - X 14 SZ) 60CV (03-1993 A</p> <p>d50x46x40mm c18mm d37.5mm 1f-d14mm</p>		<p>S1616-D NO. 0353280 - 09191299 - 353280 - 353283 - 353284 - 90445101 - 90539059 - 9191299</p> <p>SILENT-BLOC BRAÇO SUSPENSÃO FRENTE DIREITO</p> <p>OPEL CORSA B (S93) VITA 1.0 i 12V (F08, F68, M68) 11.1996/09.2000 40KW 54CV 973CC X 10 XE 0039167 0039168 - OPEL CORSA B (S93) VITA 1.2 i (F08, F68, M68) 03.1993/09.2000 33KW 45CV 1195CC C 12 NZ X 12 SZ 0039923 0039156 0039157 7526321 - OPEL CORSA B (S93) VITA 1.2 i (F08, F68, M68) 03.1993/09.2000 33KW 45CV 1195CC 12 NZ - OPEL CORSA B (S93) VITA 1.2 i 16V (F08, F68, M68) 03.1998/09.2000 48...</p> <p>170x130x60mm 1f-d14mm 3f-d14mm 2f-d9mm</p>
	<p>S1616-E NO. 0353281 - 0353282 - 0353285 - 09191298 - 353281 - 353282 - 353285 - 90445100 - 90539058</p> <p>SILENT-BLOC BRAÇO SUSPENSÃO FRENTE ESQUERDO</p> <p>OPEL CORSA B (S93) VITA 1.0 i 12V (F08, F68, M68) 11.1996/09.2000 40KW 54CV 973CC X 10 XE 0039167 0039168 - OPEL CORSA B (S93) VITA 1.2 i (F08, F68, M68) 03.1993/09.2000 33KW 45CV 1195CC C 12 NZ X 12 SZ 0039923 0039156 0039157 7526321 - OPEL CORSA B (S93) VITA 1.2 i (F08, F68, M68) 03.1993/09.2000 33KW 45CV 1195CC 12 NZ - OPEL CORSA B (S93) VITA 1.2 i 16V (F08, F68, M68) 03.1998/09.2000 48...</p> <p>170x130x60mm 1f-d14mm 3f-d14mm 2f-d9mm</p>		<p>S2032 NO. 353283 - 353562 - 90539057 - 90539058 - 90539059</p> <p>SILENT-BLOC DO BRAÇO SUSPENSÃO DA FRENTE PARTE INFERIOR</p> <p>OPEL CORSA B (S93) VITA 1.0 i 12V (F08, F68, M68) 11.1996/09.2000 40KW 54CV 973CC X 10 XE 0039167 0039168 - OPEL CORSA B (S93) VITA 1.2 i (F08, F68, M68) 03.1993/09.2000 33KW 45CV 1195CC C 12 NZ X 12 SZ 0039923 0039156 0039157 7526321 - OPEL CORSA B (S93) VITA 1.2 i (F08, F68, M68) 03.1993/09.2000 33KW 45CV 1195CC 12 NZ - OPEL CORSA B (S93) VITA 1.2 i 16V (F08, F68, M68) 03.1998/09.2000 48...</p> <p>d62x 35mm c-24mm dc-58mm1f-d14mm</p>
	<p>T0039 NO. 0350127 - 350109 - 350119 - 350127 - 90168602 - 90236108 - 90447946</p> <p>BATENTE DO CENTRO DA BARRA ESTABILIZADORA</p> <p>OPEL CORSA B (S93): 1.0 i 12V (F08, F68, M68) 11.1996/09.2000 40KW 54CV 973CC - OPEL CORSA B (S93): 1.0 i 12V (F08, F68, M68) 11.1996/09.2000 40KW 54CV 973CC - OPEL CORSA B (S93): 1.2 i (F08, F68, M68) 03.1993/09.2000 33KW 45CV 1195CC - OPEL CORSA B (S93): 1.2 i (F08, F68, M68) 03.1993/09.2000 33KW 45CV 1195CC - OPEL CORSA B (S93): 1.2 i (F08, F68, M68) 03.1993/09.2000 33KW 45CV 1195CC - OPEL CORSA B (S93): 1.2 i 16V (F08, F68, M68) 03.1998/09.2000 48KW 65CV 1199CC - OPEL ...</p> <p>40x37x34mm 1f-d21mm</p>		<p>UMB84011 NO. 031126</p> <p>TAMPÃO BLOCO MOTOR</p> <p>OPEL CORSA B (S93) 1.2 i (F08 - F68 - M68) (De 03-1993 Até 09-2000) 33KW 45CV 1195cc Hatchback OPEL CORSA B (S93) 1.2 i (F08 - F68 - M68) (De 03-1993 Até 09-2000) 33KW 45CV 1195cc Hatchback OPEL CORSA B (S93) 1.4 i (F08 - F68 - M68) (De 03-1993 Até 09-2000) 44KW 60CV 1389cc Hatchback OPEL CORSA B Caixa (S93) 1.4 i (F08 - W5L) (De 08-1999 Até 09-2000) 44KW 60CV 1389cc Caixa</p> <p>d-18x8mm di-16mm</p>
	<p>UMB84011L NO. 11062402 - 2060675</p> <p>TAMPÃO BLOCO DE MOTOR (RELAS)</p> <p>OPEL CORSA B (S93) 1.2 i (F08 - F68 - M68) (De 03-1993 Até 09-2000) 33KW 45CV 1195cc Hatchback OPEL CORSA B (S93) 1.2 i (F08 - F68 - M68) (De 03-1993 Até 09-2000) 33KW 45CV 1195cc Hatchback OPEL CORSA B (S93) 1.4 i (F08 - F68 - M68) (De 03-1993 Até 09-2000) 44KW 60CV 1389cc Hatchback OPEL CORSA B Caixa (S93) 1.4 i (F08 - W5L) (De 08-1999 Até 09-2000) 44KW 60CV 1389cc Caixa</p> <p>d-18x8mm di-16mm</p>		<p>UMB84029 NO. 2060946</p> <p>TAMPÃO BLOCO MOTOR</p> <p>OPEL CORSA B (S93) 1.2 i (F08, F68, M68) (03.93 A 09.00) 45cv 1195cc Hatchback - OPEL CORSA B Caixa (S93) 1.4 i (F08, W5L) (08.99 A 09.00) 60cv 1389cc Caixa</p> <p>d36x10mm di-32mm</p>
	<p>UMV26806 NO. 5738736 - 90511219</p> <p>MANETE PUNHO TOPO ALAVANCA MUDANÇAS 5 VELOCIDADES F19MM</p> <p>OPEL CORSA B (S93): 1.2 i (F08, F68, M68) 03.1993/09.2000 33KW 45CV 1195CC - OPEL CORSA B (S93): 1.2 i (F08, F68, M68) 03.1993/09.2000 33KW 45CV 1195CC - OPEL CORSA B (S93): 1.4 i (F08, F68, M68) 03.1993/09.2000 44KW 60CV 1389CC - OPEL CORSA B (S93): 1.6 GSI 16V (F08, F68, M68) 03.1993/09.2000 80KW 109CV 1598CC - OPEL CORSA B (S93): 1.5 D (F08, F68, M68) 03.1993/09.2000 37KW 50CV 1488CC - OPEL COR...</p> <p>55x47x45mm 1f-d19mm</p>		<p>UMV26809 NO. 5738737 - 90540619 - 9200972</p> <p>MANETE PUNHO TOPO ALAVANCA MUDANÇAS 5 VELOCIDADES F32MM</p> <p>OPEL CORSA B (S93): 1.2 i (F08, F68, M68) 03.1993/09.2000 33KW 45CV 1195CC - OPEL CORSA B (S93): 1.4 i (F08, F68, M68) 03.1993/09.2000 44KW 60CV 1389CC - OPEL CORSA B (S93): 1.5 D (F08, F68, M68) 03.1993/09.2000 37KW 50CV 1488CC - OPEL CORSA B (S93): 1.7 D (F08, F68, M68) 02.1996/09.2000 44KW 60CV 1686CC</p> <p>d50x51mm 1f-d32mm</p>
	<p>UTR0800 NO. 1304240 - 1304654 - 1304659 - 1304660 - 1304661 - 1304665 - 1304666 - 1304667 - 1304853 - 90352470 - ...</p> <p>TAMPÃO RESERVATÓRIO LIQUIDO REFRIGERAÇÃO</p> <p>OPEL CORSA B 1.0 i 12V (11.96 A 09.00) 54cv 973cc Hatchback - OPEL CORSA B 1.2 i (03.93 A 09.00) 45cv 1195cc Hatchback - OPEL CORSA B 1.2 i (03.93 A 09.00) 45cv 1195cc Hatchback - OPEL CORSA B 1.2 i 16V (03.98 A 09.00) 65cv 1199cc Hatchback - OPEL CORSA B 1.4 i (03.93 A 09.00) 60cv 1389cc Hatchback - OPEL CORSA B 1.4 Si (03.93 A 09.00) 82cv 1389cc Hatchback - OPEL CORSA B 1.4 i 16V (09....</p> <p>d62x25mm 1f-d53x14mm</p>		<p>UTR0811 NO. 1304659 - 1304660 - 1304661 - 1304665 - 1304666 - 1304853 - 4395513 - 90352470 - 90409256 - 90409257...</p> <p>TAMPÃO RESERVATÓRIO LIQUIDO REFRIGERAÇÃO</p> <p>OPEL CORSA B (02.96 A 09.00) 60cv 1686cc Hatchback</p> <p>60x25mm 1f-d52x14mm</p>
	<p>UTR0820 NO. 90352470 - 90409256 - 90409257 - 9041032690497472 - 90467473</p> <p>TAMPÃO RESERVATÓRIO LIQUIDO REFRIGERAÇÃO</p> <p>OPEL CORSA B (73_ , 78_ , 79_) 1.0 i 12V (11.96 A 09.00) 54cv 973cc Hatchback - OPEL CORSA B (73_ , 78_ , 79_) 1.2 i (03.93 A 09.00) 45cv 1195cc Hatchback - OPEL CORSA B (73_ , 78_ , 79_) 1.2 i (03.93 A 09.00) 45cv 1195cc Hatchback - OPEL CORSA B (73_ , 78_ , 79_) 1.2 i 16V (03.98 A 09.00) 65cv 1199cc Hatchback - OPEL CORSA B (73_ , 78_ , 79_) 1.4 i (03.93 A 09.00) 60cv 1389cc Hatchback - OPEL COR...</p> <p>d62x23mm 1f-d53x12mm</p>		<p>UTR1201 NO. 1450591 - 90563741</p> <p>TAMPÃO RESERVATÓRIO LAVA VIDROS</p> <p>OPEL CORSA B (S93): 1.2 i (F08, F68, M68) 03.1993/09.2000 33KW 45CV 1195CC - OPEL CORSA B (S93): 1.2 i (F08, F68, M68) 03.1993/09.2000 33KW 45CV 1195CC - OPEL CORSA B (S93): 1.4 i (F08, F68, M68) 03.1993/09.2000 44KW 60CV 1389CC - OPEL CORSA B (S93): 1.6 GSI 16V (F08, F68, M68) 03.1993/09.2000 80KW 109CV 1598CC - OPEL CORSA B (S93): 1.5 D (F08, F68, M68) 03.1993/09.2000 37KW 50CV 1488CC - OPEL COR...</p> <p>d58x6mm c96mm di-d53x6mm</p>
	<p>UTR1305 NO. 0650089 - 650089</p> <p>TAMPÃO DO RESERVATÓRIO ÓLEO</p> <p>OPEL CORSA B (S93) VITA 1.0 i 12V (F08, F68, M68) 11.1996/09.2000 40KW 54CV 973CC X 10 XE 0039167 0039168 - OPEL CORSA B (S93) VITA 1.2 i (F08, F68, M68) 03.1993/09.2000 33KW 45CV 1195CC C 12 NZ X 12 SZ 0039923 0039156 0039157 7526321 - OPEL CORSA B (S93) VITA 1.2 i 16V (F08, F68, M68) 03.1998/09.2000 48KW 65CV 1199CC X 12 XE 0039176 0039175 - OPEL CORSA B (S93) VITA 1.4 i (F08, F68, M68) 0...</p> <p>d61x23mm d32x19mm</p>		<p>UTV83011 NO. 0652475 - 09275631 - 652475 - 652491 - 90409376 - 9275631 - N90288901</p> <p>TAMPÃO VEDAÇÃO BUJÃO</p> <p>OPEL CORSA B (S93) 1.2 i (F08 - F68 - M68) (De 03-1993 Até 09-2000) 33KW 45CV 1195cc Hatchback OPEL CORSA B (S93) 1.2 i (F08 - F68 - M68) (De 03-1993 Até 09-2000) 33KW 45CV 1195cc Hatchback OPEL CORSA B (S93) 1.4 i (F08 - F68 - M68) (De 03-1993 Até 09-2000) 44KW 60CV 1389cc Hatchback OPEL CORSA B (S93) 1.4 Si (F08 - F68 - M68) (De 03-1993 Até 09-2000) 60KW 82CV 1389cc Hatchback OPEL CORSA B (S93) ...</p> <p>19x18mm c12mm d14mm</p>

OPEL CORSA B

Rafri, Lda.

















	<p>UTV83019 NO. 0652315 - 0652477 - 652315 - 652477 - 90502556 - 96023264</p> <p>TAMPÃO VEDAÇÃO BUJÃO</p> <p>OPEL CORSA B (S93) 1.0 i 12V (F08 - F68 - M68) (De 11-1996 Até 09-2000) 40KW 54CV 973cc Hatchback OPEL CORSA B (S93) 1.2 i 16V (F08 - F68 - M68) (De 03-1998 Até 09-2000) 48kW 65CV 1199cc Hatchback</p>		<p>W5045 NO. 5614417 - 614457 - 614637 - 97011870 - 97129070</p> <p>POLIE DA CAMBOTA (1+1+1 PISTAS)</p> <p>OPEL CORSA B (S93): 1.5 D (F08, F68, M68) 03.1993/09.2000 37KW 50CV 1488CC - OPEL CORSA B (S93): 1.5 TD (F08, F68, M68) 03.1993/09.2000 49KW 67CV 1488CC - OPEL CORSA B (S93): 1.7 D (F08, F68, M68) 02.1996/09.2000 44KW 60CV 1686CC - OPEL CORSA B Caixa/parte traseira inclinada (S93): 1.7 D (F08, W5L) 08.1999/09.2000 44KW 60CV 1686CC</p>
	<p>W5078 NO. 0614611 - 5614406 - 5614430 - 614611 - 90412837 - 90502115 - 9129210</p> <p>POLIE DA CAMBOTA (6 PISTAS)</p> <p>OPEL CORSA B 1.0i 12v (11-1996 A 09-2000) - 1.2i 16v (03-1998 A 09-2000) - 1.4i 16v (09-1994 A 09-2000)</p>		<p>W5201 NO. 5614423 - 90572867</p> <p>POLIE DA CAMBOTA (5 PISTAS)</p> <p>OPEL CORSA B (S93): 1.0 i 12V (F08, F68, M68) 11.1996/09.2000 40KW 54CV 973CC - OPEL CORSA B (S93): 1.2 i 16V (F08, F68, M68) 03.1998/09.2000 48KW 65CV 1199CC</p>
	<p>Y3004 NO. 854982 - 90128082</p> <p>PARAFUSO ESCAPE</p> <p>OPEL CORSA B (APÓS 1993)</p>		<p>Y3212 NO. 1008501 - 1008504 - 4709077</p> <p>PARAFUSO PERNO RODA CHAVE 17 M12X1,50X48MM (BASE CONICA PARA JANTES AÇO E LIGA LEVE)</p> <p>OPEL CORSA B (S93) 1.2 i (F08, F68, M68) (03.1993 - 09.2000) 33kw 45cv 1195cm3 Hatchback OPEL CORSA B (S93) 1.2 i (F08, F68, M68) (03.1993 - 09.2000) 33kw 45cv 1195cm3 Hatchback OPEL CORSA B (S93) 1.2 i 16V (F08, F68, M68) (03.1998 - 09.2000) 48kw 65cv 1199cm3 Hatchback OPEL CORSA B (S93) 1.4 Si (F08, F68, M68) (03.1993 - 09.2000) 60kw 82cv 1389cm3 Hatchback OPEL CORSA B (S93) 1.4 i (F08, F68, M68...)</p>
	<p>Z86001 NO. 1438336 - 90332334</p> <p>MOLA FIXAÇÃO PALA TAPA-SOL</p> <p>OPEL CORSA B</p>		<p>Z9004 NO. 856563</p> <p>MOLA DE ESCAPE</p> <p>OPEL CORSA B (1993 A 1995)</p>
	<p>Z9011 NO. 1261479 - 1449282600 - 4709339 - 4711509 - 854880</p> <p>MOLA DE ESCAPE</p> <p>OPEL CORSA B</p>		

















OPEL CORSA C















	<p>A1634 NO. 0684234 - 24416555 - 684189 - 684234 - 90189477</p> <p>APOIO DO MOTOR PARTE DA FRENTE ESQUERDO</p> <p>OPEL CORSA C (X01) VITA 1.4 (F08, F68) 09.2000/12.2009 66KW 90CV 1389CC Z 14 XE 0035396 - OPEL CORSA C (X01) VITA 1.8 (F08, F68) 09.2000/12.2009 92KW 125CV 1796CC Z 18 XE 0035420</p>		<p>A1635 NO. 0684183 - 0684184 - 09227880 - 24467436 - 5684646 - 644184 - 684183 - 9227880 - 9227881 - 93183223</p> <p>APOIO DO MOTOR PARTE DA FRENTE DIREITO</p> <p>OPEL CORSA C 1.3 CDTi (APÓS 06-2003) - 1.4 - 1.8</p>
	<p>A1636 NO. 0684188 - 24416554 - 684188 - 684194</p> <p>APOIO DO MOTOR PARTE DA FRENTE ESQUERDO</p> <p>OPEL CORSA C 1.0 - 1.2 - CORSA C 1.7Di - 1.7DTi - 1.7Di 16v - 1.7DTi 16v (APÓS 09-2000)</p>		<p>A1935 NO. 0846082 - 13117089 - 846082</p> <p>APOIO DO MOTOR</p> <p>OPEL CORSA C (F08 - F68) 1.0 N.º chas. a partir de: 34184448 (09.00 A 06.03) 58cv 973cc Hatchback - OPEL CORSA C (F08, F68) 1.0 N.º chas. a partir de: 34184448 (06.03 A 12.09) 60cv 998cc Hatchback</p>

	<p>A1943 NO. 0344523 - 344523 - 90468554</p> <p>APOIO SUPORTE AMORTECEDOR FRENTE (GASTA 2 UNIDADES)</p> <p>OPEL CORSA C (F08, F68) 1.0 (09.00 A 06.03) 58cv 973cv Hatchback - OPEL CORSA C (F08, F68) 1.0 06.03 A 12.09) 60cv 998cc Hatchback - OPEL CORSA C (F08, F68) 1.2 (09.00 A 12.09) 75cv 1199cc Hatchback - OPEL CORSA C (F08, F68) 1.2 Twinport (07.04 A 12.09) 80cv 1229cc Hatchback - OPEL CORSA C (F08, F68) 1.4 Twinport (06.03 A 12.09) 90cv 1364cc Hatchback - OPEL CORSA C (F08, F68) 1.4 (09.00 ...</p> <p>d115x45mm 1f-d12mm</p>		<p>A2069 NO. 0684238 - 184398A - 24416545 - 684238 - 93302281</p> <p>APOIO MOTOR FRENTE CENTRO</p> <p>OPEL CORSA C (X01) 1.2 (F08 - F68) (De 09-2000 Até 12-2009) 55kW 75CV 1199cc Hatchback OPEL CORSA C (X01) 1.2 Twinport (F08 - F68) (De 07-2004 Até 12-2009) 59kW 80CV 1229cc Hatchback OPEL CORSA C (X01) 1.4 Twinport (F08 - F68) (De 06-2003 Até 12-2009) 66kW 90CV 1364cc Hatchback OPEL CORSA C (X01) 1.4 (F08 - F68) (De 09-2000 Até 12-2009) 66kW 90CV 1389cc Hatchback OPEL CORSA C (X01) 1.8 (F08 - F68)...</p> <p>204x94x84mm 1f-d16mm 2f-d12mm</p>
	<p>A2180 NO. 24463129 - 5684172</p> <p>APOIO DO MOTOR PARTE DA FRENTE</p> <p>OPEL CORSA C (X01) 1.7 CDTI (F08, F68) (De 2003.06 Até 2009.12) 74kW 100cv 1686cm3 Hatchback - OPEL CORSA C Caixa (X01) 1.7 CDTI (F08, W5L) (De 2003.08 Até 2012.12) 74kW 101cv 1686cm3 Caixa -</p> <p>186x115x105mm 1f-d16mm 2f-d12mm</p>		<p>A2301 NO. 0684180 - 0684181 - 09227878 - 09227879 - 13125209 - 5684168 - 5684170</p> <p>APOIO DO MOTOR LADO DIREITO</p> <p>OPEL CORSA C (X01) 1.0 (F08, F68) (De 2000.09 Até 2003.06) 43kW 58cv 973cm3 Hatchback - OPEL CORSA C (X01) 1.0 (F08, F68) (De 2003.06 Até 2009.12) 44kW 60cv 998cm3 Hatchback - OPEL CORSA C (X01) 1.2 (F08, F68) (De 2000.09 Até 2009.12) 55kW 75cv 1199cm3 Hatchback - OPEL CORSA C (X01) 1.2 Twinport (F08, F68) (De 2004.07 Até 2009.12) 59kW 80cv 1229cm3 Hatchback -</p> <p>204x94x84mm 2f-d11mm 2f-d17mm</p>
	<p>A2594 NO. 13109203 - 5684761</p> <p>APOIO DO MOTOR PARTE DA FRENTE LADO ESQUERDO</p> <p>OPEL CORSA C (X01) 1.3 CDTI (F08, F68) (De 06.2003 Até 12.2009) 51kW 70cv 1248cm3 Hatchback - OPEL CORSA C (X01) 1.7 DI (F08, F68) (De 09.2000 Até 12.2009) 48kW 65cv 1686cm3 Hatchback - OPEL CORSA C (X01) 1.7 DTI (F08, F68) (De 09.2000 Até 12.2009) 55kW 75cv 1686cm3 Hatchback - OPEL CORSA C Caixa/parte traseira inclinada (X01) 1.3 CDTI 16V (F08, W5L) (De 07.2005 Até 06.2006) 51kW 69cv 1248cm3 Caix...</p> <p>175x114x140mm 2f-d19mm 4f-d9mm</p>		<p>B450 NO. 164987</p> <p>ABRAÇADEIRA DO REVESTIMENTO DO HABITÁCULO</p> <p>OPEL CORSA C (X01) 1.0 (F08, F68) (06.2003 - 12.2009) 44kW 60cv 998cm3 Hatchback OPEL CORSA C (X01) 1.0 (F08, F68) (09.2000 - 06.2003) 43kW 58cv 973cm3 Hatchback OPEL CORSA C (X01) 1.2 (F08, F68) (09.2000 - 12.2009) 55kW 75cv 1199cm3 Hatchback OPEL CORSA C (X01) 1.2 Twinport (F08, F68) (07.2004 - 12.2009) 59kW 80cv 1229cm3 Hatchback OPEL CORSA C (X01) 1.3 CDTI (F08, F68) (06.2003 - 12.2009) 51kW ...</p> <p>245x38x11mm</p>
	<p>B450 NO. 164987</p> <p>ABRAÇADEIRA DO REVESTIMENTO DO HABITÁCULO</p> <p>OPEL CORSA D (S07) 1.0 (L08, L68) (07.2006 - 12.2010) 44kW 60cv 998cm3 Hatchback OPEL CORSA D (S07) 1.0 (L08, L68) (12.2009 - 08.2014) 48kW 65cv 998cm3 Hatchback OPEL CORSA D (S07) 1.2 (L08, L68) (12.2009 - 08.2014) 51kW 69cv 1229cm3 Hatchback OPEL CORSA D (S07) 1.2 (L08, L68) (07.2006 - 08.2014) 59kW 80cv 1229cm3 Hatchback OPEL CORSA D (S07) 1.2 (L08, L68) (12.2009 - 08.2014) 63kW 86cv 1229cm3 H...</p> <p>245x38x11mm</p>		<p>C0233 NO. 1160724 - 90054143</p> <p>BOTÃO AFINAÇÃO CAPÔT</p> <p>OPEL CORSA C (F08, F68) 1.0 (09.00 A 06.03) 58cv 973cc Hatchback - OPEL CORSA C (F08, F68) 1.0 (06.03 A 12.09) 60cv 998cc Hatchback - OPEL CORSA C (F08, F68) 1.2 (09.00 A 12.09) 75cv 1199cc Hatchback - OPEL CORSA C (F08, F68) 1.2 Twinport (07.04 A 12.09) 80cv 1229cc Hatchback - OPEL CORSA C (F08, F68) 1.4 Twinport (06.03 A 12.09) 90cv 1364cc Hatchback - OPEL CORSA C (F08, F68) 1.4 (09.00...</p> <p>d19x31mm</p>
	<p>E0013 NO. 852715 - 852716 - 852720</p> <p>ESTICADOR DE ESCAPE</p> <p>OPEL CORSA C 1.2 - 1.4 - 1.8 - 1.7Di - 1.7DTi - (APÓS 2000)</p> <p>66x56x13mm</p>		<p>E0129 NO. 0350610 - 350610 - 4886606 - 90496116</p> <p>ESTICADOR DA BARRA ESTABILIZADORA DA FRENTE</p> <p>OPEL CORSA C TT</p> <p>285x36x36mm 2p-d12-25mm</p>
	<p>E0601-M NO. 50510781 - 55703436</p> <p>ESTICADOR SUPORTE APOIO MOTOR TRAS</p> <p>OPEL CORSA C Caixa/parte traseira inclinada (X01): 1.2 (F08, W5L) 07.2005/06.2006 59KW 80CV 1229CC</p> <p>210x97x46mm 1f-d12mm 1f-d13mm 1r-d10mm</p>		<p>E0605-M NO. 0846000 - 09227883 - 24463130 - 8 46 083 - 846000 - 9227883 - 93302286</p> <p>ESTICADOR SUPORTE APOIO MOTOR TRAS</p> <p>OPEL CORSA C (X01) VITA 1.0 (F08, F68) 09.2000/06.2003 43KW 58CV 973CC Z 10 XE 0035394 - OPEL CORSA C (X01) VITA 1.0 (F08, F68) 06.2003/12.2009 44KW 60CV 998CC Z 10 XEP 0035519 - OPEL CORSA C (X01) VITA 1.2 (F08, F68) 09.2000/12.2009 55KW 75CV 1199CC Z 12 XE 0035395 - OPEL CORSA C (X01) VITA 1.2 Twinport (F08, F68) 07.2004/12.2009 59KW 80CV 1229CC Z 12 XEP 0035534 - OPEL CORSA C (X01) VI...</p> <p>220x100x50mm 2f-d12mm 1f-12x18mm</p>
	<p>E0606-M NO. 0684713 - 09227882 - 684713 - 9227882 - 93302287</p> <p>ESTICADOR SUPORTE APOIO MOTOR TRAS</p> <p>OPEL CORSA C (X01) VITA 1.0 (F08, F68) 09.2000/06.2003 43KW 58CV 973CC Z 10 XE 0035394 - OPEL CORSA C (X01) VITA 1.2 (F08, F68) 09.2000/12.2009 55KW 75CV 1199CC Z 12 XE 0035395 - OPEL CORSA C (X01) VITA 1.2 Twinport (F08, F68) 07.2004/12.2009 59KW 80CV 1229CC Z 12 XEP 0035534 - OPEL CORSA C (X01) VITA 1.4 (F08, F68) 09.2000/12.2009 66KW 90CV 1389CC Z 14 XE 0035396 - OPEL CORSA C (X01) VI...</p> <p>207x80x44mm 1f-d12mm 1f-d13mm 1r-d10mm</p>		<p>E0639-M NO. 0846034 - 13143386 - 846034</p> <p>ESTICADOR SUPORTE APOIO MOTOR TRAS</p> <p>OPEL CORSA C (X01) VITA 1.3 CDTI (F08, F68) 06.2003/12.2009 51KW 70CV 1248CC Z 13 DT Y 13 DT 0035520 - OPEL CORSA C Caixa/parte traseira inclinada (X01) 1.3 CDTI 16V (F08, W5L) 07.2005/06.2006 51KW 69CV 1248CC Z 13 DT 0035AFC 0035115</p> <p>223x111x57mm 2f-d12mm 1f-13x19mm</p>
	<p>E0653-M NO. 0684717 - 13117088 - 684717</p> <p>ESTICADOR DO MOTOR PARTE DE TRÁS</p> <p>OPEL CORSA C (X01) 1.0 (F08, F68) (09.2000 - 06.2003) 43kW 58cv 973cm3 Hatchback OPEL CORSA C (X01) 1.0 (F08, F68) (06.2003 - 12.2009) 44kW 60cv 998cm3 Hatchback OPEL CORSA C (X01) 1.3 CDTI (F08, F68) (06.2003 - 12.2009) 51kW 70cv 1248cm3 Hatchback OPEL CORSA C Caixa/parte traseira inclinada (X01) 1.3 CDTI 16V (F08, W5L) (07.2005 - 06.2006) 51kW 69cv 1248cm3 Caixa/parte traseira inclinada</p> <p>215x101x44mm 1f-d12mm 1r-d10mm 1f-d12mm</p>		<p>E1092 NO. 0852726 - 13276148 - 852777 - 852726 - 90466668</p> <p>ESTICADOR DE ESCAPE</p> <p>OPEL CORSA C (X01): 1.0 (F08, F68) 09.2000/06.2003 43KW 58CV 973CC - OPEL CORSA C (X01): 1.0 (F08, F68) 06.2003/12.2009 44KW 60CV 998CC - OPEL CORSA C (X01): 1.2 (F08, F68) 09.2000/12.2009 55KW 75CV 1199CC - OPEL CORSA C (X01): 1.2 Twinport (F08, F68) 07.2004/12.2009 59KW 80CV 1229CC - OPEL CORSA C (X01): 1.4 Twinport (F08, F68) 06.2003/12.2009 66KW 90CV 1364CC - OPEL CORSA C (X01): 1.4 (F08, F68)...</p> <p>55x40x35mm</p>

	<p>F0517-I NO. 374093 - 374101</p> <p>FOLE DO SEMI-EIXO INTERNO</p> <p>OPEL CORSA C 1.2i - 1.4i - 1.7i - 1.7DTi (APÓS 2000)</p> <p>d90x103mm 1f-d74mm 1f-d22mm</p>		<p>F1829H-I NO. 1603005 - 20424726 - 26067603 - 26070498</p> <p>FOLE DA TRANSMISSÃO JUNTO À RODA</p> <p>OPEL CORSA C 1.0i - 1.2i (APÓS 2000)</p> <p>d90x130mm 1f-d72mm 1f-d23mm</p>
	<p>F1830H-I NO. 1603189 - 1603231</p> <p>FOLE DA TRANSMISSÃO JUNTO À RODA</p> <p>OPEL CORSA C 1.3 CDTi - 1.4i 16v (APÓS 2000) - CORSA C 1.7 Di 16v - 1.7 DTi 16v</p> <p>d90x135mm 1f-d78mm 1f-d23mm</p>		<p>F1845-I NO. 1603004 - 1603230 - 26073421 - 26094870</p> <p>FOLE DA TRANSMISSÃO LADO DA CAIXA</p> <p>OPEL CORSA C 1.0i - 1.2i - 1.3 CDTi - 1.4i (APÓS 2000)</p> <p>d81x95mm 1f-d72mm 1f-d22mm</p>
	<p>F1848-I NO. 1603014 - 1603183 - 1603238 - 374014 - 374319 - 374429 - 90543336</p> <p>FOLE DA TRANSMISSÃO JUNTO À CAIXA</p> <p>OPEL CORSA C 1.8i 16v (APÓS 2000)</p> <p>d95x100mm 1f-d65mm 1f-d24mm</p>		<p>F4093 NO. 0738423 - 09200970 - 738423 - 9200970</p> <p>FOLE ALAVANCA VELOCIDADES</p> <p>OPEL CORSA C (X01): 1.0 (F08, F68) 09.2000/06.2003 43KW 58CV 973CC - OPEL CORSA C (X01): 1.0 (F08, F68) 06.2003/12.2009 44KW 60CV 998CC - OPEL CORSA C (X01): 1.2 (F08, F68) 09.2000/12.2009 55KW 75CV 1199CC - OPEL CORSA C (X01): 1.2 Twinport (F08, F68) 07.2004/12.2009 59KW 80CV 1229CC - OPEL CORSA C (X01): 1.4 Twinport (F08, F68) 06.2003/12.2009 66KW 90CV 1364CC - OPEL CORSA C (X01): 1.4 (F08, F68)...</p> <p>160x110x170mm 1f-d50mm</p>
	<p>F4094 NO. 0738978 - 5738414 - 738978 - 90373314 - 90437426</p> <p>FOLE ALAVANCA VELOCIDADES</p> <p>OPEL CORSA C Caixa (X01): 1.2 (F08, W5L) 07.2005/06.2006 59KW 80CV 1229CC</p> <p>170x120x220mm 1f-160x105mm 1f-d50mm</p>		<p>F4098 NO. 5738416 - 93181112</p> <p>FOLE ALAVANCA VELOCIDADES</p> <p>OPEL CORSA C (X01): 1.7 CDTi (F08, F68) 06.2003/12.2009 74KW 100CV 1686CC</p> <p>180x120x170mm 1f-d50mm 1f-155x105mm</p>
	<p>F4216 NO. 55557718 - 5738056</p> <p>FOLE ALAVANCA VELOCIDADES</p> <p>OPEL CORSA C Caixa/parte traseira inclinada (X01): 1.7 CDTi (F08, W5L) 08.2003/12.2012 74KW 101CV 1686CC</p> <p>157x120x195mm 1f-140x108mm</p>		<p>KF1845-I NO. 1603004 - 1603230 - 26073421 - 26094870</p> <p>KIT FOLE TRANSMISSÃO JUNTO À CAIXA</p> <p>OPEL CORSA C (X01) 1.0 (09.00 A 06.03) 58cv 973cc Hatchback - OPEL CORSA C (X01) 1.0 (06.03 A 12.09) 60cv 998cc Hatchback - OPEL CORSA C (X01) 1.2 (09.00 A 12.09) 75cv 1199cc Hatchback - OPEL CORSA C (X01) 1.2 Twinport (07.04 A 12.09) 80cv 1229cc Hatchback - OPEL CORSA C (X01) 1.4 Twinport (06.03 A 12.09) 90cv 1364cc Hatchback - OPEL CORSA C (X01) 1.4 (09.00 A 12.09) 90cv 1389cc Hatchba...</p> <p>d81x95mm 1f-d72mm 1f-d22mm</p>
	<p>KF2371-T NO. 1603005 - 20424726 - 26067603 - 26070498</p> <p>KIT DE FOLE DO CARDAN JUNTO À RODA</p> <p>OPEL CORSA C 1.0i - 1.2i (APÓS 2000)</p> <p>d88x126mm 1f-d72mm 1f-d23mm</p>		<p>KF2527-T NO. 1603189 - 1603231</p> <p>KIT DE FOLE DO CARDAN JUNTO À RODA</p> <p>OPEL CORSA C 1.3 CDTi - 1.4i - 1.7 Di - 1.7 DTi (APÓS 2000)</p> <p>d95x130mm 1f-d78mm 1f-d23mm</p>
	<p>KL80449 NO. 198283 - 607813 - 90412865</p> <p>KIT CASQUILHOS COBERTURA TAMPA MOTOR</p> <p>OPEL CORSA C (X01): 1.4 (F08, F68) 09.2000/12.2009 66KW 90CV 1389CC - OPEL CORSA C (X01): 1.8 (F08, F68) 09.2000/12.2009 92KW 125CV 1796CC</p> <p>d16x10mm 1f-d6mm</p>		<p>KL80932 NO. 1p-d6-10mm d-20/10mm 1f-d14mm 1f-d</p> <p>KIT CASQUILHO COBERTURA TAMPA MOTOR</p> <p>OPEL CORSA C (X01): 1.3 CDTi (F08, F68) 06.2003/12.2009 51KW 70CV 1248CC - OPEL CORSA C Caixa/parte traseira inclinada (X01): 1.3 CDTi 16V (F08, W5L) 07.2005/06.2006 51KW 69CV 1248CC</p> <p>d30/75mm d-33/19mm d-39/25mm d-41/21mm d-43/23mm d-45/25mm</p>
	<p>KUR2828 NO. 1f-d16mm 1f-d15mm 1f-d18mm 1f-d25mm</p> <p>KIT REPARAÇÃO ALAVANCA DE VELOCIDADES</p> <p>OPEL CORSA C (X01) 1.0 (F08, F68) (09.2000 - 06.2003) 43kw 58 973 Hatchback OPEL CORSA C (X01) 1.0 (F08, F68) (06.2003 - 12.2009) 44kw 60cv 998cm3 Hatchback OPEL CORSA C (X01) 1.2 (F08, F68) (09.2000 - 12.2009) 55kw 75cv 1199cm3 Hatchback OPEL CORSA C (X01) 1.2 Twinport (F08, F68) (07.2004 - 12.2009) 59kw 80cv 1229cm3 Hatchback OPEL CORSA C (X01) 1.3 CDTi (F08, F68) (06.2003 - 12.2009) 51kw 70cv 1...</p> <p>33x35x28mm(x2) d22x19mm d24x11mm d26x11mm d28x11mm d30x11mm d32x11mm d34x11mm d36x11mm d38x11mm d40x11mm d42x11mm d44x11mm d46x11mm d48x11mm d50x11mm</p>		<p>KUR2828 NO. 1f-d16mm 1f-d15mm 1f-d18mm 1f-d25mm</p> <p>KIT REPARAÇÃO ALAVANCA DE VELOCIDADES</p> <p>OPEL CORSA C Caixa/parte traseira inclinada (X01) 1.2 16V (F08, W5L) (09.2000 - 07.2003) 55kw 75cv 1199cm3 Caixa/parte traseira inclinada OPEL CORSA C Caixa/parte traseira inclinada (X01) 1.3 CDTi 16V (F08, W5L) (07.2005 - 06.2006) 51kw 69cv 1248cm3 Caixa/parte traseira inclinada OPEL CORSA C Caixa/parte traseira inclinada (X01) 1.4 (W5L, F08) (08.2003 - 06.2012) 66kw 90cv 1364cm3 Caixa/parte trasei...</p> <p>33x35x28mm(x2) d22x19mm d24x11mm d26x11mm d28x11mm d30x11mm d32x11mm d34x11mm d36x11mm d38x11mm d40x11mm d42x11mm d44x11mm d46x11mm d48x11mm d50x11mm</p>

	<p>M6045 NO. 854936 - 90231063</p> <p>JUNTA DE ESCAPE</p> <p>OPEL CORSA C (APÓS 2000)</p> <p>95x92mm 1f-d55mm</p>		<p>P1056 NO. 0560803 - 560803</p> <p>CAPA PEDAL EMBRAIAGEM/TRAVAO (GASTA 2 UNIDADES)</p> <p>OPEL CORSA C (X01) VITA 1.2 (F08, F68) 09.2000/12.2009 55KW 75CV 1199CC Z 12 XE 0035395 - OPEL CORSA C (X01) VITA 1.4 (F08, F68) 09.2000/12.2009 66KW 90CV 1389CC Z 14 XE 0035396 - OPEL CORSA C (X01) VITA 1.7 DI (F08, F68) 09.2000/12.2009 48KW 65CV 1686CC Y 17 DTL 0035416 - OPEL CORSA C (X01) VITA 1.7 DTI (F08, F68) 09.2000/12.2009 55KW 75CV 1686CC Y 17 DT 0035397 - OPEL CORSA C (X01) VIT...</p> <p>58x54x14mm</p>
	<p>P1103 NO. 0560804 - 09191205 - 560804 - 9191205 - 90468790</p> <p>CAPA PEDAL TRAVÃO (VEÍCULOS CAIXA AUTOMÁTICA)</p> <p>OPEL CORSA C (X01) VITA 1.0 (F08, F68) 09.2000/06.2003 43KW 58CV 973CC Z 10 XE 0035394 - OPEL CORSA C (X01) VITA 1.0 (F08, F68) 06.2003/12.2009 44KW 60CV 998CC Z 10 XEP 0035519 - OPEL CORSA C (X01) VITA 1.2 (F08, F68) 09.2000/12.2009 55KW 75CV 1199CC Z 12 XE 0035395 - OPEL CORSA C (X01) VITA 1.2 Twinport (F08, F68) 07.2004/12.2009 59KW 80CV 1229CC Z 12 XEP 0035534 - OPEL CORSA C (X01) VI...</p> <p>110x65x45mm</p>		<p>R015005 NO. ch-d8(f-d3mm)x260mm 4bicos-d6mm(f-...</p> <p>TUBO EXTRACTOR COMBUSTIVEL INJECTORES</p> <p>OPEL CORSA C (X01) 1.7 CDTI (F08, F68) (De 06.2003 Até 12.2009) 74kW 100cv 1686cm3 Hatchback - OPEL CORSA C Caixa/parte traseira inclinada (X01) 1.7 CDTI (F08, W5L) (De 08.2003 Até 12.2012) 74kW 101cv 1686cm3 Caixa/parte traseira inclinada -</p> <p>324mm ch-d8(f-d3mm)x260mm 4bicos-d6mm(f-d2mm) ...</p>
	<p>R017112 NO. 5851946 - 93177469</p> <p>TUBO DA VALVULA REGULADORA DE VELOCIDADE</p> <p>OPEL CORSA C (X01): 1.3 CDTI (F08, F68) 06.2003/12.2009 51KW 70CV 1248CC - OPEL CORSA C Caixa/parte traseira inclinada (X01): 1.3 CDTI 16V (F08, W5L) 07.2005/06.2006 51KW 69CV 1248CC</p> <p>B133-14/14mm 39x64x29x51mm</p>		<p>R019214 NO. 817329 - 93177371</p> <p>TUBO EXTRACTOR DE COMBUSTIVEL</p> <p>OPEL CORSA C (X01) VITA 1.3 CDTI (F08, F68) 06.2003/12.2009 51KW 70CV 1248CC Z 13 DT Y 13 DT 0035520 - OPEL CORSA C Caixa/parte traseira inclinada (X01) 1.3 CDTI 16V (F08, W5L) 07.2005/06.2006 51KW 69CV 1248CC Z 13 DT 0035AFC 0035115</p> <p>B455-3mm 4p-d5x10mm</p>
	<p>R080253 NO. 06336007 - 09128719</p> <p>TUBO LÍQUIDO REFRIGERAÇÃO</p> <p>OPEL CORSA C (X01) VITA 1.4 (F08, F68) 09.2000/12.2009 66KW 90CV 1389CC Z 14 XE 0035396 - OPEL CORSA C Caixa/parte traseira inclinada (X01) 1.4 (W5L, F08) 08.2003/06.2012 66KW 90CV 1364CC Z 14 XEP 0035AFB</p> <p>B340-30/35mm ch-d13-29mm ch-d13-30mm</p>		<p>R220256 NO. 1818546 - 24423509</p> <p>TUBO DO PERMUTADOR DE CALOR DO ARREFECIMENTO</p> <p>OPEL CORSA C (X01) VITA 1.4 (F08, F68) 09.2000/12.2009 66KW 90CV 1389CC Z 14 XE 0035396 - OPEL CORSA C (X01) VITA 1.8 (F08, F68) 09.2000/12.2009 92KW 125CV 1796CC Z 18 XE 0035420</p> <p>B257x18/19mm 89x79x38x42x60mm</p>
	<p>R221444 NO. 1337696</p> <p>TUBO SUPERIOR DO RADIADOR</p> <p>OPEL CORSA C (X01) 1.3 CDTI (F08, F68) (De 2003.06 Até 2009.12) 51kW 70cv 1248cm3 Hatchback -</p> <p>B325-28/31mm 42x133x81x46mm</p>		<p>R221446 NO. 49x90x150x138x95x86x93x100x72x41x75x39x65</p> <p>TUBO INFERIOR DO RADIADOR</p> <p>OPEL CORSA C (X01) VITA 1.3 CDTI (F08, F68) 06.2003/12.2009 51KW 70CV 1248CC Z 13 DT Y 13 DT 0035520 - OPEL CORSA C Caixa/parte traseira inclinada (X01) 1.3 CDTI 16V (F08, W5L) 07.2005/06.2006 51KW 69CV 1248CC Z 13 DT 0035AFC 0035115</p> <p>B780-18/29mm 49x90x150x138x95x86x93x100x72x41x75x39x65</p>
	<p>R221710 NO. 24457200 - 6818561</p> <p>TUBO DO PERMUTADOR DE CALOR DO AQUECIMENTO</p> <p>OPEL CORSA C (X01) 1.7 CDTI (F08, F68) (De 2003.06 Até 2009.12) 74kW 100cv 1686cm3 Hatchback -</p> <p>B330-18/22mm 36x66x125x36x70mm ch-d22x43x22x30mm</p>		<p>R221743 NO. 055351522 - 05656121 - 0656092 - 55578995 - 5656121 - 656092</p> <p>TUBO RESPIRO DO CARTER CAMBOTA</p> <p>OPEL CORSA C (X01) 1.0 (F08, F68) (09.2000 - 06.2003) 43kw 58cv 973cm3 Hatchback OPEL CORSA C (X01) 1.0 (F08, F68) (06.2003 - 12.2009) 44kw 60cv 998cm3 Hatchback OPEL CORSA C (X01) 1.2 Twinport (F08, F68) (07.2004 - 12.2009) 59kw 80cv 1229cm3 Hatchback OPEL CORSA C (X01) 1.4 (F08, F68) (09.2000 - 12.2009) 66kw 90cv 1389cm3 Hatchback OPEL CORSA C (X01) 1.4 Twinport (F08, F68) (06.2003 - 12.2009) 66...</p> <p>boca a boca 175mmd1-15mm d20h75-73</p>
	<p>R221747 NO. 1336267 - 9158673</p> <p>TUBO DO RADIADOR</p> <p>OPEL CORSA C (X01) 1.8 (F08, F68) (De 2000.09 Até 2009.12) 92kW 125cv 1796cm3 Hatchback -</p> <p>B430-38/39mm 60x73x120x127x100mm</p>		<p>R221748 NO. 5851946 - 93177469</p> <p>TUBO DA VALVULA REGULADORA DE VELOCIDADE</p> <p>OPEL CORSA C (X01) 1.3 CDTI (F08, F68) 06.2003/12.2009 51KW 70CV 1248CC Z 13 DT Y 13 DT 0035520</p> <p>B140-17/17mm 70x30x80x35mm</p>
	<p>R222707 NO. 1337521 - 9129152</p> <p>TUBO DE LIGAÇÃO TERMOSTATO Á BOMBA DE ÁGUA</p> <p>OPEL CORSA C (X01) 1.4 (F08, F68) (De 2000.09 Até 2009.12) 66kW 90cv 1389cm3 Hatchback -</p> <p>B156-28/36mm 61x75x37mm ch-d26x50x42mm</p>		<p>R222750 NO. 1337572 - 9128348</p> <p>TUBO SUPERIOR DO RADIADOR</p> <p>OPEL CORSA C (X01) 1.0 (F08, F68) 09.2000/06.2003 43KW 58CV 973CC Z 10 XE 0035394 - OPEL 1.0 (F08, F68) 06.2003/12.2009 44KW 60CV 998CC Z 10 XEP 0035519</p> <p>B195-d35/34mm 70-50-50-70mm</p>

	<p>R222751 NO. 1336227 - 9128347</p> <p>TUBO INFERIOR DO RADIADOR</p> <p>OPEL CORSA C (X01) 1.0 (F08, F68) 09.2000/06.2003 43KW 58CV 973CC Z 10 XE 0035394 - OPEL CORSA C (X01) 1.0 (F08, F68) 06.2003/12.2009 44KW 60CV 998CC Z 10 XEP 0035519</p> <p>B310-d40/34mm 40-100-180-90mm+ch1080-d20mm</p>		<p>R222752 NO. 1337573 - 9128354</p> <p>TUBO SUPERIOR DO RADIADOR</p> <p>OPEL CORSA C (X01) 1.2 (F08, F68) 09.2000/12.2009 55KW 75CV 1199CC Z 12 XE 0035395 - OPEL CORSA C (X01) 1.2 Twinport (F08, F68) 07.2004/12.2009 59KW 80CV 1229CC Z 12 XEP 0035534 - OPEL CORSA C (X01) 1.4 Twinport (F08, F68) 06.2003/12.2009 66KW 90CV 1364CC Z 14 XEP 0035521 - OPEL CORSA C Caixa/parte traseira inclinada (X01) 1.2 16V (F08, W5L) 09.2000/07.2003 55KW 75CV 1199CC Z 12 XE</p> <p>B170-d34/34mm 110-85mm</p>
	<p>R222753 NO. 1336233 - 6336101 - 9128353</p> <p>TUBO INFERIOR DO RADIADOR</p> <p>OPEL CORSA C (X01) 1.2 (F08, F68) 09.2000/12.2009 55KW 75CV 1199CC Z 12 XE 0035395 - OPEL CORSA C (X01) 1.2 Twinport (F08, F68) 07.2004/12.2009 59KW 80CV 1229CC Z 12 XEP 0035534 - OPEL CORSA C (X01) 1.4 Twinport (F08, F68) 06.2003/12.2009 66KW 90CV 1364CC Z 14 XEP 0035521 - OPEL CORSA C Caixa/parte traseira inclinada (X01) 1.2 (F08, W5L) 07.2005/06.2006 59KW 80CV 1229CC Z 12 XEP 0035AFE 0035117 - ...</p> <p>B310-d40/34mm 65-50-110-90-50mm+ch1080-d20mm</p>		<p>R222754 NO. 1337601</p> <p>TUBO SUPERIOR DO RADIADOR</p> <p>OPEL CORSA C (X01) 1.4 (F08, F68) 09.2000/12.2009 66KW 90CV 1389CC Z 14 XE 0035396</p> <p>B160-d32/28mm 70-80-80-70-70mm</p>
	<p>R222755 NO. 1336243 - 9128764</p> <p>TUBO INFERIOR DO RADIADOR</p> <p>OPEL CORSA C (X01) 1.4 (F08, F68) 09.2000/12.2009 66KW 90CV 1389CC Z 14 XE 0035396</p> <p>B470-d39/34mm 120-100-150-110-95mm</p>		<p>R222760 NO. 1337574 - 9128807</p> <p>TUBO SUPERIOR DO RADIADOR</p> <p>OPEL CORSA C (X01) 1.7 DI (F08, F68) 09.2000/12.2009 48KW 65CV 1686CC Y 17 DTL 0035416 - OPEL CORSA C (X01) 1.7 DTI (F08, F68) 09.2000/12.2009 55KW 75CV 1686CC Y 17 DT 0035397 - OPEL CORSA C Caixa/parte traseira inclinada (X01) 1.7 DI 16V (F08, W5L) 09.2000/07.2003 48KW 65CV 1686CC Y 17 DTL - OPEL CORSA C Caixa/parte traseira inclinada (X01) 1.7 DTI 16V (F08, W5L) 09.2000/07.2003 55KW 75CV 1686CC ...</p> <p>B300-d33/37mm 70-80-90-50-85mm</p>
	<p>R222761 NO. 50-70-30-30-60mm + ch-d20mm 90-140</p> <p>TUBO INFERIOR DO RADIADOR</p> <p>OPEL CORSA C (X01) 1.7 DI (F08, F68) 09.2000/12.2009 48KW 65CV 1686CC Y 17 DTL 0035416 - OPEL CORSA C (X01) 1.7 DTI (F08, F68) 09.2000/12.2009 55KW 75CV 1686CC Y 17 DT 0035397 - OPEL CORSA C Caixa/parte traseira inclinada (X01) 1.7 DI 16V (F08, W5L) 09.2000/07.2003 48KW 65CV 1686CC Y 17 DTL - OPEL CORSA C Caixa/parte traseira inclinada (X01) 1.7 DTI 16V (F08, W5L) 09.2000/07.2003 55KW 75CV 1686CC ...</p> <p>B220-d32/32mm 50-70-30-30-60mm + ch-d20mm 90-140-3</p>		<p>R222762 NO. 1336279 - 24434613</p> <p>TUBO LIGAÇÃO TERMOSTATO Á BOMBA DE AGUA</p> <p>OPEL CORSA C (X01) VITA 1.7 DI (F08, F68) 09.2000/12.2009 48KW 65CV 1686CC Y 17 DTL 0035416 - OPEL CORSA C (X01) VITA 1.7 DTI (F08, F68) 09.2000/12.2009 55KW 75CV 1686CC Y 17 DT 0035397 - OPEL CORSA C Caixa/parte traseira inclinada (X01) 1.7 DI 16V (F08, W5L) 09.2000/07.2003 48KW 65CV 1686CC Y 17 DTL - OPEL CORSA C Caixa/parte traseira inclinada (X01) 1.7 DTI 16V (F08, W5L) 09.2000/07.2003 55KW ...</p> <p>B315-6/6mm 45-80-50-20-80-35-60-50mm</p>
	<p>R222763 NO. 09202288 - 5860742 - 9202288</p> <p>TUBO DO AR SOBREALIMENTAÇÃO</p> <p>OPEL CORSA C (X01) VITA 1.7 CDTI (F08, F68) 06.2003/12.2009 74KW 100CV 1686CC Z 17 DTH 0035522 - OPEL CORSA C (X01) VITA 1.7 DTI (F08, F68) 09.2000/12.2009 55KW 75CV 1686CC Y 17 DT 0035397 - OPEL CORSA C Caixa/parte traseira inclinada (X01) 1.7 DTI 16V (F08, W5L) 09.2000/07.2003 55KW 75CV 1686CC Y 17 DT</p> <p>B132-35/35mm 180-65-180mm</p>		<p>R222784 NO. 1302604 - 24406722</p> <p>TUBO DO AR SOBREALIMENTAÇÃO</p> <p>OPEL CORSA C (X01) 1.7 DI (F08, F68) (De 2000.09 Até 2009.12) 48KW 65cv 1686cm3 Hatchback - OPEL CORSA C (X01) 1.7 DTI (F08, F68) (De 2000.09 Até 2009.12) 55KW 75cv 1686cm3 Hatchback - OPEL CORSA C Caixa (X01) 1.7 DI 16V (F08, W5L) (De 2000.09 Até 2003.07) 48KW 65cv 1686cm3 Caixa - OPEL CORSA C Caixa (X01) 1.7 DTI 16V (F08, W5L) (De 2000.09 Até 2003.07) 55KW 75cv 1686cm3 Caixa - ...</p> <p>B100-33/39mm 138x52x150mm</p>
	<p>R222786 NO. 1337453 - 1337455</p> <p>TUBO DE LIGAÇÃO AO DEPÓSITO REFRIGERAÇÃO</p> <p>OPEL CORSA C (X01) VITA 1.0 (F08, F68) 09.2000/06.2003 43KW 58CV 973CC Z 10 XE 0035394 - OPEL CORSA C (X01) VITA 1.0 (F08, F68) 06.2003/12.2009 44KW 60CV 998CC Z 10 XEP 0035519 - OPEL CORSA C (X01) VITA 1.2 (F08, F68) 09.2000/12.2009 55KW 75CV 1199CC Z 12 XE 0035395 - OPEL CORSA C (X01) VITA 1.2 Twinport (F08, F68) 07.2004/12.2009 59KW 80CV 1229CC Z 12 XEP 0035534 - OPEL CORSA C Caixa/part...</p> <p>B185-14/14mm 147x27x57mm</p>		<p>R222788 NO. 24460993 - 5860818</p> <p>TUBO DO AR SOBREALIMENTAÇÃO</p> <p>OPEL CORSA C (X01) 1.3 CDTI (F08, F68) (De 2003.06 Até 2009.12) 51kW 70cv 1248cm3 Hatchback - OPEL CORSA C Caixa (X01) 1.3 CDTI 16V (F08, W5L) (De 2005.07 Até 2006.06) 51kW 69cv 1248cm3 Caixa -</p> <p>B120-30/36mm 124x52x90mm</p>
	<p>R222789 NO. 24460994 - 5835847</p> <p>TUBO DO AR SOBREALIMENTAÇÃO</p> <p>OPEL CORSA C (X01) 1.3 CDTI (F08, F68) (De 2003.06 Até 2009.12) 51kW 70cv 1248cm3 Hatchback - OPEL CORSA C Caixa (X01) 1.3 CDTI 16V (F08, W5L) (De 2005.07 Até 2006.06) 51kW 69cv 1248cm3 Caixa -</p> <p>B445-40/49mm 195x80x150x65mm</p>		<p>R222790 NO. 13157692 - 6818557</p> <p>TUBO DO PERMUTADOR DO CALOR AO AQUECIMENTO</p> <p>OPEL CORSA C (X01) 1.3 CDTI (F08, F68) (De 2003.06 Até 2009.12) 51kW 70cv 1248cm3 Hatchback - OPEL CORSA C Caixa (X01) 1.3 CDTI 16V (F08, W5L) (De 2005.07 Até 2006.06) 51kW 69cv 1248cm3 Caixa -</p> <p>B230-19/19mm 38x40x72x49x58mm</p>
	<p>R222791 NO. 6336108</p> <p>TUBO DE LIGAÇÃO AO TERMOSTATO</p> <p>OPEL CORSA C (X01) 1.3 CDTI (F08, F68) (De 2003.06 Até 2009.12) 51kW 70cv 1248cm3 Hatchback - OPEL CORSA C Caixa (X01) 1.3 CDTI 16V (F08, W5L) (De 2005.07 Até 2006.06) 51kW 69cv 1248cm3 Caixa -</p> <p>B350-7/8mm 30x35x94x30x127x53x45mm</p>		<p>R222793 NO. 6818564</p> <p>TUBO DO PERMUTADOR DE CALOR DO AQUECIMENTO</p> <p>OPEL CORSA C (X01) 1.3 CDTI (F08, F68) (De 2003.06 Até 2009.12) 51kW 70cv 1248cm3 Hatchback - OPEL CORSA C Caixa (X01) 1.3 CDTI 16V (F08, W5L) (De 2005.07 Até 2006.06) 51kW 69cv 1248cm3 Caixa -</p> <p>B330-19/20mm 50x41x45x68x156x31x48</p>

	<p>R222811 NO. 650872</p> <p>TUBO DE LIGAÇÃO AO TERMOSTATO</p> <p>OPEL CORSA C (X01) 1.7 DI (F08, F68) (De 2000.09 Até 2009.12) 48kW 65cv 1686cm3 Hatchback -</p> <p>B57-15/15mm 50x22x50mm</p>		<p>R222827 NO. 6336084 - 97300149</p> <p>TUBO LIGAÇÃO TERMOSTATO</p> <p>OPEL CORSA C (X01) 1.7 CDTI (F08 - F68) (De 06-2003 Até 12-2009) 74kW 100CV 1686cc Hatchback OPEL CORSA C Caixa (X01) 1.7 DTI (F08 - W5L) (De 08-2003 Até ...) 74kW 101CV 1686cc Caixa</p> <p>B115-15/15mm 39-45-39mm</p>
	<p>R222828 NO. 97351101</p> <p>TUBO DO RADIADOR</p> <p>OPEL CORSA C (X01) 1.7 DI (F08 - F68) (De 09-2000 Até 12-2009) 48kW 65CV 1686cc Hatchback OPEL CORSA C (X01) 1.7 DTI (F08 - F68) (De 09-2000 Até 12-2009) 55kW 75CV 1686cc Hatchback OPEL CORSA C (X01) 1.7 CDTI (F08 - F68) (De 06-2003 Até 12-2009) 74kW 100CV 1686cc Hatchback OPEL CORSA C Caixa (X01) 1.7 DI 16V (F08 - W5L) (De 09-2000 Até ...) 48kW 65CV 1686cc Caixa OPEL CORSA C Caixa (X01) 1.7 DTI 1...</p> <p>B165-13/13mm 34-41-47-51mm</p>		<p>R222848 NO. 55559258 - 555592582 - 58605472</p> <p>TUBO DO AR SOBREALIMENTAÇÃO</p> <p>OPEL CORSA C (X01) 1.7 DTI (F08, F68) (De 2000.09 Até 2009.12) 55kW 75cv 1686cm3 Hatchback - OPEL CORSA C Caixa (X01) 1.7 DTI 16V (F08, W5L) (De 2000.09 Até 2003.07) 55kW 75cv 1686cm3 Caixa -</p> <p>B220-24/36mm 61x27x170mm</p>
	<p>R222848 NO. 55559258 - 555592582 - 58605472</p> <p>TUBO DO AR SOBREALIMENTAÇÃO</p> <p>OPEL CORSA D (S07) 1.3 CDTI (L08, L68) (De 2006.07 Até 2011.06) 66kW 90cv 1248cm3 Hatchback - OPEL CORSA D Van (S07) 1.3 CDTI (L08) (De 2006.07 Até 2010.06) 66kW 90cv 1248cm3 Caixa -</p> <p>B220-24/36mm 61x27x170mm</p>		<p>R222857 NO. 13157694 - 6818559</p> <p>TUBO DO PERMUTADOR DO CALOR DO AQUECIMENTO</p> <p>OPEL CORSA C (X01) 1.3 CDTI (F08, F68) (De 2003.06 Até 2009.12) 51kW 70cv 1248cm3 Hatchback - OPEL CORSA C Caixa (X01) 1.7 DTI 16V (F08, W5L) (De 2005.07 Até 2006.06) 51kW 69cv 1248cm3 Caixa -</p> <p>B213-19/21mm 46x51x65x66mm</p>
	<p>R222870 NO. 13157692 - 13157694 - 6818557 - 6818559</p> <p>TUBO DO PERMUTADOR DE CALOR AO AQUECIMENTO</p> <p>OPEL CORSA C (X01) 1.3 CDTI (F08, F68) 06.2003/12.2009 51KW 70CV 1248CC Z 13 DT Y 13 DT 0035520 - OPEL CORSA C Caixa/parte traseira inclinada (X01) 1.3 CDTI 16V (F08, W5L) 07.2005/06.2006 51KW 69CV 1248CC Z 13 DT 0035AFC 0035115</p> <p>B215-19/24mm(x2) 44-46-65-70mm</p>		<p>R224306 NO. 24458346 - 6336109</p> <p>TUBO DO AQUECIMENTO</p> <p>OPEL CORSA C (X01) 1.7 DTI (F08, F68) (De 2000.09 Até 2009.12) 55kW 75cv 1686cm3 Hatchback -</p> <p>B380-7/7mm 36x55x96x33x33x78x42x32mm</p>
	<p>R224316 NO. 24423514 - 6818533</p> <p>TUBO DO PERMUTADOR DE CALOR DO AQUECIMENTO</p> <p>OPEL CORSA C (X01) 1.7 DI (F08, F68) (De 2000.09 Até 2009.12) 48kW 65cv 1686cm3 Hatchback - OPEL CORSA C (X01) 1.7 DTI (F08, F68) (De 2000.09 Até 2009.12) 55kW 75cv 1686cm3 Hatchback - OPEL CORSA C Caixa (X01) 1.7 DTI 16V (F08, W5L) (De 2000.09 Até 2003.07) 55kW 75cv 1686cm3 Caixa -</p> <p>B335-17/18mm 129x125x76mm ch-d28x80mm</p>		<p>R224317 NO. 24457201 - 6818562</p> <p>TUBO DO PERMUTADOR DO CALOR DO AQUECIMENTO</p> <p>OPEL CORSA C (X01) VITA 1.7 CDTI (F08, F68) 06.2003/12.2009 74KW 100CV 1686CC Z 17 DTH 0035522</p> <p>B290-19/21mm 70x115x51x75mm</p>
	<p>R224318 NO. 24423511 - 6818531</p> <p>TUBO LIGAÇÃO PERMUTADOR AQUECIMENTO</p> <p>OPEL CORSA C (X01) VITA 1.7 DI (F08, F68) 09.2000/12.2009 48KW 65CV 1686CC Y 17 DTL 0035416 - OPEL CORSA C (X01) VITA 1.7 DTI (F08, F68) 09.2000/12.2009 55KW 75CV 1686CC Y 17 DT 0035397 - OPEL CORSA C Caixa/parte traseira inclinada (X01) 1.7 DTI 16V (F08, W5L) 09.2000/07.2003 55KW 75CV 1686CC Y 17 DT</p> <p>B260-19-27mm 79-150-38mm</p>		<p>R225254 NO. 1337233 - 97086694</p> <p>TUBO LIGAÇÃO TERMOSTATO</p> <p>OPEL CORSA C (X01) 1.7 DI (F08 - F68) (De 09-2000 Até 12-2009) 48kW 65CV 1686cc Hatchback OPEL CORSA C (X01) 1.7 DTI (F08 - F68) (De 09-2000 Até 12-2009) 55kW 75CV 1686cc Hatchback</p> <p>B78-15-15mm 48-47mm</p>
	<p>R225266 NO. 13101637 - 5860817</p> <p>TUBO DO AR SOBREALIMENTAÇÃO</p> <p>OPEL CORSA C (X01) 1.7 CDTI (F08, F68) (De 06.2003 Até 12.2009) 74kW 100cv 1686cm3 Hatchback - OPEL CORSA C Caixa/parte traseira inclinada (X01) 1.7 DI 16V (F08, W5L) (De 09.2000 Até 07.2003) 48kW 65cv 1686cm3 Caixa/parte traseira inclinada - OPEL CORSA C Caixa/parte traseira inclinada (X01) 1.7 DTI 16V (F08, W5L) (De 09.2000 Até 07.2003) 55kW 75cv 1686cm3 Caixa/parte traseira inclinada -</p> <p>B105-35/36mm 44x121x51x97mm</p>		<p>R225287 NO. 13101638 - 5835844</p> <p>TUBO DO AR SOBREALIMENTAÇÃO</p> <p>OPEL CORSA C (X01) 1.7 CDTI (F08, F68) (De 2003.06 Até 2009.12) 74kW 100cv 1686cm3 Hatchback - OPEL CORSA C Caixa (X01) 1.7 CDTI (F08, W5L) (De 2003.08 Até 2012.12) 74kW 101cv 1686cm3 Caixa -</p> <p>B480-50/40mm 52x126x92x157x90mm</p>
	<p>R225298 NO. 5835870 - 93329873</p> <p>TUBO DO AR SOBREALIMENTAÇÃO</p> <p>OPEL CORSA C (X01) 1.7 CDTI (F08, F68) (06.2003 - 12.2009) 74kw 100cv 1686cm3 Hatchback</p> <p>B545-d38/d39mm 71-66-150-74-108-87mm</p>		<p>R225612 NO. 63-108-57-65mm 63-35-140-40-79mm c</p> <p>TUBO DO PERMUTADOR DO AQUECIMENTO</p> <p>OPEL CORSA C (X01) VITA 1.7 CDTI (F08, F68) 06.2003/12.2009 74KW 100CV 1686CC Z 17 DTH 0035522</p> <p>B305-20/24mm B333-18/20mm 63-108-57-65mm 63-35-140-40-79mm ch-d21x52</p>

	<p>R225612 NO. 63-108-57-65mm 63-35-140-40-79mm c</p> <p>TUBO DO PERMUTADOR DO AQUECIMENTO</p> <p>OPEL MERIVA A Veículo multiuso (X03) 1.7 CDTi (E75) 09.2003/05.2010 74KW 100CV 1686CC Z 17 DT Z 17 DTH 0035AAS 0035516</p>		<p>RT08937 NO. 5562230 - 9191262</p> <p>TUBO DE TRAVÃO FRENTE LH-RH</p> <p>OPEL CORSA C 1.0 (APÓS 09-2000) - 1.2 (APÓS 09-2000) - 1.2 16V (APÓS 09-2000) - 1.3 CDTi (APÓS 06-2003) - 1.4 (APÓS 09-2000) - 1.7 CDTi (APÓS 06-2003) - 1.7 Di (APÓS 09-2000) - 1.7 DTi (APÓS 09-2000) - 1.7 DTi 16V (APÓS 09-2000)</p>
	<p>RT08938 NO. 562302 - 9191263</p> <p>TUBO DE TRAVÃO TRÁS LH</p> <p>OPEL CORSA C (APÓS 2000)</p>		<p>S1441 NO. 13138151 - 13138151-24430103 - 24430103 - 352310 - 352320</p> <p>SILENT-BLOC DO BRAÇO DA SUSPENSÃO DA FRENTE</p> <p>OPEL CORSA C 1.0 - 1.2 - 1.4 - 1.7D - 1.7DTi - 1.8</p>
	<p>S1595 NO. 50511650 - 50521486 - 51783056 - 51783057</p> <p>SILENT-BLOC BRAÇO SUPERIOR FRENTE</p> <p>OPEL CORSA C Caixa (F08, W5L) 1.2 (A Partir de 07.05) 80cv 1229cc Caixa</p>		<p>T1019 NO. 0350104 - 24403523 - 350104</p> <p>BATENTE DA BARRA ESTABILIZADORA FRENTE</p> <p>OPEL CORSA C 1.0 - 1.2 (APÓS 2000) (BARRA (15mm))</p>
	<p>U0314 NO. 0424761</p> <p>ANILHA DA SUSPENSÃO DAS MOLAS DE TRÁS INFERIOR</p> <p>OPEL CORSA C (X01) 1.0 (F08, F68) (09.2000 - 06.2003) 43kw 58cv 973cm3 Hatchback OPEL CORSA C (X01) 1.0 (F08, F68) (06.2003 - 12.2009) 44kw 60cv 998cm3 Hatchback OPEL CORSA C (X01) 1.2 (F08, F68) (09.2000 - 12.2009) 55kw 75cv 1199cm3 Hatchback OPEL CORSA C (X01) 1.2 Twinport (F08, F68) (07.2004 - 12.2009) 59kw 80cv 1229cm3 Hatchback OPEL CORSA C (X01) 1.3 CDTi (F08, F68) (06.2003 - 12.2009) 51kw 7...</p>		<p>UAP81292 NO. 0821038 - 0821074 - 0821437 - 0821675 - 4708869 - 4809347 - 821038 - 821074 - 821437 - 821675</p> <p>ANILHA PROTEÇÃO TÉRMICA INJECTORES</p> <p>OPEL CORSA C (X01) 1.3 CDTi (F08 - F68) (De 06-2003 Até 12-2009) 51kW 70CV 1248cc Hatchback</p>
	<p>UAP81292 NO. 0821038 - 0821074 - 0821437 - 0821675 - 4708869 - 4809347 - 821038 - 821074 - 821437 - 821675</p> <p>ANILHA PROTEÇÃO TÉRMICA INJECTORES</p> <p>OPEL CORSA C (X01) 1.3 CDTi (F08 - F68) (De 06-2003 Até 12-2009) 51kW 70CV 1248cc Hatchback</p>		<p>UMB84011 NO. 031126</p> <p>TAMPÃO BLOCO MOTOR</p> <p>OPEL CORSA C (X01) 1.4 (F08 - F68) (De 09-2000 Até 12-2009) 66kW 90CV 1389cc Hatchback</p>
	<p>UMB84011L NO. 11062402 - 2060675</p> <p>TAMPÃO BLOCO DE MOTOR (RELAS)</p> <p>OPEL CORSA C (X01) 1.4 (F08 - F68) (De 09-2000 Até 12-2009) 66kW 90CV 1389cc Hatchback</p>		<p>UMB84019 NO. 2060668</p> <p>TAMPÃO BLOCO MOTOR</p> <p>OPEL CORSA C (X01) 1.4 (F08 - F68) (De 09-2000 Até 12-2009) 66kW 90CV 1389cc Hatchback OPEL CORSA C (X01) 1.8 (F08 - F68) (De 09-2000 Até 12-2009) 92kW 125CV 1796cc Hatchback</p>
	<p>UMB84019L NO. 2060668</p> <p>TAMPÃO BLOCO DE MOTOR (RELAS)</p> <p>OPEL CORSA C (X01) 1.4 (F08 - F68) (De 09-2000 Até 12-2009) 66kW 90CV 1389cc Hatchback OPEL CORSA C (X01) 1.8 (F08 - F68) (De 09-2000 Até 12-2009) 92kW 125CV 1796cc Hatchback</p>		<p>UMB84021 NO. 2060673</p> <p>TAMPÃO BLOCO MOTOR</p> <p>OPEL CORSA C (X01) 1.4 (F08 - F68) - OPEL CORSA C (X01) 1.8 (F08, F68)</p>
	<p>UMB84021L NO. 2060673</p> <p>TAMPÃO BLOCO DE MOTOR (RELAS)</p> <p>OPEL CORSA C (X01) 1.4 (F08 - F68) - OPEL CORSA C (X01) 1.8 (F08, F68)</p>		<p>UMB84029 NO. 2060946</p> <p>TAMPÃO BLOCO MOTOR</p> <p>OPEL CORSA C (X01) 1.4 (F08, F68) (09.00 A 12.09) 90cv 1389cc Hatchback - OPEL CORSA C (X01) 1.8 (F08, F68) (09.00 A 12.09) 125cv 1796cc Hatchback</p>















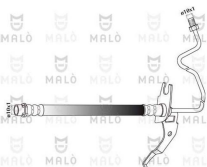

	UMV25431 NO. 5738741 MANETE PUNHO TOPO ALAVANCA MUDANÇAS 5 VELOCIDADES F33MM OPEL CORSA C (X01) VITA 1.0 (F08, F68) 09.2000/06.2003 43KW 58CV 973CC Z 10 XE 0035394 - OPEL CORSA C (X01) VITA 1.0 (F08, F68) 06.2003/12.2009 44KW 60CV 998CC Z 10 XEP 0035519 - OPEL CORSA C (X01) VITA 1.2 (F08, F68) 09.2000/12.2009 55KW 75CV 1199CC Z 12 XE 0035395 - OPEL CORSA C (X01) VITA 1.2 Twinport (F08, F68) 07.2004/12.2009 59KW 80CV 1229CC Z 12 XEP 0035534 - OPEL CORSA C (X01) V1...		UMV26809 NO. 5738737 - 90540619 - 9200972 MANETE PUNHO TOPO ALAVANCA MUDANÇAS 5 VELOCIDADES F32MM OPEL CORSA C (X01): 1.0 (F08, F68) 09.2000/06.2003 43KW 58CV 973CC - OPEL CORSA C (X01): 1.0 (F08, F68) 06.2003/12.2009 44KW 60CV 998CC - OPEL CORSA C (X01): 1.2 (F08, F68) 09.2000/12.2009 55KW 75CV 1199CC - OPEL CORSA C (X01): 1.2 Twinport (F08, F68) 07.2004/12.2009 59KW 80CV 1229CC - OPEL CORSA C (X01): 1.4 Twinport (F08, F68) 06.2003/12.2009 66KW 90CV 1364CC - OPEL CORSA C (X01): 1.4 (F08, F68)...
	UTR0800 NO. 1304240 - 1304654 - 1304659 - 1304660 - 1304661 - 1304665 - 1304666 - 1304667 - 1304853 - 90352470 ... TAMPÃO RESERVATÓRIO LIQUIDO REFRIGERAÇÃO OPEL CORSA C 1.0 (09.00 A 06.03) 58cv 973cc Hatchback - OPEL CORSA C 1.2 (09.00 A 12.09) 75cv 1199cc Hatchback - OPEL CORSA C 1.2 Twinport (07.04 A 12.09) 80cv 1229cc Hatchback - OPEL CORSA C 1.4 (09.00 A 12.09) 90cv 1389cc Hatchback - OPEL CORSA C 1.8 (09.00 A 12.09) 125cv 1796cc Hatchback - OPEL CORSA C 1.3 CDTI (06.03 A 12.09) 70cv 1248cc Hatchback - OPEL CORSA C 1.7 DI (09.00 A 12...		UTR0820 NO. 90352470 - 90409256 - 90409257 - 9041032690497472 - 90467473 TAMPÃO RESERVATÓRIO LIQUIDO REFRIGERAÇÃO OPEL CORSA C (F08, F68) 1.0 (09.00 A 06.03) 58cv 973cc Hatchback - OPEL CORSA C (F08, F68) 1.0 (06.03 A 12.09) 60cv 998cc Hatchback - OPEL CORSA C (F08, F68) 1.2 (09.00 A 12.09) 75cv 1199cc Hatchback - OPEL CORSA C (F08, F68) 1.2 Twinport (07.04 A 12.09) 80cv 1229cc Hatchback - OPEL CORSA C (F08, F68) 1.4 Twinport (06.03 A 12.09) 90cc 1364 - Hatchback OPEL CORSA C (F08, F68) 1.4 (09.00 A 12...
	UTR1201 NO. 1450591 - 90563741 TAMPÃO RESERVATÓRIO LAVA VIDROS OPEL CORSA C (X01): 1.0 (F08, F68) 06.2003/12.2009 44KW 60CV 998CC - OPEL CORSA C (X01): 1.2 Twinport (F08, F68) 07.2004/12.2009 59KW 80CV 1229CC - OPEL CORSA C (X01): 1.4 Twinport (F08, F68) 06.2003/12.2009 66KW 90CV 1364CC - OPEL CORSA C (X01): 1.8 (F08, F68) 09.2000/12.2009 92KW 125CV 1796CC - OPEL CORSA C (X01): 1.3 CDTI (F08, F68) 06.2003/12.2009 51KW 70CV 1248CC - OPEL CORSA C (X01): 1.7 DI ...		UTR1300 NO. 00650090 - 05650831 TAMPÃO RESERVATÓRIO DO OLEO OPEL CORSA C (X01) 1.0 (F08 - F68) (De 06-2003 Até 12-2009) 44KW 60CV 998cc Hatchback OPEL CORSA C (X01) 1.2 Twinport (F08 - F68) (De 07-2004 Até 12-2009) 59KW 80CV 1229cc Hatchback OPEL CORSA C (X01) 1.4 Twinport (F08 - F68) (De 06-2003 Até 12-2009) 66KW 90CV 1364cc Hatchback OPEL CORSA C (X01) 1.7 DI (F08 - F68) (De 09-2000 Até 12-2009) 48KW 65CV 1686cc Hatchback OPEL CORSA C (X01) 1.7 DTI (F08 ...
	UTR1305 NO. 0650089 - 650089 TAMPÃO DO RESERVATÓRIO ÓLEO OPEL CORSA C (X01) 1.0 (F08, F68) (09.2000 -06.2003) 43kw 58cv 973cm3 Hatchback OPEL CORSA C (X01) 1.0 (F08, F68) (06.2003 -12.2009) 44kw 60cv 998cm3 Hatchback OPEL CORSA C (X01) 1.2 (F08, F68) (09.2000 -12.2009) 55kw 75cv 1199cm3 Hatchback OPEL CORSA C (X01) 1.2 Twinport (F08, F68) (07.2004 -12.2009) 59kw 80cv 1229cm3 Hatchback OPEL CORSA C (X01) 1.3 CDTI (F08, F68) (06.2003 -12.2009) 51kw 70cv 1...		UTR1305 NO. 0650089 - 650089 TAMPÃO DO RESERVATÓRIO ÓLEO OPEL CORSA C Caixa/parte traseira inclinada (X01) 1.2 (F08, W5L) (07.2005 -06.2006) 59kw 80cv 1229cm3 Caixa/parte traseira inclinada OPEL CORSA C Caixa/parte traseira inclinada (X01) 1.2 16V (F08, W5L) (09.2000 - 07.2003) 55kw 75cv 1199cm3 Caixa/parte traseira inclinada OPEL CORSA C Caixa/parte traseira inclinada (X01) 1.3 CDTI 16V (F08, W5L) (07.2005-06.2006) 51kw 69cv 1248cm3 Caixa/parte traseira...
	UTR1404 NO. 0808211 - 09117533 - 808211 TAMPÃO DEPÓSITO COMBUSTIVEL OPEL CORSA C (X01) 1.0 (F08, F68) (De 09.2000 Até 06.2003) 43kW 58cv 973cm3 Hatchback - OPEL CORSA C (X01) 1.0 (F08, F68) (De 06.2003 Até 12.2009) 44kW 60cv 998cm3 Hatchback - OPEL CORSA C (X01) 1.2 (F08, F68) (De 09.2000 Até 12.2009) 55kW 75cv 1199cm3 Hatchback - OPEL CORSA C (X01) 1.2 Twinport (F08, F68) (De 07.2004 Até 12.2009) 59kW 80cv 1229cm3 Hatchback - OPEL CORSA C (X01) 1.3 CDTI (F08, F68)...		UTV83011 NO. 0652475 - 09275631 - 652475 - 652491 - 90409376 - 9275631 - N90288901 TAMPÃO VEDAÇÃO BUJÃO OPEL CORSA C (X01) 1.4 (F08 - F68) (De 09-2000 Até 12-2009) 66kW 90CV 1389cc Hatchback
	UTV83019 NO. 0652315 - 0652477 - 652315 - 652477 - 90502556 - 96023264 TAMPÃO VEDAÇÃO BUJÃO OPEL CORSA C (X01) 1.0 (F08 - F68) (De 09-2000 Até 06-2003) 43kW 58CV 973cc Hatchback OPEL CORSA C (X01) 1.0 (F08 - F68) (De 06-2003 Até 12-2009) 44kW 60CV 998cc Hatchback OPEL CORSA C (X01) 1.2 (F08 - F68) (De 09-2000 Até 12-2009) 55kW 75CV 1199cc Hatchback OPEL CORSA C (X01) 1.2 Twinport (F08 - F68) (De 07-2004 Até 12-2009) 59kW 80CV 1229cc Hatchback OPEL CORSA C (X01) 1.4 Twinport (F08 - F68) (...)		W5054 NO. 0614150 - 5614438 - 614150 - 93177317 - 93194443 POLIE DA CAMBOTA (6 PISTAS) OPEL CORSA C 1.3 CDTi - Mtr Z13DT (70CV) (APÓS 06-2003)
	W5080 NO. 5614441 - 5614442 - 97229044 - 97353964 POLIE DA CAMBOTA (6 PISTAS) OPEL CORSA C (X01) 1.7 CDTI (F08, F68) 06.2003/12.2009 74KW 100CV 1686CC Z 17 DTH 0035522 - OPEL CORSA C Caixa/parte traseira inclinada (X01) 1.7 CDTI (F08, W5L) 08.2003/12.2012 74KW 101CV 1686CC Z 17 DTH 0035AFD OPEL CORSA C COMBO Caixa/monovolume 1.7 CDTI 16V desde 12.2004 74KW 101CV 1686CC Z 17 DTH 0035AEY 0035098 0035AMT - OPEL CORSA C COMBO Tour 1.7 CDTI 16V 07.2004/12.2011 74KW 101CV 1686CC ...		W5082 NO. 0614426 - 5614444 - 614426 - 97251975 - 97361525 POLIE DA CAMBOTA (6 PISTAS) OPEL CORSA C (X01) 1.7 DI (F08, F68) 09.2000/12.2009 48KW 65CV 1686CC Y 17 DTL 0035416 - OPEL CORSA C (X01) 1.7 DTI (F08, F68) 09.2000/12.2009 55KW 75CV 1686CC - Y 17 DT 0035397 - OPEL CORSA C Caixa/parte traseira inclinada (X01) 1.7 DI 16V (F08, W5L) 09.2000/07.2003 48KW 65CV 1686CC Y 17 DTL - OPEL CORSA C Caixa/parte traseira inclinada (X01) 1.7 DTI 16V (F08, W5L) 09.2000/07.2003 55KW 75CV 1686CC...
	W5107 NO. 5614425 - 5614431 - 9129209 POLIE DA CAMBOTA (5 PISTAS) OPEL CORSA C 1.4 Z 14 XE 90CV (APÓS 09-2000) - 1.8 Z 18 XE 125CV (APÓS 09-2000)		W5201 NO. 5614423 - 90572867 POLIE DA CAMBOTA (5 PISTAS) OPEL CORSA C (X01): 1.0 (F08, F68) 09.2000/06.2003 43KW 58CV 973CC - OPEL CORSA C (X01): 1.0 (F08, F68) 06.2003/12.2009 44KW 60CV 998CC - OPEL CORSA C (X01): 1.2 (F08, F68) 09.2000/12.2009 55KW 75CV 1199CC - OPEL CORSA C (X01): 1.2 Twinport (F08, F68) 07.2004/12.2009 59KW 80CV 1229CC - OPEL CORSA C (X01): 1.4 Twinport (F08, F68) 06.2003/12.2009 66KW 90CV 1364CC

	Y3212	NO. 1008501 - 1008504 - 4709077		
	PARAFUSO PERNO RODA CHAVE 17 M12X1,50X48MM (BASE CONICA PARA JANTES AÇO E LIGA LEVE) OPEL CORSA C (X01) 1.0 (F08, F68) (09.2000 - 06.2003) 43kw 58cv 973cm3 Hatchback OPEL CORSA C (X01) 1.0 (F08, F68) (06.2003 - 12.2009) 44kw 60cv 998cm3 Hatchback OPEL CORSA C (X01) 1.2 (F08, F68) (09.2000 - 12.2009) 55kw 75cv 1199cm3 Hatchback OPEL CORSA C (X01) 1.2 Twinport (F08, F68) (07.2004 - 12.2009) 59kw 80cv 1229cm3 Hatchback OPEL CORSA C (X01) 1.3 CDTI (F08, F68) (06.2003 - 12.2009) 51 70 ...			
	C48mm (Ch-17mm)	M12x1,50x22mm		

OPEL CORSA D - ADAM

	A2051	NO. 344963 - 55701796		A2051	NO. 344963 - 55701796
	APOIO PRATO AMORTECEDOR FRENTE (GASTA 2 UNIDADES) OPEL ADAM (M13): 1.2 10.2012/02.2019 51KW 69CV 1229CC - OPEL ADAM (M13): 1.4 10.2012/02.2019 64KW 87CV 1398CC - OPEL ADAM (M13): 1.4 10.2012/02.2019 74KW 101CV 1398CC			APOIO PRATO AMORTECEDOR FRENTE (GASTA 2 UNIDADES) OPEL CORSA D (S07): 1.0 (L08, L68) 07.2006/12.2010 44KW 60CV 998CC - OPEL CORSA D (S07): 1.0 (L08, L68) 12.2009/08.2014 48KW 65CV 998CC - OPEL CORSA D (S07): 1.2 (L08, L68) 12.2009/08.2014 51KW 69CV 1229CC - OPEL CORSA D (S07): 1.2 (L08, L68) 07.2006/08.2014 59KW 80CV 1229CC - OPEL CORSA D (S07): 1.2 LPG (L08, L68) 08.2006/08.2014 59KW 80CV 1229CC - OPEL CORSA D (S07): 1.2 LPG (L08, L68) 06.2011/0...	
	d68x10mm	1f-d12mm		d68x10mm	1f-d12mm
	A2301	NO. 0684180 - 0684181 - 09227878 - 09227879 - 13125209 - 5684168 - 5684170		A2441	NO. 0344653 - 55703313
	APOIO DO MOTOR LADO DIREITO OPEL CORSA D (S07) 1.2 LPG (L08, L68) (De 2006.08 Até 2014.08) 59kW 80cv 1229cm3 Hatchback -			APOIO SUPORTE AMORTECEDOR FRENTE (GASTA 2 UNIDADES) OPEL ADAM (M13) 1.0 (De 07.2014 Até 11.2018) 66kW 90cv 999cm3 Hatchback - OPEL ADAM (M13) 1.0 (De 07.2014 Até 11.2018) 85kW 115cv 999cm3 Hatchback - OPEL ADAM (M13) 1.2 (De 10.2012 Até 02.2019) 51kW 69cv 1229cm3 Hatchback - OPEL ADAM (M13) 1.4 (De 10.2012 Até 02.2019) 64kW 87cv 1398cm3 Hatchback - OPEL ADAM (M13) 1.4 (De 10.2012 Até 02.2019) 74kW 101cv 1398cm3 Hatchback - OPEL ADAM (M13) 1.4 LPG (...	
	175x117x100mm	2f-d11mm 2f-d17mm		d103x31mm	1f-d12mm
	A2441	NO. 0344653 - 55703313		B450	NO. 164987
	APOIO SUPORTE AMORTECEDOR FRENTE (GASTA 2 UNIDADES) OPEL CORSA D (S07) 1.0 (L08, L68) (De 07.2006 Até 12.2010) 44kW 60cv 998cm3 Hatchback - OPEL CORSA D (S07) 1.0 (L08, L68) (De 12.2009 Até 08.2014) 48kW 65cv 998cm3 Hatchback - OPEL CORSA D (S07) 1.2 (L08, L68) (De 12.2009 Até 08.2014) 51kW 69cv 1229cm3 Hatchback - OPEL CORSA D (S07) 1.2 (L08, L68) (De 07.2006 Até 08.2014) 59kW 80cv 1229cm3 Hatchback - OPEL CORSA D (S07) 1.2 (L08, L68) (De 12.2009 ...			ABRAÇADEIRA DO REVESTIMENTO DO HABITÁCULO OPEL CORSA D Caixa/parte traseira inclinada (S07) 1.0 (L08) (08.2006 - 08.2014) 44kw 60cv 998cm3 Caixa/parte traseira inclinada OPEL CORSA D Caixa/parte traseira inclinada (S07) 1.0 (L08) (01.2010 - 08.2014) 48kw 65cv 998cm3 Caixa/parte traseira inclinada OPEL CORSA D Caixa/parte traseira inclinada (S07) 1.2 (L08) (01.2010 - 08.2014) 51kw 69cv 1229cm3 Caixa/parte traseira inclinada OPEL CORSA D C...	
	d103x31mm	1f-d12mm		245x38x11mm	
	BE22	NO. 4401363 - 4501620 - 860151		C0233	NO. 1160724 - 90054143
	ABRAÇADEIRA ESCAPE OPEL CORSA D (S07): 1.3 CDTI (L08, L68) 07.2006/08.2014 55KW 75CV 1248CC - OPEL CORSA D (S07): 1.3 CDTI (L08, L68) 06.2009/08.2014 70KW 95CV 1248CC - OPEL CORSA D Caixa/parte traseira inclinada (S07): 1.3 CDTI (L08) 07.2006/08.2014 55KW 75CV 1248CC - OPEL CORSA D Caixa/parte traseira inclinada (S07): 1.3 CDTI (L08) 11.2009/08.2014 70KW 95CV 1248CC			BOTÃO AFINAÇÃO CAPÔT OPEL ADAM 1.2 (A Partir de 10.12) 69cv 1229cc Hatchback - OPEL ADAM 1.4 (A Partir de 10.12) 87cv 1398cc Hatchback - OPEL ADAM 1.4 LPG (A Partir de 07.13) 87cv 1398cc Hatchback - OPEL ADAM 1.4 (A Partir de 10.12) 101cv 1398cc Hatchback	
	96x100x18mm	1p-d10-75mm		d19x31mm	
	C0233	NO. 1160724 - 90054143		E0601-M	NO. 5684206
	BOTÃO AFINAÇÃO CAPÔT OPEL CORSA D 1.0 (A Partir de 07.06) 60cv 998cc Hatchback - OPEL CORSA D 1.0 (A Partir de 01.10) 65cv 998cc Hatchback - OPEL CORSA D 1.2 (A Partir de 06.10) 69cv 1229cc Hatchback - OPEL CORSA D 1.2 (A Partir de 07.06) 80cv 1229cc Hatchback - OPEL CORSA D 1.2 LPG (A Partir de 09.09) 80cv 1229cc Hatchback - OPEL CORSA D 1.2 LPG (A Partir de 06.11) 83cv 1229cc Hatchback - OPEL CORSA D 1.2...			ESTICADOR SUPORTE APOIO MOTOR TRAS OPEL CORSA D (S07): 1.0 (L08, L68) 07.2006/12.2010 44KW 60CV 998CC - OPEL CORSA D (S07): 1.0 (L08, L68) 12.2009/08.2014 48KW 65CV 998CC - OPEL CORSA D (S07): 1.2 (L08, L68) 12.2009/08.2014 51KW 69CV 1229CC - OPEL CORSA D (S07): 1.2 (L08, L68) 07.2006/08.2014 59KW 80CV 1229CC - OPEL CORSA D (S07): 1.2 LPG (L08, L68) 08.2006/08.2014 59KW 80CV 1229CC - OPEL CORSA D (S07): 1.2 LPG (L08, L68) 06.2011/0...	
	d19x31mm			210x97x46mm	1f-d12mm 1f-d13mm 1r-d10mm
	E0601-M	NO. 50510781 - 55703436		E0605-M	NO. 0846000 - 09227883 - 24463130 - 8 46 083 - 846000 - 9227883 - 93302286
	ESTICADOR SUPORTE APOIO MOTOR TRAS OPEL ADAM (M13): 1.2 10.2012/02.2019 51KW 69CV 1229CC - OPEL ADAM (M13): 1.4 10.2012/02.2019 64KW 87CV 1398CC - OPEL ADAM (M13): 1.4 LPG 07.2013/11.2018 64KW 87CV 1398CC - OPEL ADAM (M13): 1.4 10.2012/02.2019 74KW 101CV 1398CC			ESTICADOR SUPORTE APOIO MOTOR TRAS OPEL CORSA D (S07) 1.2 LPG (L08, L68) 08.2006/08.2014 59KW 80CV 1229CC Z 12 XEP 0035AKH	
	210x97x46mm	1f-d12mm 1f-d13mm 1r-d10mm		220x100x50mm	2f-d12mm 1f-12x18mm

	<p>F4137 NO. 578002 - 95507715</p> <p>FOLE ALAVANCA TRAVÃO DE MÃO</p> <p>OPEL CORSA D (S07): 1.2 (L08, L68) 12.2009/08.2014 63KW 86CV 1229CC - OPEL CORSA D (S07): 1.4 (L08, L68) 12.2009/08.2014 74KW 100CV 1398CC - OPEL CORSA D (S07): 1.6 Turbo (L08, L68) 05.2007/08.2014 110KW 150CV 1598CC - OPEL CORSA D (S07): 1.6 Turbo (L08, L68) 11.2006/08.2014 141KW 192CV 1598CC - OPEL CORSA D (S07): 1.3 CDTI (L08, L68) 06.2009/08.2014 70KW 95CV 1248CC</p> <p>202x60x181 1f-d10mm</p>		<p>F4142 NO. 5738025 - 93180984</p> <p>FOLE ALAVANCA VELOCIDADES</p> <p>OPEL CORSA D 2005/2010</p> <p>155x133x160mm 1f-d22mm</p>
	<p>F4208 NO. 55490923 - 55557719 - 55568368 - 5738057 - 738522</p> <p>FOLE ALAVANCA VELOCIDADES C/ MANETE PUNHO TOPO COMPLETO 5 VELOCIDADES</p> <p>OPEL CORSA D (S07): 1.0 (L08, L68) 07.2006/12.2010 44KW 60CV 998CC - OPEL CORSA D (S07): 1.2 (L08, L68) 07.2006/08.2014 59KW 80CV 1229CC - OPEL CORSA D (S07): 1.4 (L08, L68) 07.2006/08.2014 66KW 90CV 1364CC - OPEL CORSA D (S07): 1.3 CDTI (L08, L68) 07.2006/08.2014 55KW 75CV 1248CC - OPEL CORSA D (S07): 1.3 CDTI (L08, L68) 07.2006/06.2011 66KW 90CV 1248CC - OPEL CORSA D (S07): 1.7 CDTI (L08, L68) 0...</p> <p>162x126x260mm 1f-144x104mm</p>		<p>F4216 NO. 55557718 - 5738056</p> <p>FOLE ALAVANCA VELOCIDADES</p> <p>OPEL CORSA D (S07): 1.2 (L08, L68) 12.2009/08.2014 63KW 86CV 1229CC - OPEL CORSA D (S07): 1.4 (L08, L68) 07.2006/08.2014 66KW 90CV 1364CC - OPEL CORSA D (S07): 1.4 (L08, L68) 12.2009/08.2014 74KW 100CV 1398CC - OPEL CORSA D (S07): 1.6 Turbo (L08, L68) 05.2007/08.2014 110KW 150CV 1598CC - OPEL CORSA D (S07): 1.6 Turbo (L08, L68) 11.2006/08.2014 141KW 192CV 1598CC - OPEL CORSA D (S07): 1.3 CDTI (L08, L68) 0...</p> <p>157x120x195mm 1f-140x108mm</p>
	<p>F4217 NO. 55557719 - 5738057</p> <p>FOLE ALAVANCA VELOCIDADES C/ ARO CROMADO</p> <p>OPEL CORSA D (S07): 1.0 (L08, L68) 07.2006/12.2010 44KW 60CV 998CC - OPEL CORSA D (S07): 1.2 (L08, L68) 07.2006/08.2014 59KW 80CV 1229CC - OPEL CORSA D (S07): 1.4 (L08, L68) 07.2006/08.2014 66KW 90CV 1364CC - OPEL CORSA D (S07): 1.3 CDTI (L08, L68) 07.2006/08.2014 55KW 75CV 1248CC - OPEL CORSA D (S07): 1.3 CDTI (L08, L68) 07.2006/06.2011 66KW 90CV 1248CC - OPEL CORSA D (S07): 1.7 CDTI (L08, L68) 0...</p> <p>158x128x188mm 1f-138x102mm</p>		<p>F4263 NO. 55354140 - 55557718 - 55568376 - 5738036 - 738536</p> <p>FOLE ALAVANCA VELOCIDADES C/ MANETE PUNHO TOPO COMPLETO 5 VELOCIDADES</p> <p>OPEL CORSA D (S07) 1.0 (L08, L68) 07.2006/12.2010 44KW 60CV 998CC Z 10 XEP 0035AF0 - OPEL CORSA D (S07) 1.0 (L08, L68) 12.2009/08.2014 48KW 65CV 998CC A 10 XEP 0035ALH - OPEL CORSA D (S07) 1.2 (L08, L68) 07.2006/08.2014 59KW 80CV 1229CC Z 12 XEP 0035AFQ - OPEL CORSA D (S07) 1.2 (L08, L68) 12.2009/08.2014 51KW 69CV 1229CC A 12 XEL 0035ALI - OPEL CORSA D (S07) 1.2 (L08, L68) 12.2009/08.2014 63KW...</p> <p>244x167x125mm 1f-140x99mm</p>
	<p>F9066H-I NO. 1603307 - 93189683</p> <p>FOLE TRANSMISSÃO JUNTO RODA</p> <p>OPEL CORSA D</p> <p>d94x120mm 1f-d28mm 1f-d84mm</p>		<p>KL80932 NO. 1p-d6-10mm d-20/10mm 1f-d14mm 1f-d</p> <p>KIT CASQUILHO COBERTURA TAMP MOTOR</p> <p>OPEL CORSA D (S07): 1.3 CDTI (L08, L68) 07.2006/08.2014 55KW 75CV 1248CC - OPEL CORSA D (S07): 1.3 CDTI (L08, L68) 07.2006/06.2011 66KW 90CV 1248CC - OPEL CORSA D (S07): 1.3 CDTI (L08, L68) 06.2009/08.2014 70KW 95CV 1248CC - OPEL CORSA D Caixa/parte traseira inclinada (S07): 1.3 CDTI (L08) 07.2006/08.2014 55KW 75CV 1248CC - OPEL CORSA D Caixa/parte traseira inclinada (S07): 1.3 CDTI (L08) 07.2006/...</p> <p>d30/75mm d-33/19mm d-39/20mm d-42/20mm d-20/10mm 1f-d14mm 1f-d22mm...</p>
	<p>KT0506 NO. 55701429</p> <p>KIT BATENTE SUSPENSÃO FRENTE (GASTA 2 UNIDADES)</p> <p>OPEL CORSA D (S07) 1.0 (L08, L68) 07.2006/12.2010 44KW 60CV 998CC Z 10 XEP 0035AF0 - OPEL CORSA D (S07) 1.0 (L08, L68) 12.2009/08.2014 48KW 65CV 998CC A 10 XEP 0035ALH - OPEL CORSA D (S07) 1.2 (L08, L68) 07.2006/08.2014 59KW 80CV 1229CC Z 12 XEP 0035AFQ - OPEL CORSA D (S07) 1.2 (L08, L68) 12.2009/08.2014 51KW 69CV 1229CC A 12 XEL 0035ALI - OPEL CORSA D (S07) 1.2 (L08, L68) 12.2009/08.2014 63KW 86CV...</p> <p>d62x285mm 1f-d13mm 1f-d60mm</p>		<p>KUR28282 NO. 1f-d16mm 1f-d15mm 1f-d18mm 1f-d25mm</p> <p>KIT REPARAÇÃO ALAVANCA DE VELOCIDADES</p> <p>OPEL CORSA D Caixa/parte traseira inclinada (S07) 1.2 (L08) (08.2006 - 08.2014) 59kw 80cv 1229cm3 Caixa/parte traseira inclinada OPEL CORSA D Caixa/parte traseira inclinada (S07) 1.3 CDTI (L08) (07.2006 - 06.2010) 66kw 90cv 1248cm3 Caixa/parte traseira inclinada</p> <p>33x35x28mm(x2) d22x19mm d22x19mm d22x19mm d22x19mm d22x19mm d22x19mm d22x19mm d22x19mm d22x19mm d22x19mm</p>
	<p>Q2009 NO.</p> <p>UNIÃO DE ESCAPE 47/52,5x90mm</p> <p>OPEL - CORSA D - 1.4 (APÓS 07.06) 90cv 1364cc Hatchback - OPEL - CORSA D - 1.4 LPG (APÓS 07.06) 90cv 1364cc Hatchback - OPEL - CORSA D - 1.4 (APÓS 09.09) 87cv 1398cc Hatchback - OPEL - CORSA D - 1.4 (APÓS 06.10) 100cv 1398cc Hatchback</p> <p>90x58x78mm 1f-d47mm</p>		<p>Q2010 NO.</p> <p>UNIÃO DE ESCAPE 48/52,5X125MM</p> <p>OPEL - CORSA D - 1.3 CDTI (APÓS 07.06) 75cv 1248cc - OPEL - CORSA D - 1.3 CDTI (APÓS 07.06) 90cv 1248cc - OPEL - CORSA D - 1.3 CDTI (APÓS 06.10) 95cv 1248cc</p> <p>125x57x80mm 1f-d48mm</p>
	<p>R016261 NO. 55240933 - 860334 - 860415 - 861021</p> <p>TUBO DO OLEO DO COMPRESSOR</p> <p>OPEL CORSA D (S07) 1.3 CDTI (L08, L68) 06.2009/08.2014 70KW 95CV 1248CC A 13 DTE Z 13 DTE A 13 DTR 0035AKE - OPEL CORSA D Caixa/parte traseira inclinada (S07) 1.3 CDTI (L08) 11.2009/08.2014 70KW 95CV 1248CC A 13 DTE A 13 DTR Z 13 DTE 0035ANZ</p> <p>B105-14/15mm 40x40x39mm</p>		<p>R017112 NO. 5851946 - 93177469</p> <p>TUBO DA VALVULA REGULADORA DE VELOCIDADE</p> <p>OPEL CORSA D (S07): 1.3 CDTI (L08, L68) 07.2006/08.2014 55KW 75CV 1248CC - OPEL CORSA D (S07): 1.3 CDTI (L08, L68) 07.2006/06.2011 66KW 90CV 1248CC - OPEL CORSA D (S07): 1.3 CDTI (L08, L68) 06.2009/08.2014 70KW 95CV 1248CC - OPEL CORSA D Caixa/parte traseira inclinada (S07): 1.3 CDTI (L08) 07.2006/08.2014 55KW 75CV 1248CC - OPEL CORSA D Caixa/parte traseira inclinada (S07): 1.3 CDTI (L08) 07.2006/...</p> <p>B133-14/14mm 39x64x29x51mm</p>
	<p>R019213 NO. 55245385</p> <p>TUBO EXTRATOR COMBUSTIVEL</p> <p>OPEL CORSA D (S07): 1.3 CDTI (L08, L68) 07.2006/08.2014 55KW 75CV 1248CC - OPEL CORSA D (S07): 1.3 CDTI (L08, L68) 07.2006/06.2011 66KW 90CV 1248CC - OPEL CORSA D Caixa/parte traseira inclinada (S07): 1.3 CDTI (L08) 07.2006/08.2014 55KW 75CV 1248CC - OPEL CORSA D Caixa/parte traseira inclinada (S07): 1.3 CDTI (L08) 07.2006/06.2011 66KW 90CV 1248CC</p> <p>B-340/3mm 4p-d5x10mm</p>		<p>R220259 NO. 13249356 - 1818479</p> <p>TUBO PERMUTADOR DO AQUECIMENTO</p> <p>OPEL CORSA D (S07) 1.0 (L08, L68) 12.2009/08.2014 48KW 65CV 998CC A 10 XEP 0035ALH - OPEL CORSA D (S07) 1.2 (L08, L68) 12.2009/08.2014 63KW 86CV 1229CC A 12 XER 0035ALJ - OPEL CORSA D (S07) 1.4 (L08, L68) 09.2009/08.2014 64KW 87CV 1398CC A 14 XEL 0035ALK - OPEL CORSA D (S07) 1.4 (L08, L68) 12.2009/08.2014 74KW 100CV 1398CC A 14 XER 0035ALL</p> <p>B355-19/22mm 60-156-70-70-49mm</p>

	R221467 NO. 100-57-156-83mm ch-d19-23-62-28-72 TUBO INFERIOR DO RADIADOR OPEL CORSA D (S07) 1.2 (L08 - L68) (De 07-2006 Até ...) 59kW 80CV 1229cc Hatchback OPEL CORSA D (S07) 1.4 LPG (L08 - L68) (De 07-2006 Até ...) 66kW 90CV 1364cc Hatchback B359-32/40mm 100-57-156-83mm ch-d19-23-62-28-72-14		R221743 NO. 055351522 - 05656121 - 0656092 - 55578995 - 5656121 - 656092 TUBO RESPIRO DO CARTER CAMBOTA OPEL CORSA D (S07) 1.0 (L08, L68) (07.2006 - 12.2010) 44kW 60cv 998cm3 Hatchback OPEL CORSA D (S07) 1.0 (L08, L68) (12.2009 - 08.2014) 48kW 65cv 998cm3 Hatchback OPEL CORSA D (S07) 1.2 (L08, L68) (12.2009 - 08.2014) 63kW 86cv 1229cm3 Hatchback OPEL CORSA D (S07) 1.2 (L08, L68) (07.2006 - 08.2014) 59kW 80cv 1229cm3 Hatchback OPEL CORSA D (S07) 1.2 LPG (L08, L68) (08.2006 - 08.2014) 59kW 80cv 1229cm... boca a boca 175mmd1-15mm x 20mm 75-73
	R221748 NO. 5851946 - 93177469 TUBO DA VALVULA REGULADORA DE VELOCIDADE OPEL CORSA D (S07) 1.3 CDTI (L08, L68) 07.2006/08.2014 55KW 75CV 1248CC Z 13 DTJ A 13 DTC 0035AFS - OPEL CORSA D (S07) 1.3 CDTI (L08, L68) 07.2006/06.2011 66KW 90CV 1248CC Z 13 DTH 0035AFT - OPEL CORSA D (S07) 1.3 CDTI (L08, L68) 06.2009/08.2014 70KW 95CV 1248CC A 13 DTE Z 13 DTE A 13 DTR 0035AKE B140-17/17mm 70x30x80x35mm		R222733 NO. 1336026 - 1336474 - 13249351 - 13344211 TUBO SUPERIOR DO RADIADOR OPEL CORSA D (S07) 1.2 (L08, L68) 12.2009/08.2014 51KW 69CV 1229CC A 12 XEL 0035ALI - OPEL CORSA D (S07) 1.2 (L08, L68) 12.2009/08.2014 63KW 86CV 1229CC A 12 XER 0035ALJ - OPEL CORSA D (S07) 1.2 LPG (L08, L68) 06.2011/08.2014 61KW 83CV 1229CC A 12 XER - OPEL CORSA D (S07) 1.2 LPG (L08, L68) 06.2011/08.2014 63KW 86CV 1229CC A 12 XER 0035ASI - OPEL CORSA D (S07) 1.4 (L08, L68) 07.2006/08.2014 66KW 9... B350-d31/d32mm 86-112-92-88mm
	R224303 NO. 13191203 - 1337806 TUBO SUPERIOR DO RADIADOR OPEL CORSA D (S07) 1.4 (L08, L68) (De 07.2006 Até 08.2014) 66KW 90cv 1364cm3 Hatchback - boca a boca 238 mm d1 32mmd2 34mm		R225293 NO. 13249353 - 1336027 - 1337868 - 13408388 TUBO DO AQUECIMENTO OPEL CORSA D (S07) 1.2 (L08, L68) 12.2009/08.2014 63KW 86CV 1229CC A 12 XER 0035ALJ - OPEL CORSA D (S07) 1.4 (L08, L68) 09.2009/08.2014 64KW 87CV 1398CC A 14 XEL 0035ALK - OPEL CORSA D (S07) 1.4 (L08, L68) 12.2009/08.2014 74KW 100CV 1398CC A 14 XER 0035ALL 295-10/10mm 72-70-81-75mm
	R230093 NO. 1307XH TUBO DO LIQUIDO DA REFRIGERAÇÃO OPEL CORSA D (S07) 1.4 (L08, L68) 07.2006/08.2014 66KW 90CV 1364CC Z 14 XEP 0035AFR B450-4/4mm 53-45-51-143-116-46-103mm		RT80580 NO. 5562250 TUBO DE TRAVÃO TRÁS RH OPEL CORSA D (S07) 1.0 (L08, L68) 07.2006/12.2010 44KW 60CV 998CC Z 10 XEP 0035AFO - OPEL CORSA D (S07) 1.2 (L08, L68) 07.2006/08.2014 59KW 80CV 1229CC Z 12 XEP 0035AFQ - OPEL CORSA D (S07) 1.3 CDTI (L08, L68) 07.2006/08.2014 55KW 75CV 1248CC Z 13 DTJ A 13 DTC 0035AFS - OPEL CORSA D (S07) 1.3 CDTI (L08, L68) 07.2006/06.2011 66KW 90CV 1248CC Z 13 DTH 0035AFT - OPEL CORSA D (S07) 1.4 (L08, L68) 07.2... 630mm
	RT80581 NO. 5562249 TUBO DE TRAVÃO TRÁS RH (COM TAMBOR) OPEL CORSA D 1.0 (motor Z 10 XEP) (APÓS 7-2006) - 1.2 (motor Z 12 XEP) (APÓS 07-2006) - 1.3 CDTI (motor Z 13 DTH) (APÓS 07-2006) - 1.3 CDTI (motor Z 13 DTJ) (APÓS 7-2006) - 1.4 (motor Z 14 XEP) (APÓS 07-2006) - 1.6 TURBO (motor Z 16 LEL) (APÓS 02-2007) - 630mm		RT80582 NO. 5562248 TUBO DE TRAVÃO TRÁS RH (COM DISCO) OPEL CORSA D 1.0 (motor Z 10 XEP) (APÓS 7-2006) - 1.2 (motor Z 12 XEP) (APÓS 07-2006) - 1.3 CDTI (motor Z 13 DTH) (APÓS 07-2006) - 1.3 CDTI (motor Z 13 DTJ) (APÓS 7-2006) - 1.4 (motor Z 14 XEP) (APÓS 07-2006) - 1.6 TURBO (motor Z 16 LEL) (APÓS 02-2007) - 760mm
	S1595 NO. 50511650 - 50521486 - 51783056 - 51783057 SILENT-BLOC BRAÇO SUPERIOR FRENTE OPEL ADAM 1.2 (A Partir de 07.13) 69cv 1229cc Hatchback - OPEL ADAM 1.2 (A Partir de 07.13) 94cv 1242cc Hatchback - OPEL ADAM 1.4 (A Partir de 10.12) 87cv 1398cc Hatchback - OPEL ADAM 1.4 LPG (A Partir de 07.13) 87cv 1398cc Hatchback - OPEL ADAM 1.4 (A partir de 10.12) 101cv 1398cc Hatchback d53x67mm d41mm 1f-d14mm		S1595 NO. 50511650 - 50521486 - 51783056 - 51783057 SILENT-BLOC BRAÇO SUPERIOR FRENTE OPEL CORSA D 1.0 (A Partir de 07.06) 60cv 998cc Hatchback - OPEL CORSA D 1.0 (A partir de 07.10) 65cv 998cc Hatchback - OPEL CORSA D 1.2 (A partir de 06.10) 69cv 1229cc Hatchback - OPEL CORSA D 1.2 (A partir de 07.06) 80cv 1229cc Hatchback - OPEL CORSA D 1.2 LPG (A partir de 09.09) 80cv 1229cc Hatchback - OPEL CORSA D 1.2 LPG (A partir de 06.11) 83cc 1229cv Hatchback - OPEL CORSA D 1.2... d53x67mm d41mm 1f-d14mm
	S1829 NO. 0352864 SILENT-BLOC DO BRAÇO SUSPENSÃO FRENTE PARTE TRÁS OPEL ADAM (M13) 1.0 (De 07.2014 Até 11.2018) 66kW 90cv 999cm3 Hatchback - OPEL ADAM (M13) 1.0 (De 07.2014 Até 11.2018) 85kW 115cv 999cm3 Hatchback - OPEL ADAM (M13) 1.2 (De 10.2012 Até 02.2019) 51kW 69cv 1229cm3 Hatchback - OPEL ADAM (M13) 1.4 (De 10.2012 Até 02.2019) 64kW 87cv 1398cm3 Hatchback - OPEL ADAM (M13) 1.4 (De 10.2012 Até 02.2019) 74kW 101cv 1398cm3 Hatchback - OPEL ADAM (M13) 1.4 LPG ... d72x66mm c28mm 1f-d12mm		S1829 NO. 0352864 SILENT-BLOC DO BRAÇO SUSPENSÃO FRENTE PARTE TRÁS OPEL CORSA D (S07) 1.0 (L08, L68) (De 07.2006 Até 12.2010) 44kW 60cv 998cm3 Hatchback - OPEL CORSA D (S07) 1.0 (L08, L68) (De 12.2009 Até 08.2014) 48kW 65cv 998cm3 Hatchback - OPEL CORSA D (S07) 1.2 (L08, L68) (De 12.2009 Até 08.2014) 51kW 69cv 1229cm3 Hatchback - OPEL CORSA D (S07) 1.2 (L08, L68) (De 07.2006 Até 08.2014) 59kW 80cv 1229cm3 Hatchback - OPEL CORSA D (S07) 1.2 (L08, L68) (De 12.2009...) d72x66mm c28mm 1f-d12mm
	S1830 NO. 0402538 SILENT-BLOC DA PONTE SUSPENSÃO DE TRÁS OPEL ADAM (M13) 1.0 (De 07.2014 Até 11.2018) 66kW 90cv 999cm3 Hatchback - OPEL ADAM (M13) 1.0 (De 07.2014 Até 11.2018) 85kW 115cv 999cm3 Hatchback - OPEL ADAM (M13) 1.2 (De 10.2012 Até 02.2019) 51kW 69cv 1229cm3 Hatchback - OPEL ADAM (M13) 1.4 (De 10.2012 Até 02.2019) 64kW 87cv 1398cm3 Hatchback - OPEL ADAM (M13) 1.4 (De 10.2012 Até 02.2019) 74kW 101cv 1398cm3 Hatchback - OPEL ADAM (M13) 1.4 LPG ... d81x 99mm c-64mm dc-69mm1f-d12mm		S1830 NO. 0402538 SILENT-BLOC DA PONTE SUSPENSÃO DE TRÁS OPEL CORSA D (S07) 1.0 (L08, L68) (De 07.2006 Até 12.2010) 44kW 60cv 998cm3 Hatchback - OPEL CORSA D (S07) 1.0 (L08, L68) (De 12.2009 Até 08.2014) 48kW 65cv 998cm3 Hatchback - OPEL CORSA D (S07) 1.2 (L08, L68) (De 12.2009 Até 08.2014) 51kW 69cv 1229cm3 Hatchback - OPEL CORSA D (S07) 1.2 (L08, L68) (De 07.2006 Até 08.2014) 59kW 80cv 1229cm3 Hatchback - OPEL CORSA D (S07) 1.2 (L08, L68) (De 12.2009...) d81x 99mm c-64mm dc-69mm1f-d12mm

	<p>T0656-I NO. 0344651 - 344651</p> <p>BATENTE SUSPENSÃO DA FRENTE</p> <p>OPEL CORSA D 1.0 (APÓS 07.06) 60cv 998cc Hatchback - OPEL CORSA D 1.0 (APÓS 01.10) 65cv 998cc Hatchback - OPEL CORSA D 1.2 (APÓS 06.10) 69cv 1229cc Hatchback - OPEL CORSA D 1.2 (APÓS 07.06) 80cv 1229cc Hatchback - OPEL CORSA D 1.2 LPG (APÓS 09.09) 80cv 1229cc Hatchback - OPEL CORSA D 1.2 LPG (APÓS 06.11) 83cv 1229cc Hatchback - OPEL CORSA D 1.2 (APÓS 06.10) 86cv 1229cc Hatchback - OPEL CORSA...</p> <p>d63x65mm 1f-d27mm 1f-d20mm</p>		<p>T1234 NO. 0350181 - 0350182 - 0350207 - 13343139 - 13343140 - 350181 - 350182 - 350207 - 55700770</p> <p>BATENTE DA BARRA ESTABILIZADORA DA FRENTE</p> <p>OPEL ADAM (M13): 1.0 07.2014/11.2018 66KW 90CV 999CC - OPEL ADAM (M13): 1.0 07.2014/11.2018 85KW 115CV 999CC - OPEL ADAM (M13): 1.2 10.2012/02.2019 51KW 69CV 1229CC - OPEL ADAM (M13): 1.4 10.2012/02.2019 64KW 87CV 1398CC - OPEL ADAM (M13): 1.4 LPG 07.2013/11.2018 64KW 87CV 1398CC - OPEL ADAM (M13): 1.4 10.2012/02.2019 74KW 101CV 1398CC - OPEL ADAM (M13): 1.4 S 11.2014/01.2019 110KW 150CV 1364CC</p> <p>38x35x35mm 1f-d17mm</p>
	<p>T1234 NO. 0350181 - 0350182 - 0350207 - 13343139 - 13343140 - 350181 - 350182 - 350207 - 55700770</p> <p>BATENTE DA BARRA ESTABILIZADORA DA FRENTE</p> <p>OPEL CORSA D (S07): 1.0 (L08, L68) 07.2006/12.2010 44KW 60CV 998CC - OPEL CORSA D (S07): 1.0 (L08, L68) 12.2009/08.2014 48KW 65CV 998CC - OPEL CORSA D (S07): 1.2 (L08, L68) 12.2009/08.2014 51KW 69CV 1229CC - OPEL CORSA D (S07): 1.2 (L08, L68) 07.2006/08.2014 59KW 80CV 1229CC - OPEL CORSA D (S07): 1.2 LPG (L08, L68) 08.2006/08.2014 59KW 80CV 1229CC - OPEL CORSA D (S07): 1.2 LPG (L08, L68) 06.2011/0...</p> <p>38x35x35mm 1f-d17mm</p>		<p>T1235 NO. 0350181 - 0350207 - 13343139 - 350181 - 350182 - 0350182 - 13343140 - 55700770 - 350207</p> <p>BATENTE DA BARRA ESTABILIZADORA DA FRENTE</p> <p>OPEL ADAM (M13): 1.0 07.2014/11.2018 66KW 90CV 999CC - OPEL ADAM (M13): 1.0 07.2014/11.2018 85KW 115CV 999CC - OPEL ADAM (M13): 1.2 10.2012/02.2019 51KW 69CV 1229CC - OPEL ADAM (M13): 1.4 10.2012/02.2019 64KW 87CV 1398CC - OPEL ADAM (M13): 1.4 LPG 07.2013/11.2018 64KW 87CV 1398CC - OPEL ADAM (M13): 1.4 10.2012/02.2019 74KW 101CV 1398CC - OPEL ADAM (M13): 1.4 S 11.2014/01.2019 110KW 150CV 1364CC</p> <p>39x35x34mm 1f-d18mm</p>
	<p>T1235 NO. 0350181 - 0350207 - 13343139 - 350181 - 350182 - 0350182 - 13343140 - 55700770 - 350207</p> <p>BATENTE DA BARRA ESTABILIZADORA DA FRENTE</p> <p>OPEL CORSA D (S07): 1.0 (L08, L68) 07.2006/12.2010 44KW 60CV 998CC - OPEL CORSA D (S07): 1.0 (L08, L68) 12.2009/08.2014 48KW 65CV 998CC - OPEL CORSA D (S07): 1.2 (L08, L68) 12.2009/08.2014 51KW 69CV 1229CC - OPEL CORSA D (S07): 1.2 (L08, L68) 07.2006/08.2014 59KW 80CV 1229CC - OPEL CORSA D (S07): 1.2 LPG (L08, L68) 08.2006/08.2014 59KW 80CV 1229CC - OPEL CORSA D (S07): 1.2 LPG (L08, L68) 06.2011/0...</p> <p>39x35x34mm 1f-d18mm</p>		<p>UAP81292 NO. 0821038 - 0821074 - 0821437 - 0821675 - 4708869 - 4809347 - 821038 - 821074 - 821437 - 821675</p> <p>ANILHA PROTEÇÃO TÉRMICA INJECTORES</p> <p>OPEL CORSA D (S07) 1.3 CDTI (L08 - L68) (De 07-2006 Até 08-2014) 55KW 75CV 1248cc Hatchback OPEL CORSA D (S07) 1.3 CDTI (L08 - L68) (De 07-2006 Até 06-2011) 66KW 90CV 1248cc Hatchback OPEL CORSA D Van (S07) 1.3 CDTI (L08) (De 07-2006 Até 08-2014) 55KW 75CV 1248cc Caixa OPEL CORSA D Van (S07) 1.3 CDTI (L08) (De 07-2006 Até 06-2010) 66KW 90CV 1248cc Caixa</p> <p>d16x1mm 1f-d7mm</p>
	<p>UAP81292 NO. 0821038 - 0821074 - 0821437 - 0821675 - 4708869 - 4809347 - 821038 - 821074 - 821437 - 821675</p> <p>ANILHA PROTEÇÃO TÉRMICA INJECTORES</p> <p>OPEL CORSA D (S07) 1.3 CDTI (L08 - L68) (De 07-2006 Até 08-2014) 55KW 75CV 1248cc Hatchback OPEL CORSA D (S07) 1.3 CDTI (L08 - L68) (De 07-2006 Até 06-2011) 66KW 90CV 1248cc Hatchback OPEL CORSA D Van (S07) 1.3 CDTI (L08) (De 07-2006 Até 08-2014) 55KW 75CV 1248cc Caixa OPEL CORSA D Van (S07) 1.3 CDTI (L08) (De 07-2006 Até 06-2010) 66KW 90CV 1248cc Caixa</p> <p>d16x1mm 1f-d7mm</p>		<p>UCRZ1052 NO. 1603433 - 93195149</p> <p>CRUZETA VEIO TRANSMISSAO TRIPOIDE D29,9MM/20 DENTES</p> <p>OPEL ADAM (M13) 1.2 10.2012/02.2019 51KW 69CV 1229CC B 12 XEL A 12 XEL D 12 XEL 0035AWJ 0035BDY 1844ACQ</p> <p>d30x30mm 1f-d12mm</p>
	<p>UCRZ1052 NO. 1603433 - 93195149 - 93600-00Q0A - 39600-00Q0D - 396004652R - 93195149 - GG11-22-520 - GG12-22-620 - GG12-25-50...</p> <p>CRUZETA VEIO TRANSMISSAO TRIPOIDE D29,9MM/20 DENTES</p> <p>OPEL CORSA D (S07) 1.0 (L08, L68) 07.2006/12.2010 44KW 60CV 998CC Z 10 XEP 0035AFO - OPEL CORSA D (S07) 1.0 (L08, L68) 12.2009/08.2014 48KW 65CV 998CC A 10 XEP 0035ALH - OPEL CORSA D (S07) 1.2 (L08, L68) 07.2006/08.2014 59KW 80CV 1229CC Z 12 XEP 0035AFQ - OPEL CORSA D (S07) 1.2 (L08, L68) 12.2009/08.2014 51KW 69CV 1229CC A 12 XEL 0035ALI - OPEL CORSA D (S07) 1.2 (L08, L68) 12.2009/08.2014 63KW 8...</p> <p>d30x30mm 1f-d12mm</p>		<p>UCRZ1060 NO. (22 dentes)</p> <p>CRUZETA VEIO DE TRANSMISSÃO TRIPOIDE D30,40MM/21 DENTES</p> <p>OPEL ADAM (M13) 1.4 (De 10.2012 Até 02.2019) 64KW 87cv 1398cm3 Hatchback - OPEL ADAM (M13) 1.4 (De 10.2012 Até 02.2019) 74KW 101cv 1398cm3 Hatchback - OPEL ADAM (M13) 1.4 LPG (De 07.2013 Até 11.2018) 64KW 87cv 1398cm3 Hatchback -</p> <p>d30mm (22 dentes) ...</p>
	<p>UCRZ1060 NO. (22 dentes)</p> <p>CRUZETA VEIO DE TRANSMISSÃO TRIPOIDE D30,40MM/21 DENTES</p> <p>OPEL CORSA D (S07) 1.0 (L08, L68) (De 07.2006 Até 12.2010) 44KW 60cv 998cm3 Hatchback - OPEL CORSA D (S07) 1.0 (L08, L68) (De 07.2006 Até 12.2010) 44KW 60cv 998cm3 Hatchback - OPEL CORSA D (S07) 1.2 (L08, L68) (De 07.2006 Até 08.2014) 59KW 80cv 1229cm3 Hatchback - OPEL CORSA D (S07) 1.2 (L08, L68) (De 07.2006 Até 08.2014) 59KW 80cv 1229cm3 Hatchback - OPEL CORSA D (S07) 1.2 LPG (L08, L68) (De 08.2...</p> <p>d30mm (22 dentes) ...</p>		<p>UMB84029 NO. 2060946</p> <p>TAMPÃO BLOCO MOTOR</p> <p>OPEL CORSA D (S07) 1.6 Turbo (L08, L68) (05.07 A 08.14) 150cv 1598cc Hatchback - OPEL CORSA D (S07) 1.6 Turbo (L08, L68) (05.07 A 08.14) 150cv 1598cc Hatchback</p> <p>d36x10mm di-32mm</p>
	<p>UMV25434 NO. 5738946 - 93186142</p> <p>MANETE PUNHO TOPO ALAVANCA MUDANÇAS 6 VELOCIDADES F31MM</p> <p>OPEL CORSA D (S07) 1.0 (L08, L68) 07.2006/12.2010 44KW 60CV 998CC Z 10 XEP 0035AFO - OPEL CORSA D (S07) 1.0 (L08, L68) 12.2009/08.2014 48KW 65CV 998CC A 10 XEP 0035ALH - OPEL CORSA D (S07) 1.2 (L08, L68) 07.2006/08.2014 59KW 80CV 1229CC Z 12 XEP 0035AFQ - OPEL CORSA D (S07) 1.2 (L08, L68) 12.2009/08.2014 51KW 69CV 1229CC A 12 XEL 0035ALI - OPEL CORSA D (S07) 1.2 (L08, L68) 12.2009/08.2014 63KW 86C...</p> <p>d52x60mm 1f-d31mm</p>		<p>UTR0821 NO. 1304677 - 9202799</p> <p>TAMPÃO RESERVATÓRIO LIQUIDO REFRIGERAÇÃO</p> <p>OPEL CORSA D 1.0 (A Partir de 07.06) 60cv 998cc Hatchback - OPEL CORSA D 1.0 (A Partir de 01.10) 65cv 998cc Hatchback - OPEL CORSA D 1.2 (A Partir de 06.10) 69cv 1229cc Hatchback - OPEL CORSA D 1.2 (A Partir de 07.06) 80cv 1229cc Hatchback - OPEL CORSA D 1.2 L P G (A Partir de 09.09) 80cv 1229cc Hatchback - OPEL CORSA D 1.2 L P G (A Partir de 06.11) 83cv 1229cc Hatchback - OPEL CORSA...</p> <p>61x35mm 1f-d52x15mm</p>
	<p>UTR0856 NO. 1305248 - 13502353</p> <p>TAMPÃO RESERVATÓRIO LIQUIDO REFRIGERAÇÃO</p> <p>OPEL ADAM (M13) 1.0 (A Partir de 07.14) 90cv 999cc Hatchback - OPEL ADAM (M13) 1.0 (A Partir de 07.14) 115cv 999cc Hatchback - OPEL ADAM (M13) 1.2 (A Partir de 10.12) 69cv 1229cc Hatchback - OPEL ADAM (M13) 1.4 LPG (A Partir de 07.13) 87cv 1398cc Hatchback</p> <p>65x35mm 1f-d52x10mm</p>		<p>UTR0856 NO. 1305248 - 13502353</p> <p>TAMPÃO RESERVATÓRIO LIQUIDO REFRIGERAÇÃO</p> <p>OPEL ADAM (M13) 1.0 (De 07-2014 Até .1-20 -) 66KW 90CV 999cc Hatchback OPEL ADAM (M13) 1.0 (De 07-2014 Até .1-20 -) 85KW 115CV 999cc Hatchback OPEL ADAM (M13) 1.2 (De 10-2012 Até .1-20 -) 51KW 69CV 1229cc Hatchback OPEL ADAM (M13) 1.4 (De 10-2012 Até .1-20 -) 64KW 87CV 1398cc Hatchback OPEL ADAM (M13) 1.4 LPG (De 07-2013 Até .1-20 -) 64KW 87CV 1398cc Hatchback OPEL ADAM (M13) 1.4 (De 10-2012 Até</p> <p>65x35mm 1f-d52x10mm</p>

	<p>UTR0862 NO. 1305248 - 13502353</p> <p>TAMPÃO RESERVATÓRIO LIQUIDO REFRIGERAÇÃO</p> <p>OPEL ADAM (M13) 1.0 (De 07-2014 Até .1-20 -) 66kW 90CV 999cc Hatchback OPEL ADAM (M13) 1.0 (De 07-2014 Até .1-20 -) 85kW 115CV 999cc Hatchback OPEL ADAM (M13) 1.2 (De 10-2012 Até .1-20 -) 51kW 69CV 1229cc Hatchback OPEL ADAM (M13) 1.4 (De 10-2012 Até .1-20 -) 64kW 87CV 1398cc Hatchback OPEL ADAM (M13) 1.4 LPG (De 07-2013 Até .1-20 -) 64kW 87CV 1398cc Hatchback OPEL ADAM (M13) 1.4 (De 10-2012 ...</p> <p>d65x35mm d48x15mm 1p-d39x32mm</p>		<p>UTR1300 NO. 00650090 - 05650831</p> <p>TAMPÃO RESERVATÓRIO DO OLEO</p> <p>OPEL ADAM (M13) 1.2 (De 10-2012 Até .1-20 -) 51kW 69CV 1229cc Hatchback</p> <p>d59x31mm d45x12mm</p>
	<p>UTR1300 NO. 00650090 - 05650831</p> <p>TAMPÃO RESERVATÓRIO DO OLEO</p> <p>OPEL CORSA D (S07) 1.0 (L08 - L68) (De 07-2006 Até 12-2010) 44kW 60CV 998cc Hatchback OPEL CORSA D (S07) 1.2 (L08 - L68) (De 07-2006 Até 08-2014) 59kW 80CV 1229cc Hatchback OPEL CORSA D (S07) 1.2 LPG (L08 - L68) (De 08-2006 Até 08-2014) 59kW 80CV 1229cc Hatchback OPEL CORSA D (S07) 1.4 (L08 - L68) (De 07-2006 Até 08-2014) 66kW 90CV 1364cc Hatchback OPEL CORSA D (S07) 1.6 Turbo (L08 - L68) (De 05-2...</p> <p>d59x31mm d45x12mm</p>		<p>UTV83019 NO. 0652315 - 0652477 - 652315 - 652477 - 90502556 - 96023264</p> <p>TAMPÃO VEDAÇÃO BUJÃO</p> <p>OPEL ADAM (M13) 1.2 (De 10-2012 Até .1-20 -) 51kW 69CV 1229cc Hatchback OPEL ADAM (M13) 1.4 (De 10-2012 Até .1-20 -) 64kW 87CV 1398cc Hatchback OPEL ADAM (M13) 1.4 LPG (De 07-2013 Até .1-20 -) 64kW 87CV 1398cc Hatchback OPEL ADAM (M13) 1.4 (De 10-2012 Até .1-20 -) 74kW 101CV 1398cc Hatchback</p> <p>d25x14mm c9mm d13mm</p>
	<p>UTV83019 NO. 0652315 - 0652477 - 652315 - 652477 - 90502556 - 96023264</p> <p>TAMPÃO VEDAÇÃO BUJÃO</p> <p>OPEL CORSA D (S07) 1.0 (L08 - L68) (De 07-2006 Até 12-2010) 44kW 60CV 998cc Hatchback OPEL CORSA D (S07) 1.0 (L08 - L68) (De 12-2009 Até 08-2014) 48kW 65CV 998cc Hatchback OPEL CORSA D (S07) 1.2 (L08 - L68) (De 12-2009 Até 08-2014) 51kW 69CV 1229cc Hatchback OPEL CORSA D (S07) 1.2 (L08 - L68) (De 07-2006 Até 08-2014) 59kW 80CV 1229cc Hatchback OPEL CORSA D (S07) 1.2 LPG (L08 - L68) (De 08-2006 Até...</p> <p>d25x14mm c9mm d13mm</p>		<p>W5054 NO. 0614150 - 5614438 - 614150 - 93177317 - 93194443</p> <p>POLIE DA CAMBOTA (6 PISTAS)</p> <p>OPEL CORSA D 1.3 CDTI APÓS 07-2006 - Mtr Z13DTH - Z13DTH (75-90CV)</p> <p>d165mm d35mm</p>
	<p>W5159 NO. 055575960 - 0614172 - 0614758 - 098022837 - 098039173 - 55575960 - 5614450 - 614172 - 614758 - 99622...</p> <p>POLIE CAMBOTA 6 PISTAS</p> <p>OPEL CORSA D (S07) 1.7 CDTI (L08, L68) 08.2006/12.2011 92KW 125CV 1686CC Z 17 DTR 0035AGW - OPEL CORSA D (S07) 1.7 CDTI (L08, L68) 12.2009/08.2014 96KW 130CV 1686CC A 17 DTS 0035ALG</p> <p>d154mm d48mm</p>		<p>W5201 NO. 5614423 - 90572867</p> <p>POLIE DA CAMBOTA (5 PISTAS)</p> <p>OPEL CORSA D (S07): 1.0 (L08, L68) 07.2006/12.2010 44KW 60CV 998CC - OPEL CORSA D (S07): 1.0 (L08, L68) 12.2009/08.2014 48KW 65CV 998CC - OPEL CORSA D (S07): 1.2 (L08, L68) 12.2009/08.2014 51KW 69CV 1229CC - OPEL CORSA D (S07): 1.2 (L08, L68) 07.2006/08.2014 59KW 80CV 1229CC - OPEL CORSA D (S07): 1.2 LPG (L08, L68) 08.2006/08.2014 59KW 80CV 1229CC - OPEL CORSA D (S07): 1.2 LPG (L08, L68) 06.2011/0...</p> <p>d152mm d39mm</p>
	<p>Y3212 NO. 1008501 - 1008504 - 4709077</p> <p>PARAFUSO PERNO RODA CHAVE 17 M12X1,50X48MM (BASE CONICA PARA JANTES AÇO E LIGA LEVE)</p> <p>OPEL CORSA D (S07) 1.0 (L08, L68) (07.2006 - 12.2010) 44kw 60cv 998cm3 Hatchback OPEL CORSA D (S07) 1.0 (L08, L68) (12.2009 - 08.2014) 48kw 65cv 998cm3 Hatchback OPEL CORSA D (S07) 1.2 (L08, L68) (12.2009 - 08.2014) 51kw 69cv 1229cm3 Hatchback OPEL CORSA D (S07) 1.2 (L08, L68) (07.2006 - 08.2014) 59kw 80cv 1229cm3 Hatchback OPEL CORSA D (S07) 1.2 (L08, L68) (12.2009 - 08.2014) 63kw 86cv 1229cm3 Ha...</p> <p>C48mm (Ch-17mm) M12x1,50x22mm</p>		<p>Z55280 NO. 2228839</p> <p>MOLA PAINEL REVESTIMENTO DAS PORTAS</p> <p>OPEL ADAM (M13) 1.0 07.2014/11.2018 66KW 90CV 999CC B 10 XFL D 10 XFL 0035BDU 0035BCT 1844ACL - OPEL ADAM (M13) 1.0 07.2014/11.2018 85KW 115CV 999CC B 10 XFT D 10 XFT 0035BDW 0035BCU 1844ACN - OPEL ADAM (M13) 1.2 10.2012/02.2019 51KW 69CV 1229CC B 12 XEL A 12 XEL D 12 XEL 0035AWJ 0035BDY 1844ACQ - OPEL ADAM (M13) 1.4 10.2012/02.2019 64KW 87CV 1398CC A 14 XEL B 14 XEL D 14 XEL 0035AWK 0035BDZ 1844A...</p> <p>F-G-mm T-27L-18H-12S-5mm</p>
	<p>Z55280 NO. 2228839</p> <p>MOLA PAINEL REVESTIMENTO DAS PORTAS</p> <p>OPEL CORSA D (S07) 1.0 (L08, L68) 07.2006/12.2010 44KW 60CV 998CC Z 10 XEP 0035AFO - OPEL CORSA D (S07) 1.0 (L08, L68) 12.2009/08.2014 48KW 65CV 998CC A 10 XEP 0035ALH - OPEL CORSA D (S07) 1.2 (L08, L68) 07.2006/08.2014 59KW 80CV 1229CC Z 12 XEP 0035AFQ - OPEL CORSA D (S07) 1.2 (L08, L68) 12.2009/08.2014 51KW 69CV 1229CC A 12 XEL 0035ALI - OPEL CORSA D (S07) 1.2 (L08, L68) 12.2009/08.2014 63KW 86C...</p> <p>F-G-mm T-27L-18H-12S-5mm</p>		<p>Z55288 NO. 13317099</p> <p>MOLA DO PAINEL DAS PORTAS</p> <p>OPEL ADAM (A partir de 2013)</p> <p>F12mm T17mm L12mm H19mm S1-9mm</p>
	<p>Z57101 NO. 13252119</p> <p>MOLA DO PAINEL DA PORTA</p> <p>OPEL ADAM (A partir de 2013)</p> <p>F9mm T17mm L15mm H20mm S1-6mm</p>		<p>Z71500 NO. 13252118</p> <p>MOLA DO PAINEL DA PORTA</p> <p>OPEL ADAM (A partir de 2013)</p> <p>F9mm T17mm L14mm H20mm S1-7mm</p>
	<p>Z80846 NO. 1104881 - 1104882 - 90450482</p> <p>Rebite</p> <p>OPEL CORSA D</p> <p>d19x29mm 1p-d8-15.2mm</p>		

	<p>A2051 NO. 344963 - 55701796</p> <p>APOIO PRATO AMORTECEDOR FRENTE (GASTA 2 UNIDADES)</p> <p>OPEL CORSA E (X15): 1.0 (08, 68) 09.2014/>>> 66KW 90CV 999CC - OPEL CORSA E (X15): 1.0 (08, 68) 09.2014/>>> 85KW 115CV 999CC - OPEL CORSA E (X15): 1.2 (08, 68) 09.2014/>>> 51KW 69CV 1229CC - OPEL CORSA E (X15): 1.4 (08, 68) 09.2014/>>> 55KW 75CV 1398CC - OPEL CORSA E (X15): 1.4 (08, 68) 09.2014/>>> 66KW 90CV 1398CC - OPEL CORSA E (X15): 1.4 LPG (08, 68) 11.2015/>>> 64KW 87CV 1398CC - OPEL CORSA E ...</p> <p>d68x10mm 1f-d12mm</p>		<p>A2441 NO. 0344653 - 55703313</p> <p>APOIO SUPORTE AMORTECEDOR FRENTE (GASTA 2 UNIDADES)</p> <p>OPEL CORSA E (X15) 1.0 (08, 68) (De 09.2014 -) 66kW 90cv 999cm3 Hatchback - OPEL CORSA E (X15) 1.0 (08, 68) (De 09.2014 -) 85kW 115cv 999cm3 Hatchback - OPEL CORSA E (X15) 1.2 (08, 68) (De 09.2014 -) 51kW 69cv 1229cm3 Hatchback - OPEL CORSA E (X15) 1.3 CDTI (08, 68) (De 09.2014 -) 55kW 75cv 1248cm3 Hatchback - OPEL CORSA E (X15) 1.3 CDTI (08, 68) (De 09.2014 -) 55kW 75cv 1248cm3 Hatchback - OPEL CORSA E (X15) 1.3 CDTI (08, 68) (De 09.2014 -) 70kW 95cv 1248cm3 Hatchback - OPEL C...</p> <p>d103x31mm 1f-d12mm</p>
	<p>BE22 NO. 4401363 - 4501620 - 860151</p> <p>ABRAÇADEIRA ESCAPE</p> <p>OPEL CORSA E (X15): 1.3 CDTI (08, 68) 09.2014/>>> 55KW 75CV 1248CC - OPEL CORSA E (X15): 1.3 CDTI (08, 68) 09.2014/>>> 70KW 95CV 1248CC - OPEL CORSA E Caixa/parte traseira inclinada (X15): 1.3 CDTI (08) 01.2015/>>> 55KW 75CV 1248CC - OPEL CORSA E Caixa/parte traseira inclinada (X15): 1.3 CDTI (08) 09.2014/>>> 70KW 95CV 1248CC</p> <p>96x100x18mm 1p-d10-75mm</p>		<p>E0601-M NO. 50510781 - 55703436</p> <p>ESTICADOR SUPORTE APOIO MOTOR TRAS</p> <p>OPEL CORSA E (X15): 1.2 (08, 68) 09.2014/>>> 51KW 69KW 1229CC - OPEL CORSA E (X15): 1.4 (08, 68) 09.2014/>>> 55KW 75CV 1398CC - OPEL CORSA E (X15): 1.4 (08, 68) 09.2014/>>> 66KW 90CV 1398CC - OPEL CORSA E (X15): 1.4 LPG (08, 68) 11.2015/>>> 64KW 87CV 1398CC - OPEL CORSA E (X15): 1.4 LPG (08, 68) 03.2015/>>> 66KW 90CV 1398CC - OPEL CORSA E (X15): 1.6 Turbo (08, 68) 03.2015/>>> 152KW 207CV 1598CC - ...</p> <p>210x97x46mm 1f-d12mm 1f-d13mm 1f-d10mm</p>
	<p>F4216 NO. 55557718 - 5738056</p> <p>FOLE ALAVANCA VELOCIDADES</p> <p>OPEL CORSA E (X15): 1.4 (08, 68) 09.2014/>>> 66KW 90CV 1398CC</p> <p>157x120x195mm 1f-140x108mm</p>		<p>F9066H-I NO. 1603307 - 93189683</p> <p>FOLE TRANSMISSÃO JUNTO RODA</p> <p>OPEL CORSA E</p> <p>d94x120mm 1f-d28mm 1f-d84mm</p>
	<p>S1829 NO. 0352864</p> <p>SILENT-BLOC DO BRAÇO SUSPENSÃO FRENTE PARTE TRÁS</p> <p>OPEL CORSA E (X15) 1.0 (08, 68) (De 09.2014 -) 66kW 90cv 999cm3 Hatchback - OPEL CORSA E (X15) 1.0 (08, 68) (De 09.2014 -) 85kW 115cv 999cm3 Hatchback - OPEL CORSA E (X15) 1.2 (08, 68) (De 09.2014 -) 51kW 69cv 1229cm3 Hatchback - OPEL CORSA E (X15) 1.3 CDTI (08, 68) (De 09.2014 -) 55kW 75cv 1248cm3 Hatchback - OPEL CORSA E (X15) 1.3 CDTI (08, 68) (De 09.2014 -) 70kW 95cv 1248cm3 Hatchback - OPEL ...</p> <p>d72x66mm c28mm 1f-d12mm</p>		<p>S1830 NO. 0402538</p> <p>SILENT-BLOC DA PONTE SUSPENSÃO DE TRÁS</p> <p>OPEL CORSA E (X15) 1.0 (08, 68) (De 09.2014 -) 66kW 90cv 999cm3 Hatchback - OPEL CORSA E (X15) 1.0 (08, 68) (De 09.2014 -) 85kW 115cv 999cm3 Hatchback - OPEL CORSA E (X15) 1.2 (08, 68) (De 09.2014 -) 51kW 69cv 1229cm3 Hatchback - OPEL CORSA E (X15) 1.3 CDTI (08, 68) (De 09.2014 -) 55kW 75cv 1248cm3 Hatchback - OPEL CORSA E (X15) 1.3 CDTI (08, 68) (De 09.2014 -) 70kW 95cv 1248cm3 Hatchback - OPEL C...</p> <p>d81x 99mm c-64mm dc-69mm1f-d12mm</p>
	<p>T1234 NO. 0350181 - 0350182 - 0350207 - 13343139 - 13343140 - 350181 - 350182 - 350207 - 55700770</p> <p>BATENTE DA BARRA ESTABILIZADORA DA FRENTE</p> <p>OPEL CORSA E (X15): 1.0 (08, 68) 09.2014/>>> 66KW 90CV 999CC - OPEL CORSA E (X15): 1.0 (08, 68) 09.2014/>>> 85CV 115CV 999CC - OPEL CORSA E (X15): 1.2 (08, 68) 09.2014/>>> 51KW 69CV 1229CC - OPEL CORSA E (X15): 1.4 (08, 68) 09.2014/>>> 55KW 75CV 1398CC - OPEL CORSA E (X15): 1.4 (08, 68) 09.2014/>>> 66KW 90CV 1398CC - OPEL CORSA E (X15): 1.4 LPG (08, 68) 11.2015/>>> 64KW 87CV 1398CC - OPEL CORSA E ...</p> <p>38x35x35mm 1f-d17mm</p>		<p>T1235 NO. 0350181 - 0350207 - 13343139 - 350181 - 350182 - 0350182 - 13343140 - 55700770 - 350207</p> <p>BATENTE DA BARRA ESTABILIZADORA DA FRENTE</p> <p>OPEL CORSA E (X15): 1.0 (08, 68) 09.2014/>>> 66KW 90CV 999CC - OPEL CORSA E (X15): 1.0 (08, 68) 09.2014/>>> 85CV 115CV 999CC - OPEL CORSA E (X15): 1.2 (08, 68) 09.2014/>>> 51KW 69CV 1229CC - OPEL CORSA E (X15): 1.4 (08, 68) 09.2014/>>> 55KW 75CV 1398CC - OPEL CORSA E (X15): 1.4 (08, 68) 09.2014/>>> 66KW 90CV 1398CC - OPEL CORSA E (X15): 1.4 LPG (08, 68) 11.2015/>>> 64KW 87CV 1398CC - OPEL CORSA E ...</p> <p>39x35x34mm 1f-d18mm</p>
	<p>UAP81292 NO. 0821038 - 0821074 - 0821437 - 0821675 - 4708869 - 4809347 - 821038 - 821074 - 821437 - 821675</p> <p>ANILHA PROTEÇÃO TÉRMICA INJECTORES</p> <p>OPEL CORSA E (X15) 1.3 CDTI (08 - 68) (De 09-2014 Até .1-20 -) 55kW 75CV 1248cc Hatchback OPEL CORSA E (X15) 1.3 CDTI (08 - 68) (De 09-2014 Até .1-20 -) 70kW 95CV 1248cc Hatchback</p> <p>d16x1mm 1f-d7mm</p>		<p>UAP81292 NO. 0821038 - 0821074 - 0821437 - 0821675 - 4708869 - 4809347 - 821038 - 821074 - 821437 - 821675</p> <p>ANILHA PROTEÇÃO TÉRMICA INJECTORES</p> <p>OPEL CORSA E (X15) 1.3 CDTI (08 - 68) (De 09-2014 Até .1-20 -) 55kW 75CV 1248cc Hatchback OPEL CORSA E (X15) 1.3 CDTI (08 - 68) (De 09-2014 Até .1-20 -) 70kW 95CV 1248cc Hatchback</p> <p>d16x1mm 1f-d7mm</p>
	<p>UCRZ1060 NO. (22 dentes)</p> <p>CRUZETA VEIO DE TRANSMISSÃO TRIPOIDE D30,40MM/21 DENTES</p> <p>OPEL CORSA E (X15) 1.4 (08, 68) (De 09.2014 -) 55kW 75cv 1398cm3 Hatchback - OPEL CORSA E (X15) 1.4 (08, 68) (De 09.2014 -) 66kW 90cv 1398cm3 Hatchback - OPEL CORSA E (X15) 1.4 LPG (08, 68) (De 11.2015 -) 64kW 87cv 1398cm3 Hatchback - OPEL CORSA E (X15) 1.4 LPG (08, 68) (De 03.2015 -) 66kW 90cv 1398cm3 Hatchback - OPEL CORSA E Caixa/parte traseira inclinada (X15) 1.4 (08) (De 09.2014 -) 55kW 75cv ...</p> <p>d30mm (22 dentes) ...</p>		<p>UMB84029 NO. 2060946</p> <p>TAMPÃO BLOCO MOTOR</p> <p>OPEL CORSA E (X15) 1.6 Turbo (08, 68) (A Partir de 03.15) 207cv 1598cc Hatchback -</p> <p>d36x10mm di-32mm</p>
	<p>UTR0856 NO. 1305248 - 13502353</p> <p>TAMPÃO RESERVATÓRIO LIQUIDO REFRIGERAÇÃO</p> <p>OPEL CORSA E (X15) 1.0 (08 - 68) (De 09-2014 Até .1-20 -) 66kW 90CV 999cc Hatchback OPEL CORSA E (X15) 1.0 (08 - 68) (De 09-2014 Até .1-20 -) 85KW 115CV 999cc Hatchback OPEL CORSA E (X15) 1.2 (08 - 68) (De 09-2014 Até .1-20 -) 51kW 69CV 1229cc Hatchback OPEL CORSA E (X15) 1.4 (08 - 68) (De 09-2014 Até .1-20 -) 55KW 75CV 1398cc Hatchback OPEL CORSA E (X15) 1.4 (08 - 68) (De 09-2014 Até .1-20 -) 66k...</p> <p>65x35mm 1f-d52x10mm</p>		<p>UTR0862 NO. 1305248 - 13502353</p> <p>TAMPÃO RESERVATÓRIO LIQUIDO REFRIGERAÇÃO</p> <p>OPEL CORSA E (X15) 1.0 (08 - 68) (De 09-2014 Até .1-20 -) 66kW 90CV 999cc Hatchback OPEL CORSA E (X15) 1.0 (08 - 68) (De 09-2014 Até .1-20 -) 85KW 115CV 999cc Hatchback OPEL CORSA E (X15) 1.2 (08 - 68) (De 09-2014 Até .1-20 -) 51kW 69CV 1229cc Hatchback OPEL CORSA E (X15) 1.4 (08 - 68) (De 09-2014 Até .1-20 -) 55KW 75CV 1398cc Hatchback OPEL CORSA E (X15) 1.4 (08 - 68) (De 09-2014 Até .1-20 -) 66k...</p> <p>d65x35mm d48x15mm 1p-d39x32mm</p>



	<p>Z55280 NO. 2228839</p> <p>MOLA PAINEL REVESTIMENTO DAS PORTAS</p> <p>OPEL CORSA E (X15) 1.0 (08, 68) desde 09.2014 66KW 90CV 999CC D 10 XFL F 10 XFL B 10 XFL 0035BGU 0035BCE 0035BCO 1844ACM 1844ADD - OPEL CORSA E (X15) 1.0 (08, 68) desde 09.2014 85KW 115CV 999CC B 10 XFT D 10 XFT 0035BGV 0035BCF 0035BCP 1844ACO 1844ADE - OPEL CORSA E (X15) 1.2 (08, 68) desde 09.2014 51KW 69CV 1229CC B 12 XEL D 12 XEL 0035BGP 0035BBZ 0035BCJ 1844ACP 1844ADF - OPEL CORSA E (X15) 1.3 ...</p> <p>F-G-mm T-27L-18H-12S-5mm</p>		<p>Z57101 NO. 13252119</p> <p>MOLA DO PAINEL DA PORTA</p> <p>OPEL CORSA E (A partir de 2014)</p> <p>F9mm T17mm L15mm H20mm S1-6mm</p>
	<p>Z71500 NO. 13252118</p> <p>MOLA DO PAINEL DA PORTA</p> <p>OPEL CORSA E (A partir de 2014)</p> <p>F9mm T17mm L14mm H20mm S1-7mm</p>		

OPEL CROSSLAND - CROSSLAND-X - MERIVA

	<p>A1635 NO. 0684183 - 0684184 - 09227880 - 24467436 - 5684646 - 644184 - 684183 - 9227880 - 9227881 - 93183223</p> <p>APOIO DO MOTOR PARTE DA FRENTE DIREITO</p> <p>OPEL MERIVA 1.6 - 1.6 16v - 1.8</p> <p>170x110x120mm</p>		<p>A1692 NO. 5682519 - 90538582</p> <p>APOIO DO MOTOR PARTE DE TRÁS</p> <p>OPEL MERIVA</p> <p>155x125x92mm 1f-d12mm</p>
	<p>A1944 NO. 13159993 - 5684651</p> <p>APOIO MOTOR ESQUERDO</p> <p>OPEL MERIVA B 1.4 (A Partir de 06.10) 100cv 1398cc Veículo multiuso - OPEL MERIVA B 1.4 (A Partir de 06.10) 120cv 1364cc Veículo multiuso - OPEL MERIVA B 1.4 LPG (A Partir de 06.11) 120cv 1364cc Veículo multiuso - OPEL MERIVA B 1.3 CDTI (A Partir de 06.10) 95cv 1248cc Veículo multiuso</p> <p>165x110x70mm 1f-d13mm 4f-d9mm 1p-8x18mm</p>		<p>A2051 NO. 344963 - 55701796</p> <p>APOIO PRATO AMORTECEDOR FRENTE (GASTA 2 UNIDADES)</p> <p>OPEL MERIVA B Veículo multiuso (S10): 1.4 (75) 06.2010/03.2017 74KW 100CV 1398CC - OPEL MERIVA B Veículo multiuso (S10): 1.4 (75) 06.2010/03.2017 88KW 120CV 1364CC - OPEL MERIVA B Veículo multiuso (S10): 1.4 LPG (75) 06.2011/03.2017 88KW 120CV 1364CC - OPEL MERIVA B Veículo multiuso (S10): 1.4 (75) 06.2010/03.2017 103KW 140CV 1364CC - OPEL MERIVA B Veículo multiuso (S10): 1.3 CDTI (75) 06.2010/10....</p> <p>d68x10mm 1f-d12mm</p>
	<p>A2059 NO. 24459803 - 5684137</p> <p>APOIO DO MOTOR PARTE DA FRENTE</p> <p>OPEL MERIVA B Veículo multiuso (S10) 1.4 (75) (De 06-2010 Até .1-20 -) 74kW 100CV 1398cc Veículo multiuso - OPEL MERIVA B Veículo multiuso (S10) 1.4 (75) (De 06-2010 Até .1-20 -) 88kW 120CV 1364cc Veículo multiuso - OPEL MERIVA B Veículo multiuso (S10) 1.4 LPG (75) (De 06-2011 Até .1-20 -) 88kW 120CV 1364cc Veículo multiuso</p> <p>222x91x74mm 2f-d13mm 1f-d16mm</p>		<p>A2069 NO. 0684238 - 184398A - 24416545 - 684238 - 93302281</p> <p>APOIO MOTOR FRENTE CENTRO</p> <p>OPEL MERIVA A Veículo multiuso (X03) 1.4 16V Twinport (E75) (De 07-2004 Até 05-2010) 66kW 90CV 1364cc Veículo multiuso - OPEL MERIVA A Veículo multiuso (X03) 1.6 (E75) (De 05-2003 Até 05-2010) 64kW 87CV 1598cc Veículo multiuso - OPEL MERIVA A Veículo multiuso (X03) 1.6 16V (E75) (De 05-2003 Até 01-2006) 74kW 100CV 1598cc Veículo multiuso - OPEL MERIVA A Veículo multiuso (X03) 1.6 (E75) (De 01-2006 At...)</p> <p>204x94x84mm 1f-d16mm 2f-d12mm</p>
	<p>A2180 NO. 24463129 - 5684172</p> <p>APOIO DO MOTOR PARTE DA FRENTE</p> <p>OPEL MERIVA A Veículo multiuso (X03) 1.7 CDTI (E75) (De 2003.09 Até 2010.05) 74kW 100cv 1686cm3 Veículo multiuso - OPEL MERIVA A Veículo multiuso (X03) 1.7 CDTI (E75) (De 2006.09 Até 2010.05) 92kW 125cv 1686cm3 Veículo multiuso - OPEL MERIVA B Veículo multiuso (S10) 1.7 CDTI (75) (De 2010.06 Até 2017.01) 74kW 100cv 1686cm3 Veículo multiuso - OPEL MERIVA B Veículo multiuso (S10) 1.7 ...</p> <p>186x115x105mm 1f-d16mm 2f-d12mm</p>		<p>A2301 NO. 0684180 - 0684181 - 09227878 - 09227879 - 13125209 - 5684168 - 5684170</p> <p>APOIO DO MOTOR LADO DIREITO</p> <p>OPEL MERIVA A Veículo multiuso (X03) 1.4 16V Twinport (E75) (De 2004.07 Até 2010.05) 66kW 90cv 1364cm3 Veículo multiuso -</p> <p>175x117x100mm 2f-d11mm 2f-d17mm</p>
	<p>A2594 NO. 13109203 - 5684761</p> <p>APOIO DO MOTOR PARTE DA FRENTE LADO ESQUERDO</p> <p>OPEL MERIVA A Veículo multiuso (X03) 1.3 CDTI (E75) (De 04.2005 Até 05.2010) 51kW 69cv 1248cm3 Veículo multiuso - OPEL MERIVA A Veículo multiuso (X03) 1.3 CDTI (E75) (De 09.2003 Até 05.2010) 55kW 75cv 1248cm3 Veículo multiuso - OPEL MERIVA A Veículo multiuso (X03) 1.7 DTI (E75) (De 09.2003 Até 05.2010) 55kW 75cv 1686cm3 Veículo multiuso -</p> <p>175x114x140mm 2f-d19mm 4f-d9mm</p>		<p>BE22 NO. 4401363 - 4501620 - 860151</p> <p>ABRAÇADEIRA ESCAPE</p> <p>OPEL MERIVA B Veículo multiuso (S10): 1.3 CDTI (75) 06.2010/10.2013 55KW 75CV 1248CC - OPEL MERIVA B Veículo multiuso (S10): 1.3 CDTI (75) 06.2010/11.2014 70KW 95K 1248CC</p> <p>96x100x18mm 1p-d10-75mm</p>

	<p>C0233 NO. 1160724 - 90054143</p> <p>BOTÃO AFINAÇÃO CAPÔT</p> <p>OPEL MERIVA 1.4 16V Twinport (07.04 A 05.10) 90cv 1364cc Veículo multiuso - OPEL MERIVA 1.4 16V Twinport LPG (07.04 A 05.10) 90cv 1364cc Veículo multiuso - OPEL MERIVA 1.6 (05.03 A 05.10) 87cv 1598cc Veículo multiuso - OPEL MERIVA 1.6 16V (05.03 A 01.06) 100cv 1598cc Veículo multiuso - OPEL MERIVA 1.6 (01.06 A 05.10) 105cv 1598cc Veículo multiuso - OPEL MERIVA 1.6 Turbo (09.05 A 05.10) ...</p> <p>d19x31mm</p>		<p>E0163 NO. 0350611 - 0350614 - 13169439 - 350611 - 350614 - 90498745</p> <p>ESTICADOR DA BARRA ESTABILIZADORA DA FRENTE</p> <p>OPEL MERIVA B Veículo multiuso (S10): 1.4 (75) 06.2010/03.2017 74KW 100CV 1398CC - OPEL MERIVA B Veículo multiuso (S10): 1.4 (75) 06.2010/03.2017 88KW 120CV 1364CC - OPEL MERIVA B Veículo multiuso (S10): 1.4 LPG (75) 06.2011/03.2017 88KW 120CV 1364CC - OPEL MERIVA B Veículo multiuso (S10): 1.4 (75) 06.2010/03.2017 103KW 140CV 1364CC - OPEL MERIVA B Veículo multiuso (S10): 1.3 CDTI (75) 06.2010/11....</p> <p>340x37x37mm 2p-d12-25mm</p>
	<p>E0601-M NO. 50510781 - 55703436</p> <p>ESTICADOR SUPORTE APOIO MOTOR TRAS</p> <p>OPEL MERIVA B Veículo multiuso (S10): 1.4 (75) 06.2010/03.2017 74KW 100CV 1398CC - OPEL MERIVA B Veículo multiuso (S10): 1.3 CDTI (75) 06.2010/11.2014 70KW 95CV 1248CC</p> <p>210x97x46mm 1f-d12mm 1f-d13mm 1r-d10mm</p>		<p>E0639-M NO. 0846034 - 13143386 - 846034</p> <p>ESTICADOR SUPORTE APOIO MOTOR TRAS</p> <p>OPEL MERIVA A Veículo multiuso (X03) 1.3 CDTI (E75) 09.2003/05.2010 55KW 75CV 1248CC Z 13 DTJ 0035AAC - OPEL MERIVA A Veículo multiuso (X03) 1.3 CDTI (E75) 04.2005/05.2010 51KW 69CV 1248CC Y 13 DT Z 13 DT 0035AAT 0035543 - OPEL MERIVA A Veículo multiuso (X03) 1.4 16V Twinport (E75) 07.2004/05.2010 66KW 90CV 1364CC Z 14 XEP 0035AAU 0035538 - OPEL MERIVA A Veículo multiuso (X03) 1.4 16V Twinport LPG...</p> <p>223x111x57mm 2f-d12mm 1f-13x19mm</p>
	<p>E0653-M NO. 0684717 - 13117088 - 684717</p> <p>ESTICADOR DO MOTOR PARTE DE TRÁS</p> <p>OPEL MERIVA A Veículo multiuso (X03) 1.3 CDTI (E75) (04.2005 - 05.2010) 51kw 69cv 1248cm3 Veículo multiuso OPEL MERIVA A Veículo multiuso (X03) 1.3 CDTI (E75) (09.2003 - 05.2010) 55kw 75cv 1248cm3 Veículo multiuso OPEL MERIVA A Veículo multiuso (X03) 1.4 16V Twinport (E75) (07.2004 - 05.2010) 66kw 90cv 1364cm3 Veículo multiuso OPEL MERIVA A Veículo multiuso (X03) 1.4 16V Twinport LPG (E75) (07.2004...)</p> <p>215x101x44mm 1f-d12mm 1r-d10mm 1f-d12mm</p>		<p>E1092 NO. 0852726 - 13276148 - 852577 - 852726 - 90466668</p> <p>ESTICADOR DE ESCAPE</p> <p>OPEL MERIVA A Veículo multiuso (X03): 1.4 16V Twinport (E75) 07.2004/05.2010 66KW 90CV 1364CC - OPEL MERIVA A Veículo multiuso (X03): 1.4 16V Twinport LPG (E75) 07.2004/05.2010 66KW 90CV 1364CC - OPEL MERIVA A Veículo multiuso (X03): 1.6 (E75) 05.2003/05.2010 64KW 87CV 1598CC - OPEL MERIVA A Veículo multiuso (X03): 1.6 16V (E75) 05.2003/01.2006 74KW 100CV 1598CC - OPEL MERIVA A Veículo multiuso (X...)</p> <p>55x40x35mm</p>
	<p>F1842-I NO. 1142813 - 1603250 - 2561-4A084-BA - 39741-AY125 - 39741-BM526 - 39741-BM528 - 44315-SA7-981 - 470743...</p> <p>FOLE DA TRANSMISSÃO JUNTO À CAIXA</p> <p>OPEL MERIVA 1.6i - 1.6i 16V - 1.8i 16V (APÓS 2003)</p> <p>d82x87mm 1f-d75mm 1f-d20mm</p>		<p>F3773-T NO. 39241BM525 - 39241BM526 - 39241BM527</p> <p>FOLE TRANSMISSÃO JUNTO À RODA</p> <p>OPEL MERIVA</p> <p>d93x121mm 1f-d76mm 1f-d23mm</p>
	<p>F4093 NO. 0738423 - 09200970 - 738423 - 9200970</p> <p>FOLE ALAVANCA VELOCIDADES</p> <p>OPEL MERIVA A Veículo multiuso (X03): 1.4 16V Twinport (E75) 07.2004/05.2010 66KW 90CV 1364CC - OPEL MERIVA A Veículo multiuso (X03): 1.4 16V Twinport LPG (E75) 07.2004/05.2010 66KW 90CV 1364CC - OPEL MERIVA A Veículo multiuso (X03): 1.6 (E75) 05.2003/05.2010 64KW 87CV 1598CC - OPEL MERIVA A Veículo multiuso (X03): 1.6 16V (E75) 05.2003/01.2006 74KW 100CV 1598CC - OPEL MERIVA A Veículo multiuso (X...)</p> <p>160x110x170mm 1f-d50mm</p>		<p>F4098 NO. 5738416 - 93181112</p> <p>FOLE ALAVANCA VELOCIDADES</p> <p>OPEL MERIVA A Veículo multiuso (X03): 1.4 16V Twinport (E75) 07.2004/05.2010 66KW 90CV 1364CC - OPEL MERIVA A Veículo multiuso (X03): 1.4 16V Twinport LPG (E75) 07.2004/05.2010 66KW 90CV 1364CC - OPEL MERIVA A Veículo multiuso (X03): 1.6 (E75) 05.2003/05.2010 64KW 87CV 1598CC - OPEL MERIVA A Veículo multiuso (X03): 1.6 16V (E75) 05.2003/01.2006 74KW 100CV 1598CC - OPEL MERIVA A Veículo multiuso (X...)</p> <p>180x120x170mm 1f-d50mm 1f-155x105mm</p>
	<p>KF1842-I NO. 1603250</p> <p>FOLE DA TRANSMISSÃO JUNTO À CAIXA</p> <p>OPEL MERIVA A Veículo multiuso (X03) 1.6 (E75) 05.2003/05.2010 64KW 87CV 1598CC Z 16 SE 0035481 - OPEL MERIVA A Veículo multiuso (X03) 1.6 16V (E75) 05.2003/01.2006 74KW 100CV 1598CC Z 16 XE 0035AAV 0035482</p> <p>d83x86mm 1f-d19mm 1f-d72mm</p>		<p>KF1845-I NO. 1603004 - 1603230 - 26073421 - 26094870</p> <p>KIT FOLE TRANSMISSÃO JUNTO À CAIXA</p> <p>OPEL MERIVA 1.4 16V Twinport (07.04 A 05.10) 90cv 1364cc Veículo multiuso - OPEL MERIVA 1.6 (05.03 A 05.10) 87cv 1598cc Veículo multiuso - OPEL MERIVA 1.6 16V (05.03 A 01.06) 100cv 1598cc Veículo multiuso - OPEL MERIVA 1.6 (01.06 A 05.10) 105cv 1598cc Veículo multiuso</p> <p>d81x95mm 1f-d72mm 1f-d22mm</p>
	<p>KF2271-T NO. 1603259 - 374434</p> <p>KIT DE FOLE DO CARDAN JUNTO À RODA</p> <p>OPEL MERIVA 1.7 CDTi 16v - 1.7 DTi (APÓS 2003)</p> <p>d105x125mm 1f-d83mm 1f-d25mm</p>		<p>KF3760-T NO. 09201727 - 1603012 - 96391553 - 96489655</p> <p>KIT DE FOLE DO CARDAN JUNTO À RODA</p> <p>OPEL MERIVA</p> <p>d106x122mm 1f-d82mm 1f-d24mm</p>
	<p>KL80449 NO. 198283 - 607813 - 90412865</p> <p>KIT CASQUILHOS COBERTURA TAMPA MOTOR</p> <p>OPEL MERIVA A Veículo multiuso (X03): 1.4 16V Twinport (E75) 07.2004/05.2010 66KW 90CV 1364CC - OPEL MERIVA A Veículo multiuso (X03): 1.4 16V Twinport LPG (E75) 07.2004/05.2010 66KW 90CV 1364CC - OPEL MERIVA A Veículo multiuso (X03): 1.8 (E75) 05.2003/05.2010 92KW 125CV 1796CC - OPEL MERIVA A Veículo multiuso (X03): 1.7 CDTI (E75) 09.2003/05.2010 74KW 100CV 1686CC</p> <p>d16x10mm 1f-d6mm</p>		<p>KL80932 NO. 1p-d6-10mm d-20/10mm 1f-d14mm 1f-d</p> <p>KIT CASQUILHO COBERTURA TAMPA MOTOR</p> <p>OPEL MERIVA</p> <p>d30/75mm d-33/19mm d-39/26mm d-20/10mm 1f-d14mm 1f-d22mm...</p>

	<p>P1103 NO. 0560804 - 09191205 - 560804 - 9191205</p> <p>CAPA PEDAL TRAVÃO (VEÍCULOS CAIXA AUTOMÁTICA)</p> <p>OPEL MERIVA A Veículo multiuso (X03) 1.3 CDTI (E75) 09.2003/05.2010 55KW 75CV 1248CC Z 13 DTJ 0035AAC - OPEL MERIVA A Veículo multiuso (X03) 1.3 CDTI (E75) 04.2005/05.2010 51KW 69CV 1248CC Y 13 DT Z 13 DT 0035AAT 0035543 - OPEL MERIVA A Veículo multiuso (X03) 1.4 16V Twinport (E75) 07.2004/05.2010 66KW 90CV 1364CC Z 14 XEP 0035AAU 0035538 - OPEL MERIVA A Veículo multiuso (X03) 1.4 16V Twinport LPG...</p> <p>110x65x45mm</p>		<p>Q2013 NO. 173633 - 4411730 - 4418063 - 4433515</p> <p>UNIÃO DO ESCAPE 60x64,5x90mm</p> <p>OPEL MERIVA</p> <p>90x70x92mm 1f-d60mm</p>
	<p>R015005 NO. ch-d8(f-d3mm)x260mm 4bicos-d6mm(f-</p> <p>TUBO EXTRACTOR COMBUSTIVEL INJECTORES</p> <p>OPEL MERIVA A Veículo multiuso (X03) 1.7 CDTI (E75) (De 09.2003 Até 05.2010) 74kW 100cv 1686cm3 Veículo multiuso -</p> <p>324mm ch-d8(f-d3mm)x260mm 4bicos-d6mm(f-d2</p>		<p>R016261 NO. 55240933 - 860334 - 860415 - 861021</p> <p>TUBO DO OLEO DO COMPRESSOR</p> <p>OPEL MERIVA B VAN (S10) 1.3 CDTI (75) 01.2013/11.2014 70KW 95CV 1248CC A 13 DTE - OPEL MERIVA B Veículo multiuso (S10) 1.3 CDTI (75) 06.2010/11.2014 70KW 95CV 1248CC A 13 DTE 0035AMX</p> <p>B105-14/15mm 40x40x39mm</p>
	<p>R017112 NO. 5851946 - 93177469</p> <p>TUBO DA VALVULA REGULADORA DE VELOCIDADE</p> <p>OPEL MERIVA A Veículo multiuso (X03): 1.3 CDTI (E75) 04.2005/05.2010 51KW 69CV 1248CC - OPEL MERIVA A Veículo multiuso (X03): 1.3 CDTI (E75) 09.2003/05.2010 55KW 75CV 1248CC</p> <p>B133-14/14mm 39x64x29x51mm</p>		<p>R080253 NO. 06336007 - 09128719</p> <p>TUBO LÍQUIDO REFRIGERAÇÃO</p> <p>OPEL MERIVA A Veículo multiuso (X03) 1.6 (E75) 05.2003/05.2010 64KW 87CV 1598CC Z 16 SE 0035481 - OPEL MERIVA A Veículo multiuso (X03) 1.6 16V (E75) 05.2003/01.2006 74KW 100CV 1598CC Z 16 XE 0035AAV 0035482</p> <p>B340-30/35mm ch-d13-29mm ch-d13-30mm</p>
	<p>R220256 NO. 1818546 - 24423509</p> <p>TUBO DO PERMUTADOR DE CALOR DO ARREFECIMENTO</p> <p>OPEL MERIVA A Veículo multiuso (X03) 1.6 (E75) 05.2003/05.2010 64KW 87CV 1598CC Z 16 SE 0035481 - OPEL MERIVA A Veículo multiuso (X03) 1.6 (E75) 01.2006/05.2010 77KW 105CV 1598CC Z 16 XEP 0035AAB - OPEL MERIVA A Veículo multiuso (X03) 1.6 16V (E75) 05.2003/01.2006 74KW 100CV 1598CC Z 16 XE 0035AAV 0035482 - OPEL MERIVA A Veículo multiuso (X03) 1.8 (E75) 05.2003/05.2010 92KW 125CV 1796CC Z 18 XE 00...</p> <p>B257x18/19mm 89x79x38x42x60mm</p>		<p>R221710 NO. 24457200 - 6818561</p> <p>TUBO DO PERMUTADOR DE CALOR DO AQUECIMENTO</p> <p>OPEL MERIVA A Veículo multiuso (X03) 1.7 CDTI (E75) (De 2003.09 Até 2010.05) 74kW 100cv 1686cm3 Veículo multiuso -</p> <p>B330-18/22mm 36x66x125x36x70mm ch-d22x43x22x30mm</p>
	<p>R221743 NO. 055351522 - 05656121 - 0656092 - 55578995 - 5656121 - 656092</p> <p>TUBO RESPIRO DO CARTER CAMBOTA</p> <p>OPEL MERIVA A Veículo multiuso (X03) 1.4 16V Twinport (E75) (07.2004 - 05.2010) 66kw 90cv 1364cm3 Veículo multiuso OPEL MERIVA A Veículo multiuso (X03) 1.4 16V Twinport LPG (E75) (07.2004 - 05.2010) 66kw 90cv 1364cm3 Veículo multiuso</p> <p>boca a boca175mmd1-15mm220mm75-73</p>		<p>R221748 NO. 5851946 - 93177469</p> <p>TUBO DA VALVULA REGULADORA DE VELOCIDADE</p> <p>OPEL MERIVA A Veículo multiuso (X03) 1.3 CDTI (E75) 04.2005/05.2010 51KW 69CV 1248CC Y 13 DT Z 13 DT 0035AAT 0035543</p> <p>B140-17/17mm 70x30x80x35mm</p>
	<p>R222763 NO. 09202288 - 5860742 - 9202288</p> <p>TUBO DO AR SOBREALIMENTAÇÃO</p> <p>OPEL MERIVA A Veículo multiuso (X03) 1.7 CDTI (E75) 09.2003/05.2010 74KW 100CV 1686CC Z 17 DT Z 17 DTH 0035AAS 0035516</p> <p>B132-35/35mm 180-65-180mm</p>		<p>R222790 NO. 13157692 - 6818557</p> <p>TUBO DO PERMUTADOR DO CALOR AO AQUECIMENTO</p> <p>OPEL MERIVA A Veículo multiuso (X03) 1.3 CDTI (E75) (De 2005.04 Até 2010.05) 51kW 69cv 1248cm3 Veículo multiuso - OPEL MERIVA A Veículo multiuso (X03) 1.3 CDTI (E75) (De 2003.09 Até 2010.05) 55kW 75cv 1248cm3 Veículo multiuso -</p> <p>B230-19/19mm 38x40x72x49x58mm</p>
	<p>R222827 NO. 6336084 - 97300149</p> <p>TUBO LIGAÇÃO TERMOSTATO</p> <p>OPEL MERIVA A Veículo multiuso (X03) 1.7 CDTI (E75) (De 09-2003 Até 05-2010) 74kW 100CV 1686cc Veículo multiuso</p> <p>B115-15/15mm 39-45-39mm</p>		<p>R222828 NO. 97351101</p> <p>TUBO DO RADIADOR</p> <p>OPEL MERIVA A Veículo multiuso (X03) 1.7 DTI (E75) (De 09-2003 Até 05-2010) 55kW 75CV 1686cc Veículo multiuso OPEL MERIVA A Veículo multiuso (X03) 1.7 CDTI (E75) (De 09-2003 Até 05-2010) 74kW 100CV 1686cc Veículo multiuso</p> <p>B165-13/13mm 34-41-47-51mm</p>
	<p>R222857 NO. 13157694 - 6818559</p> <p>TUBO DO PERMUTADOR DO CALOR DO AQUECIMENTO</p> <p>OPEL MERIVA A Veículo multiuso (X03) 1.3 CDTI (E75) (De 2005.04 Até 2010.05) 51kW 69cv 1248cm3 Veículo multiuso - OPEL MERIVA A Veículo multiuso (X03) 1.3 CDTI (E75) (De 2003.09 Até 2010.05) 55kW 75cv 1248cm3 Veículo multiuso -</p> <p>B213-19/21mm 46x51x65x66mm</p>		<p>R222870 NO. 13157692 - 13157694 - 6818557 - 6818559</p> <p>TUBO DO PERMUTADOR DE CALOR AO AQUECIMENTO</p> <p>OPEL MERIVA A Veículo multiuso (X03) 1.3 CDTI (E75) 09.2003/05.2010 55KW 75CV 1248CC Z 13 DTJ 0035AAC - OPEL MERIVA A Veículo multiuso (X03) 1.3 CDTI (E75) 04.2005/05.2010 51KW 69CV 1248CC Y 13 DT Z 13 DT 0035AAT 0035543</p> <p>B215-19/24mm(x2) 44-46-65-70mm</p>

	<p>R225298 NO. 5835870 - 93329873</p> <p>TUBO DO AR SOBRELIMENTAÇÃO</p> <p>OPEL MERIVA A Veículo multiuso (X03) 1.7 CDTI (E75) (09.2003 - 05.2010) 74kw 100cv 1686cm3 Veículo multiuso</p> <p>B545-d38/d39mm 71-66-150-74-108-87mm</p>		<p>R225493 NO. 3647457 - 9820100780</p> <p>TUBO DO AR SOBRELIMENTAÇÃO</p> <p>OPEL CROSSLAND X / CROSSLAND (P17, P2QO) 1.2 (75) (03.2017 -) 81kw 110cv 1199cm3 SUV OPEL CROSSLAND X / CROSSLAND (P17, P2QO) 1.2 (75) (03.2017 -) 96kw 131cv 1199cm3 SUV OPEL CROSSLAND X / CROSSLAND (P17, P2QO) 1.5 (75) (10.2020 -) 81kw 110cv 1499cm3 SUV OPEL CROSSLAND X / CROSSLAND (P17, P2QO) 1.5 Turbo D (75) (06.2018 -) 75kw 102cv 1499cm3 SUV OPEL CROSSLAND X / CROSSLAND (P17, P2QO) 1.5 Turbo D...</p> <p>boca a boca290mmd1-46mmx240mm118-85-83-62-156-77</p>
	<p>RT80582 NO. 5562248</p> <p>TUBO DE TRAVÃO TRÁS RH (COM DISCO)</p> <p>OPEL MERIVA 1.3 CDTI (motor Z 13 DT) (APÓS 04-2005) - 1.3 CDTi (motor Z 13 DTJ) (APÓS 09-2003) - 1.4 16V TWINPORT (motor Z 14 XEP) (APÓS 07-2004) - 1.6 (motor Z 16 SE) (APÓS 05-2003) - 1.6 (motor Z 16 XEP) (APÓS 01-2006) - 1.6 16V (motor Z 16 XE) (APÓS 05</p> <p>760mm</p>		<p>RT80583 NO. 5562247</p> <p>TUBO DE TRAVÃO TRÁS LH (COM DISCO)</p> <p>OPEL MERIVA 1.3 CDTi (motor Z 13 DT) (APÓS 04-2005) - 1.3 CDTi (motor Z 13 DTJ) (APÓS 09-2003) - 1.4 16V TWINPORT (motor Z 14 XEP) (APÓS 07-2004) - 1.6 (motor Z 16 SE) (APÓS 05-2003) - 1.6 (motor Z 16 XEP) (APÓS 01-2006) - 1.6 16V (motor Z 16 XE) (APÓS 05</p> <p>760mm</p>
	<p>S1441 NO. 13138151 - 13138151-24430103 - 24430103 - 352320</p> <p>SILENT-BLOC DO BRAÇO DA SUSPENSÃO DA FRENTE</p> <p>OPEL MERIVA 1.4 16v - 1.6 - 1.616v - 1.7 16v CDTi - 1.7 16v DTi - 1.8 16v</p> <p>d60x45mm c27mm 1f-d12.6mm</p>		<p>S1978 NO. 0352324</p> <p>SILENT-BLOC DO BRAÇO SUSPENSÃO FRENTE PARTE DE TRÁS</p> <p>OPEL MERIVA B VAN (S10) 1.3 CDTI (75) (De 01.2013 Até 11.2014) 70kW 95cv 1248cm3 Caixa/monovolume - OPEL MERIVA B VAN (S10) 1.4 ECOTEC (75) (De 01.2013 Até 03.2017) 74kW 101cv 1398cm3 Caixa/monovolume - OPEL MERIVA B VAN (S10) 1.6 CDTI (75) (De 01.2014 Até 01.2017) 70kW 95cv 1598cm3 Caixa/monovolume - OPEL MERIVA B VAN (S10) 1.6 CDTI (75) (De 03.2014 Até 03.2017) 81kW 110cv 1598cm3 Caixa/monovolum...</p> <p>d60x 59mm c-45mm dc-46mm1f-d12mm</p>
	<p>S1990 NO. 0402952 - 13110418 - 13267215 - 13267216 - 402952 - 5402637 - 5402639</p> <p>SILENT-BLOC DO EIXO DA SUSPENSÃO DE TRÁS DIREITO E ESQUERDO</p> <p>OPEL MERIVA B Veículo multiuso (S10) 1.3 CDTI (75) (De 06.2010 Até 10.2013) 55kW 75cv 1248cm3 Veículo multiuso - OPEL MERIVA B Veículo multiuso (S10) 1.3 CDTI (75) (De 06.2010 Até 11.2014) 70kW 95cv 1248cm3 Veículo multiuso - OPEL MERIVA B Veículo multiuso (S10) 1.4 (75) (De 06.2010 Até 03.2017) 74kW 100cv 1398cm3 Veículo multiuso - OPEL MERIVA B Veículo multiuso (S10) 1.4 (75) (De 06.2010 Até 03.2017) 74kW 100cv 1398cm3 Veículo multiuso - OPEL MERIVA B Veículo multiuso (S10) 1.4 (75) (De 06.2010 Até 03....</p> <p>d85x 90mm c-55mm dc-70mm1f-d13mm</p>		<p>U0314 NO. 0424761</p> <p>ANILHA DA SUSPENSÃO DAS MOLAS DE TRÁS INFERIOR</p> <p>OPEL MERIVA A Veículo multiuso (X03) 1.3 CDTI (E75) (04.2005 - 05.2010) 51kw 69cv 1248cm3 Veículo multiuso OPEL MERIVA A Veículo multiuso (X03) 1.3 CDTI (E75) (09.2003 - 05.2010) 55kw 75cv 1248cm3 Veículo multiuso OPEL MERIVA A Veículo multiuso (X03) 1.4 16V Twinport (E75) (07.2004 - 05.2010) 66kw 90cv 1364cm3 Veículo multiuso OPEL MERIVA A Veículo multiuso (X03) 1.4 16V Twinport LPG (E75) (07.200...</p> <p>d132x22mm 1f-d33mm</p>
	<p>U0314 NO. 0424761</p> <p>ANILHA DA SUSPENSÃO DAS MOLAS DE TRÁS INFERIOR</p> <p>OPEL MERIVA B VAN (S10) 1.3 CDTI (75) (01.2013 - 11.2014) 70kw 95cv 1248cm3 Caixa/monovolume OPEL MERIVA B VAN (S10) 1.4 ECOTEC (75) (01.2013 - 03.2017) 74kw 101cv 1398cm3 Caixa/monovolume OPEL MERIVA B VAN (S10) 1.6 CDTI (75) (01.2014 - 01.2017) 70kw 95cv 1598cm3 Caixa/monovolume OPEL MERIVA B VAN (S10) 1.6 CDTI (75) (03.2014 - 03.2017) 81kw 110cv 1598cm3 Caixa/monovolume OPEL MERIVA B VAN (S10) ...</p> <p>d132x22mm 1f-d33mm</p>		<p>U7004 NO. 5817552 - 90541910</p> <p>ORING DE VÁLVULA INJECTORA (Di 7,52 - De 14,58 - E 3,53)</p> <p>OPEL CROSSLAND X / CROSSLAND (P17, P2QO) 1.2 (75) (03.2017 -) 60kw 82cv 1199cm3 SUV OPEL CROSSLAND X / CROSSLAND (P17, P2QO) 1.2 LPG (75) (10.2017 -) 60kw 82cv 1199cm3 SUV</p> <p>d14x3mm 1f-d8mm</p>
	<p>UAP81292 NO. 0821038 - 0821074 - 0821437 - 0821675 - 4708869 - 4809347 - 821038 - 821074 - 821437 - 821675</p> <p>ANILHA PROTEÇÃO TÉRMICA INJECTORES</p> <p>OPEL MERIVA A Veículo multiuso (X03) 1.3 CDTI (E75) (De 04-2005 Até 05-2010) 51kW 69CV 1248cc Veículo multiuso OPEL MERIVA A Veículo multiuso (X03) 1.3 CDTI (E75) (De 09-2003 Até 05-2010) 55kW 75CV 1248cc Veículo multiuso</p> <p>d16x1mm 1f-d7mm</p>		<p>UAP81292 NO. 0821038 - 0821074 - 0821437 - 0821675 - 4708869 - 4809347 - 821038 - 821074 - 821437 - 821675</p> <p>ANILHA PROTEÇÃO TÉRMICA INJECTORES</p> <p>OPEL MERIVA B Veículo multiuso (S10) 1.3 CDTI (75) (De 06-2010 Até 11-2014) 70kW 95CV 1248cc Veículo multiuso</p> <p>d16x1mm 1f-d7mm</p>
	<p>UAP81292 NO. 0821038 - 0821074 - 0821437 - 0821675 - 4708869 - 4809347 - 821038 - 821074 - 821437 - 821675</p> <p>ANILHA PROTEÇÃO TÉRMICA INJECTORES</p> <p>OPEL MERIVA A Veículo multiuso (X03) 1.3 CDTI (E75) (De 04-2005 Até 05-2010) 51kW 69CV 1248cc Veículo multiuso OPEL MERIVA A Veículo multiuso (X03) 1.3 CDTI (E75) (De 09-2003 Até 05-2010) 55kW 75CV 1248cc Veículo multiuso</p> <p>d16x1mm 1f-d7mm</p>		<p>UAP81292 NO. 0821038 - 0821074 - 0821437 - 0821675 - 4708869 - 4809347 - 821038 - 821074 - 821437 - 821675</p> <p>ANILHA PROTEÇÃO TÉRMICA INJECTORES</p> <p>OPEL MERIVA B Veículo multiuso (S10) 1.3 CDTI (75) (De 06-2010 Até 11-2014) 70kW 95CV 1248cc Veículo multiuso</p> <p>d16x1mm 1f-d7mm</p>
	<p>UMB84011 NO. 031126</p> <p>TAMPÃO BLOCO MOTOR</p> <p>OPEL MERIVA A Veículo multiuso (X03) 1.6 16V (E75) (De 05-2003 Até 01-2006) 74kW 100CV 1598cc Veículo multiuso</p> <p>d-18x8mm di-16mm</p>		<p>UMB84011L NO. 11062402 - 2060675</p> <p>TAMPÃO BLOCO DE MOTOR (RELAS)</p> <p>OPEL MERIVA A Veículo multiuso (X03) 1.6 16V (E75) (De 05-2003 Até 01-2006) 74kW 100CV 1598cc Veículo multiuso</p> <p>d-18x8mm di-16mm</p>

	<p>UMB84019 NO. 2060668</p> <p>TAMPÃO BLOCO MOTOR</p> <p>OPEL MERIVA A Veículo multiuso (X03) 1.6 16V (E75) (De 05-2003 Até 01-2006) 74kW 100CV 1598cc Veículo multiuso OPEL MERIVA A Veículo multiuso (X03) 1.8 (E75) (De 05-2003 Até 05-2010) 92kW 125CV 1796cc Veículo multiuso</p> <p>d-26x9,5mm di-23,3mm</p>		<p>UMB84019L NO. 2060668</p> <p>TAMPÃO BLOCO DE MOTOR (RELAS)</p> <p>OPEL MERIVA A Veículo multiuso (X03) 1.6 16V (E75) (De 05-2003 Até 01-2006) 74kW 100CV 1598cc Veículo multiuso OPEL MERIVA A Veículo multiuso (X03) 1.8 (E75) (De 05-2003 Até 05-2010) 92kW 125CV 1796cc Veículo multiuso</p> <p>d-26x9,5mm di-23,3mm</p>
	<p>UMB84021 NO. 2060673</p> <p>TAMPÃO BLOCO MOTOR</p> <p>OPEL MERIVA A Veículo multiuso (X03) 1.6 16V (E75) (De 05-2003 Até 01-2006) 74kW 100CV 1598cc Veículo multiuso OPEL MERIVA A Veículo multiuso (X03) 1.8 (E75) (De 05-2003 Até 05-2010) 92kW 125CV 1796cc Veículo multiuso</p> <p>d-28x7mm di-25,6mm</p>		<p>UMB84021L NO. 2060673</p> <p>TAMPÃO BLOCO DE MOTOR (RELAS)</p> <p>OPEL MERIVA A Veículo multiuso (X03) 1.6 16V (E75) (De 05-2003 Até 01-2006) 74kW 100CV 1598cc Veículo multiuso OPEL MERIVA A Veículo multiuso (X03) 1.8 (E75) (De 05-2003 Até 05-2010) 92kW 125CV 1796cc Veículo multiuso</p> <p>d-28x7mm di-25,6mm</p>
	<p>UMB84029 NO. 2060946</p> <p>TAMPÃO BLOCO MOTOR</p> <p>OPEL MERIVA A Veículo multiuso (X03) 1.6 (E75) (05.03 A 05.10) 87cv 1598cc Veículo multiuso - OPEL MERIVA A Veículo multiuso (X03) 1.8 (E75) (05.03 A 05.10) 125cv 1796cc Veículo multiuso</p> <p>d36x10mm di-32mm</p>		<p>UMV25434 NO. 5738946 - 93186142</p> <p>MANETE PUNHO TOPO ALAVANCA MUDANÇAS 6 VELOCIDADES F31MM</p> <p>OPEL MERIVA A Veículo multiuso (X03) 1.3 CDTI (E75) 09.2003/05.2010 55KW 75CV 1248CC Z 13 DTJ 0035AAC - OPEL MERIVA A Veículo multiuso (X03) 1.3 CDTI (E75) 04.2005/05.2010 51KW 69CV 1248CC Y 13 DTZ 13 DT 0035AAT 0035543 - OPEL MERIVA A Veículo multiuso (X03) 1.4 16V Twinport (E75) 07.2004/05.2010 66KW 90CV 1364CC Z 14 XEP 0035AAU 0035538 - OPEL MERIVA A Veículo multiuso (X03) 1.4 16V Twinport LPG ...</p> <p>d52x60mm 1f-d31mm</p>
	<p>UMV25441 NO. 55503115 - 565537081 - 3649167 - 55499457 - 55503114 - 55499458 - YQ001073YX</p> <p>MANETE ALAVANCA VELOCIDADES (6V) PRETO/PRATA</p> <p>OPEL CROSSLAND X / CROSSLAND (P17, P2Q0) 1.2 desde 07.2019 61KW 83CV 1199CC F 12 XE (EB2FA) 1844AKG 1844AIN - OPEL CROSSLAND X / CROSSLAND (P17, P2Q0) 1.2 (75) desde 03.2017 60KW 82CV 1199CC D 12 XE (EB2FA) B 12 XE (EB2F) 0035BIZ 1844ADU - OPEL CROSSLAND X / CROSSLAND (P17, P2Q0) 1.2 (75) desde 03.2017 81KW 110CV 1199CC B 12 XHL (EB2DT) D 12 XHL (EB2ADT) F 12 XHL (EB2ADT) 0035BJA 1844AKH 1844ADT ...</p> <p>51x63x52mm 1f-d12mm</p>		<p>UTR0800 NO. 1304240 - 1304654 - 1304659 - 1304660 - 1304661 - 1304665 - 1304666 - 1304667 - 1304853 - 90352470 - ...</p> <p>TAMPÃO RESERVATÓRIO LIQUIDO REFRIGERAÇÃO</p> <p>OPEL MERIVA 1.4 16V Twinport (07.04 A 05.10) 90cv 1364cc Veículo multiuso - OPEL MERIVA 1.4 16V Twinport LPG (07.04 A 05.10) 90cv 1364cc Veículo multiuso - OPEL MERIVA 1.6 (05.03 A 05.10) 87cv 1598cc Veículo multiuso - OPEL MERIVA 1.6 16V (05.03 A 01.06) 100cv 1598cc Veículo multiuso - OPEL MERIVA 1.6 (01.06 A 05.10) 105cv 1598cc Veículo multiuso - OPEL MERIVA 1.6 Turbo (09.05 A 05.10) ...</p> <p>d62x25mm 1f-d53x14mm</p>
	<p>UTR0811 NO. 1304659 - 1304660 - 1304661 - 1304665 - 1304666 - 1304853 - 4395513 - 90352470 - 90409256 - 90409257...</p> <p>TAMPÃO RESERVATÓRIO LIQUIDO REFRIGERAÇÃO</p> <p>OPEL MERIVA 1.7 CDTI (09.03 A 05.10) 100cv 1686cc Veículo multiuso</p> <p>60x25mm 1f-d52x14mm</p>		<p>UTR0820 NO. 90352470 - 90409256 - 90409257 - 9041032690497472 - 90467473</p> <p>TAMPÃO RESERVATÓRIO LIQUIDO REFRIGERAÇÃO</p> <p>OPEL MERIVA 1.4 16V Twinport (07.04 A 05.10) 90cv 1364cc Veículo multiuso - OPEL MERIVA 1.4 16V Twinport LPG (07.04 A 05.10) 90cv 1364cc Veículo multiuso - OPEL MERIVA 1.6 (05.03 - 05.10) 87 1598 Veículo multiuso OPEL MERIVA 1.6 16V 05.03 - 01.06 74 100 1598 Veículo multiuso OPEL MERIVA 1.6 01.06 - 05.10 77 105 1598 Veículo multiuso OPEL MERIVA 1.6 Turbo (09.05 A 05.10) 180cv 1598cc Veículo ...</p> <p>d62x23mm 1f-d53x12mm</p>
	<p>UTR0856 NO. 1305248 - 13502353</p> <p>TAMPÃO RESERVATÓRIO LIQUIDO REFRIGERAÇÃO</p> <p>OPEL MERIVA B 1.4 (A Partir de 06.10) 100cv 1398cc Veículo multiuso - OPEL MERIVA B 1.4 (A Partir de 06.10) 120cv 1364cc Veículo multiuso - OPEL MERIVA B 1.4 LPG (A Partir de 06.11) 120cv 1364cc Veículo multiuso - OPEL MERIVA B 1.4 (A Partir de 06.10) 140cv 1364cc Veículo multiuso - OPEL MERIVA B 1.3 CDTI (A Partir de 06.10) 75cv 1248cc Veículo multiuso - OPEL MERIVA B 1.3 CDTI (A Partir...</p> <p>65x35mm 1f-d52x10mm</p>		<p>UTR0856 NO. 1305248 - 13502353</p> <p>TAMPÃO RESERVATÓRIO LIQUIDO REFRIGERAÇÃO</p> <p>OPEL MERIVA B Veículo multiuso (S10) 1.4 (75) (De 06-2010 Até .1-20 -) 74kW 100CV 1398cc Veículo multiuso OPEL MERIVA B Veículo multiuso (S10) 1.4 (75) (De 06-2010 Até .1-20 -) 88kW 120CV 1364cc Veículo multiuso OPEL MERIVA B Veículo multiuso (S10) 1.4 LPG (75) (De 06-2011 Até .1-20 -) 88kW 120CV 1364cc Veículo multiuso OPEL MERIVA B Veículo multiuso (S10) 1.4 (75) (De 06-2010 Até .1-20 -) 103k...</p> <p>65x35mm 1f-d52x10mm</p>
	<p>UTR0862 NO. 1305248 - 13502353</p> <p>TAMPÃO RESERVATÓRIO LIQUIDO REFRIGERAÇÃO</p> <p>OPEL MERIVA B Veículo multiuso (S10) 1.4 (75) (De 06-2010 Até 03-2017) 74kW 100CV 1398cc Veículo multiuso OPEL MERIVA B Veículo multiuso (S10) 1.4 (75) (De 06-2010 Até 03-2017) 88kW 120CV 1364cc Veículo multiuso OPEL MERIVA B Veículo multiuso (S10) 1.4 LPG (75) (De 06-2011 Até 03-2017) 88kW 120CV 1364cc Veículo multiuso OPEL MERIVA B Veículo multiuso (S10) 1.4 (75) (De 06-2010 Até 03-2017) 103...</p> <p>d65x35mm d48x15mm 1p-d39x32mm</p>		<p>UTR1300 NO. 00650090 - 05650831</p> <p>TAMPÃO RESERVATÓRIO DO OLEO</p> <p>OPEL MERIVA A Veículo multiuso (X03) 1.4 16V Twinport (E75) (De 07-2004 Até 05-2010) 66kW 90CV 1364cc Veículo multiuso OPEL MERIVA A Veículo multiuso (X03) 1.4 16V Twinport LPG (E75) (De 07-2004 Até 05-2010) 66kW 90CV 1364cc Veículo multiuso OPEL MERIVA A Veículo multiuso (X03) 1.6 (E75) (De 01-2006 Até 05-2010) 77kW 105CV 1598cc Veículo multiuso OPEL MERIVA A Veículo multiuso (X03) 1.6 Turbo (...)</p> <p>d59x31mm d45x12mm</p>
	<p>UTR1300 NO. 00650090 - 05650831</p> <p>TAMPÃO RESERVATÓRIO DO OLEO</p> <p>OPEL MERIVA B Veículo multiuso (S10) 1.4 (75) (De 06-2010 Até 03-2017) 88kW 120CV 1364cc Veículo multiuso OPEL MERIVA B Veículo multiuso (S10) 1.4 (75) (De 06-2010 Até 03-2017) 103kW 140CV 1364cc Veículo multiuso OPEL MERIVA B Veículo multiuso (S10) 1.7 CDTI (75) (De 06-2010 Até 01-2017) 74kW 100CV 1686cc Veículo multiuso</p> <p>d59x31mm d45x12mm</p>		<p>UTR1305 NO. 0650089 - 650089</p> <p>TAMPÃO DO RESERVATÓRIO ÓLEO</p> <p>OPEL MERIVA A Veículo multiuso (X03) 1.3 CDTI (E75) (09.2003 -05.2010) 55kW 75cv 1248cm3 Veículo multiuso OPEL MERIVA A Veículo multiuso (X03) 1.4 16V Twinport (E75) (07.2004 -05.2010) 66kW 90cv 1364cm3 Veículo multiuso OPEL MERIVA A Veículo multiuso (X03) 1.6 (E75) (05.2003 -05.2010) 64kW 87cv 1598cm3 Veículo multiuso OPEL MERIVA A Veículo multiuso (X03) 1.6 (E75) (01.2006 -05.2010) 77kW 105cv 15...</p> <p>d61x23mm d32x19mm</p>

	<p>UTR1404 NO. 0808211 - 09117533 - 808211</p> <p>TAMPÃO DEPÓSITO COMBUSTIVEL</p> <p>OPEL MERIVA A Veículo multiuso (X03) 1.3 CDTI (E75) (De 04.2005 Até 05.2010) 51kW 69cv 1248cm3 Veículo multiuso - OPEL MERIVA A Veículo multiuso (X03) 1.3 CDTI (E75) (De 09.2003 Até 05.2010) 55kW 75cv 1248cm3 Veículo multiuso - OPEL MERIVA A Veículo multiuso (X03) 1.7 CDTI (E75) (De 09.2003 Até 05.2010) 74kW 100cv 1686cm3 Veículo multiuso - OPEL MERIVA A Veículo multiuso (X03) 1.7 CDTI (E75) (De 0...</p> <p>d67x62mm d41x45mm</p>		<p>UTV83019 NO. 0652315 - 0652477 - 652315 - 652477 - 90502556 - 96023264</p> <p>TAMPÃO VEDAÇÃO BUJÃO</p> <p>OPEL MERIVA A Veículo multiuso (X03) 1.4 16V Twinport (E75) (De 07-2004 Até 05-2010) 66kW 90CV 1364cc Veículo multiuso OPEL MERIVA A Veículo multiuso (X03) 1.4 16V Twinport LPG (E75) (De 07-2004 Até 05-2010) 66kW 90CV 1364cc Veículo multiuso OPEL MERIVA A Veículo multiuso (X03) 1.6 (E75) (De 05-2003 Até 05-2010) 64kW 87CV 1598cc Veículo multiuso OPEL MERIVA A Veículo multiuso (X03) 1.6 16V (E75...</p> <p>d25x14mm c9mm d13mm</p>
	<p>UTV83019 NO. 0652315 - 0652477 - 652315 - 652477 - 90502556 - 96023264</p> <p>TAMPÃO VEDAÇÃO BUJÃO</p> <p>OPEL MERIVA B Veículo multiuso (S10) 1.4 (75) (De 06-2010 Até 03-2017) 74kW 100CV 1398cc Veículo multiuso OPEL MERIVA B Veículo multiuso (S10) 1.4 (75) (De 06-2010 Até 03-2017) 88kW 120CV 1364cc Veículo multiuso OPEL MERIVA B Veículo multiuso (S10) 1.4 LPG (75) (De 06-2011 Até 03-2017) 88kW 120CV 1364cc Veículo multiuso OPEL MERIVA B Veículo multiuso (S10) 1.4 (75) (De 06-2010 Até 03-2017) 103k...</p> <p>d25x14mm c9mm d13mm</p>		<p>W5054 NO. 0614150 - 5614438 - 614150 - 93177317 - 93194443</p> <p>POLIE DA CAMBOTA (6 PISTAS)</p> <p>OPEL MERIVA 1.3 CDTI Mtr Z13DTJ (75CV) (APÓS 09-2003)</p> <p>d165mm d35mm</p>
	<p>W5080 NO. 5614441 - 5614442 - 97229044 - 97353964</p> <p>POLIE DA CAMBOTA (6 PISTAS)</p> <p>OPEL MERIVA A Veículo multiuso (X03) 1.7 CDTI (E75) 09.2003/05.2010 74KW 100CV 1686CC Z 17 DT Z 17 DTH 0035AAS 0035516</p> <p>d152mm d48mm</p>		<p>W5082 NO. 0614426 - 5614444 - 614426 - 97251975 - 97361525</p> <p>POLIE DA CAMBOTA (6 PISTAS)</p> <p>OPEL MERIVA A Veículo multiuso (X03) 1.7 DTI (E75) 09.2003/05.2010 55KW 75CV 1686CC Y 17 DT 0035AAR 0035484</p> <p>d139/141mm d48mm</p>
	<p>W5107 NO. 5614425 - 5614431 - 9129209</p> <p>POLIE DA CAMBOTA (5 PISTAS)</p> <p>OPEL MERIVA 1.6 16V Z 16 XE 100CV (05-2003 A 05-2010)</p> <p>d160m 1f-d26mm</p>		<p>W5159 NO. 055575960 - 0614172 - 0614758 - 098022837 - 098039173 - 55575960 - 5614450 - 614172 - 614758 - 98022...</p> <p>POLIE CAMBOTA 6 PISTAS</p> <p>OPEL MERIVA A Veículo multiuso (X03) 1.7 CDTI (E75) 09.2006/05.2010 92KW 125CV 1686CC Z 17 DTR 0035AGX - OPEL MERIVA B VAN (S10) 1.7 CDTI (75) 01.2013/01.2017 74KW 101CV 1686CC A 17 DT - OPEL MERIVA B VAN (S10) 1.7 CDTI (75) 01.2013/10.2013 81KW 110CV 1686CC A 17 DTC - OPEL MERIVA B VAN (S10) 1.7 CDTI (75) 01.2013/10.2013 96KW 131CV 1686CC A 17 DTS - OPEL MERIVA B Veículo multiuso (S10) 1.7 CDTI (...)</p> <p>d154mm d48mm</p>
	<p>W5201 NO. 5614423 - 90572867</p> <p>POLIE DA CAMBOTA (5 PISTAS)</p> <p>OPEL MERIVA A Veículo multiuso (X03): 1.4 16V Twinport (E75) 07.2004/05.2010 66KW 90CV 1364CC - OPEL MERIVA A Veículo multiuso (X03): 1.4 16V Twinport LPG (E75) 07.2004/05.2010 66KW 90CV 1364CC</p> <p>d152mm d39mm</p>		<p>Y3212 NO. 1008501 - 1008504 - 4709077</p> <p>PARAFUSO PERNO RODA CHAVE 17 M12X1,50X48MM (BASE CONICA PARA JANTES AÇO E LIGA LEVE)</p> <p>OPEL MERIVA A Veículo multiuso (X03) 1.3 CDTI (E75) (04.2005 - 05.2010) 51kw 69cv 1248cm3 Veículo multiuso OPEL MERIVA A Veículo multiuso (X03) 1.3 CDTI (E75) (09.2003 - 05.2010) 55kw 75cv 1248cm3 Veículo multiuso OPEL MERIVA A Veículo multiuso (X03) 1.4 16V Twinport (E75) (07.2004 - 05.2010) 66kw 90cv 1364cm3 Veículo multiuso OPEL MERIVA A Veículo multiuso (X03) 1.4 16V Twinport LPG (E75) (07.200...</p> <p>C48mm (Ch-17mm) M12x1,50x22mm</p>
	<p>Y3212 NO. 1008501 - 1008504 - 4709077</p> <p>PARAFUSO PERNO RODA CHAVE 17 M12X1,50X48MM (BASE CONICA PARA JANTES AÇO E LIGA LEVE)</p> <p>OPEL MERIVA B Veículo multiuso (S10) 1.3 CDTI (75) (06.2010 - 11.2014) 70kw 95cv 1248cm3 Veículo multiuso OPEL MERIVA B Veículo multiuso (S10) 1.4 (75) (06.2010 - 03.2017) 74kw 100cv 1398cm3 Veículo multiuso OPEL MERIVA B Veículo multiuso (S10) 1.4 (75) (06.2010 - 03.2017) 88kw 120cv 1364cm3 Veículo multiuso OPEL MERIVA B Veículo multiuso (S10) 1.4 (75) (06.2010 - 03.2017) 103kw 140cv 1364cm3 cm3V...</p> <p>C48mm (Ch-17mm) M12x1,50x22mm</p>		<p>Z55280 NO. 2228839</p> <p>MOLA PAINEL REVESTIMENTO DAS PORTAS</p> <p>OPEL MERIVA B VAN (S10) 1.3 CDTI (75) 01.2013/11.2014 70KW 95CV 1248CC A 13 DTE - OPEL MERIVA B VAN (S10) 1.4 ECOTEC (75) 01.2013/03.2017 74KW 101CV 1398CC A 14 XER - OPEL MERIVA B VAN (S10) 1.6 CDTI (75) 01.2014/01.2017 70KW 95CV 1598CC B 16 DTC - OPEL MERIVA B VAN (S10) 1.6 CDTI (75) 03.2014/03.2017 81KW 110CV 1598CC B 16 DTL - OPEL MERIVA B VAN (S10) 1.7 CDTI (75) 01.2013/01.2017 74KW 101CV 168...</p> <p>F-G-mm T-27L-18H-12S-5mm</p>
	<p>Z57101 NO. 13252119</p> <p>MOLA DO PAINEL DA PORTA</p> <p>OPEL MERIVA (A partir de 2010)</p> <p>F9mm T17mm L15mm H20mm S1-6mm</p>		<p>Z71500 NO. 13252118</p> <p>MOLA DO PAINEL DA PORTA</p> <p>OPEL MERIVA (A partir de 2010)</p> <p>F9mm T17mm L14mm H20mm S1-7mm</p>



	<p>A1422 NO. 5684105 - 8-97910-967-0 - 8-97916-331-0 - 91162338 - 97149837</p> <p>APOIO DE MOTOR ESQUERDO</p> <p>OPEL FRONTERA 2.2 D MOTOR Y22 DTH</p> <p>142x120x95mm 2p-d10-25mm</p>		<p>A1425 NO. 8-97910-966-0 - 8-97916-330-0 - 91162337 - 97149836</p> <p>APOIO DE MOTOR DIREITO</p> <p>OPEL FRONTERA 2.2 D MOTOR Y22 DTH</p> <p>142-120-55mm 2p-d10-25mm</p>
	<p>A1494 NO. 8-94328-799-0 - 8-94386-854-0</p> <p>APOIO DE TRANSMISSÃO COM ROLAMENTO 30MM</p> <p>OPEL FRONTERA A Sport (U92): 2.0 i (52SUD2, 55SUD2) 03.1992/10.1998 85KW 115CV 1998CC - OPEL FRONTERA A (U92): 2.2 i (54MWWL4) 03.1995/10.1998 100KW 136CV 2198CC - OPEL FRONTERA A (U92): 2.4 i (53MWWL4) 03.1992/10.1998 92KW 125CV 2410CC - OPEL FRONTERA A (U92): 2.3 TD (5JMWL4) 03.1992/10.1998 92KW 125CV 2410CC - OPEL FRONTERA A (U92): 2.8 TD (5BMWWL4, 5BSUD2) 03.1995/08.1998 83KW 113CV 2771CC</p> <p>135x115x50mm 1f-d30mm</p>		<p>A1667 NO. 682574 - 8-94422-867-2 - 8-94482-405-2 - 8-94482405-0 - 8-97066-800-0 - 91140202 - 91153376</p> <p>APOIO DE MOTOR DIREITO</p> <p>OPEL FRONTERA A (U92) 2.2 i (54MWWL4) 03.1995/10.1998 100KW 136CV 2198CC X 22 XE 2127317 2127320 - OPEL FRONTERA A (U92) 2.4 i (53MWWL4) 03.1992/10.1998 92KW 125CV 2410CC C 24 NE 2127311 - OPEL FRONTERA A Sport (U92) 2.0 i (52SUD2, 55SUD2) 03.1992/10.1998 85KW 115CV 1998CC C 20 NE X 20 SE 2127321 2127310</p> <p>180x121x59mm 1p-d12-29mm</p>
	<p>A1668 NO. 4301093 - 8-94325597-2 - 8-94422-868-2 - 8-94482-406-0 - 8-94482-406-2 - 8-97066-799-0 - 91142003 - 8-97916-331-0</p> <p>APOIO DE MOTOR ESQUERDO</p> <p>OPEL FRONTERA A (U92) 2.2 i (54MWWL4) 03.1995/10.1998 100KW 136CV 2198CC X 22 XE 2127317 2127320 - OPEL FRONTERA A (U92) 2.4 i (53MWWL4) 03.1992/10.1998 92KW 125CV 2410CC C 24 NE 2127311 - OPEL FRONTERA A Sport (U92) 2.0 i (52SUD2, 55SUD2) 03.1992/10.1998 85KW 115CV 1998CC C 20 NE X 20 SE 2127321 2127310</p> <p>180x121x59mm 1p-d12-29mm</p>		<p>A2009 NO. 5684105 - 8-97039-190-2 - 8-97039-190-3 - 8-97086-076-1 - 8-97910-967-0 - 8-97916-331-0 - 8-97916-331-0</p> <p>APOIO DE MOTOR ESQUERDO</p> <p>OPEL FRONTERA 2.2 D MOTOR Y22 DTH</p> <p>114x60x56x142x47mm 2f-15x11mm 2p-d10x25mm</p>
	<p>A2010 NO. 8-97916-330-0 - 8-97910-966-0 - 91162337 - 97149836</p> <p>APOIO DE MOTOR DIREITO</p> <p>OPEL FRONTERA 2.2 D MOTOR Y22 DTH</p> <p>113x60x55x143x48mm 2f-15x11mm 2p-d10x25mm</p>		<p>A2332 NO. 1f-d17mm 1f-d12mm 1f-d10mm 1f-10x1</p> <p>APOIO DO MOTOR PARTE DA FRENTE</p> <p>OPEL ANTARA (L07): 2.0 CDTI 03.2007/12.2011 93KW 127CV 1991CC - OPEL ANTARA (L07): 2.0 CDTI 09.2008/12.2011 93KW 127CV 1991CC - OPEL ANTARA (L07): 2.0 CDTI 08.2006/12.2011 110KW 150CV 1991CC - OPEL ANTARA (L07): 2.0 CDTI 4x4 07.2006/12.2011 110KW 150CV 1991CC</p> <p>260x69x220mm 1f-d17mm 1f-d12mm 1f-d10mm 1f-10x12mm...</p>
	<p>A2538 NO. 448039 - 458010 - 91143487 - 91145129 - 91149595</p> <p>APOIO DA TRANSMISSÃO</p> <p>OPEL FRONTERA A (U92) 2.2 i (54MWWL4) 03.1995/10.1998 100KW 136CV 2198CC X 22 XE 2127317 2127320 - OPEL FRONTERA A (U92) 2.3 TD (5JMWL4) 03.1992/10.1998 74KW 100CV 2260CC 23 DTR 2127312 - OPEL FRONTERA A (U92) 2.4 i (53MWWL4) 03.1992/10.1998 92KW 125CV 2410CC C 24 NE 2127311</p> <p>d121x49mm 1f-d45mm 2r-d8mm</p>		<p>E0008 NO. 0801909 - 1591419 - 6030483 - 70GB5281AA - 801909</p> <p>ESTICADOR DE ESCAPE</p> <p>OPEL FRONTERA A</p> <p>d44x40mm</p>
	<p>E0271 NO. 03 50 236 - 0350607 - 5352019 - 97018228 - 97125014 - 97289820</p> <p>ESTICADOR BARRA ESTABILIZADORA FRENTE LADO DIREITO</p> <p>OPEL FRONTERA A (U92) 2.2 i (54MWWL4) 03.1995/10.1998 100KW 136CV 2198CC X 22 XE 2127317 2127320 - OPEL FRONTERA A (U92) 2.3 TD (5JMWL4) 03.1992/10.1998 74KW 100CV 2260CC 23 DTR 2127312 - OPEL FRONTERA A (U92) 2.4 i (53MWWL4) 03.1992/10.1998 92KW 125CV 2410CC C 24 NE 2127311 - OPEL FRONTERA A (U92) 2.5 TDS 09.1996/10.1998 85KW 115CV 2499CC 25TD 2127322 - OPEL FRONTERA A (U92) 2.8 TD (5BMWWL4, 5BSUD2)...</p> <p>180x36x36mm 2p-d10x20mm</p>		<p>E0271 NO. 03 50 236 - 0350607 - 5352019 - 97018228 - 97125014 - 97289820</p> <p>ESTICADOR BARRA ESTABILIZADORA FRENTE LADO DIREITO</p> <p>OPEL FRONTERA B (U99) 2.2 DTI (6B_66, 6B_76) 09.2002/07.2004 88KW 120CV 2171CC Y 22 DTH 0035468 - OPEL FRONTERA B (U99) 2.2 DTI (6B_ZC, 6B_VF, 6B_66, 6B_76) 09.1998/12.2003 85KW 116CV 2171CC X 22 DTH Y 22 DTH 0035370 - OPEL FRONTERA B (U99) 2.2 i (6B_ZC, 6B_VF, 6B_66, 6B_76) 10.1998/07.2004 100KW 136CV 2198CC Y 22 SE X 22 SE 0035371 - OPEL FRONTERA B (U99) 3.2 i (6B1VF, 6B1_6) 10.1998/07.2004 151K...</p> <p>180x36x36mm 2p-d10x20mm</p>
	<p>E0272 NO. 0350235 - 0350608 - 5352020 - 97 28 9819 - 97018227 - 97125013</p> <p>ESTICADOR BARRA ESTABILIZADORA FRENTE ESQUERDO</p> <p>OPEL FRONTERA A (U92) 2.2 i (54MWWL4) 03.1995/10.1998 100KW 136CV 2198CC X 22 XE 2127317 2127320 - OPEL FRONTERA A (U92) 2.3 TD (5JMWL4) 03.1992/10.1998 74KW 100CV 2260CC 23 DTR 2127312 - OPEL FRONTERA A (U92) 2.4 i (53MWWL4) 03.1992/10.1998 92KW 125CV 2410CC C 24 NE 2127311 - OPEL FRONTERA A (U92) 2.5 TDS 09.1996/10.1998 85KW 115CV 2499CC 25TD 2127322 - OPEL FRONTERA A (U92) 2.8 TD (5BMWWL4, 5BSUD2)...</p> <p>180x36x36mm 2p-d10x20mm</p>		<p>E0272 NO. 0350235 - 0350608 - 5352020 - 97 28 9819 - 97018227 - 97125013</p> <p>ESTICADOR BARRA ESTABILIZADORA FRENTE ESQUERDO</p> <p>OPEL FRONTERA B (U99) 2.2 DTI (6B_66, 6B_76) 09.2002/07.2004 88KW 120CV 2171CC Y 22 DTH 0035468 - OPEL FRONTERA B (U99) 2.2 DTI (6B_ZC, 6B_VF, 6B_66, 6B_76) 09.1998/12.2003 85KW 116CV 2171CC X 22 DTH Y 22 DTH 0035370 - OPEL FRONTERA B (U99) 2.2 i (6B_ZC, 6B_VF, 6B_66, 6B_76) 10.1998/07.2004 100KW 136CV 2198CC Y 22 SE X 22 SE 0035371 - OPEL FRONTERA B (U99) 3.2 i (6B1VF, 6B1_6) 10.1998/07.2004 151K...</p> <p>180x36x36mm 2p-d10x20mm</p>
	<p>EBTV8050 NO. 0542265 - 0542283 - 0542284 - 0542333 - 0542334 - 0542626</p> <p>EMBOLO PINÇA TRAVÃO DE TRÁS KASKO 41MM</p> <p>OPEL FRONTERA A (U92) 2.2 i (54MWWL4) 03.1995/10.1998 100KW 136CV 2198CC X 22 XE 2127317 2127320 - OPEL FRONTERA A (U92) 2.3 TD (5JMWL4) 03.1992/10.1998 74KW 100CV 2260CC 23 DTR 2127312 - OPEL FRONTERA A (U92) 2.4 i (53MWWL4) 03.1992/10.1998 92KW 125CV 2410CC C 24 NE 2127311 - OPEL FRONTERA A (U92) 2.5 TDS 09.1996/10.1998 85KW 115CV 2499CC 25TD 2127322 - OPEL FRONTERA A (U92) 2.8 TD (5BMWWL4, 5BSUD2)...</p> <p>d41x46mm 1f-d29mm</p>		<p>EBTV8050 NO. 0542265 - 0542266 - 0542626</p> <p>EMBOLO PINÇA TRAVÃO DE TRÁS KASKO 41MM</p> <p>OPEL FRONTERA B (U99) 2.2 DTI (6B_66, 6B_76) 09.2002/07.2004 88KW 120CV 2171CC Y 22 DTH 0035468 - OPEL FRONTERA B (U99) 2.2 DTI (6B_ZC, 6B_VF, 6B_66, 6B_76) 09.1998/12.2003 85KW 116CV 2171CC X 22 DTH Y 22 DTH 0035370 - OPEL FRONTERA B (U99) 2.2 i (6B_ZC, 6B_VF, 6B_66, 6B_76) 10.1998/07.2004 100KW 136CV 2198CC Y 22 SE X 22 SE 0035371 - OPEL FRONTERA B (U99) 3.2 i (6B1VF, 6B1_6) 10.1998/07.2004 151K...</p> <p>d41x46mm 1f-d29mm</p>

	<p>KF1612 NO. 0374075 - 374075 - 8-97138981-1 - 97138981 - 97148749</p> <p>KIT DE FOLE DO CARDAN LADO DA RODA</p> <p>OPEL FRONTERA B 2.2i 16v (APÓS 10-1998) - 2.2i 16v WAGON - 2.2 DTI 16v - 2.2i DTI 16v WAGON - 3.2i 24V WAGON (APÓS 10-1998)</p> <p>d100x100mm 1f-d83mm 1f-d23mm</p>		<p>KF2327 NO. 94312678</p> <p>KIT DE FOLE TRANSMISSAO</p> <p>OPEL FRONTERA A Sport (U92): 2.0 i (52SUD2,55SUD2) 03.1992/10.1998 85KW 115CV 1998CC - OPEL FRONTERA A 2.2i 16v 1992/1998 - OPEL FRONTERA 2.3 TD 1992/1998 - OPEL FRONTERA 2.4i 1992/1998 - OPEL FRONTERA 2.5 TDS 1992/1998 - OPEL FRONTERA 2.8 TD 1992/1998 - OPEL FRONTERA A Sport (U92): 2.5 TDS 09.1996/10.1998 85KW 115CV 2499CC - OPEL FRONTERA A Sport (U92): 2.8 TD (5BSUD2) 03.1995/08.1996 83KW 113CV 2...</p> <p>d86x84mm 1f-d76mm 1f-d22mm</p>
	<p>KF3885 NO. 0301710 - 0301712 - 0374082 - 301710 - 301712 - 374082 - 8-97139-981-0 - 97139981 - 97148750 ...</p> <p>KIT DE FOLE DO CARDAN JUNTO À RODA E CAIXA</p> <p>OPEL FRONTERA B 2.2 DTi 16v - 2.2i 16v - 3.2i (APÓS 1998)</p> <p>d100x100mm 1f-d83mm 1f-d25mm</p>		<p>KL80449 NO. 198283 - 607813 - 90412865</p> <p>KIT CASQUILHOS COBERTURA TAMPA MOTOR</p> <p>OPEL FRONTERA B (U99): 2.2 DTI (6B_ZC, 6B_VF, 6B_66, 6B_76) 09.1998/12.2003 85KW 116CV 2171CC - OPEL FRONTERA B (U99): 2.2 DTI (6B_66, 6B_76) 09.2002/07.2004 88KW 120CV 2171CC</p> <p>d16x10mm 1f-d6mm</p>
	<p>KM0404 NO. 98005814</p> <p>KIT BRINCOS DE MOLAS TRÁS PARTE DE TRAS (GASTA 2 UNIDADES)</p> <p>OPEL FRONTERA A Sport (U92): 2.0 i (52SUD2, 55SUD2) 03.1992/10.1998 85KW 115CV 1998CC - OPEL FRONTERA A Sport (U92): 2.5 TDS 09.1996/10.1998 85KW 115CV 2499CC - OPEL FRONTERA A Sport (U92): 2.8 TD (5BSUD2) 03.1995/08.1996 83KW 113CV 2771CC - OPEL FRONTERA A (U92): 2.2 i (54MWL4) 03.1995/10.1998 100KW 136CV 2198CC - OPEL FRONTERA A (U92): 2.4 i (53MWL4) 03.1992/10.1998 92KW 125CV 2410CC - OPEL FRON...</p> <p>132x90x40mm d30mm</p>		<p>KMEX0001 NO. 0308456 - 0308575 - 0308700 - 308456 - 308575 - 308700 - 94407708 - 94407718 - 97123691</p> <p>KIT REPARAÇÃO MANGA DE EIXO</p> <p>OPEL FRONTERA A (U92) 2.2 i (54MWL4) 03.1995/10.1998 100KW 136CV 2198CC X 22 DTH 2127317 2127320 - OPEL FRONTERA A (U92) 2.3 TD (5JMWL4) 03.1992/10.1998 74KW 100CV 2260CC 23 DTR 2127312 - OPEL FRONTERA A (U92) 2.4 i (53MWL4) 03.1992/10.1998 92KW 125CV 2410CC C 24 NE 2127311 - OPEL FRONTERA A (U92) 2.5 TDS 09.1996/10.1998 85KW 115CV 2499CC 25TD 2127322 - OPEL FRONTERA A (U92) 2.8 TD (5BMWL4, 5BSUD2)...</p> <p>d87x18mm d53x2mm d37x16x52mm 1f-d34mm 1f-d30mm</p>
	<p>KMEX0001 NO. 0308456 - 0308575 - 0308700 - 308456 - 308575 - 308700 - 94407708 - 94407718 - 97123691</p> <p>KIT REPARAÇÃO MANGA DE EIXO</p> <p>OPEL FRONTERA B (U99) 2.2 DTI (6B_66, 6B_76) 09.2002/07.2004 88KW 120CV 2171CC Y 22 DTH 0035468 - OPEL FRONTERA B (U99) 2.2 DTI (6B_ZC, 6B_VF, 6B_66, 6B_76) 09.1998/12.2003 85KW 116CV 2171CC X 22 DTH 22 DTH 0035370 - OPEL FRONTERA B (U99) 2.2 i (6B_ZC, 6B_VF, 6B_66, 6B_76) 10.1998/07.2004 100KW 136CV 2198CC Y 22 SEX 22 SE 0035371 - OPEL FRONTERA B (U99) 3.2 i (6B1VF, 6B1_6) 10.1998/07.2004 151KW ...</p> <p>d87x18mm d53x2mm d37x16x52mm 1f-d34mm 1f-d30mm</p>		<p>KUBT3002 NO. 05 42 267 - 05 42 268 - 1605850 - 1605949 - 5 42 283 - 5 42 284 - 97035265 - 97134718</p> <p>KIT BORRACHAS TRAVAO PINÇA TRAS AKE/AKEBONO 42MM</p> <p>OPEL FRONTERA A Sport (U92): 2.0 i (52SUD2, 55SUD2) 03.1992/10.1998 85KW 115CV 1998CC - OPEL FRONTERA A Sport (U92): 2.5 TDS 09.1996/10.1998 85KW 115CV 2499CC - OPEL FRONTERA A Sport (U92): 2.8 TD (5BSUD2) 03.1995/08.1996 83KW 113CV 2771CC - OPEL FRONTERA A (U92): 2.2 i (54MWL4) 03.1995/10.1998 100KW 136CV 2198CC - OPEL FRONTERA A (U92): 2.4 i (53MWL4) 03.1992/10.1998 92KW 125CV 2410CC - OPEL FRON...</p> <p>d52x8mm d49x3mm d52x21mm d20x25mm d11x10mm d9x8mm</p>
	<p>KUBT3003 NO. 05 42 107 - 05 42 116 - 05 42 247 - 05 42 248 - 16 05 853 - 1605948 - 5 42 107 - 5 42 116 - 5 42 247...</p> <p>KIT BORRACHAS TRAVAO PINÇA FRENTE ATE/AKEBONO 60MM</p> <p>OPEL FRONTERA A Sport (U92): 2.0 i (52SUD2, 55SUD2) 03.1992/10.1998 85KW 115CV 1998CC - OPEL FRONTERA A Sport (U92): 2.5 TDS 09.1996/10.1998 85KW 115CV 2499CC - OPEL FRONTERA A Sport (U92): 2.8 TD (5BSUD2) 03.1995/08.1996 83KW 113CV 2771CC - OPEL FRONTERA A (U92): 2.2 i (54MWL4) 03.1995/10.1998 100KW 136CV 2198CC - OPEL FRONTERA A (U92): 2.5 TDS 09.1996/10.1998 85KW 115CV 2499CC - OPEL FRONTERA A ...</p> <p>d70x7mm d70x3mm d76x21mm d20x27mm d11x10mm d11x9mm</p>		<p>L1013 NO. 00432751 - 0432751 - 094234319 - 432751 - 5-51151-007-0 - 8-94234-190-0 - 8-94234-319-0 - 8-97332-64...</p> <p>CASQUILHO DE MOLAS DE TRÁS PARTE DE TRÁS (8 UNIDADES)</p> <p>OPEL FRONTERA A Sport (U92): 2.0 i (52SUD2, 55SUD2) 03.1992/10.1998 85KW 115CV 1998CC - OPEL FRONTERA A Sport (U92): 2.5 TDS 09.1996/10.1998 85KW 115CV 2499CC - OPEL FRONTERA A Sport (U92): 2.8 TD (5BSUD2) 03.1995/08.1996 83KW 113CV 2771CC - OPEL FRONTERA A (U92): 2.2 i (54MWL4) 03.1995/10.1998 100KW 136CV 2198CC - OPEL FRONTERA A (U92): 2.4 i (53MWL4) 03.1992/10.1998 92KW 125CV 2410CC - OPEL FRON...</p> <p>d36x38mm d30mm 1f-d18mm</p>
	<p>L1042 NO. 894223-168-0</p> <p>CASQUILHO DE MOLAS DE TRÁS PARTE DA FRENTE (4 UNIDADES)</p> <p>OPEL FRONTERA A Sport (U92): 2.0 i (52SUD2, 55SUD2) 03.1992/10.1998 85KW 115CV 1998CC - OPEL FRONTERA A Sport (U92): 2.5 TDS 09.1996/10.1998 85KW 115CV 2499CC - OPEL FRONTERA A Sport (U92): 2.8 TD (5BSUD2) 03.1995/08.1996 83KW 113CV 2771CC - OPEL FRONTERA A (U92): 2.2 i (54MWL4) 03.1995/10.1998 100KW 136CV 2198CC - OPEL FRONTERA A (U92): 2.4 i (53MWL4) 03.1992/10.1998 92KW 125CV 2410CC - OPEL FRON...</p> <p>d45x35mm d40mm 1f-d18mm</p>		<p>L3109 NO. 0423751 - 094234319 - 423751 - 8-94234-190-0 - 8-94234-319-0 - 8-97332-642-0 - 8-97357-492-0 - 94234...</p> <p>CASQUILHO DE MOLAS DE TRÁS PARTE DE TRÁS (8 UNIDADES)</p> <p>OPEL FRONTERA A Sport (U92): 2.0 i (52SUD2, 55SUD2) 03.1992/10.1998 85KW 115CV 1998CC - OPEL FRONTERA A Sport (U92): 2.5 TDS 09.1996/10.1998 85KW 115CV 2499CC - OPEL FRONTERA A Sport (U92): 2.8 TD (5BSUD2) 03.1995/08.1996 83KW 113CV 2771CC - OPEL FRONTERA A (U92): 2.2 i (54MWL4) 03.1995/10.1998 100KW 136CV 2198CC - OPEL FRONTERA A (U92): 2.4 i (53MWL4) 03.1992/10.1998 92KW 125CV 2410CC - OPEL FRON...</p> <p>d36x36mm d30mm 1f-d18mm</p>
	<p>L3182 NO. 0444325 - 0444326 - 0444336 - 0444348 - 115501182 - 444325 - 444336 - 444348 - 6655341 - 8971400891...</p> <p>CASQUILHO DA BARRA ESTABILIZADORA DE TRÁS</p> <p>OPEL FRONTERA B (U99): 2.2 i (6B_ZC, 6B_VF, 6B_66, 6B_76) 10.1998/07.2004 100KW 136CV 2198CC - OPEL FRONTERA B (U99): 3.2 i (6B1VF, 6B1_6) 10.1998/07.2004 151KW 205CV 3165CC - OPEL FRONTERA B (U99): 2.2 DTI (6B_ZC, 6B_VF, 6B_66, 6B_76) 09.1998/12.2003 85KW 116CV 2171CC - OPEL FRONTERA B (U99): 2.2 DTI (6B_66, 6B_76) 09.2002/07.2004 88KW 120CV 2171CC</p> <p>d26x28mm d24mm 1f-d13mm</p>		<p>M6007 NO. 854963 - 97102031</p> <p>JUNTA DO COLECTOR DE ESCAPE</p> <p>OPEL FRONTERA B</p> <p>d67x5mm 1f-d56mm</p>
	<p>M6008 NO. 91137992 - 94236345 - 94329529</p> <p>JUNTA DE ESCAPE</p> <p>OPEL FRONTERA A Sport (U92): 2.5 TDS 09.1996/10.1998 85KW 115CV 2499CC - OPEL FRONTERA A (U92): 2.5 TDS 09.1996/10.1998 85KW 115CV 2499CC</p> <p>d65x5mm 1f-d50mm</p>		<p>M6017 NO. 854963 - 97102031</p> <p>JUNTA DE ESCAPE</p> <p>OPEL FRONTERA</p> <p>d56.5x10mm 1f-d44mm</p>

	<p>M6068 NO. 0852800 - 0852801 - 174510R030 - 21101206057 - 52005431 - 6616585 - 6616985 - 6688869 - 6745091 - 82...</p> <p>JUNTA DE ESCAPE</p> <p>OPEL FRONTERA A (1992 A 1993)</p> <p>d71x13mm 1f-d56mm</p>		<p>P1041 NO. 97318799</p> <p>CAPA PEDAL EMBRAIAGEM/TRAVAO (GASTA 2 UNIDADES)</p> <p>OPEL FRONTERA A (U92) 2.2 i (54MWL4) 03.1995/10.1998 100KW 136CV 2198CC X 22 XE 2127317 2127320 - OPEL FRONTERA A (U92) 2.4 i (53MWL4) 03.1992/10.1998 92KW 125CV 2410CC C 24 NE 2127311 - OPEL FRONTERA A Sport (U92) 2.0 i (52SUD2, 55SUD2) 03.1992/10.1998 85KW 115CV 1998CC C 20 NE X 20 SE 2127321 2127310</p> <p>62x53x11mm</p>
	<p>R222724 NO. 1337502 - 90573220 - 91156066</p> <p>TUBO INFERIOR DO RADIADOR</p> <p>OPEL FRONTERA A (U92) 2.5 TDS 09.1996/10.1998 85KW 115CV 2499CC 25TD 2127322 - OPEL FRONTERA A Sport (U92) 2.5 TDS 09.1996/10.1998 85KW 115CV 2499CC 25TDS (VM41B)25TD 2127323</p> <p>B220-d33/33mm 60-100-35-60-60mm</p>		<p>RT08617 NO. 4301615 - 562304 - 562366 - 8944033223 - 91142432 - 94403322 - 97134830</p> <p>TUBO DE TRAVÃO FRENTE LH-RH</p> <p>OPEL FRONTERA TT(APÓS 03-1991)</p> <p>435mm FB43 - OR18</p>
	<p>RT08618 NO. 562307 - 91142436</p> <p>TUBO DE TRAVÃO TRÁS LH-RH</p> <p>OPEL FRONTERA (A) - (TODAS MOTORIZAÇÕES) (03-1992 A 10-1998)</p> <p>468mm FB44 - FC1</p>		<p>S1244 NO. 0302411 - 0310400 - 29041-40K00 - 302292 - 8-94408-840-0 - 8-94408-840-1 - 8-94408-840-2 - ...</p> <p>SILENT-BLOC DO BRAÇO DA SUSPENSÃO SUPERIOR (GASTA 4 UNIDADES)</p> <p>OPEL FRONTERA A Sport (U92): 2.0 i (52SUD2, 55SUD2) 03.1992/10.1998 85KW 115CV 1998CC - OPEL FRONTERA A Sport (U92): 2.5 TDS 09.1996/10.1998 85KW 115CV 2499CC - OPEL FRONTERA A Sport (U92): 2.8 TD (5BSUD2) 03.1995/08.1996 83KW 113CV 2771CC - OPEL FRONTERA A (U92): 2.2 i (54MWL4) 03.1995/10.1998 100KW 136CV 2198CC - OPEL FRONTERA A (U92): 2.4 i (53MWL4) 03.1992/10.1998 92KW 125CV 2410CC - OPEL FRON...</p> <p>d50x45mm c33mm d38mm 1f-d18mm</p>
	<p>S1316 NO. 0302294 - 0310402 - 0352456 - 29040-50K00 - 29043-70K00 - 302294 - 45503-87706 - 8-94408-842-0 - 8-...</p> <p>SILENT-BLOC DO BRAÇO DA SUSPENSÃO INFERIOR (GASTA 2 UNIDADES)</p> <p>OPEL FRONTERA A Sport (U92): 2.0 i (52SUD2, 55SUD2) 03.1992/10.1998 85KW 115CV 1998CC - OPEL FRONTERA A Sport (U92): 2.5 TDS 09.1996/10.1998 85KW 115CV 2499CC - OPEL FRONTERA A Sport (U92): 2.8 TD (5BSUD2) 03.1995/08.1996 83KW 113CV 2771CC - OPEL FRONTERA A (U92): 2.2 i (54MWL4) 03.1995/10.1998 100KW 136CV 2198CC - OPEL FRONTERA A (U92): 2.4 i (53MWL4) 03.1992/10.1998 92KW 125CV 2410CC - OPEL FR...</p> <p>d44x85mm c76mm 1f-d18mm</p>		<p>S1316 NO. 0302294 - 0310402 - 0352456 - 29040-50K00 - 29043-70K00 - 302294 - 45503-87706 - 8-94408-842-0 - 8-9-...</p> <p>SILENT-BLOC DO BRAÇO DA SUSPENSÃO INFERIOR (GASTA 2 UNIDADES)</p> <p>OPEL FRONTERA B (U99): 2.2 i (6B_ZC, 6B_VF, 6B_66, 6B_76) 10.1998/07.2004 100KW 136CV 2198CC - OPEL FRONTERA B (U99): 3.2 i (6B1VF, 6B1_6) 10.1998/07.2004 151KW 205CV 3165CC - OPEL FRONTERA B (U99): 2.2 DTI (6B_ZC, 6B_VF, 6B_66, 6B_76) 09.1998/12.2003 85KW 116CV 2171CC - OPEL FRONTERA B (U99): 2.2 DTI (6B_66, 6B_76) 09.2002/07.2004 88KW 120CV 2171CC</p> <p>d44x85mm c76mm 1f-d18mm</p>
	<p>S1317 NO. 352455 - 8-94408-841-1 - 94408841</p> <p>SILENT-BLOC DO BRAÇO DA SUSPENSÃO INFERIOR (GASTA 2 UNIDADES)</p> <p>OPEL FRONTERA A Sport (U92): 2.0 i (52SUD2, 55SUD2) 03.1992/10.1998 85KW 115CV 1998CC - OPEL FRONTERA A Sport (U92): 2.8 TD (5BSUD2) 03.1995/08.1996 83KW 113CV 2771CC - OPEL FRONTERA A (U92): 2.2 i (54MWL4) 03.1995/10.1998 100KW 136CV 2198CC - OPEL FRONTERA A (U92): 2.4 i (53MWL4) 03.1992/10.1998 92KW 125CV 2410CC - OPEL FRONTERA A (U92): 2.3 TD (5JMWL4) 03.1992/10.1998 74KW 100CV 2260CC - OPEL FR...</p> <p>d42x56mm d36mm 1f-d16mm</p>		<p>S1482 NO. 0423602 - 0464314 - 0464316 - 8-94375-105-0 - 8-97021-0550 - 91153044 - 97021055</p> <p>SILENT-BLOC DO ESTICADOR SUSPENSÃO TRÁS (GASTA 4 UNIDADES)</p> <p>OPEL FRONTERA A (U92) 2.2 i (54MWL4) 03.1995/10.1998 100KW 136CV 2198CC X 22 XE 2127317 2127320 - OPEL FRONTERA A (U92) 2.3 TD (5JMWL4) 03.1992/10.1998 74KW 100CV 2260CC 23 DTR 2127312 - OPEL FRONTERA A (U92) 2.4 i (53MWL4) 03.1992/10.1998 92KW 125CV 2410CC C 24 NE 2127311 - OPEL FRONTERA A (U92) 2.5 TDS 09.1996/10.1998 85KW 115CV 2499CC 25TD 2127322 - OPEL FRONTERA A (U92) 2.8 TD (5BMWL4, 5BSUD2)...</p> <p>d54x71mm c55mm 1f-d14mm</p>
	<p>S1483 NO. 0302293 - 0302944 - 2904330-K00SH - 2904340-K00 - 302293 - 302944 - 8-97018-165-0 - 8-97364-176-0 - ...</p> <p>SILENT-BLOC DO BRAÇO DA SUSPENSÃO INFERIOR (GASTA 2 UNIDADES)</p> <p>OPEL FRONTERA B (U99): 2.2 i (6B_ZC, 6B_VF, 6B_66, 6B_76) 10.1998/07.2004 100KW 136CV 2198CC - OPEL FRONTERA B (U99): 2.2 i (6B_ZC, 6B_VF, 6B_66, 6B_76) 10.1998/07.2004 100KW 136CV 2198CC - OPEL FRONTERA B (U99): 3.2 i (6B1VF, 6B1_6) 10.1998/07.2004 151KW 205CV 3165CC - OPEL FRONTERA B (U99): 3.2 i (6B1VF, 6B1_6) 10.1998/07.2004 151KW 205CV 3165CC - OPEL FRONTERA B (U99): 2.2 DTI (6B_ZC, 6B_VF, 6B_...</p> <p>d41.5x56.5mm c40.5mm d35.5mm 1f-d16.3mm</p>		<p>S1484 NO. 8-97104-178-0 - 0310400 - 29041-40K00 - 302292 - 302411 - 8-94408-840-0 - 8-94408-840-2 - 8-94408-8-...</p> <p>SILENT-BLOC DO BRAÇO DA SUSPENSÃO SUPERIOR (GASTA 4 UNIDADES)</p> <p>OPEL FRONTERA A Sport (U92): 2.0 i (52SUD2, 55SUD2) 03.1992/10.1998 85KW 115CV 1998CC - OPEL FRONTERA A Sport (U92): 2.5 TDS 09.1996/10.1998 85KW 115CV 2499CC - OPEL FRONTERA A Sport (U92): 2.8 TD (5BSUD2) 03.1995/08.1996 83KW 113CV 2771CC - OPEL FRONTERA A (U92): 2.2 i (54MWL4) 03.1995/10.1998 100KW 136CV 2198CC - OPEL FRONTERA A (U92): 2.4 i (53MWL4) 03.1992/10.1998 92KW 125CV 2410CC - OPEL FRON...</p> <p>d49.5x45mm c35mm d38mm 1f-d18.4mm</p>
	<p>S1696 NO. 0464311 - 0464315 - 464311 - 464314 - 464315 - 464316 - 8-97125-086-1 - 8-97366-502-0 - 97125086 - 9-...</p> <p>SILENT-BLOC TIRANTE SUSPENSÃO TRÁS SUPERIOR</p> <p>OPEL FRONTERA B (U99) 2.2 DTI (6B_66, 6B_76) 09.2002/07.2004 88KW 120CV 2171CC Y 22 DTH 0035468 - OPEL FRONTERA B (U99) 2.2 DTI (6B_ZC, 6B_VF, 6B_66, 6B_76) 09.1998/12.2003 85KW 116CV 2171CC X 22 DTH Y 22 DTH 0035370 - OPEL FRONTERA B (U99) 2.2 i (6B_ZC, 6B_VF, 6B_66, 6B_76) 10.1998/07.2004 100KW 136CV 2198CC Y 22 SE X 22 SE 0035371 - OPEL FRONTERA B (U99) 3.2 i (6B1VF, 6B1_6) 10.1998/07.2004 151K...</p> <p>d50x60mm c45mm 1f-d14mm</p>		<p>S1697 NO. 0302411 - 0310400 - 302292 - 97138388</p> <p>SILENT-BLOC DO BRAÇO DA SUSPENSÃO SUPERIOR (GASTA 4 UNIDADES)</p> <p>OPEL FRONTERA A Sport (U92): 2.0 i (52SUD2 - 55SUD2) 03.1992/10.1998 85KW 115CV 1998CC - OPEL FRONTERA A Sport (U92): 2.5 TDS 09.1996/10.1998 85KW 115CV 2499CC - OPEL FRONTERA A Sport (U92): 2.8 TD (5BSUD2) 03.1995/08.1996 83KW 113CV 2771CC - OPEL FRONTERA A (U92): 2.2 i (54MWL4) 03.1995/10.1998 100KW 136CV 2198CC - OPEL FRONTERA A (U92): 2.4 i (53MWL4) 03.1992/10.1998 92KW 125CV 2410CC - OPEL FRON...</p> <p>d49x45mm d38mm c32mm 1f-d18mm</p>
	<p>S1699 NO. 0302293 - 0302944 - 2904330-K00SH - 2904340-K00 - 302293 - 97138389 - 97366491</p> <p>SILENT-BLOC DO BRAÇO DA SUSPENSÃO INFERIOR (GASTA 2 UNIDADES)</p> <p>OPEL FRONTERA B (U99): 2.2 i (6B_ZC, 6B_VF, 6B_66, 6B_76) 10.1998/07.2004 100KW 136CV 2198CC - OPEL FRONTERA B (U99): 2.2 i (6B_ZC, 6B_VF, 6B_66, 6B_76) 10.1998/07.2004 100KW 136CV 2198CC - OPEL FRONTERA B (U99): 3.2 i (6B1VF, 6B1_6) 10.1998/07.2004 151KW 205CV 3165CC - OPEL FRONTERA B (U99): 3.2 i (6B1VF, 6B1_6) 10.1998/07.2004 151KW 205CV 3165CC - OPEL FRONTERA B (U99): 2.2 DTI (6B_ZC, 6B_VF, 6B_...</p> <p>d42x57mm d36mm c41mm 1f-d16mm</p>		<p>S1728 NO. 8-97147-547-0 - 8-97366-495-0 - 97147547 - 97366495 - 0423322 - 423322 - 2917500-K00</p> <p>SILENT-BLOC DO ESTICADOR SUSPENSÃO TRÁS (GASTA 2 UNIDADES)</p> <p>OPEL FRONTERA B (U99) 2.2 DTI (6B_66, 6B_76) 09.2002/07.2004 88KW 120CV 2171CC Y 22 DTH 0035468 - OPEL FRONTERA B (U99) 2.2 DTI (6B_ZC, 6B_VF, 6B_66, 6B_76) 09.1998/12.2003 85KW 116CV 2171CC X 22 DTH Y 22 DTH 0035370 - OPEL FRONTERA B (U99) 2.2 i (6B_ZC, 6B_VF, 6B_66, 6B_76) 10.1998/07.2004 100KW 136CV 2198CC Y 22 SE X 22 SE 0035371 - OPEL FRONTERA B (U99) 3.2 i (6B1VF, 6B1_6) 10.1998/07.2004 151K...</p> <p>d43x49mm c37mm 1f-d21mm</p>

	<p>S1729 NO. 0302281 - 0302297 - 0302298 - 2303310-K01 - 302281 - 302297 - 302298 - 97139268 - 97149540 - 9736651...</p> <p>SILENT-BLOC APOIO DO DIFERENCIAL</p> <p>OPEL FRONTERA B (U99) 2.2 DTI (6B_66, 6B_76) 09.2002/07.2004 88KW 120CV 2171CC Y 22 DTH 0035468 - OPEL FRONTERA B (U99) 2.2 DTI (6B_ZC, 6B_VF, 6B_66, 6B_76) 09.1998/12.2003 85KW 116CV 2171CC X 22 DTH Y 22 DTH 0035370 - OPEL FRONTERA B (U99) 2.2 i (6B_ZC, 6B_VF, 6B_66, 6B_76) 10.1998/07.2004 100KW 136CV 2198CC Y 22 SEX 22 SE 0035371</p> <p>d49x50mm d38mm c26mm 1f-d14mm</p>		<p>S1974 NO. 0423321 - 0423605</p> <p>SILENT-BLOC BRAÇO SUSPENSÃO BARRA PANHARD TRÁS</p> <p>OPEL FRONTERA B (U99) 2.2 DTI (6B_66, 6B_76) (De 09.2002 Até 07.2004) 88KW 120cv 2171cm3 Veículo todo-terreno fechado - OPEL FRONTERA B (U99) 2.2 DTI (6B_66, 6B_76) (De 09.2002 Até 07.2004) 88KW 120cv 2171cm3 Veículo todo-terreno fechado - OPEL FRONTERA B (U99) 2.2 DTI (6B_ZC, 6B_VF, 6B_66, 6B_76) (De 09.1998 Até 12.2003) 85KW 116cv 2171cm3 Veículo todo-terreno fechado - OPEL FRONTERA B (U99) 2.2 ...</p> <p>d39x56mm c38mm 1f-d14mm</p>
	<p>T1195 NO. 0350666 - 350666 - 91132004 - 97179437</p> <p>BATENTE BARRA ESTABILIZADORA DA FRENTE</p> <p>OPEL FRONTERA B (U99): 3.2 i (6B1VF, 6B1_6) 10.1998/07.2004 151KW 205CV 3165CC - OPEL FRONTERA B (U99): 2.2 DTI (6B_66, 6B_76) 09.2002/07.2004 88KW 120CV 2171CC</p> <p>41x43x41mm 1f-d23mm</p>		<p>T1224 NO. 0444343 - 444344 - 91147929 - 97039520 - 97048318 - 97179438</p> <p>BATENTE DA BARRA ESTABILIZADORA DE TRÁS</p> <p>OPEL FRONTERA A (M92): 3.2 (UBS25D, UBS25G) 08.1991/03.1994 130KW 177CV 3165CC - OPEL FRONTERA A (M92): 3.1 TD (UBS69D, UBS69G) 09.1991/07.1998 84KW 114CV 3059CC - OPEL FRONTERA B (M98): 3.5 V6 24V (UBS26D, UBS26G) 07.1998/08.1999 158KW 215CV 3494CC - OPEL FRONTERA B (M98): 3.0 DTI (UBS73D, UBS73G) 07.1998/08.1999 117KW 159CV 2999CC</p> <p>42x43x42mm 1f-d17mm</p>
	<p>UAP81292 NO. 0821038 - 0821074 - 0821437 - 0821675 - 4708869 - 4809347 - 821038 - 821074 - 821437 - 821675</p> <p>ANILHA PROTEÇÃO TÉRMICA INJECTORES</p> <p>OPEL FRONTERA B (U99) 2.2 DTI (6B_ZC - 6B_VF - 6B_66 - 6B_76) (De 10-1998 Até 09-2002) 85KW 116CV 2172cc Veículo todo-terreno fechado - OPEL FRONTERA B (U99) 2.2 DTI (6B_66 - 6B_76) (De 09-2002 Até ...) 88KW 120CV 2172cc Veículo todo-terreno fechado</p> <p>d16x1mm 1f-d7mm</p>		<p>UAP81292 NO. 0821038 - 0821074 - 0821437 - 0821675 - 4708869 - 4809347 - 821038 - 821074 - 821437 - 821675</p> <p>ANILHA PROTEÇÃO TÉRMICA INJECTORES</p> <p>OPEL FRONTERA B (U99) 2.2 DTI (6B_ZC - 6B_VF - 6B_66 - 6B_76) (De 10-1998 Até 09-2002) 85KW 116CV 2172cc Veículo todo-terreno fechado - OPEL FRONTERA B (U99) 2.2 DTI (6B_66 - 6B_76) (De 09-2002 Até ...) 88KW 120CV 2172cc Veículo todo-terreno fechado</p> <p>d16x1mm 1f-d7mm</p>
	<p>UMB84011 NO. 031126</p> <p>TAMPÃO BLOCO MOTOR</p> <p>OPEL FRONTERA A (U92) 2.2 i (54MWL4) (De 03-1995 Até 10-1998) 100kW 136CV 2198cc Veículo todo-terreno fechado - OPEL FRONTERA B (U99) 2.2 i (6B_ZC - 6B_VF - 6B_66 - 6B_76) (De 10-1998 Até .9-20 -) 100kW 136CV 2198cc Veículo todo-terreno fechado</p> <p>d-18x8mm di-16mm</p>		<p>UMB84011L NO. 11062402 - 2060675</p> <p>TAMPÃO BLOCO DE MOTOR (RELAS)</p> <p>OPEL FRONTERA A (U92) 2.2 i (54MWL4) (De 03-1995 Até 10-1998) 100kW 136CV 2198cc Veículo todo-terreno fechado - OPEL FRONTERA B (U99) 2.2 i (6B_ZC - 6B_VF - 6B_66 - 6B_76) (De 10-1998 Até .9-20 -) 100kW 136CV 2198cc Veículo todo-terreno fechado</p> <p>d-18x8mm di-16mm</p>
	<p>UMB84019 NO. 2060668</p> <p>TAMPÃO BLOCO MOTOR</p> <p>OPEL FRONTERA A Sport (U92) 2.0 i (52SUD2 - 55SUD2) (De 03-1992 Até 10-1998) 85kW 115CV 1998cc Veículo todo terreno aberto</p> <p>d-26x9,5mm di-23,3mm</p>		<p>UMB84019L NO. 2060668</p> <p>TAMPÃO BLOCO DE MOTOR (RELAS)</p> <p>OPEL FRONTERA A Sport (U92) 2.0 i (52SUD2 - 55SUD2) (De 03-1992 Até 10-1998) 85kW 115CV 1998cc Veículo todo terreno aberto</p> <p>d-26x9,5mm di-23,3mm</p>
	<p>UMB84029 NO. 2060946</p> <p>TAMPÃO BLOCO MOTOR</p> <p>OPEL FRONTERA A Sport (U92) 2.0 i (52SUD2, 55SUD2) (03.92 A 10.98) 115cv 1998cc Veículo todo terreno aberto - OPEL FRONTERA A (U92) 2.3 TD (5JMWL4) (03.92 A 10.98) 100cv 2260cc Veículo todo terreno fechado</p> <p>d36x10mm di-32mm</p>		<p>UMB84029 NO. 2060946</p> <p>TAMPÃO BLOCO MOTOR</p> <p>OPEL FRONTERA B (U99) 2.2 i (6B_ZC, 6B_VF, 6B_66, 6B_76) (A Partir de 10.98) 136cv 2198cc Veículo todo terreno fechado - OPEL FRONTERA B (U99) 2.2 i (6B_ZC, 6B_VF, 6B_66, 6B_76) (A Partir de 10.98) 136cv 2198cc Veículo todo terreno fechado</p> <p>d36x10mm di-32mm</p>
	<p>UTR0626 NO. 1326003</p> <p>TAMPÃO RADIADOR</p> <p>OPEL FRONTERA B (U99) 3.2 i (De 1998.10 Até 2004.07) 151kW 205cv 3165cm3 Veículo todo-terreno fechado -</p> <p>d59/79x28mm d38x25mm</p>		<p>UTR0800 NO. 1304240 - 1304654 - 1304659 - 1304660 - 1304661 - 1304665 - 1304666 - 1304667 - 1304853 - 90352470 - ...</p> <p>TAMPÃO RESERVATÓRIO LIQUIDO REFRIGERAÇÃO</p> <p>OPEL FRONTERA A Sport (U92) 2.0 i (52SUD2, 55SUD2) 03.92 - 10.98 85 115 1998 Veículo todo terreno aberto - OPEL FRONTERA A Sport (U92) 2.5 TDS 09.96 - 10.98 85 115 2499 Veículo todo terreno aberto - OPEL FRONTERA A Sport (U92) 2.8 TD (53SUD2) 03.95 - 08.96 83 113 2771 Veículo todo terreno aberto - OPEL FRONTERA A (U92) 2.2 i (54MWL4) 03.95 - 10.98 100 136 2198 Veículo todo-terreno fechado - OPEL FRONTERA ...</p> <p>d62x25mm 1f-d53x14mm</p>
	<p>UTR0820 NO. 90352470 - 90409256 - 90409257 - 9041032690497472 - 90467473</p> <p>TAMPÃO RESERVATÓRIO LIQUIDO REFRIGERAÇÃO</p> <p>OPEL FRONTERA A Sport (5_SUD2) 2.0 i (52SUD2, 55SUD2) (03.92 A 10.98) 115cv 1998cc Veículo todo terreno aberto - OPEL FRONTERA A Sport (5_SUD2) 2.5 TDS (09.96 A 10.98) 115cv 2499cc Veículo todo terreno aberto - OPEL FRONTERA A Sport (5_SUD2) 2.8 TD (53SUD2) (03.95 A 08.96) 113cv 2771cc Veículo todo terreno aberto - OPEL FRONTERA A (5_MWL4) 2.2 i (54MWL4) (03.95 A 10.98) 136cv 2198cc Veículo...</p> <p>d62x23mm 1f-d53x12mm</p>		<p>UTR0957 NO. 1326000 - 1326004 - 1326026 - 1326027 - 1326028 - 1326030 - 1326031 - 1326032</p> <p>TAMPÃO DO RADIADOR</p> <p>OPEL FRONTERA B (U99) 3.2 i (6B1VF, 6B1_6) (De 10.1998 Até 07.2004) 151kW 205cv 3165cm3 Veículo todo-terreno fechado -</p> <p>d45x25mm d28x22mm</p>









	<p>UTR0958 NO. 1326000 - 1326004 - 1326026 - 1326027 - 1326028 - 1326030 - 1326031 - 1326032</p> <p>TAMPÃO RADIAADOR</p> <p>OPEL FRONTERA B (U99) 3.2 i (6B1VF, 6B1_6) (De 10.1998 Até 07.2004) 151kW 205cv 3165cm3 Veículo todo-terreno fechado -</p> <p>d45x29mm d28x21mm</p>		<p>UTR1300 NO. 00650090 - 05650831</p> <p>TAMPÃO RESERVATÓRIO DO OLEO</p> <p>OPEL FRONTERA A (U92) 2.2 i (54MWL4) (De 03-1995 Até 10-1998) 100kW 136CV 2198cc Veículo todo-terreno fechado</p> <p>d59x31mm d45x12mm</p>
	<p>UTR1300 NO. 00650090 - 05650831</p> <p>TAMPÃO RESERVATÓRIO DO OLEO</p> <p>OPEL FRONTERA B (U99) 2.2 i (6B_ZC - 6B_VF - 6B_66 - 6B_76) (De 10-1998 Até .9-20 -) 100kW 136CV 2198cc Veículo todo-terreno fechado</p> <p>d59x31mm d45x12mm</p>		<p>UTR1305 NO. 0650089 - 650089</p> <p>TAMPÃO DO RESERVATÓRIO ÓLEO</p> <p>OPEL FRONTERA A (U92) 2.2 i (54MWL4) (03.1995 -10.1998) 100kw 136cv 2198cm3 Veículo todo-terreno fechado OPEL FRONTERA A (U92) 2.3 TD (5JMWL4) (03.1992 -10.1998) 74kw 100cv 2260cm3 Veículo todo-terreno fechado OPEL FRONTERA A (U92) 2.4 i (53MWL4) (03.1992 -10.1998) 92kw 125cv 2410cm3 Veículo todo-terreno fechado OPEL FRONTERA A (U92) 2.5 TDS (09.1996 -10.1998) 85kw 115cv 2499cm3 Veículo todo-terre...</p> <p>d61x23mm d32x19mm</p>
	<p>UTR1305 NO. 0650089 - 650089</p> <p>TAMPÃO DO RESERVATÓRIO ÓLEO</p> <p>OPEL FRONTERA B (U99) 2.2 DTI (6B_66, 6B_76) (09.2002 -07.2004) 88kw 120cv 2171cm3 Veículo todo-terreno fechado OPEL FRONTERA B (U99) 2.2 DTI (6B_ZC, 6B_VF, 6B_66, 6B_76) (09.1998 -12.2003) 85kw 116cv 2171cm3 Veículo todo-terreno fechado OPEL FRONTERA B (U99) 2.2 i (6B_ZC, 6B_VF, 6B_66, 6B_76) (10.1998 -07.2004) 100kw 136cv 2198cm3 Veículo todo-terreno fechado OPEL FRONTERA B (U99) 3.2 i (6B1VF, 6...</p> <p>d61x23mm d32x19mm</p>		<p>UTV83011 NO. 0652475 - 09275631 - 652475 - 652491 - 90409376 - 9275631 - N90288901</p> <p>TAMPÃO VEDAÇÃO BUJÃO</p> <p>OPEL FRONTERA A Sport (U92) 2.0 i (52SUD2 - 55SUD2) (De 03-1992 Até 10-1998) 85kW 115CV 1998cc Veículo todo terreno aberto OPEL FRONTERA A (U92) 2.2 i (54MWL4) (De 03-1995 Até 10-1998) 100kW 136CV 2198cc Veículo todo-terreno fechado OPEL FRONTERA A (U92) 2.4 i (53MWL4) (De 03-1992 Até 10-1998) 92kW 125CV 2410cc Veículo todo-terreno fechado OPEL FRONTERA A (U92) 2.3 TD (5JMWL4) (De 03-1992 Até...</p> <p>19x18mm c12mm d14mm</p>
	<p>UTV83011 NO. 0652475 - 09275631 - 652475 - 652491 - 90409376 - 9275631 - N90288901</p> <p>TAMPÃO VEDAÇÃO BUJÃO</p> <p>OPEL FRONTERA B (U99) 2.2 i (6B_ZC - 6B_VF - 6B_66 - 6B_76) (De 10-1998 Até .9-20 -) 100kW 136CV 2198cc Veículo todo-terreno fechado</p> <p>19x18mm c12mm d14mm</p>		<p>UTV83019 NO. 0652315 - 0652477 - 652315 - 652477 - 90502556 - 96023264</p> <p>TAMPÃO VEDAÇÃO BUJÃO</p> <p>OPEL FRONTERA B (U99) 2.2 DTI (6B_ZC - 6B_VF - 6B_66 - 6B_76) (De 10-1998 Até 09-2002) 85kW 116CV 2172cc Veículo todo-terreno fechado OPEL FRONTERA B (U99) 2.2 DTI (6B_66 - 6B_76) (De 09-2002 Até ...) 88kW 120CV 2172cc Veículo todo-terreno fechado</p> <p>d25x14mm c9mm d13mm</p>
	<p>W5034 NO. 614654 - 90466618</p> <p>POLIE DA CAMBOTA (6 PISTAS)</p> <p>OPEL FRONTERA A 2.0i SPORT - 2.2i (1992 A 1998) - FRONTERA B 2.2i - 2.2DTi (APOS 1998)</p> <p>d138mm d42mm</p>		<p>W5051 NO. 0614411 - 09128177 - 09544461 - 55351711 - 5535171169 - 5614415 - 5614437 - 614411 - 614444 - 9...</p> <p>POLIE DA CAMBOTA (6 PISTAS)</p> <p>OPEL FRONTERA B (U99) 2.2 DTI (6B_66, 6B_76) 09.2002/07.2004 88KW 120CV 2171CC Y 22 DTH 0035468 - OPEL FRONTERA B (U99) 2.2 DTI (6B_ZC, 6B_VF, 6B_66, 6B_76) 09.1998/12.2003 85KW 116CV 2171CC X 22 DTH 22 DTH 0035370</p> <p>d153mm d35mm</p>
	<p>W5069 NO. 614654</p> <p>POLIE DA CAMBOTA (6 PISTAS)</p> <p>OPEL FRONTERA A 2.0i SPORT - 2.2i (1992 A 1998) - FRONTERA B 2.2i - 2.2DTi (APOS 1998)</p> <p>d140/141mm d42mm</p>		<p>Y3000 NO. 854917 - 854977 - 854980 - 90128081</p> <p>PARAFUSO MOLA DE ESCAPE</p> <p>OPEL FRONTERA A (1992 A 1993)</p> <p>82x13mm 1p-d10-20mm</p>
	<p>Z80661 NO. 1218601 - 90181010</p> <p>MOLA SUPORTE FAROL PRINCIPAL (GASTA 2 UNIDADES)</p> <p>OPEL FRONTERA A Sport (U92): 2.0 i (52SUD2, 55SUD2) 03.1992/10.1998 85KW 115CV 1998CC - OPEL FRONTERA A Sport (U92): 2.5 TDS 09.1996/10.1998 85KW 115CV 2499CC - OPEL FRONTERA A Sport (U92): 2.8 TD (5BSUD2) 03.1995/08.1996 83KW 113CV 2771CC - OPEL FRONTERA A (U92): 2.2 i (54MWL4) 03.1995/10.1998 100KW 136CV 2198CC - OPEL FRONTERA A (U92): 2.4 i (53MWL4) 03.1992/10.1998 92KW 125CV 2410CC - OPEL F...</p> <p>27.5x22x20mm</p>		<p>Z9000 NO. 25501711 - 854880 - 854881 - 854884 - 858884 - 90234204</p> <p>MOLA DE ESCAPE 42mm</p> <p>OPEL FRONTERA A (1992 A 1993)</p> <p>d18x26mm</p>
	<p>Z9011 NO. 1261479 - 1449282600 - 4709339 - 4711509 - 854880</p> <p>MOLA DE ESCAPE</p> <p>OPEL FRONTERA</p> <p>d23x42mm</p>		

	N2335	NO. 175538		N2336	NO. 852711
	ANEL ESCAPE OPEL GT			ANEL ESCAPE OPEL GT: 1.9 09.1968/08.1973 66KW 90CV 1897CC	
	d65x15mm	1f-d36mm		d62x14mm	1f-d36mm

OPEL INSIGNIA A

	A2693	NO. 13112029 - 5684143		E1092	NO. 0852726 - 13276148 - 852577 - 852726 - 90466668
	APOIO DO MOTOR PARTE DE TRÁS CAIXA AUTOMÁTICA OPEL INSIGNIA A (G09) Informações Tipo Ano de construção kW HP cc			ESTICADOR DE ESCAPE OPEL INSIGNIA A (G09): 1.4 (68) 04.2011/03.2017 103KW 140CV 1364CC - OPEL INSIGNIA A (G09): 1.4 LPG (68) 07.2012/03.2017 103KW 140CV 1364CC - OPEL INSIGNIA A (G09): 1.6 (68) 07.2008/03.2017 85KW 116CV 1598CC - OPEL INSIGNIA A (G09): 1.6 SIDI (68) 03.2013/03.2017 125KW 170CV 1598CC - OPEL INSIGNIA A (G09): 1.6 Turbo (68) 07.2008/03.2017 132KW 180CV 1598CC - OPEL INSIGNIA A (G09): 1.8 (68) 07.2008/0...	
	228x132x118mm	1f-d6mm 3f-d12mm 1f-d16mm		55x40x35mm	
	KF3760-T	NO. 39241BM525 - 39241BM526 - 103241BM527 162 220 1998		KF3760-T	NO. 09201727 - 1603012 - 96391553 - 96489655
	KIT DE FOLE DO CARDAN JUNTO Á RODA 2.0 Turbo 4x4 (68) 07.2011 - 03.2017 184 250 1998 OPEL INSIGNIA A (G09): 2.0 Turbo 4x4 (68) 07.2008/03.2017 162KW 103KW 140CV 1364CC - OPEL INSIGNIA A (G09): 2.0 Turbo 4x4 (68) 07.2008/03.2017 85KW 116CV 1598CC - OPEL INSIGNIA A (G09): 2.8 XER 4x4 (68) 07.2009/03.2017 239KW 325CV 2792CC - OPEL INSIGNIA A (G09): 2.0 CDTI 4x4 (68) 06.2010/03.2017 118KW 160CV 1956cm3 - OPEL INSIGNIA A (G09): 2.0 CDTI 4x4 (68) 07.2013/03.2017 120KW 163CV 1956CC - ...			KIT DE FOLE DO CARDAN JUNTO Á RODA OPEL INSIGNIA	
	d93x121mm	1f-d76mm 1f-d23mm		d106x122mm	1f-d82mm 1f-d24mm
	KUBT3023	NO. 1f-d39mm(x2) 1f-d48mm(x2) 1f-d5mm		R22852	NO. 1302251 - 1302275 - 1302277 - 13242121 - 22865155 - 22990025
	KIT BORRACHAS TRAVAO PINÇA TRAS BRENBO 40MM OPEL INSIGNIA A (G09) 1.4 (68) 04.2011/03.2017 103KW 140CV 1364CC B 14 NETA 14 NET 0035AVG - OPEL INSIGNIA A (G09) 1.4 LPG (68) 07.2012/03.2017 103KW 140CV 1364CC A 14 NETB 14 NET 0035AYD 0035AYH - OPEL INSIGNIA A (G09) 1.6 (68) 07.2008/03.2017 85KW 116CV 1598CC A 16 XER 0035APP 0035AIQ - OPEL INSIGNIA A (G09) 1.6 CDTI (68) 07.2015/03.2017 88KW 120CV 1598CC B 16 DTJ 0035BFD - OPEL INSIGNIA A (G09)...			TUBO DO AR SOBREALIMENTAÇÃO OPEL INSIGNIA A (G09) 2.0 Turbo (68) (De 2008.07 Até 2017.03) 162kW 220cv 1998cm3 Hatchback - OPEL INSIGNIA A (G09) 2.0 Turbo 4x4 (68) (De 2008.07 Até 2017.03) 162kW 220cv 1998cm3 Hatchback - OPEL INSIGNIA A (G09) 2.0 CDTI (68) (De 2008.07 Até 2017.03) 81kW 110cv 1956cm3 Hatchback - OPEL INSIGNIA A (G09) 2.0 CDTI (68) (De 2008.07 Até 2017.03) 96kW 131cv 1956cm3 Hatchback - ...	
	d59x12mm(x2) d54x3mm(x2) d58mm(x2) 1f-d48mm(x2) 1f-d5mm 1p			B500-60/68mm	100-140-215mm
	R224815	NO. 13419441		S1979	NO. 22940356 - 22940357 - 423149 - 423150
	TUBO DO AR SOBREALIMENTAÇÃO OPEL INSIGNIA A (G09) 1.6 CDTI (68) 07.2015/03.2017 88KW 120CV 1598CC B 16 DTJ 0035BFD - OPEL INSIGNIA A (G09) 1.6 CDTI (68) 07.2015/03.2017 100KW 136CV 1598CC B 16 DTH 0035BFG - OPEL INSIGNIA A Sports Tourer (G09) 1.6 CDTI (35) 07.2015/01.2017 88KW 120CV 1598CC B 16 DTJ 0035BFF - OPEL INSIGNIA A Sports Tourer (G09) 1.6 CDTI (35) 07.2015/12.2016 100KW 136CV 1598CC B 16 DTH 0035BFI - OPEL INSIGNIA ...			SILENT-BLOC DO BRAÇO SUSPENSÃO LONGITUDINAL TRÁS OPEL INSIGNIA A (G09) 1.4 (68) (De 04.2011 Até 03.2017) 103kW 140cv 1364cm3 Hatchback - OPEL INSIGNIA A (G09) 1.4 LPG (68) (De 07.2012 Até 03.2017) 103kW 140cv 1364cm3 Hatchback - OPEL INSIGNIA A (G09) 1.6 (68) (De 07.2008 Até 03.2017) 85kW 116cv 1598cm3 Hatchback - OPEL INSIGNIA A (G09) 1.6 CDTI (68) (De 07.2015 Até 03.2017) 88kW 120cv 1598cm3 Hatchback - OPEL INSIGNIA A (G09) 1.6 CDTI (68) (De 0...	
	B730-58/58mm	270-150-120-110-130-		d48x53mm	c36mm 1f-d14mm
	U0314	NO. 0424761		U0314	NO. 0424761
	ANILHA DA SUSPENSÃO DAS MOLAS DE TRÁS INFERIOR OPEL INSIGNIA A (G09) 1.4 (68) (04.2011 - 03.2017) 103kw 140cv 1364cm3 Hatchback OPEL INSIGNIA A (G09) 1.6 CDTI (68) (07.2012 - 03.2017) 103kw 140cv 1364cm3 Hatchback OPEL INSIGNIA A (G09) 1.6 (68) (07.2008 - 03.2017) 85kw 116cv 1598cm3 Hatchback OPEL INSIGNIA A (G09) 1.6 CDTI (68) (07.2015 - 03.2017) 88kw 120cv 1598cm3 Hatchback OPEL INSIGNIA A (G09) 1.6 CDTI (68) (07.2015 - 03.2017) 100kw 136cv 15...			ANILHA DA SUSPENSÃO DAS MOLAS DE TRÁS INFERIOR OPEL INSIGNIA A Country Tourer (G09) 1.6 CDTI (47) (07.2015 - 03.2017) 88kw 120cv 1598cm3 Combi OPEL INSIGNIA A Country Tourer (G09) 1.6 CDTI (47) (07.2015 - 03.2017) 100kw 136cv 1598cm3 Combi OPEL INSIGNIA A Country Tourer (G09) 1.6 SIDI (47) (07.2014 - 03.2017) 125kw 170cv 1598cm3 Combi OPEL INSIGNIA A Country Tourer (G09) 2.0 CDTI (47) (03.2012 - 03.2017) 88kw 120cv 1956cm3 Combi OPEL INSIGNIA ...	
	d132x22mm	1f-d33mm		d132x22mm	1f-d33mm
	U0314	NO. 0424761		U0314	NO. 0424761
	ANILHA DA SUSPENSÃO DAS MOLAS DE TRÁS INFERIOR OPEL INSIGNIA A Sports Tourer (G09) 1.4 (35) (04.2011 - 03.2017) 103kw 140cv 1364cm3 Combi OPEL INSIGNIA A Sports Tourer (G09) 1.4 LPG (35) (09.2012 - 03.2017) 103kw 140cv 1364cm3 Combi OPEL INSIGNIA A Sports Tourer (G09) 1.6 (35) (07.2008 - 06.2012) 85kw 116cv 1598cm3 Combi OPEL INSIGNIA A Sports Tourer (G09) 1.6 CDTI (35) (07.2015 - 01.2017) 88kw 120cv 1598cm3 Combi OPEL INSIGNIA A Sports Tourer...			ANILHA DA SUSPENSÃO DAS MOLAS DE TRÁS INFERIOR OPEL INSIGNIA A três volumes (G09) 1.4 (69) (04.2011 - 03.2017) 103kw 140cv 1364cm3 três volumes OPEL INSIGNIA A três volumes (G09) 1.4 LPG (69) (07.2012 - 03.2017) 103kw 140cv 1364cm3 três volumes OPEL INSIGNIA A três volumes (G09) 1.6 (69) (07.2008 - 03.2017) 85kw 116cv 1598cm3 três volumes OPEL INSIGNIA A três volumes (G09) 1.6 CDTI (69) (07.2015 - 03.2017) 88kw 120cv 1598cm3 três volumes OPEL I...	
	d132x22mm	1f-d33mm		d132x22mm	1f-d33mm

	UAP83244 NO. 055565375 - 55565375 ANILHA PROTEÇÃO TÉRMICA INJECTORES OPEL INSIGNIA B Grand Sport (Z18) 2.0 CDTi 4x4 (68) (De 03-2017 Até .1-20 -) 154kW 210CV 1956cc Hatchback OPEL INSIGNIA B Sports Tourer (Z18) 2.0 CDTi 4x4 (35) (De 03-2017 Até .1-20 -) 154kW 210CV 1956cc Combi		UMB84026L NO. 11056093 - 2060665 TAMPÃO BLOCO DE MOTOR (RELAS) OPEL INSIGNIA A
	UMB84029 NO. 2060946 TAMPÃO BLOCO MOTOR OPEL INSIGNIA A (G09) 1.6 (68) (07.08 A 03.17) 116cv 1598cc Hatchback - OPEL INSIGNIA A Sports Tourer (G09) 1.8 (35) (07.08 A 06.13) 140cv 1796cc Combi		UMV25440 NO. 55536838 - 55563836 - 738313 - 738315 MANETE PUNHO TOPO ALAVANCA MUDANÇAS 6 VELOCIDADES F11MM OPEL INSIGNIA A (G09) 1.4 (68) 04.2011/03.2017 103KW 140CV 1364CC B 14 NET A 14 NET 0035AVG - OPEL INSIGNIA A (G09) 1.4 LPG (68) 07.2012/03.2017 103KW 140CV 1364CC A 14 NET B 14 NET 0035AYD 0035AYH - OPEL INSIGNIA A (G09) 1.6 (68) 07.2008/03.2017 85KW 116CV 1598CC A 16 XER 0035APP 0035AIQ - OPEL INSIGNIA A (G09) 1.6 CDTi (68) 07.2015/03.2017 88KW 120CV 1598CC B 16 DTJ 0035BFD - OPEL INSIGNIA A (G0...
	UMV25440 NO. 55536838 - 55563836 - 738313 - 738315 MANETE PUNHO TOPO ALAVANCA MUDANÇAS 6 VELOCIDADES F11MM OPEL INSIGNIA A Country Tourer (G09) 1.6 CDTi (47) 07.2015/03.2017 88KW 120CV 1598CC B 16 DTJ 0035BFF - OPEL INSIGNIA A Country Tourer (G09) 1.6 CDTi (47) 07.2015/03.2017 100KW 136CV 1598CC B 16 DTH 0035BFI - OPEL INSIGNIA A Country Tourer (G09) 1.6 SIDI (47) 07.2014/03.2017 125KW 170CV 1598CC B 16 SHL A 16 XHT 0035BAR - OPEL INSIGNIA A Country Tourer (G09) 2.0 CDTi (47) 07.2008/03.2017 96KW 131CV...		UMV25440 NO. 55536838 - 55563836 - 738313 - 738315 MANETE PUNHO TOPO ALAVANCA MUDANÇAS 6 VELOCIDADES F11MM OPEL INSIGNIA A Sports Tourer (G09) 1.4 (35) 04.2011/03.2017 103KW 140CV 1364CC A 14 NET B 14 NET 0035BAQ 0035AUH 0035AUR - OPEL INSIGNIA A Sports Tourer (G09) 1.4 LPG (35) 09.2012/03.2017 103KW 140CV 1364CC A 14 NET B 14 NET 0035AYD 0035AYH 0035AYI - OPEL INSIGNIA A Sports Tourer (G09) 1.6 (35) 07.2008/06.2012 85KW 116CV 1598CC A 16 XER 0035AJF 0035AOR - OPEL INSIGNIA A Sports Tourer (G09) 1.6 CD...
	UMV25440 NO. 55536838 - 55563836 - 738313 - 738315 MANETE PUNHO TOPO ALAVANCA MUDANÇAS 6 VELOCIDADES F11MM OPEL INSIGNIA A três volumes (G09) 1.4 (69) 04.2011/03.2017 103KW 140CV 1364CC B 14 NET A 14 NET 0035AUF 0035AVE - OPEL INSIGNIA A três volumes (G09) 1.4 LPG (69) 07.2012/03.2017 103KW 140CV 1364CC B 14 NET A 14 NET 0035ABW 0035AXY - OPEL INSIGNIA A três volumes (G09) 1.6 (69) 07.2008/03.2017 85KW 116CV 1598CC A 16 XER 0035AJR 0035APF - OPEL INSIGNIA A três volumes (G09) 1.6 CDTi (69) 07.2015/03.2...		UMV25442 NO. 55563838 - 55563836 - 738313 - 738315 MANETE ALAVANCA VELOCIDADES (5V) PRETO/CROMO OPEL INSIGNIA A (G09) 1.4 (68) 04.2011/03.2017 103KW 140CV 1364CC B 14 NET A 14 NET 0035AVG - OPEL INSIGNIA A (G09) 1.4 LPG (68) 07.2012/03.2017 103KW 140CV 1364CC A 14 NET B 14 NET 0035AYD 0035AYH - OPEL INSIGNIA A (G09) 1.6 (68) 07.2008/03.2017 85KW 116CV 1598CC A 16 XER 0035APP 0035AIQ - OPEL INSIGNIA A (G09) 1.6 CDTi (68) 07.2015/03.2017 88KW 120CV 1598CC B 16 DTJ 0035BFD - OPEL INSIGNIA A (G0...
	UMV25442 NO. 55563838 - 55563836 - 738313 - 738315 MANETE ALAVANCA VELOCIDADES (5V) PRETO/CROMO OPEL INSIGNIA A Country Tourer (G09) 1.6 CDTi (47) 07.2015/03.2017 88KW 120CV 1598CC B 16 DTJ 0035BFF - OPEL INSIGNIA A Country Tourer (G09) 1.6 CDTi (47) 07.2015/03.2017 100KW 136CV 1598CC B 16 DTH 0035BFI - OPEL INSIGNIA A Country Tourer (G09) 1.6 SIDI (47) 07.2014/03.2017 125KW 170CV 1598CC B 16 SHL A 16 XHT 0035BAR - OPEL INSIGNIA A Country Tourer (G09) 2.0 CDTi (47) 07.2008/03.2017 96KW 131CV...		UMV25442 NO. 55563838 - 55563836 - 738313 - 738315 MANETE ALAVANCA VELOCIDADES (5V) PRETO/CROMO OPEL INSIGNIA A Sports Tourer (G09) 1.4 (35) 04.2011/03.2017 103KW 140CV 1364CC A 14 NET B 14 NET 0035BAQ 0035AUH 0035AUR - OPEL INSIGNIA A Sports Tourer (G09) 1.4 LPG (35) 09.2012/03.2017 103KW 140CV 1364CC A 14 NET B 14 NET 0035AYD 0035AYH 0035AYI - OPEL INSIGNIA A Sports Tourer (G09) 1.6 (35) 07.2008/06.2012 85KW 116CV 1598CC A 16 XER 0035AJF 0035AOR - OPEL INSIGNIA A Sports Tourer (G09) 1.6 CD...
	UMV25442 NO. 55563838 - 55563836 - 738313 - 738315 MANETE ALAVANCA VELOCIDADES (5V) PRETO/CROMO OPEL INSIGNIA A três volumes (G09) 1.4 (69) 04.2011/03.2017 103KW 140CV 1364CC B 14 NET A 14 NET 0035AUF 0035AVE - OPEL INSIGNIA A três volumes (G09) 1.4 LPG (69) 07.2012/03.2017 103KW 140CV 1364CC B 14 NET A 14 NET 0035ABW 0035AXY - OPEL INSIGNIA A três volumes (G09) 1.6 (69) 07.2008/03.2017 85KW 116CV 1598CC A 16 XER 0035AJR 0035APF - OPEL INSIGNIA A três volumes (G09) 1.6 CDTi (69) 07.2015/03.2...		UTR0856 NO. 1305248 - 13502353 TAMPÃO RESERVATÓRIO LIQUIDO REFRIGERAÇÃO OPEL INSIGNIA A (G09) 1.4 (68) (A Partir de 04.11) 140cv 1364cc Hatchback - OPEL INSIGNIA A (G09) 1.4 LPG (68) (A Partir de 07.12) 140cv 1364cc Hatchback - OPEL INSIGNIA A (G09) 1.6 (68) (A Partir de 07.08) 116cv 1598cc Hatchback - OPEL INSIGNIA A (G09) 1.6 SIDI (68) (A Partir de 03.13) 170cv 1598cc Hatchback - OPEL INSIGNIA A (G09) 1.6 Turbo (68) (A Partir de 07.08) 180cv 1598cc Hatchbac...
	UTR0856 NO. 1305248 - 13502353 TAMPÃO RESERVATÓRIO LIQUIDO REFRIGERAÇÃO OPEL INSIGNIA A (G09) 1.4 (68) (De 04-2011 Até .1-20 -) 103kW 140CV 1364cc Hatchback OPEL INSIGNIA A (G09) 1.4 LPG (68) (De 07-2012 Até .1-20 -) 103kW 140CV 1364cc Hatchback OPEL INSIGNIA A (G09) 1.6 (68) (De 07-2008 Até ...) 85kW 116CV 1598cc Hatchback OPEL INSIGNIA A (G09) 1.6 SIDI (68) (De 03-2013 Até .1-20 -) 125kW 170CV 1598cc Hatchback OPEL INSIGNIA A (G09) 1.6 Turbo (68) (De 07-2008 Até		UTR0862 NO. 1305248 - 13502353 TAMPÃO RESERVATÓRIO LIQUIDO REFRIGERAÇÃO OPEL INSIGNIA A (G09) 1.4 (68) (De 04-2011 Até 03-2017) 103kW 140CV 1364cc Hatchback OPEL INSIGNIA A (G09) 1.4 LPG (68) (De 07-2012 Até 03-2017) 103kW 140CV 1364cc Hatchback OPEL INSIGNIA A (G09) 1.6 (68) (De 07-2008 Até 03-2017) 85kW 116CV 1598cc Hatchback OPEL INSIGNIA A (G09) 1.6 SIDI (68) (De 03-2013 Até 03-2017) 125kW 170CV 1598cc Hatchback OPEL INSIGNIA A (G09) 1.6 Turbo (68) (De 07-2008 Até...
	UTR0862 NO. 1305248 - 13502353 TAMPÃO RESERVATÓRIO LIQUIDO REFRIGERAÇÃO OPEL INSIGNIA B Grand Sport (Z18) 1.5 (68) (De 03-2017 Até .1-20 -) 103kW 140CV 1490cc Hatchback OPEL INSIGNIA B Grand Sport (Z18) 1.5 (68) (De 03-2017 Até .1-20 -) 121kW 165CV 1490cc Hatchback OPEL INSIGNIA B Grand Sport (Z18) 2.0 4x4 (68) (De 03-2017 Até .1-20 -) 191kW 260CV 1998cc Hatchback OPEL INSIGNIA B Grand Sport (Z18) 1.6 CDTi (68) (De 03-2017 Até .1-20 -) 81kW 110CV 1598cc Hatchback OPE...		UTV83019 NO. 0652315 - 0652477 - 652315 - 652477 - 90502556 - 96023264 TAMPÃO VEDAÇÃO BUJÃO OPEL INSIGNIA A (G09) 1.4 (68) (De 04-2011 Até 03-2017) 103kW 140CV 1364cc Hatchback OPEL INSIGNIA A (G09) 1.4 LPG (68) (De 07-2012 Até 03-2017) 103kW 140CV 1364cc Hatchback OPEL INSIGNIA A (G09) 1.6 (68) (De 07-2008 Até 03-2017) 85kW 116CV 1598cc Hatchback OPEL INSIGNIA A (G09) 1.6 Turbo (68) (De 07-2008 Até 03-2017) 132kW 180CV 1598cc Hatchback OPEL INSIGNIA A (G09) 1.8 (68) (De 07-2008 Até ...
	d65x35mm 1f-d52x10mm		d65x35mm d48x15mm 1p-d39x32mm

	Z50130 NO. 4811301 - YQ00159480 <i>MOLA REBITE FIXAÇÃO</i> OPEL INSIGNIA B Country Tourer (Z18) 1.5 (47) (06.2017 -) 121kw 165cv 1490cm3 Combi OPEL INSIGNIA B Country Tourer (Z18) 1.6 Turbo (47) (06.2018 -) 147kw 200cv 1598cm3 Combi OPEL INSIGNIA B Country Tourer (Z18) 2.0 4x4 (47) (06.2017 -) 191kw 260cv 1998cm3 Combi OPEL INSIGNIA B Country Tourer (Z18) 2.0 CDTi (47) (06.2017 -) 125kw 170cv 1956cm3 Combi OPEL INSIGNIA B Country Tourer (Z18) 2.0 CDTi 4x4...		Z50130 NO. 4811301 - YQ00159480 <i>MOLA REBITE FIXAÇÃO</i> OPEL INSIGNIA B Grand Sport (Z18) 1.4 Turbo (68) (04.2020 -) 107kw 145cv 1342cm3 Hatchback OPEL INSIGNIA B Grand Sport (Z18) 1.5 (68) (03.2017 -) 103kw 140cv 1490cm3 Hatchback OPEL INSIGNIA B Grand Sport (Z18) 1.5 (68) (03.2017 -) 121kw 165cv 1490cm3 Hatchback OPEL INSIGNIA B Grand Sport (Z18) 1.5 CDTi (68) (02.2020 -) 90kw 122cv 1496cm3 Hatchback OPEL INSIGNIA B Grand Sport (Z18) 1.6 CDTi (68) (0...
	Z50130 NO. 4811301 - YQ00159480 <i>MOLA REBITE FIXAÇÃO</i> OPEL INSIGNIA B Sports Tourer (Z18) 1.5 (35) (03.2017 -) 103kw 140cv 1490cm3 Combi OPEL INSIGNIA B Sports Tourer (Z18) 1.5 (35) (03.2017 -) 121kw 165cv 1490cm3 Combi OPEL INSIGNIA B Sports Tourer (Z18) 1.5 CDTi (35) (02.2020 -) 90kw 122cv 1496cm3 Combi OPEL INSIGNIA B Sports Tourer (Z18) 1.6 CDTi (35) (03.2017 -) 81kw 110cv 1598cm3 Combi OPEL INSIGNIA B Sports Tourer (Z18) 1.6 CDTi (35) (03.2017 -) ...		Z55280 NO. 2228839 <i>MOLA PAINEL REVESTIMENTO DAS PORTAS</i> OPEL INSIGNIA A (G09) 1.4 (68) 04.2011/03.2017 103KW 140CV 1364CC B 14 NET A 14 NET 0035AVG - OPEL INSIGNIA A (G09) 1.4 LPG (68) 07.2012/03.2017 103KW 140CV 1364CC A 14 NET B 14 NET 0035AYD 0035AYH - OPEL INSIGNIA A (G09) 1.6 (68) 07.2008/03.2017 85KW 116CV 1598CC A 16 XER 0035APP 0035AIQ - OPEL INSIGNIA A (G09) 1.6 CDTi (68) 07.2015/03.2017 88KW 120CV 1598CC B 16 DTJ 0035BFD - OPEL INSIGNIA A (G0...
	Z55280 NO. 2228839 <i>MOLA PAINEL REVESTIMENTO DAS PORTAS</i> OPEL INSIGNIA A Country Tourer (G09) 1.6 CDTi (47) 07.2015/03.2017 88KW 120CV 1598CC B 16 DTJ 0035BFF - OPEL INSIGNIA A Country Tourer (G09) 1.6 CDTi (47) 07.2015/03.2017 100KW 136CV 1598CC B 16 DTH 0035BFI - OPEL INSIGNIA A Country Tourer (G09) 1.6 SIDI (47) 07.2014/03.2017 125KW 170CV 1598CC B 16 SHL A 16 XHT 0035BAR - OPEL INSIGNIA A Country Tourer (G09) 2.0 CDTi (47) 07.2008/03.2017 96KW 131CV...		Z55280 NO. 2228839 <i>MOLA PAINEL REVESTIMENTO DAS PORTAS</i> OPEL INSIGNIA A Sports Tourer (G09) 1.4 (35) 04.2011/03.2017 103KW 140CV 1364CC A 14 NET B 14 NET 0035BAQ 0035AUH 0035AUR - OPEL INSIGNIA A Sports Tourer (G09) 1.4 LPG (35) 09.2012/03.2017 103KW 140CV 1364CC A 14 NET B 14 NET 0035AYD 0035AYH - OPEL INSIGNIA A Sports Tourer (G09) 1.6 (35) 07.2008/06.2012 85KW 116CV 1598CC A 16 XER 0035AJF 0035AOR - OPEL INSIGNIA A Sports Tourer (G09) 1.6 CD...
	Z55280 NO. 2228839 <i>MOLA PAINEL REVESTIMENTO DAS PORTAS</i> OPEL INSIGNIA A três volumes (G09) 1.4 (69) 04.2011/03.2017 103KW 140CV 1364CC B 14 NET A 14 NET 0035AUF 0035AVE - OPEL INSIGNIA A três volumes (G09) 1.4 LPG (69) 07.2012/03.2017 103KW 140CV 1364CC B 14 NET A 14 NET 0035BAB 0035AXY - OPEL INSIGNIA A três volumes (G09) 1.6 (69) 07.2008/03.2017 85KW 116CV 1598CC A 16 XER 0035AJR 0035APF - OPEL INSIGNIA A três volumes (G09) 1.6 CDTi (69) 07.2015/03.2...		Z57101 NO. 13252119 <i>MOLA DO PAINEL DA PORTA</i> OPEL INSIGNIA (De 2009 A 2017)
	Z71500 NO. 13252118 <i>MOLA DO PAINEL DA PORTA</i> OPEL INSIGNIA (De 2009 A 2017)		
	F9mm T17mm L14mm H20mm S1-7mm		

OPEL KARL

	A2198-C NO. 13502180 <i>APOIO SUPORTE AMORTECEDOR FRENTE COM ROLAMENTO (GASTA 2 UNIDADES)</i> OPEL KARL (C16): 1.0 LPG 02.2015/03.2018 54KW 73CV 999CC - OPEL KARL (C16): 1.0 01.2015/03.2018 55KW 75CV 999CC		UTR0856 NO. 1305248 - 13502353 <i>TAMPÃO RESERVATÓRIO LIQUIDO REFRIGERAÇÃO</i> OPEL KARL (C16) 1.0 LPG (De 02-2015 Até .1-20 -) 54kW 73CV 999cc Hatchback OPEL KARL (C16) 1.0 (De 01-2015 Até .1-20 -) 55kW 75CV 999cc Hatchback
	d110x34mm 1f-d14mm		65x35mm 1f-d52x10mm
	UTR0862 NO. 1305248 - 13502353 <i>TAMPÃO RESERVATÓRIO LIQUIDO REFRIGERAÇÃO</i> OPEL KARL (C16) 1.0 LPG (De 02-2015 Até .1-20 -) 54kW 73CV 999cc Hatchback OPEL KARL (C16) 1.0 (De 01-2015 Até .1-20 -) 55kW 75CV 999cc Hatchback		Z50130 NO. 4811301 - YQ00159480 <i>MOLA REBITE FIXAÇÃO</i> OPEL KARL (C16) 1.0 (01.2018 - 03.2019) 54kw 73cv 999cm3 Hatchback OPEL KARL (C16) 1.0 (01.2015 - 03.2018) 55kw 75cv 999cm3 Hatchback OPEL KARL (C16) 1.0 LPG (02.2015 - 03.2018) 54kw 73cv 999cm3 Hatchback
	d65x35mm d48x15mm 1p-d39x32mm		d6x 18mm f-d17mm

	Z71162	NO. 11610926		
	MOLA DO PAINEL EXTERIOR MOLDURAS OPEL KARL (A partir de 2016)			
	F13mm T20mm L15mm H20mm S1-7mm			

OPEL MANTA (A)-(B)



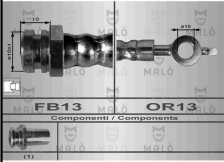

	A2242	NO. 0817744 - 817744 - 90080552		E0008	NO. 852512 - 856517
	APOIO DA BOMBA DO COMBUSTIVEL OPEL MANTA B (58_, 59_) 2.0 E (De 1977.08 Até 1988.08) 81kW 110cv 1979cm3 três volumes - OPEL MANTA B CC (53_, 55_) 2.0 E (De 1977.08 Até 1988.08) 81kW 110cv 1979cm3 Coupé -			ESTICADOR DE ESCAPE OPEL MANTA B (1965 A 1973) - MANTA C (1973 A 1979)	
	19x21mm	2p-d8x14mm		d44x40mm	
	E1003	NO. 0856519 - 856519 - 9281771		E1003	NO. 0856519 - 856519 - 9281771
	ESTICADOR SUPORTE TRÁS DO ESCAPE OPEL MANTA A (58_, 59_): 1.2 04.1972/08.1975 44KW 60CV 1196CC - OPEL MANTA A (58_, 59_): 1.6 02.1975/08.1975 44KW 60CV 1584CC - OPEL MANTA A (58_, 59_): 1.6 09.1970/08.1975 50KW 68CV 1584CC - OPEL MANTA A (58_, 59_): 1.6 02.1975/08.1975 55KW 75CV 1584CC - OPEL MANTA A (58_, 59_): 1.6 S 09.1970/08.1975 59KW 80CV 1584CC - OPEL MANTA A (58_, 59_): 1.9 S 09.1970/08.1975 65KW 88CV 1897CC - OPEL MANTA A...			ESTICADOR SUPORTE TRÁS DO ESCAPE OPEL MANTA B (58_, 59_): 1.3 N 03.1979/12.1980 44KW 60CV 1297CC - OPEL MANTA B (58_, 59_): 1.3 S 08.1981/08.1986 55KW 75CV 1297CC - OPEL MANTA B (58_, 59_): 1.6 N 09.1975/12.1980 44KW 60CV 1584CC - OPEL MANTA B (58_, 59_): 1.6 S 09.1975/12.1981 55KW 75CV 1584CC - OPEL MANTA B (58_, 59_): 1.8 S 07.1982/08.1987 66KW 90CV 1796CC - OPEL MANTA B (58_, 59_): 1.9 N 08.1976/12.1981 55KW 75CV 1897CC - OPEL...	
	50x44x42mm	2f-d5mm 2f-18x9mm		50x44x42mm	2f-d5mm 2f-18x9mm
	F0460-I	NO. 09290155 - 322503 - 322506 - 902828 - 90345195 - 92090155 - 9290155		F0465-I	NO. 0322501 - 0322502 - 322501 - 322502
	FOLE DIRECÇÃO DIREITO/ESQUERDO (GASTA 2 UNIDADES) OPEL MANTA B (58_, 59_) 1.3 N 03.1979/12.1980 44KW 60CV 1297CC 13 N 0039571 - OPEL MANTA B (58_, 59_) 1.3 S 08.1981/08.1986 55KW 75CV 1297CC 13 S 0039588 - OPEL MANTA B (58_, 59_) 1.6 09.1975/08.1981 51KW 69CV 1584CC 16 S - OPEL MANTA B (58_, 59_) 1.6 N 09.1975/12.1980 44KW 60CV 1584CC 16 N 0039505 - OPEL MANTA B (58_, 59_) 1.6 S 09.1975/12.1981 55KW 75CV 1584CC 16 S 0039506 - OPEL MANTA B (58_, 59_)...			FOLE DIRECÇÃO DIREITO/ESQUERDO (GASTA 2 UNIDADES) OPEL MANTA A (58_, 59_) 1.2 04.1972/08.1975 44KW 60CV 1196CC 12 S 0039206 0039209 - OPEL MANTA B CC (53_, 55_) 1.2 N 08.1976/07.1983 40KW 55CV 1196CC 12 N 0039524	
	d70x190mm	1f-d22mm 1f-d40mm		d75x160mm	d52mm 1f-d40mm 1f-d33mm
	F1029	NO. 0402637 - 402637		KF2300	NO. 374019 - 6152107500002 - 90095087
	FOLE APOIO SUPORTE REPARAÇÃO TRANSMISSÃO OPEL MANTA B			FOLE DO LADO DA RODA OPEL MANTA B (1975 A 1988)	
	d82x50mm	1f-d28mm		d96x79mm	1f-d19mm 1f-d77mm
	M6036	NO. 02886093 - 02886931 - 854926		M6041	NO. 854929 - 90091769
	JUNTA DE ESCAPE OPEL MANTA A - B (1978 A 1983)			JUNTA DE ESCAPE OPEL MANTA (1978 A 1987)	
	96x60mm	2f-d36mm		142x68mm	2f-d50mm
	N2001	NO. 852707 - 852712		N2335	NO. 0852713 - 09275338 - 852713 - 9275338
	ANEL DE ESCAPE TRÁS OPEL MANTA A 1.2 (04-1972 A 08-1975)			ANEL ESCAPE OPEL MANTA A (58_, 59_): 1.2 04.1972/08.1975 44KW 60CV 1196CC - OPEL MANTA B CC (53_, 55_): 1.2 N 08.1976/07.1983 40KW 55CV 1196CC	
	d70x14mm	1f-d46mm		d65x15mm	1f-d36mm

	<p>N2336 NO. 852711 - 9275338</p> <p>ANEL ESCAPE</p> <p>OPEL MANTA CC (1975 A 1989) - MANTA B (1975 A 1990)</p> <p>d62x14mm 1f-d36mm</p>		<p>N2336 NO. 852711</p> <p>ANEL ESCAPE</p> <p>OPEL MANTA A (58_, 59_): 1.2 04.1972/08.1975 44KW 60CV 1196CC - OPEL MANTA A (58_, 59_): 1.6 02.1975/08.1975 44KW 60CV 1584CC - OPEL MANTA A (58_, 59_): 1.6 02.1975/08.1975 55KW 75CV 1584CC</p> <p>d62x14mm 1f-d36mm</p>
	<p>N4021 NO. 852713</p> <p>ANEL DE ESCAPE</p> <p>OPEL MANTA A 1.2 (04-1972 A 08-1975) - MANTA B 1.2 (08-1976 A 07-1983)</p> <p>d60x14mm 1f-d33mm</p>		<p>N6371 NO. 08949811 - 852706 - 856507</p> <p>ANEL DE ESCAPE</p> <p>OPEL MANTA A 1.2 - 1.6 - 1.9GT - 1.9E - 1.9S</p> <p>d100x9mm 1f-d82mm</p>
	<p>R0609 NO. 1336250 - 1336316 - 90091138 - 90169012</p> <p>TUBO SUPERIOR DO RADIADOR</p> <p>OPEL MANTA B (58_, 59_) 1.3 N 03.1979/12.1980 44KW 60CV 1297CC 13 N 0039571 - OPEL MANTA B (58_, 59_) 1.3 S 08.1981/08.1986 55KW 75CV 1297CC 13 S 0039588</p> <p>B235-d34/34mm 180-145mm</p>		<p>R0615-M NO. 1336791 - 1336839 - 1336848 - M-220073</p> <p>TUBO SUPERIOR DO RADIADOR</p> <p>OPEL MANTA A (58_, 59_) 1.6 09.1970/08.1975 50KW 68CV 1584CC 16 N 0039480 0039483 - OPEL MANTA A (58_, 59_) 1.6 02.1975/08.1975 44KW 60CV 1584CC 16 N 0039268 0039271 - OPEL MANTA A (58_, 59_) 1.6 02.1975/08.1975 55KW 75CV 1584CC 16 S 0039269 0039272 - OPEL MANTA A (58_, 59_) 1.9 GT/E 02.1974/08.1975 77KW 105CV 1897CC 19 E 0039245 - OPEL MANTA A (58_, 59_) 1.9 S 09.1970/08.1975 65KW 88CV 1897CC 19 ...</p> <p>B290-d38/34mm 105-175-90mm</p>
	<p>R220073 NO. 1336782 - 1336791 - 1336839 - 1336844 - 90121917</p> <p>TUBO DE RADIADOR SUPERIOR</p> <p>OPEL MANTA A (58_, 59_): 1.6 02.1975/08.1975 44KW 60CV 1584CC - OPEL MANTA A (58_, 59_): 1.6 09.1970/08.1975 50KW 68CV 1584CC - OPEL MANTA A (58_, 59_): 1.6 02.1975/08.1975 55KW 75CV 1584CC - OPEL MANTA A (58_, 59_): 1.9 S 09.1970/08.1975 65KW 88CV 1897CC - OPEL MANTA A (58_, 59_): 1.9 S 09.1970/08.1975 66KW 90CV 1897CC - OPEL MANTA A (58_, 59_): 1.9 GT/E 02.1974/08.1975 77KW 105CV 1897CC</p> <p>B340-d34/38mm 115-160-140mm</p>		<p>R220237 NO. 1336212 - 1336864</p> <p>TUBO DE RADIADOR INFERIOR</p> <p>OPEL MANTA B (58_, 59_) 1.6 N 09.1975/12.1980 44KW 60CV 1584CC 16 N 0039505 - OPEL MANTA B (58_, 59_) 1.6 S 09.1975/12.1981 55KW 75CV 1584CC 16 S 0039506 - OPEL MANTA B CC (53_, 55_) 1.2 N 08.1976/07.1983 40KW 55CV 1196CC 12 N 0039524 - OPEL MANTA B CC (53_, 55_) 1.2 S 09.1975/02.1979 44KW 60CV 1196CC 12 S 0039504 - OPEL MANTA B CC (53_, 55_) 1.6 N 09.1975/12.1980 44KW 60CV 1584CC 16 N 0039565</p>
	<p>R220254 NO. 1336749 - 1336783 - 90424150</p> <p>TUBO INFERIOR SAÍDA ÁGUA DO RADIADOR</p> <p>OPEL MANTA A (58_, 59_): 1.6 02.1975/08.1975 44KW 60CV 1584CC - OPEL MANTA A (58_, 59_): 1.6 09.1970/08.1975 50KW 68CV 1584CC - OPEL MANTA A (58_, 59_): 1.6 02.1975/08.1975 55KW 75CV 1584CC - OPEL MANTA A (58_, 59_): 1.9 S 09.1970/08.1975 65KW 88CV 1897CC - OPEL MANTA A (58_, 59_): 1.9 S 09.1970/08.1975 66KW 90CV 1897CC - OPEL MANTA A (58_, 59_): 1.9 GT/E 02.1974/08.1975 77KW 105CV 1897CC</p> <p>B250-d45/35mm 75-175-85mm</p>		<p>R220255 NO. 1336863 - 9281830</p> <p>TUBO DE RADIADOR SUPERIOR</p> <p>OPEL MANTA B (58_, 59_) 1.6 N 09.1975/12.1980 44KW 60CV 1584CC 16 N 0039505 - OPEL MANTA B (58_, 59_) 1.6 S 09.1975/12.1981 55KW 75CV 1584CC 16 S 0039506 - OPEL MANTA B (58_, 59_) 1.9 E 09.1975/08.1977 77KW 105CV 1897CC 19 E 0039508 - OPEL MANTA B (58_, 59_) 1.9 N 08.1976/12.1981 55KW 75CV 1897CC 19 N 0039525 - OPEL MANTA B CC (53_, 55_) 1.6 N 09.1975/12.1980 44KW 60CV 1584CC 16 N 0039565 - OPEL M...</p> <p>B360-d40/40mm 125-240-80mm</p>
	<p>R220260 NO. 1336788</p> <p>TUBO DE RADIADOR SUPERIOR</p> <p>OPEL MANTA A (58_, 59_) 1.2 04.1972/08.1975 44KW 60CV 1196CC 12 S 0039206 0039209</p> <p>B260-d34/34mm 60-150-115-75mm</p>		<p>R220260 NO. 1336788</p> <p>TUBO DE RADIADOR SUPERIOR</p> <p>OPEL MANTA B CC (53_, 55_) 1.2 N 08.1976/07.1983 40KW 55CV 1196CC 12 N 0039524 - OPEL MANTA B CC (53_, 55_) 1.2 S 09.1975/02.1979 44KW 60CV 1196CC 12 S 0039504</p> <p>B260-d34/34mm 60-150-115-75mm</p>
	<p>R220284 NO. 1336250 - 1336251 - 1336316 - 90091138 - 90169012</p> <p>TUBO DE RADIADOR SUPERIOR</p> <p>OPEL MANTA B (58_, 59_): 1.3 N 03.1979/12.1980 44KW 60CV 1297CC - OPEL MANTA B (58_, 59_): 1.3 S 08.1981/08.1986 55KW 75CV 1297CC</p> <p>B225-d34/34mm 120-80-115mm</p>		<p>UTR0626 NO. 1326003</p> <p>TAMPÃO RADIADOR</p> <p>OPEL MANTA B (58_, 59_) 1.3 N (De 1979.03 Até 1980.12) 44kW 60cv 1297cm3 três volumes - OPEL MANTA B (58_, 59_) 1.3 S (De 1981.08 Até 1986.08) 55kW 75cv 1297cm3 três volumes - OPEL MANTA B CC (53_, 55_) 1.3 N (De 1979.03 Até 1980.12) 44kW 60cv 1297cm3 Coupé - OPEL MANTA B CC (53_, 55_) 1.3 S (De 1979.08 Até 1986.08) 55kW 75cv 1297cm3 Coupé -</p> <p>d59/79x28mm d38x25mm</p>
	<p>UTR0811 NO. 1304659 - 1304660 - 1304661 - 1304666 - 1304666 - 1304853 - 4395513 - 90352470 - 90409256 - 90409257...</p> <p>TAMPÃO RESERVATÓRIO LÍQUIDO REFRIGERAÇÃO</p> <p>OPEL MANTA B-CC 1.8 S (07.82 A 08.87) 90cv 1796cc Coupé</p> <p>60x25mm 1f-d52x14mm</p>		<p>UTR0859 NO. 1650630 - 94539597 - 96293957 - 96312510 - 96351578 - 96420303 - 96536649</p> <p>TAMPÃO RESERVATÓRIO LÍQUIDO REFRIGERAÇÃO</p> <p>OPEL MANTA B (58_, 59_) 1.8 S (07.82 A 08.87) 90cv 1796cc três volumes - OPEL MANTA B (58_, 59_) 1.9 E (09.75 A 08.77) 105cv 1897cc três volumes - OPEL MANTA BCC (53_, 55_) 1.8 S (07.82 A 08.87) 90cv 1796cc Coupé</p> <p>d63x23mm 1f-d53x11mm</p>











	RT08697	NO. 4293901 - 4294450 - 94113583 - 94227189		
	TUBO DE TRAVÃO FRENTE LH - RH (GASTA 2 UNIDADES) OPEL MIDI Autocarro 2.0 TD 09.1984/08.1992 51KW 69CV 1994CC 20DIE - OPEL MIDI Autocarro 2.2 D 4WD 09.1984/08.1992 45KW 61CV 2189CC 22DIE 4FD1			
	545mm	FB13 - OR13		

OPEL MOKKA

	A2288	NO. 13252362 - 436565		U0314	NO. 0424761
	APOIO SUPORTE AMORTECEDOR TRÁS (GASTA 2 UNIDADES) OPEL MOKKA / MOKKA X (J13): 1.4 (_76) 04.2013/>>> 103KW 140CV 1364CC - OPEL MOKKA / MOKKA X (J13): 1.4 LPG (_76) 04.2013/>>> 103KW 140CV 1364CC - OPEL MOKKA / MOKKA X (J13): 1.4 4x4 (_76) 06.2012/>>> 103KW 140CV 1364CC - OPEL MOKKA / MOKKA X (J13): 1.4 4x4 (_76) 06.2016/>>> 112KW 152CV 1399CC - OPEL MOKKA / MOKKA X (J13): 1.6 (_76) 06.2012/>>> 85KW 116CV 1598CC - OPEL MOKKA / MOKKA X (J13): 1.6 CD...			ANILHA DA SUSPENSÃO DAS MOLAS DE TRÁS INFERIOR OPEL MOKKA / MOKKA X (J13) 1.4 (_76) (04.2013 -) 103kw 140cv 1364cm3 SUV OPEL MOKKA / MOKKA X (J13) 1.4 4x4 (_76) (06.2012 -) 103kw 140cv 1364cm3 SUV OPEL MOKKA / MOKKA X (J13) 1.4 4x4 (_76) (06.2016 -) 112kw 152cv 1399cm3 SUV OPEL MOKKA / MOKKA X (J13) 1.4 LPG (_76) (04.2013 -) 103kw 140cv 1364cm3 SUV OPEL MOKKA / MOKKA X (J13) 1.6 (_76) (06.2012 -) 85kw 116cv 1598cm3 SUV OPEL MOKKA / MOKKA X (J1...	
	137x75x47mm	1f-d10mm 2f-d13mm		d132x22mm	1f-d33mm
	UCRZ1079	NO. 0446078		UCRZ1092	NO. 1603038 - 1603039 - 1603050 - 5374099 - 5374154
	CRUZETA TRANSMISSÃO VEIO LONGITUDINAL D24X64MM OPEL MOKKA / MOKKA X (J13) 1.4 (_76) (De 04.2013 -) 103kw 140cv 1364cm3 SUV - OPEL MOKKA / MOKKA X (J13) 1.4 4x4 (_76) (De 06.2012 -) 103kw 140cv 1364cm3 SUV - OPEL MOKKA / MOKKA X (J13) 1.4 4x4 (_76) (De 06.2016 -) 112kw 152cv 1399cm3 SUV - OPEL MOKKA / MOKKA X (J13) 1.4 LPG (_76) (De 04.2013 -) 103kw 140cv 1364cm3 SUV - OPEL MOKKA / MOKKA X (J13) 1.6 (_76) (De 06.2012 -) 85kw 116cv 1598cm3 SUV - ...			CRUZETA TRANSMISSÃO TRIPOIDE D33,90MM/23 DENTES OPEL MOKKA / MOKKA X (J13) 1.6 (_76) (De 06.2012 -) 85KW 116CV 1598CM3 SUV -	
	d24x65x45mm			d33.9mm	(23 dentes)
	UMB84026L	NO. 11056093 - 2060665		UMB84029	NO. 2060946
	TAMPÃO BLOCO DE MOTOR (RELAS) OPEL MOKKA			TAMPÃO BLOCO MOTOR OPEL MOKKA / MOKKA X (J13) 1.6 (_76) (A Partir de 06.12) 116cv 1598cc Veículo todo terreno fechado - OPEL MOKKA / MOKKA X (J13) 1.6 (_76) (A Partir de 06.12) 116cv 1598cc Veículo todo terreno fechado	
	d-34x13mm	di-31,2mm		d36x10mm	di-32mm
	UPCR5017	NO. 09594682 - 09598708 - 10018202 - 1008013 - 14032479 - 4817533 - 8095946820 - 88891748 - 9591699 - 95...		UTR0856	NO. 1305248 - 13502353
	PORCA DA RODA CHAVE 19 M12X1,50X36MM (BASE CONICA) OPEL MOKKA / MOKKA X (J13) 1.4 (_76) (04.2013 -) 103kw 140cv 1364cm3 SUV OPEL MOKKA / MOKKA X (J13) 1.4 4x4 (_76) (06.2012 -) 103kw 140cv 1364cm3 SUV OPEL MOKKA / MOKKA X (J13) 1.4 4x4 (_76) (06.2016 -) 112kw 152cv 1399cm3 SUV OPEL MOKKA / MOKKA X (J13) 1.4 LPG (_76) (04.2013 -) 103kw 140cv 1364cm3 SUV OPEL MOKKA / MOKKA X (J13) 1.6 (_76) (06.2012 -) 85kw 116cv 1598cm3 SUV OPEL MOKKA / MOKKA X (J1...			TAMPÃO RESERVATÓRIO LIQUIDO REFRIGERAÇÃO OPEL MOKKA / MOKKA X (J13) 1.4 LPG (A Partir de 04.13) 140cv 1364cc Veículo todo-terreno fechado 4 / 4 - OPEL MOKKA / MOKKA X (J13) 1.7 CDTI (A Partir de 06.12) 131cv 1686cc Veículo todo-terreno fechado - OPEL MOKKA / MOKKA X (J13) 1.7 CDTI 4x4 (A partir de 06.12) 131cv 1686cc Veículo todo-terreno fechado	
	d23x35mm	M12x32mm		65x35mm	1f-d52x10mm
	UTR0856	NO. 1305248 - 13502353		UTR0862	NO. 1305248 - 13502353
	TAMPÃO RESERVATÓRIO LIQUIDO REFRIGERAÇÃO OPEL MOKKA / MOKKA X (J13) 1.4 (_76) (De 04-2013 Até .1-20 -) 103kW 140CV 1364cc Veículo todo-terreno fechado OPEL MOKKA / MOKKA X (J13) 1.4 LPG (_76) (De 04-2013 Até .1-20 -) 103kW 140CV 1364cc Veículo todo-terreno fechado OPEL MOKKA / MOKKA X (J13) 1.4 4x4 (_76) (De 06-2012 Até .1-20 -) 103kW 140CV 1364cc Veículo todo-terreno fechado OPEL MOKKA / MOKKA X (J13) 1.4 4x4 (_76) (De 06-2012 Até...			TAMPÃO RESERVATÓRIO LIQUIDO REFRIGERAÇÃO OPEL MOKKA / MOKKA X (J13) 1.4 (_76) (De 04-2013 Até .1-20 -) 103kW 140CV 1364cc Veículo todo-terreno fechado OPEL MOKKA / MOKKA X (J13) 1.4 LPG (_76) (De 04-2013 Até .1-20 -) 103kW 140CV 1364cc Veículo todo-terreno fechado OPEL MOKKA / MOKKA X (J13) 1.4 4x4 (_76) (De 06-2012 Até .1-20 -) 103kW 140CV 1364cc Veículo todo-terreno fechado OPEL MOKKA / MOKKA X (J13) 1.4 4x4 (_76) (De 06-2012 Até...	
	65x35mm	1f-d52x10mm		d65x35mm	d48x15mm 1p-d39x32mm
	UTV83019	NO. 0652315 - 0652477 - 652315 - 652477 - 90502556 - 96023264		W5159	NO. 055575960 - 0614172 - 0614758 - 098022837 - 098039173 - 55575960 - 5614450 - 614172 - 614758 - 986922...
	TAMPÃO VEDAÇÃO BUJÃO OPEL MOKKA / MOKKA X (J13) 1.4 (_76) (De 04-2013 Até .1-20 -) 103kW 140CV 1364cc Veículo todo-terreno fechado OPEL MOKKA / MOKKA X (J13) 1.4 LPG (_76) (De 04-2013 Até .1-20 -) 103kW 140CV 1364cc Veículo todo-terreno fechado OPEL MOKKA / MOKKA X (J13) 1.4 4x4 (_76) (De 06-2012 Até .1-20 -) 103kW 140CV 1364cc Veículo todo-terreno fechado			POLIE CAMBOTA 6 PISTAS OPEL MOKKA / MOKKA X (J13) 1.7 CDTI (_76) desde 06.2012 96KW 131CV 1686CC A 17 DTS 0035AWY 0035AXA - OPEL MOKKA / MOKKA X (J13) 1.7 CDTI 4x4 (_76) desde 06.2012 96KW 131CV 1686CC A 17 DTS 0035AWX 0035AWZ	
	d25x14mm	c9mm d13mm		d154mm	d48mm







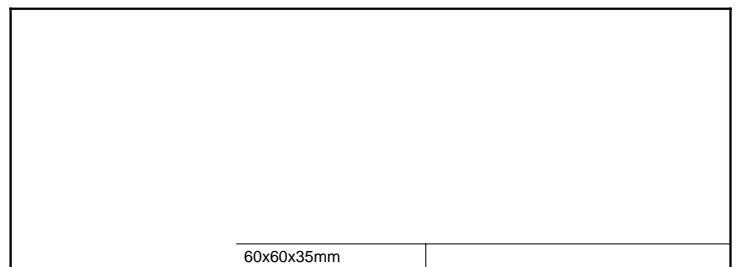



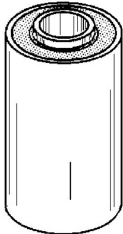
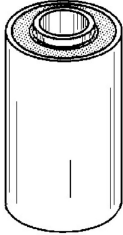

	Y3227	NO. 0328004 - 09595179 - 09599302 - 11611063 - 15651585 - 9595179		Z50130	NO. 4811301 - YQ00159480
	PARAFUSO DA RODA CAVILHA OPEL MOKKA / MOKKA X (J13) 1.4 (_76) 04.2013 -) 103kw 140cv 1364cm3 SUV OPEL MOKKA / MOKKA X (J13) 1.4 4x4 (_76) 06.2012 -) 103kw 140cv 1364cm3 SUV OPEL MOKKA / MOKKA X (J13) 1.4 4x4 (_76) 06.2016 -) 112kw 152cv 1399cm3 SUV OPEL MOKKA / MOKKA X (J13) 1.4 LPG (_76) 04.2013 -) 103kw 140cv 1364cm3 SUV OPEL MOKKA / MOKKA X (J13) 1.6 (_76) 06.2012 -) 85kw 116cv 1598cm3 SUV OPEL MOKKA / MOKKA X (J13) 1....			MOLA REBITE FIXAÇÃO OPEL MOKKA / MOKKA X (J13) 1.4 (_76) (06.2018 -) 88kw 120cv 1364cm3 SUV OPEL MOKKA / MOKKA X (J13) 1.4 (_76) (04.2013 -) 103kw 140cv 1364cm3 SUV OPEL MOKKA / MOKKA X (J13) 1.4 4x4 (_76) (06.2012 -) 103kw 140cv 1364cm3 SUV OPEL MOKKA / MOKKA X (J13) 1.4 4x4 (_76) (06.2016 -) 112kw 152cv 1399cm3 SUV OPEL MOKKA / MOKKA X (J13) 1.4 LPG (_76) (04.2013 -) 103kw 140cv 1364cm3 SUV OPEL MOKKA / MOKKA X (J1...)	
	c56mm	M12x1mm		d6x 18mm	f-d17mm
	Z55280	NO. 2228839		Z71162	NO. 11610926
	MOLA PAINEL REVESTIMENTO DAS PORTAS OPEL MOKKA / MOKKA X (J13) 1.4 (_76) desde 04.2013 103KW 140CV 1364CC D 14 NET A 14 NET B 14 NET 0035BAY 0035BAZ 0035BIP 1844AIS 1844AAU - OPEL MOKKA / MOKKA X (J13) 1.4 (_76) desde 06.2018 88KW 120CV 1364CC D 14 NEL 1844AIT 1844AII - OPEL MOKKA / MOKKA X (J13) 1.4 4x4 (_76) desde 06.2012 103KW 140CV 1364CC B 14 NET D 14 NET A 14 NET 0035AWT 0035AWU 0035BIQ 1844AIR 1844AAR - OPEL MOKKA / MOKKA X (...)			MOLA DO PAINEL EXTERIOR MOLDURAS OPEL MOKKA X (A partir de 2013)	
	F-G-mm	T-27L-18H-12S-5mm		F13mm T20mm L15mm	H20mm S1-7mm

OPEL MONTEREY









	A1494	NO. 8-94328-799-0 - 8-94386-854-0		A1762	NO. 8-94375-283-2
	APOIO DE TRANSMISSÃO COM ROLAMENTO 30MM OPEL MONTEREY A (M92): 3.2 (UBS25D, UBS25G) 08.1991/03.1994 130KW 177CV 3165CC - OPEL MONTEREY A (M92): 3.1 TD (UBS69D, UBS69G) 09.1991/07.1998 84KW 114CV 3059CC			APOIO DE MOTOR ESQUERDO OPEL MONTEREY A (M92) 3.1 TD (UBS69D, UBS69G) 09.1991/07.1998 84KW 114CV 3059CC 4 JG2TC 7115311 7115313 - OPEL MONTEREY A (M92) 3.2 (UBS25D, UBS25G) 08.1991/03.1994 130KW 177CV 3165CC 6VD1 (SOHC) 7115310 7115312	
	135x115x50mm	1f-d30mm		142x145x55mm	1p-d12x25mm
	A1763	NO. 8-97104-157-1		A1768	NO. 8-94375-282-5
	APOIO DE MOTOR DIREITO OPEL MONTEREY A (M92) 3.1 TD (UBS69D, UBS69G) 09.1991/07.1998 84KW 114CV 3059CC 4 JG2TC 7115311 7115313 - OPEL MONTEREY A (M92) 3.2 (UBS25D, UBS25G) 08.1991/03.1994 130KW 177CV 3165CC 6VD1 (SOHC) 7115310 7115312			APOIO DE MOTOR DIREITO OPEL MONTEREY A (M92): 3.2 (UBS25D, UBS25G) 08.1991/03.1994 130KW 177CV 3165CC - OPEL MONTEREY A (M92): 3.1 TD (UBS69D, UBS69G) 09.1991/07.1998 84KW 114CV 3059CC	
	140x110x53mm	2p-d10x28mm		140x140x50mm	1p-d12x30mm
	E0271	NO. 03 50 236 - 0350607 - 5352019 - 97018228 - 97125014 - 97289820 - 97018227 - 97125013 - 97289819 - 44...		E0271	NO. 03 50 236 - 0350607 - 5352019 - 97018228 - 97125014 - 97289820 - 0350608 - 0444065 - 097018125 - 035...
	ESTICADOR BARRA ESTABILIZADORA FRENTE LADO DIREITO OPEL MONTEREY A (M92) 3.1 TD (UBS69D, UBS69G) 09.1991/07.1998 84KW 114CV 3059CC 4 JG2TC 7115311 7115313 - OPEL MONTEREY A (M92) 3.2 (UBS25D, UBS25G) 08.1991/03.1994 130KW 177CV 3165CC 6VD1 (SOHC) 7115310 7115312			ESTICADOR BARRA ESTABILIZADORA FRENTE LADO DIREITO OPEL MONTEREY B (M98) 3.0 DTI (UBS73D, UBS73G) 07.1998/08.1999 117KW 159CV 2999CC 4 JX1 7115315 - OPEL MONTEREY B (M98) 3.5 V6 24V (UBS26D, UBS26G) 07.1998/08.1999 158KW 215CV 3494CC 6 VE1 7115314	
	180x36x36mm	2p-d10x20mm		180x36x36mm	2p-d10x20mm
	E0272	NO. 0350235 - 0350608 - 5352020 - 97 28 9819 - 97018227 - 97125013		E0272	NO. 0350235 - 0350608 - 5352020 - 97 28 9819 - 97018227 - 97125013
	ESTICADOR BARRA ESTABILIZADORA FRENTE ESQUERDO OPEL MONTEREY A (M92) 3.1 TD (UBS69D, UBS69G) 09.1991/07.1998 84KW 114CV 3059CC 4 JG2TC 7115311 7115313 - OPEL MONTEREY A (M92) 3.2 (UBS25D, UBS25G) 08.1991/03.1994 130KW 177CV 3165CC 6VD1 (SOHC) 7115310 7115312			ESTICADOR BARRA ESTABILIZADORA FRENTE ESQUERDO OPEL MONTEREY B (M98) 3.0 DTI (UBS73D, UBS73G) 07.1998/08.1999 117KW 159CV 2999CC 4 JX1 7115315 - OPEL MONTEREY B (M98) 3.5 V6 24V (UBS26D, UBS26G) 07.1998/08.1999 158KW 215CV 3494CC 6 VE1 7115314	
	180x36x36mm	2p-d10x20mm		180x36x36mm	2p-d10x20mm
	E1054	NO. 852725 - 97023183		E1076	NO. 8-97080-694-0 - 8-97289-169-0 - 856024
	ESTICADOR DE ESCAPE OPEL MONTEREY (1992 A 1995)			ESTICADOR ESCAPE MONTEREY A (M92) INFORMAÇÕES TIPO ANO DE CONSTRUÇÃO KW HP CC CÓDIGO(S) DO MOTOR NÚMERO KBA (ALEMANHA) 3.1 TD (UBS69D, UBS69G) 09.1991 - 07.1998 84 114 3059 4	
	56x56x29mm	2f-d9mm			



	<p>E1117 NO. 4410148 - 4422016 - 91166194 - 93865793</p> <p>ESTICADOR DO ESCAPE</p> <p>OPEL MONTEREY A (UBS_) 3.2 (UBS25_) (06.92 A 07.98) 177cv 3165cc Veículo todo-terreno fechado - OPEL MONTEREY A (UBS_) 3.1 TD (UBS69_) (09.91 A 07.98) 114cv 3059cc Veículo todo-terreno fechado</p> <p>d8x40x38mm 2f-d12mm</p>		<p>EBTV8050 NO. 0542626 - 93173226 - 93173228 - 97035258 - 97035259 - 97035261 - 97039050 - 97039051 - 97144478 - 97...</p> <p>EMBOLO PINÇA TRAVÃO DE TRÁS KASKO 41MM</p> <p>OPEL MONTEREY A (M92) 3.1 TD (UBS69D, UBS69G) 09.1991/07.1998 84KW 114CV 3059CC 4 JG2TC 7115311 7115313 - OPEL MONTEREY A (M92) 3.2 (UBS25D, UBS25G) 08.1991/03.1994 130KW 177CV 3165CC 6VD1 (SOHC) 7115310 7115312</p> <p>d41x46mm 1f-d29mm</p>
	<p>KF2327 NO. 94312678</p> <p>KIT DE FOLE TRANSMISSAO</p> <p>OPEL MONTEREY A (M92): 3.2 (UBS25D, UBS25G) 08.1991/03.1994 130KW 177CV 3165CC - OPEL MONTEREY A (M92): 3.1 TD (UBS69D, UBS69G) 09.1991/07.1998 84KW 114CV 3059CC</p> <p>d86x84mm 1f-d76mm 1f-d22mm</p>		<p>KF3885 NO. 0301710 - 0301712 - 0374082 - 301710 - 301712 - 374082 - 8-97139-981-0 - 97139981 - 97148750 ...</p> <p>KIT DE FOLE DO CARDAN JUNTO À RODA E CAIXA</p> <p>OPEL MONTEREY B 3.0 DTi - 3.5i V6 24V (1998 A 1999)</p> <p>d100x100mm 1f-d83mm 1f-d25mm</p>
	<p>KM0404 NO. 98005814</p> <p>KIT BRINCOS DE MOLAS TRÁS PARTE DE TRÁS (GASTA 2 UNIDADES)</p> <p>OPEL MONTEREY A (M92): 3.2 (UBS25D, UBS25G) 08.1991/03.1994 130KW 177CV 3165CC - OPEL MONTEREY A (M92): 3.1 TD (UBS69D, UBS69G) 09.1991/07.1998 84KW 114CV 3059CC - OPEL MONTEREY B (M98): 3.5 V6 24V (UBS26D, UBS26G) 07.1998/08.1999 158KW 215CV 3494CC - OPEL MONTEREY B (M98): 3.0 DTi (UBS73D, UBS73G) 07.1998/08.1999 117KW 159CV 2999CC</p> <p>132x90x40mm d30mm</p>		<p>KMEX0001 NO. 0308456 - 0308575 - 0308700 - 308456 - 308575 - 308700 - 94407708 - 94407718 - 97123691</p> <p>KIT REPARAÇÃO MANGA DE EIXO</p> <p>OPEL MONTEREY A (M92) 3.1 TD (UBS69D, UBS69G) 09.1991/07.1998 84KW 114CV 3059CC 4 JG2TC 7115311 7115313 - OPEL MONTEREY A (M92) 3.2 (UBS25D, UBS25G) 08.1991/03.1994 130KW 177CV 3165CC 6VD1 (SOHC) 7115310 7115312 - OPEL MONTEREY B (M98) 3.5 V6 24V (UBS26D, UBS26G) 07.1998/08.1999 158KW 215CV 3494CC 6 VE1 7115314</p> <p>d87x18mm d53x2mm d37x16.5mm 1f-d34mm 1f-d30mm</p>
	<p>KUBT3002 NO. 05 42 267 - 05 42 268 - 1605850 - 1605949 - 5 42 283 - 5 42 284 - 97035265 - 97134718</p> <p>KIT BORRACHAS TRAVAO PINÇA TRAS AKE/AKEBONO 42MM</p> <p>OPEL MONTEREY A (M92): 3.2 (UBS25D, UBS25G) 08.1991/03.1994 130KW 177CV 3165CC - OPEL MONTEREY A (M92): 3.1 TD (UBS69D, UBS69G) 09.1991/07.1998 84KW 114CV 3059CC - OPEL MONTEREY B (M98): 3.5 V6 24V (UBS26D, UBS26G) 07.1998/08.1999 158KW 215CV 3494CC - OPEL MONTEREY B (M98): 3.0 DTi (UBS73D, UBS73G) 07.1998/08.1999 117KW 159CV 2999CC</p> <p>d52x8mm d49x3mm d52x21mm d20x25mm d11x10mm d9x8mm</p>		<p>KUBT3003 NO. 05 42 107 - 05 42 116 - 05 42 247 - 05 42 248 - 16 05 853 - 1605948 - 5 42 107 - 5 42 116 - 5 42 247...</p> <p>KIT BORRACHAS TRAVAO PINÇA FRENTE ATE/AKEBONO 60MM</p> <p>OPEL MONTEREY A (M92): 3.2 (UBS25D, UBS25G) 08.1991/03.1994 130KW 177CV 3165CC - OPEL MONTEREY A (M92): 3.1 TD (UBS69D, UBS69G) 09.1991/07.1998 84KW 114CV 3059CC - OPEL MONTEREY B (M98): 3.5 V6 24V (UBS26D, UBS26G) 07.1998/08.1999 158KW 215CV 3494CC - OPEL MONTEREY B (M98): 3.0 DTi (UBS73D, UBS73G) 07.1998/08.1999 117KW 159CV 2999CC</p> <p>d70x7mm d70x3mm d76x21mm d20x27mm d11x10mm d11x9mm</p>
	<p>L1013 NO. 00432751 - 0432751 - 094234319 - 432751 - 5-51151-007-0 - 8-94234-190-0 - 8-94234-319-0 - 8-97332-64...</p> <p>CASQUILHO DE MOLAS DE TRÁS PARTE DE TRÁS (8 UNIDADES)</p> <p>OPEL MONTEREY A (M92): 3.2 (UBS25D, UBS25G) 08.1991/03.1994 130KW 177CV 3165CC - OPEL MONTEREY A (M92): 3.1 TD (UBS69D, UBS69G) 09.1991/07.1998 84KW 114CV 3059CC - OPEL MONTEREY B (M98): 3.5 V6 24V (UBS26D, UBS26G) 07.1998/08.1999 158KW 215CV 3494CC - OPEL MONTEREY B (M98): 3.0 DTi (UBS73D, UBS73G) 07.1998/08.1999 117KW 159CV 2999CC</p> <p>d36x38mm d30mm 1f-d18mm</p>		<p>L1042 NO. 894223-168-0</p> <p>CASQUILHO DE MOLAS DE TRÁS PARTE DA FRENTE (4 UNIDADES)</p> <p>OPEL MONTEREY A (M92): 3.2 (UBS25D, UBS25G) 08.1991/03.1994 130KW 177CV 3165CC - OPEL MONTEREY A (M92): 3.1 TD (UBS69D, UBS69G) 09.1991/07.1998 84KW 114CV 3059CC - OPEL MONTEREY B (M98): 3.5 V6 24V (UBS26D, UBS26G) 07.1998/08.1999 158KW 215CV 3494CC - OPEL MONTEREY B (M98): 3.0 DTi (UBS73D, UBS73G) 07.1998/08.1999 117KW 159CV 2999CC</p> <p>d45x35mm d40mm 1f-d18mm</p>
	<p>L3109 NO. 0423751 - 094234319 - 423751 - 8-94234-190-0 - 8-94234-319-0 - 8-97332-642-0 - 8-97357-492-0 - 94234...</p> <p>CASQUILHO DE MOLAS DE TRÁS PARTE DE TRÁS (8 UNIDADES)</p> <p>OPEL MONTEREY B (M98): 3.5 V6 24V (UBS26D, UBS26G) 07.1998/08.1999 158KW 215CV 3494CC - OPEL MONTEREY B (M98): 3.0 DTi (UBS73D, UBS73G) 07.1998/08.1999 117KW 159CV 2999CC</p> <p>d36x36mm d30mm 1f-d18mm</p>		<p>M6007 NO. 854963 - 97102031</p> <p>JUNTA DO COLECTOR DE ESCAPE</p> <p>OPEL MONTEREY A</p> <p>d67x5mm 1f-d56mm</p>
	<p>M6007 NO. 854963 - 97102031</p> <p>JUNTA DO COLECTOR DE ESCAPE</p> <p>OPEL MONTEREY B</p> <p>d67x5mm 1f-d56mm</p>		<p>M6008 NO. 91137992 - 94236345 - 94329529</p> <p>JUNTA DE ESCAPE</p> <p>OPEL MONTEREY A (M92): 3.1 TD (UBS69D, UBS69G) 09.1991/07.1998 84KW 114CV 3059CC</p> <p>d65x5mm 1f-d50mm</p>
	<p>M6017 NO. 854963 - 97102031</p> <p>JUNTA DE ESCAPE</p> <p>OPEL MONTEREY</p> <p>d56.5x10mm 1f-d44mm</p>		<p>M6082 NO. 854943 - 854944 - 854955 - 97069287</p> <p>JUNTA DE ESCAPE</p> <p>OPEL MONTEREY (1988 A 1991)</p> <p>d64x5mm 1f-d53mm</p>

	<p>M6100 NO. 852803 - 94328352</p> <p>JUNTA DE ESCAPE</p> <p>OPEL MONTEREY (1992 A 1998)</p> <p>116x80x2mm 1f-d65mm</p>		<p>S1011 NO. 9-51151-023-0 - 9-51151-023-1 - 9-51151-036-0</p> <p>SILENT-BLOC DE MOLAS DA FRENTE (GASTA 4 UNIDADES)</p> <p>OPEL MONTEREY A (M92): 3.2 (UBS25D, UBS25G) 08.1991/03.1994 130KW 177CV 3165CC - OPEL MONTEREY A (M92): 3.1 TD (UBS69D, UBS69G) 09.1991/07.1998 84KW 114CV 3059CC - OPEL MONTEREY B (M98): 3.5 V6 24V (UBS26D, UBS26G) 07.1998/08.1999 158KW 215CV 3494CC - OPEL MONTEREY B (M98): 3.0 DTI (UBS73D, UBS73G) 07.1998/08.1999 117KW 159CV 2999CC</p> <p>d38x68mm c61mm 1f-d16mm</p>
	<p>S1011-B NO. 9-51151-023-0 - 9-51151-023-1 - 9-51151-036-0</p> <p>SILENT-BLOC DE MOLAS DA FRENTE (GASTA 4 UNIDADES)</p> <p>OPEL MONTEREY A (M92): 3.2 (UBS25D, UBS25G) 08.1991/03.1994 130KW 177CV 3165CC - OPEL MONTEREY A (M92): 3.1 TD (UBS69D, UBS69G) 09.1991/07.1998 84KW 114CV 3059CC - OPEL MONTEREY B (M98): 3.5 V6 24V (UBS26D, UBS26G) 07.1998/08.1999 158KW 215CV 3494CC - OPEL MONTEREY B (M98): 3.0 DTI (UBS73D, UBS73G) 07.1998/08.1999 117KW 159CV 2999CC</p> <p>d38x68mm c61mm 1f-d16mm</p>		<p>S1244 NO. 0302411 - 0310400 - 29041-40K00 - 302292 - 302411 - 8-94408-840-0 - 8-94408-840-1 - 8-94408-840-2 - ...</p> <p>SILENT-BLOC DO BRAÇO DA SUSPENSÃO SUPERIOR (GASTA 4 UNIDADES)</p> <p>OPEL MONTEREY A (M92): 3.2 (UBS25D, UBS25G) 08.1991/03.1994 130KW 177CV 3165CC - OPEL MONTEREY A (M92): 3.1 TD (UBS69D, UBS69G) 09.1991/07.1998 84KW 114CV 3059CC - OPEL MONTEREY B (M98): 3.5 V6 24V (UBS26D, UBS26G) 07.1998/08.1999 158KW 215CV 3494CC - OPEL MONTEREY B (M98): 3.0 DTI (UBS73D, UBS73G) 07.1998/08.1999 117KW 159CV 2999CC</p> <p>d50x45mm c33mm d38mm 1f-d18mm</p>
	<p>S1316 NO. 0302294 - 0310402 - 0352456 - 29040-50K00 - 29043-70K00 - 302294 - 45503-87706 - 8-94408-842-0 - 8-...</p> <p>SILENT-BLOC DO BRAÇO DA SUSPENSÃO INFERIOR (GASTA 2 UNIDADES)</p> <p>OPEL MONTEREY A (M92): 3.2 (UBS25D, UBS25G) 08.1991/03.1994 130KW 177CV 3165CC - OPEL MONTEREY A (M92): 3.1 TD (UBS69D, UBS69G) 09.1991/07.1998 84KW 114CV 3059CC - OPEL MONTEREY B (M98): 3.5 V6 24V (UBS26D, UBS26G) 07.1998/08.1999 158KW 215CV 3494CC - OPEL MONTEREY B (M98): 3.0 DTI (UBS73D, UBS73G) 07.1998/08.1999 117KW 159CV 2999CC</p> <p>d44x85mm c76mm 1f-d18mm</p>		<p>S1317 NO. 352455 - 8-94408-841-1 - 94408841</p> <p>SILENT-BLOC DO BRAÇO DA SUSPENSÃO INFERIOR (GASTA 2 UNIDADES)</p> <p>OPEL MONTEREY A (M92): 3.2 (UBS25D, UBS25G) 08.1991/03.1994 130KW 177CV 3165CC - OPEL MONTEREY A (M92): 3.1 TD (UBS69D, UBS69G) 09.1991/07.1998 84KW 114CV 3059CC</p> <p>d42x56mm d36mm 1f-d16mm</p>
	<p>S1482 NO. 0423602 - 0464314 - 0464316 - 8-94375-105-0 - 8-97021-0550 - 91153044 - 97021055</p> <p>SILENT-BLOC DO ESTICADOR SUSPENSÃO TRAS (GASTA 4 UNIDADES)</p> <p>OPEL MONTEREY A (M92) 3.1 TD (UBS69D, UBS69G) 09.1991/07.1998 84KW 114CV 3059CC 4 JG2TC 7115311 7115313 - OPEL MONTEREY A (M92) 3.2 (UBS25D, UBS25G) 08.1991/03.1994 130KW 177CV 3165CC 6VD1 (SOHC) 7115310 7115312</p> <p>d54x71mm c55mm 1f-d14mm</p>		<p>S1484 NO. 8-97104-178-0 - 0310400 - 29041-40K00 - 302292 - 302411 - 8-94408-840-0 - 8-94408-840-2 - 8-94408-8-...</p> <p>SILENT-BLOC DO BRAÇO DA SUSPENSÃO SUPERIOR (GASTA 4 UNIDADES)</p> <p>OPEL MONTEREY A (M92): 3.2 (UBS25D, UBS25G) 08.1991/03.1994 130KW 177CV 3165CC - OPEL MONTEREY A (M92): 3.1 TD (UBS69D, UBS69G) 09.1991/07.1998 84KW 114CV 3059CC - OPEL MONTEREY B (M98): 3.5 V6 24V (UBS26D, UBS26G) 07.1998/08.1999 158KW 215CV 3494CC - OPEL MONTEREY B (M98): 3.0 DTI (UBS73D, UBS73G) 07.1998/08.1999 117KW 159CV 2999CC</p> <p>d49.5x45mm c35mm d38mm 1f-d18.4mm</p>
	<p>S1697 NO. 0302411 - 0310400 - 302292 - 97138388</p> <p>SILENT-BLOC DO BRAÇO DA SUSPENSÃO SUPERIOR (GASTA 4 UNIDADES)</p> <p>OPEL MONTEREY A (M92): 3.2 (UBS25D, UBS25G) 08.1991/03.1994 130KW 177CV 3165CC - OPEL MONTEREY A (M92): 3.1 TD (UBS69D, UBS69G) 09.1991/07.1998 84KW 114CV 3059CC - OPEL MONTEREY B (M98): 3.5 V6 24V (UBS26D, UBS26G) 07.1998/08.1999 158KW 215CV 3494CC - OPEL MONTEREY B (M98): 3.0 DTI (UBS73D, UBS73G) 07.1998/08.1999 117KW 159CV 2999CC</p> <p>d49x45mm d38mm c32mm 1f-d18mm</p>		<p>T1224 NO. 0444343 - 444019 - 444021 - 444340 - 444341 - 444343 - 91151918 - 97048318 - 97179437</p> <p>BATENTE DA BARRA ESTABILIZADORA DE TRÁS</p> <p>OPEL MONTEREY A (M92): 3.2 (UBS25D, UBS25G) 08.1991/03.1994 130KW 177CV 3165CC - OPEL MONTEREY A (M92): 3.1 TD (UBS69D, UBS69G) 09.1991/07.1998 84KW 114CV 3059CC - OPEL MONTEREY B (M98): 3.5 V6 24V (UBS26D, UBS26G) 07.1998/08.1999 158KW 215CV 3494CC - OPEL MONTEREY B (M98): 3.0 DTI (UBS73D, UBS73G) 07.1998/08.1999 117KW 159CV 2999CC</p> <p>42x43x42mm 1f-d17mm</p>
	<p>UTR0602 NO. 01326027 - 04709376 - 1326027 - 4709376 - 93194271</p> <p>TAMPÃO RADIADOR</p> <p>OPEL MONTEREY A (M92) 3.2 (UBS25D, UBS25G) (De 1991.08 Até 1994.03) 130KW 177cv 3165cm3 Veículo todo-terreno fechado - OPEL MONTEREY A (M92) 3.1 TD (UBS69D, UBS69G) (De 1991.09 Até 1998.07) 84KW 114cv 3059cm3 Veículo todo-terreno fechado -</p> <p>d53/45x24mm d27x20mm</p>		<p>UTR0800 NO. 1304240 - 1304654 - 1304659 - 1304660 - 1304661 - 1304665 - 1304666 - 1304667 - 1304853 - 90352470 - ...</p> <p>TAMPÃO RESERVATÓRIO LÍQUIDO REFRIGERAÇÃO</p> <p>OPEL MONTEREY A (M92) 3.2 (UBS25_) (06.92 A 07.98) 177cv 3165cc Veículo todo-terreno fechado - OPEL MONTEREY A (M92) 3.1 TD (UBS69_) (09.91 A 07.98) 114cv 3059cc Veículo todo-terreno fechado</p> <p>d62x25mm 1f-d53x14mm</p>
	<p>UTR0820 NO. 90352470 - 90409256 - 90409257 - 9041032690497472 - 90467473</p> <p>TAMPÃO RESERVATÓRIO LÍQUIDO REFRIGERAÇÃO</p> <p>OPEL MONTEREY A (UBS_) 3.2 (UBS25_) (06.92 A 07.98) 177cv 3165cc Veículo todo-terreno fechado - OPEL MONTEREY A (UBS_) 3.1 TD (UBS69_) (09.91 A 07.98) 114cv 3059cc Veículo todo-terreno fechado</p> <p>d62x23mm 1f-d53x12mm</p>		<p>UTR1305 NO. 0650089 - 650089</p> <p>TAMPÃO DO RESERVATÓRIO ÓLEO</p> <p>OPEL MONTEREY A (M92) 3.1 TD (UBS69D, UBS69G) (09.1991 - 07.1998) 84kw 114cv 3059cm3 Veículo todo-terreno fechado OPEL MONTEREY A (M92) 3.2 (UBS25D, UBS25G) (08.1991 - 03.1994) 130kw 177cv 3165cm3 Veículo todo-terreno fechado</p> <p>d61x23mm d32x19mm</p>
	<p>UTR1305 NO. 0650089 - 650089</p> <p>TAMPÃO DO RESERVATÓRIO ÓLEO</p> <p>OPEL MONTEREY B (M98) 3.0 DTI (UBS73D, UBS73G) (07.1998 - 08.1999) 117kw 159cv 2999cm3 Veículo todo-terreno fechado OPEL MONTEREY B (M98) 3.5 V6 24V (UBS26D, UBS26G) (07.1998 - 08.1999) 158kw 215cv 3494cm3 Veículo todo-terreno fechado</p> <p>d61x23mm d32x19mm</p>		<p>W5044 NO. 89445062311</p> <p>POLIE DA CAMBOTA (1+1+1 PISTAS)</p> <p>OPEL MONTEREY 2.1 DIESEL (ORIGEM ISUZU)</p> <p>d145mm d47mm</p>

	<p>A0649 NO. 684260 - 684270</p> <p>APOIO MOTOR (GASTA 2 UNIDADES)</p> <p>OPEL RECORD C (4 CILINDROS) 1966/1972</p> <p>80x73x52mm 1p-d10-18mm</p>		<p>A0654 NO. 0682554 - 682554 - 90222823</p> <p>APOIO CAIXA VELOCIDADES</p> <p>OPEL REKORD E (17_ - 19_ - 11_ - 14_ - 16_) 1.8 (De 11-1982 Até 08-1986) 55kW 75CV 1796cc três volumes OPEL REKORD E (17_ - 19_ - 11_ - 14_ - 16_) 1.8 S (De 11-1982 Até 08-1986) 66kW 90CV 1796cc três volumes OPEL REKORD E Combi (61_ - 66_ - 67_) 1.8 (De 11-1982 Até 08-1986) 55kW 75CV 1796cc Combi OPEL REKORD E Combi (61_ - 66_ - 67_) 1.8 S (De 11-1982 Até 08-1986) 66kW 90CV 1796cc Combi</p> <p>184x35x57mm 2f-d12mm 2p-d8x16mm</p>
	<p>A0654 NO. 0682554 - 682554 - 90222823</p> <p>APOIO CAIXA VELOCIDADES</p> <p>OPEL SENATOR A (29_) 2.0 E (De 03-1983 Até 10-1984) 85kW 115CV 1979cc três volumes OPEL SENATOR A (29_) 2.2 E (De 11-1984 Até 08-1987) 85kW 115CV 2197cc três volumes</p> <p>184x35x57mm 2f-d12mm 2p-d8x16mm</p>		<p>A2088 NO. 0684274 - 684274 - 90235055</p> <p>APOIO MOTOR LADO DIREITO E ESQUERDO (HIDRAULICO)</p> <p>OPEL REKORD E (17_ - 19_ - 11_ - 14_ - 16_) 2.0 D (De 09-1977 Até 10-1982) 43kW 58CV 1998cc três volumes OPEL REKORD E (17_ - 19_ - 11_ - 14_ - 16_) 2.1 D (De 09-1977 Até 07-1978) 44kW 60CV 2068cc três volumes OPEL REKORD E (17_ - 19_ - 11_ - 14_ - 16_) 2.2 D (De 08-1978 Até 08-1983) 48kW 65CV 2260cc três volumes OPEL REKORD E (17_ - 19_ - 11_ - 14_ - 16_) 2.2 D (De 11-1982 Até 08-1986) 52kW 71CV 2260cc...</p> <p>d105x110mm 1p-d10x23 1p-d10x17mm</p>
	<p>A2089 NO. 0684274 - 684274 - 90235055</p> <p>APOIO DO MOTOR LADO DIREITO E ESQUERDO</p> <p>OPEL REKORD E (17_ - 19_ - 11_ - 14_ - 16_) 2.0 D (De 09-1977 Até 10-1982) 43kW 58CV 1998cc três volumes OPEL REKORD E (17_ - 19_ - 11_ - 14_ - 16_) 2.1 D (De 09-1977 Até 07-1978) 44kW 60CV 2068cc três volumes OPEL REKORD E (17_ - 19_ - 11_ - 14_ - 16_) 2.2 D (De 08-1978 Até 08-1983) 48kW 65CV 2260cc três volumes OPEL REKORD E (17_ - 19_ - 11_ - 14_ - 16_) 2.2 D (De 11-1982 Até 08-1986) 52kW 71CV 2260cc...</p> <p>d105x110mm 1p-d10x23mm 1p-d10x17</p>		<p>A2242 NO. 0817744 - 817744 - 90080552</p> <p>APOIO DA BOMBA DO COMBUSTIVEL</p> <p>OPEL MONZA A (22_) 2.0 E (De 1983.03 Até 1984.10) 85kW 115cv 1979cm3 Coupé - OPEL MONZA A (22_) 2.2 E (De 1984.11 Até 1986.08) 85kW 115cv 2197cm3 Coupé - OPEL MONZA A (22_) 2.5 E (De 1981.05 Até 1986.08) 100kW 136cv 2490cm3 Coupé - OPEL MONZA A (22_) 3.0 (De 1978.04 Até 1982.07) 110kW 150cv 2969cm3 Coupé - OPEL MONZA A (22_) 3.0 (De 1978.04 Até 1982.07) 110kW 150cv 2969cm3 Coupé - OPEL MONZA A (22_) 3.0 (De 1982.07 Até 1986.08) 132kW 180cv 2969cm3 Coupé</p>
	<p>A2242 NO. 0817744 - 817744 - 90080552</p> <p>APOIO DA BOMBA DO COMBUSTIVEL</p> <p>OPEL REKORD E (17_ - 19_ , 11_ , 14_ , 16_) 1.8 E (De 1985.05 Até 1986.08) 74kW 100cv 1796cm3 três volumes - OPEL REKORD E (17_ - 19_ , 11_ , 14_ , 16_) 2.0 E (De 1977.09 Até 1984.10) 81kW 110cv 1979cm3 três volumes - OPEL REKORD E (17_ - 19_ , 11_ , 14_ , 16_) 2.2 E (De 1984.11 Até 1986.08) 85kW 115cv 2197cm3 três volumes - OPEL REKORD E Combi (61_ , 66_ , 67_) 1.8 E (De 1985.05 Até 1986.08) 7...</p> <p>19x21mm 2p-d8x14mm</p>		<p>A2242 NO. 0817744 - 817744 - 90080552</p> <p>APOIO DA BOMBA DO COMBUSTIVEL</p> <p>OPEL SENATOR A (29_) 2.0 E (De 1983.03 Até 1984.10) 85kW 115cv 1979cm3 três volumes - OPEL SENATOR A (29_) 2.2 E (De 1984.11 Até 1987.08) 85kW 115cv 2197cm3 três volumes - OPEL SENATOR A (29_) 2.5 (De 1978.05 Até 1980.12) 85kW 115cv 2490cm3 três volumes - OPEL SENATOR A (29_) 2.5 E (De 1984.09 Até 1987.08) 103kW 140cv 2490cm3 três volumes - OPEL SENATOR A (29_) 3.0 (De 1982.07 Até 1986.08) 132kW 180cv 2969cm3 três volumes</p>
	<p>A2461 NO. 682506</p> <p>APOIO DO MOTOR TRÁS CENTRO</p> <p>OPEL REKORD D: 1.7 03.1975/08.1977 44KW 60CV 1698CC</p> <p>122x91x46mm 2f-d8mm 1f-d12mm</p>		<p>A2499 NO. 00684173 - 0682560 - 24417107 - 90235666 - 90289667</p> <p>APOIO DO MOTOR PARTE DA FRENTE DIREITO E ESQUERDO</p> <p>OPEL REKORD E (17_ , 11_ , 14_ , 16_ , 18_ , 19_) 1.8 E (De 05.1985 Até 08.1986) 74kW 100cv 1796cm3 três volumes - OPEL REKORD E (17_ , 11_ , 14_ , 16_ , 18_ , 19_) 2.0 E (De 09.1977 Até 10.1984) 81kW 110cv 1979cm3 três volumes - OPEL REKORD E (17_ , 11_ , 14_ , 16_ , 18_ , 19_) 2.0 S (De 08.1977 Até 08.1986) 74kW 100cv 1979cm3 três volumes - OPEL REKORD E (17_ , 11_ , 14_ , 16_ , 18_ , 19_) 2.2 E (De 11.1984 Até 08...</p> <p>d103x66mm 1p-d10x17mm 1p-d10x25mm</p>
	<p>A2499 NO. 00684173 - 0682560 - 24417107 - 90235666 - 90289667</p> <p>APOIO DO MOTOR PARTE DA FRENTE DIREITO E ESQUERDO</p> <p>OPEL SENATOR A (29_) 2.0 E (De 03.1983 Até 10.1984) 85kW 115cv 1979cm3 três volumes - OPEL SENATOR A (29_) 2.2 E (De 11.1984 Até 08.1987) 85kW 115cv 2197cm3 três volumes -</p> <p>d103x66mm 1p-d10x17mm 1p-d10x25mm</p>		<p>D0052 NO. 0458363 - 0458366 - 0458367 - 458363 - 458366 - 458367 - 90023735 - 90425689 - 90578558</p> <p>CARDAN TRANSMISSÃO</p> <p>OPEL REKORD E (17_ - 19_ , 11_ , 14_ , 16_) 2.2 TD (06.84 A 08.86) 86cv 2260cc três volumes - OPEL REKORD E Combi (61_ , 66_ , 67_) 2.2 TD (06.84 A 08.86) 86cv 2260cc Combi</p> <p>d127X30mm 6f-d12mm</p>
	<p>E0013 NO. 852715 - 852716 - 852720</p> <p>ESTICADOR DE ESCAPE</p> <p>OPEL MONZA (78 A 87)</p> <p>66x56x13mm</p>		<p>E0013 NO. 852715 - 852716 - 852720</p> <p>ESTICADOR DE ESCAPE</p> <p>OPEL REKORD E 1.7 - 1.8 - 1.9 - 2.0 - 2.0S . 2.2E</p> <p>66x56x13mm</p>
	<p>E0048 NO. 852506</p> <p>ESTICADOR DE ESCAPE</p> <p>OPEL SENATOR</p> <p>59x40x28mm 2f-d14mm</p>		<p>F0469-I NO. 3435052 - 414510</p> <p>FOLE DA TRANSMISSÃO LADO DA CAIXA</p> <p>OPEL MONZA A (22_) 2.0 E 03.1983/10.1984 85KW 115CV 1979CC - OPEL MONZA A (22_) 2.0 E 03.1983/10.1984 85KW 115CV 1979CC - OPEL MONZA A (22_) 2.2 E 11.1984/08.1986 85KW 115CV 2197CC - OPEL MONZA A (22_) 2.2 E 11.1984/08.1986 85KW 115CV 2197CC - OPEL MONZA A (22_) 2.5 E 05.1981/08.1986 100KW 136CV 2490CC - OPEL MONZA A (22_) 2.5 E 06.1984/08.1986 103KW 140CV 2490CC - OPEL MONZA A (22_) 2.5 E ...</p> <p>d85x80mm 1f-d61mm 1f-d23mm</p>

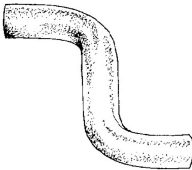
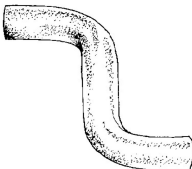
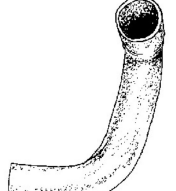
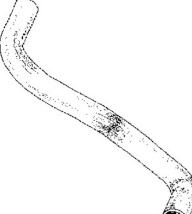
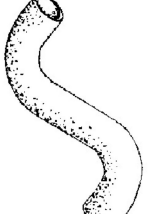
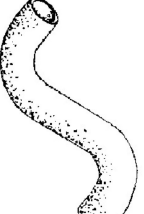
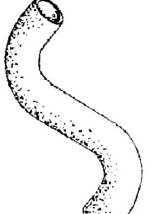
	<p>L3020 NO. 0856700 - 856700 - 9275758</p> <p>CASQUILHO DE ESCAPE</p> <p>OPEL REKORD E</p> <p>d29x12mm d26/di19x8mm 1f-d9mm</p>		<p>L3020 NO. 0856700 - 856700 - 9275758</p> <p>CASQUILHO DE ESCAPE</p> <p>OPEL REKORD D</p> <p>d29x12mm d26/di19x8mm 1f-d9mm</p>
	<p>M6045 NO. 854936 - 90231063</p> <p>JUNTA DE ESCAPE</p> <p>OPEL SENATOR (1987 A 1993)</p> <p>95x92mm 1f-d55mm</p>		<p>N1617 NO. 852705 - 852711</p> <p>ANEL DE ESCAPE</p> <p>OPEL REKORD A 1500 (02-1963 A 12-1965) - REKORD B 1.5 (08-1965 A 08-1966) - REKORD C 1.5 - 1.7 - 1.9 - 2.2 (1966 A 1971) - REKORD D 1.7 - 1.9 - 2.0 - 2 - 0D - 2.1D - REKORD E 1.7 - (09-1977 A 10-1982)</p> <p>d65x13mm 1f-d40mm</p>
	<p>N2001 NO. 852707 - 852712</p> <p>ANEL DE ESCAPE TRÁS</p> <p>OPEL REKORD A 1500 - 1700 (06-1963 A 12-1965) - REKORD B 1.5 - 1.7 - 1.9 (08-1965 A 12-1966) - REKORD C 1.5 - 1.7 - 1.9 - 2.2 (1966 A 1971) - REKORD D 1.7 - 1.7S - 1.9 - 1.9S - 2.0 - 2.0D - 2.1D</p> <p>d70x14mm 1f-d46mm</p>		<p>N2074 NO. 856506</p> <p>ANEL DE ESCAPE</p> <p>OPEL REKORD (A) (1963 A 1965) - REKORD (B) (1965 A 1967) - REKORD (D) (1972 A 1973)</p> <p>d54x10mm 1f-d34mm</p>
	<p>N2335 NO. 175538</p> <p>ANEL ESCAPE</p> <p>OPEL REKORD</p> <p>d65x15mm 1f-d36mm</p>		<p>N2336 NO. 852711</p> <p>ANEL ESCAPE</p> <p>OPEL REKORD D: 2.0 09.1975/08.1977 74KW 100CV 1979CV - OPEL REKORD D Combi: 2.0 S 09.1975/08.1977 74KW 100CV 1979CC</p> <p>d62x14mm 1f-d36mm</p>
	<p>N6371 NO. 08949811 - 852706 - 856507</p> <p>ANEL DE ESCAPE</p> <p>OPEL REKORD E 1.7 - 1.8 - 1.9 - 2.0 - 2.0S - 2.2E (1977 A 1986) - REKORD A 1500 - 1700 (02-1963 A 12-1965) - REKORD B 1.5 - 1.7 - 1.9 (08-1965 A 12-1966) - REKORD C 1.5 - 1.7 - 1.9 - 2.2 (1966 A 1971) - REKORD D 1.7 - 1.9 - 2.0 - 2.0D - 2.1D</p> <p>d100x9mm 1f-d82mm</p>		<p>R0615-M NO. 1336791 - 1336839 - 1336848 - M-220073</p> <p>TUBO SUPERIOR DO RADIADOR</p> <p>OPEL REKORD B 1.5 08.1965/08.1966 44KW 60CV 1492CC 15 NB 0039378 0039381 - OPEL REKORD B 1.7 08.1965/12.1966 55KW 75CV 1698CC 17 S 0039379 0039382 - OPEL REKORD B 1.9 08.1965/12.1966 66KW 90CV 1897CC 19 S 0039380 0039383 - OPEL REKORD B Combi 1.5 08.1965/08.1966 44KW 60CV 1492CC 15 NB 0039394 - OPEL REKORD B Combi 1.7 08.1965/12.1966 55KW 75CV 1698CC 17 N 0039395 - OPEL REKORD B Coupé 1.7 08.1966...</p> <p>B290-d38/34mm 105-175-90mm</p>
	<p>R0615-M NO. 1336791 - 1336839 - 1336848 - M-220073</p> <p>TUBO SUPERIOR DO RADIADOR</p> <p>OPEL REKORD D 1.7 01.1972/02.1975 49KW 66CV 1698CC 17 N 0039213 0039210 - OPEL REKORD D 1.7 03.1975/08.1977 44KW 60CV 1698CC 17 N 0039249 0039252 - OPEL REKORD D 1.9 03.1975/08.1977 55KW 75CV 1897CC 19 N 0039250 0039253 - OPEL REKORD D 1.9 03.1975/08.1977 66KW 90CV 1897CC 19 SH 0039251 0039254 - OPEL REKORD D 2.0 D 08.1974/08.1977 40KW 54CV 1998CC 20 D 0039257 - OPEL REKORD D 2.1 D 09.1972/08.19...</p> <p>B290-d38/34mm 105-175-90mm</p>		<p>R0616M NO. 1336744 - M-220220</p> <p>TUBO INFERIOR DO RADIADOR</p> <p>OPEL REKORD B 1.5 08.1965/08.1966 44KW 60CV 1492CC 15 NB 0039378 0039381</p> <p>B250-d34/46mm 100-195-115mm</p>
	<p>R0709 NO. 1336180 - 1336235 - 1336437 - 1336480 - 90088720 - 902205539 - 90322663</p> <p>TUBO SUPERIOR DO RADIADOR</p> <p>OPEL REKORD D 2.0 D 08.1974/08.1977 40KW 54CV 1998CC 20 D 0039257 - OPEL REKORD D 2.1 D 09.1972/08.1977 44KW 60CV 2068CC 21 D 0039228 - OPEL REKORD D Combi 2.1 D 09.1972/08.1977 44KW 60CV 2068CC 21 D 0039243</p> <p>B480-d36/34mm 145-200-170-90mm</p>		<p>R220073 NO. 1336782 - 1336791 - 1336839 - 1336844 - 90121917</p> <p>TUBO DE RADIADOR SUPERIOR</p> <p>OPEL REKORD B: 1.5 08.1965/08.1966 44KW 60CV 1492CC - OPEL REKORD B: 1.7 08.1965/12.1966 55KW 75CV 1698CC - OPEL REKORD B: 1.9 08.1965/12.1966 66KW 90CV 1897CC - OPEL REKORD B Combi: 1.5 08.1965/08.1966 44KW 60CV 1492CC - OPEL REKORD B Combi: 1.7 08.1965/12.1966 55KW 75CV 1698CC - OPEL REKORD B Coupé: 1.7 08.1965/12.1966 55KW 75CV 1698CC - OPEL REKORD B Coupé: 1.9 08.1965/02.1967 66KW 90CV 1897CC</p> <p>B340-d34/38mm 115-160-140mm</p>
	<p>R220073 NO. 1336782 - 1336791 - 1336839 - 1336844 - 90121917</p> <p>TUBO DE RADIADOR SUPERIOR</p> <p>OPEL REKORD A: 1700 (R3) 02.1963/12.1965 44KW 60CV 1668CC - OPEL REKORD A: 1700 (R3) 02.1963/12.1965 49KW 67CV 1668CC - OPEL REKORD A: 1.7 03.1963/08.1965 44KW 60CV 1698CC - OPEL REKORD A: 1.7 04.1964/08.1965 55KW 75CV 1698CC - OPEL REKORD A Coupé: 1700 01.1963/12.1965 49KW 67CV 1668CC</p> <p>B340-d34/38mm 115-160-140mm</p>		<p>R220073 NO. 1336782 - 1336791 - 1336839 - 1336844 - 90121917</p> <p>TUBO DE RADIADOR SUPERIOR</p> <p>OPEL REKORD D: 1.7 03.1975/08.1977 44KW 60CV 1698CC - OPEL REKORD D: 1.7 01.1972/02.1975 49KW 66CV 1698CC - OPEL REKORD D: 1.9 03.1975/08.1977 55KW 75CV 1698CC - OPEL REKORD D: 1.9 03.1975/08.1977 66KW 90CV 1897CC - OPEL REKORD D: 2.0 D 08.1974/08.1977 40KW 54CV 1998CC - OPEL REKORD D: 2.1 D 09.1972/08.1977 44KW 60CV 2068CC - OPEL REKORD D Combi: 1.7 03.1975/08.1977 44KW 60CV 1698CC - OPEL REKORD ...</p> <p>B340-d34/38mm 115-160-140mm</p>













	<p>R220073 NO. 1336782 - 1336791 - 1336839 - 1336844 - 90121917</p> <p>TUBO DE RADIADOR SUPERIOR</p> <p>OPEL REKORD C Coupé: 1.9 08.1966/12.1971 66KW 90CV 1897CC</p> <p>B340-d34/38mm 115-160-140mm</p>		<p>R220220 NO. 1336744</p> <p>TUBO INFERIRO RADIADOR</p> <p>OPEL REKORD B 1.5 08.1965/08.1966 44KW 60CV 1492CC 15 NB 0039378 0039381</p> <p>B260-d32/46mm 100-180-110mm</p>
	<p>R220230 NO. 1336784</p> <p>TUBO INFERIOR DO RADIADOR</p> <p>OPEL REKORD D 1.9 03.1975/08.1977 55KW 75CV 1897CC 19 N 0039250 0039253 - OPEL REKORD D 1.9 03.1975/08.1977 66KW 90CV 1897CC 19 SH 0039251 0039254 - OPEL REKORD D Combi 1.9 03.1975/08.1977 55KW 75CV 1897CC 19 N 0039259 0039262 - OPEL REKORD D Combi 1.9 03.1975/08.1977 66KW 90CV 1897CC 19 SH 0039263 0039260 - OPEL REKORD D Coupé 1.9 03.1975/08.1977 55KW 75CV 1897CC 19 N 0039255 - OPEL REKORD D Coup...</p> <p>B295-33/40mm 54x48x195x113mm</p>		<p>R220231 NO. 1818196</p> <p>TUBO DO AQUECIMENTO</p> <p>OPEL REKORD D 1.7 03.1975/08.1977 44KW 60CV 1698CC 17 N 0039249, 0039252</p> <p>B390-d15/15mm 45-45-295-75mm</p>
	<p>R220235 NO. 1336238 - 90106060</p> <p>TUBO DE LIGAÇÃO TERMOSTATO Á BOMBA DE ÁGUA</p> <p>OPEL REKORD D 2.0 D 08.1974/08.1977 40KW 54CV 1998CC 20 D 0039257 - OPEL REKORD D 2.1 D 09.1972/08.1977 44KW 60CV 2068CC 21 D 0039228 - OPEL REKORD D Combi 2.1 D 09.1972/08.1977 44KW 60CV 2068CC 21 D 0039243 - OPEL REKORD E Combi (61_, 66_, 67_) 2.3 D 11.1982/08.1986 52KW 71CV 2260CC 23 D 0039626</p> <p>B340-d30/38mm 51x65x34mm</p>		<p>R220237 NO. 1336212 - 1336864</p> <p>TUBO DE RADIADOR INFERIOR</p> <p>OPEL REKORD E (17_, 11_, 14_, 16_, 18_, 19_) 1.7 09.1977/10.1982 44KW 60CV 1698CC 17 N 0039532 - OPEL REKORD E (17_, 11_, 14_, 16_, 18_, 19_) 1.8 11.1982/08.1986 55KW 75CV 1796CC 18 N 0039617 - OPEL REKORD E (17_, 11_, 14_, 16_, 18_, 19_) 1.9 09.1977/10.1982 55KW 75CV 1897CC 19 N 0039533 - OPEL REKORD E (17_, 11_, 14_, 16_, 18_, 19_) 2.0 09.1977/10.1982 66KW 90CV 1979CC 20 N 0039534 - OPEL REKORD ...</p>
	<p>R220254 NO. 1336749 - 1336783 - 90424150</p> <p>TUBO INFERIOR SAÍDA ÁGUA DO RADIADOR</p> <p>OPEL REKORD A: 1700 (R3) 02.1963/12.1965 44KW 60CV 1668CC - OPEL REKORD A: 1700 (R3) 02.1963/12.1965 49KW 67CV 1668CC - OPEL REKORD A: 1.7 03.1963/08.1965 44KW 60CV 1698CC - OPEL REKORD A: 1.7 04.1964/08.1965 55KW 75CV 1698CC - OPEL REKORD A Coupé: 1700 01.1963/12.1965 49KW 67CV 1668CC</p> <p>B250-d45/35mm 75-175-85mm</p>		<p>R220254 NO. 1336749 - 1336783 - 90424150</p> <p>TUBO INFERIOR SAÍDA ÁGUA DO RADIADOR</p> <p>OPEL REKORD C: 1.5 08.1966/12.1971 43KW 58CV 1492CC - OPEL REKORD C: 1.5 02.1968/12.1971 44KW 60CV 1492CC - OPEL REKORD C: 1.7 08.1966/12.1971 44KW 60CV 1698CC - OPEL REKORD C: 1.7 02.1968/12.1971 49KW 66CV 1698CC - OPEL REKORD C: 1.7 S 08.1966/12.1971 55KW 75CV 1698CC - OPEL REKORD C: 1.9 08.1966/12.1971 66KW 90CV 1897CC - OPEL REKORD C: 1.9 Sprint 08.1967/12.1971 78KW 106CV 1897CC - OPEL REKORD ...</p> <p>B250-d45/35mm 75-175-85mm</p>
	<p>R220254 NO. 1336749 - 1336783 - 90424150</p> <p>TUBO INFERIOR SAÍDA ÁGUA DO RADIADOR</p> <p>OPEL REKORD D: 2.0 D 08.1974/08.1977 40KW 54CV 1998CC - OPEL REKORD D: 2.1 D 09.1972/08.1977 44KW 60CV 2068CC - OPEL REKORD D Combi: 2.0 D 08.1974/08.1977 40KW 54CV 1998CC - OPEL REKORD D Combi: 2.1 D 09.1972/08.1977 44KW 60CV 2068CC</p> <p>B250-d45/35mm 75-175-85mm</p>		<p>R220254 NO. 1336749 - 1336783 - 90424150</p> <p>TUBO INFERIOR SAÍDA ÁGUA DO RADIADOR</p> <p>OPEL REKORD B: 1.7 08.1965/12.1966 55KW 75CV 1698CC - OPEL REKORD B: 1.9 09.1965/08.1966 55KW 75CV 1897CC - OPEL REKORD B: 1.9 08.1965/12.1966 66KW 90CV 1897CC - OPEL REKORD B Combi: 1.7 08.1965/12.1966 55KW 75CV 1698CC - OPEL REKORD B Coupé: 1.7 08.1965/12.1966 55KW 75CV 1698CC - OPEL REKORD B Coupé: 1.9 08.1965/02.1967 66KW 90CV 1897CC</p> <p>B250-d45/35mm 75-175-85mm</p>
	<p>S1029 NO.</p> <p>SILENT-BLOC DE VAUS DE SUSPENSÃO</p> <p>OPEL REKORD</p> <p>d44x27mm d35 1f-d15mm</p>		<p>S2103 NO. 0402935 - 402935 - 90250986</p> <p>SILENT-BLOC DO EIXO SUSPENSÃO TRÁS</p> <p>OPEL SENATOR A (29_) 2.0 E 03.1983/10.1984 85KW 115CV 1979CC H 20 E 0039623 - OPEL SENATOR A (29_) 2.2 E 11.1984/08.1987 85KW 115CV 2197CC 22 E 0039631 - OPEL SENATOR A (29_) 2.2 TD 11.1984/08.1987 63KW 86CV 2260CC 23 TD 0039633 - OPEL SENATOR A (29_) 2.5 05.1978/12.1980 85KW 115CV 2490CC 25 S 0039551 - OPEL SENATOR A (29_) 2.5 E 01.1983/08.1984 100KW 136CV 2490CC H 25 E 0039595 - OPEL SENATOR A (...)</p> <p>d121x80mm c46mm d96mm 1f-d18mm</p>
	<p>T0001-E NO. 856516 - 856521</p> <p>BATENTE DE ESCAPE</p> <p>OPEL REKORD D 2.0 09.1975/08.1977 74KW 100CV 1979CC 20 S 0039297 0039296 - OPEL REKORD D Combi 2.0 S 09.1975/08.1977 74KW 100CV 1979CC 20 S 0039298 0039299 - OPEL REKORD E (17_, 11_, 14_, 16_, 18_, 19_) 1.7 09.1977/10.1982 44KW 60CV 1698CC 17 N 0039532 - OPEL REKORD E (17_, 11_, 14_, 16_, 18_, 19_) 1.8 11.1982/08.1986 55KW 75CV 1796CC 18 N 0039617 - OPEL REKORD E (17_, 11_, 14_, 16_, 18_, 19_) 1.8...</p>		<p>UTR0800 NO. 1304240 - 1304654 - 1304659 - 1304660 - 1304661 - 1304665 - 1304666 - 1304667 - 1304853 - 90352470 - ...</p> <p>TAMPÃO RESERVATÓRIO LIQUIDO REFRIGERAÇÃO</p> <p>OPEL SENATOR B (V88) 2.5 i 09.90 - 09.93 103 140 2490 três volumes OPEL SENATOR B (V88) 2.6 i 09.90 - 09.93 110 150 2594 três volumes OPEL SENATOR B (V88) 3.0 09.87 - 09.93 115 156 2969 três volumes OPEL SENATOR B (V88) 3.0 01.88 - 09.90 130 177 2969 três volumes OPEL SENATOR B (V88) 3.0 i Cat 01.88 - 09.93 130 177 2969 três volumes OPEL SENATOR B (V88) 3.0 24V 09.89 - 09.93 150 204 2969 três volu...</p> <p>d62x25mm 1f-d53x14mm</p>
	<p>UTR0811 NO. 1304659 - 1304660 - 1304661 - 1304665 - 1304666 - 1304853 - 4395513 - 90352470 - 90409256 - 90409257...</p> <p>TAMPÃO RESERVATÓRIO LIQUIDO REFRIGERAÇÃO</p> <p>OPEL SENATOR B 2.5 i (09.90 A 09.93) 140cv 2490cc três volumes - OPEL SENATOR B 2.6 i (09.90 A 09.93) 150cv 2594cc três volumes - OPEL SENATOR B 3.0 (01.88 A 09.90) 177cv 2969cc três volumes - OPEL SENATOR B 3.0 i (01.88 A 09.93) 177cv 2969cc três volumes - OPEL SENATOR B 3.0 24V (09.89 A 09.93) 204cv 2969cc três volumes</p> <p>60x25mm 1f-d52x14mm</p>		<p>UTR0820 NO. 90352470 - 90409256 - 90409257 - 9041032690497472 - 90467473</p> <p>TAMPÃO RESERVATÓRIO LIQUIDO REFRIGERAÇÃO</p> <p>OPEL MONZA A (22_) 2.0 E (03.83 A 10.84) 115cv 1979cc Coupé - OPEL MONZA A (22_) 2.2 E (11.84 A 08.86) 115cv 2197cc Coupé - OPEL MONZA A (22_) 2.5 E (05.81 A 08.86) 136cv 2490cc Coupé - OPEL MONZA A (22_) 2.5 E (06.84 A 08.86) 140cv 2490cc Coupé - OPEL MONZA A (22_) 3.0 (04.78 A 07.82) 150cv 2969cc Coupé - OPEL MONZA A (22_) 3.0 GSE (02.78 A 08.86) 180cv 2969cc Coupé - OPEL MONZA A (22_...</p> <p>d62x23mm 1f-d53x12mm</p>

	<p>UTR0820 NO. 90352470 - 90409256 - 90409257 - 9041032690497472 - 90467473</p> <p>TAMPÃO RESERVATÓRIO LIQUIDO REFRIGERAÇÃO</p> <p>OPEL REKORD E (17_-19_, 11_, 14_, 16_) 2.2 E (11.84 A 08.86) 115cv 2197cc três volumes - OPEL REKORD E Combi (61_, 66_, 67_) 2.2 E (11.84 A 08.86) 115cv 2197cc Combi</p> <p>d62x23mm 1f-d53x12mm</p>		<p>UTR0820 NO. 90352470 - 90409256 - 90409257 - 9041032690497472 - 90467473</p> <p>TAMPÃO RESERVATÓRIO LIQUIDO REFRIGERAÇÃO</p> <p>OPEL SENATOR A (29_) 3.0 (09.85 A 08.87) 156cv 2969cc três volumes - OPEL SENATOR B (29_) 2.5 i (09.90 A 09.93) 140cv 2490cc três volumes - OPEL SENATOR B (29_) 2.6 i (09.90 A 09.93) 150cv 2594cc três volumes - OPEL SENATOR B (29_) 3.0 (09.87 A 09.93) 156cv 2969cc três volumes - OPEL SENATOR B (29_) 3.0 (01.88 A 09.90) 177cv 2969cc três volumes 11 / 13 - OPEL SENATOR B (29_) 3.0 i Cat (01...)</p> <p>d62x23mm 1f-d53x12mm</p>
	<p>UTR0859 NO. 1650630 - 94539597 - 96293957 - 96312510 - 96351578 - 96420303 - 96536649</p> <p>TAMPÃO RESERVATÓRIO LIQUIDO REFRIGERAÇÃO</p> <p>OPEL MONZA A (2 2_) 2.0 E (03.83 A 10.84) 115cv 1979cc Coupé - OPEL MONZA A (2 2_) 2.2 E (11.84 A 08.86) 115cv 2197cc Coupé - OPEL MONZA A (2 2_) 2.5 E (05.81 A 08.86) 136cv 2490cc Coupé - OPEL MONZA A (2 2_) 2.5 E (06.84 A 08.86) 140cv 2490cc Coupé</p> <p>d63x23mm 1f-d53x11mm</p>		<p>UTR0859 NO. 1650630 - 94539597 - 96293957 - 96312510 - 96351578 - 96420303 - 96536649</p> <p>TAMPÃO RESERVATÓRIO LIQUIDO REFRIGERAÇÃO</p> <p>OPEL SENATOR A (29_) 2.5 E (01.83 A 08.84) 136cv 2490cc três volumes - OPEL SENATOR A (29_) 2.5 E (09.84 A 08.87) 140cv 2490cc três volumes</p> <p>d63x23mm 1f-d53x11mm</p>
	<p>UTR0859 NO. 1650630 - 94539597 - 96293957 - 96312510 - 96351578 - 96420303 - 96536649</p> <p>TAMPÃO RESERVATÓRIO LIQUIDO REFRIGERAÇÃO</p> <p>OPEL SENATOR B (V88) 2.5 i (09.90 A 09.93) 140cv 2490cc três volumes - OPEL SENATOR B (V88) 2.6 i (09.90 A 09.93) 150cv 2594cc três volumes - OPEL SENATOR B (V88) 3.0 (09.87 A 09.93) 156cv 2969cc três volumes - OPEL SENATOR B (V88) 3.0 (01.88 A 09.90) 177cv 2969cc três volumes - OPEL SENATOR B (V88) 3.0 i Cat (01.88 A 09.93) 177cv 2969cc três volumes - OPEL SENATOR B (V88) 3.0 24V (09.89...)</p> <p>d63x23mm 1f-d53x11mm</p>		<p>UTV83011 NO. 0652475 - 09275631 - 652475 - 652491 - 90409376 - 9275631 - N9028901</p> <p>TAMPÃO VEDAÇÃO BUJÃO</p> <p>OPEL REKORD E (17_-19_ - 11_ - 14_ - 16_) 1.7 (De 09-1977 Até 10-1982) 44kW 60CV 1698cc três volumes OPEL REKORD E (17_-19_ - 11_ - 14_ - 16_) 1.8 (De 11-1982 Até 08-1986) 55kW 75CV 1796cc três volumes OPEL REKORD E (17_-19_ - 11_ - 14_ - 16_) 1.8 S (De 11-1982 Até 08-1986) 66kW 90CV 1796cc três volumes OPEL REKORD E (17_-19_ - 11_ - 14_ - 16_) 1.8 E (De 05-1985 Até 08-1986) 74kW 100CV 1796cc t...</p> <p>19x18mm c12mm d14mm</p>
	<p>Y3212 NO. 1008501 - 1008504 - 4709077</p> <p>PARAFUSO PERNO RODA CHAVE 17 M12X1,50X48MM (BASE CONICA PARA JANTES AÇO E LIGA LEVE)</p> <p>OPEL SENATOR A (29_) 2.0 E (03.1983 - 10.1984) 85kw 115cv 1979cm3 três volumes OPEL SENATOR A (29_) 2.2 E (11.1984 - 08.1987) 85kw 115cv 2197cm3 três volumes OPEL SENATOR A (29_) 2.2 TD (11.1984 - 08.1987) 63kw 86cv 2260cm3 três volumes OPEL SENATOR A (29_) 2.5 (05.1978 - 12.1980) 85kw 115cv 2490cm3 três volumes OPEL SENATOR A (29_) 2.5 E (09.1984 - 08.1987) 103kw 140cv 2490cm3 três volumes OPEL S...</p> <p>C48mm (Ch-17mm) M12x1,50x22mm</p>		<p>Z80563 NO. 174824</p> <p>Mola de friso</p> <p>OPEL RECKORD (E)</p> <p>40x24x5.5mm</p>
	<p>Z80661 NO. 1218601 - 90181010</p> <p>MOLA SUPORTE FAROL PRINCIPAL (GASTA 2 UNIDADES)</p> <p>OPEL SENATOR B (V88): 2.5 i (P19) 09.1990/09.1993 103KW 140CV 2490CC - OPEL SENATOR B (V88): 2.6 i (P19) 09.1990/09.1993 110KW 150CV 2594CC - OPEL SENATOR B (V88): 3.0 (P19) 09.1987/09.1993 115KW 156CV 2969CC - OPEL SENATOR B (V88): 3.0 (P19) 01.1988/09.1990 130KW 177KW 2969CC - OPEL SENATOR B (V88): 3.0 i Cat (P19) 01.1988/09.1993 130KW 177CV 2969CC - OPEL SENATOR B (V88): 3.0 24V (P19) 09.1989/0...</p> <p>27.5x22x20mm</p>		

OPEL MOVANO

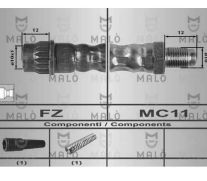
	<p>A2219 NO. 04403351 - 09111351 - 4403351 - 9111351</p> <p>APOIO DO MOTOR LADO DIREITO</p> <p>OPEL MOVANO Combi (X70) 2.2 DTI (JD) (De 2000.09 -) 66kW 90cv 2188cm3 Autocarro - OPEL MOVANO Combi (X70) 2.5 DTI (JD) (De 2001.10 -) 84kW 115cv 2463cm3 Autocarro - OPEL MOVANO Combi (X70) 2.5 CDTI (JD) (De 2007.09 -) 74kW 101cv 2464cm3 Autocarro - OPEL MOVANO Combi (X70) 2.5 CDTI (JD) (De 2006.08 -) 88kW 120cv 2464cm3 Autocarro - OPEL MOVANO Combi (X70) 2.5 CDTI (JD) (De 2006.08 -) 88kW 120cv 2464cm3 Autocarro - OPEL MOVANO Combi (X70) 2.5 CDTI (JD) (De 2006.08 -) 88kW 120cv 2464cm3 Autocarro</p> <p>085x107mm 045x107mm 2P-105x45mm 1p-d12x68mm</p>		<p>A2255 NO. 4500183</p> <p>APOIO DO MOTOR PARTE FRENTE ESQUERDO</p> <p>OPEL MOVANO Camião de plataforma/chassis (X70) 2.5 CDTI (ED, HD, UD0, UD4) (De 2006.08 -) 88kW 120cv 2464cm3 Camião de plataforma/chassis - OPEL MOVANO Camião de plataforma/chassis (X70) 2.5 CDTI (ED, HD, UD0, UD4) (De 2006.08 -) 107kW 146cv 2464cm3 Camião de plataforma/chassis - OPEL MOVANO Camião de plataforma/chassis (X70) 2.5 D (ED, HD, UD0, UD4) (De 1998.07 Até 2000.09) 59kW 80cv...</p> <p>150x96x62mm 1p-d14x62mm 2f-d12mm</p>
	<p>A2437 NO. 2f-d14mm 1f-d12mm 1f-13x15mm 1f-12x12mm</p> <p>APOIO DO MOTOR LADO DIREITO</p> <p>OPEL MOVANO B Autocarro (X62): 2.3 CDTI FWD (JV) 12.2010/>>> 74kW 101CV 2298CC - OPEL MOVANO B Autocarro (X62): 2.3 CDTI FWD (JV) 05.2014/>>> 81kW 110CV 2298CC - OPEL MOVANO B Autocarro (X62): 2.3 CDTI FWD (JV) 12.2010/>>> 92kW 125CV 2298CC - OPEL MOVANO B Autocarro (X62): 2.3 CDTI FWD (JV) 12.2010/>>> 107kW 146CV 2298CC - OPEL MOVANO B Autocarro (X62): 2.3 CDTI FWD (JV) 01.2013/>>> 110kW 150CV 22...</p> <p>201x137x134mm 2f-d14mm 1f-d12mm 1f-13x15mm 1f-12x12mm</p>		<p>A2532 NO. 93168920</p> <p>APOIO DA TRANSMISSÃO</p> <p>OPEL MOVANO B Caixa (X62) 2.3 CDTI RWD (FV) (De 05.2010 -) 74kW 101cv 2298cm3 Caixa - OPEL MOVANO B Caixa (X62) 2.3 CDTI RWD (FV) (De 05.2010 -) 92kW 125cv 2298cm3 Caixa - OPEL MOVANO B Caixa (X62) 2.3 CDTI RWD (FV) (De 05.2010 -) 107kW 146cv 2298cm3 Caixa - OPEL MOVANO B Caixa (X62) 2.3 CDTI RWD (FV) (De 05.2014 -) 100kW 136cv 2298cm3 Caixa - OPEL MOVANO B Caixa (X62) 2.3 CDTI RWD (FV) (De 01.201...</p> <p>246x59x122mm 1f-d45mm 2f16x20mm</p>

	<p>BE22 NO. 4401363 - 4501620 - 860151</p> <p>ABRACADEIRA ESCAPE</p> <p>OPEL MOVANO Autocarro (X70): 1.9 DTI (JD) 09.2000/10.2001 59KW 80CV 1870CC - OPEL MOVANO Autocarro (X70): 1.9 DTI (JD) 10.2001/>>> 60KW 82CV 1870CC - OPEL MOVANO Autocarro (X70): 2.2 DTI (JD) 09.2000/>>> 66KW 90CV 2188CC - OPEL MOVANO Autocarro (X70): 2.5 DTI (JD) 10.2001/>>> 84KW 115CV 2463CC - OPEL MOVANO Autocarro (X70): 2.5 CDTI (JD) 09.2007/>>> 74KW 101CV 2464CC - OPEL MOVANO Autocarro (X70):...</p> <p>96x100x18mm 1p-d10-75mm</p>		<p>D0078 NO. 000 411 06 00 - 000 411 07 00 - 209 410 02 15 - 215 410 00 15 - 221 410 04 15 - 221 411 01 15 - 240 ...</p> <p>CARDAN DA TRANSMISSÃO</p> <p>OPEL MOVANO B Autocarro (X62): 2.3 CDTI FWD (JV) 12.2010/>>> 74KW 101CV 2298CC - OPEL MOVANO B Autocarro (X62): 2.3 CDTI FWD (JV) 05.2014/>>> 81KW 110CV 2298CC - OPEL MOVANO B Autocarro (X62): 2.3 CDTI FWD (JV) 12.2010/>>> 92KW 125CV 2298CC - OPEL MOVANO B Autocarro (X62): 2.3 CDTI FWD (JV) 05.2014/>>> 100KW 136CV 2298CC - OPEL MOVANO B Autocarro (X62): 2.3 CDTI FWD (JV) 12.2010/>>> 107KW 146CV 22... ..</p> <p>d154x36mm 1f-d69mm 8f-d12mm</p>
	<p>E0037 NO. 009161012 - 09161012 - 4500712 - 9161012</p> <p>ESTICADOR SUPORTE DE ESCAPE</p> <p>OPEL MOVANO A Autocarro (X70) 2.2 DTI (JD) desde 09.2000 66KW 90CV 2188CC G9T 720 G9T 750 G9T 722 3041303 3041309 - OPEL MOVANO A Autocarro (X70) 2.8 DTI (JD) 07.1998/10.2001 84KW 114CV 2799CC S9W 702 S9W 700 3041300 3041306 - OPEL MOVANO A Caixa (X70) 2.2 DTI (FD) desde 09.2000 66KW 90CV 2188CC G9T 750 G9T 720 G9T 722 3041511 - OPEL MOVANO A Camião de plataforma/chassis (X70) 2.2 DTI (ED, HD, UD0... ..</p> <p>50x50x28mm</p>		<p>E0248-M NO. 4402612 - 09110612 - 9110612</p> <p>ESTICADOR SUPORTE APOIO MOTOR TRAS</p> <p>OPEL MOVANO A Autocarro (X70) 1.9 DTI (JD) 09.2000/10.2001 59KW 80CV 1870CC F9Q 770 3041302 3041308 - OPEL MOVANO A Autocarro (X70) 1.9 DTI (JD) desde 10.2001 60KW 82CV 1870CC F9Q 772 F9Q 774 3041305 3041311 - OPEL MOVANO A Autocarro (X70) 2.2 DTI (JD) desde 09.2000 66KW 90CV 2188CC G9T 720 G9T 750 G9T 722 3041303 3041309 - OPEL MOVANO A Autocarro (X70) 2.5 CDTI (JD) desde 08.2006 88KW 120CV 2464C... ..</p> <p>150x80x94mm 2f-d12mm</p>
	<p>E0248-M NO. 4402612</p> <p>ESTICADOR SUPORTE APOIO MOTOR TRAS</p> <p>VAUXHALL MOVANO Mk I (A) Chassis/Cab (X70) 2.2 DTI (UD0) 09.2000/05.2010 66KW 90CV 2188CC G9T 750 G9T 722 3041303 3041309 - VAUXHALL MOVANO Mk I (A) Chassis/Cab (X70) 2.5 DTI (ED, UD0) 01.2001/12.2006 84KW 115CV 2463CC G9U 754 G9U 724 G9U 750 G9U 720 - VAUXHALL MOVANO Mk I (A) Van (X70) 2.5 DTI (FD) 10.2001/05.2010 84KW 115CV 2463CC G9U 750 G9U 724 G9U 754 G9U 720</p> <p>150x80x94mm 2f-d12mm</p>		<p>E23423-V NO. 3292200QAE</p> <p>ESTICADOR MANETE CAIXA DE VELOCIDADES</p> <p>OPEL MOVANO A Autocarro (X70) 1.9 DTI (JD) (De 09.2000 Até 10.2001) 59KW 80cv 1870cm3 Autocarro - OPEL MOVANO A Autocarro (X70) 1.9 DTI (JD) (De 10.2001 -) 60KW 82cv 1870cm3 Autocarro - OPEL MOVANO A Autocarro (X70) 2.2 DTI (JD) (De 09.2000 -) 66KW 90cv 2188cm3 Autocarro - OPEL MOVANO A Autocarro (X70) 2.5 CDTI (JD) (De 09.2007 -) 74KW 101cv 2464cm3 Autocarro - OPEL MOVANO A Autocarro (X70) 2.5 CD... ..</p> <p>158x68x18mm 1f-d15mm 1p-d15x71mm</p>
	<p>F1701K3I NO. 4501297</p> <p>FOLE DA TRANSMISSÃO JUNTO À CAIXA</p> <p>OPEL MOVANO 1.9 DTi - 2.2 DTi - 2.5 DTi (APÓS 1998)</p> <p>d85x200mm 1f-d75mm 1f-d25mm</p>		<p>F1817-I NO.</p> <p>FOLE TRANSMISSÃO JUNTO CAIXA (GASTA 2 UNIDADES)</p> <p>OPEL MOVANO 2.5 - 2.8 DTi (1998 A 2001)</p> <p>d98x119mm 1f-d81mm 1f-d26mm</p>
	<p>F1911-I NO. 4501260</p> <p>FOLE DIREÇÃO DIREITO ESQUERDO</p> <p>OPEL MOVANO Combi (X70) 2.5 D (De 07-1998 Até 09-2000) 59kW 80CV 2499cc Autocarro OPEL MOVANO Caixa (F9) 1.9 DTi (De 09-2000 Até 10-2001) 59kW 80CV 1870cc Caixa OPEL MOVANO Caixa (F9) 1.9 DTi (De 10-2001 Até ...) 60kW 82CV 1870cc Caixa OPEL MOVANO Caixa (F9) 2.8 DTi (De 01-1999 Até 10-2001) 84kW 114CV 2799cc Caixa OPEL MOVANO Camião de plataforma/chassis (X70) 2.5 D (De 07-1998 Até 09-2000... ..</p> <p>d64x175mm 1f-d10mm 1f-d43mm</p>		<p>KF2539-T NO.</p> <p>KIT DE FOLE DO CARDAN JUNTO À RODA</p> <p>OPEL MOVANO 2.5D - 2.8 DTi (APÓS 1998)</p> <p>d110x150mm 1f-d98mm 1f-d30mm</p>
	<p>KF2590 NO.</p> <p>KIT DE FOLE DO CARDAN JUNTO À RODA</p> <p>OPEL MOVANO 2.5D - 2.8 DTi (APÓS 1998)</p> <p>d105x150mm 1f-d86mm 1f-d30mm</p>		<p>KF3395-T NO. 4403476</p> <p>KIT DE FOLE DO CARDAN JUNTO À RODA</p> <p>OPEL MOVANO 1.9 DTi - 2.2 DTi - 2.5 DTi (APÓS 1998)</p> <p>d120x150mm 1f-d99mm 1f-d30mm</p>
	<p>KM0436 NO. 04419516 - 4419516 - 93197613</p> <p>KIT BRINCOS DE MOLAS TRÁS PARTE DE TRAS (GASTA 2 UNIDADES)</p> <p>OPEL MOVANO B Autocarro (X62) 2.3 CDTI FWD (JV) (De 12.2010 -) 74kW 101cv 2298cm3 Autocarro - OPEL MOVANO B Autocarro (X62) 2.3 CDTI FWD (JV) (De 05.2014 -) 81kW 110cv 2298cm3 Autocarro - OPEL MOVANO B Autocarro (X62) 2.3 CDTI FWD (JV) (De 12.2010 -) 92kW 125cv 2298cm3 Autocarro - OPEL MOVANO B Autocarro (X62) 2.3 CDTI FWD (JV) (De 05.2014 -) 100kW 136cv 2298cm3 Autocarro - OPEL MOVANO B Autocarro... ..</p> <p>143x99x50mm 2f-d14mm 2f-d15mm</p>		<p>KS0805 NO. 4404592 - 4404593 - 4500102 - 9112593</p> <p>KIT SILENT-BLOCOS JOGO REPARAÇÃO MOLAS TRÁS (GASTA 2 UNIDADES)</p> <p>OPEL MOVANO Autocarro (X70): 1.9 DTI (JD) 09.2000/10.2001 59KW 80CV 1870CC - OPEL MOVANO Autocarro (X70): 1.9 DTI (JD) 10.2001/>>> 60KW 82CV 1870CC - OPEL MOVANO Autocarro (X70): 2.2 DTI (JD) 09.2000/>>> 66KW 90CV 2188CC - OPEL MOVANO Autocarro (X70): 2.5 DTI (JD) 10.2001/>>> 84KW 115CV 2463CC - OPEL MOVANO Autocarro (X70): 2.5 CDTI (JD) 09.2007/>>> 74KW 101CV 2464CC - OPEL MOVANO Autocarro (X70):...</p> <p>d45x77mm d40x63mm 1f-d16mm</p>
	<p>P1127 NO. 09109646 - 09160993 - 4401646 - 4500693</p> <p>CAPA PEDAL EMBRAIAGEM/TRAVAO (GASTA 2 UNIDADES)</p> <p>OPEL MOVANO A Autocarro (X70) 1.9 DTI (JD) 09.2000/10.2001 59KW 80CV 1870CC F9Q 770 3041302 3041308 - OPEL MOVANO A Autocarro (X70) 1.9 DTI (JD) desde 10.2001 60KW 82CV 1870CC F9Q 772 F9Q 774 3041305 3041311 - OPEL MOVANO A Autocarro (X70) 2.2 DTI (JD) desde 09.2000 66KW 90CV 2188CC G9T 720 G9T 750 G9T 722 3041303 3041309 - OPEL MOVANO A Autocarro (X70) 2.5 CDTI (JD) desde 08.2006 88KW 120CV 2464C... ..</p> <p>72x53x11mm 49x38x5mm</p>		<p>R221659 NO. 44x82x145x44x160x195x185x73x40mm 2</p> <p>TUBO DO PERMUTADOR DO AQUECIMENTO</p> <p>OPEL MOVANO A Autocarro (X70) 2.2 DTI (JD) desde 09.2000 66KW 90CV 2188CC G9T 720 G9T 750 G9T 722 3041303 3041309 - OPEL MOVANO A Autocarro (X70) 2.5 DTI (JD) desde 10.2001 84KW 115CV 2463CC G9U 750 G9U 720 G9U 724 G9U 754 3041304 3041310 - OPEL MOVANO A Caixa (X70) 2.2 DTI (FD) desde 09.2000 66KW 90CV 2188CC G9T 750 G9T 720 G9T 722 3041511 - OPEL MOVANO A Caixa (X70) 2.5 DTI (FD) desde 10.2001 84... ..</p> <p>B620-16/18mm 44x82x145x44x160x195x185x73x40mm 2</p>

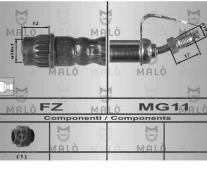
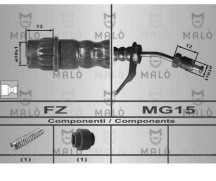
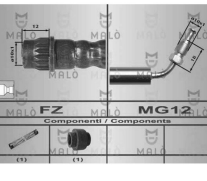
	<p>R223493 NO. 4500077</p> <p>TUBO SUPERIOR DO RADIADOR</p> <p>OPEL MOVANO A Autocarro (X70) 2.8 DTI (JD) (De 07.1998 Até 10.2001) 84kW 114cv 2799cm3 Autocarro - OPEL MOVANO A Caixa (X70) 2.8 DTI (FD) (De 01.1999 Até 10.2001) 84kW 114cv 2799cm3 Caixa - OPEL MOVANO A Camião de plataforma/chassis (X70) 2.8 DTI (ED, HD, UD0, UD4) (De 07.1998 Até 10.2001) 84kW 114cv 2799cm3 Camião de plataforma/chassis -</p> <p>B400-d30/d36mm mm</p>		<p>R223494 NO. 4500112</p> <p>TUBO INFERIOR DO RADIADOR</p> <p>OPEL MOVANO A Autocarro (X70) 2.8 DTI (JD) (De 07.1998 Até 10.2001) 84kW 114cv 2799cm3 Autocarro - OPEL MOVANO A Caixa (X70) 2.8 DTI (FD) (De 01.1999 Até 10.2001) 84kW 114cv 2799cm3 Caixa - OPEL MOVANO A Camião de plataforma/chassis (X70) 2.8 DTI (ED, HD, UD0, UD4) (De 07.1998 Até 10.2001) 84kW 114cv 2799cm3 Camião de plataforma/chassis -</p> <p>B535-d30/d34mm mm</p>
	<p>R224055 NO. 4500076 - 7700302000</p> <p>TUBO INFERIOR DO RADIADOR</p> <p>OPEL MOVANO Caixa (X70) 2.5 D (FD) (De 01.1999 Até 09.2000) 59kW 80cv 2499cm3 Caixa OPEL MOVANO Camião basculante (X70) 2.5 D (ED, HD, UD0, UD4) (De 01.1999 Até 09.2000) 59kW 80cv 2499cm3 Camião basculante - OPEL MOVANO Camião de plataforma/chassis (X70) 2.5 D (ED, HD, UD0, UD4) (De 07.1998 Até 09.2000) 59kW 80cv 2499cm3 Camião de plataforma/chassis - OPEL MOVANO Combi (X70) 2.5 D (JD) (De 07.1998...</p> <p>B360-29/34mm 91x210x66mm</p>		<p>R225679 NO. 1302315 - 95519367 - 95524209</p> <p>TUBO DO AR SOBREALIMENTAÇÃO</p> <p>OPEL MOVANO B Caixa (X62) 2.3 CDTI FWD (FV) desde 05.2010 107KW 146CV 2298CC M9T 680 M9T 678 M9T 706 M9T 708 M9T 880 M9T 878 0035BKG 0035ART 0035AMQ 0035ANR 1844ABF 1844ABP 1844ABA - OPEL MOVANO B Caixa (X62) 2.3 CDTI FWD (FV) desde 02.2012 81KW 110CV 2298CC M9T 870 0035BKD 0035BDC 1844ABD 1844ABI 1844ABQ - OPEL MOVANO B Caixa (X62) 2.3 CDTI FWD (FV) desde 05.2014 100KW 136CV 2298CC M9T 71...</p> <p>B310-54/61mm 154-105</p>
	<p>R225679 NO. 144600588R - 144609413R</p> <p>TUBO DO AR SOBREALIMENTAÇÃO</p> <p>RENAULT MASTER III Caixa (FV) 2.3 dCi 110 FWD (FV0R, FV0W) desde 09.2014 81KW 110CV 2298CC M9T 704 M9T 870 M9T 726 3333BGE 3333BCY - RENAULT MASTER III Caixa (FV) 2.3 dCi 130 FWD (FV0M, FV0Y, FV0J, FV02, FV03) desde 06.2016 96KW 130CV 2298CC M9T 710 M9T 882 M9T 704 3333BGF 3333BGH - RENAULT MASTER III Caixa (FV) 2.3 dCi 135 FWD (FV0N, FV08, FV06, FV00) desde 07.2014 100KW 136CV 2298CC M9T 702 M9T ...</p> <p>B310-54/61mm 154-105</p>		<p>R225680 NO. 1302315 - 95519367 - 95524209</p> <p>TUBO DO AR SOBREALIMENTAÇÃO (2 TUBOS)</p> <p>OPEL MOVANO B Caixa (X62) 2.3 CDTI FWD (FV) desde 05.2010 107KW 146CV 2298CC M9T 680 M9T 678 M9T 706 M9T 708 M9T 880 M9T 878 0035BKG 0035ART 0035AMQ 0035ANR 1844ABF 1844ABP 1844ABA - OPEL MOVANO B Caixa (X62) 2.3 CDTI FWD (FV) desde 02.2012 81KW 110CV 2298CC M9T 870 0035BKD 0035BKH 0035BDC 1844ABD 1844ABI 1844ABQ - OPEL MOVANO B Caixa (X62) 2.3 CDTI FWD (FV) desde 05.2014 100KW 136CV 2298CC M9T 71...</p> <p>B230-57/67mm B295-57/67mm B272-83mm 155-107mm</p>
	<p>R225680 NO. 144600588R - 144609413R</p> <p>TUBO DO AR SOBREALIMENTAÇÃO (2 TUBOS)</p> <p>RENAULT MASTER III Caixa (FV) 2.3 dCi 110 FWD (FV0R, FV0W) desde 09.2014 81KW 110CV 2298CC M9T 704 M9T 870 M9T 726 3333BGE 3333BCY - RENAULT MASTER III Caixa (FV) 2.3 dCi 130 FWD (FV0M, FV0Y, FV0J, FV02, FV03) desde 06.2016 96KW 130CV 2298CC M9T 710 M9T 882 M9T 704 3333BGF 3333BGH - RENAULT MASTER III Caixa (FV) 2.3 dCi 135 FWD (FV0N, FV08, FV06, FV00) desde 07.2014 100KW 136CV 2298CC M9T 702 M9T ...</p> <p>B230-57/67mm B295-57/67mm B272-83mm 155-107mm</p>		<p>R8237 NO. 71-125-83-250-44-49mm ch-d20x190mm</p> <p>TUBO RADIADOR INFERIOR</p> <p>OPEL MOVANO B Autocarro (X62) 2.3 CDTI FWD (JV) desde 12.2010 74KW 101CV 2298CC M9T 670 M9T 676 M9T 672 M9T 870 0035ARO - OPEL MOVANO B Autocarro (X62) 2.3 CDTI FWD (JV) desde 12.2010 92KW 125CV 2298CC M9T 870 M9T 876 M9T 680 M9T 672 M9T 670 M9T 676 M9T 880 0035ASC 0035ARP 0035BHE - OPEL MOVANO B Caixa (X62) 2.3 CDTI FWD (FV) desde 05.2010 74KW 101CV 2298CC M9T 676 M9T 672 M9T 670 M9T 870 M9T 876 ...</p> <p>B555-31/31mm 71-125-83-250-44-49mm ch-d20x190mm ch-d16x340</p>
	<p>RF80335 NO. 4404241 - 4414954 - 4417174 - 9112241 - 9201346 - 93179121 - 93189992</p> <p>TUBO DE FERRO REFRIGERAÇÃO</p> <p>OPEL MOVANO A Autocarro (X70) 2.5 CDTI (JD) desde 08.2006 88KW 120CV 2464CC G9U 632 G9U 650 3041AAV 3041AAW 3041ABA - OPEL MOVANO A Autocarro (X70) 2.5 CDTI (JD) desde 08.2006 107KW 146CV 2464CC G9U 632 G9U 650 3041AAX 3041AAY 3041ABB - OPEL MOVANO A Autocarro (X70) 2.5 CDTI (JD) desde 09.2007 74KW 101CV 2464CC G9U 650 3041AAT 3041AAU 3041AAZ - OPEL MOVANO A Caixa (X70) 2.5 CDTI (FD) desde 10.2003...</p> <p>B500-31/38mm 88-74-121-90-97-87mm 1f-d13mm</p>		<p>RT80206 NO. 4415698 - 46201-00QAH - 5010422007</p> <p>TUBO DE TRAVÃO FRENTE LH-RH</p> <p>OPEL MOVANO TT (APÓS 07-1998)</p> <p>582mm FZ - MC11</p>
	<p>RT80208 NO. 4500133 - 46204-00QAA - 9160433</p> <p>TUBO DE TRAVÃO CENTRAL</p> <p>OPEL MOVANO TT (APÓS 07-1998)</p> <p>433mm FZ - MC11</p>		<p>RT80211 NO. 4403662 - 46201-00QAE - 46204-00QAE - 9111662</p> <p>TUBO DE TRAVÃO TRÁS LH-RH (COM DISCO)</p> <p>OPEL MOVANO TT (APÓS 07-1998)</p> <p>355mm FZ - MC11</p>
	<p>RT80384 NO. 4500132 - 9160432</p> <p>TUBO DE TRAVÃO FRENTE LH-RH</p> <p>OPEL MOVANO TT (07-1998 A 08-2003)</p> <p>570mm FZ - MG11</p>		<p>RT80385 NO. 4500131 - 9160431</p> <p>TUBO DE TRAVÃO FRENTE LH-RH</p> <p>OPEL MOVANO TT (07-1998 A 08-2003)</p> <p>615mm FZ - MG11</p>
	<p>RT80587 NO. 4403643 - 46201-00QAD - 8200057462</p> <p>TUBO DE TRAVÃO DA FRENTE LH-RH</p> <p>OPEL MOVANO Combi (J9) 1.9 DTI (APÓS 10.01) 82cv 1870cc Autocarro - OPEL MOVANO Combi (J9) 2.2 DTI (APÓS 09.00) 90cv 2188cc Autocarro - OPEL MOVANO Combi (J9) 2.5 DTI (APÓS 10.01) 115cv 2463cc Autocarro - OPEL MOVANO Combi (J9) 2.5 CDTI (APÓS 08.06) 120cv 2464cc Autocarro - OPEL MOVANO Combi (J9) 2.5 CDTI (APÓS 08.06) 146cv 2464cc Autocarro</p> <p>535mm FZ - MG15</p>		<p>RT80588 NO. 4403645 - 46201-00QAC - 8200057460</p> <p>TUBO DE TRAVÃO DA FRENTE</p> <p>OPEL MOVANO Combi (J9) 1.9 DTI (APÓS 10.01) 82cv 1870cc Autocarro - OPEL MOVANO Combi (J9) 2.2 DTI (APÓS 09.00) 90cv 2188cc Autocarro - OPEL MOVANO Combi (J9) 2.5 DTI (APÓS 10.01) 115cv 2463cc Autocarro - OPEL MOVANO Combi (J9) 2.5 CDTI (APÓS 08.06) 120cv 2464cc Autocarro - OPEL MOVANO Combi (J9) 2.5 CDTI (APÓS 08.06) 146cv 2464cc Autocarro</p> <p>510mm F7 - MG12</p>

	<p>S1118 NO. 5000392657 - 7700730733</p> <p>SILENT-BLOC DA SUSPENSÃO TRÁS</p> <p>OPEL MOVANO Autocarro (X70): 1.9 DTI (JD) 09.2000/10.2001 59KW 80CV 1870CC - OPEL MOVANO Autocarro (X70): 1.9 DTI (JD) 10.2001/10.2001 60KW 82CV 1870CC - OPEL MOVANO Autocarro (X70): 2.2 DTI (JD) 09.2000/10.2001 66KW 90CV 2188CC - OPEL MOVANO Autocarro (X70): 2.5 DTI (JD) 10.2001/10.2001 84KW 115CV 2463CC - OPEL MOVANO Autocarro (X70): 2.5 CDTI (JD) 08.2006/10.2007 88KW 120CV 2464CC - OPEL MOVANO Autocarro (X70):...</p> <p>d54x80mm d46mm 1f-d22mm</p>		<p>S1741 NO. 4404592 - 4404593 - 4500102 - 9112593</p> <p>SILENTBLOC MOLAS LAMINA TRÁS OLHAL FRENTE</p> <p>OPEL MOVANO Autocarro (X70): 1.9 DTI (JD) 09.2000/10.2001 59KW 80CV 1870CC - OPEL MOVANO Autocarro (X70): 1.9 DTI (JD) 10.2001/10.2001 60KW 82CV 1870CC - OPEL MOVANO Autocarro (X70): 2.2 DTI (JD) 09.2000/10.2001 66KW 90CV 2188CC - OPEL MOVANO Autocarro (X70): 2.5 DTI (JD) 10.2001/10.2001 84KW 115CV 2463CC - OPEL MOVANO Autocarro (X70): 2.5 CDTI (JD) 09.2007/10.2007 74KW 101CV 2464CC - OPEL MOVANO Autocarro (X70):...</p> <p>d45x77mm c63mm d41mm 1f-d16mm</p>
	<p>S1926 NO. 4500094</p> <p>SILENT-BLOC DO BRAÇO SUSPENSÃO FRENTE PARTE DA FRENTE</p> <p>OPEL A1:F101 MOVANO Autocarro (X70) 1.9 DTI (JD) (De 09.2000 Até 10.2001) 59KW 80cv 1870cm3 Autocarro - OPEL MOVANO Autocarro (X70) 1.9 DTI (JD) (De 09.2000 Até 10.2001) 59KW 80cv 1870cm3 Autocarro - OPEL MOVANO Autocarro (X70) 1.9 DTI (JD) (De 09.2000 Até 10.2001) 59KW 80cv 1870cm3 Autocarro - OPEL MOVANO Autocarro (X70) 1.9 DTI (JD) (De 09.2000 Até 10.2001) 59KW 80cv 1870cm3 Autocarro - OPEL MOVANO Autocarro (X70) 1.9 DTI (JD) (De 10.2001 -) 60KW 82cv 1870cm3 Autocarro - OPEL MOVANO Autoc...</p> <p>d75x 74mm c-58mm dc-55mm1f-d28mm</p>		<p>S1927 NO. 4500095</p> <p>SILENT-BLOC DO BRAÇO SUSPENSÃO FRENTE PARTE DA FRENTE</p> <p>OPEL A1:F101 MOVANO Autocarro (X70) 1.9 DTI (JD) (De 09.2000 Até 10.2001) 59KW 80cv 1870cm3 Autocarro - OPEL MOVANO Autocarro (X70) 1.9 DTI (JD) (De 09.2000 Até 10.2001) 59KW 80cv 1870cm3 Autocarro - OPEL MOVANO Autocarro (X70) 1.9 DTI (JD) (De 09.2000 Até 10.2001) 59KW 80cv 1870cm3 Autocarro - OPEL MOVANO Autocarro (X70) 1.9 DTI (JD) (De 09.2000 Até 10.2001) 59KW 80cv 1870cm3 Autocarro - OPEL MOVANO Autocarro (X70) 1.9 DTI (JD) (De 10.2001 -) 60KW 82cv 1870cm3 Autocarro - OPEL MOVANO Autoc...</p> <p>d75x79mm d56mm c58mm 1f-d28mm</p>
	<p>S2071 NO. 4419215 - 4419216 - 4419217 - 93197214 - 93197215 - 93197216</p> <p>SILENT-BLOC DO BRAÇO SUSPENSÃO DA FRENTE PARTE DA FRENTE</p> <p>OPEL MOVANO B Autocarro (X62) 2.3 CDTI FWD (JV) desde 12.2010 74KW 101CV 2298CC M9T 670 M9T 676 M9T 672 M9T 870 0035ARO - OPEL MOVANO B Autocarro (X62) 2.3 CDTI FWD (JV) desde 12.2010 92KW 125CV 2298CC M9T 870 M9T 876 M9T 680 M9T 672 M9T 670 M9T 676 M9T 880 0035ASC 0035ARP 0035BHE - OPEL MOVANO B Autocarro (X62) 2.3 CDTI FWD (JV) desde 12.2010 107KW 146CV 2298CC M9T 680 M9T 678 M9T 706 M9T 708 003...</p> <p>d55x64mm d49mm 1f-d16mm</p>		<p>S2072 NO. 4419215 - 4419216 - 4419218 - 93197214 - 93197215 - 93197232</p> <p>SILENT-BLOC DO BRAÇO SUSPENSÃO DA FRENTE PARTE DE TRÁS</p> <p>OPEL MOVANO B Autocarro (X62) 2.3 CDTI FWD (JV) desde 12.2010 74KW 101CV 2298CC M9T 670 M9T 676 M9T 672 M9T 870 0035ARO - OPEL MOVANO B Autocarro (X62) 2.3 CDTI FWD (JV) desde 12.2010 92KW 125CV 2298CC M9T 870 M9T 876 M9T 680 M9T 672 M9T 670 M9T 676 M9T 880 0035ASC 0035ARP 0035BHE - OPEL MOVANO B Autocarro (X62) 2.3 CDTI FWD (JV) desde 12.2010 107KW 146CV 2298CC M9T 680 M9T 678 M9T 706 M9T 708 003...</p> <p>d70x77mm c40mm 1f-d16mm</p>
	<p>T0618-I NO. 8200893777</p> <p>BATENTE APOIO DE SUSPENSÃO FRENTE (GASTA 2 UNIDADES)</p> <p>OPEL MOVANO Combi (J9) 2.2 DTI (APÓS09.00) 90cv 2188cc Autocarro - OPEL MOVANO Combi (J9) 2.5 DTI (APÓS 10.01) 115cv 2463cc Autocarro - OPEL MOVANO Combi (J9) 2.5 CDTI (10.03 A 12.06) 99cv 2463cc Autocarro - OPEL MOVANO Combi (J9) 3.0 DTI (APÓS 10.03) 136cv 2953cc Autocarro - OPEL MOVANO Caixa (F9) 2.2 DTI (APÓS 09.00) 90cv 2188cc Caixa - OPEL MOVANO Caixa (F9) 2.5 DTI (APÓS10.03) 99cv 2463c...</p> <p>d58x85mm 1f-d13mm 1p-d10x26mm</p>		<p>T0619-I NO.</p> <p>BATENTE APOIO DE SUSPENSÃO TRÁS (GASTA 2 UNIDADES)</p> <p>OPEL MOVANO</p> <p>d94x125mm 1f-d31mm 1f-d11mm</p>
	<p>T1081 NO. 09109134 - 4401134 - 9109134</p> <p>BATENTE BARRA ESTABILIZADORA FRENTE FUORO 22,40MM</p> <p>OPEL MOVANO A Autocarro (X70) 1.9 DTI (JD) 09.2000/10.2001 59KW 80CV 1870CC F9Q 770 3041302 3041308 - OPEL MOVANO A Autocarro (X70) 1.9 DTI (JD) desde 10.2001 60KW 82CV 1870CC F9Q 772 F9Q 774 3041305 3041311 - OPEL MOVANO A Autocarro (X70) 2.2 DTI (JD) desde 09.2000 66KW 90CV 2188CC G9T 720 G9T 750 G9T 722 3041303 3041309 - OPEL MOVANO A Autocarro (X70) 2.5 CDTI (JD) desde 08.2006 88KW 120CV 2464C...</p> <p>39x35x23mm 1f-d22mm</p>		<p>T1191 NO. 04419 323 - 093197327 - 4419323 - 93197327</p> <p>BATENTE DA BARRA ESTABILIZADORA DA FRENTE</p> <p>OPEL MOVANO B Autocarro (X62) 2.3 CDTI FWD (JV) (De 12-2010 Até 1-20 -) 74KW 101CV 2298cc Autocarro - OPEL MOVANO B Autocarro (X62) 2.3 CDTI FWD (JV) (De 12-2010 Até 1-20 -) 92KW 125CV 2298cc Autocarro - OPEL MOVANO B Autocarro (X62) 2.3 CDTI FWD (JV) (De 12-2010 Até 1-20 -) 107KW 146CV 2298cc Autocarro - OPEL MOVANO B Autocarro (X62) 2.3 CDTI FWD (JV) (De 01-2013 Até 1-20 -) 110KW 150CV 2298cc...</p> <p>39x41x42mm 1f-d24mm</p>
	<p>UAP81637 NO. 09110702 - 4402702 - 9110702</p> <p>ANILHA PROTEÇÃO TÉRMICA INJECTORES</p> <p>OPEL MOVANO Combi (X70) 1.9 DTI (JD) (De 2000.09 Até 2001.10) 59KW 80cv 1870cm3 Autocarro - OPEL MOVANO Combi (X70) 1.9 DTI (JD) (De 2001.10 -) 60KW 82cv 1870cm3 Autocarro - OPEL MOVANO Caixa (X70) 1.9 DTI (FD) (De 2000.09 Até 2001.10) 59KW 80cv 1870cm3 Caixa - OPEL MOVANO Caixa (X70) 1.9 DTI (FD) (De 2001.10 -) 60KW 82cv 1870cm3 Caixa -</p> <p>d15x3mm 1f-d7mm</p>		<p>UAP81637 NO. 09110702 - 4402702 - 9110702</p> <p>ANILHA PROTEÇÃO TÉRMICA INJECTORES</p> <p>OPEL MOVANO B Autocarro (X62) 2.3 CDTI FWD (JV) (De 2014.05 -) 100KW 136cv 2298cm3 Autocarro - OPEL MOVANO B Autocarro (X62) 2.3 CDTI FWD (JV) (De 2014.05 -) 120KW 163cv 2298cm3 Autocarro - OPEL MOVANO B Caixa (X62) 2.3 CDTI FWD (FV) (De 2014.05 -) 100KW 136cv 2298cm3 Caixa - OPEL MOVANO B Caixa (X62) 2.3 CDTI RWD (FV) (De 2014.05 -) 100KW 136cv 2298cm3 Caixa -</p> <p>Ø53mm/ANO ... 1f-d7mm</p>
	<p>UAP83244 NO. 055565375 - 55565375</p> <p>ANILHA PROTEÇÃO TÉRMICA INJECTORES</p> <p>OPEL MOVANO B Autocarro (X62) 2.3 CDTI FWD (JV) (De 12-2010 Até 1-20 -) 74KW 101CV 2298cc Autocarro - OPEL MOVANO B Autocarro (X62) 2.3 CDTI FWD (JV) (De 05-2014 Até 1-20 -) 81KW 110CV 2298cc Autocarro - OPEL MOVANO B Autocarro (X62) 2.3 CDTI FWD (JV) (De 12-2010 Até 1-20 -) 92KW 125CV 2298cc Autocarro - OPEL MOVANO B Autocarro (X62) 2.3 CDTI FWD (JV) (De 05-2014 Até 1-20 -) 100KW 136CV 2298cc...</p> <p>d15x2mm 1f-d7mm</p>		<p>UTR0805 NO. 17932-84CT0 - 4402429 - 9110429</p> <p>TAMPÃO RESERVATÓRIO LIQUIDO REFRIGERAÇÃO</p> <p>OPEL MOVANO Comb 1.9 DTI (09.00 A 10.01) 80cv 1870cc Autocarro - OPEL MOVANO Combi 1.9 DTI (APÓS 10.01) 82cv 1870cc Autocarro - OPEL MOVANO Combi (J9) 2.2 DTI (APÓS 09.00) 90cv 2188cc Autocarro - OPEL MOVANO Combi 2.5 CDTI (10.03 A 12.06) 99cv 2463cc Autocarro - OPEL MOVANO Combi 2.5 CDTI (APÓS 09.07) 101cv 2464cc Autocarro - OPEL MOVANO Combi 2.5 CDTI (APÓS 08.06) 120cv 2464cc Autocarro...</p> <p>d55x26mm 1f-d45x13mm</p>
	<p>UTR0837 NO. 1793284CT0 - 2151600QAA - 2151600QAB - 4402429 - 7700805031 - 7700808836 - 9110429</p> <p>TAMPÃO RESERVATÓRIO LIQUIDO REFRIGERAÇÃO</p> <p>OPEL MOVANO Autocarro (X70): 1.9 DTI (JD) 09.2000/10.2001 59KW 80CV 1870CC - OPEL MOVANO Autocarro (X70): 1.9 DTI (JD) 10.2001/10.2001 60KW 82CV 1870CC - OPEL MOVANO Autocarro (X70): 2.2 DTI (JD) 09.2000/10.2001 66KW 90CV 2188CC - OPEL MOVANO Autocarro (X70): 2.5 DTI (JD) 10.2001/10.2001 84KW 115CV 2463CC - OPEL MOVANO Autocarro (X70): 2.5 CDTI (JD) 09.2007/10.2007 74KW 101CV 2464CC - OPEL MOVANO Autocarro (X70):...</p> <p>52x22mm 1f-d45x10mm</p>		<p>UTR0841 NO. 7700505032 - 7700760508 - 7700805031 - 7704001606</p> <p>TAMPÃO RESERVATÓRIO LIQUIDO REFRIGERAÇÃO</p> <p>OPEL MOVANO Combi (X70) 2.5 CDTI (JD) (De 09-2007 Até ...) 74KW 101CV 2464cc Autocarro - OPEL MOVANO Combi (X70) 2.5 CDTI (JD) (De 08-2006 Até ...) 88KW 120CV 2464cc Autocarro - OPEL MOVANO Caixa (X70) 2.5 CDTI (FD) (De 10-2003 Até ...) 74KW 101CV 2464cc Caixa - OPEL MOVANO Caixa (X70) 2.5 CDTI (FD) (De 10-2003 Até ...) 88KW 120CV 2464cc Caixa - OPEL MOVANO Caixa (X70) 2.5 CDTI (FD) (De 10-2003 Até ...)</p> <p>d49x23mm 1f-d42x11mm</p>

	<p>UTR1305 NO. 0650089 - 650089</p> <p>TAMPÃO DO RESERVATÓRIO ÓLEO</p> <p>OPEL MOVANO A Autocarro (X70) 1.9 DTI (JD) (09.2000 -10.2001) 59kw 80cv 1870cm3 Autocarro OPEL MOVANO A Autocarro (X70) 1.9 DTI (JD) (10.2001 -) 60kw 82cv 1870cm3 Autocarro OPEL MOVANO A Autocarro (X70) 2.2 DTI (JD) (09.2000 -) 66kw 90cv 2188cm3 Autocarro OPEL MOVANO A Autocarro (X70) 2.5 D (JD) (07.1998 -09.2000) 59kw 80cv 2499cm3 Autocarro OPEL MOVANO A Autocarro (X70) 2.5 DTI (JD) (10.2001 -) 8...</p> <p>d61x23mm d32x19mm</p>		<p>UTR1403 NO. 7701470950 - 7701471585</p> <p>TAMPÃO DEPÓSITO COMBUSTIVEL</p> <p>OPEL MOVANO A Autocarro (X70) 1.9 DTI (JD) 09.2000/10.2001 59KW 80CV 1870CC F9Q 770 3041302 3041308 - OPEL MOVANO A Autocarro (X70) 1.9 DTI (JD) desde 10.2001 60KW 82CV 1870CC F9Q 772 F9Q 774 3041305 3041311 - OPEL MOVANO A Autocarro (X70) 2.2 DTI (JD) desde 09.2000 66KW 90CV 2188CC G9T 720 G9T 750 G9T 722 3041303 3041309 - OPEL MOVANO A Autocarro (X70) 2.5 CDTI (JD) desde 08.2006 88KW 120CV 2464C...</p> <p>d73x67mm d37mm</p>
	<p>UTV83018 NO. 09110558 - 4402558 - 4418098 - 9110558 - 93192517</p> <p>TAMPÃO VEDAÇÃO BUJÃO</p> <p>OPEL MOVANO Combi (X70) 1.9 DTI (JD) (De 10-2001 Até ...) 60kW 82CV 1870cc Autocarro OPEL MOVANO Caixa (X70) 1.9 DTI (FD) (De 09-2000 Até 10-2001) 59kW 80CV 1870cc Caixa OPEL MOVANO Caixa (X70) 1.9 DTI (FD) (De 10-2001 Até ...) 60kW 82CV 1870cc Caixa</p> <p>d21x18mm c14mm d15mm</p>		<p>W5083 NO. 4405268 - 4416426 - 4416535 - 4418765 - 4433564 - 9121101 - 931188615 - 93187473 - 93196089 ...</p> <p>POLIE DA CAMBOTA (7 PISTAS)</p> <p>OPEL MOVANO Combi (J9) - 2.2 DTI Autocarro 90CV 2188cc (APÓS 09-2000) - 2.5 DTI 115CV 2463cc (APÓS 10-2001) - 2.5 CDTI 101CV 2464cc (APÓS 09-2007) - 2.5 CTDI 120CV 2464cc (APÓS 08-2006) - 2.5 CDTI 146CV 2464cc (APÓS 08-2006) - MOVANO Caixa (F9) - 2.2 DTI</p> <p>d152/162mm d30/58mm</p>
	<p>W5095 NO. 4405269 - 9121102</p> <p>POLIE DA CAMBOTA (7 PISTAS)</p> <p>OPEL MOVANO A Autocarro (X70) 2.2 DTI (JD) desde 09.2000 66KW 90CV 2188CC G9T 720 G9T 750 G9T 722 3041303 3041309 - OPEL MOVANO A Autocarro (X70) 2.5 CDTI (JD) desde 08.2006 88KW 120CV 2464CC G9U 632 G9U 650 3041AAV 3041AAW 3041ABA - OPEL MOVANO A Autocarro (X70) 2.5 CDTI (JD) desde 08.2006 107KW 146CV 2464CC G9U 632 G9U 650 3041AAX 3041AAY 3041ABB - OPEL MOVANO A Autocarro (X70) 2.5 CDTI (JD) des...</p> <p>d146.5mm d30mm</p>		<p>W5133 NO. 4420381 - 93168039</p> <p>POLIE DA CAMBOTA (7 PISTAS)</p> <p>OPEL MOVANO B Autocarro (X62): 2.3 CDTI FWD (JV) 12.2010/»» 74KW 101CV 2298CC - OPEL MOVANO B Autocarro (X62): 2.3 CDTI FWD (JV) 05.2014/»» 81KW 110CV 2298CC - OPEL MOVANO B Autocarro (X62): 2.3 CDTI FWD (JV) 12.2010/»» 92KW 125CV 2298CC - OPEL MOVANO B Autocarro (X62): 2.3 CDTI FWD (JV) 05.2014/»» 100KW 136CV 2298CC - OPEL MOVANO B Autocarro (X62): 2.3 CDTI FWD (JV) 12.2010/»» 107KW 146CV 22...</p> <p>d151mm 1f-38/31mm</p>
	<p>Z80758 NO. 4501589</p> <p>MOLA DE FRISO</p> <p>OPEL MOVANO</p> <p>d20x16.5mm 1p-8x8-6.5mm</p>		

OPEL OMEGA - SENATOR B









	<p>A0654 NO. 0682554 - 682554 - 90222823</p> <p>APOIO CAIXA VELOCIDADES</p> <p>OPEL OMEGA A (V87) 1.8 N (F19 - M19 - N19) (De 09-1986 Até 08-1987) 60kW 82CV 1796cc três volumes OPEL OMEGA A (V87) 1.8 (F19 - M19 - N19) (De 09-1987 Até 03-1994) 65kW 88CV 1796cc três volumes OPEL OMEGA A (V87) 1.8 (F19 - M19 - N19) (De 09-1986 Até 03-1994) 85kW 115CV 1796cc três volumes OPEL OMEGA A (V87) 2.0 i (F19 - M19 - N19) (De 09-1986 Até 03-1994) 85kW 115CV 1998cc três volumes OPEL O...</p> <p>184x35x57mm 2f-d12mm 2p-d8x16mm</p>		<p>A2088 NO. 0684274 - 684274 - 90235055</p> <p>APOIO MOTOR LADO DIREITO E ESQUERDO (HIDRAULICO)</p> <p>OPEL OMEGA A (V87) 2.3 D (F19 - M19 - N19) (De 10-1986 Até 03-1994) 54kW 73CV 2260cc três volumes OPEL OMEGA A (V87) 2.3 TD (F19 - M19 - N19) (De 10-1986 Até 08-1988) 66kW 90CV 2260cc três volumes OPEL OMEGA A (V87) 2.3 TD Interc. (F19 - M19 - N19) (De 08-1988 Até 03-1994) 74kW 100CV 2260cc três volumes OPEL OMEGA A Combi (V87) 2.3 D (F35 - M35) (De 09-1986 Até 03-1994) 54kW 73CV 2260cc Combi ...</p> <p>d105x110mm 1p-d10x23 1p-d10x17mm</p>
	<p>A2088 NO. 0684274 - 684274 - 90235055</p> <p>APOIO MOTOR LADO DIREITO E ESQUERDO (HIDRAULICO)</p> <p>OPEL OMEGA B (V94) 2.5 TD (F69 - M69 - P69) (De 04-1994 Até 07-2003) 96kW 130CV 2497cc três volumes OPEL OMEGA B Combi (V94) 2.5 TD (F35 - M35 - P35) (De 04-1994 Até 07-2001) 96kW 131CV 2497cc Combi</p> <p>d105x110mm 1p-d10x23 1p-d10x17mm</p>		<p>A2089 NO. 0684274 - 684274 - 90235055</p> <p>APOIO DO MOTOR LADO DIREITO E ESQUERDO</p> <p>OPEL OMEGA A (V87) 2.3 D (F19 - M19 - N19) (De 10-1986 Até 03-1994) 54kW 73CV 2260cc três volumes OPEL OMEGA A (V87) 2.3 TD (F19 - M19 - N19) (De 10-1986 Até 08-1988) 66kW 90CV 2260cc três volumes OPEL OMEGA A (V87) 2.3 TD Interc. (F19 - M19 - N19) (De 08-1988 Até 03-1994) 74kW 100CV 2260cc três volumes OPEL OMEGA A Combi (V87) 2.3 D (F35 - M35) (De 09-1986 Até 03-1994) 54kW 73CV 2260cc Combi ...</p> <p>d105x110mm 1p-d10x23mm 1p-d10x17</p>
	<p>A2089 NO. 0684274 - 684274 - 90235055</p> <p>APOIO DO MOTOR LADO DIREITO E ESQUERDO</p> <p>OPEL OMEGA B (V94) 2.5 TD (F69 - M69 - P69) (De 04-1994 Até 07-2003) 96kW 130CV 2497cc três volumes OPEL OMEGA B Combi (V94) 2.5 TD (F35 - M35 - P35) (De 04-1994 Até 07-2001) 96kW 131CV 2497cc Combi</p> <p>d105x110mm 1p-d10x23mm 1p-d10x17</p>		<p>A2242 NO. 0817744 - 817744 - 90080552</p> <p>APOIO DA BOMBA DO COMBUSTIVEL</p> <p>OPEL OMEGA A (V87) 1.8 (F19, M19, N19) (De 1987.09 Até 1994.03) 65kW 88cv 1796cm3 três volumes - OPEL OMEGA A (V87) 2.0 i (F19, M19, N19) (De 1986.09 Até 1994.03) 85kW 115cv 1998cm3 três volumes - OPEL OMEGA A (V87) 2.0 (F19, M19, N19) (De 1986.09 Até 1994.03) 90kW 122cv 1998cm3 três volumes - OPEL OMEGA A (V87) 3.0 (3000) (F19, M19, N19) (De 1987.03 Até 1987.12) 115kW 156cv ...</p> <p>19x21mm 2p-d8x14mm</p>

	<p>A2242 NO. 0817744 - 817744 - 90080552</p> <p>APOIO DA BOMBA DO COMBUSTIVEL</p> <p>OPEL SENATOR B (V88) 2.5 i (P19) (De 1990.09 Até 1993.09) 103kW 140cv 2490cm3 três volumes - OPEL SENATOR B (V88) 3.0 (P19) (De 1987.09 Até 1993.09) 115kW 156cv 2969cm3 três volumes - OPEL SENATOR B (V88) 3.0 (P19) (De 1988.01 Até 1990.09) 130kW 177cv 2969cm3 três volumes -</p> <p>19x21mm 2p-d8x14mm</p>		<p>A2499 NO. 00684173 - 0682560 - 24417107 - 90235666 - 90289667</p> <p>APOIO DO MOTOR PARTE DA FRENTE DIREITO E ESQUERDO</p> <p>OPEL OMEGA A (V87) 1.8 (F19, M19, N19) (De 09.1987 Até 03.1994) 65kW 88cv 1796cm3 três volumes - OPEL OMEGA A (V87) 1.8 (F19, M19, N19) (De 09.1986 Até 03.1994) 85kW 115cv 1796cm3 três volumes - OPEL OMEGA A (V87) 1.8 N (F19, M19, N19) (De 09.1986 Até 08.1987) 60kW 82cv 1796cm3 três volumes - OPEL OMEGA A (V87) 1.8 S (F19, M19, N19) (De 09.1986 Até 03.1994) 66kW 90cv 1796cm3 três volumes - OPEL OM...</p> <p>d103x66mm 1p-d10x17mm 1p-d10x25mm</p>
	<p>A2499 NO. 00684173 - 0682560 - 24417107 - 90235666 - 90289667</p> <p>APOIO DO MOTOR PARTE DA FRENTE DIREITO E ESQUERDO</p> <p>OPEL OMEGA B (V94) 2.0 (F69, M69, P69) (De 03.1994 Até 09.1999) 85kW 116cv 1998cm3 três volumes - OPEL OMEGA B (V94) 2.0 16V (F69, M69, P69) (De 03.1994 Até 09.1999) 100kW 136cv 1998cm3 três volumes - OPEL OMEGA B (V94) 2.2 16V (F69, M69, P69) (De 09.1999 Até 07.2003) 106kW 144cv 2198cm3 três volumes - OPEL OMEGA B Combi (V94) 2.0 (F35, M35, P35) (De 03.1994 Até 09.1999) 85kW 116cv 1998cm3 Combi - ...</p> <p>d103x66mm 1p-d10x17mm 1p-d10x25mm</p>		<p>A2571 NO. 0458009 - 458009 - 90343676</p> <p>APOIO DA TRANSMISSÃO SEM ROLAMENTO</p> <p>OPEL OMEGA A (V87) 1.8 (F19, M19, N19) (De 09.1987 Até 03.1994) 65kW 88cv 1796cm3 três volumes - OPEL OMEGA A (V87) 1.8 (F19, M19, N19) (De 09.1986 Até 03.1994) 85kW 115cv 1796cm3 três volumes - OPEL OMEGA A (V87) 1.8 N (F19, M19, N19) (De 09.1986 Até 08.1987) 60kW 82cv 1796cm3 três volumes - OPEL OMEGA A (V87) 1.8 S (F19, M19, N19) (De 09.1986 Até 03.1994) 66kW 90cv 1796cm3 três volumes - OPEL OM...</p> <p>118x27x99mm 1f-d51mm 2r-d7mm</p>
	<p>A2571 NO. 0458009 - 458009 - 90343676</p> <p>APOIO DA TRANSMISSÃO SEM ROLAMENTO</p> <p>OPEL SENATOR B (V88) 2.5 i (P19) (De 09.1990 Até 09.1993) 103kW 140cv 2490cm3 três volumes - OPEL SENATOR B (V88) 2.6 i (P19) (De 09.1990 Até 09.1993) 110kW 150cv 2594cm3 três volumes - OPEL SENATOR B (V88) 3.0 (P19) (De 01.1988 Até 09.1990) 130kW 177cv 2969cm3 três volumes - OPEL SENATOR B (V88) 3.0 24V (P19) (De 09.1989 Até 09.1993) 150kW 204cv 2969cm3 três volumes - OPEL SENATOR B (V88) 3.0 i C...</p> <p>118x27x99mm 1f-d51mm 2r-d7mm</p>		<p>C0233 NO. 1160724 - 90054143</p> <p>BOTÃO AFINAÇÃO CAPÔT</p> <p>OPEL OMEGA B (25_26_27_) 2.0 (03.94 A 12.00) 115cv 1998cc três volumes - OPEL OMEGA B (25_26_27_) 2.0 (03.94 A 09.99) 116cv 1998cc três volumes - OPEL OMEGA B (25_26_27_) 2.0 16V (03.94 A 09.99) 136cv 1998cc três volumes - OPEL OMEGA B (25_26_27_) 2.2 16V (09.99 A 07.03) 144cv 2198cc três volumes - OPEL OMEGA B (25_26_27_) 2.5 V6 (03.94 A 09.00) 170cv 2498cc três volumes - OPEL...</p> <p>d19x31mm</p>
	<p>D0040 NO. 0458364 - 458364 - 90222781</p> <p>CARDAN TRANSMISSÃO</p> <p>OPEL OMEGA A (16_, 17_, 19_) 1.8 N (09.86 A 08.87) 82cv 1796cc três volumes - OPEL OMEGA A (16_, 17_, 19_) 1.8 (09.87 A 03.94) 88cv 1796cc três volumes - OPEL OMEGA A (16_, 17_, 19_) 1.8 S (09.86 A 03.94) 90cv 1796cc três volumes - OPEL OMEGA A (16_, 17_, 19_) 1.8 (09.86 A 03.94) 115cv 1796cc três volumes - OPEL OMEGA A (16_, 17_, 19_) 2.0 (09.90 A 03.94) 99cv 1998cc três volumes - OPEL ...</p> <p>100x105x28mm 6f-d10mm</p>		<p>D0040 NO. 0458364 - 458364 - 90222781</p> <p>CARDAN TRANSMISSÃO</p> <p>OPEL OMEGA B (25_, 26_, 27_) 2.0 Ano fabric. até: 09.99 (03.94 A 12.00) 115cv 1998cc três volumes - OPEL OMEGA B (25_, 26_, 27_) 2.0 (03.94 A 09.99) 116cv 1998cc três volumes - OPEL OMEGA B (25_, 26_, 27_) 2.0 16V (03.94 A 09.99) 136cv 1998cc três volumes - OPEL OMEGA B Combi (21_, 22_, 23_) 2.0 (03.94 A 09.99) 116cv 1998cc Combi - OPEL OMEGA B Combi (21_, 22_, 23_) 2.0 16V (03.94 A 09.99)...</p> <p>100x105x28mm 6f-d10mm</p>
	<p>D0052 NO. 0458363 - 0458366 - 0458367 - 458363 - 458366 - 458367 - 90023735 - 90425689 - 90578558</p> <p>CARDAN TRANSMISSÃO</p> <p>OPEL OMEGA A (V87) 2.4 i (F19, M19, N19) (09.88 A 03.94) 125cv 2410cc três volumes - OPEL OMEGA A (V87) 2.6 i (F19, M19, N19) (09.90 A 03.94) 150cv 2594cc três volumes - OPEL OMEGA A (V87) 3.0 (3000) (F19, M19, N19) (03.87 A 12.87) 156cv 2969cc três volumes - OPEL OMEGA A (V87) 3.0 (3000) (F19, M19, N19) (03.87 A 09.90) 177cv 2969cc três volumes - OPEL OMEGA A (V87) 3.0 (3000) Cat (F19, M19, N19)...</p> <p>d127X30mm 6f-d12mm</p>		<p>D0052 NO. 0458363 - 0458366 - 0458367 - 458363 - 458366 - 458367 - 90023735 - 90425689 - 90578558</p> <p>CARDAN TRANSMISSÃO</p> <p>OPEL OMEGA B (V94) 2.2 16V (F69, M69, P69) (09.99 A 07.03) 144cv 2198cc três volumes - OPEL OMEGA B (V94) 2.5 V6 (F69, M69, P69) (03.94 A 09.00) 170cv 2498cc três volumes - OPEL OMEGA B (V94) 3.0 V6 (F69, M69, P69) (04.94 A 02.01) 211cv 2962cc três volumes - OPEL OMEGA B (V94) 2.0 DTI 16V (F69, M69, P69) (09.97 A 09.00) 101cv 1995cc três volumes - OPEL OMEGA B (V94) 2.5 TD (F69, M69, P69) ...</p> <p>d127X30mm 6f-d12mm</p>
	<p>E0013 NO. 852715 - 852716 - 852720</p> <p>ESTICADOR DE ESCAPE</p> <p>OPEL OMEGA A (08-1989 A 06-1993)</p> <p>66x56x13mm</p>		<p>E0048 NO. 852506</p> <p>ESTICADOR DE ESCAPE</p> <p>OPEL OMEGA A (09-1986 A 04-1994)</p> <p>59x40x28mm 2f-d14mm</p>
	<p>E1092 NO. 0852726 - 13276148 - 852577 - 852726 - 90466668</p> <p>ESTICADOR DE ESCAPE</p> <p>OPEL OMEGA B (V94): 2.0 (F69, M69, P69) 03.1994/12.2000 85KW 115CV 1998CC - OPEL OMEGA B (V94): 2.0 (F69, M69, P69) 03.1994/09.1999 85KW 116CV 1998CC - OPEL OMEGA B (V94): 2.0 16V (F69, M69, P69) 03.1994/09.1999 100KW 136CV 1998CC - OPEL OMEGA B (V94): 2.2 16V (F69, M69, P69) 09.1999/07.2003 106KW 144CV 2198CC - OPEL OMEGA B (V94): 2.5 V6 (F69, M69, P69) 03.1994/09.2000 125KW 170CV 2498CC - OPEL O...</p> <p>55x40x35mm</p>		<p>F0469-I NO. 3435052 - 414510</p> <p>FOLE DA TRANSMISSÃO LADO DA CAIXA</p> <p>OPEL OMEGA A (V87): 1.8 N (F19, M19, N19) 09.1986/08.1987 60KW 82CV 1796CC - OPEL OMEGA A (V87): 1.8 (F19, M19, N19) 09.1987/03.1994 65KW 88CV 1796CC - OPEL OMEGA A (V87): 1.8 S (F19, M19, N19) 09.1986/03.1994 66KW 90CV 1796CC - OPEL OMEGA A (V87): 1.8 (F19, M19, N19) 09.1986/03.1994 85KW 115CV 1796CC - OPEL OMEGA A (V87): 2.0 (F19, M19, N19) 09.1990/03.1994 73KW 99CV 1998CC - OPEL OMEGA A (V87): ...</p> <p>d85x80mm 1f-d61mm 1f-d23mm</p>
	<p>F0469-I NO. 3435052 - 414510</p> <p>FOLE DA TRANSMISSÃO LADO DA CAIXA</p> <p>OPEL SENATOR A (29_): 2.0 E 03.1983/10.1984 85KW 115CV 1979CC - OPEL SENATOR A (29_): 2.0 E 03.1983/10.1984 85KW 115CV 1979CC - OPEL SENATOR A (29_): 2.2 E 11.1984/08.1987 85KW 115CV 2197CC - OPEL SENATOR A (29_): 2.2 E 11.1984/08.1987 85KW 115CV 2197CC - OPEL SENATOR A (29_): 2.5 05.1978/12.1980 85KW 115CV 2490CC - OPEL SENATOR A (29_): 2.5 05.1978/12.1980 85KW 115CV 2490CC - OPEL SENATOR A (29_): ...</p> <p>d85x80mm 1f-d61mm 1f-d23mm</p>		<p>F1650A-I NO. 1604252 - 1604300 - 90510398</p> <p>FOLE DA TRANSMISSÃO JUNTO À CAIXA</p> <p>OPEL OMEGA A 2.0i - 2.3 TD - 2.3 TD iC - 2.4i - 2.6i - 3.0 - 3.024V - (1986 A 1994)</p> <p>d110x125mm 1f-d108mm 1f-d25mm</p>

	<p>F1650A-I NO. 1604252 - 1604300 - 90510398</p> <p>FOLE DA TRANSMISSÃO JUNTO À CAIXA</p> <p>OPEL OMEGA B 2.2 DTi 16V - 2.2i 16V - 2.5 DTi - 2.5 TD - 2.6i V6 - 3.0i V6 - 3.2i V6 (1994 A 2003)</p> <p>d110x125mm 1f-d108mm 1f-d25mm</p>		<p>KL80449 NO. 198283 - 607813 - 90412865</p> <p>KIT CASQUILHOS COBERTURA TAMPA MOTOR</p> <p>OPEL OMEGA B (V94): 3.0 V6 (F69, M69, P69) 04.1994/02.2001 155KW 211CV 2962CC - OPEL OMEGA B (V94): 3.2 V6 (F69, M69, P69) 02.2001/07.2003 160KW 218CV 3175CC - OPEL OMEGA B (V94): 2.0 DTi 16V (F69, M69, P69) 09.1997/09.2000 74KW 101CV 1995CC - OPEL OMEGA B (V94): 2.2 DTi 16V (F69, M69, P69) 09.2000/07.2003 81KW 110CV 2171CC - OPEL OMEGA B (V94): 2.2 DTi 16V (F69, M69, P69) 09.2000/07.2003 88KW 120...</p> <p>d16x10mm 1f-d6mm</p>
	<p>L3020 NO. 0856700 - 856700 - 9275758</p> <p>CASQUILHO DE ESCAPE</p> <p>OPEL OMEGA A (V87): 1.8 (F19, M19, N19) 09.1987/03.1994 65KW 88CV 1796CC - OPEL OMEGA A (V87): 1.8 S (F19, M19, N19) 09.1986/03.1994 66KW 90CV 1796CC - OPEL OMEGA A (V87): 1.8 (F19, M19, N19) 09.1986/03.1994 85KW 115CV 1796CC - OPEL OMEGA A (V87): 2.0 (F19, M19, N19) 09.1986/03.1994 90KW 122CV 1998CC - OPEL OMEGA A (V87): 2.3 D (F19, M19, N19) 10.1986/03.1994 54KW 73CV 2260CC - OPEL OMEGA A (V87):...</p> <p>d29x12mm d26/di19x8mm 1f-d9mm</p>		<p>L3182 NO. 0444325 - 0444326 - 0444336 - 0444348 - 444325 - 444336 - 444348 - 6655341 - 8971400891 - 90343305 - ...</p> <p>CASQUILHO DA BARRA ESTABILIZADORA DE TRÁS</p> <p>OPEL OMEGA A</p> <p>d26x28mm d24mm 1f-d13mm</p>
	<p>L3182 NO. 0444325 - 0444326 - 0444336 - 0444348 - 444325 - 444336 - 444348 - 6655341 - 8971400891 - 90343305 - ...</p> <p>CASQUILHO DA BARRA ESTABILIZADORA DE TRÁS</p> <p>OPEL SENATOR</p> <p>d26x28mm d24mm 1f-d13mm</p>		<p>M6045 NO. 854936 - 90231063</p> <p>JUNTA DE ESCAPE</p> <p>OPEL OMEGA A (1986 A 1994)</p> <p>95x92mm 1f-d55mm</p>
	<p>M6068 NO. 0852800 - 0852801 - 174510R030 - 21101206057 - 52005431 - 6616585 - 6616985 - 6688869 - 6745091 - 82...</p> <p>JUNTA DE ESCAPE</p> <p>OPEL OMEGA A TURBO DIESEL (1986 A 1994)</p> <p>d71x13mm 1f-d56mm</p>		<p>R220346 NO. 1336444 - 90271848 - 90280628</p> <p>TUBO INFERIOR DO RADIADOR LADO ESQUERDO</p> <p>OPEL OMEGA A (V87) 1.8 (F19, M19, N19) 09.1986/03.1994 85KW 115CV 1796CC 18 SEH 0039677 - OPEL OMEGA A (V87) 1.8 (F19, M19, N19) 09.1987/03.1994 65KW 88CV 1796CC E 18 NVR 0039760 - OPEL OMEGA A (V87) 1.8 N (F19, M19, N19) 09.1986/08.1987 60KW 82CV 1796CC 18 NV 0039675 - OPEL OMEGA A (V87) 1.8 N (F19, M19, N19) 11.1986/09.1988 63KW 86CV 1796CC 18 SV - OPEL OMEGA A (V87) 1.8 S (F19, M19, N19) 09.198...</p> <p>B610-d30/d31mm 64-98-69-250-90-61mm</p>
	<p>R220346 NO. 1336444 - 90271848 - 90280628 - 0857564600 - 0857730000 - 7700697815 - 8575646 - 8577300 - 770056043...</p> <p>TUBO INFERIOR DO RADIADOR LADO ESQUERDO</p> <p>OPEL OMEGA A Combi (V87) 1.8 (F35, M35) 09.1986/03.1994 85KW 115CV 1796CC 18 SEH 0039684 - OPEL OMEGA A Combi (V87) 1.8 (F35, M35) 09.1987/03.1994 65KW 88CV 1796CC E 18 NVR 0039763 - OPEL OMEGA A Combi (V87) 1.8 N (F35, M35) 09.1986/08.1987 60KW 82CV 1796CC 18 NV 0039682 - OPEL OMEGA A Combi (V87) 1.8 N (F35, M35) 11.1986/09.1988 63KW 86CV 1796CC 18 SV - OPEL OMEGA A Combi (V87) 1.8 S (F35, M35) 0...</p> <p>B610-d30/d31mm 64-98-69-250-90-61mm</p>		<p>S2066 NO. 920361</p> <p>SILENT-BLOC DO PENDURAL DA DIREÇÃO</p> <p>OPEL OMEGA A (V87) 1.8 (F19, M19, N19) (De 09.1987 Até 03.1994) 65KW 88cv 1796cm3 três volumes - OPEL OMEGA A (V87) 1.8 (F19, M19, N19) (De 09.1986 Até 03.1994) 85KW 115cv 1796cm3 três volumes - OPEL OMEGA A (V87) 1.8 N (F19, M19, N19) (De 09.1986 Até 08.1987) 60KW 82cv 1796cm3 três volumes - OPEL OMEGA A (V87) 1.8 S (F19, M19, N19) (De 09.1986 Até 03.1994) 66KW 90cv 1796cm3 três volumes - OPEL OM...</p> <p>d38x 61mm c-48mm dc-30mm1f-d18mm</p>
	<p>S2066 NO. 920361</p> <p>SILENT-BLOC DO PENDURAL DA DIREÇÃO</p> <p>OPEL OMEGA B (V94) 2.0 (F69, M69, P69) (De 03.1994 Até 12.2000) 85KW 115cv 1998cm3 três volumes - OPEL OMEGA B (V94) 2.0 (F69, M69, P69) (De 03.1994 Até 09.1999) 85KW 116cv 1998cm3 três volumes - OPEL OMEGA B (V94) 2.0 16V (F69, M69, P69) (De 03.1994 Até 09.1999) 100KW 136cv 1998cm3 três volumes - OPEL OMEGA B (V94) 2.0 DTi 16V (F69, M69, P69) (De 09.1997 Até 09.2000) 74KW 101cv 1995cm3 três volum...</p> <p>d38x 61mm c-48mm dc-30mm1f-d18mm</p>		<p>S2066 NO. 920361</p> <p>SILENT-BLOC DO PENDURAL DA DIREÇÃO</p> <p>OPEL SENATOR B (V88) 2.6 i (P19) (De 09.1990 Até 09.1993) 110KW 150cv 2594cm3 três volumes - OPEL SENATOR B (V88) 3.0 (P19) (De 09.1987 Até 09.1993) 115KW 156cv 2969cm3 três volumes - OPEL SENATOR B (V88) 3.0 (P19) (De 01.1988 Até 09.1990) 130KW 177cv 2969cm3 três volumes - OPEL SENATOR B (V88) 3.0 24V (P19) (De 09.1989 Até 09.1993) 150KW 204cv 2969cm3 três volumes - OPEL SENATOR B (V88) 3.0 i Cat...</p> <p>d38x 61mm c-48mm dc-30mm1f-d18mm</p>
	<p>S2103 NO. 0402935 - 402935 - 90250986</p> <p>SILENT-BLOC DO EIXO SUSPENSÃO TRÁS</p> <p>OPEL OMEGA A (V87) 1.8 (F19, M19, N19) 09.1986/03.1994 85KW 115CV 1796CC 18 SEH 0039677 - OPEL OMEGA A (V87) 1.8 (F19, M19, N19) 09.1987/03.1994 65KW 88CV 1796CC E 18 NVR 0039760 - OPEL OMEGA A (V87) 1.8 N (F19, M19, N19) 09.1986/08.1987 60KW 82CV 1796CC 18 NV 0039675 - OPEL OMEGA A (V87) 1.8 N (F19, M19, N19) 11.1986/09.1988 63KW 86CV 1796CC 18 SV - OPEL OMEGA A (V87) 1.8 S (F19, M19, N19) 09.198...</p> <p>d121x80mm c46mm d96mm 1f-d18mm</p>		<p>UAP81292 NO. 0821038 - 0821074 - 0821437 - 0821675 - 4708869 - 4809347 - 821038 - 821074 - 821437 - 821675</p> <p>ANILHA PROTEÇÃO TÉRMICA INJECTORES</p> <p>OPEL OMEGA B (V94) 2.0 DTi 16V (F69 - M69 - P69) (De 09-1997 Até 09-2000) 74KW 101CV 1995cc três volumes OPEL OMEGA B (V94) 2.2 DTi 16V (F69 - M69 - P69) (De 09-2000 Até 07-2003) 81KW 110CV 2172cc três volumes OPEL OMEGA B (V94) 2.2 DTi 16V (F69 - M69 - P69) (De 09-2000 Até 07-2003) 88KW 120CV 2172cc três volumes OPEL OMEGA B Combi (V94) 2.0 DTi 16V (F35 - M35 - P35) (De 09-1997 Até 09-2000) 74...</p> <p>d16x1mm 1f-d7mm</p>
	<p>UAP81292 NO. 0821038 - 0821074 - 0821437 - 0821675 - 4708869 - 4809347 - 821038 - 821074 - 821437 - 821675</p> <p>ANILHA PROTEÇÃO TÉRMICA INJECTORES</p> <p>OPEL OMEGA B (V94) 2.0 DTi 16V (F69 - M69 - P69) (De 09-1997 Até 09-2000) 74KW 101CV 1995cc três volumes OPEL OMEGA B (V94) 2.2 DTi 16V (F69 - M69 - P69) (De 09-2000 Até 07-2003) 81KW 110CV 2172cc três volumes OPEL OMEGA B (V94) 2.2 DTi 16V (F69 - M69 - P69) (De 09-2000 Até 07-2003) 88KW 120CV 2172cc três volumes OPEL OMEGA B Combi (V94) 2.0 DTi 16V (F35 - M35 - P35) (De 09-1997 Até 09-2000) 74...</p> <p>d16x1mm 1f-d7mm</p>		<p>UMB84011 NO. 031126</p> <p>TAMPÃO BLOCO MOTOR</p> <p>OPEL OMEGA A (V87) 1.8 N (F19 - M19 - N19) (De 09-1986 Até 08-1987) 60KW 82CV 1796cc três volumes OPEL OMEGA A (V87) 1.8 S (F19 - M19 - N19) (De 09-1986 Até 03-1994) 66KW 90CV 1796cc três volumes OPEL OMEGA A (V87) 1.8 (F19 - M19 - N19) (De 09-1986 Até 03-1994) 85KW 115CV 1796cc três volumes OPEL OMEGA A (V87) 2.0 i (F19 - M19 - N19) (De 09-1986 Até 03-1994) 85KW 115CV 1998cc três volumes OPEL...</p> <p>d-18x8mm di-16mm</p>

	<p>UMB84011L NO. 11062402 - 2060675</p> <p>TAMPÃO BLOCO DE MOTOR (RELAS)</p> <p>OPEL OMEGA A (V87) 1.8 N (F19 - M19 - N19) (De 09-1986 Até 08-1987) 60kW 82CV 1796cc três volumes OPEL OMEGA A (V87) 1.8 S (F19 - M19 - N19) (De 09-1986 Até 03-1994) 66kW 90CV 1796cc três volumes OPEL OMEGA A (V87) 1.8 (F19 - M19 - N19) (De 09-1986 Até 03-1994) 85kW 115CV 1796cc três volumes OPEL OMEGA A (V87) 2.0 i (F19 - M19 - N19) (De 09-1986 Até 03-1994) 85kW 115CV 1998cc três volumes OPEL OME...</p> <p>d-18x8mm di-16mm</p>		<p>UMB84011L NO. 11062402 - 2060675</p> <p>TAMPÃO BLOCO DE MOTOR (RELAS)</p> <p>OPEL SENATOR B (V88) 3.0 24V (P19) (De 09-1989 Até 09-1993) 150kW 204CV 2969cc três volumes</p> <p>d-18x8mm di-16mm</p>
	<p>UMB84019 NO. 2060668</p> <p>TAMPÃO BLOCO MOTOR</p> <p>OPEL OMEGA A (V87) 1.8 N (F19 - M19 - N19) (De 09-1986 Até 08-1987) 60kW 82CV 1796cc três volumes OPEL OMEGA A (V87) 1.8 (F19 - M19 - N19) (De 09-1987 Até 03-1994) 65kW 88CV 1796cc três volumes OPEL OMEGA A (V87) 1.8 S (F19 - M19 - N19) (De 09-1986 Até 03-1994) 66kW 90CV 1796cc três volumes OPEL OMEGA A (V87) 1.8 (F19 - M19 - N19) (De 09-1986 Até 03-1994) 85kW 115CV 1796cc três volumes OPEL OM...</p> <p>d-26x9,5mm di-23,3mm</p>		<p>UMB84019L NO. 2060668</p> <p>TAMPÃO BLOCO DE MOTOR (RELAS)</p> <p>OPEL OMEGA A (V87) 1.8 N (F19 - M19 - N19) (De 09-1986 Até 08-1987) 60kW 82CV 1796cc três volumes OPEL OMEGA A (V87) 1.8 (F19 - M19 - N19) (De 09-1987 Até 03-1994) 65kW 88CV 1796cc três volumes OPEL OMEGA A (V87) 1.8 S (F19 - M19 - N19) (De 09-1986 Até 03-1994) 66kW 90CV 1796cc três volumes OPEL OMEGA A (V87) 1.8 (F19 - M19 - N19) (De 09-1986 Até 03-1994) 85kW 115CV 1796cc três volumes OPEL OMEGA ...</p> <p>d-26x9,5mm di-23,3mm</p>
	<p>UMB84019L NO. 2060668</p> <p>TAMPÃO BLOCO DE MOTOR (RELAS)</p> <p>OPEL SENATOR B (V88) 3.0 24V (P19) (De 09-1989 Até 09-1993) 150kW 204CV 2969cc três volumes</p> <p>d-26x9,5mm di-23,3mm</p>		<p>UMB84021 NO. 2060673</p> <p>TAMPÃO BLOCO MOTOR</p> <p>OPEL OMEGA A (V87) 1.8 N (F19 - M19 - N19) (De 09-1986 Até 08-1987) 60kW 82CV 1796cc três volumes OPEL OMEGA A (V87) 1.8 (F19 - M19 - N19) (De 09-1987 Até 03-1994) 65kW 88CV 1796cc três volumes OPEL OMEGA A (V87) 1.8 S (F19 - M19 - N19) (De 09-1986 Até 03-1994) 66kW 90CV 1796cc três volumes OPEL OMEGA A (V87) 1.8 (F19 - M19 - N19) (De 09-1986 Até 03-1994) 85kW 115CV 1796cc três volumes OPEL OM...</p> <p>d-28x7mm di-25,6mm</p>
	<p>UMB84021L NO. 2060673</p> <p>TAMPÃO BLOCO DE MOTOR (RELAS)</p> <p>OPEL OMEGA A (V87) 1.8 N (F19 - M19 - N19) (De 09-1986 Até 08-1987) 60kW 82CV 1796cc três volumes OPEL OMEGA A (V87) 1.8 (F19 - M19 - N19) (De 09-1987 Até 03-1994) 65kW 88CV 1796cc três volumes OPEL OMEGA A (V87) 1.8 S (F19 - M19 - N19) (De 09-1986 Até 03-1994) 66kW 90CV 1796cc três volumes OPEL OMEGA A (V87) 1.8 (F19 - M19 - N19) (De 09-1986 Até 03-1994) 85kW 115CV 1796cc três volumes OPEL OMEGA ...</p> <p>d-28x7mm di-25,6mm</p>		<p>UMB84029 NO. 2060946</p> <p>TAMPÃO BLOCO MOTOR</p> <p>OPEL OMEGA A (V87) 1.8 N (F19, M19, N19) (09.86 A 08.87) 82cv 1796cc três volumes - OPEL OMEGA A Combi (V87) 2.3 TD Interc. (F35, M35) (09.88 A 03.94) 100cv 2260cc Combi</p> <p>d36x10mm di-32mm</p>
	<p>UMB84029 NO. 2060946</p> <p>TAMPÃO BLOCO MOTOR</p> <p>OPEL OMEGA B (V94) 2.0 (F69, M69, P69) (03.94 A 12.00) 115cv 1998cc três volumes - OPEL OMEGA B Combi (V94) 2.2 16V (F35, M35, P35) (09.99 A 07.03) 144cv 2198cc Combi</p> <p>d36x10mm di-32mm</p>		<p>UMB84029 NO. 2060946</p> <p>TAMPÃO BLOCO MOTOR</p> <p>OPEL SENATOR B (V88) 2.5 i (P19) (09.90 A 09.93) 140cv 2490cc três volumes - OPEL SENATOR B (V88) 3.0 24V (P19) (09.89 A 09.93) 204cv 2969cc três volumes</p> <p>d36x10mm di-32mm</p>
	<p>UTR0800 NO. 1304654 - 1304659 - 1304660 - 1304661 - 1304665 - 1304666 - 1304667 - 1304853 - 60507797 - 90352470 ...</p> <p>TAMPÃO RESERVATÓRIO LIQUIDO REFRIGERAÇÃO</p> <p>OPEL OMEGA A (V87) 2.4 i 09.88 - 03.94 92 125 2410 três volumes OPEL OMEGA A (V87) 2.6 i 09.90 - 03.94 110 150 2594 três volumes OPEL OMEGA A (V87) 3.0 (3000) 03.87 - 12.87 115 156 2969 três volumes OPEL OMEGA A (V87) 3.0 (3000) 03.87 - 09.90 130 177 2969 três volumes OPEL OMEGA A (V87) 3.0 (3000) Cat 03.88 - 03.94 130 177 2969 três volumes OPEL OMEGA A (V87) 3.0 24V (3000) 09.89 - 03.94 150 204 2...</p> <p>d62x25mm 1f-d53x14mm</p>		<p>UTR0811 NO. 1304660 - 1304661 - 1304665 - 1304666 - 1304853 - 4395513 - 90352470 - 90409256 - 90409257 - 9041032...</p> <p>TAMPÃO RESERVATÓRIO LIQUIDO REFRIGERAÇÃO</p> <p>OPEL OMEGA A 1.8 N (09.86 A 08.87) 82cv 1796cc três volumes - OPEL OMEGA A 1.8 (09.87 A 03.94) 88cv 1796cc três volumes - OPEL OMEGA A 1.8 S (09.86 A 03.94) 90cv 1796cc três volumes - OPEL OMEGA A 1.8 (09.86 A 03.94) 115cv 1796cc três volumes - OPEL OMEGA A 2.0 i E (09.86 A 03.94) 115cv 1998cc três volumes - OPEL OMEGA A 2.0 E (09.86 A 03.94) 122cv 1998cc três volumes - OPEL OMEGA A 2...</p> <p>60x25mm 1f-d52x14mm</p>
	<p>UTR0820 NO. 90352470 - 90409256 - 90409257 - 9041032690497472 - 90467473</p> <p>TAMPÃO RESERVATÓRIO LIQUIDO REFRIGERAÇÃO</p> <p>OPEL OMEGA A (16_, 17_, 19_) 1.8 N (09.86 A 08.87) 82cv 1796cc três volumes - OPEL OMEGA A (16_, 17_, 19_) 1.8 N (11.86 A 09.88) 88cv 1796cc três volumes - OPEL OMEGA A (16_, 17_, 19_) 1.8 (09.87 A 03.94) 88cv 1796cc três volumes - OPEL OMEGA A (16_, 17_, 19_) 1.8 S (09.86 A 03.94) 90cv 1796cc três volumes - OPEL OMEGA A (16_, 17_, 19_) 1.8 (09.86 A 03.94) 90cv 1796cc três volumes - OPEL OMEGA A (16_, 17_, 19_) 1.8 (09.86 A 03.94) 115cv 1796cc três volumes - OPE...</p> <p>d62x23mm 1f-d53x12mm</p>		<p>UTR0859 NO. 1650630 - 94539597 - 96293957 - 96312510 - 96351578 - 96420303 - 96536649</p> <p>TAMPÃO RESERVATÓRIO LIQUIDO REFRIGERAÇÃO</p> <p>OPEL OMEGA A (V 8 7) 1.8 N (09.86 A 08.87) 82cv 1796cc três volumes - OPEL OMEGA A (V 8 7) 1.8 (09.87 A 03.94) 88cv 1796cc três volumes - OPEL OMEGA A (V 8 7) 1.8 S (09.86 A 03.94) 90cv 1796cc três volumes - OPEL OMEGA A (V 8 7) 1.8 (09.86 A 03.94) 115cv 1796cc três volumes - OPEL OMEGA A (V 8 7) 2.0 i (09.86 A 03.94) 115cv 1998cc três volumes - OPEL OMEGA A (V 8 7) 2.0 (09.86 A 2...</p> <p>d63x23mm 1f-d53x11mm</p>
	<p>UTR0890 NO. 92067202</p> <p>TAMPÃO RESERVATÓRIO LIQUIDO REFRIGERAÇÃO</p> <p>OPEL OMEGA 3.6 V6 (2005 A 2006)</p> <p>d63x40mm d52x15mm 1p-d39x32mm</p>		<p>UTR0890 NO. 92067202</p> <p>TAMPÃO RESERVATÓRIO LIQUIDO REFRIGERAÇÃO</p> <p>OPEL OMEGA 3.6 V6 (2005 A 2006)</p> <p>d63x40mm d52x15mm 1p-d39x32mm</p>

	<p>UTR0895 NO. 1306C7</p> <p>TAMPÃO RESERVATÓRIO LIQUIDO REFRIGERAÇÃO</p> <p>OPEL OMEGA B (V94) 2.2 DTI 16V (De 2000.09 Até 2003.07) 81kW 110cv 2172cm3 três volumes -</p> <p>d78/59x29mm d38x25mm</p>		<p>UTR1300 NO. 00650090 - 05650831</p> <p>TAMPÃO RESERVATÓRIO DO OLEO</p> <p>OPEL OMEGA B (V94) 2.5 V6 (F69 - M69 - P69) (De 03-1994 Até 09-2000) 125kW 170CV 2498cc três volumes</p> <p>d59x31mm d45x12mm</p>
	<p>UTR1305 NO. 0650089 - 650089</p> <p>TAMPÃO DO RESERVATÓRIO ÓLEO</p> <p>OPEL OMEGA A (V87) 1.8 (F19, M19, N19) (09.1987 -03.1994) 65kw 88cv 1796cm3 três volumes OPEL OMEGA A (V87) 1.8 (F19, M19, N19) (09.1986 -03.1994) 85kw 115cv 1796cm3 três volumes OPEL OMEGA A (V87) 1.8 N (F19, M19, N19) (09.1986 -08.1987) 60kw 82cv 1796cm3 três volumes OPEL OMEGA A (V87) 1.8 S (F19, M19, N19) (09.1986 -03.1994) 66kw 90cv 1796cm3 três volumes OPEL OMEGA A (V87) 2.0 (F19, M19, N19) ...</p> <p>d61x23mm d32x19mm</p>		<p>UTR1305 NO. 0650089 - 650089</p> <p>TAMPÃO DO RESERVATÓRIO ÓLEO</p> <p>OPEL OMEGA A Combi (V87) 1.8 (F35, M35) (09.1987 -03.1994) 65kw 88cv 1796cm3 Combi OPEL OMEGA A Combi (V87) 1.8 (F35, M35) (09.1986 -03.1994) 85kw 115cv 1796cm3 Combi OPEL OMEGA A Combi (V87) 1.8 N (F35, M35) (09.1986 -08.1987) 60kw 82cv 1796cm3 Combi OPEL OMEGA A Combi (V87) 1.8 S (F35, M35) (09.1986 -03.1994) 66kw 90cv 1796cm3 Combi OPEL OMEGA A Combi (V87) 2.0 (F35, M35) (09.1987 -04.1994) 85kw...</p> <p>d61x23mm d32x19mm</p>
	<p>UTR1305 NO. 0650089 - 650089</p> <p>TAMPÃO DO RESERVATÓRIO ÓLEO</p> <p>OPEL OMEGA B (V94) 2.0 (F69, M69, P69) (03.1994 -09.1999) 85kw 116 1998 três volumes OPEL OMEGA B (V94) 2.0 16V (F69, M69, P69) (03.1994 -09.1999) 100kw 136 1998 três volumes OPEL OMEGA B (V94) 2.0 DTI 16V (F69, M69, P69) (09.1997 -09.2000) 74kw 101cv 1995cm3 três volumes OPEL OMEGA B (V94) 2.2 16V (F69, M69, P69) (09.1999 -07.2003) 106kw 144cv 2198cm3 três volumes OPEL OMEGA B (V94) 2.2 DTI 16V (...)</p> <p>d61x23mm d32x19mm</p>		<p>UTR1305 NO. 0650089 - 650089</p> <p>TAMPÃO DO RESERVATÓRIO ÓLEO</p> <p>OPEL OMEGA B Combi (V94) 2.0 (F35, M35, P35) (03.1994 -09.1999) 85kw 116cv 1998cm3 Combi OPEL OMEGA B Combi (V94) 2.0 16V (F35, M35, P35) (03.1994 -09.1999) 100kw 136cv 1998cm3 Combi OPEL OMEGA B Combi (V94) 2.0 DTI 16V (F35, M35, P35) (09.1997 -09.2000) 74kw 101cv 1995cm3 Combi OPEL OMEGA B Combi (V94) 2.2 16V (F35, M35, P35) (09.1999 -07.2003) 106kw 144cv 2198cm3 Combi OPEL OMEGA B Combi (V94) 2...</p> <p>d61x23mm d32x19mm</p>
	<p>UTR1305 NO. 0650089 - 650089</p> <p>TAMPÃO DO RESERVATÓRIO ÓLEO</p> <p>OPEL SENATOR B (V88) 2.5 i (P19) (09.1990 -09.1993) 103kw 140cv 2490cm3 três volumes OPEL SENATOR B (V88) 2.6 i (P19) (09.1990 -09.1993) 110kw 150cv 2594cm3 três volumes OPEL SENATOR B (V88) 3.0 (P19) (09.1987 -09.1993) 115kw 156cv 2969cm3 três volumes OPEL SENATOR B (V88) 3.0 (P19) (01.1988 -09.1990) 130kw 177cv 2969cm3 três volumes OPEL SENATOR B (V88) 3.0 24V (P19) (09.1989 -09.1993) 150kw 204c...</p> <p>d61x23mm d32x19mm</p>		<p>UTV83011 NO. 0652475 - 09275631 - 652475 - 652491 - 90409376 - 9275631 - N90288901</p> <p>TAMPÃO VEDAÇÃO BUJÃO</p> <p>OPEL OMEGA A (V87) 1.8 N (F19 - M19 - N19) (De 09-1986 Até 08-1987) 60kW 82CV 1796cc três volumes OPEL OMEGA A (V87) 1.8 (F19 - M19 - N19) (De 09-1987 Até 03-1994) 65kW 88CV 1796cc três volumes OPEL OMEGA A (V87) 1.8 S (F19 - M19 - N19) (De 09-1986 Até 03-1994) 66kW 90CV 1796cc três volumes OPEL OMEGA A (V87) 1.8 (F19 - M19 - N19) (De 09-1986 Até 03-1994) 85kW 115CV 1796cc três volumes OPEL OMEGA ...</p> <p>19x18mm c12mm d14mm</p>
	<p>UTV83011 NO. 0652475 - 09275631 - 652475 - 652491 - 90409376 - 9275631 - N90288901</p> <p>TAMPÃO VEDAÇÃO BUJÃO</p> <p>OPEL OMEGA B (V94) 2.0 (F69 - M69 - P69) (De 03-1994 Até 12-2000) 85kW 115CV 1998cc três volumes OPEL OMEGA B (V94) 2.0 (F69 - M69 - P69) (De 03-1994 Até 09-1999) 85kW 116CV 1998cc três volumes OPEL OMEGA B (V94) 2.0 16V (F69 - M69 - P69) (De 03-1994 Até 09-1999) 100kW 136CV 1998cc três volumes OPEL OMEGA B (V94) 2.5 V6 (F69 - M69 - P69) (De 03-1994 Até 09-2000) 125kW 170CV 2498cc três volumes ...</p> <p>19x18mm c12mm d14mm</p>		<p>UTV83011 NO. 0652475 - 09275631 - 652475 - 652491 - 90409376 - 9275631 - N90288901</p> <p>TAMPÃO VEDAÇÃO BUJÃO</p> <p>OPEL SENATOR B (V88) 2.5 i (P19) (De 09-1990 Até 09-1993) 103kW 140CV 2490cc três volumes OPEL SENATOR B (V88) 2.6 i (P19) (De 09-1990 Até 09-1993) 110kW 150CV 2594cc três volumes OPEL SENATOR B (V88) 3.0 (P19) (De 09-1987 Até 09-1993) 115kW 156CV 2969cc três volumes OPEL SENATOR B (V88) 3.0 (P19) (De 01-1988 Até 09-1990) 130kW 177CV 2969cc três volumes OPEL SENATOR B (V88) 3.0 i Cat (P19) (De...</p> <p>19x18mm c12mm d14mm</p>
	<p>UTV83019 NO. 0652315 - 0652477 - 652315 - 652477 - 90502556 - 96023264</p> <p>TAMPÃO VEDAÇÃO BUJÃO</p> <p>OPEL OMEGA B (V94) 2.0 16V (F69 - M69 - P69) (De 03-1994 Até 09-1999) 100kW 136CV 1998cc três volumes OPEL OMEGA B (V94) 2.2 16V (F69 - M69 - P69) (De 09-1999 Até 07-2003) 106kW 144CV 2198cc três volumes OPEL OMEGA B (V94) 2.5 V6 (F69 - M69 - P69) (De 03-1994 Até 09-2000) 125kW 170CV 2498cc três volumes OPEL OMEGA B (V94) 2.6 V6 (F69 - M69 - P69) (De 09-2000 Até 07-2003) 132kW 180CV 2597cc três...</p> <p>d25x14mm c9mm d13mm</p>		<p>W5034 NO. 614654</p> <p>POLIE DA CAMBOTA (6 PISTAS)</p> <p>OPEL OMEGA 2.0 16v CD-BVA CD</p> <p>d138mm d42mm</p>
	<p>W5047 NO. 0614610 - 0614612 - 614610 - 614612 - 90487878 - 90541669</p> <p>POLIE DA CAMBOTA (5 PISTAS)</p> <p>OPEL OMEGA B (V94): 2.5 TD (F69, M69, P69) 04.1994/07.2003 96KW 130CV 2498CC - OPEL OMEGA B Combi (V94): 2.5 TD (F35, M35, P35) 04.1994/07.2001 96KW 131CV 2498CC</p> <p>d157/205mm d45mm</p>		<p>W5051 NO. 0614411 - 09128177 - 09544461 - 55351711 - 5535171169 - 5614415 - 5614437 - 614411 - 614444 - 9...</p> <p>POLIE DA CAMBOTA (6 PISTAS)</p> <p>OPEL OMEGA B (V94) 2.0 DTI 16V (F69, M69, P69) 09.1997/09.2000 74KW 101CV 1995CC X 20 DTH 0035340 - OPEL OMEGA B (V94) 2.2 DTI 16V (F69, M69, P69) 09.2000/07.2003 81KW 110CV 2171CC Y 22 DTH 0035417 - OPEL OMEGA B (V94) 2.2 DTI 16V (F69, M69, P69) 09.2000/07.2003 88KW 120CV 2171CC Y 22 DTH 0035415 - OPEL OMEGA B Combi (V94) 2.0 DTI 16V (F35, M35, P35) 09.1997/09.2000 74KW 101CV 1995CC X 20 DTH 0035...</p> <p>d153mm d35mm</p>
	<p>W5069 NO. 614654</p> <p>POLIE DA CAMBOTA (6 PISTAS)</p> <p>OPEL OMEGA B 2.0 - 2.0 16v - 2.2 16v - 2.2 Dti 16v</p> <p>d140/141mm d42mm</p>		<p>Y3000 NO. 854917 - 854977 - 854980 - 90128081</p> <p>PARAFUSO MOLA DE ESCAPE</p> <p>OPEL OMEGA A (1986 A 1994)</p> <p>82x13mm 1p-d10-20mm</p>

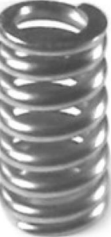
	Y3212	NO. 1008501 - 1008504 - 4709077		Y3212	NO. 1008501 - 1008504 - 4709077
	<p>PARAFUSO PERNO RODA CHAVE 17 M12X1,50X48MM (BASE CONICA PARA JANTES AÇO E LIGA LEVE)</p> <p>OPEL OMEGA A (V87) 1.8 (F19, M19, N19) (09.1987 - 03.1994) 65kw 88cv 1796cm3 três volumes OPEL OMEGA A (V87) 1.8 (F19, M19, N19) (09.1986 - 03.1994) 85kw 115cv 1796cm3 três volumes OPEL OMEGA A (V87) 1.8 N (F19, M19, N19) (09.1986 - 08.1987) 60kw 82cv 1796cm3 três volumes OPEL OMEGA A (V87) 1.8 S (F19, M19, N19) (09.1986 - 03.1994) 66kw 90cv 1796cm3 três volumes OPEL OMEGA A (V87) 2.0 (F19, M19, N...</p>			<p>PARAFUSO PERNO RODA CHAVE 17 M12X1,50X48MM (BASE CONICA PARA JANTES AÇO E LIGA LEVE)</p> <p>OPEL OMEGA B (V94) 2.0 (F69, M69, P69) (03.1994 - 12.2000) 85kw 115cv 1998cm3 três volumes OPEL OMEGA B (V94) 2.0 (F69, M69, P69) (03.1994 - 09.1999) 85kw 116cv 1998cm3 três volumes OPEL OMEGA B (V94) 2.0 16V (F69, M69, P69) (03.1994 - 09.1999) 100kw 136cv 1998cm3 três volumes OPEL OMEGA B (V94) 2.0 DTI 16V (F69, M69, P69) (09.1997 - 09.2000) 74kw 101cv 1995cm3 três volumes OPEL OMEGA B (V94) 2.2 ...</p>	
C48mm (Ch-17mm)		M12x1,50x22mm	C48mm (Ch-17mm)		M12x1,50x22mm
	Y3212	NO. 1008501 - 1008504 - 4709077		Z55254	NO. 2317703
	<p>PARAFUSO PERNO RODA CHAVE 17 M12X1,50X48MM (BASE CONICA PARA JANTES AÇO E LIGA LEVE)</p> <p>OPEL SENATOR B (V88) 2.5 i (P19) (09.1990 - 09.1993) 103kw 140cv 2490cm3 três volumes OPEL SENATOR B (V88) 2.6 i (P19) (09.1990 - 09.1993) 110kw 150cv 2594cm3 três volumes OPEL SENATOR B (V88) 3.0 (P19) (09.1987 - 09.1993) 115kw 156cv 2969cm3 três volumes OPEL SENATOR B (V88) 3.0 (P19) (01.1988 - 09.1990) 130kw 177cv 2969cm3 três volumes OPEL SENATOR B (V88) 3.0 24V (P19) (09.1989 - 09.1993) 150kw...</p>			<p>MOLA REBITE FIXAÇÃO</p> <p>OPEL OMEGA</p>	
C48mm (Ch-17mm)		M12x1,50x22mm	d5.5x 16mm		f-d11mm
	Z80540	NO. 2240861 - 90022049		Z80661	NO. 1218601 - 90181010
	<p>Mola de painel</p> <p>OPEL OMEGA</p>			<p>MOLA SUPORTE FAROL PRINCIPAL (GASTA 2 UNIDADES)</p> <p>OPEL OMEGA A (V87): 1.8 N (F19, M19, N19) 09.1986/08.1987 60KW 82CV 1796CC - OPEL OMEGA A (V87): 1.8 (F19, M19, N19) 09.1987/03.1994 65KW 88CV 1796CC - OPEL OMEGA A (V87): 1.8 S (F19, M19, N19) 09.1986/03.1994 66KW 90CV 1796CC - OPEL OMEGA A (V87): 1.8 (F19, M19, N19) 09.1986/03.1994 85KW 115CV 1796CC - OPEL OMEGA A (V87): 2.0 (F19, M19, N19) 09.1990/03.1994 73KW 99CV 1998CC - OPEL OMEGA A (V87): ...</p>	
d12x14.3mm		1p-d7-12.3mm	27.5x22x20mm		
	Z80745	NO. 51118174186		Z9000	NO. 25501711 - 854880 - 854881 - 854884 - 858884 - 90234204
	<p>Mola de fixação</p> <p>OPEL OMEGA</p>			<p>MOLA DE ESCAPE 42mm</p> <p>OPEL OMEGA A (1986 A 1992)</p>	
d15x44mm		1p-d6.5-20mm	d18x26mm		
	Z9011	NO. 1261479 - 1449282600 - 4709339 - 4711509 - 854880			
	<p>MOLA DE ESCAPE</p> <p>OPEL OMEGA</p>				
d23x42mm					

OPEL SIGNUM

	A2367	NO. 13112026 - 5684649		A2368	NO. 13183100 - 5684865
	<p>APOIO DO MOTOR PARTE DA FRENTE DIREITO</p> <p>OPEL SIGNUM Hatchback (Z03) 1.9 CDTI (F48) (De 08.2005 Até 02.2008) 74kW 100cv 1910cm3 Hatchback - OPEL SIGNUM Hatchback (Z03) 1.9 CDTI (F48) (De 04.2004 Até 02.2008) 88kW 120cv 1910cm3 Hatchback - OPEL SIGNUM Hatchback (Z03) 1.9 CDTI (F48) (De 04.2004 Até 02.2008) 110kW 150cv 1910cm3 Hatchback -</p>			<p>APOIO DO MOTOR LADO DIREITO</p> <p>OPEL SIGNUM Hatchback (Z03) 1.9 CDTI (F48) (De 08.2005 Até 02.2008) 74kW 100cv 1910cm3 Hatchback -</p>	
201x114x76mm		2f-d12mm 1f-d15mm	201x114x76mm		2f-d12mm 1f-d15mm
	A2369	NO. 13166642 - 13191586 - 13207585 - 5684650 - 5684661 - 5684689		A2370	NO. 09156933 - 5684166 - 9156933
	<p>APOIO DO MOTOR PARTE DA FRENTE ESQUERDO</p> <p>OPEL SIGNUM Hatchback (Z03) 1.9 CDTI (F48) (De 08.2005 Até 02.2008) 74kW 100cv 1910cm3 Hatchback - OPEL SIGNUM Hatchback (Z03) 1.9 CDTI (F48) (De 04.2004 Até 02.2008) 88kW 120cv 1910cm3 Hatchback - OPEL SIGNUM Hatchback (Z03) 1.9 CDTI (F48) (De 04.2004 Até 02.2008) 110kW 150cv 1910cm3 Hatchback -</p>			<p>APOIO DO MOTOR PARTE DE TRÁS EM BAIXO</p> <p>OPEL SIGNUM Hatchback (Z03) 1.9 CDTI (F48) (De 04.2004 Até 02.2008) 88kW 120cv 1910cm3 Hatchback - OPEL SIGNUM Hatchback (Z03) 1.9 CDTI (F48) (De 04.2004 Até 02.2008) 110kW 150cv 1910cm3 Hatchback - OPEL SIGNUM Hatchback (Z03) 2.0 DTI (F48) (De 05.2003 Até 04.2004) 74kW 100cv 1995cm3 Hatchback - OPEL SIGNUM Hatchback (Z03) 2.2 DTI (F48) (De 05.2003 Até 04.2004) 92kW 125cv 2172cm3 Hatchback -</p>	
165x122x151mm		4f-d6mm 3f-d13mm	195x103x76mm		2f-d10mm 1f-d12mm

	<p>A2635 NO. 13207586</p> <p>APOIO DO MOTOR FRENTE LADO ESQUERDO</p> <p>OPEL SIGNUM Hatchback (Z03) 2.2 DTI (F48) 05.2003/04.2004 92KW 125CV 2172CC Y 22 DTR 0035490 0035056 0035527</p> <p>168x125x171mm 4f-d9mm 3f-d16mm</p>		<p>A2693 NO. 13112029 - 5684143</p> <p>APOIO DO MOTOR PARTE DE TRÁS CAIXA AUTOMÁTICA</p> <p>OPEL SIGNUM Hatchback (Z03) 1.9 CDTI (F48) (04.2004 - 02.2008) 110kw 150cv 1910cm3 Hatchback</p> <p>228x132x118mm 1f-d6mm 3f-d12mm 1f-d16mm</p>
	<p>C0233 NO. 1160724 - 90054143</p> <p>BOTÃO AFINAÇÃO CAPÔT</p> <p>OPEL INSIGNIA 1.4 (A Partir de 04.11) 140cv 1364cc Hatchback - OPEL INSIGNIA 1.4 LPG (A Partir de 07.12) 140cv 1364cc Hatchback - OPEL INSIGNIA 1.6 (A Partir de 07.08) 116cv 1598cc Hatchback - OPEL INSIGNIA 1.6 SIDI (A Partir de 03.13) 170cv 1598cc Hatchback - OPEL INSIGNIA 1.6 Turbo (A Partir de 07.08) 180cv 1598cc Hatchback - OPEL INSIGNIA 1.8 (A Partir de 07.08) 140cv 1796cc Hatchback...</p> <p>d19x31mm</p>		<p>E1092 NO. 0852726 - 13276148 - 852577 - 852726 - 90466668</p> <p>ESTICADOR DE ESCAPE</p> <p>OPEL SIGNUM Hatchback (Z03): 1.8 (F48) 05.2003/07.2005 90KW 122CV 1796CC - OPEL SIGNUM Hatchback (Z03): 2.0 Turbo (F48) 05.2003/12.2008 129KW 175CV 1998CC - OPEL SIGNUM Hatchback (Z03): 2.8 V6 Turbo (F48) 09.2005/12.2008 169KW 230CV 2792CC - OPEL SIGNUM Hatchback (Z03): 2.8 V6 Turbo (F48) 01.2006/12.2008 184KW 250CV 2792CC - OPEL SIGNUM Hatchback (Z03): 3.2 V6 (F48) 05.2003/07.2005 155KW 211CV 317...</p> <p>55x40x35mm</p>
	<p>F1848-I NO. 1603104 - 1603183 - 1603238 - 374014 - 374319 - 374429 - 90543336</p> <p>FOLE DA TRANSMISSÃO JUNTO À CAIXA</p> <p>OPEL SIGNUM 1.8i 16v - 2.0 DTi 16v - 2.0i T 16v - 2.2 DTi 16v - 2.2i 16v - 3.0 CDTi V6 - 3.2i V6 (APÓS 2003)</p> <p>d95x100mm 1f-d65mm 1f-d24mm</p>		<p>F4141 NO. 5738393 - 5738939 - 93176450</p> <p>FOLE ALAVANCA VELOCIDADES</p> <p>OPEL SIGNUM Hatchback (Z03) 1.9 CDTI (F48) 04.2004/02.2008 88kw 120CV 1910CC Z 19 DT 0035ABE 0035058 0035531 - OPEL SIGNUM Hatchback (Z03) 2.2 DTI (F48) 05.2003/04.2004 92KW 125CV 2172CC Y 22 DTR 0035490 0035056 0035527</p> <p>165x144x180mm 1f-d35mm</p>
	<p>KF1686-T NO. 1603232</p> <p>KIT DE FOLE DO CARDAN JUNTO À RODA</p> <p>OPEL SIGNUM 2.0i T - 2.2 Dt i - 3.0 CDTi - 3.2i (APÓS 2003)</p> <p>d105x130mm 1f-d90mm 1f-d27mm</p>		<p>KF2362-T NO. 1603232 - 1603278 - 1603281 - 1603284 - 93182574</p> <p>KIT DE FOLE DO CARDAN JUNTO À RODA</p> <p>OPEL SIGNUM (APÓS 05-2003) 2.2 DTI</p> <p>d104x130mm 1f-d91mm 1f-d27mm</p>
	<p>KF9007H-I NO. 1603526 - 30788285 - 6G9N-4A084-DA</p> <p>KIT FOLE TRANSMISSÃO JUNTO À RODA</p> <p>OPEL SIGNUM Hatchback (Z03) 1.8 (F48) (De 09.2005 Até 12.2008) 103KW 140cv 1796cm3 Hatchback - OPEL SIGNUM Hatchback (Z03) 1.8 (F48) (De 05.2003 Até 07.2005) 90KW 122cv 1796cm3 Hatchback - OPEL SIGNUM Hatchback (Z03) 1.9 CDTI (F48) (De 08.2005 Até 02.2008) 74KW 100cv 1910cm3 Hatchback - OPEL SIGNUM Hatchback (Z03) 1.9 CDTI (F48) (De 04.2004 Até 02.2008) 88KW 120cv 1910cm3 Hatchback - OPEL SIGNUM H...</p> <p>d110x133mm 1f-d96mm 1f-d28mm</p>		<p>KL80449 NO. 198283 - 607813 - 90412865</p> <p>KIT CASQUILHOS COBERTURA TAMPA MOTOR</p> <p>OPEL SIGNUM Hatchback (Z03): 1.8 (F48) 05.2003/07.2005 90KW 122CV 1796CC - OPEL SIGNUM Hatchback (Z03): 1.9 CDTI (F48) 08.2005/02.2008 74KW 100CV 1910CC - OPEL SIGNUM Hatchback (Z03): 1.9 CDTI (F48) 04.2004/02.2008 88KW 120CV 1910CC - OPEL SIGNUM Hatchback (Z03): 2.0 DTI (F48) 05.2003/04.2004 74KW 100CV 1995CC - OPEL SIGNUM Hatchback (Z03): 2.2 DTI (F48) 05.2003/04.2004 92KW 125CV 2172CC - O...</p> <p>d16x10mm 1f-d6mm</p>
	<p>R221405 NO. 13119222 - 6336095</p> <p>TUBO SUPERIOR DO RADIADOR</p> <p>OPEL SIGNUM Hatchback (Z03) 1.9 CDTI (F48) (De 04.2004 Até 02.2008) 88KW 120cv 1910cm3 Hatchback - OPEL SIGNUM Hatchback (Z03) 1.9 CDTI (F48) (De 04.2004 Até 02.2008) 110KW 150cv 1910cm3 Hatchback</p> <p>B380-33/34mm 66x101x105x123mm</p>		<p>R225290 NO. 13289474 - 55352734 - 55354286 - 5860824 - 835037</p> <p>TUBO DO AR SOBREALIMENTAÇÃO</p> <p>OPEL SIGNUM Hatchback (Z03) 1.9 CDTI (F48) (De 08.2005 Até 02.2008) 74KW 100cv 1910cm3 Hatchback - OPEL SIGNUM Hatchback (Z03) 1.9 CDTI (F48) (De 04.2004 Até 02.2008) 88KW 120cv 1910cm3 Hatchback - OPEL SIGNUM Hatchback (Z03) 1.9 CDTI (F48) (De 04.2004 Até 02.2008) 110KW 150cv 1910cm3 Hatchback -</p> <p>B122-37/46mm 60x62mm</p>
	<p>RT80340 NO. 24436541 - 5562203</p> <p>TUBO DE TRAVÃO FRENTE LH - RH</p> <p>OPEL SIGNUM Hatchback (Z03) 1.8 (F48) (05.2003 - 07.2005) 90kw 122cv 1796cm3 Hatchback OPEL SIGNUM Hatchback (Z03) 1.9 CDTI (F48) (08.2005 - 02.2008) 74kw 100cv 1910cm3 Hatchback OPEL SIGNUM Hatchback (Z03) 1.9 CDTI (F48) (04.2004 - 02.2008) 88kw 120cv 1910cm3 Hatchback OPEL SIGNUM Hatchback (Z03) 1.9 CDTI (F48) (04.2004 - 02.2008) 110kw 150cv 1910cm3 Hatchback OPEL SIGNUM Hatchback (Z03) 2.0 DTI ...</p> <p>430x11mm 1r-d10mm 1f-d12mm</p>		<p>S1894 NO. 0423001 - 24417090</p> <p>SILENT-BLOC BRAÇO SUSPENSÃO SUPERIOR TRÁS PARTE INTERIOR</p> <p>OPEL SIGNUM Hatchback (Z03) 1.8 (F48) (De 09.2005 Até 12.2008) 103KW 140cv 1796cm3 Hatchback - OPEL SIGNUM Hatchback (Z03) 1.8 (F48) (De 05.2003 Até 07.2005) 90KW 122cv 1796cm3 Hatchback - OPEL SIGNUM Hatchback (Z03) 1.9 CDTI (F48) (De 08.2005 Até 02.2008) 74KW 100cv 1910cm3 Hatchback - OPEL SIGNUM Hatchback (Z03) 1.9 CDTI (F48) (De 04.2004 Até 02.2008) 88KW 120cv 1910cm3 Hatchback - OPEL SIGNUM Hatchback (Z03) 1.9 CDTI (F48) (De 04.2004 Até 02.2008) 110KW 150cv 1910cm3 Hatchback - OPEL SIGNUM H...</p> <p>d35x61mm c42mm 1f-d12mm</p>
	<p>T1180 NO. 0444160 - 0444163 - 444160 - 444163</p> <p>BATENTE DA BARRA ESTABILIZADORA DE TRÁS</p> <p>OPEL SIGNUM Hatchback (Z03) 1.8 (F48) (De 09-2005 Até 12-2008) 103KW 140CV 1796cc Hatchback OPEL SIGNUM Hatchback (Z03) 1.8 (F48) (De 05-2003 Até 07-2005) 90KW 122CV 1796cc Hatchback OPEL SIGNUM Hatchback (Z03) 2.0 Turbo (F48) (De 05-2003 Até 12-2008) 129KW 175CV 1998cc Hatchback OPEL SIGNUM Hatchback (Z03) 2.2 direct (F48) (De 05-2003 Até 09-2008) 114KW 155CV 2198cc Hatchback OPEL SIGNUM Hatchbac...</p> <p>38x38x37mm 1f-d16mm</p>		<p>T1217 NO. 0444161 - 444161</p> <p>BATENTE DA BARRA ESTABILIZADORA DE TRÁS</p> <p>OPEL SIGNUM Hatchback (Z03) 1.8 (F48) (De 2005.09 Até 2008.12) 103KW 140cv 1796cm3 Hatchback - OPEL SIGNUM Hatchback (Z03) 1.8 (F48) (De 2003.05 Até 2005.07) 90KW 122cv 1796cm3 Hatchback - OPEL SIGNUM Hatchback (Z03) 2.0 Turbo (F48) (De 2003.05 Até 2008.12) 129KW 175cv 1998cm3 Hatchback - OPEL SIGNUM Hatchback (Z03) 2.2 direct (F48) (De 2003.05 Até 2008.09) 114KW 155cv 2198cm3...</p> <p>37x38x36mm 1f-d18mm</p>

	<p>U0314 NO. 0424761</p> <p>ANILHA DA SUSPENSÃO DAS MOLAS DE TRÁS INFERIOR</p> <p>OPEL SIGNUM Hatchback (Z03) 1.8 (F48) (09.2005 - 12.2008) 103kw 140cv 1796cm3 Hatchback OPEL SIGNUM Hatchback (Z03) 1.8 (F48) (05.2003 - 07.2005) 90kw 122cv 1796cm3 Hatchback OPEL SIGNUM Hatchback (Z03) 1.9 CDTI (F48) (08.2005 - 02.2008) 74kw 100cv 1910cm3 Hatchback OPEL SIGNUM Hatchback (Z03) 1.9 CDTI (F48) (04.2004 - 02.2008) 88kw 120cv 1910cm3 Hatchback OPEL SIGNUM Hatchback (Z03) 1.9 CDTI (F48...</p> <p>d132x22mm 1f-d33mm</p>		<p>UAP81292 NO. 0821038 - 0821074 - 0821437 - 0821675 - 4708869 - 4809347 - 821038 - 821074 - 821437 - 821675</p> <p>ANILHA PROTEÇÃO TÉRMICA INJECTORES</p> <p>OPEL SIGNUM Hatchback (Z03) 2.0 DTI (F48) (De 05-2003 Até 04-2004) 74kW 100CV 1995cc Hatchback OPEL SIGNUM Hatchback (Z03) 2.2 DTI (F48) (De 05-2003 Até 04-2004) 92kW 125CV 2172cc Hatchback</p> <p>d16x1mm 1f-d7mm</p>
	<p>UAP81292 NO. 0821038 - 0821074 - 0821437 - 0821675 - 4708869 - 4809347 - 821038 - 821074 - 821437 - 821675</p> <p>ANILHA PROTEÇÃO TÉRMICA INJECTORES</p> <p>OPEL SIGNUM Hatchback (Z03) 2.0 DTI (F48) (De 05-2003 Até 04-2004) 74kW 100CV 1995cc Hatchback OPEL SIGNUM Hatchback (Z03) 2.2 DTI (F48) (De 05-2003 Até 04-2004) 92kW 125CV 2172cc Hatchback</p> <p>d16x1mm 1f-d7mm</p>		<p>UCRZ1055 NO. 0905000 - 0905005 - 0905009 - 5905104</p> <p>CRUZETA VEIO DIREÇÃO D16X39MM</p> <p>OPEL SIGNUM Hatchback (Z03) 1.8 (F48) (De 09.2005 Até 12.2008) 103kW 140cv 1796cm3 Hatchback - OPEL SIGNUM Hatchback (Z03) 1.8 (F48) (De 05.2003 Até 07.2005) 90kW 122cv 1796cm3 Hatchback - OPEL SIGNUM Hatchback (Z03) 1.9 CDTI (F48) (De 08.2005 Até 02.2008) 74kW 100cv 1910cm3 Hatchback - OPEL SIGNUM Hatchback (Z03) 1.9 CDTI (F48) (De 04.2004 Até 02.2008) 88kW 120cv 1910cm3 Hatchback - OPEL SIGNUM ...</p> <p>d16x28x41mm</p>
	<p>UMB84019 NO. 2060668</p> <p>TAMPÃO BLOCO MOTOR</p> <p>OPEL SIGNUM Hatchback (Z03) 1.8 (F48) (De 05-2003 Até 07-2005) 90kW 122CV 1796cc Hatchback</p> <p>d-26x9,5mm di-23,3mm</p>		<p>UMB84019L NO. 2060668</p> <p>TAMPÃO BLOCO DE MOTOR (RELAS)</p> <p>OPEL SIGNUM Hatchback (Z03) 1.8 (F48) (De 05-2003 Até 07-2005) 90kW 122CV 1796cc Hatchback</p> <p>d-26x9,5mm di-23,3mm</p>
	<p>UMB84021 NO. 2060673</p> <p>TAMPÃO BLOCO MOTOR</p> <p>OPEL SIGNUM Hatchback (Z03) 1.8 (F48) (De 05-2003 Até 07-2005) 90kW 122CV 1796cc Hatchback</p> <p>d-28x7mm di-25,6mm</p>		<p>UMB84021L NO. 2060673</p> <p>TAMPÃO BLOCO DE MOTOR (RELAS)</p> <p>OPEL SIGNUM Hatchback (Z03) 1.8 (F48) (De 05-2003 Até 07-2005) 90kW 122CV 1796cc Hatchback</p> <p>d-28x7mm di-25,6mm</p>
	<p>UMB84029 NO. 2060946</p> <p>TAMPÃO BLOCO MOTOR</p> <p>OPEL SIGNUM Hatchback (Z03) 1.8 (F48) (09.05 A 12.08) 140cv 1796cc Hatchback - OPEL SIGNUM Hatchback (Z03) 1.8 (F48) (05.03 A 07.05) 122cv 1796cc Hatchback</p> <p>d36x10mm di-32mm</p>		<p>UMV25415 NO. 24456028 - 738125</p> <p>MANETE PUNHO TOPO ALAVANCA MUDANÇAS 5 VELOCIDADES F12MM</p> <p>OPEL SIGNUM Hatchback (Z03): 1.8 (F48) 09.2005/12.2008 103KW 140CV 1796CC - OPEL SIGNUM Hatchback (Z03): 1.8 (F48) 05.2003/07.2005 90KW 122CV 1796CC - OPEL SIGNUM Hatchback (Z03): 2.0 Turbo (F48) 05.2003/12.2008 129KW 175CV 1998CC - OPEL SIGNUM Hatchback (Z03): 2.2 direct (F48) 05.2003/09.2008 114KW 155CV 2198CC - OPEL SIGNUM Hatchback (Z03): 2.8 V6 Turbo (F48) 09.2005/12.2008 169KW 230CV 2792CC ...</p> <p>d51x55mm 1f-d31mm</p>
	<p>UMV25434 NO. 5738946 - 93186142</p> <p>MANETE PUNHO TOPO ALAVANCA MUDANÇAS 6 VELOCIDADES F31MM</p> <p>OPEL SIGNUM Hatchback (Z03) 1.8 (F48) 05.2003/07.2005 90KW 122CV 1796CC Z 18 XE 0035ABB 0035485 0035050 0035523 - OPEL SIGNUM Hatchback (Z03) 1.8 (F48) 09.2005/12.2008 103KW 140CV 1796CC Z 18 XER 0035AAH - OPEL SIGNUM Hatchback (Z03) 1.9 CDTI (F48) 04.2004/02.2008 88KW 120CV 1910CC Z 19 DT 0035ABE 0035058 0035531 - OPEL SIGNUM Hatchback (Z03) 1.9 CDTI (F48) 04.2004/02.2008 110KW 150CV 1910CC Z 1...</p> <p>d52x60mm 1f-d31mm</p>		<p>UMV25443 NO. 55557637</p> <p>MANETE PUNHO TOPO ALAVANCA MUDANÇAS 5 VELOCIDADES F13MM</p> <p>OPEL SIGNUM Hatchback (Z03) 1.9 CDTI (F48) 04.2004/02.2008 88KW 120CV 1910CC Z 19 DT 0035ABE 0035058 0035531 - OPEL SIGNUM Hatchback (Z03) 1.9 CDTI (F48) 04.2004/02.2008 110KW 150CV 1910CC Z 19 DTH 0035ABG 0035059 0035532 - OPEL SIGNUM Hatchback (Z03) 1.9 CDTI (F48) 08.2005/02.2008 74KW 100CV 1910CC Z 19 DTL 0035110 0035ABF - OPEL SIGNUM Hatchback (Z03) 3.2 V6 (F48) 05.2003/07.2005 155KW 211CV 317...</p> <p>52x54x53mm 1f-d13mm</p>
	<p>UMV25444 NO. 55557637 - 5738044</p> <p>MANETE PUNHO TOPO ALAVANCA MUDANÇAS 6 VELOCIDADES F13MM</p> <p>OPEL SIGNUM Hatchback (Z03) 1.9 CDTI (F48) 04.2004/02.2008 88KW 120CV 1910CC Z 19 DT 0035ABE 0035058 0035531 - OPEL SIGNUM Hatchback (Z03) 1.9 CDTI (F48) 04.2004/02.2008 110KW 150CV 1910CC Z 19 DTH 0035ABG 0035059 0035532 - OPEL SIGNUM Hatchback (Z03) 1.9 CDTI (F48) 08.2005/02.2008 74KW 100CV 1910CC Z 19 DTL 0035110 0035ABF - OPEL SIGNUM Hatchback (Z03) 3.2 V6 (F48) 05.2003/07.2005 155KW 211CV 317...</p> <p>52x54x53mm 1f-d13mm</p>		<p>UTR0821 NO. 1304677 - 9202799</p> <p>TAMPÃO RESERVATÓRIO LIQUIDO REFRIGERAÇÃO</p> <p>OPEL SIGNUM 2.0 Turbo (A Partir de 05.03) 175cv 1998cc Hatchback - OPEL SIGNUM 1.9 CDTI (A Partir de 08.05) 100cv 1910cc Hatchback - OPEL SIGNUM 1.9 CDTI (A Partir de 04.04) 120cv 1910cc Hatchback 3 / 4 - OPEL SIGNUM 1.9 CDTI (A Partir de 04.04) 150cv 1910cc Hatchback - OPEL SIGNUM 2.2 DTI 1 6 V (05.03 A 06.08) 117cv 2172cc Hatchback - OPEL SIGNUM 2.2 DTI (A Partir de 05.03) 125cv 2172...</p> <p>61x35mm 1f-d52x15mm</p>
	<p>UTR1300 NO. 00650090 - 05650831</p> <p>TAMPÃO DO RESERVATÓRIO DO ÓLEO</p> <p>OPEL SIGNUM Hatchback (Z03) 2.2 DTI (F48) (De 05-2003 Até 04-2004) 92kW 125CV 2172cc Hatchback</p> <p>d59x31mm d45x12mm</p>		<p>UTR1305 NO. 0650089 - 650089</p> <p>TAMPÃO DO RESERVATÓRIO ÓLEO</p> <p>OPEL SIGNUM Hatchback (Z03) 1.8 (F48) (09.2005 -12.2008) 103kw 140cv 1796cm3 Hatchback OPEL SIGNUM Hatchback (Z03) 1.8 (F48) (05.2003 -07.2005) 90kw 122cv 1796cm3 Hatchback OPEL SIGNUM Hatchback (Z03) 1.9 CDTI (F48) (04.2004 -02.2008) 88kw 120cv 1910cm3 Hatchback OPEL SIGNUM Hatchback (Z03) 1.9 CDTI (F48) (04.2004 -02.2008) 110kw 150cv 1910cm3 Hatchback OPEL SIGNUM Hatchback (Z03) 2.0 DTI (F48) (0...</p> <p>d61x23mm d32x19mm</p>

OPEL SIGNUM

Rafri, Lda.













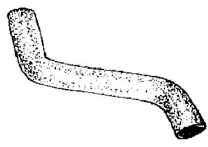

	<p>UTV83019 NO. 0652315 - 0652477 - 652315 - 652477 - 90502556 - 96023264</p> <p>TAMPÃO VEDAÇÃO BUJÃO</p> <p>OPEL SIGNUM Hatchback (Z03) 1.8 (F48) (De 09-2005 Até 12-2008) 103kW 140CV 1796cc Hatchback OPEL SIGNUM Hatchback (Z03) 1.8 (F48) (De 05-2003 Até 07-2005) 90kW 122CV 1796cc Hatchback OPEL SIGNUM Hatchback (Z03) 3.2 V6 (F48) (De 05-2003 Até 07-2005) 155kW 211CV 3175cc Hatchback OPEL SIGNUM Hatchback (Z03) 2.0 DTI (F48) (De 05-2003 Até 04-2004) 74kW 100CV 1995cc Hatchback OPEL SIGNUM Hatchback (Z03) 14mm c9mm d13mm</p>		<p>W5051 NO. 0614411 - 09128177 - 09544461 - 55351711 - 553517169 - 5614415 - 5614437 - 614411 - 614444 - 9...</p> <p>POLIE DA CAMBOTA (6 PISTAS)</p> <p>OPEL SIGNUM Hatchback (Z03) 2.0 DTI (F48) 05.2003/04.2004 74KW 100CV 1995CC Y 20 DTH 0035489 0035055 0035526 - OPEL SIGNUM Hatchback (Z03) 2.2 DTI (F48) 05.2003/04.2004 92KW 125CV 2172CC Y 22 DTR 0035490 0035056 0035527</p> <p>d153mm d35mm</p>
	<p>W5107 NO. 5614425 - 5614431 - 9129209</p> <p>POLIE DA CAMBOTA (5 PISTAS)</p> <p>OPEL SIGNUM 1.8 Z 18 XE 122CV (APÓS 05-2003)</p> <p>d160m 1f-d26mm</p>		<p>W5145 NO. 93178819 - 0614359 - 614359 - 93192547</p> <p>POLIE DA CAMBOTA 6 PISTAS</p> <p>OPEL SIGNUM 1.9 CDTI (APÓS 04.04) 120cv 1910cc Hatchback</p> <p>d169mm d30,5mm</p>
	<p>W5166 NO. 0614584 - 55564573 - 614584</p> <p>POLIE DA CAMBOTA (6 PISTAS)</p> <p>OPEL SIGNUM Hatchback (Z03) 1.9 CDTI (F48) 04.2004/02.2008 110KW 150CV 1910CC Z 19 DTH 0035ABG 0035059 0035532</p> <p>d165mm d30mm</p>		<p>Y3212 NO. 1008501 - 1008504 - 4709077</p> <p>PARAFUSO PERNO RODA CHAVE 17 M12X1,50X48MM (BASE CONICA PARA JANTES AÇO E LIGA LEVE)</p> <p>OPEL SIGNUM Hatchback (Z03) 1.8 (F48) (09.2005 - 12.2008) 103kw 140cv 1796cm3 Hatchback OPEL SIGNUM Hatchback (Z03) 1.8 (F48) (05.2003 - 07.2005) 90kw 122cv 1796cm3 Hatchback OPEL SIGNUM Hatchback (Z03) 1.9 CDTI (F48) (04.2004 - 02.2008) 88kw 120cv 1910cm3 Hatchback OPEL SIGNUM Hatchback (Z03) 1.9 CDTI (F48) (04.2004 - 02.2008) 110kw 150cv 1910cm3 Hatchback OPEL SIGNUM Hatchback (Z03) 2.0 DTI (F48...</p> <p>C48mm (Ch-17mm) M12x1,50x22mm</p>
	<p>Z55280 NO. 2228839</p> <p>MOLA PAINEL REVESTIMENTO DAS PORTAS</p> <p>OPEL SIGNUM Hatchback (Z03) 1.8 (F48) 05.2003/07.2005 90KW 122CV 1796CC Z 18 XE 0035ABB 0035485 0035050 0035523 - OPEL SIGNUM Hatchback (Z03) 1.8 (F48) 09.2005/12.2008 103KW 140CV 1796CC Z 18 XER 0035AAH - OPEL SIGNUM Hatchback (Z03) 1.9 CDTI (F48) 04.2004/02.2008 88KW 120CV 1910CC Z 19 DT 0035ABE 0035058 0035531 - OPEL SIGNUM Hatchback (Z03) 1.9 CDTI (F48) 04.2004/02.2008 110KW 150CV 1910CC Z 1...</p> <p>F-G-mm T-27L-18H-12S-5mm</p>		

OPEL SPEEDSTER

	<p>A2087 NO. 5834901</p> <p>APOIO DO FILTRO DE AR</p> <p>OPEL SPEEDSTER (E01) 2.2 (R97) (06.00 A 08.05) 147cv 2198cc Cabriolet</p> <p>d20x15mm 1p-d5x14 1p-d6x14mm</p>		<p>E1092 NO. 0852726 - 13276148 - 852577 - 852726 - 90466668</p> <p>ESTICADOR DE ESCAPE</p> <p>OPEL SPEEDSTER (E01): 2.2 (R97) 06.2000/08.2005 108KW 147CV 2198CC</p> <p>55x40x35mm</p>
	<p>JMB84026L NO. 11056093 - 2060665</p> <p>TAMPÃO BLOCO DE MOTOR (RELAS)</p> <p>OPEL SPEEDSTER</p> <p>d-34x13mm di-31,2mm</p>		<p>UTR0800 NO. 1304240 - 1304654 - 1304659 - 1304660 - 1304661 - 1304665 - 1304666 - 1304667 - 1304853 - 90352470 - ...</p> <p>TAMPÃO RESERVATÓRIO LIQUIDO REFRIGERAÇÃO</p> <p>OPEL SPEEDSTER (E01) 2.0 Turbo 04.03 - 147 200 1998 Cabriolet OPEL SPEEDSTER (E01) 2.2 09.00 - 108 147 2198 Cabriolet</p> <p>d62x25mm 1f-d53x14mm</p>
	<p>UTR0820 NO. 90352470 - 90409256 - 90409257 - 9041032690497472 - 90467473</p> <p>TAMPÃO RESERVATÓRIO LIQUIDO REFRIGERAÇÃO</p> <p>OPEL SPEEDSTER 2.0 Turbo (A Partir de 04.03) 200cv 1998cc Cabriolet - OPEL SPEEDSTER 2.2 (A Partir de 09.00) 147cv 2198cc Cabriolet</p> <p>d62x23mm 1f-d53x12mm</p>		

	<p>A1069 NO. 0682555 - 0682600 - 0682603 - 682555 - 682600 - 682603 - 90304647 - 90473837 - 90538063</p> <p>APOIO SUPORTE TRASEIRO DO MOTOR (CAIXA)</p> <p>OPEL TIGRA (S93) 1.4 16V (F07) 07.1994/12.2000 66KW 90CV 1389CC X 14 XE 0039933 - OPEL TIGRA (S93) 1.4 16V (F07) 08.1997/12.2000 63KW 86CV 1389CC X 14 XE - OPEL TIGRA (S93) 1.6 16V (F07) 07.1994/08.1998 78KW 106CV 1598CC X 16 XE 0039934 - OPEL TIGRA (S93) 1.6 16V (F07) 08.1997/08.1998 74KW 100CV 1598CC C 16 SEL</p> <p>145x90x66mm 1f-d10mm</p>		<p>A1205 NO. 0684666 - 684666 - 90445300</p> <p>APOIO DE MOTOR FRENTE DIREITO</p> <p>OPEL TIGRA (S93) 1.4 16V (F07) 07.1994/12.2000 66KW 90CV 1389CC X 14 XE 0039933 - OPEL TIGRA (S93) 1.4 16V (F07) 08.1997/12.2000 63KW 86CV 1389CC X 14 XE - OPEL TIGRA (S93) 1.6 16V (F07) 07.1994/08.1998 78KW 106CV 1598CC X 16 XE 0039934 - OPEL TIGRA (S93) 1.6 16V (F07) 08.1997/08.1998 74KW 100CV 1598CC C 16 SEL</p> <p>160x100x100mm 1p-d10-45mm 1r-d9mm</p>
	<p>A1209 NO. 0684661 - 0684665 - 0684671 - 684661 - 684665 - 684671 - 90444514 - 90444515 - 90444522 - 90444525...</p> <p>APOIO FRENTE ESQUERDO DE MOTOR</p> <p>OPEL TIGRA (S93) 1.4 16V (F07) 07.1994/12.2000 66KW 90CV 1389CC X 14 XE 0039933 - OPEL TIGRA (S93) 1.4 16V (F07) 08.1997/12.2000 63KW 86CV 1389CC X 14 XE - OPEL TIGRA (S93) 1.6 16V (F07) 07.1994/08.1998 78KW 106CV 1598CC X 16 XE 0039934</p> <p>200x90x60mm 2r-d10mm</p>		<p>A1211 NO. 0684671 - 684671 - 684687 - 90445523 - 90445524 - 90495170</p> <p>APOIO FRENTE ESQUERDO DE MOTOR</p> <p>OPEL TIGRA (S93) 1.4 16V (F07) 07.1994/12.2000 66KW 90CV 1389CC X 14 XE 0039933 - OPEL TIGRA (S93) 1.6 16V (F07) 07.1994/08.1998 78KW 106CV 1598CC X 16 XE 0039934</p> <p>200x90x60mm 2r-d10mm</p>
	<p>A1212 NO. 684659 - 684669</p> <p>APOIO FRENTE ESQUERDO DE MOTOR</p> <p>OPEL TIGRA 1.4 - 1.6 (APÓS 1994)</p> <p>157x90x60mm 2r-d10mm</p>		<p>A1215 NO. 684294</p> <p>APOIO DE MOTOR FRENTE DIREITO</p> <p>OPEL TIGRA 1.4 16v - 1.6 16v (APÓS 1994)</p> <p>160x95x60mm 2r-d10mm</p>
	<p>A1218 NO. 0344519 - 344502 - 344519 - 90445207 - 90445208</p> <p>APOIO DO AMORTECEDOR DE TRÁS</p> <p>OPEL TIGRA (S93): 1.4 16V (F07) 08.1997/12.2000 63KW 86CV 1389CC - OPEL TIGRA (S93): 1.4 16V (F07) 07.1994/12.2000 66KW 90CV 1389CC - OPEL TIGRA (S93): 1.6 16V (F07) 08.1997/08.1998 74KW 100CV 1598CC - OPEL TIGRA (S93): 1.6 16V (F07) 07.1994/08.1998 78KW 106CV 1598CC</p> <p>135x110x40mm 1f-d34mm</p>		<p>A1314 NO. 344519 - 90445207</p> <p>APOIO DE AMORTECEDOR DA FRENTE</p> <p>OPEL TIGRA (S93): 1.4 16V (F07) 08.1997/12.2000 63KW 86CV 1389CC - OPEL TIGRA (S93): 1.4 16V (F07) 07.1994/12.2000 66KW 90CV 1389CC - OPEL TIGRA (S93): 1.6 16V (F07) 08.1997/08.1998 74KW 100CV 1598CC - OPEL TIGRA (S93): 1.6 16V (F07) 07.1994/08.1998 78KW 106CV 1598CC</p> <p>136x109x38mm 2p-d8-17mm 1f-d37mm</p>
	<p>A1943 NO. 0344523 - 344523 - 90468554</p> <p>APOIO SUPORTE AMORTECEDOR FRENTE (GASTA 2 UNIDADES)</p> <p>OPEL TIGRA TwinTop 1.4 (A Partir de 06.04) 90cv 1364cc Cabriolet - OPEL TIGRA TwinTop 1.8 (A partir de 06.04) 125cv 1796cc Cabriolet - OPEL TIGRA TwinTop 1.3 CDTI (A Partir de 06.04) 69cv 1248cc Cabriolet</p> <p>d115x45mm 1f-d12mm</p>		<p>A2069 NO. 0684238 - 184398A - 24416545 - 684238 - 93302281</p> <p>APOIO MOTOR FRENTE CENTRO</p> <p>OPEL TIGRA TwinTop (X04) 1.4 (R97) (De 06-2004 Até 12-2010) 66KW 90CV 1364cc Cabriolet OPEL TIGRA TwinTop (X04) 1.8 (R97) (De 06-2004 Até 12-2010) 92KW 125CV 1796cc Cabriolet OPEL TIGRA TwinTop (X04) 1.3 CDTI (R97) (De 06-2004 Até 12-2010) 51KW 69CV 1248cc Cabriolet</p> <p>204x94x84mm 1f-d16mm 2f-d12mm</p>
	<p>A2301 NO. 0684180 - 0684181 - 09227878 - 09227879 - 13125209 - 5684168 - 5684170</p> <p>APOIO DO MOTOR LADO DIREITO</p> <p>OPEL TIGRA TwinTop (X04) 1.4 (R97) (De 2004.06 Até 2010.12) 66kW 90cv 1364cm3 Cabriolet -</p> <p>175x117x100mm 2f-d11mm 2f-d17mm</p>		<p>A2594 NO. 13109203 - 5684761</p> <p>APOIO DO MOTOR PARTE DA FRENTE LADO ESQUERDO</p> <p>OPEL TIGRA TwinTop (X04) 1.3 CDTI (R97) (De 06.2004 Até 12.2010) 51kW 69cv 1248cm3 Cabriolet -</p> <p>175x114x140mm 2f-d19mm 4f-d9mm</p>
	<p>C0233 NO. 1160724 - 90054143</p> <p>BOTÃO AFINAÇÃO CAPÔT</p> <p>OPEL TIGRA (75_) 1.4 16V (07.94 A 12.00) 90cv 1389cc Coupé - OPEL TIGRA (75_) 1.6 16V (07.94 A 08.98) 106cv 1598cc Coupé - OPEL TIGRA TwinTop 1.4 (A Partir de 06.04) 90cv 1364cc Cabriolet - OPEL TIGRA TwinTop 1.8 (A Partir de 06.04) 125cv 1796cc Cabriolet - OPEL TIGRA TwinTop 1.3 CDTI (A Partir de 06.04) 69cv 1248cc Cabriolet</p> <p>d19x31mm</p>		<p>E0605-M NO. 0846000 - 09227883 - 24463130 - 8 46 083 - 846000 - 9227883 - 93302286</p> <p>ESTICADOR SUPORTE APOIO MOTOR TRAS</p> <p>OPEL TIGRA TwinTop (X04) 1.4 (R97) 06.2004/12.2010 66KW 90CV 1364CC Z 14 XEP 0035AGN 0035037 - OPEL TIGRA TwinTop (X04) 1.8 (R97) 06.2004/12.2010 92KW 125CV 1796CC Z 18 XE 0035AGZ 0035038</p> <p>220x100x50mm 2f-d12mm 1f-12x18mm</p>
	<p>E0606-M NO. 0684713 - 09227882 - 684713 - 9227882 - 93302287</p> <p>ESTICADOR SUPORTE APOIO MOTOR TRAS</p> <p>OPEL TIGRA TwinTop (X04) 1.4 (R97) 06.2004/12.2010 66KW 90CV 1364CC Z 14 XEP 0035AGN 0035037 - OPEL TIGRA TwinTop (X04) 1.8 (R97) 06.2004/12.2010 92KW 125CV 1796CC Z 18 XE 0035AGZ 0035038</p> <p>207x80x44mm 1f-d12mm 1f-d13mm 1r-d10mm</p>		<p>E0639-M NO. 0846034 - 13143386 - 846034</p> <p>ESTICADOR SUPORTE APOIO MOTOR TRAS</p> <p>OPEL TIGRA TwinTop (X04) 1.3 CDTI (R97) 06.2004/12.2010 51KW 69CV 1248CC Z 13 DT 0035AGL 0035099 - OPEL TIGRA TwinTop (X04) 1.4 (R97) 06.2004/12.2010 66KW 90CV 1364CC Z 14 XEP 0035AGN 0035037 - OPEL TIGRA TwinTop (X04) 1.8 (R97) 06.2004/12.2010 92KW 125CV 1796CC Z 18 XE 0035AGZ 0035038</p> <p>223x111x57mm 2f-d12mm 1f-13x19mm</p>

	E0653-M NO. 0684717 - 13117088 - 684717 ESTICADOR DO MOTOR PARTE DE TRÁS OPEL TIGRA TwinTop (X04) 1.3 CDTI (R97) (06.2004 - 12.2010) 51kw 69cv 1248cm3 Cabriolet OPEL TIGRA TwinTop (X04) 1.4 (R97) (06.2004 - 12.2010) 66kw 90cv 1364cm3 Cabriolet 215x101x44mm 1f-d12mm 1f-d10mm 1f-d12mm		E1031 NO. 0852516 - 852516 - 90467447 ESTICADOR DE ESCAPE OPEL TIGRA 1.4 16v - 1.6 16v (APÓS 1994) 68x44x42mm
	E1092 NO. 0852726 - 13276148 - 852577 - 852726 - 90466668 ESTICADOR DE ESCAPE OPEL TIGRA TwinTop (X04): 1.4 (R97) 06.2004/12.2010 66KW 90CV 1364CC - OPEL TIGRA TwinTop (X04): 1.8 (R97) 06.2004/12.2010 92KW 125CV 1796CC - OPEL TIGRA TwinTop (X04): 1.3 CDTI (R97) 06.2004/12.2010 51KW 69CV 1248CC 55x40x35mm		F1617-I NO. 1609087 - 26032286 FOLE DE DIRECÇÃO ASSISTIDA DIREITO E ESQUERDO OPEL TIGRA 1.4 16v - 1.6 16v (APÓS 1994) d62x184mm 1f-d11mm 1f-d48mm
	F1830H-I NO. 1603189 - 1603231 FOLE DA TRANSMISSÃO JUNTO À CAIXA OPEL TIGRA TWIN TOP 1.4i 16v (APÓS 2004) d90x135mm 1f-d78mm 1f-d23mm		F1845-I NO. 1603004 - 1603230 - 26073421 - 26094870 FOLE DA TRANSMISSÃO LADO DA CAIXA OPEL TIGRA TWIN TOP 1.4i 16v (APÓS 2004) d81x95mm 1f-d72mm 1f-d22mm
	F4093 NO. 0738423 - 09200970 - 738423 - 9200970 FOLE ALAVANCA VELOCIDADES OPEL TIGRA TwinTop (X04): 1.4 (R97) 06.2004/12.2010 66KW 90CV 1364CC - OPEL TIGRA TwinTop (X04): 1.8 (R97) 06.2004/12.2010 92KW 125CV 1796CC - OPEL TIGRA TwinTop (X04): 1.3 CDTI (R97) 06.2004/12.2010 51KW 69CV 1248CC 160x110x170mm 1f-d50mm		F4094 NO. 0738978 - 5738414 - 738978 - 90373314 - 90437426 FOLE ALAVANCA VELOCIDADES OPEL TIGRA (S93): 1.4 16V (F07) 07.1994/12.2000 66KW 90CV 1389CC - OPEL TIGRA (S93): 1.6 16V (F07) 07.1994/08.1998 78KW 106CV 1598CC 170x120x220mm 1f-160x105mm 1f-d50mm
	KF1845-I NO. 1603004 - 1603230 - 26073421 - 26094870 KIT FOLE TRANSMISSÃO JUNTO À CAIXA OPEL TIGRA TwinTop (X04) 1.4 (A Partir de 06.04) 90cv 1364cc Cabriolet - OPEL TIGRA TwinTop (X04) 1.3 CDTI (A Partir de 06.04) 69cv 1248cc Cabriolet d81x95mm 1f-d72mm 1f-d22mm		KF2527-T NO. 1603189 KIT DE FOLE DO CARDAN JUNTO À RODA OPEL TIGRA 1.4i 16v (1994 A 2000) d95x130mm 1f-d78mm 1f-d23mm
	KL80449 NO. 198283 - 607813 - 90412865 KIT CASQUINHOS COBERTURA TAMPA MOTOR OPEL TIGRA (S93): 1.4 16V (F07) 08.1997/12.2000 63KW 86CV 1389CC - OPEL TIGRA (S93): 1.4 16V (F07) 07.1994/12.2000 66KW 90CV 1389CC - OPEL TIGRA (S93): 1.6 16V (F07) 08.1997/08.1998 74KW 100CV 1598CC - OPEL TIGRA (S93): 1.6 16V (F07) 07.1994/08.1998 78KW 106CV 1598CC - OPEL TIGRA TwinTop (X04): 1.8 (R97) 06.2004/12.2010 92KW 125CV 1796CC d16x10mm 1f-d6mm		KUR2822 NO. 1f-d16mm 1f-d15mm 1f-d18mm 1f-d25mm KIT REPARAÇÃO ALAVANCA DE VELOCIDADES OPEL TIGRA TwinTop (X04) 1.3 CDTI (R97) (06.2004 - 12.2010) 51kw 69cv 1248cm3 Cabriolet OPEL TIGRA TwinTop (X04) 1.4 (R97) (06.2004 - 12.2010) 66kw 90cv 1364cm3 Cabriolet OPEL TIGRA TwinTop (X04) 1.8 (R97) (06.2004 - 12.2010) 92kw 125cv 1796cm3 Cabriolet 33x35x28mm(x2) d22x19mm(x2) d14x14mm(x2) d22x26mm 16x32mm d17x17mm
	M6003 NO. 854952 JUNTA DE ESCAPE OPEL TIGRA (APÓS 1994) d59x13.5mm 1f-d45mm		P1012 NO. 0560808 - 560808 - 90105172 CAPA PEDAL EMBRAIAGEM/TRAVAO (GASTA 2 UNIDADES) OPEL TIGRA (S93): 1.4 16V (F07) 07.1994/12.2000 66KW 90CV 1389CC - OPEL TIGRA (S93): 1.6 16V (F07) 07.1994/08.1998 78KW 106CV 1598CC 60x55x9mm
	R017112 NO. 5851946 - 93177469 TUBO DA VALVULA REGULADORA DE VELOCIDADE OPEL TIGRA TwinTop (X04): 1.3 CDTI (R97) 06.2004/12.2010 51KW 69CV 1248CC B133-14/14mm 39x64x29x51mm		R019214 NO. 817329 - 93177371 TUBO EXTRACTOR DE COMBUSTIVEL OPEL TIGRA TwinTop (X04) 1.3 CDTI (R97) 06.2004/12.2010 51KW 69CV 1248CC Z 13 DT 0035AGL 0035099 B455-3mm 4p-d5x10mm

	<p>R080252 NO. 80-300mm ch-d20-30mm ch-d20-30mm c</p> <p>TUBO RÍGIDO REFRIGERAÇÃO</p> <p>OPEL TIGRA (S93) 1.4 16V (F07) (De 1997.08 Até 2000.12) 63kW 86cv 1389cm3 Coupé - OPEL TIGRA (S93) 1.4 16V (F07) (De 1994.07 Até 2000.12) 66kW 90cv 1389cm3 Coupé - OPEL TIGRA (S93) 1.6 16V (F07) (De 1997.08 Até 1998.08) 74kW 100cv 1598cm3 Coupé - OPEL TIGRA (S93) 1.6 16V (F07) (De 1994.07 Até 1998.08) 78kW 106cv 1598cm3 Coupé -</p> <p>B315-32/35mm 80-300mm ch-d20-30mm ch-d20-30mm c</p>		<p>R221446 NO. 49x90x150x138x95x86x93x100x72x41x7</p> <p>TUBO INFERIOR DO RADIADOR</p> <p>OPEL TIGRA TwinTop (X04) 1.3 CDTI (R97) 06.2004/12.2010 51KW 69CV 1248CC Z 13 DT 0035AGL 0035099</p> <p>hB780-18/29mm 49x90x150x138x95x86x93x100x72x41x75x39x65</p>
	<p>R221450 NO. 1337186 - 90444463</p> <p>TUBO SUPERIOR RADIADOR</p> <p>OPEL TIGRA (S93) 1.4 16V (F07) 07.1994/12.2000 66KW 90CV 1389CC X 14 XE 0039933 - OPEL TIGRA (S93) 1.4 16V (F07) 08.1997/12.2000 63KW 86CV 1389CC X 14 XE</p> <p>B185-d40/34mm 120-100-80mm</p>		<p>R221451 NO. 1337193 - 90410065 - 90444477</p> <p>TUBO DE RADIADOR INFERIOR</p> <p>OPEL TIGRA (S93) 1.4 16V (F07) 07.1994/12.2000 66KW 90CV 1389CC X 14 XE 0039933 - OPEL TIGRA (S93) 1.4 16V (F07) 08.1997/12.2000 63KW 86CV 1389CC X 14 XE</p> <p>B360-d37/33mm 125-205-65mm</p>
	<p>R221743 NO. 055351522 - 05656121 - 0656092 - 55578995 - 5656121 - 656092</p> <p>TUBO RESPIRO DO CARTER CAMBOTA</p> <p>OPEL TIGRA TwinTop (X04) 1.4 (R97) (06.2004 - 12.2010) 66kw 90cv 1364cm3 Cabriolet</p> <p>boca a boca175mmd1-15mm/207-75</p>		<p>R221747 NO. 1336267 - 9158673</p> <p>TUBO DO RADIADOR</p> <p>OPEL TIGRA TwinTop (X04) 1.8 (R97) (De 2004.06 Até 2010.12) 92kW 125cv 1796cm3 Cabriolet -</p> <p>B430-38/39mm 60x73x120x127x100mm</p>
	<p>R221748 NO. 5851946 - 93177469</p> <p>TUBO DA VALVULA REGULADORA DE VELOCIDADE</p> <p>OPEL TIGRA TwinTop (X04) 1.3 CDTI (R97) 06.2004/12.2010 51KW 69CV 1248CC Z 13 DT 0035AGL 0035099</p> <p>B140-17/17mm 70x30x80x35mm</p>		<p>R222739 NO. 1337188</p> <p>TUBO SUPERIOR DO RADIADOR</p> <p>OPEL TIGRA (S93) 1.4 16V (F07) (De 07-1994 Até 12-2000) 66kW 90CV 1389cc Coupé</p> <p>B195-32/39mm 55-42-70mm</p>
	<p>R222740 NO. 1337095 - 90354836</p> <p>TUBO LIGAÇÃO TERMOSTATO BOMBA DE ÁGUA</p> <p>OPEL TIGRA (S93) 1.4 16V (F07) (De 07-1994 Até 12-2000) 66kW 90CV 1389cc Coupé OPEL TIGRA (S93) 1.6 16V (F07) (De 07-1994 Até 08-1998) 78kW 106CV 1598cc Coupé</p> <p>B138-28/38mm 32-57-51mm</p>		<p>R222741 NO. 1818256</p> <p>TUBO DE LIGAÇÃO AO DEPÓSITO EXPANSÃO</p> <p>OPEL TIGRA (S93) 1.4 16V (F07) (De 1997.08 Até 2000.12) 63kW 86cv 1389cm3 Coupé - OPEL TIGRA (S93) 1.4 16V (F07) (De 1994.07 Até 2000.12) 66kW 90cv 1389cm3 Coupé -</p> <p>B250-29/29mm 86x42x104mm</p>
	<p>R222752 NO. 1337573 - 9128354</p> <p>TUBO SUPERIOR DO RADIADOR</p> <p>OPEL TIGRA TwinTop (X04) 1.4 (R97) 06.2004/12.2010 66KW 90CV 1364CC Z 14 XEP 0035AGN 0035037</p> <p>B170-d34/34mm 110-85mm</p>		<p>R222857 NO. 13157694 - 6818559</p> <p>TUBO DO PERMUTADOR DO CALOR DO AQUECIMENTO</p> <p>OPEL TIGRA TwinTop (X04) 1.3 CDTI (R97) (De 2004.06 Até 2010.12) 51kW 69cv 1248cm3 Cabriolet -</p> <p>B213-19/21mm 46x51x65x66mm</p>
	<p>R8081 NO. 1818256</p> <p>TUBO DO ARREFECIMENTO</p> <p>OPEL TIGRA (S93) 1.4 16V (F07) 07.1994/12.2000 66KW 90CV 1389CC X 14 XE 0039933 - OPEL TIGRA (S93) 1.4 16V (F07) 08.1997/12.2000 63KW 86CV 1389CC X 14 XE</p> <p>B195-d18/18mm 75-95-75mm</p>		<p>R8084 NO. 1337190 - 90444470</p> <p>TUBO SUPERIOR DO RADIADOR</p> <p>OPEL TIGRA (S93) 1.4 16V (F07) 07.1994/12.2000 66KW 90CV 1389CC X 14 XE 0039933 - OPEL TIGRA (S93) 1.4 16V (F07) 08.1997/12.2000 63KW 86CV 1389CC X 14 XE - OPEL TIGRA (S93) 1.6 16V (F07) 07.1994/08.1998 78KW 106CV 1598CC X 16 XE 0039934 - OPEL TIGRA (S93) 1.6 16V (F07) 08.1997/08.1998 74KW 100CV 1598CC C 16 SEL</p> <p>B160-d34/34mm 145-180-95mm</p>
	<p>R8085 NO. 1337191 - 90444475</p> <p>TUBO SUPERIOR DO RADIADOR</p> <p>OPEL TIGRA (S93) 1.6 16V (F07) 07.1994/08.1998 78KW 106CV 1598CC X 16 XE 0039934 - OPEL TIGRA (S93) 1.6 16V (F07) 08.1997/08.1998 74KW 100CV 1598CC C 16 SEL</p> <p>B185-d32/32mm</p>		<p>R8151 NO. 838276 - 90470097</p> <p>TUBO LIGAÇÃO COLECTOR ADMISSÃO</p> <p>OPEL TIGRA (S93) 1.4 16V (F07) 07.1994/12.2000 66KW 90CV 1389CC X 14 XE 0039933 - OPEL TIGRA (S93) 1.4 16V (F07) 08.1997/12.2000 63KW 86CV 1389CC X 14 XE - OPEL TIGRA (S93) 1.6 16V (F07) 07.1994/08.1998 78KW 106CV 1598CC X 16 XE 0039934 - OPEL TIGRA (S93) 1.6 16V (F07) 08.1997/08.1998 74KW 100CV 1598CC C 16 SEL</p> <p>d76x49mm 1f-d67mm</p>

	<p>R8197 NO. 806137 - 90467441</p> <p>TUBO DO RESPIRO DO DEPÓSITO COMBUSTIVEL</p> <p>OPEL TIGRA (S93) 1.4 16V (F07) 07.1994/12.2000 66KW 90CV 1389CC X 14 XE 0039933 - OPEL TIGRA (S93) 1.6 16V (F07) 07.1994/08.1998 78KW 106CV 1598CC X 16 XE 0039934 - OPEL TIGRA (S93) 1.6 16V (F07) 08.1997/08.1998 74KW 100CV 1598CC C 16 SEL</p> <p>B405-d37/d37mm 96-220-80mm</p>		<p>RT08937 NO. 5562230 - 9191262</p> <p>TUBO DE TRAVÃO FRENTE LH-RH</p> <p>OPEL TIGRA 1.3 CDTI TWIN TOP (APÓS 06-2004) - 1.4 TWIN TOP (APÓS 06-2004) - 1.8 TWIN TOP (APÓS 06-2004)</p> <p>320mm F8 - OR29</p>
	<p>S1072 NO. 402643</p> <p>SILENT-BLOC DO ESTABILIZADOR</p> <p>OPEL TIGRA 1.4 16v - 1.6 16v (1994 A 2000)</p> <p>d52x65mm d39mm 1f-d10mm</p>		<p>S1126 NO. 352301 - 904445097</p> <p>SILENT-BLOC DA SUSPENSÃO</p> <p>OPEL TIGRA 1.4 16v - 1.6 16v (1994 A 2000)</p> <p>d45x52mm d38mm 1f-d10mm</p>
	<p>S1616-D NO. 0353280 - 09191299 - 353280 - 353283 - 353284 - 90445101 - 90539059 - 9191299</p> <p>SILENT-BLOC BRAÇO SUSPENSÃO FRENTE DIREITO</p> <p>OPEL TIGRA (S93) 1.4 16V (F07) 07.1994/12.2000 66KW 90CV 1389CC X 14 XE 0039933 - OPEL TIGRA (S93) 1.4 16V (F07) 08.1997/12.2000 63KW 86CV 1389CC X 14 XE - OPEL TIGRA (S93) 1.6 16V (F07) 07.1994/08.1998 78KW 106CV 1598CC X 16 XE 0039934</p> <p>170x130x60mm 1f-d14mm 3f-d14mm 2f-d9mm</p>		<p>S1616-E NO. 0353281 - 0353282 - 0353285 - 09191298 - 353281 - 353282 - 353285 - 90445100 - 90539058</p> <p>SILENT-BLOC BRAÇO SUSPENSÃO FRENTE ESQUERDO</p> <p>OPEL TIGRA (S93) 1.4 16V (F07) 07.1994/12.2000 66KW 90CV 1389CC X 14 XE 0039933 - OPEL TIGRA (S93) 1.4 16V (F07) 08.1997/12.2000 63KW 86CV 1389CC X 14 XE - OPEL TIGRA (S93) 1.6 16V (F07) 07.1994/08.1998 78KW 106CV 1598CC X 16 XE 0039934</p> <p>170x130x60mm 1f-d14mm 3f-d14mm 2f-d9mm</p>
	<p>S2032 NO. 353283 - 353562 - 90539057 - 90539058 - 90539059</p> <p>SILENT-BLOC DO BRAÇO SUSPENSÃO DA FRENTE PARTE INFERIOR</p> <p>OPEL TIGRA (S93) 1.4 16V (F07) 07.1994/12.2000 66KW 90CV 1389CC X 14 XE 0039933 - OPEL TIGRA (S93) 1.4 16V (F07) 08.1997/12.2000 63KW 86CV 1389CC X 14 XE - OPEL TIGRA (S93) 1.6 16V (F07) 07.1994/08.1998 78KW 106CV 1598CC X 16 XE 0039934 - OPEL TIGRA (S93) 1.6 16V (F07) 08.1997/08.1998 74KW 100CV 1598CC C 16 SEL</p> <p>d62x 35mm c-24mm dc-58mm1f-d14mm</p>		<p>T0039 NO. 0350127 - 350109 - 350119 - 350127 - 90168602 - 90236108 - 90447946</p> <p>BATENTE DO CENTRO DA BARRA ESTABILIZADORA</p> <p>OPEL TIGRA (S93): 1.4 16V (F07) 08.1997/12.2000 63KW 86CV 1389CC - OPEL TIGRA (S93): 1.4 16V (F07) 07.1994/12.2000 66KW 90CV 1389CC - OPEL TIGRA (S93): 1.6 16V (F07) 08.1997/08.1998 74KW 100CV 1598CC - OPEL TIGRA (S93): 1.6 16V (F07) 07.1994/08.1998 78KW 106CV 1598CC</p> <p>40x37x34mm 1f-d21mm</p>
	<p>UAP81292 NO. 0821038 - 0821074 - 0821437 - 0821675 - 4708869 - 4809347 - 821038 - 821074 - 821437 - 821675</p> <p>ANILHA PROTEÇÃO TÉRMICA INJECTORES</p> <p>OPEL TIGRA TwinTop (X04) 1.3 CDTI (R97) (De 06-2004 Até 12-2010) 51kW 69CV 1248cc Cabriolet</p> <p>d16x1mm 1f-d7mm</p>		<p>UAP81292 NO. 0821038 - 0821074 - 0821437 - 0821675 - 4708869 - 4809347 - 821038 - 821074 - 821437 - 821675</p> <p>ANILHA PROTEÇÃO TÉRMICA INJECTORES</p> <p>OPEL TIGRA TwinTop (X04) 1.3 CDTI (R97) (De 06-2004 Até 12-2010) 51kW 69CV 1248cc Cabriolet</p> <p>d16x1mm 1f-d7mm</p>
	<p>UMB84019 NO. 2060668</p> <p>TAMPÃO BLOCO MOTOR</p> <p>OPEL TIGRA (S93) 1.4 16V (F07) (De 07-1994 Até 12-2000) 66kW 90CV 1389cc Coupé OPEL TIGRA (S93) 1.6 16V (F07) (De 07-1994 Até 08-1998) 78kW 106CV 1598cc Coupé OPEL TIGRA TwinTop (X04) 1.8 (De 06-2004 Até ...) 92kW 125CV 1796cc Cabriolet</p> <p>d-26x9,5mm di-23,3mm</p>		<p>UMB84019L NO. 2060668</p> <p>TAMPÃO BLOCO DE MOTOR (RELAS)</p> <p>OPEL TIGRA (S93) 1.4 16V (F07) (De 07-1994 Até 12-2000) 66kW 90CV 1389cc Coupé OPEL TIGRA (S93) 1.6 16V (F07) (De 07-1994 Até 08-1998) 78kW 106CV 1598cc Coupé OPEL TIGRA TwinTop (X04) 1.8 (De 06-2004 Até ...) 92kW 125CV 1796cc Cabriolet</p> <p>d-26x9,5mm di-23,3mm</p>
	<p>UMB84021 NO. 2060673</p> <p>TAMPÃO BLOCO MOTOR</p> <p>OPEL TIGRA (S93 1.4 16V (F07) - OPEL TIGRA Twin Top (X04) 1.8</p> <p>d-28x7mm di-25,6mm</p>		<p>UMB84021L NO. 2060673</p> <p>TAMPÃO BLOCO DE MOTOR (RELAS)</p> <p>OPEL TIGRA (S93 1.4 16V (F07) - OPEL TIGRA Twin Top (X04) 1.8</p> <p>d-28x7mm di-25,6mm</p>
	<p>UMB84029 NO. 2060946</p> <p>TAMPÃO BLOCO MOTOR</p> <p>OPEL TIGRA (S93) 1.4 16V (F07) (08.97 A 12.00) 86cv 1389cc Coupé - OPEL TIGRA TwinTop (X04) 1.8 (R97) (06.04 A 12.10) 125cv 1796cc Cabriolet</p> <p>d36x10mm di-32mm</p>		<p>UTR0800 NO. 1304240 - 1304654 - 1304659 - 1304660 - 1304661 - 1304665 - 1304666 - 1304667 - 1304853 - 90352470 - ...</p> <p>TAMPÃO RESERVATÓRIO LÍQUIDO REFRIGERAÇÃO</p> <p>OPEL TIGRA (S93) 1.4 16V 08.97 - 12.00 63 86 1389 Coupé OPEL TIGRA (S93) 1.4 16V 07.94 - 12.00 66 90 1389 Coupé OPEL TIGRA (S93) 1.6 16V 08.97 - 08.98 74 100 1598 Coupé OPEL TIGRA (S93) 1.4 16V 07.94 - 08.98 78 106 1598 Coupé OPEL TIGRA TwinTop (X04) 1.4 06.04 - 66 90 1364 Cabriolet OPEL TIGRA TwinTop (X04) 1.8 06.04 - 92 125 1796 Cabriolet OPEL TIGRA TwinTop (X04) 1.3 CDTI 06.04 - 51 69 1248 Cabr...</p> <p>d62x25mm 1f-d53x14mm</p>

	<p>UTR0820 NO. 90352470 - 90409256 - 90409257 - 9041032690497472 - 90467473</p> <p>TAMPÃO RESERVATÓRIO LIQUIDO REFRIGERAÇÃO</p> <p>OPEL TIGRA (75_) 1.4 16V (07.94 A 12.00) 90cv 1389cc Coupé - OPEL TIGRA (75_) 1.6 16V (07.94 A 08.98) 106cv 1598cc Coupé - OPEL TIGRA TwinTop 1.4 (A Partir de 06.04) 90cv 1364cc Cabriolet - OPEL TIGRA TwinTop 1.8 (A Partir de 06.04) 125cv 1796cc Cabriolet - OPEL TIGRA TwinTop 1.3 CDTi (A Partir de 06.04) 69cv 1248cc Cabriolet</p> <p>d62x23mm 1f-d53x12mm</p>		<p>UTR1305 NO. 0650089 - 650089</p> <p>TAMPÃO DO RESERVATÓRIO ÓLEO</p> <p>OPEL TIGRA (S93) 1.4 16V (F07) (07.1994 - 12.2000) 66kw 90cv 1389cm3 Coupé OPEL TIGRA (S93) 1.6 16V (F07) (07.1994 - 08.1998) 78kw 106cv 1598cm3 Coupé OPEL TIGRA TwinTop (X04) 1.3 CDTi (R97) (06.2004 - 12.2010) 51kw 69cv 1248cm3 Cabriolet OPEL TIGRA TwinTop (X04) 1.4 (R97) (06.2004 - 12.2010) 66kw 90cv 1364cm3 Cabriolet OPEL TIGRA TwinTop (X04) 1.8 (R97) (06.2004 - 12.2010) 92kw 125cv 1796cm3 Cabriolet...</p> <p>d61x23mm d32x19mm</p>
	<p>UTV83011 NO. 0652475 - 09275631 - 652475 - 652491 - 90409376 - 9275631 - N90288901</p> <p>TAMPÃO VEDAÇÃO BUJÃO</p> <p>OPEL TIGRA (S93) 1.4 16V (F07) (De 07-1994 Até 12-2000) 66kW 90CV 1389cc Coupé OPEL TIGRA (S93) 1.6 16V (F07) (De 07-1994 Até 08-1998) 78kW 106CV 1598cc Coupé</p> <p>19x18mm c12mm d14mm</p>		<p>UTV83019 NO. 0652315 - 0652477 - 652315 - 652477 - 90502556 - 96023264</p> <p>TAMPÃO VEDAÇÃO BUJÃO</p> <p>OPEL TIGRA TwinTop (X04) 1.4 (R97) (De 06-2004 Até 12-2010) 66kW 90CV 1364cc Cabriolet OPEL TIGRA TwinTop (X04) 1.8 (R97) (De 06-2004 Até 12-2010) 92kW 125CV 1796cc Cabriolet</p> <p>d25x14mm c9mm d13mm</p>
	<p>W5054 NO. 0614150 - 5614438 - 614150 - 93177317 - 93194443</p> <p>POLIE DA CAMBOTA (6 PISTAS)</p> <p>OPEL TIGRA TWINTOP 1.3 CDTi Motor Z13DT (70CV) (APÓS 06-2004)</p> <p>d165mm d35mm</p>		<p>W5107 NO. 5614425 - 5614431 - 9129209</p> <p>POLIE DA CAMBOTA (5 PISTAS)</p> <p>OPEL TIGRA Twin Top 1.8 Z 18 XE (APÓS 06-2004)</p> <p>d160m 1f-d26mm</p>
	<p>Y3212 NO. 1008501 - 1008504 - 4709077</p> <p>PARAFUSO PERNO RODA CHAVE 17 M12X1,50X48MM (BASE CONICA PARA JANTES AÇO E LIGA LEVE)</p> <p>OPEL TIGRA (S93) 1.4 16V (F07) (07.1994 - 12.2000) 66kw 90cv 1389cm3 Coupé OPEL TIGRA (S93) 1.6 16V (F07) (07.1994 - 08.1998) 78kw 106cv 1598cm3 Coupé OPEL TIGRA TwinTop (X04) 1.3 CDTi (R97) (06.2004 - 12.2010) 51kw 69cv 1248cm3 Cabriolet OPEL TIGRA TwinTop (X04) 1.4 (R97) (06.2004 - 12.2010) 66kw 90cv 1364cm3 Cabriolet OPEL TIGRA TwinTop (X04) 1.8 (R97) (06.2004 - 12.2010) 92kw 125cv 1796cm3 Cabr...</p> <p>C48mm (Ch-17mm) M12x1,50x22mm</p>		<p>Z80655 NO. 2338955 - 2338961 - 2346824 - 8964.57 - 8964.81 - 90283614 - 90431553</p> <p>MOLA REVESTIMENTO DO HABITÁCULO</p> <p>OPEL TIGRA (S93) 1.4 16V (F07) 07.1994/12.2000 66KW 90CV 1389CC X 14 XE 0039933 - OPEL TIGRA (S93) 1.4 16V (F07) 08.1997/12.2000 63KW 86CV 1389CC X 14 XE - OPEL TIGRA (S93) 1.6 16V (F07) 07.1994/08.1998 78KW 106CV 1598CC X 16 XE 0039934 - OPEL TIGRA (S93) 1.6 16V (F07) 08.1997/08.1998 74KW 100CV 1598CC C 16 SEL</p> <p>d14x17.5mm 1p-d8-15.5mm</p>
	<p>Z80662 NO. 1218604 - 90386374</p> <p>MOLA SUPORTE FAROL PRINCIPAL (GASTA 2 UNIDADES)</p> <p>OPEL TIGRA (S93): 1.4 16V (F07) 07.1994/12.2000 66KW 90CV 1389CC - OPEL TIGRA (S93): 1.6 16V (F07) 07.1994/08.1998 78KW 106CV 1598CC</p> <p>26x23.4x20mm</p>		<p>Z80743 NO. 2345957</p> <p>Mola de painel</p> <p>OPEL TIGRA</p> <p>d17x19mm 1p-d9-13mm</p>
	<p>Z9004 NO. 856563</p> <p>MOLA DE ESCAPE</p> <p>OPEL TIGRA (APÓS 1994)</p> <p>25x22x5mm</p>		<p>Z9011 NO. 1261479 - 1449282600 - 4709339 - 4711509 - 854880</p> <p>MOLA DE ESCAPE</p> <p>OPEL TIGRA</p> <p>d23x42mm</p>

OPEL VECTRA

	<p>A1406 NO. 0650702 - 90233962</p> <p>APOIO MOTOR ESQUERDO</p> <p>OPEL VECTRA</p> <p>d20x15mm 1p-d6-10mm 1p-d6-15mm</p>		<p>E0147 NO. 350260 - 90278579 - 90278586</p> <p>ESTICADOR DA BARRA ESTABILIZADORA DA FRENTE</p> <p>OPEL VECTRA (A) TT</p> <p>100x50x35mm 1f-d21mm 1p-d8-28mm</p>
---	---	--	--

	<p>KF9023 NO. 1609095 - 90512778</p> <p>KIT DE FOLE DA DIREÇÃO</p> <p>OPEL VECTRA B Hatchback (38_) 1.6 i (10.95 A 07.03) 75cv 1598cc Hatchback - OPEL VECTRA B Hatchback (38_) 1.8 i 16V (10.95 A 09.00) 116cv 1796cc Hatchback - OPEL VECTRA B Hatchback (38_) 1.8 i 16V (09.00 A 07.03) 125cv 1796cc Hatchback - OPEL VECTRA B Hatchback (38_) 1.7 TD (10.95 A 12.98) 82cv 1686cc Hatchback - OPEL VECTRA B Hatchback (38_) 2.0 DTI 16V (06.97 A 07.03) 101cv 1995cc Hatchback...</p> <p>d65x155mm 1f-d14mm 1f-d48mm</p>		<p>N2335 NO. 175538</p> <p>ANEL ESCAPE</p> <p>OPEL VECTRA</p> <p>d65x15mm 1f-d36mm</p>
	<p>N2335 NO. 852711 - 852713</p> <p>ANEL ESCAPE</p> <p>OPEL VECTRA</p> <p>d65x15mm 1f-d36mm</p>		<p>N2336 NO. 852711</p> <p>ANEL ESCAPE</p> <p>OPEL VECTRA A Hatchback (J89): 2.0 i 16V (F68, M68) 08.1992/08.1995 100KW 136CV 1998CC - OPEL VECTRA A Hatchback (J89): 2.0 i 16V (F68, M68) 02.1989/10.1990 110KW 150CV 1998CC - OPEL VECTRA A Hatchback (J89): 2.0 i 16V Cat (F68, M68) 02.1990/11.1995 110KW 150CV 1998CC - OPEL VECTRA A Hatchback (J89): 2.5 V6 (F68, M68) 02.1993/11.1995 125KW 170CV 2498CC - OPEL VECTRA A (J89): 2.0 i 16V (F19, M19) 0...</p> <p>d62x14mm 1f-d36mm</p>
	<p>R8078 NO. 1336328 - 1337393 - 90322911 - 90570033</p> <p>TUBO DE LIGAÇÃO À BOMBA DE ÁGUA</p> <p>OPEL VECTRA A (J89) 2.0 i 16V (F19, M19) 08.1992/08.1995 100KW 136CV 1998CC X 20 XEV 0039917 - OPEL VECTRA A (J89) 2.0 i 16V 4x4 (F19, M19) 06.1994/11.1995 100KW 136CV 1998CC X 20 XEV 0039919 - OPEL VECTRA A (J89) 2000 16V 4x4 (F19, M19) 01.1989/10.1990 110KW 150CV 1998CC 20 XEJ 0039817 - OPEL VECTRA A (J89) 2000/GT 16V (F19, M19) 01.1989/06.1994 110KW 150CV 1998CC 20 XEJ 0039816 0039883 - OPEL VE...</p> <p>B171-d40/34mm d27mm 45-90-45mm 85-80mm</p>		<p>S1472 NO. 352358 - 90468638</p> <p>SILENT BLOC DO BRAÇO SA SUSPENSÃO DA FRENTE</p> <p>OPEL VECTRA B Hatchback (J96): 1.6 i (F68) 10.1995/07.2003 55KW 75CV 1598CC - OPEL VECTRA B Hatchback (J96): 1.6 i (F68) 10.1995/07.2003 55KW 75CV 1598CC - OPEL VECTRA B Hatchback (J96): 1.6 i 16V (F68) 10.1995/07.2002 74KW 101CV 1598CC - OPEL VECTRA B Hatchback (J96): 1.8 i 16V (F68) 10.1995/09.2000 85KW 116CV 1796CC - OPEL VECTRA B Hatchback (J96): 1.8 i 16V (F68) 10.1995/09.2000 85KW 116CV 1799...</p> <p>d61x60mm c42mm d48.5mm 1f-d12mm</p>
	<p>T0644-I NO. 0436933 - 436933 - 90495617</p> <p>BATENTE SUSPENSÃO DA FRENTE</p> <p>OPEL VECTRA B Hatchback (38_) 1.6 i (10.95 A 07.03) 75cv 1598cc Hatchback - OPEL VECTRA B Hatchback (38_) 1.6 i 16V (10.95 A 07.02) 101cv 1598cc Hatchback - OPEL VECTRA B Hatchback (38_) 1.8 i 16V (10.95 A 09.00) 116cv 1796cc Hatchback - OPEL VECTRA B Hatchback (38_) 1.8 i 16V (09.00 A 07.03) 125cv 1796cc Hatchback - OPEL VECTRA B Hatchback (38_) 2.0 i 16V (10.95 A 09.00) 136cv 1998cc Hatchba...</p> <p>d56x140mm 1f-d17mm 1f-d10mm</p>		<p>Z55254 NO. 2317703</p> <p>MOLA REBITE FIXAÇÃO</p> <p>OPEL VECTRA</p> <p>d5.5x 16mm f-d11mm</p>
	<p>Z9004 NO. 856563</p> <p>MOLA DE ESCAPE</p> <p>OPEL VECTRA (APÓS 1995)</p> <p>25x22x5mm</p>		

OPEL VECTRA A

	<p>A1210 NO. 682556 - 682601 - 684648</p> <p>APOIO TRÁS DE MOTOR</p> <p>OPEL VECTRA A (J89) 1.4 S (F19, M19) 09.1988/06.1992 55KW 75CV 1389CC 14 NV - OPEL 1.6 (F19, M19) 09.1988/05.1993 60KW 82CV 1598CC 16 SV 0039794 - OPEL VECTRA A (J89) 1.6 i (F19, M19) 09.1988/11.1995 55KW 75CV 1598CC C 16 NZC 16 NZ2E 16 NZ 0039793 - OPEL VECTRA A (J89) 1.6 i (F19, M19) 09.1993/11.1995 52KW 71CV 1598CC X 16 SZ 0039903 - OPEL VECTRA A (J89) 1.7 D (F19, M19) 10.1988/09.1992 42KW 57CV...</p> <p>150x98x57mm 2p-d10-20mm 2f-d10mm</p>		<p>A1213 NO. 682504 - 682558 - 682566</p> <p>APOIO TRÁS DE MOTOR</p> <p>OPEL VECTRA A (J89) 1.4 S (F19, M19) 09.1988/06.1992 55KW 75CV 1389CC 14 NV - OPEL 1.6 (F19, M19) 09.1988/05.1993 60KW 82CV 1598CC 16 SV 0039794 - OPEL VECTRA A (J89) 1.6 i (F19, M19) 09.1988/11.1995 55KW 75CV 1598CC C 16 NZC 16 NZ2E 16 NZ 0039793 - OPEL VECTRA A (J89) 1.6 i (F19, M19) 09.1993/11.1995 52KW 71CV 1598CC X 16 SZ 0039903 - OPEL VECTRA A (J89) 1.7 D (F19, M19) 10.1988/09.1992 42KW...</p> <p>150x98x57mm 2p-d10-20mm 2f-d10mm</p>
	<p>A1217 NO.</p> <p>APOIO DO AMOTECEDOR DA FRENTE</p> <p>OPEL VECTRA A 1.8i - 1.8S - 2.0 - 2.0i 16v 4x4</p> <p>d104x32mm 1f-d21mm</p>		<p>A1219 NO. 0344514 - 0344520 - 344514 - 344520 - 90289421 - 90468447</p> <p>APOIO DO AMOTECEDOR DA FRENTE</p> <p>OPEL VECTRA A 1.4S - 1.6i - 1.7D - 1.7TD - 1.8i - 1.8S - 2.0i - 2.0i 4x4 - 2.5CD - 2.5 V6</p> <p>d113x42mm 1f-d12mm</p>

	<p>A1392 NO. 684282 - 684291 - 684667 - 902783347</p> <p>APOIO DO MOTOR FRENTE DIREITO</p> <p>OPEL VECTRA A DIESEL 1.8i - 1.8i CAT - 1.8S - 2.0i - 2.0i CAT - 2.0i GT (1988 A 1995)</p> <p>185x95x67mm 2f-d11mm</p>		<p>A1394 NO. 684646 - 90372425</p> <p>APOIO MOTOR FRENTE DIREITO</p> <p>OPEL VECTRA A 2.0 - 2.0i - 2.0i CAT (1988 A 1995)</p> <p>175x95x60mm 1f-d12mm</p>
	<p>A1553 NO. 0684644 - 684644 - 90335498</p> <p>APOIO DO MOTOR FRENTE LADO DIREITO</p> <p>OPEL VECTRA A (9-88 A 9-95) 1.7 TD (1988 A 1995)</p> <p>180x95x80mm</p>		<p>A2242 NO. 0817744 - 817744 - 90080552</p> <p>APOIO DA BOMBA DO COMBUSTIVEL</p> <p>OPEL VECTRA A Hatchback (J89) 2.0 (F68, M68) (De 1988.04 Até 1989.09) 74kW 100cv 1998cm3 Hatchback - OPEL VECTRA A Hatchback (J89) 2.0i (F68, M68) (De 1988.09 Até 1990.10) 85kW 115cv 1998cm3 Hatchback - OPEL VECTRA A Hatchback (J89) 2.0i Cat (F68, M68) (De 1988.09 Até 1995.11) 85kW 116cv 1998cm3 Hatchback - OPEL VECTRA A Hatchback (J89) 2.0i GT (F68, M68) (De 1988.09 Até 1995...</p> <p>19x21mm 2p-d8x14mm</p>
	<p>A2360 NO. 0344513 - 344513 - 90268464</p> <p>APOIO SUPORTE AMORTECEDOR FRENTE (GASTA 2 UNIDADES)</p> <p>OPEL VECTRA A (J89) 1.8 S (F19, M19) (De 09.1988 Até 07.1989) 989kW 65cv 88cm3 1796 - OPEL VECTRA A (J89) 1.8 S (F19, M19) (De 09.1989 Até 10.1990) 7182kW 66cv 90cm3 1796 - OPEL VECTRA A (J89) 2.0 (F19, M19) (De 09.1988 Até 09.1989) 997kW 74cv 100cm3 1998 OPEL VECTRA A Hatchback (J89) 1.8 S (F68, M68) (De 09.1988 Até 07.1989) 993kW 65cv 88cm3 1796 - OPEL VECTRA A Hatchback (J89) 1.8 i (F68, M68) (...)</p> <p>d113x44mm 1f-d15mm</p>		<p>C0233 NO. 1160724 - 90054143</p> <p>BOTÃO AFINAÇÃO CAPÔT</p> <p>OPEL VECTRA A Hatchback (88_89_) 1.6 i (09.93 A 11.95) 71cv 1598cc Hatchback - OPEL VECTRA A Hatchback (88_89_) 1.6 i Cat (09.88 A 11.95) 75cv 1598cc Hatchback - OPEL VECTRA A Hatchback (88_89_) 1.6 S (09.88 A 05.93) 82cv 1598cc Hatchback - OPEL VECTRA A Hatchback (88_89_) 1.8 S (09.88 A 07.89) 88cv 1796cc Hatchback - OPEL VECTRA A Hatchback (88_89_) 1.8 i (09.88 A 10.90) 90cv 1796cc...</p> <p>d19x31mm</p>
	<p>E0085 NO. 350261 - 90278577</p> <p>ESTICADOR BARRA ESTABILIZADORA FRENTE FURO 18MM (GASTA 2 UNIDADES)</p> <p>OPEL VECTRA A (J89) 1.4 S (F19, M19) 09.1988/06.1992 55kW 75CV 1389CC 14 NV - OPEL VECTRA A (J89) 1.6 (F19, M19) 09.1988/05.1993 60kW 82CV 1598CC 16 SV 0039794 - OPEL VECTRA A (J89) 1.6 i (F19, M19) 09.1988/11.1995 55kW 75CV 1598CC C 16 NZ C 16 NZ2 E 16 NZ 0039793 - OPEL VECTRA A (J89) 1.6 i (F19, M19) 09.1993/11.1995 52kW 71CV 1598CC X 16 SZ 0039903 - OPEL VECTRA A (J89) 1.7 D (F19, M19) 10.1988/...</p> <p>110x40x35mm</p>		<p>E0128 NO. 0350263 - 350263 - 4544599 - 90495045</p> <p>ESTICADOR DA BARRA ESTABILIZADORA DA FRENTE</p> <p>OPEL VECTRA A 1.4S - 1.6i - 1.7D - 1.7TD - 1.8 - 1.8S 4x4 - 2.0 - 2.0i 4x4 - 2.5CD - 2.5 V6 (1988 A 1995)</p> <p>105x34x34mm 1p-d12-25mm</p>
	<p>E1007 NO. 852722</p> <p>ESTICADOR SUPORTE DE ESCAPE</p> <p>OPEL VECTRA A 1.4S - 1.6i - 1.7D - 1.7TD - 1.8i - 1.8S - 2.0i - 2.0i 4x4 - 2.5 CD - 2.5 V6</p> <p>70x47x40mm</p>		<p>E1071 NO. 852723 - 90352773</p> <p>ESTICADOR DE ESCAPE</p> <p>OPEL VECTRA A 1.4S - 1.6i - 1.7D - 1.7TD - 1.8i - 1.8S - 2.0i - 2.0i 4x4 - 2.5CD - 2.5 V6 (1988 A 1995)</p> <p>72x61x20mm</p>
	<p>E23401-V NO. 0758801 - 758801 - 90250156</p> <p>ESTICADOR MANETE CAIXA DE VELOCIDADES</p> <p>OPEL VECTRA A Hatchback (J89) 1.4 S (F68 - M68) (De 04-1988 Até 06-1992) 55kW 75CV 1389cc Hatchback OPEL VECTRA A Hatchback (J89) 1.6 i (F68 - M68) (De 09-1993 Até 11-1995) 52kW 71CV 1598cc Hatchback OPEL VECTRA A Hatchback (J89) 1.6 i Cat (F68 - M68) (De 09-1988 Até 11-1995) 55kW 75CV 1598cc Hatchback OPEL VECTRA A Hatchback (J89) 1.6 S (De 09-1988 Até 05-1993) 60kW 82CV 1598cc Hatchback OPEL...</p> <p>207x17x18mm 2f-d11mm</p>		<p>F0466-I NO. 0902825 - 0902828 - 0902829 - 26024585 - 572658 - 90090811 - 902825 - 902828 - 902829 - 90345185 ...</p> <p>FOLE DIRECÇÃO DIREITO/ESQUERDO (GASTA 2 UNIDADES)</p> <p>OPEL VECTRA A (J89) 1.4 S (F19, M19) 09.1988/06.1992 55kW 75CV 1389CC 14 NV - OPEL VECTRA A (J89) 1.6 (F19, M19) 08.1992/07.1993 51kW 69CV 1598CC C 16 LZ2 - OPEL VECTRA A (J89) 1.6 (F19, M19) 09.1988/05.1993 60kW 82CV 1598CC 16 SV 0039794 - OPEL VECTRA A (J89) 1.6 i (F19, M19) 09.1993/11.1995 52kW 71CV 1598CC X 16 SZ 0039903 - OPEL VECTRA A (J89) 1.6 i (F19, M19) 09.1993/11.1995 55kW 75CV 1598CC C...</p> <p>d78x165mm 1f-d41mm 1f-d51mm</p>
	<p>F1285-I NO. 90236492</p> <p>FOLE DO SEMI-EIXO LADO DA RODA</p> <p>OPEL VECTRA A 1.6i (1988 A 1990)</p> <p>d99x85mm 1f-d83mm 1f-d20mm</p>		<p>F1305-I NO. 0902828 - 1609074 - 26024585</p> <p>FOLE DA DIRECÇÃO ASSISTIDA LADO DIREITO E ESQUERDO</p> <p>OPEL VECTRA A 1.6i - 1.7 D - 1.7 TD - 1.8i - 2.0i 16v - 2.5i V6 (1988 A 1995)</p> <p>d78x170mm 1f-d54mm 1f-d42mm</p>
	<p>F1337-I NO. 902829</p> <p>FOLE DA DIRECÇÃO ASSISTIDA (CAIXA ZF)</p> <p>OPEL VECTRA (A) 1.4S - 1.6 - 1.7D - 1.7TD - 1.8i - 1.8S - 2.0</p> <p>d57x425mm 2f-d51mm</p>		<p>F1350-I NO. 1609045 - 1609073 - 90188878 - 90398968 - 9943449</p> <p>FOLE DA DIRECÇÃO ASSISTIDA LADO DIREITO E ESQUERDO</p> <p>OPEL VECTRA A (J89) 1.4 S (F19, M19) 09.1988/06.1992 55kW 75CV 1389CC 14 NV - OPEL VECTRA A (J89) 1.6 (F19, M19) 09.1988/05.1993 60kW 82CV 1598CC 16 SV 0039794 - OPEL VECTRA A (J89) 1.6 (F19, M19) 08.1992/07.1993 51kW 69CV 1598CC C 16 LZ2 - OPEL VECTRA A (J89) 1.6 i (F19, M19) 09.1988/11.1995 55kW 75CV 1598CC C 16 NZ C 16 NZ2 E 16 NZ 0039793 - OPEL VECTRA A (J89) 1.6 i (F19, M19) 09.1993/11.1995 5...</p> <p>d74/63x125mm 1f-d50mm 1f-d38mm</p>

	<p>F1373-I NO. 1603141 - 374040 - 90009020 - 90112609 - 90421756</p> <p>FOLE DA TRANSMISSÃO JUNTO À CAIXA</p> <p>OPEL VECTRA A 1.6i - 1.7TD - 1.8S - 1.8i - 1.8i 16V - 2.0 - 2.0i - 2.0i 16V - 2.5i V6 (88 A 95)</p> <p>d87x99mm 1f-d65mm 1f-d22mm</p>		<p>F4094 NO. 0738978 - 5738414 - 738978 - 90373314 - 90437426</p> <p>FOLE ALAVANCA VELOCIDADES</p> <p>OPEL VECTRA A Hatchback (J89): 1.4 S (F68, M68) 04.1988/06.1992 55KW 75CV 1389CC - OPEL VECTRA A Hatchback (J89): 1.6 i (F68, M68) 09.1993/11.1995 52KW 71CV 1598CC - OPEL VECTRA A Hatchback (J89): 1.6 i (F68, M68) 09.1993/11.1995 55KW 75CV 1598CC - OPEL VECTRA A Hatchback (J89): 1.6 i (F68, M68) 09.1988/11.1995 55KW 75CV 1598CC - OPEL VECTRA A Hatchback (J89): 1.6 S 09.1988/05.1993 60KW 82CV 1...</p> <p>170x120x220mm 1f-160x105mm 1f-d50mm</p>
	<p>F4126 NO. 578794 - 90331615</p> <p>FOLE ALAVANCA TRAVÃO DE MÃO</p> <p>OPEL VECTRA A Hatchback (J89): 1.6 i (F68, M68) 09.1993/11.1995 52KW 71CV 1598CC - OPEL VECTRA A Hatchback (J89): 1.6 i (F68, M68) 09.1993/11.1995 55KW 75CV 1598CC - OPEL VECTRA A (J89): 1.6 i (F19, M19) 09.1993/11.1995 52KW 71CV 1598CC - OPEL VECTRA A (J89): 1.6 i (F19, M19) 09.1993/11.1995 55KW 75CV 1598CC</p> <p>223x43x190mm 1f-185x38mm</p>		<p>KF2340 NO. 1603179 - 374050 - 90125491</p> <p>FOLE DO LADO DA RODA</p> <p>OPEL VECTRA A 1.4 - 1.6i - 1.7D - 1.8i - 2.0i - 2.5i</p> <p>d103x78mm 1f-d22mm 1f-d82mm</p>
	<p>KF2345 NO. 374190 - 90236762</p> <p>FOLE DO LADO DA RODA</p> <p>OPEL VECTRA A 1.6i (1988 A 1995)</p> <p>d90x82mm 1f-d19mm 1f-d75mm</p>		<p>L3020 NO. 0856700 - 856700 - 9275758</p> <p>CASQUILHO DE ESCAPE</p> <p>OPEL VECTRA A Hatchback (J89): 1.4 S (F68, M68) 04.1988/06.1992 55KW 75CV 1389CC - OPEL VECTRA A Hatchback (J89): 1.6 S 09.1988/05.1993 60KW 82CV 1598CC - OPEL VECTRA A Hatchback (J89): 1.8 S (F68, M68) 09.1988/07.1989 65KW 88CV 1796CC - OPEL VECTRA A Hatchback (J89): 1.8 i (F68, M68) 09.1988/10.1990 66KW 90CV 1796CC - OPEL VECTRA A Hatchback (J89): 1.8 i Cat (F68, M68) 03.1990/11.1995 66KW 90CV 1...</p> <p>d29x12mm d26/di19x8mm 1f-d9mm</p>
	<p>L3182 NO. 0444325 - 0444326 - 0444336 - 0444348 - 444325 - 444336 - 444348 - 6655341 - 8971400891 - 90343305 - ...</p> <p>CASQUILHO DA BARRA ESTABILIZADORA DE TRÁS</p> <p>OPEL VECTRA A</p> <p>d26x28mm d24mm 1f-d13mm</p>		<p>M6003 NO. 854952</p> <p>JUNTA DE ESCAPE</p> <p>OPEL VECTRA A 1.4S - 1.6i - 1.7D - 1.7TD</p> <p>d59x13.5mm 1f-d45mm</p>
	<p>M6008 NO. 854943</p> <p>JUNTA DE ESCAPE</p> <p>OPEL VECTRA A Hatchback (J89): 1.7 TD (F68, M68) 03.1990/11.1995 60KW 82CV 1686CC - OPEL VECTRA A (J89): 1.7 TD (F19, M19) 03.1990/11.1995 60KW 82CV 1686CC</p> <p>d65x5mm 1f-d50mm</p>		<p>M6041 NO. 854842 - 90091769</p> <p>JUNTA DE ESCAPE</p> <p>OPEL VECTRA A 1.7D - 1.7TD</p> <p>142x68mm 2f-d50mm</p>
	<p>M6045 NO. 854936 - 90231063</p> <p>JUNTA DE ESCAPE</p> <p>OPEL VECTRA A 1.7D - 1.7TD (1988 A 1995)</p> <p>95x92mm 1f-d55mm</p>		<p>M6060 NO. 90423152</p> <p>JUNTA DE ESCAPE</p> <p>OPEL VECTRA A (1988 A 1995)</p> <p>93x95mm 1f-d60mm</p>
	<p>M6068 NO. 0852800 - 0852801 - 174510R030 - 21101206057 - 52005431 - 6616585 - 6616985 - 6688869 - 6745091 - 82...</p> <p>JUNTA DE ESCAPE</p> <p>OPEL VECTRA A (1998 A 1989)</p> <p>d71x13mm 1f-d56mm</p>		<p>M6082 NO. 854943 - 854944 - 854955 - 97069287</p> <p>JUNTA DE ESCAPE</p> <p>OPEL VECTRA A (1992 A 1995)</p> <p>d64x5mm 1f-d53mm</p>
	<p>P1012 NO. 0560808 - 560808 - 90105172</p> <p>CAPA PEDAL EMBRAIAGEM/TRAVAO (GASTA 2 UNIDADES)</p> <p>OPEL VECTRA A Hatchback (J89): 1.4 S (F68, M68) 04.1988/06.1992 55KW 75CV 1389CC - OPEL VECTRA A Hatchback (J89): 1.6 i (F68, M68) 09.1993/11.1995 52KW 71CV 1598CC - OPEL VECTRA A Hatchback (J89): 1.6 i (F68, M68) 09.1993/11.1995 55KW 75CV 1598CC - OPEL VECTRA A Hatchback (J89): 1.6 i (F68, M68) 09.1988/11.1995 55KW 75CV 1598CC - OPEL VECTRA A Hatchback (J89): 1.6 S 09.1988/05.1993 60KW 82CV 1...</p> <p>60x55x9mm</p>		<p>R080249 NO. 1336062 - 90265800 - 90322216</p> <p>TUBO RÍGIDO REFRIGERAÇÃO</p> <p>OPEL VECTRA A (J89) 1.6 (F19, M19) 09.1988/05.1993 60KW 82CV 1598CC 16 SV 0039794 - OPEL VECTRA A (J89) 1.6 i (F19, M19) 09.1988/11.1995 55KW 75CV 1598CC C 16 NZ C 16 NZ E 16 NZ 0039793 - OPEL VECTRA A (J89) 1.6 i (F19, M19) 09.1993/11.1995 55KW 75CV 1598CC C 16 LZ2 16 LZ2 - OPEL VECTRA A (J89) 1.8 i Cat (F19, M19) 03.1990/11.1995 66KW 90CV 1796CC C 18 NZ 0039818 - OPEL VECTRA A (J89) 1.8 S (F19,...</p> <p>B325-34/32mm 284-80mm 2f-d7mm 3p-d15x26mm</p>





	<p>R220543 NO. 1336323 - 1336410 - 1336486 - 90128699 - 90215368 - 90265772</p> <p>TUBO RADIADOR INFERIOR</p> <p>OPEL VECTRA A Hatchback (J89): 1.4 S (F68, M68) 04.1988/06.1992 55KW 75CV 1389CC - OPEL VECTRA A (J89): 1.4 S (F19, M19) 09.1988/06.1992 55KW 75CV 1389CC</p> <p>B460-d35/35mm 70-110-120-200-40-100mm</p>		<p>R221470 NO. 1336485 - 90265784</p> <p>TUBO SUPERIOR DO RADIADOR</p> <p>OPEL VECTRA A (J89) 1.4 S (F19, M19) (De 2009.1988 Até 2006.1992) 55kW 75cv 1389cm3 três volumes - OPEL VECTRA A (J89) 1.6 (F19, M19) (De 2009.1988 Até 2005.1993) 60kW 82cv 1598cm3 três volumes - OPEL VECTRA A Hatchback (J89) 1.4 S (De 2004.1988 Até 2006.1992) 55kW 75cv 1389cm3 Hatchback -</p> <p>B305-32/37mm 83x70x54x77mm</p>
	<p>R221475 NO. 1337019 - 1334423</p> <p>TUBO DE LIGAÇÃO À BOMBA DE ÁGUA</p> <p>OPEL VECTRA A (J89): 1.6 (F19, M19) 09.1988/05.1993 60KW 82CV 1598CC</p> <p>B151-29/39mm 38x57x54mm ch-d26x82x85x219mm</p>		<p>R221481 NO. 1336487</p> <p>TUBO INFERIOR DO RADIADOR</p> <p>OPEL VECTRA A Hatchback (J89) 1.8 S (F68 - M68) (De 09-1988 Até 07-1989) 65kW 88CV 1796cc Hatchback OPEL VECTRA A Hatchback (J89) 1.8 i (F68 - M68) (De 09-1988 Até 10-1990) 66kW 90CV 1796cc Hatchback OPEL VECTRA A Hatchback (J89) 2.0 (F68 - M68) (De 04-1988 Até 09-1989) 74kW 100CV 1998cc Hatchback OPEL VECTRA A (J89) 1.6 (F19 - M19) (De 09-1988 Até 05-1993) 60kW 82CV 1598cc três volumes OPEL V...</p> <p>B450-33/39mm 72-175-97-91mm</p>
	<p>R221485 NO. 1336812 - 1337463 - 90265803 - 90530796</p> <p>TUBO DE LIGAÇÃO À BOMBA DE ÁGUA</p> <p>OPEL VECTRA A (J89) 1.8 S (De 1988.09 Até 1989.07) 65kW 88cv 1796cm3 três volumes - OPEL VECTRA A (J89) 1.8 S (F19, M19) (De 1989.09 Até 1990.10) 66kW 90cv 1796cm3 três volumes - OPEL VECTRA A (J89) 2.0 (F19, M19) (De 1988.09 Até 1989.09) 74kW 100cv 1998cm3 três volumes - OPEL VECTRA A Hatchback (J89) 1.8 S (De 1988.09 Até 1989.07) 65kW 88cv 1796cm3 Hatchback -</p> <p>B195-32/33mm 47x47x55mm</p>		<p>R221490 NO. 1336499 - 90322608</p> <p>TUBO SUPERIOR DO RADIADOR</p> <p>OPEL VECTRA A (J89) 1.7 D (F19, M19) (De 1988.10 Até 1992.09) 42kW 57cv 1700cm3 três volumes - OPEL VECTRA A (J89) 1.7 D (F19, M19) (De 1992.07 Até 1995.11) 44kW 60cv 1700cm3 três volumes - OPEL VECTRA A (J89) 1.7 TD (F19, M19) (De 1990.03 Até 1995.11) 60kW 82cv 1686cm3 três volumes - OPEL VECTRA A Hatchback (J89) 1.7 D (F68, M68) (De 1988.09 Até 1992.09) 42kW 57cv 1700cm3 Ha...</p> <p>B195-32/33mm 49x73x64mm</p>
	<p>R221495 NO. 1337069</p> <p>TUBO SUPERIOR DO RADIADOR</p> <p>OPEL VECTRA A (J89) 1.7 TD (F19, M19) (De 1990.03 Até 1995.11) 60kW 82cv 1686cm3 três volumes - OPEL VECTRA A Hatchback (J89) 1.7 TD (De 1990.03 Até 1995.11) 60kW 82cv 1686cm3 Hatchback -</p> <p>B310-31/33mm 72x80x62x62mm</p>		<p>R222719 NO. 1336294 - 1337395 - 90128078 - 90166058 - 90570030</p> <p>TUBO DE LIGAÇÃO TERMOSTATO Á BOMBA DE ÁGUA</p> <p>OPEL VECTRA A (J89) 1.7 D (F19, M19) 10.1988/09.1992 42KW 57CV 1699CC 17 D 0039799 - OPEL VECTRA A (J89) 1.7 D (F19, M19) 07.1992/11.1995 44KW 60CV 1699CC 17 DR 0039882 - OPEL VECTRA A Hatchback (J89) 1.7 D (F68, M68) 09.1988/09.1992 42KW 57CV 1699CC 17 D 0039810 - OPEL VECTRA A Hatchback (J89) 1.7 D (F68, M68) 07.1992/11.1995 44KW 60CV 1699CC 17 DR 0039884</p> <p>boca a boca 137 mm d1 31mmd2 32mm</p>
	<p>R222740 NO. 1337095 - 90354836</p> <p>TUBO LIGAÇÃO TERMOSTATO BOMBA DE ÁGUA</p> <p>OPEL VECTRA A Hatchback (J89) 1.6 i (F68 - M68) (De 09-1993 Até 11-1995) 52kW 71CV 1598cc Hatchback OPEL VECTRA A Hatchback (J89) 1.6 i (F68 - M68) (De 09-1993 Até 11-1995) 55kW 75CV 1598cc Hatchback OPEL VECTRA A Hatchback (J89) 1.6 i Cat (F68 - M68) (De 09-1988 Até 11-1995) 55kW 75CV 1598cc Hatchback OPEL VECTRA A Hatchback (J89) 1.6 S (De 09-1988 Até 05-1993) 60kW 82CV 1598cc Hatchback OPEL...</p> <p>B138-28/38mm 32-57-51mm</p>		<p>R222769 NO. 1336509 - 1337465 - 90351806 - 90530799</p> <p>TUBO DE LIGAÇÃO AO TERMOSTATO</p> <p>OPEL VECTRA A (J89) 2.0 (F19, M19) 09.1988/09.1989 74K2 100CV 1998CC C 20 NEF 0039796 - OPEL VECTRA A Hatchback (J89) 2.0 (F68, M68) 04.1988/09.1989 74KW 100CV 1998CC C 20 NEF 0039805</p> <p>B220-d20/20mm 80-70-60-70-60mm</p>
	<p>R222811 NO. 650872</p> <p>TUBO DE LIGAÇÃO AO TERMOSTATO</p> <p>OPEL VECTRA A Hatchback (J89) 1.7 TD (F68, M68) (De 1990.03 Até 1995.11) 60kW 82cv 1686cm3 Hatchback - OPEL VECTRA A (J89) 1.7 TD (F19, M19) (De 1990.03 Até 1995.11) 60kW 82cv 1686cm3 três volumes -</p> <p>B57-15/15mm 50x22x50mm</p>		<p>R222812 NO. 650873</p> <p>TUBO LIGAÇÃO TERMOSTATO</p> <p>OPEL VECTRA A Hatchback (J89) 1.7 TD (F68 - M68) (De 03-1990 Até 11-1995) 60kW 82CV 1686cc Hatchback OPEL VECTRA A (J89) 1.7 TD (F19 - M19) (De 03-1990 Até 11-1995) 60kW 82CV 1686cc três volumes</p> <p>B97-14/14mm 60-41mm</p>
	<p>R222871 NO. 650872 - 650873</p> <p>TUBOS DE LIGAÇÃO AO TERMOSTATO</p> <p>OPEL VECTRA A (J89) 1.7 TD (F19, M19) 03.1990/11.1995 60KW 82CV 1686CC 17 TD 0039819 - OPEL VECTRA A Hatchback (J89) 1.7 TD (F68, M68) 03.1990/11.1995 60KW 82CV 1686CC 17 DT X 17 TD 0039821</p> <p>B113-14/14mm B56-16/16mm 40x1540mm</p>		<p>R2470 NO. 1336323 - M-220543</p> <p>TUBO INFERIOR DO RADIADOR</p> <p>OPEL VECTRA A (J89) 1.4 S (F19, M19) 09.1988/06.1992 55KW 75CV 1389CC 14 NV - OPEL VECTRA A Hatchback (J89) 1.4 S (F68, M68) 04.1988/06.1992 55KW 75CV 1389CC 14 NV</p> <p>B440-d35/35mm 115-205-100-110-70mm</p>
	<p>R8080 NO. 1336294 - 1337395 - 2101-1303090 - 90128078 - 90166058 - 90570030 - 90916-01013</p> <p>TUBO DO RADIADOR À BOMBA DE ÁGUA</p> <p>OPEL VECTRA A (J89) 1.7 D (F19, M19) 10.1988/09.1992 42KW 57CV 1699CC 17 D 0039799 - OPEL VECTRA A (J89) 1.7 D (F19, M19) 07.1992/11.1995 44KW 60CV 1699CC 17 DR 0039882 - OPEL VECTRA A (J89) 1.7 TD (F19, M19) 03.1990/11.1995 60KW 82CV 1686CC 17 TD 0039819 - OPEL VECTRA A Hatchback (J89) 1.7 D (F68, M68) 09.1988/09.1992 42KW 57CV 1699CC 17 D 0039810 - OPEL VECTRA A Hatchback (J89) 1.7 D (F68, M68) ...</p> <p>B140-d34/34mm 85-75mm</p>		<p>R8150 NO. 836791 - 90411677</p> <p>TUBO ADMISSÃO FILTRO DE AR</p> <p>OPEL VECTRA A (J89) 2.0 i 16V (F19, M19) 08.1992/08.1995 100KW 136CV 1998CC X 20 XEV 0039917 - OPEL VECTRA A (J89) 2.0 i 16V 4x4 (F19, M19) 06.1994/11.1995 100KW 136CV 1998CC X 20 XEV 0039919 - OPEL VECTRA A Hatchback (J89) 2.0 i 16V (F68, M68) 08.1992/08.1995 100KW 136CV 1998CC X 20 XEV 0039918</p> <p>B215-62/72mm 85-128mm ch-d18x42mm</p>

	<p>RF80245 NO. 0606401 - 606401</p> <p>TUBO DE FERRO REFRIGERAÇÃO</p> <p>OPEL VECTRA A Hatchback (J89) 1.8 S (F68 - M68) (De 09-1988 Até 07-1989) 65kW 88CV 1796cc Hatchback OPEL VECTRA A Hatchback (J89) 1.8 i (F68 - M68) (De 09-1988 Até 10-1990) 66kW 90CV 1796cc Hatchback OPEL VECTRA A Hatchback (J89) 1.8 i Cat (F68 - M68) (De 03-1990 Até 11-1995) 66kW 90CV 1796cc Hatchback OPEL VECTRA A Hatchback (J89) 2.0 (F68 - M68) (De 04-1988 Até 09-1989) 74kW 100CV 1998cc Hatc...</p> <p>d35x51mm c45mm 1f-d31</p>		<p>RF80248 NO. ch-d30-25mm ch-d15-25mm ch-d13-25m</p> <p>TUBO DE FERRO REFRIGERAÇÃO</p> <p>OPEL VECTRA A Hatchback (J89) 1.7 D (F68 - M68) (De 09-1988 Até 09-1992) 42kW 57CV 1700cc Hatchback OPEL VECTRA A Hatchback (J89) 1.7 D (F68 - M68) (De 07-1992 Até 11-1995) 44kW 60CV 1700cc Hatchback OPEL VECTRA A (J89) 1.7 D (F19 - M19) (De 10-1988 Até 09-1992) 42kW 57CV 1700cc três volumes OPEL VECTRA A (J89) 1.7 D (F19 - M19) (De 07-1992 Até 11-1995) 44kW 60CV 1700cc três volumes</p> <p>B470-28/34mm ch-d30-25mm ch-d15-25mm ch-d13-25mm 2f-9mm...</p>
	<p>RT08545 NO. 562345 - 562350 - 562358 - 90235568 - 90374106 - 90468316 - 90468319</p> <p>TUBO DE TRAVÃO FRENTE LH-RH</p> <p>OPEL VECTRA A Hatchback (J89): 1.4 S (F68, M68) 04.1988/06.1992 55KW 75CV 1389CC - OPEL VECTRA A Hatchback (J89): 1.6 (F68, M68) 08.1992/07.1993 51KW 69CV 1598CC - OPEL VECTRA A Hatchback (J89): 1.6 i (F68, M68) 09.1993/11.1995 52KW 71CV 1598CC - OPEL VECTRA A Hatchback (J89): 1.6 i (F68, M68) 09.1993/11.1995 55KW 75CV 1598CC - OPEL VECTRA A Hatchback (J89): 1.6 i Cat (F68, M68) 09.1988/11.1995 55...</p> <p>310mm FB3/1 - OR1</p>		<p>S1127 NO. 352300 - 352346</p> <p>SILENT-BLOC DO BRAÇO DA SUSPENSÃO FRENTE DIAM.12mm</p> <p>OPEL VECTRA (A) 1.4S - 1.6 - 1.6i - 1.7TD - 1.8i - 1.8s - 2.0 - 2.0i TURBO 4x4</p> <p>d43x60mm d38mm 1f-d12mm</p>
	<p>S1128 NO. 90268463 - 0352317 - 0352348 - 352347 - 352348 - 353460 - 4246062 - 90250709</p> <p>SILENT-BLOC EXTERIOR DO BRAÇO DA SUSPENSÃO FRENTE DIAM.16mm</p> <p>OPEL VECTRA A 1.4S - 1.6i - 1.7D - 1.7TD - 1.8i - 1.8S - 2.0i - 2.0i 4x4</p> <p>d68x58mm d60mm 1f-d16mm</p>		<p>S1275 NO. 402642 - 90189050</p> <p>SILENT-BLOC DA SUSPENSÃO DE TRÁS</p> <p>OPEL VECTRA A Hatchback (J89): 1.4 S (F68, M68) 04.1988/06.1992 55KW 75CV 1389CC - OPEL VECTRA A Hatchback (J89): 1.6 i (F68, M68) 09.1993/11.1995 52KW 71CV 1598CC - OPEL VECTRA A Hatchback (J89): 1.6 i Cat (F68, M68) 09.1988/11.1995 55KW 75CV 1598CC - OPEL VECTRA A Hatchback (J89): 1.6 S 09.1988/05.1993 60KW 82CV 1598CC - OPEL VECTRA A Hatchback (J89): 1.8 S (F68, M68) 09.1988/07.1989 65KW 88CV ...</p> <p>d56x 75mm c-63mm dc-48mm1f-d12mm</p>
	<p>S1688 NO. 402937</p> <p>SILENT-BLOC DO EIXO DA SUSPENSÃO DE TRÁS</p> <p>OPEL VECTRA A Hatchback (J89) 1.4 S (F68 - M68) (De 04-1988 Até 06-1992) 55kW 75CV 1389cc Hatchback OPEL VECTRA A Hatchback (J89) 1.6 i (F68 - M68) (De 09-1993 Até 11-1995) 52kW 71CV 1598cc Hatchback OPEL VECTRA A Hatchback (J89) 1.6 i (F68 - M68) (De 09-1993 Até 11-1995) 55kW 75CV 1598cc Hatchback OPEL VECTRA A Hatchback (J89) 1.6 i Cat (F68 - M68) (De 09-1988 Até 11-1995) 55kW 75CV 1598cc Hat...</p> <p>d121x80mm c46mm 1f-d19mm</p>		<p>S2103 NO. 0402935 - 402935 - 90250986</p> <p>SILENT-BLOC DO EIXO SUSPENSÃO TRÁS</p> <p>OPEL VECTRA A (J89) 1.8 S 4x4 (F19, M19) 01.1989/07.1989 65KW 88CV 1796CC E 18 NVR 0039815 - OPEL VECTRA A (J89) 2.0 (F19, M19) 09.1988/09.1989 74KW 100CV 1998CC C 20 NEF 0039796 - OPEL VECTRA A (J89) 2.0 i (F19, M19) 09.1988/10.1990 85KW 115CV 1998CC 20 NE 0039797 - OPEL VECTRA A (J89) 2.0 i (F19, M19) 09.1988/09.1992 95KW 129CV 1998CC 20 SEH 0039798 - OPEL VECTRA A (J89) 2.0 i 16V (F19, M19) 08...</p> <p>d121x80mm c46mm d96mm 1f-d18mm</p>
	<p>T0646-I NO. 0344411 - 344411 - 90279302</p> <p>BATENTE SUSPENSÃO DA FRENTE</p> <p>OPEL VECTRA A Hatchback (88_ - 89_) 1.4 S (04.88 A 06.92) 75cv 1389cc Hatchback - OPEL VECTRA A Hatchback (88_ - 89_) 1.6 i (09.93 A 11.95) 71cv 1598cc Hatchback - OPEL VECTRA A Hatchback (88_ - 89_) 1.6 i (09.93 A 11.95) 75cv 1598cc Hatchback - OPEL VECTRA A Hatchback (88_ - 89_) 1.6 i Cat (09.88 A 11.95) 75cv 1598cc Hatchback - OPEL VECTRA A Hatchback (88_ - 89_) 1.6 S (09.88 A 05.93) 82cv...</p> <p>d49x67mm 1f-d27mm 1f-d20mm</p>		<p>T1049F24 NO. 350125 - 90447869</p> <p>BATENTE DO CENTRO DA BARRA ESTABILIZADORA</p> <p>OPEL VECTRA A 1.4S - 1.6i - 1.7D - 1.7TD - 1.8S - 2.0 - 2.5 V6 (1988 A 1995)</p> <p>40x47x40mm 1f-d22mm</p>
	<p>UMB84011 NO. 031126</p> <p>TAMPÃO BLOCO MOTOR</p> <p>OPEL VECTRA A Hatchback (J89) 1.6 i (F68 - M68) (De 09-1993 Até 11-1995) 52kW 71CV 1598cc Hatchback OPEL VECTRA A Hatchback (J89) 1.6 i Cat (F68 - M68) (De 09-1988 Até 11-1995) 55kW 75CV 1598cc Hatchback OPEL VECTRA A Hatchback (J89) 1.6 S (De 09-1988 Até 05-1993) 60kW 82CV 1598cc Hatchback OPEL VECTRA A Hatchback (J89) 1.8 S (F68 - M68) (De 09-1988 Até 07-1989) 65kW 88CV 1796cc Hatchback OPEL...</p> <p>d-18x8mm di-16mm</p>		<p>UMB84011L NO. 11062402 - 2060675</p> <p>TAMPÃO BLOCO DE MOTOR (RELAS)</p> <p>OPEL VECTRA A Hatchback (J89) 1.6 i (F68 - M68) (De 09-1993 Até 11-1995) 52kW 71CV 1598cc Hatchback OPEL VECTRA A Hatchback (J89) 1.6 i Cat (F68 - M68) (De 09-1988 Até 11-1995) 55kW 75CV 1598cc Hatchback OPEL VECTRA A Hatchback (J89) 1.6 S (De 09-1988 Até 05-1993) 60kW 82CV 1598cc Hatchback OPEL VECTRA A Hatchback (J89) 1.8 S (F68 - M68) (De 09-1988 Até 07-1989) 65kW 88CV 1796cc Hatchback OPEL VEC...</p> <p>d-18x8mm di-16mm</p>
	<p>UMB84019 NO. 2060668</p> <p>TAMPÃO BLOCO MOTOR</p> <p>OPEL VECTRA A Hatchback (J89) 1.4 S (F68 - M68) (De 04-1988 Até 06-1992) 55kW 75CV 1389cc Hatchback OPEL VECTRA A Hatchback (J89) 1.6 i (F68 - M68) (De 09-1993 Até 11-1995) 52kW 71CV 1598cc Hatchback OPEL VECTRA A Hatchback (J89) 1.6 i Cat (F68 - M68) (De 09-1988 Até 11-1995) 55kW 75CV 1598cc Hatchback OPEL VECTRA A Hatchback (J89) 1.6 S (De 09-1988 Até 05-1993) 60kW 82CV 1598cc Hatchback OPEL...</p> <p>d-26x9,5mm di-23,3mm</p>		<p>UMB84019L NO. 2060668</p> <p>TAMPÃO BLOCO DE MOTOR (RELAS)</p> <p>OPEL VECTRA A Hatchback (J89) 1.4 S (F68 - M68) (De 04-1988 Até 06-1992) 55kW 75CV 1389cc Hatchback OPEL VECTRA A Hatchback (J89) 1.6 i (F68 - M68) (De 09-1993 Até 11-1995) 52kW 71CV 1598cc Hatchback OPEL VECTRA A Hatchback (J89) 1.6 i Cat (F68 - M68) (De 09-1988 Até 11-1995) 55kW 75CV 1598cc Hatchback OPEL VECTRA A Hatchback (J89) 1.6 S (De 09-1988 Até 05-1993) 60kW 82CV 1598cc Hatchback OPEL VEC...</p> <p>d-26x9,5mm di-23,3mm</p>
	<p>UMB84021 NO. 2060673</p> <p>TAMPÃO BLOCO MOTOR</p> <p>OPEL VECTRA A Hatchback (J89) 1.4 S (F68 - M68) (De 04-1988 Até 06-1992) 55kW 75CV 1389cc Hatchback OPEL VECTRA A Hatchback (J89) 1.6 i (F68 - M68) (De 09-1993 Até 11-1995) 52kW 71CV 1598cc Hatchback OPEL VECTRA A Hatchback (J89) 1.6 i Cat (F68 - M68) (De 09-1988 Até 11-1995) 55kW 75CV 1598cc Hatchback OPEL VECTRA A Hatchback (J89) 1.6 S (De 09-1988 Até 05-1993) 60kW 82CV 1598cc Hatchback OPEL...</p> <p>d-28x7mm di-25,6mm</p>		<p>UMB84021L NO. 2060673</p> <p>TAMPÃO BLOCO DE MOTOR (RELAS)</p> <p>OPEL VECTRA A Hatchback (J89) 1.4 S (F68 - M68) (De 04-1988 Até 06-1992) 55kW 75CV 1389cc Hatchback OPEL VECTRA A Hatchback (J89) 1.6 i (F68 - M68) (De 09-1993 Até 11-1995) 52kW 71CV 1598cc Hatchback OPEL VECTRA A Hatchback (J89) 1.6 i Cat (F68 - M68) (De 09-1988 Até 11-1995) 55kW 75CV 1598cc Hatchback OPEL VECTRA A Hatchback (J89) 1.6 S (De 09-1988 Até 05-1993) 60kW 82CV 1598cc Hatchback OPEL VEC...</p> <p>d-28x7mm di-25,6mm</p>

	<p>UMB84026L NO. 11056093 - 2060665</p> <p>TAMPÃO BLOCO DE MOTOR (RELAS)</p> <p>OPEL VECTRA A</p> <p>d-34x13mm di-31,2mm</p>		<p>UMB84029 NO. 2060946</p> <p>TAMPÃO BLOCO MOTOR</p> <p>OPEL VECTRA A Hatchback (J89) 1.4 S (F68, M68) (04.88 A 06.92) 75cv 1389cc Hatchback - OPEL VECTRA A (J89) 1.7 D (F19, M19) (07.92 A 11.95) 60cv 1700cc três volumes</p> <p>d36x10mm di-32mm</p>
	<p>UMV25433 NO. 5738983</p> <p>MANETE PUNHO TOPO ALAVANCA MUDANÇAS 5 VELOCIDADES F19MM</p> <p>OPEL VECTRA A (J89) 1.4 S (F19, M19) (De 09.1988 Até 06.1992) 55kW 75cv 1389cm3 três volumes - OPEL VECTRA A (J89) 1.6 (F19, M19) (De 08.1992 Até 07.1993) 51kW 69cv 1598cm3 três volumes - OPEL VECTRA A (J89) 1.6 (F19, M19) (De 09.1988 Até 05.1993) 60kW 82cv 1598cm3 três volumes - OPEL VECTRA A (J89) 1.6 i (F19, M19) (De 09.1993 Até 11.1995) 52kW 71cv 1598cm3 três volumes - OPEL VECTRA A (J89) 1.6 ...</p> <p>d49x104mm 1f-d19mm</p>		<p>UMV26806 NO. 5738736 - 90511219</p> <p>MANETE PUNHO TOPO ALAVANCA MUDANÇAS 5 VELOCIDADES F19MM</p> <p>OPEL VECTRA A (J89): 2.0 i Cat (F19, M19) 09.1988/11.1995 85KW 116CV 1998CC</p> <p>55x47x45mm 1f-d19mm</p>
	<p>UTR0800 NO. 1304654 - 1304659 - 1304660 - 1304661 - 1304853 - 1341182080 - 90409256 - 9046472 - 90467472</p> <p>TAMPÃO RESERVATÓRIO LIQUIDO REFRIGERAÇÃO</p> <p>OPEL VECTRA A Hatchback 1.4 S (04.88 A 06.92) 75cv 1389cc Hatchback - OPEL VECTRA A Hatchback 1.6 i (09.93 A 11.95) 71cv 1598cc Hatchback - OPEL VECTRA A Hatchback 1.6 i (09.93 A 11.95) 75cv 1598cc Hatchback - OPEL VECTRA A Hatchback 1.6 i Cat (09.88 A 11.95) 75cv 1598cc Hatchback - OPEL VECTRA A Hatchback 1.6 S (09.88 A 05.93) 82cv 1598cc Hatchback - OPEL VECTRA A Hatchback 1.8 S (09.88 ...</p> <p>d62x25mm 1f-d53x14mm</p>		<p>UTR0820 NO. 90352470 - 90409256 - 90409257 - 9041032690497472 - 90467473</p> <p>TAMPÃO RESERVATÓRIO LIQUIDO REFRIGERAÇÃO</p> <p>OPEL VECTRA A Hatchback (88_ 89_) 1.4 S (04.88 A 06.92) 75cv 1389cc Hatchback - OPEL VECTRA A Hatchback (88_ 89_) 1.6 i (09.93 A 11.95) 71cv 1598cc Hatchback - OPEL VECTRA A Hatchback (88_ 89_) 1.6 i (09.93 A 11.95) 75cv 1598cc Hatchback - OPEL VECTRA A Hatchback (88_ 89_) 1.6 i Cat (09.88 A 11.95) 75cv 1598cc Hatchback - OPEL VECTRA A Hatchback (88_ 89_) 1.6 S (09.88 A 05.93) 82cv 1...</p> <p>d62x23mm 1f-d53x12mm</p>
	<p>UTR0859 NO. 1650630 - 94539597 - 96293957 - 96312510 - 96351578 - 96420303 - 96536649</p> <p>TAMPÃO RESERVATÓRIO LIQUIDO REFRIGERAÇÃO</p> <p>OPEL VECTRA A Hatchback (J89) 1.6 i (09.93 A 11.95) 71cv 1598cc Hatchback - OPEL VECTRA A Hatchback (J89) 1.6 i Cat (09.88 A 11.95) 75cv 1598cc Hatchback - OPEL VECTRA A Hatchback (J89) 1.6 S (09.88 A 05.93) 82cv 1598cc Hatchback - OPEL VECTRA A Hatchback (J89) 1.8 S (09.88 A 07.89) 88cv 1796cc Hatchback - OPEL VECTRA A Hatchback (J89) 1.8 i (09.88 A 10.90) 90cv 1796cc Hatchback - OPEL V...</p> <p>d63x23mm 1f-d53x11mm</p>		<p>UTR1201 NO. 1450591 - 90563741</p> <p>TAMPÃO RESERVATÓRIO LAVA VIDROS</p> <p>OPEL VECTRA A Hatchback (J89): 1.6 i (F68, M68) 09.1993/11.1995 52KW 71CV 1598CC - OPEL VECTRA A Hatchback (J89): 1.6 i (F68, M68) 09.1993/11.1995 55KW 75CV 1598CC - OPEL VECTRA A Hatchback (J89): 1.6 S 09.1988/05.1993 60KW 82CV 1598CC - OPEL VECTRA A Hatchback (J89): 2.0 i (F68, M68) 09.1988/10.1990 85KW 115CV 1998CC - OPEL VECTRA A Hatchback (J89): 2.0 i GT (F68, M68) 09.1988/11.1995 95KW 129CV ...</p> <p>d58x6mm c96mm di-d53x6mm</p>
	<p>UTR1300 NO. 00650090 - 05650831</p> <p>TAMPÃO RESERVATÓRIO DO OLEO</p> <p>OPEL VECTRA A Hatchback (J89) 2.0 i 16V (F68 - M68) (De 08-1992 Até 08-1995) 100kW 136CV 1998cc Hatchback OPEL VECTRA A (J89) 2.0 i 16V (F19 - M19) (De 08-1992 Até 08-1995) 100kW 136CV 1998cc três volumes OPEL VECTRA A (J89) 2.0 i 16V 4x4 (F19 - M19) (De 06-1994 Até 11-1995) 100kW 136CV 1998cc três volumes</p> <p>d59x31mm d45x12mm</p>		<p>UTR1305 NO. 0650089 - 650089</p> <p>TAMPÃO DO RESERVATÓRIO ÓLEO</p> <p>OPEL VECTRA A (J89) 1.6 (F19, M19) (09.1988 -05.1993) 60kw 82cv 1598cm3 três volumes OPEL VECTRA A (J89) 1.6 i (F19, M19) (09.1993 -11.1995) 52kw 71cv 1598cm3 três volumes OPEL VECTRA A (J89) 1.6 i (F19, M19) (09.1988 -11.1995) 55kw 75cv 1598cm3 três volumes OPEL VECTRA A (J89) 1.7 D (F19, M19) (10.1988 -09.1992) 42kw 57cv 1699cm3 três volumes OPEL VECTRA A (J89) 1.7 D (F19, M19) (07.1992 -11.1995...</p> <p>d61x23mm d32x19mm</p>
	<p>UTV83011 NO. 0652475 - 09275631 - 652475 - 652491 - 90409376 - 9275631 - N90288901</p> <p>TAMPÃO VEDAÇÃO BUJÃO</p> <p>OPEL VECTRA A Hatchback (J89) 1.6 i (F68 - M68) (De 09-1993 Até 11-1995) 52kW 71CV 1598cc Hatchback OPEL VECTRA A Hatchback (J89) 1.6 i Cat (F68 - M68) (De 09-1988 Até 11-1995) 55kW 75CV 1598cc Hatchback OPEL VECTRA A Hatchback (J89) 1.6 S (De 09-1988 Até 05-1993) 60kW 82CV 1598cc Hatchback OPEL VECTRA A Hatchback (J89) 1.8 S (F68 - M68) (De 09-1988 Até 07-1989) 65kW 88CV 1796cc Hatchback OPEL VEC...</p> <p>19x18mm c12mm d14mm</p>		<p>W5034 NO. 614654</p> <p>POLIE DA CAMBOTA (6 PISTAS)</p> <p>OPEL VECTRA A 2.0 16v Motor C20NE - Motor X20XEV</p> <p>d138mm d42mm</p>
	<p>W5045 NO. 5614417 - 614457 - 614637 - 97011870 - 97129070</p> <p>POLIE DA CAMBOTA (1+1+1 PISTAS)</p> <p>OPEL VECTRA A Hatchback (J89): 1.7 TD (F68, M68) 03.1990/11.1995 60KW 82CV 1686CC - OPEL VECTRA A (J89): 1.7 TD (F19, M19) 03.1990/11.1995 60KW 82CV 1686CC</p> <p>d139mm d48mm</p>		<p>W5178 NO. 614473 - 90448439</p> <p>POLIE DA CAMBOTA (1+1 PISTAS)</p> <p>OPEL VECTRA A Hatchback (J89): 1.7 D (F68, M68) 09.1988/09.1992 42KW 57CV 1700CC - OPEL VECTRA A Hatchback (J89): 1.7 D (F68, M68) 07.1992/11.1995 44KW 60CV 1700CC - OPEL VECTRA A (J89): 1.7 D (F19, M19) 10.1988/09.1992 42KW 57CV 1700CC - OPEL VECTRA A (J89): 1.7 D (F19, M19) 10.1988/09.1992 42KW 57CV 1700CC</p> <p>d146mm d41mm</p>
	<p>W5185 NO. 614473 - 90448439</p> <p>POLIE DA CAMBOTA (1+1 PISTAS)</p> <p>OPEL VECTRA A Hatchback (J89): 1.7 D (F68, M68) 09.1988/09.1992 42KW 57CV 1700CC - OPEL VECTRA A Hatchback (J89): 1.7 D (F68, M68) 07.1992/11.1995 44KW 60CV 1700CC - OPEL VECTRA A (J89): 1.7 D (F19, M19) 10.1988/09.1992 42KW 57CV 1700CC - OPEL VECTRA A (J89): 1.7 D (F19, M19) 07.1992/11.1995 44KW 60CV 1700CC</p> <p>d146mm d42mm</p>		<p>Y3212 NO. 1008501 - 1008504 - 4709077</p> <p>PARAFUSO PERNO RODA CHAVE 17 M12X1,50X48MM (BASE CONICA PARA JANTES AÇO E LIGA LEVE)</p> <p>OPEL VECTRA A (J89) 1.4 S (F19, M19) 09.1988 - 06.1992) 55kw 75cv 1389cm3 três volumes OPEL VECTRA A (J89) 1.6 (F19, M19) 09.1988 - 05.1993) 60kw 82cv 1598cm3 três volumes OPEL VECTRA A (J89) 1.6 i (F19, M19) 09.1993 - 11.1995) 52kw 71cv 1598cm3 três volumes OPEL VECTRA A (J89) 1.6 i (F19, M19) 09.1988 - 11.1995) 55kw 75cv 1598cm3 três volumes OPEL VECTRA A (J89) 1.7 D (F19, M19) 10.1988 - 09.1992...</p> <p>C48mm (Ch-17mm) M12x1,50x22mm</p>

OPEL VECTRA A

















Rafri, Lda.

	Z80540	NO. 2240861 - 90022049		Z86001	NO. 1438336 - 90332334
	Mola de painel OPEL VECTRA A			MOLA FIXAÇÃO PALA TAPA-SOL OPEL VECTRA A	
	d12x14.3mm	1p-d7-12.3mm		34x24x24mm	1f-d4mm 1-pino d4x10mm
	Z9000	NO. 25501711 - 854880 - 854881 - 854884 - 858884 - 90234204		Z9011	NO. 1261479 - 1449282600 - 4709339 - 4711509 - 854880
	MOLA DE ESCAPE 42mm OPEL VECTRA A (APÓS 1988)			MOLA DE ESCAPE OPEL VECTRA A	
	d18x26mm			d23x42mm	

OPEL VECTRA B

	A1629	NO. 5682507 - 5682512 - 90495513 - 90539069		A1645	NO. 0684663 - 0684670 - 0684910 - 684663 - 684670 - 684674 - 684910 - 90495447 - 90496186
	APOIO DO MOTOR PARTE DE TRÁS OPEL VECTRA B 1.6i - 1.8i 16v - 1.7TD - 1.8i 16v - 2.0 Dti 16v (1992 A 2002)			APOIO DO MOTOR PARTE DA FRENTE DIREITO OPEL VECTRA B 1.6i - 1.8i 16v - 2.0i - 2.0i 16v (1992 A 2002)	
	170x170x120mm			d105x120mm	1p-d10-44mm 1p-d10-25mm
	A1646	NO. 0684681 - 684681 - 90497967		A1943	NO. 0344523 - 344523 - 90468554
	APOIO DO MOTOR PARTE DA FRENTE ESQUERDO OPEL VECTRA B 1.6i - 1.8i 16v - 2.0i - 2.0i 16v (1992 A 2002)			APOIO SUPORTE AMORTECEDOR FRENTE (GASTA 2 UNIDADES) OPEL VECTRA B Hatchback (38_) 1.6 i (10.95 A 07.03) 75cv 1598 Hatchback - OPEL VECTRA B Hatchback (38_) 1.6 i 16V (10.95 A 07.02) 101cv 1598cc Hatchback - OPEL VECTRA B Hatchback (38_) 1.8 i 16V (10.95 A 09.00) 116cv 1796cc Hatchback - OPEL VECTRA B Hatchback (38_) 1.8 i 16V (09.00 A 07.03) 125cv 1796cc Hatchback - OPEL VECTRA B Hatchback (38_) 1.7 TD (10.95 A 12.98) 82cv 1686cc Hatchback...	
	d105x135mm	1p-d10-44mm 1p-d10-25mm		d115x45mm	1f-d12mm
	A2087	NO. 5834901		B450	NO. 164987
	APOIO DO FILTRO DE AR OPEL VECTRA B Hatchback (J96) 1.6 i (F68) (10.95 A 07.03) 75cv 1598cc Hatchback - OPEL VECTRA B Hatchback (J96) 1.6 i 16V (F68) (10.95 A 07.03) 75cv 1598cc Hatchback - OPEL VECTRA B Hatchback (J96) 1.6 i 16V (F68) (10.95 A 07.02) 101cv 1598cc Hatchback - OPEL VECTRA B Hatchback (J96) 1.8 i 16V (F68) (10.95 A 09.00) 116cv 1796cc Hatchback - OPEL VECTRA B Hatchback (J96) 1.8 i 16V (F68) (09.00 A 07....			ABRAÇADEIRA DO REVESTIMENTO DO HABITÁCULO OPEL VECTRA B (J96) 1.6 i (F19) (10.1995 - 04.2002) 55kw 75cv 1598cm3 três volumes OPEL VECTRA B (J96) 1.6 i (F19) (10.1995 - 04.2002) 55kw 75cv 1598cm3 três volumes OPEL VECTRA B (J96) 1.6 i 16V (F19) (10.1995 - 04.2002) 74kw 100cv 1598cm3 três volumes OPEL VECTRA B (J96) 1.7 TD (F19) (10.1995 - 12.1998) 60kw 82cv 1686cm3 três volumes OPEL VECTRA B (J96) 1.8 i 16V (F19) (10.1995 - 09.2000) 85kw ...	
	d20x15mm	1p-d5x14 1p-d6x14mm		245x38x11mm	
	B450	NO. 164987		B450	NO. 164987
	ABRAÇADEIRA DO REVESTIMENTO DO HABITÁCULO OPEL VECTRA B Combi (J96) 1.6 i (F35) (11.1996 - 06.2000) 55kw 75cv 1598cm3 Combi OPEL VECTRA B Combi (J96) 1.6 i 16V (F35) (11.1996 - 07.2002) 74kw 100cv 1598cm3 Combi OPEL VECTRA B Combi (J96) 1.7 TD (F35) (11.1996 - 12.1997) 60kw 82cv 1686cm3 Combi OPEL VECTRA B Combi (J96) 1.8 i 16V (F35) (11.1996 - 09.2000) 85kw 115cv 1796cm3 Combi OPEL VECTRA B Combi (J96) 1.8 i 16V (F35) (11.1996 - 09.2000)...			ABRAÇADEIRA DO REVESTIMENTO DO HABITÁCULO OPEL VECTRA B Hatchback (J96) 1.6 i (F68) (10.1995 - 07.2003) 55kw 75cv 1598cm3 Hatchback OPEL VECTRA B Hatchback (J96) 1.6 i (F68) (10.1995 - 07.2003) 55kw 75cv 1598cm3 Hatchback OPEL VECTRA B Hatchback (J96) 1.6 i 16V (F68) (10.1995 - 07.2002) 74kw 101cv 1598cm3 Hatchback OPEL VECTRA B Hatchback (J96) 1.7 TD (F68) (10.1995 - 12.1998) 60kw 82cv 1686cm3 Hatchback OPEL VECTRA B Hatchback (J96) 1.8...	
	245x38x11mm			245x38x11mm	
	C0233	NO. 1160724 - 90054143		E0129	NO. 0350610 - 350610 - 4886606 - 90496116
	BOTÃO AFINAÇÃO CAPÔT OPEL VECTRA B Hatchback (38_) 1.6 i (10.95 A 07.03) 75cv 1598cc Hatchback - OPEL VECTRA B Hatchback (38_) 1.6 i 16V (10.95 A 07.02) 101cv 1598cc Hatchback - OPEL VECTRA B Hatchback (38_) 1.8 i 16V (10.95 A 09.00) 116cv 1796cc Hatchback - OPEL VECTRA B Hatchback (38_) 1.8 i 16V (09.00 A 07.03) 125cv 1796cc Hatchback - OPEL VECTRA B Hatchback (38_) 2.0 i 16V (10.95 A 09.00) 136cv 1...			ESTICADOR DA BARRA ESTABILIZADORA DA FRENTE OPEL VECTRA B 1.6i - 1.6i 16v - 1.7 TD - 1.8i 16v - 2.0 DI 16v - 2.0 DTI 16v - 2.0i - 2.0i 16v - 2.2DTi 16v - 2.5i V6 - 2.6i V6 (1995 A 2002)	
	d19x31mm			285x36x36mm	2p-d12-25mm

	<p>E0216-M NO. 0684703 - 13116588 - 5684109 - 684703 - 90496942</p> <p><i>ESTICADOR SUPORTE APOIO MOTOR TRAS</i></p> <p>OPEL VECTRA B (J96) 1.6 i (F19) 10.1995/04.2002 55KW 75CV 1598CC X 16 SZR 0039942 - OPHEL VECTRA B (J96) 1.6i 16V (F19) 10.1995/04.2002 74KW 100CV 1598CC X 16 XEL Y 16 XE Z 16 XE 0039943 - OPHEL VECTRA B (J96) 1.7 TD (F19) 10.1995/12.1998 60KW 82CV 1686CC X 17 DT (TC4EE1) 0039944 - OPHEL VECTRA B (J96) 1.8 i 16V (F19) 10.1995/09.2000 85KW 115CV 1796CC Z 18 XEL X 18 XE1 0039945 - OPHEL VECTRA B (J96) ...</p> <p>150x60x45mm 1f-d12/25mm 1f-d11mm</p>		<p>E1092 NO. 0852726 - 13276148 - 852577 - 852726 - 90466668</p> <p><i>ESTICADOR DE ESCAPE</i></p> <p>OPHEL VECTRA B Hatchback (J96): 1.6 i (F68) 10.1995/07.2003 55KW 75CV 1598CC - OPHEL VECTRA B Hatchback (J96): 1.6 i (F68) 10.1995/07.2003 55KW 75CV 1598CC - OPHEL VECTRA B Hatchback (J96): 1.6 i 16V (F68) 10.1995/07.2002 74KW 101CV 1598CC - OPHEL VECTRA B Hatchback (J96): 1.8 i 16V (F68) 10.1995/07.2002 74KW 101CV 1598CC - OPHEL VECTRA B Hatchback (J96): 1.8 i 16V (F68) 10.1995/09.2000 85KW 116CV 1796CC - OPHEL VECTRA B Hatchback (J96): 2.0 i 16V (F68) 09.1995/06.2000 100KW 136CV 199...</p> <p>55x40x35mm</p>
	<p>E23401-V NO. 0758801 - 758801 - 90250156</p> <p><i>ESTICADOR MANETE CAIXA DE VELOCIDADES</i></p> <p>OPHEL VECTRA B Hatchback (J96) 1.6 i (F68) (De 10-1995 Até 07-2003) 55KW 75CV 1598cc Hatchback OPHEL VECTRA B Hatchback (J96) 1.6 i 16V (F68) (De 10-1995 Até 07-2002) 74KW 101CV 1598cc Hatchback OPHEL VECTRA B Hatchback (J96) 1.8 i 16V (F68) (De 10-1995 Até 09-2000) 85KW 116CV 1796cc Hatchback OPHEL VECTRA B Hatchback (J96) 1.8 i 16V (F68) (De 10-1995 Até 09-2000) 85KW 116CV 1799cc Hatchback OPHEL ...</p> <p>207x17x18mm 2f-d11mm</p>		<p>F1373-I NO. 1603141 - 374040 - 90009020 - 90112609 - 90421756</p> <p><i>FOLE DA TRANSMISSÃO JUNTO À CAIXA</i></p> <p>OPHEL VECTRA B 1.7TD - 1.8i - 2.0i (95 A 02)</p> <p>d87x99mm 1f-d65mm 1f-d22mm</p>
	<p>F1702-I NO. 1609095 - 90512778</p> <p><i>FOLE DA DIREÇÃO LADO DIREITO E ESQUERDO</i></p> <p>OPHEL VECTRA B 1.6i - 1.6i 16v - 1.7 TD - 1.8i 16v - 2.0 DI 16v - 2.0 DTI 16v - 2.0i 16v - 2.2i 16v - 2.5i V6 (1995 A 2002)</p> <p>d59x160mm 1f-d45mm 1f-d11mm</p>		<p>F1848-I NO. 1603014 - 1603183 - 1603238 - 374014 - 374319 - 374429 - 90543336</p> <p><i>FOLE DA TRANSMISSÃO JUNTO À CAIXA</i></p> <p>OPHEL VECTRA B 1.6i 16v - 1.8i 16v - 1.9 CDTi 16v - 1.9 CDTi 8V - 2.0 Di 16v - 2.0 DTi 16v - 2.0i 16v - 2.0i T 16v - 2.2 DTi 16v - 2.2i 16v - 2.5i V6 (1995 A 2002)</p> <p>d95x100mm 1f-d65mm 1f-d24mm</p>
	<p>F4096 NO. 5738405 - 90436277</p> <p><i>FOLE ALAVANCA VELOCIDADES</i></p> <p>OPHEL VECTRA B Hatchback (J96): 1.6 i (F68) 10.1995/07.2003 55KW 75CV 1598CC - OPHEL VECTRA B Hatchback (J96): 1.6 i (F68) 10.1995/07.2003 55KW 75CV 1598CC - OPHEL VECTRA B Hatchback (J96): 1.6 i 16V (F68) 10.1995/07.2002 74KW 101CV 1598CC - OPHEL VECTRA B Hatchback (J96): 1.8 i 16V (F68) 10.1995/09.2000 85KW 116CV 1796CC - OPHEL VECTRA B Hatchback (J96): 1.8 i 16V (F68) 09.2000/07.2003 92KW 125C...</p> <p>175x120x200 1f-d50mm 1f-155x105mm</p>		<p>F4112 NO. 0578511 - 90436348</p> <p><i>FOLE ALAVANCA TRAVÃO DE MÃO</i></p> <p>OPHEL VECTRA B (J96) 2.0 DI 16V (F19) 11.1996/04.2002 60KW 82CV 1995CC X 20 DTL 0039967 - OPHEL VECTRA B Combi (J96) 1.6 i 16V (F35) 11.1996/07.2002 74KW 100CV 1598CC Z 16 XE Y 16 XE X 16 XEL 0039961 - OPHEL VECTRA B Combi (J96) 1.8 i 16V (F35) 11.1996/09.2000 85KW 115CV 1796CC Z 18 XEL X 18 XE1 0039962 - OPHEL VECTRA B Combi (J96) 1.8 i 16V (F35) 11.1996/09.2000 85KW 116CV 1799CC X 18 XE 0039962 - OP...</p> <p>180x200x50mm 1f-d16mm 1f-190x45mm</p>
	<p>F4126 NO. 578794 - 90331615</p> <p><i>FOLE ALAVANCA TRAVÃO DE MÃO</i></p> <p>OPHEL VECTRA B</p> <p>223x43x190mm 1f-185x38mm</p>		<p>KF2345 NO. 374190 - 90236762</p> <p><i>FOLE DO LADO DA RODA</i></p> <p>OPHEL VECTRA B 1.7TD (1995 A 2002)</p> <p>d90x82mm 1f-d19mm 1f-d75mm</p>
	<p>KL80449 NO. 198283 - 607813 - 90412865</p> <p><i>KIT CASQUILHOS COBERTURA TAMPA MOTOR</i></p> <p>OPHEL VECTRA B Hatchback (J96): 1.6 i 16V (F68) 10.1995/07.2002 74KW 101CV 1598CC - OPHEL VECTRA B Hatchback (J96): 1.8 i 16V (F68) 10.1995/09.2000 85KW 116CV 1796CC - OPHEL VECTRA B Hatchback (J96): 1.8 i 16V (F68) 09.2000/07.2003 92KW 125CV 1796CC - OPHEL VECTRA B Hatchback (J96): 2.0 DI 16V (F68) 11.1996/06.2000 60KW 82CV 1995CC - OPHEL VECTRA B Hatchback (J96): 2.0 DTI 16V (F68) 06.1997/07.2003 74K...</p> <p>d16x10mm 1f-d6mm</p>		<p>L3020 NO. 0856700 - 856700 - 9275758</p> <p><i>CASQUILHO DE ESCAPE</i></p> <p>OPHEL VECTRA B</p> <p>d29x12mm d26/di19x8mm 1f-d9mm</p>
	<p>M6082 NO. 854943 - 854944 - 854955 - 97069287</p> <p><i>JUNTA DE ESCAPE</i></p> <p>OPHEL VECTRA B 1.7 - 1.7TD (APÓS 1995)</p> <p>d64x5mm 1f-d53mm</p>		<p>P1049 NO. 560195 - 560775 - 560812 - 90468789 - 90222351 - 0560195 - 0560812 - 0560775</p> <p><i>CAPA PEDAL EMBRAIAGEM/TRAVAO (GASTA 2 UNIDADES)</i></p> <p>OPHEL VECTRA B (J96) 1.6 i (F19) 10.1995/04.2002 55KW 75CV 1598CC X 16 SZR 0039942 - OPHEL VECTRA B (J96) 1.6 i (F19) 10.1995/04.2002 55KW 75CV 1598CC 16 LZ2 - OPHEL VECTRA B (J96) 1.6 i 16V (F19) 10.1995/04.2002 74KW 100CV 1598CC X 16 XEL Y 16 XE Z 16 XE 0039943 - OPHEL VECTRA B (J96) 1.7 TD (F19) 10.1995/12.1998 60KW 82CV 1686CC X 17 DT (TC4EE1) 0039944 - OPHEL VECTRA B (J96) 1.8 i 16V (F19) 10.1995/...</p> <p>63x63x12mm</p>
	<p>R080251 NO. 284-80mm 2f-d8mm 1p-d15x29mm 1p-d4</p> <p><i>TUBO RÍGIDO REFRIGERAÇÃO</i></p> <p>OPHEL VECTRA B (J96) 1.6 i (F19) (De 10-1995 Até 04-2002) 55KW 75CV 1598cc três volumes OPHEL VECTRA B (J96) 1.6 i 16V (F19) (De 10-1995 Até 04-2002) 74KW 100CV 1598cc três volumes OPHEL VECTRA B (J96) 1.8 i 16V (F19) (De 10-1995 Até 09-2000) 85KW 115CV 1796cc três volumes</p> <p>B325-34/34mm 284-80mm 2f-d8mm 1p-d15x29mm 1p-d4</p>		<p>R080253 NO. 06336007 - 09128719</p> <p><i>TUBO LÍQUIDO REFRIGERAÇÃO</i></p> <p>OPHEL VECTRA B (J96) 1.6 i 16V (F19) 10.1995/04.2002 74KW 100CV 1598CC X 16 XEL Y 16 XE Z 16 XE 0039943 - OPHEL VECTRA B Combi (J96) 1.6 i 16V (F35) 11.1996/07.2002 74KW 100CV 1598CC Z 16 XE Y 16 XE X 16 XEL 0039961 - OPHEL VECTRA B Hatchback (J96) 1.6 i 16V (F68) 10.1995/07.2002 74KW 101CV 1598CC Z 16 XE Y 16 XE X 16 XEL 0039949</p> <p>B340-30/35mm ch-d13-29mm ch-d13-30mm</p>

	<p>R222770 NO. 1337328</p> <p>TUBO SUPERIOR DO RADIADOR</p> <p>OPEL VECTRA B 1.6i (10-1995 A 07-2003)</p> <p>B210-d31/34mm 80-100-110-60-50-60mm</p>		<p>R222772 NO. 1337329</p> <p>TUBO SUPERIOR DO RADIADOR</p> <p>OPEL VECTRA B (J96) 1.8 i 16V (F19) 10.1995/09.2000 85KW 115CV 1796CC Z 18 XEL X 18 XE1 0039945 - OPEL VECTRA B (J96) 1.8 i 16V (F19) 09.2000/04.2002 92KW 125CV 1796CC Z 18 XE 0039180 - OPEL VECTRA B (J96) 2.0 i (F19) 10.1995/04.2002 82KW 112CV 1998CC 20 NEJ - OPEL VECTRA B Combi (J96) 1.8 i 16V (F35) 11.1996/09.2000 85KW 115CV 1796CC Z 18 XEL X 18 XE1 0039962 - OPEL VECTRA B Combi (J96) 1.8 i 16V...</p> <p>B210-d34/34mm 50-100-50-50mm</p>
	<p>R222774 NO. 1337361</p> <p>TUBO SUPERIOR DO RADIADOR</p> <p>OPEL VECTRA B 1.7 TD (10-1995 A 12-1998)</p> <p>B300-d32/32mm 50-60-70-100-130mm</p>		<p>R222776 NO. 1337414</p> <p>TUBO SUPERIOR DO RADIADOR</p> <p>OPEL VECTRA B 2.0 DTi 16V</p> <p>B110-d33/33mm 50-70-60-80mm</p>
	<p>R222799 NO. 0836770 - 836770 - 90351553</p> <p>TUBO ADMISSÃO FILTRO DE AR</p> <p>OPEL VECTRA B Hatchback (J96): 1.8 i 16V (F68) 10.1995/09.2000 85KW 116CV 1799CC - OPEL VECTRA B (J96): 1.8 i 16V (F19) 10.1995/09.2000 85KW 116CV 1799CC - OPEL VECTRA B Combi (J96): 1.8 i 16V (F35) 11.1996/09.2000 85KW 116CV 1799CC</p> <p>boca a boca 204 mm d1 59mmd2 61mm</p>		<p>R222805 NO. 806092 - 806609 - 90499641 - 9181888</p> <p>TUBO RESPIRO DEPOSITO COMBUSTIVEL</p> <p>OPEL VECTRA B (J96) 1.6 i (F19) 10.1995/04.2002 55KW 75CV 1598CC X 16 SZR 0039942 - OPEL VECTRA B (J96) 1.6 i (F19) 10.1995/04.2002 55KW 75CV 1598CC 16 LZ2 - OPEL VECTRA B (J96) 1.6 i 16V (F19) 10.1995/04.2002 74KW 100CV 1598CC X 16 XEL Y 16 XE Z 16 XE 0039943 - OPEL VECTRA B (J96) 1.7 TD (F19) 10.1995/12.1998 60KW 82CV 1686CC X 17 DT (TC4EE1) 0039944 - OPEL VECTRA B (J96) 1.8 i 16V (F19) 10.1995/...</p> <p>B360-37/37mm 56x40x156x122mm</p>
	<p>R222806 NO. 806623 - 806642 - 90499642 - 9181889</p> <p>TUBO DE RESPIRO DEPÓSITO COMBUSTIVEL</p> <p>OPEL VECTRA B (J96) 1.6 i (F19) 10.1995/04.2002 55KW 75CV 1598CC X 16 SZR 0039942 - OPEL VECTRA B (J96) 1.6 i (F19) 10.1995/04.2002 55KW 75CV 1598CC 16 LZ2 - OPEL VECTRA B (J96) 1.6 i 16V (F19) 10.1995/04.2002 74KW 100CV 1598CC X 16 XEL Y 16 XE Z 16 XE 0039943 - OPEL VECTRA B (J96) 1.7 TD (F19) 10.1995/12.1998 60KW 82CV 1686CC X 17 DT (TC4EE1) 0039944 - OPEL VECTRA B (J96) 1.8 i 16V (F19) 10.1995/...</p> <p>B390-d16/d19mm</p>		<p>R222808 NO. 857431 - 90571668 - 857413</p> <p>TUBO ADMISSÃO DO FILTRO DE AR</p> <p>OPEL VECTRA B (J96) 1.8 i 16V (F19) 10.1995/09.2000 85KW 115CV 1796CC Z 18 XEL X 18 XE1 0039945 - OPEL VECTRA B (J96) 1.8 i 16V (F19) 10.1995/09.2000 85KW 116CV 1799CC X 18 XE 0039945 - OPEL VECTRA B (J96) 1.8 i 16V (F19) 09.2000/04.2002 92KW 125CV 1796CC Z 18 XE 0039180 - OPEL VECTRA B (J96) 2.0 i (F19) 10.1995/04.2002 82KW 112CV 1998CC 20 NEJ - OPEL VECTRA B (J96) 2.0 i 16V (F19) 09.1995/06.2000...</p> <p>B247-19/23mm 71-102-70-49-33mm</p>
	<p>R222811 NO. 650872</p> <p>TUBO DE LIGAÇÃO AO TERMOSTATO</p> <p>OPEL VECTRA B Hatchback (J96) 1.7 TD (F68) (De 1995.10 Até 1998.12) 60kW 82cv 1686cm3 Hatchback - OPEL VECTRA B (J96) 1.7 TD (F19) (De 1995.10 Até 1998.12) 60kW 82cv 1686cm3 três volumes - OPEL VECTRA B Combi (J96) 1.7 TD (F35) (De 1996.11 Até 1997.12) 60kW 82cv 1686cm3 Combi -</p> <p>B57-15/15mm 50x22x50mm</p>		<p>R222812 NO. 650873</p> <p>TUBO LIGAÇÃO TERMOSTATO</p> <p>OPEL VECTRA B Hatchback (J96) 1.7 TD (F68) (De 10-1995 Até 12-1998) 60kW 82CV 1686cc Hatchback OPEL VECTRA B (J96) 1.7 TD (F19) (De 10-1995 Até 12-1998) 60kW 82CV 1686cc três volumes OPEL VECTRA B Combi (J96) 1.7 TD (F35) (De 11-1996 Até 12-1997) 60kW 82CV 1686cc Combi</p> <p>B97-14/14mm 60-41mm</p>
	<p>R224351 NO. 38x43-310x270x103x46x58mm ch-d24x4</p> <p>TUBO INFERIOR DO RADIADOR (COM AC)</p> <p>OPEL VECTRA B (J96) 1.6 i 16V (F19) 10.1995/04.2002 74KW 100CV 1598CC X 16 XEL Y 16 XE Z 16 XE 0039943</p> <p>B730-30/34mm 38x43-310x270x103x46x58mm ch-d24x4</p>		<p>R224351 NO. 38x43-310x270x103x46x58mm ch-d24x4</p> <p>TUBO INFERIOR DO RADIADOR (COM AC)</p> <p>OPEL VECTRA B Combi (J96) 1.6 i 16V (F35) 11.1996/07.2002 74KW 100CV 1598CC Z 16 XE Y 16 XE X 16 XEL 0039961</p> <p>B730-30/34mm 38x43-310x270x103x46x58mm ch-d24x4</p>
	<p>R224351 NO. 38x43-310x270x103x46x58mm ch-d24x4</p> <p>TUBO INFERIOR DO RADIADOR (COM AC)</p> <p>OPEL VECTRA B Hatchback (J96) 1.6 i 16V (F68) 10.1995/07.2002 74KW 101CV 1598CC Z 16 XE Y 16 XE X 16 XEL 0039949</p> <p>B730-30/34mm 38x43-310x270x103x46x58mm ch-d24x4</p>		<p>R225254 NO. 1337233 - 97086694</p> <p>TUBO LIGAÇÃO TERMOSTATO</p> <p>OPEL VECTRA B (J96) 1.7 TD (F19) (De 10-1995 Até 12-1998) 60kW 82CV 1686cc três volumes</p> <p>B730-30/34mm 48-47mm</p>
	<p>R225630 NO. 1337451 - 1337599 - 24436859 - 90573595</p> <p>TUBO DE PERMUTADOR DO AQUECIMENTO</p> <p>OPEL VECTRA B (J96) 2.0 DI 16V (F19) 11.1996/04.2002 60KW 82CV 1995CC X 20 DTL 0039967 - OPEL VECTRA B (J96) 2.0 DTI 16V (F19) 06.1997/04.2002 74KW 101CV 1995CC X 20 DTH Y 20 DTH 0039172 - OPEL VECTRA B (J96) 2.2 DTI 16V (F19) 09.2000/04.2002 88KW 120CV 2172CC Y 22 DTR 0039189 - OPEL VECTRA B (J96) 2.2 DTI 16V (F19) 09.2000/04.2002 92KW 125CV 2172CC Y 22 DTR 0039186 - OPEL VECTRA B Combi (J96) 2.0...</p> <p>boca a boca 340 mm d1 14mmd2 14mm</p>		<p>R225631 NO. 1337451 - 1337456 - 1337599 - 24436859 - 90573595 - 9128160</p> <p>TUBO DO PERMUTADOR DO AQUECIMENTO</p> <p>OPEL VECTRA B (J96) 2.0 DI 16V (F19) (De 11.1996 Até 04.2002) 60kW 82cv 1995cm3 três volumes - OPEL VECTRA B (J96) 2.0 DTI 16V (F19) (De 06.1997 Até 04.2002) 74kW 101cv 1995cm3 três volumes - OPEL VECTRA B (J96) 2.2 DTI 16V (F19) (De 09.2000 Até 04.2002) 88kW 120cv 2172cm3 três volumes - OPEL VECTRA B (J96) 2.2 DTI 16V (F19) (De 09.2000 Até 04.2002) 92kW 125cv 2172cm3 três volumes - OPEL VECTRA B ...</p> <p>boca a boca 348 mm d1 14mmd2 15mm</p>

	<p>R8150 NO. 836791 - 90411677</p> <p>TUBO ADMISSÃO FILTRO DE AR</p> <p>OPEL VECTRA B (J96) 1.8 i 16V (F19) 10.1995/09.2000 85KW 115CV 1796CC Z 18 XEL X 18 XE1 0039945 - OPEL VECTRA B (J96) 1.8 i 16V (F19) 10.1995/09.2000 85KW 116CV 1799CC X 18 XE 0039945 - OPEL VECTRA B (J96) 1.8 i 16V (F19) 09.2000/04.2002 92KW 125CV 1796CC Z 18 XE 0039180 - OPEL VECTRA B (J96) 2.0 i 16V (F19) 09.1995/06.2000 100KW 136CV 1998CC X 20 XEV C 20 SEL 0039946 - OPEL VECTRA B (J96) 2.2 i 1...</p> <p>B215-62/72mm 85-128mm ch-d18x42mm</p>		<p>R8151 NO. 838276 - 90470097</p> <p>TUBO LIGAÇÃO COLECTOR ADMISSÃO</p> <p>OPEL VECTRA B (J96) 1.6 i 16V (F19) 10.1995/04.2002 74KW 100CV 1598CC X 16 XEL Y 16 XE Z 16 XE 0039943 - OPEL VECTRA B Combi (J96) 1.6 i 16V (F35) 11.1996/07.2002 74KW 100CV 1598CC Z 16 XE Y 16 XE X 16 XEL 0039961 - OPEL VECTRA B Hatchback (J96) 1.6 i 16V (F68) 10.1995/07.2002 74KW 101CV 1598CC Z 16 XE Y 16 XE X 16 XEL 0039949</p> <p>d76x49mm 1f-d67mm</p>
	<p>RT08619 NO. 562364 - 562373 - 90495787 - 90539252</p> <p>TUBO DE TRAVÃO FRENTE LH-RH</p> <p>OPEL VECTRA B TT (APÓS 10-1995)</p> <p>410mm FB3/1 - OR7</p>		<p>S1464 NO. 423302 - 423318 - 90495585 - 9191309</p> <p>SILENT BLOC DO BRAÇO DA SUSPENSÃO DE TRÁS</p> <p>OPEL VECTRA B 1.6i - 1.7TD - 1.8i 16V - 2.0i - 2.0i 16V - 2.0DTi 16V (1995 A 2002) - STATION WAGON 1.6i - 1.8i 16V - 2.0i 16V - 2.0DTi 16V (1996 A 2003)</p> <p>d75.5x55mm c30mm d60.5mm 1f-d13mm</p>
	<p>S1465 NO. 5402630 - 90496681</p> <p>SILENT BLOC DA SUSPENSÃO DE TRÁS (TRAVESSA)</p> <p>OPEL VECTRA B 1.6i - 1.7TD - 1.8i 16V - 2.0i - 2.0DTi 16V (1995 A 2002) - STATION WAGON 1.6i - 1.8i 16V - 2.0i - 2.0DTi 16V (1996 A 2003)</p> <p>d81x60mm c35mm d66mm 1f-d14mm</p>		<p>S1471 NO. 352357 - 90468636</p> <p>SILENT BLOC DO BRAÇO SA SUSPENSÃO DA FRENTE</p> <p>OPEL VECTRA B 1.6i - 1.7TD - 1.8i 16V - 2.0i - 2.0i 16V - 2.0DTi 16V (1995 A 2002) - STATION WAGON 1.6i - 1.8i 16V - 2.0i - 2.0i 16V - 2.0DTi 16V (1996 A 2003)</p> <p>d44x60mm d36.5mm 1f-d12mm</p>
	<p>S1474 NO. 0423316 - 423316 - 90496686</p> <p>SILENT BLOC DA SUSPENSÃO DE TRÁS</p> <p>OPEL VECTRA B 1.6i - 1.7TD - 1.8i 16V - 2.0i - 2.0i 16V - 2.0DTi 16V (1995 A 2003) - STATION WAGON 1.6i - 1.8i 16V - 2.0i 16V - 2.0DTi 16V - (1996 A 2003)</p> <p>d35x89mm c45.5mm 1f-d12mm</p>		<p>S1476 NO. 423121 - 4567244 - 4836201 - 4836219 - 90495584 - 90496700</p> <p>SILENT BLOC DA SUSPENSÃO DE TRÁS</p> <p>OPEL VECTRA B (J96) 1.6 GL (F19) 09.1995/08.1996 60KW 82CV 1598CC 16 SV - OPEL VECTRA B (J96) 1.6 i (F19) 10.1995/04.2002 55KW 75CV 1598CC X 16 SZR 0039942 - OPEL VECTRA B (J96) 1.6 i (F19) 10.1995/04.2002 55KW 75CV 1598CC 16 LZ2 - OPEL VECTRA B (J96) 1.6 i 16V (F19) 10.1995/04.2002 74KW 100CV 1598CC X 16 XEL Y 16 XE Z 16 XE 0039943 - OPEL VECTRA B (J96) 1.7 TD (F19) 10.1995/12.1998 60KW 82CV 1686...</p> <p>d45x52mm c24mm 1f-d12mm</p>
	<p>T0645-I NO. 0344417 - 0344417 - 344417 - 90468644</p> <p>BATENTE SUSPENSÃO DA FRENTE</p> <p>OPEL VECTRA B Combi (3 1 _) 1.6 i (11.96 A 06.00) 75cv 1598cc Combi - OPEL VECTRA B Combi (31_) 1.6 i 16V (11.96 A 07.02) 100cv 1598cc Combi - OPEL VECTRA B Combi (31_) 1.8 i 16V (11.96 A 09.00) 115cv 1796cc Combi - OPEL VECTRA B Combi (31_) 1.8 i 16V (11.96 A 09.00) 115cv 1799cc Combi - OPEL VECTRA B Combi (31_) 1.8 i 16V (09.00 A 07.03) 125cv 1796cc Combi - OPEL VECTRA B Combi (31_) 2.0 i 1...</p> <p>d50x64mm 1f-d18mm 1f-d23mm</p>		<p>T1231 NO. 0444200 - 444200 - 90496706</p> <p>BATENTE DA BARRA ESTABILIZADORA DE TRÁS</p> <p>OPEL VECTRA B (J96) 1.6 i (F19) (De 10.1995 Até 04.2002) 55kW 75cv 1598cm3 três volumes - OPEL VECTRA B (J96) 1.6 i (F19) (De 10.1995 Até 04.2002) 55kW 75cv 1598cm3 três volumes - OPEL VECTRA B (J96) 1.6 i 16V (F19) (De 10.1995 Até 04.2002) 74kW 100cv 1598cm3 três volumes - OPEL VECTRA B (J96) 1.7 TD (F19) (De 10.1995 Até 12.1998) 60kW 82cv 1686cm3 três volumes - OPEL VECTRA B (J96) 1.8 i 16V (F19)...</p> <p>38x35x36mm 1f-d16mm</p>
	<p>UAP81292 NO. 0821038 - 0821074 - 0821437 - 0821675 - 4708869 - 4809347 - 821038 - 821074 - 821437 - 821675</p> <p>ANILHA PROTEÇÃO TÉRMICA INJECTORES</p> <p>OPEL VECTRA B Hatchback (J96) 2.0 DI 16V (F68) (De 11-1996 Até 06-2000) 60kW 82CV 1995cc Hatchback OPEL VECTRA B Hatchback (J96) 2.0 DTI 16V (F68) (De 06-1997 Até 07-2003) 74kW 101CV 1995cc Hatchback OPEL VECTRA B Hatchback (J96) 2.2 DTI 16V (F68) (De 09-2000 Até 07-2003) 92kW 125CV 2172cc Hatchback OPEL VECTRA B (J96) 2.0 DI 16V (F19) (De 11-1996 Até 04-2002) 60kW 82CV 1995cc três volumes OPE...</p> <p>d16x1mm 1f-d7mm</p>		<p>UAP81292 NO. 0821038 - 0821074 - 0821437 - 0821675 - 4708869 - 4809347 - 821038 - 821074 - 821437 - 821675</p> <p>ANILHA PROTEÇÃO TÉRMICA INJECTORES</p> <p>OPEL VECTRA B Hatchback (J96) 2.0 DI 16V (F68) (De 11-1996 Até 06-2000) 60kW 82CV 1995cc Hatchback OPEL VECTRA B Hatchback (J96) 2.0 DTI 16V (F68) (De 06-1997 Até 07-2003) 74kW 101CV 1995cc Hatchback OPEL VECTRA B Hatchback (J96) 2.2 DTI 16V (F68) (De 09-2000 Até 07-2003) 92kW 125CV 2172cc Hatchback OPEL VECTRA B (J96) 2.0 DI 16V (F19) (De 11-1996 Até 04-2002) 60kW 82CV 1995cc três volumes OPE...</p> <p>d16x1mm 1f-d7mm</p>
	<p>UMB84011 NO. 031126</p> <p>TAMPÃO BLOCO MOTOR</p> <p>OPEL VECTRA B Hatchback (J96) 1.6 i (F68) (De 10-1995 Até 07-2003) 55kW 75CV 1598cc Hatchback OPEL VECTRA B Hatchback (J96) 1.6 i 16V (F68) (De 10-1995 Até 07-2002) 74kW 101CV 1598cc Hatchback OPEL VECTRA B (J96) 1.6 i (F19) (De 10-1995 Até 04-2002) 55kW 75CV 1598cc três volumes OPEL VECTRA B (J96) 1.6 i 16V (F19) (De 10-1995 Até 04-2002) 74kW 100CV 1598cc três volumes OPEL VECTRA B Combi (J96)...</p> <p>d-18x8mm di-16mm</p>		<p>UMB84011L NO. 11062402 - 2060675</p> <p>TAMPÃO BLOCO DE MOTOR (RELAS)</p> <p>OPEL VECTRA B Hatchback (J96) 1.6 i (F68) (De 10-1995 Até 07-2003) 55kW 75CV 1598cc Hatchback OPEL VECTRA B Hatchback (J96) 1.6 i 16V (F68) (De 10-1995 Até 07-2002) 74kW 101CV 1598cc Hatchback OPEL VECTRA B (J96) 1.6 i (F19) (De 10-1995 Até 04-2002) 55kW 75CV 1598cc três volumes OPEL VECTRA B (J96) 1.6 i 16V (F19) (De 10-1995 Até 04-2002) 74kW 100CV 1598cc três volumes OPEL VECTRA B Combi (J96) 1....</p> <p>d-18x8mm di-16mm</p>
	<p>UMB84019 NO. 2060668</p> <p>TAMPÃO BLOCO MOTOR</p> <p>OPEL VECTRA B Hatchback (J96) 1.6 i (F68) (De 10-1995 Até 07-2003) 55kW 75CV 1598cc Hatchback OPEL VECTRA B Hatchback (J96) 1.6 i 16V (F68) (De 10-1995 Até 07-2002) 74kW 101CV 1598cc Hatchback OPEL VECTRA B Hatchback (J96) 1.8 i 16V (F68) (De 10-1995 Até 09-2000) 85kW 116CV 1796cc Hatchback OPEL VECTRA B Hatchback (J96) 1.8 i 16V (F68) (De 09-2000 Até 07-2003) 92kW 125CV 1796cc Hatchback OPEL ...</p> <p>d-26x9,5mm di-23,3mm</p>		<p>UMB84019L NO. 2060668</p> <p>TAMPÃO BLOCO DE MOTOR (RELAS)</p> <p>OPEL VECTRA B Hatchback (J96) 1.6 i (F68) (De 10-1995 Até 07-2003) 55kW 75CV 1598cc Hatchback OPEL VECTRA B Hatchback (J96) 1.6 i 16V (F68) (De 10-1995 Até 07-2002) 74kW 101CV 1598cc Hatchback OPEL VECTRA B Hatchback (J96) 1.8 i 16V (F68) (De 10-1995 Até 09-2000) 85kW 116CV 1796cc Hatchback OPEL VECTRA B Hatchback (J96) 1.8 i 16V (F68) (De 09-2000 Até 07-2003) 92kW 125CV 1796cc Hatchback OPEL VECT...</p> <p>d-26x9,5mm di-23,3mm</p>

	<p>UMB84021 NO. 2060673</p> <p>TAMPÃO BLOCO MOTOR</p> <p>OPEL VECTRA B Hatchback (J96) 1.6 i (F68) (De 10-1995 Até 07-2003) 55kW 75CV 1598cc Hatchback OPEL VECTRA B Hatchback (J96) 1.6 i 16V (F68) (De 10-1995 Até 07-2002) 74kW 101CV 1598cc Hatchback OPEL VECTRA B Hatchback (J96) 1.8 i 16V (F68) (De 10-1995 Até 09-2000) 85kW 116CV 1796cc Hatchback OPEL VECTRA B Hatchback (J96) 1.8 i 16V (F68) (De 09-2000 Até 07-2003) 92kW 125CV 1796cc Hatchback OPEL ...</p> <p>d-28x7mm di-25,6mm</p>		<p>UMB84021L NO. 2060673</p> <p>TAMPÃO BLOCO DE MOTOR (RELAS)</p> <p>OPEL VECTRA B Hatchback (J96) 1.6 i (F68) (De 10-1995 Até 07-2003) 55kW 75CV 1598cc Hatchback OPEL VECTRA B Hatchback (J96) 1.6 i 16V (F68) (De 10-1995 Até 07-2002) 74kW 101CV 1598cc Hatchback OPEL VECTRA B Hatchback (J96) 1.8 i 16V (F68) (De 10-1995 Até 09-2000) 85kW 116CV 1796cc Hatchback OPEL VECTRA B Hatchback (J96) 1.8 i 16V (F68) (De 09-2000 Até 07-2003) 92kW 125CV 1796cc Hatchback OPEL VECT...</p> <p>d-28x7mm di-25,6mm</p>
	<p>UMB84029 NO. 2060946</p> <p>TAMPÃO BLOCO MOTOR</p> <p>OPEL VECTRA B Hatchback (J96) 1.6 i (F68) (10.95 A 07.03) 75cv 1598cc Hatchback - OPEL VECTRA B Combi (J96) 2.0 i 16V (F35) (11.96 A 09.00) 136cv 1998cc Combi</p> <p>d36x10mm di-32mm</p>		<p>UMV26806 NO. 5738736 - 90511219</p> <p>MANETE PUNHO TOPO ALAVANCA MUDANÇAS 5 VELOCIDADES F19MM</p> <p>OPEL VECTRA B Hatchback (J96): 1.6 i (F68) 10.1995/07.2003 55KW 75CV 1598CC - OPEL VECTRA B Hatchback (J96): 2.0 i (F68) 10.1995/02.2002 82KW 112CV 1998CC - OPEL VECTRA B Hatchback (J96): 2.0 i 16V (F68) 09.1995/06.2000 100KW 136CV 1998CC - OPEL VECTRA B (J96): 1.6 i (F19) 10.1995/04.2002 55KW 75CV 1598CC - OPEL VECTRA B (J96): 2.0 i (F19) 10.1995/04.2002 82KW 112CV 1998CC - OPEL VECTRA B (J96): 2... </p> <p>55x47x45mm 1f-d19mm</p>
	<p>UMV26809 NO. 5738737 - 90540619 - 9200972</p> <p>MANETE PUNHO TOPO ALAVANCA MUDANÇAS 5 VELOCIDADES F32MM</p> <p>OPEL VECTRA B Hatchback (J96): 1.6 i 16V (F68) 10.1995/07.2002 74KW 101CV 1598CC - OPEL VECTRA B Hatchback (J96): 1.8 i 16V (F68) 10.1995/09.2000 85KW 116CV 1799CC - OPEL VECTRA B Hatchback (J96): 2.0 i (F68) 10.1995/02.2002 82KW 112CV 1998CC - OPEL VECTRA B Hatchback (J96): 2.5 i V6 (F68) 10.1995/09.2000 125KW 170CV 2498CC - OPEL VECTRA B Hatchback (J96): 2.6 i V6 (F68) 09.2000/07.2003 125KW 170CV...</p> <p>d50x51mm 1f-d32mm</p>		<p>UTR0811 NO. 1304659 - 1304660 - 1304661 - 1304665 - 1304666 - 1304853 - 4395513 - 90352470 - 90409256 - 90409257...</p> <p>TAMPÃO RESERVATÓRIO LIQUIDO REFRIGERAÇÃO</p> <p>OPEL VECTRA B Hatchback (38_) 1.6 i 16V Código do mot or: Y16XE, Código do mot or: X16XEL 10.95 - 07.02 74 101 1598 Hatchback OPEL VECTRA B Hatchback (38_) 1.8 i 16V Código do mot or: X18XE1 10.95 - 09.00 85 116 1796 Hatchback OPEL VECTRA B Hatchback (38_) 2.0 i 16V Código do mot or: X20XEV 10.95 - 09.00 100 136 1998 Hatchback OPEL VECTRA B Hatchback (38_) 2.0 DTI 16V Código do mot or: X20DTH 06.9...</p> <p>60x25mm 1f-d52x14mm</p>
	<p>UTR0820 NO. 90352470 - 90409256 - 90409257 - 9041032690497472 - 90467473</p> <p>TAMPÃO RESERVATÓRIO LIQUIDO REFRIGERAÇÃO</p> <p>OPEL VECTRA B Hatchback (38_) 1.6 i (10.95 A 07.03) 75cv 1598cc Hatchback - OPEL VECTRA B Hatchback (38_) 1.6 i 16V (10.95 A 07.02) 101cv 1598cc Hatchback - OPEL VECTRA B Hatchback (38_) 1.8 i 16V (10.95 A 09.00) 116cv 1796cc Hatchback - OPEL VECTRA B Hatchback (38_) 1.8 i 16V (10.95 A 09.00) 116cv 1799cc Hatchback - OPEL VECTRA B Hatchback (38_) 1.8 i 16V (09.00 A 07.03) 125cv 1796cc Hat...</p> <p>d62x23mm 1f-d53x12mm</p>		<p>UTR1200 NO. 1450599</p> <p>TAMPÃO RESERVATÓRIO LAVA VIDROS</p> <p>OPEL VECTRA B Hatchback (J96) 1.6 i (F68) (De 10-1995 Até 07-2003) 55kW 75CV 1598cc Hatchback OPEL VECTRA B Hatchback (J96) 1.6 i 16V (F68) (De 10-1995 Até 07-2002) 74kW 101CV 1598cc Hatchback OPEL VECTRA B Hatchback (J96) 1.8 i 16V (F68) (De 10-1995 Até 09-2000) 85kW 116CV 1796cc Hatchback OPEL VECTRA B Hatchback (J96) 2.0 i (F68) (De 10-1995 Até 02-2002) 82kW 112CV 1998cc Hatchback OPEL VECT...</p> <p>d41x6mm c54mm di-d35x7mm</p>
	<p>UTR1300 NO. 00650090 - 05650831</p> <p>TAMPÃO RESERVATÓRIO DO OLEO</p> <p>OPEL VECTRA B Hatchback (J96) 1.8 i 16V (F68) (De 10-1995 Até 09-2000) 85kW 116CV 1796cc Hatchback OPEL VECTRA B Hatchback (J96) 2.0 i 16V (F68) (De 10-1995 Até 06-2000) 100kW 136CV 1998cc Hatchback OPEL VECTRA B Hatchback (J96) 2.5 i V6 (F68) (De 10-1995 Até 09-2000) 125kW 170CV 2498cc Hatchback OPEL VECTRA B Hatchback (J96) 2.6 i V6 (F68) (De 09-2000 Até 07-2003) 125kW 170CV 2597cc Hatchback ...</p> <p>d59x31mm d45x12mm</p>		<p>UTR1305 NO. 0650089 - 650089</p> <p>TAMPÃO DO RESERVATÓRIO ÓLEO</p> <p>OPEL VECTRA B (J96) 1.6 i (F19) (10.1995 -04.2002) 55kw 75cv 1598cm3 três volumes OPEL VECTRA B (J96) 1.6 i 16V (F19) (10.1995 -04.2002) 74kw 100cv 1598cm3 três volumes OPEL VECTRA B (J96) 1.7 TD (F19) (10.1995 -12.1998) 60kw 82cv 1686cm3 três volumes OPEL VECTRA B (J96) 1.8 i 16V (F19) (10.1995 -09.2000) 85kw 115cv 1796cm3 três volumes OPEL VECTRA B (J96) 1.8 i 16V (F19) (09.2000 -04.2002) 92kw 1...</p> <p>d61x23mm d32x19mm</p>
	<p>UTR1305 NO. 0650089 - 650089</p> <p>TAMPÃO DO RESERVATÓRIO ÓLEO</p> <p>OPEL VECTRA B Combi (J96) 1.6 i (F35) (11.1996 -06.2000) 55 75 1598 Combi OPEL VECTRA B Combi (J96) 1.6 i 16V (F35) (11.1996 -07.2002) 74 100 1598 Combi OPEL VECTRA B Combi (J96) 1.8 i 16V (F35) (11.1996 -09.2000) 85 115 1796 Combi OPEL VECTRA B Combi (J96) 1.8 i 16V (F35) (09.2000 -07.2003) 92kw 125cv 1796cm3 Combi OPEL VECTRA B Combi (J96) 2.0 DI 16V (F35) (11.1996 -06.2000) 60kw 82cv 1995cm3 Co...</p> <p>d61x23mm d32x19mm</p>		<p>UTR1305 NO. 0650089 - 650089</p> <p>TAMPÃO DO RESERVATÓRIO ÓLEO</p> <p>OPEL VECTRA B Hatchback (J96) 1.6 i (F68) (10.1995 -07.2003) 55kw 75cv 1598cm3 Hatchback OPEL VECTRA B Hatchback (J96) 1.6 i 16V (F68) (10.1995 -07.2002) 74kw 101cv 1598cm3 Hatchback OPEL VECTRA B Hatchback (J96) 1.7 TD (F68) (10.1995 -12.1998) 60kw 82cv 1686cm3 Hatchback OPEL VECTRA B Hatchback (J96) 1.8 i 16V (F68) (10.1995 -09.2000) 85kw 115cv 1796cm3 Hatchback OPEL VECTRA B Hatchback (J96) 1.8 i 16V (F68) (10.1995 -09.2000) 85kw 116cv 1796cm3 Hatchback OPEL VECTRA B Hatchback (J96) 1.8...</p> <p>d61x23mm d32x19mm</p>
	<p>UTV83011 NO. 0652475 - 09275631 - 652475 - 652491 - 90409376 - 9275631 - N90288901</p> <p>TAMPÃO VEDAÇÃO BUJÃO</p> <p>OPEL VECTRA B Hatchback (J96) 1.6 i (F68) (De 10-1995 Até 07-2003) 55kW 75CV 1598cc Hatchback OPEL VECTRA B Hatchback (J96) 1.6 i (F68) (De 10-1995 Até 07-2003) 55kW 75CV 1598cc Hatchback OPEL VECTRA B Hatchback (J96) 1.6 i 16V (F68) (De 10-1995 Até 07-2002) 74kW 101CV 1598cc Hatchback OPEL VECTRA B Hatchback (J96) 2.5 i V6 (F68) (De 10-1995 Até 09-2000) 125kW 170CV 2498cc Hatchback OPEL VECTR...</p> <p>19x18mm c12mm d14mm</p>		<p>UTV83019 NO. 0652315 - 0652477 - 652315 - 652477 - 90502556 - 96023264</p> <p>TAMPÃO VEDAÇÃO BUJÃO</p> <p>OPEL VECTRA B Hatchback (J96) 1.6 i 16V (F68) (De 10-1995 Até 07-2002) 74kW 101CV 1598cc Hatchback OPEL VECTRA B Hatchback (J96) 1.8 i 16V (F68) (De 10-1995 Até 09-2000) 85kW 116CV 1796cc Hatchback OPEL VECTRA B Hatchback (J96) 1.8 i 16V (F68) (De 09-2000 Até 07-2003) 92kW 125CV 1796cc Hatchback OPEL VECTRA B Hatchback (J96) 2.0 i 16V (F68) (De 10-1995 Até 06-2000) 100kW 136CV 1998cc Hatchback ...</p> <p>d25x14mm c9mm d13mm</p>
	<p>W5034 NO. 614654</p> <p>POLIE DA CABBOTA (6 PISTAS)</p> <p>OPEL VECTRA B 1.8i 16v - 2.0i - 2.0i 16v - 2.2DTi 16v</p> <p>d138mm d42mm</p>		<p>W5045 NO. 5614417 - 614457 - 614637 - 97011870 - 97129070</p> <p>POLIE DA CABBOTA (1+1+1 PISTAS)</p> <p>OPEL VECTRA B Hatchback (J96): 1.7 TD (F68) 10.1995/12.1998 60KW 82CV 1686CC - OPEL VECTRA B (J96): 1.7 TD (F19) 10.1995/12.1998 60KW 82CV 1686CC - OPEL VECTRA B Combi (J96): 1.7 TD (F35) 11.1996/12.1997 60KW 82CV 1686CC</p> <p>d139mm d48mm</p>

	W5051	NO. 0614411 - 09128177 - 09544461 - 55351711 - 5535171169 - 5614415 - 5614437 - 614411 - 614444 - 9...		W5069	NO. 5614413 - 614654 - 90466618
	POLIE DA CAMBOTA (6 PISTAS) OPEL VECTRA B (J96) 2.0 DI 16V (F19) 11.1996/04.2002 60KW 82CV 1995CC X 20 DTL 0039967 - OPEL VECTRA B (J96) 2.0 DTI 16V (F19) 06.1997/04.2002 74KW 101CV 1995CC X 20 DTH 20 DTH 0039172 - OPEL VECTRA B (J96) 2.2 DTI 16V (F19) 09.2000/04.2002 88KW 120CV 2172CC Y 22 DTR 0039189 - OPEL VECTRA B (J96) 2.2 DTI 16V (F19) 09.2000/04.2002 92KW 125CV 2172CC Y 22 DTR 0039186 - OPEL VECTRA B Combi (J96) 2.0 ...			POLIE DA CAMBOTA (6 PISTAS) OPEL VECTRA B 1.8i 16v - 2.0i - 2.0i 16v - 2.2i 16v	
d153mm		d35mm	d140/141mm		d42mm
	W5092	NO. 5614428 - 615029 - 90424119		Y3004	NO. 854982 - 90128082
	POLIE DA CAMBOTA (5 PISTAS) OPEL VECTRA B 2.0i Motor 20NEJ (10-1995 A 04-2002)			PARAFUSO ESCAPE OPEL VECTRA B (APÓS 1995)	
d147mm		d42mm	d19x65mm		d12mm 1r-d10mm
	Y3212	NO. 1008501 - 1008504 - 4709077		Z80540	NO. 2240861 - 90022049
	PARAFUSO PERNO RODA CHAVE 17 M12X1,50X48MM (BASE CONICA PARA JANTES AÇO E LIGA LEVE) OPEL VECTRA B (J96) 1.6 i (F19) (10.1995 - 04.2002) 55kw 75cv 1598cm3 três volumes OPEL VECTRA B (J96) 1.6 i (F19) (10.1995 - 04.2002) 55kw 75cv 1598cm3 três volumes OPEL VECTRA B (J96) 1.6 i 16V (F19) 10.1995 - 04.2002) 74kw 100cv 1598cm3 três volumes OPEL VECTRA B (J96) 1.7 TD (F19) (10.1995 - 12.1998) 60kw 82cv 1686cm3 três volumes OPEL VECTRA B (J96) 1.8 i 16V (F19) (10.1995 - 09.2000) 85kw 11...			Mola de painel OPEL VECTRA B	
C48mm (Ch-17mm)		M12x1,50x22mm	d12x14.3mm		1p-d7-12.3mm
	Z80846	NO. 1104881 - 1104882 - 90450482		Z9000	NO. 25501711 - 854880 - 854881 - 854884 - 858884 - 90234204
	Rebite OPEL VECTRA B			MOLA DE ESCAPE 42mm OPEL VECTRA B (1992 A 2002)	
d19x29mm		1p-d8-15.2mm	d18x26mm		

OPEL VECTRA C

	A2367	NO. 13112026 - 5684649		A2368	NO. 13183100 - 5684865
	APOIO DO MOTOR PARTE DA FRENTE DIREITO OPEL VECTRA C (Z02) 1.9 CDTI (F69) (De 10.2005 Até 08.2008) 74KW 100cv 1910cm3 três volumes - OPEL VECTRA C (Z02) 1.9 CDTI (F69) (De 04.2004 Até 01.2009) 88KW 120cv 1910cm3 três volumes - OPEL VECTRA C (Z02) 1.9 CDTI (F69) (De 04.2004 Até 08.2008) 110KW 150cv 1910cm3 três volumes - OPEL VECTRA C Combi (Z02) 1.9 CDTI (F35) (De 06.2005 Até 08.2008) 74KW 100cv 1910cm3 Combi - OPEL VECTRA C Combi (Z02...			APOIO DO MOTOR LADO DIREITO OPEL VECTRA C (Z02) 1.9 CDTI (F69) (De 10.2005 Até 08.2008) 74KW 100cv 1910cm3 três volumes - OPEL VECTRA C (Z02) 1.9 CDTI (F69) (De 04.2004 Até 01.2009) 88KW 120cv 1910cm3 três volumes - OPEL VECTRA C Combi (Z02) 1.9 CDTI (F35) (De 06.2005 Até 08.2008) 74KW 100cv 1910cm3 Combi - OPEL VECTRA C Combi (Z02) 1.9 CDTI (F35) (De 04.2004 Até 01.2009) 88KW 120cv 1910cm3 Combi - OPEL VECTRA C (Z02) 1.9 CDTI (F69) (De 04.2004 Até 08.2008) 110KW 150cv 1910cm3 três volumes - OPEL VECTRA C (Z02) 2.0 DTI 16V (F69) (De 04.2002 Até 08.2006) 74KW 101cv 1995cm3 três volumes - OPEL VECTRA C (Z02) ...	
201x114x76mm		2f-d12mm 1f-d15mm	201x114x76mm		2f-d12mm 1f-d15mm
	A2369	NO. 13166642 - 13191586 - 13207585 - 5684650 - 5684661 - 5684689		A2370	NO. 09156933 - 5684166 - 9156933
	APOIO DO MOTOR PARTE DA FRENTE ESQUERDO OPEL VECTRA C (Z02) 1.9 CDTI (F69) (De 10.2005 Até 08.2008) 74KW 100cv 1910cm3 três volumes - OPEL VECTRA C (Z02) 1.9 CDTI (F69) (De 04.2004 Até 01.2009) 88KW 120cv 1910cm3 três volumes - OPEL VECTRA C (Z02) 1.9 CDTI (F69) (De 04.2004 Até 08.2008) 110KW 150cv 1910cm3 três volumes - OPEL VECTRA C Combi (Z02) 1.9 CDTI (F35) (De 06.2005 Até 08.2008) 74KW 100cv 1910cm3 Combi - OPEL VECTRA C Combi (Z02...			APOIO DO MOTOR PARTE DE TRÁS EM BAIXO OPEL VECTRA C (Z02) 1.9 CDTI (F69) (De 10.2005 Até 08.2008) 74KW 100cv 1910cm3 três volumes - OPEL VECTRA C (Z02) 1.9 CDTI (F69) (De 04.2004 Até 01.2009) 88KW 120cv 1910cm3 três volumes - OPEL VECTRA C (Z02) 1.9 CDTI (F69) (De 04.2004 Até 08.2008) 110KW 150cv 1910cm3 três volumes - OPEL VECTRA C (Z02) 2.0 DTI 16V (F69) (De 04.2002 Até 08.2006) 74KW 101cv 1995cm3 três volumes - OPEL VECTRA C (Z02) ...	
165x122x151mm		4f-d6mm 3f-d13mm	195x103x76mm		2f-d10mm 1f-d12mm
	A2635	NO. 13207586		A2693	NO. 13112029 - 5684143
	APOIO DO MOTOR FRENTE LADO ESQUERDO OPEL VECTRA C (Z02) 1.9 CDTI (F69) 04.2004/01.2009 88KW 120CV 1910CC Z 19 DT 0035ABR 0035090 0035023 - OPEL VECTRA C (Z02) 1.9 CDTI (F69) 10.2005/08.2008 74KW 100CV 1910CC Z 19 DTL 0035108 0035ABS - OPEL VECTRA C (Z02) 2.2 16V (F69) 04.2002/12.2008 108KW 147CV 2198CC Z 22 SE 0035ABN 0035082 0035449 - OPEL VECTRA C (Z02) 2.2 DGi (F69) 10.2003/08.2008 114KW 155CV 2198CC Z 22 YH 0035ABO 0035094 00350...			APOIO DO MOTOR PARTE DE TRÁS CAIXA AUTOMÁTICA OPEL VECTRA C (Z02) 1.9 CDTI (F69) (04.2004 - 08.2008) 110kw 150cv 1910cm3 três volumes	
168x125x171mm		4f-d9mm 3f-d16mm	228x132x118mm		1f-d6mm 3f-d12mm 1f-d16mm

	<p>A2693 NO. 13112029 - 5684143</p> <p>APOIO DO MOTOR PARTE DE TRÁS CAIXA AUTOMÁTICA</p> <p>OPEL VECTRA C Combi (Z02) 1.9 CDTI (F35) (04.2004 - 08.2008) 110kw 150cv 1910cm3 Combi</p> <p>228x132x118mm 1f-d6mm 3f-d12mm 1f-d16mm</p>		<p>A2693 NO. 13112029 - 5684143</p> <p>APOIO DO MOTOR PARTE DE TRÁS CAIXA AUTOMÁTICA</p> <p>OPEL VECTRA C GTS (Z02) 1.9 CDTI (F68) (04.2004 - 08.2008) 110kw 150cv 1910cm3 Hatchback</p> <p>228x132x118mm 1f-d6mm 3f-d12mm 1f-d16mm</p>
	<p>E1092 NO. 0852726 - 13276148 - 852577 - 852726 - 90466668</p> <p>ESTICADOR DE ESCAPE</p> <p>OPEL VECTRA C GTS (Z02): 1.6 (F68) 08.2005/08.2008 74KW 100CV 1598CC - OPEL VECTRA C GTS (Z02): 1.6 (F68) 01.2006/08.2008 77KW 105CV 1598CC - OPEL VECTRA C GTS (Z02): 1.8 16V (F68) 08.2002/09.2008 90KW 122CV 1796CC - OPEL VECTRA C GTS (Z02): 1.8 (F68) 08.2005/08.2008 103KW 140CV 1796CC - OPEL VECTRA C GTS (Z02): 2.0 16V Turbo (F68) 03.2003/08.2008 129KW 175CV 1998CC - OPEL VECTRA C GTS (Z02): 2.2 ...</p> <p>55x40x35mm</p>		<p>F1827-I NO. 4410859</p> <p>FOLE DA TRANSMISSÃO JUNTO À CAIXA</p> <p>OPEL VIVARO 1.9 Di - 1.9 DTi - 2.0i 16V - 2.5 DTi (APÓS 2001)</p> <p>d115x85mm 1f-d73mm 1f-d42mm</p>
	<p>F4141 NO. 5738393 - 5738939 - 93176450 - 738125</p> <p>FOLE ALAVANCA VELOCIDADES</p> <p>OPEL VECTRA C GTS (Z02): 1.6 (F68) 08.2005/08.2008 74KW 100CV 1598CC - OPEL VECTRA C GTS (Z02): 1.6 (F68) 01.2006/08.2008 77KW 105CV 1598CC - OPEL VECTRA C GTS (Z02): 1.8 16V (F68) 08.2002/12.2006 81KW 110CV 1796CC - OPEL VECTRA C GTS (Z02): 1.8 16V (F68) 08.2002/09.2008 90KW 122CV 1796CC - OPEL VECTRA C GTS (Z02): 1.8 (F68) 08.2005/08.2008 103KW 140CV 1796CC - OPEL VECTRA C GTS (Z02): 2.0 16V Turbo (F68) 03.2003/08.2008 129KW 175CV 1998CC - OPEL VECTRA C GTS (Z02): 2.0 16V Tur...</p> <p>165x144x180mm 1f-d35mm</p>		<p>KF1686-T NO. 1603232</p> <p>KIT DE FOLE DO CARDAN JUNTO À RODA</p> <p>OPEL VECTRA C E GTS 2.0iT - 2.2 DTi - 3.0 CDTi - 3.2i (2002 A 2008)</p> <p>d105x130mm 1f-d90mm 1f-d27mm</p>
	<p>KF2362-T NO. 1603232 - 1603278 - 1603281 - 1603284 - 93182574</p> <p>KIT DE FOLE DO CARDAN JUNTO À RODA</p> <p>OPEL VECTRA C & GTS (APÓS 2002) 1.9CDTi 16V - 1.9CDTi 8V</p> <p>d104x130mm 1f-d91mm 1f-d27mm</p>		<p>KF9007H-I NO. 1603526 - 30788265 - 6G9N-4A084-DA</p> <p>KIT FOLE TRANSMISSÃO JUNTO À RODA</p> <p>OPEL VECTRA C (Z02) 2.8 V6 Turbo (F69) (De 08.2005 Até 10.2006) 169kW 230cv 2792cm3 três volumes - OPEL VECTRA C (Z02) 2.8 V6 Turbo (F69) (De 08.2005 Até 08.2008) 184kW 250cv 2792cm3 três volumes - OPEL VECTRA C (Z02) 2.8 V6 Turbo (F69) (De 08.2005 Até 09.2006) 188kW 255cv 2792cm3 três volumes - OPEL VECTRA C (Z02) 3.0 CDTi (F69) (De 08.2005 Até 08.2008) 135kW 184cv 2959cm3 três volumes - OPEL VEC...</p> <p>d110x133mm 1f-d96mm 1f-d28mm</p>
	<p>KL80449 NO. 198283 - 607813 - 90412865</p> <p>KIT CASQUILHOS COBERTURA TAMPA MOTOR</p> <p>OPEL VECTRA C GTS (Z02): 1.8 16V (F68) 08.2002/12.2006 81KW 110CV 1796CC - OPEL VECTRA C GTS (Z02): 1.8 16V (F68) 08.2002/09.2008 90KW 122CV 1796CC - OPEL VECTRA C GTS (Z02): 1.9 CDTi (F68) 06.2005/08.2008 74KW 100CV 1910CC - OPEL VECTRA C GTS (Z02): 1.9 CDTi (F68) 04.2004/01.2009 88KW 120CV 1910CC - OPEL VECTRA C GTS (Z02): 2.0 DTi 16V (F68) 08.2002/08.2005 74KW 101CV 1995CC - OPEL VECTRA C GTS (...)</p> <p>d16x10mm 1f-d6mm</p>		<p>R080253 NO. 06336007 - 09128719</p> <p>TUBO LÍQUIDO REFRIGERAÇÃO</p> <p>OPEL VECTRA C (Z02) 1.6 16V (F69) 04.2002/10.2005 74KW 100CV 1598CC Z 16 XE 0035ABK 0035070 0035444 - OPEL VECTRA C GTS (Z02) 1.6 (F68) 08.2005/08.2008 74KW 100CV 1598CC Z 16 XE 0035071 0035454 0035ABX</p> <p>B340-30/35mm ch-d13-29mm ch-d13-30mm</p>
	<p>R221405 NO. 13119222 - 6336095</p> <p>TUBO SUPERIOR DO RADIADOR</p> <p>OPEL VECTRA C (Z02) 1.9 CDTi (F69) (De 04.2004 Até 01.2009) 88KW 120cv 1910cm3 três volumes - OPEL VECTRA C (Z02) 1.9 CDTi (F69) (De 04.2004 Até 08.2008) 110KW 150cv 1910cm3 três volumes - OPEL VECTRA C Combi (Z02) 1.9 CDTi (F35) (De 04.2004 Até 01.2009) 88KW 120cv 1910cm3 Combi - OPEL VECTRA C Combi (Z02) 1.9 CDTi (F35) (De 04.2004 Até 08.2008) 110KW 150cv 1910cm3 Combi - OPEL VECTRA C GTS (Z02) ...</p> <p>B380-33/34mm 66x101x105x123mm</p>		<p>R222813 NO. 24415009 - 5835820 - 58358201 - 835156 - 9178635</p> <p>TUBO DO AR SOBREALIMENTAÇÃO</p> <p>OPEL VECTRA C (Z02) 2.0 DTi 16V (F69) 04.2002/08.2006 74KW 101CV 1995CC Y 20 DTH 0035072 0035073 0035453 - OPEL VECTRA C (Z02) 2.2 DTi 16V (F69) 04.2002/12.2004 86KW 117CV 2172CC Y 22 DTR 0035448 - OPEL VECTRA C (Z02) 2.2 DTi 16V (F69) 04.2002/07.2004 92KW 125CV 2172CC Y 22 DTR 0035078 0035447 - OPEL VECTRA C Combi (Z02) 2.0 DTi (F35) 10.2003/08.2005 74KW 100CV 1995CC Y 20 DTH 0035065 0035020 - OP...</p> <p>B255-52/53mm 51x76x69x50mm</p>
	<p>R222814 NO. 58358202</p> <p>TUBO DO AR SOBREALIMENTAÇÃO</p> <p>OPEL VECTRA C (Z02) 2.0 DTi 16V (F69) (De 04.2002 Até 08.2006) 74KW 101cv 1995cm3 três volumes - OPEL VECTRA C (Z02) 2.2 DTi 16V (F69) (De 04.2002 Até 12.2004) 86KW 117cv 2172cm3 três volumes - OPEL VECTRA C (Z02) 2.2 DTi 16V (F69) (De 04.2002 Até 07.2004) 92KW 125cv 2172cm3 três volumes - OPEL VECTRA C Combi (Z02) 2.0 DTi (F35) (De 10.2003 Até 08.2005) 74KW 100cv 1995cm3 Combi - OPEL VECTRA C Com...</p> <p>B195-50/51mm 59x82x53x59mm</p>		<p>R222821 NO. 24415006 - 55352542 - 860468 - 95515194</p> <p>TUBO DO AR SOBREALIMENTAÇÃO</p> <p>OPEL VECTRA C (Z02) 2.0 16V Turbo (F69) (De 03.2003 Até 08.2008) 17500kW 129cv 175cm3 1998 - OPEL VECTRA C (Z02) 2.0 DTi 16V (F69) (De 04.2002 Até 08.2006) 16458kW 74cv 101cm3 1995 - OPEL VECTRA C (Z02) 2.2 DTi 16V (F69) (De 04.2002 Até 12.2004) 54921kW 86cv 117cm3 2172 - OPEL VECTRA C (Z02) 2.2 DTi 16V (F69) (De 04.2002 Até 07.2004) 16451kW 92cv 125cm3 2172 - OPEL VECTRA C Combi (Z02) 2.0 DTi (F3...</p> <p>B273-36/38mm 61x80x61x55mm</p>
	<p>R225290 NO. 13289474 - 55352734 - 55354286 - 5860824 - 835037</p> <p>TUBO DO AR SOBREALIMENTAÇÃO</p> <p>OPEL VECTRA C (Z02) 1.9 CDTi (F69) (De 10.2005 Até 08.2008) 74KW 100cv 1910cm3 três volumes - OPEL VECTRA C (Z02) 1.9 CDTi (F69) (De 04.2004 Até 01.2009) 88KW 120cv 1910cm3 três volumes - OPEL VECTRA C (Z02) 1.9 CDTi (F69) (De 04.2004 Até 08.2008) 110KW 150cv 1910cm3 três volumes - OPEL VECTRA C Combi (Z02) 1.9 CDTi (F35) (De 06.2005 Até 08.2008) 74KW 100cv 1910cm3 Combi - OPEL VECTRA C Combi (Z0...</p> <p>B122-37/46mm 60x62mm</p>		<p>RT80340 NO. 24436541 - 5562203</p> <p>TUBO DE TRAVÃO FRENTE LH - RH</p> <p>OPEL VECTRA C (Z02) 1.6 (F69) (08.2005 - 08.2008) 77kw 105cv 1598cm3 três volumes OPEL VECTRA C (Z02) 1.6 16V (F69) (04.2002 - 10.2005) 74kw 100cv 1598cm3 três volumes OPEL VECTRA C (Z02) 1.8 (F69) (04.2002 - 07.2008) 81kw 110cv 1796cm3 três volumes OPEL VECTRA C (Z02) 1.8 (F69) (08.2005 - 08.2008) 103kw 140cv 1796cm3 três volumes OPEL VECTRA C (Z02) 1.8 16V (04.2002 - 09.2008) 90kw 122cv 1796cm3 ...</p> <p>430x11mm 1f-d10mm 1f-d12mm</p>

 <p>Componenti / Components</p>	<p>RT80340 NO. 24436541 - 5562203</p> <p>TUBO DE TRAVÃO FRENTE LH - RH</p> <p>OPEL VECTRA C Combi (Z02) 1.8 (F35) (10.2003 - 09.2006) 90kw 122cv 1796cm3 Combi OPEL VECTRA C Combi (Z02) 1.8 (F35) (08.2005 - 08.2008) 103kw 140cv 1796cm3 Combi OPEL VECTRA C Combi (Z02) 1.9 CDTI (F35) (06.2005 - 08.2008) 74kw 100cv 1910cm3 Combi OPEL VECTRA C Combi (Z02) 1.9 CDTI (F35) (04.2004 - 01.2009) 88kw 120cv 1910cm3 Combi OPEL VECTRA C Combi (Z02) 1.9 CDTI (F35) (04.2004 - 08.2008) 110k...</p> <p>430x11mm 1r-d10mm 1f-d12mm</p>	 <p>Componenti / Components</p>	<p>RT80340 NO. 24436541 - 5562203</p> <p>TUBO DE TRAVÃO FRENTE LH - RH</p> <p>OPEL VECTRA C GTS (Z02) 1.6 (F68) (08.2005 - 08.2008) 74kw 100cv 1598cm3 Hatchback OPEL VECTRA C GTS (Z02) 1.6 (F68) (01.2006 - 08.2008) 77kw 105cv 1598cm3 Hatchback OPEL VECTRA C GTS (Z02) 1.8 (F68) (08.2005 - 08.2008) 103kw 140cv 1796cm3 Hatchback OPEL VECTRA C GTS (Z02) 1.8 16V (F68) (08.2002 - 09.2008) 90kw 122cv 1796cm3 Hatchback OPEL VECTRA C GTS (Z02) 1.9 CDTI (F68) (06.2005 - 08.2008) 74kw...</p> <p>430x11mm 1r-d10mm 1f-d12mm</p>
	<p>S1894 NO. 0423001 - 24417090</p> <p>SILENT-BLOC BRAÇO SUSPENSÃO SUPERIOR TRÁS PARTE INTERIOR</p> <p>OPEL VECTRA C (ZA15:F17602) 1.6 (F69) (De 08.2005 Até 08.2008) 77kW 105cv 1598cm3 três volumes - OPEL VECTRA C (Z02) 1.6 (F69) (De 08.2005 Até 08.2008) 77kW 105cv 1598cm3 três volumes - OPEL VECTRA C (Z02) 1.6 (F69) (De 08.2005 Até 08.2008) 77kW 105cv 1598cm3 três volumes - OPEL VECTRA C (Z02) 1.6 16V (F69) (De 06.2004 Até 09.2008) 74kW 100cv 1598cm3 três volumes - OPEL VECTRA C (Z02) 1.6 16V (F69)...</p> <p>d35x61mm c42mm 1f-d12mm</p>		<p>T1180 NO. 0444160 - 0444163 - 444160 - 444163</p> <p>BATENTE DA BARRA ESTABILIZADORA DE TRÁS</p> <p>OPEL VECTRA C GTS (Z02) 1.6 (F68) (De 08-2005 Até 08-2008) 74kW 100CV 1598cc Hatchback OPEL VECTRA C GTS (Z02) 1.6 (F68) (De 01-2006 Até 08-2008) 77kW 105CV 1598cc Hatchback OPEL VECTRA C GTS (Z02) 1.8 16V (F68) (De 08-2002 Até 09-2008) 90kW 122CV 1796cc Hatchback OPEL VECTRA C GTS (Z02) 1.8 16V (F68) (De 08-2002 Até 09-2008) 90kW 122CV 1796cc Hatchback OPEL VECTRA C GTS (Z02) 2.0 16V Turbo (F68)...</p> <p>38x38x37mm 1f-d16mm</p>
	<p>T1217 NO. 0444161 - 444161</p> <p>BATENTE DA BARRA ESTABILIZADORA DE TRÁS</p> <p>OPEL VECTRA C (Z02) 2.0 DTI 16V (F69) (De 2002.04 Até 2006.08) 74kW 101cv 1995cm3 três volumes - OPEL VECTRA C (Z02) 2.2 DTI 16V (F69) (De 2002.04 Até 2004.12) 86kW 117cv 2172cm3 três volumes - OPEL VECTRA C (Z02) 2.2 DTI 16V (F69) (De 2002.04 Até 2004.07) 92kW 125cv 2172cm3 três volumes - OPEL VECTRA C (Z02) 3.0 CDTI (F69) (De 2003.02 Até 2005.07) 130kW 177cv 2958cm3 três v...</p> <p>37x38x36mm 1f-d18mm</p>		<p>U0314 NO. 0424761</p> <p>ANILHA DA SUSPENSÃO DAS MOLAS DE TRÁS INFERIOR</p> <p>OPEL VECTRA C (Z02) 1.6 (F69) (08.2005 - 08.2008) 77kw 105cv 1598cm3 três volumes OPEL VECTRA C (Z02) 1.6 16V (F69) (04.2002 - 10.2005) 74kw 100cv 1598cm3 três volumes OPEL VECTRA C (Z02) 1.8 (F69) (04.2002 - 07.2008) 81kw 110cv 1796cm3 três volumes OPEL VECTRA C (Z02) 1.8 (F69) (08.2005 - 08.2008) 103kw 140cv 1796cm3 três volumes OPEL VECTRA C (Z02) 1.8 16V (F69) (04.2002 - 09.2008) 90kw 122cv 1796cm3 ...</p> <p>d132x22mm 1f-d33mm</p>
	<p>U0314 NO. 0424761</p> <p>ANILHA DA SUSPENSÃO DAS MOLAS DE TRÁS INFERIOR</p> <p>OPEL VECTRA C Combi (Z02) 1.6 (F35) (12.2005 - 08.2008) 77kw 105cv 1598cm3 Combi OPEL VECTRA C Combi (Z02) 1.8 (F35) (10.2003 - 09.2006) 90kw 122cv 1796cm3 Combi OPEL VECTRA C Combi (Z02) 1.8 (F35) (08.2005 - 08.2008) 103kw 140cv 1796cm3 Combi OPEL VECTRA C Combi (Z02) 1.9 CDTI (F35) (06.2005 - 08.2008) 74kw 100cv 1910cm3 Combi OPEL VECTRA C Combi (Z02) 1.9 CDTI (F35) (04.2004 - 01.2009) 88kw 120cv...</p> <p>d132x22mm 1f-d33mm</p>		<p>U0314 NO. 0424761</p> <p>ANILHA DA SUSPENSÃO DAS MOLAS DE TRÁS INFERIOR</p> <p>OPEL VECTRA C GTS (Z02) 1.6 (F68) (08.2005 - 08.2008) 74kw 100cv 1598cm3 Hatchback OPEL VECTRA C GTS (Z02) 1.6 (F68) (01.2006 - 08.2008) 77kw 105cv 1598cm3 Hatchback OPEL VECTRA C GTS (Z02) 1.8 (F68) (08.2005 - 08.2008) 103kw 140cv 1796cm3 Hatchback OPEL VECTRA C GTS (Z02) 1.8 16V (F68) (08.2002 - 12.2006) 81kw 110cv 1796cm3 Hatchback OPEL VECTRA C GTS (Z02) 1.8 16V (F68) (08.2002 - 09.2008) 90kw ...</p> <p>d132x22mm 1f-d33mm</p>
	<p>UAP81292 NO. 0821038 - 0821074 - 0821437 - 0821675 - 4708869 - 4809347 - 821038 - 821074 - 821437 - 821675</p> <p>ANILHA PROTEÇÃO TÉRMICA INJECTORES</p> <p>OPEL VECTRA C GTS (Z02) 2.0 DTI 16V (F68) (De 08-2002 Até 08-2005) 74kW 101CV 1995cc Hatchback OPEL VECTRA C GTS (Z02) 2.2 DTI 16V (F68) (De 08-2002 Até 06-2008) 86kW 117CV 2172cc Hatchback OPEL VECTRA C GTS (Z02) 2.2 DTI 16V (F68) (De 08-2002 Até 07-2006) 92kW 125CV 2172cc Hatchback OPEL VECTRA C (Z02) 2.2 DTI 16V (F69) (De 04-2002 Até 12-2004) 86kW 117CV 2172cc três volumes OPEL VECTRA C (Z0...</p> <p>d16x1mm 1f-d7mm</p>		<p>UAP81292 NO. 0821038 - 0821074 - 0821437 - 0821675 - 4708869 - 4809347 - 821038 - 821074 - 821437 - 821675</p> <p>ANILHA PROTEÇÃO TÉRMICA INJECTORES</p> <p>OPEL VECTRA C GTS (Z02) 2.0 DTI 16V (F68) (De 08-2002 Até 08-2005) 74kW 101CV 1995cc Hatchback OPEL VECTRA C GTS (Z02) 2.2 DTI 16V (F68) (De 08-2002 Até 06-2008) 86kW 117CV 2172cc Hatchback OPEL VECTRA C GTS (Z02) 2.2 DTI 16V (F68) (De 08-2002 Até 07-2006) 92kW 125CV 2172cc Hatchback OPEL VECTRA C (Z02) 2.2 DTI 16V (F69) (De 04-2002 Até 12-2004) 86kW 117CV 2172cc três volumes OPEL VECTRA C (Z0...</p> <p>d16x1mm 1f-d7mm</p>
	<p>UCRZ1055 NO. 0905000 - 0905005 - 0905009 - 5905104</p> <p>CRUZETA VEIO DIREÇÃO D16X39MM</p> <p>OPEL VECTRA C (Z02) 1.6 (F69) (De 08.2005 Até 08.2008) 77kW 105cv 1598cm3 três volumes - OPEL VECTRA C (Z02) 1.6 16V (F69) (De 07.2004 Até 10.2005) 74kW 100cv 1598cm3 três volumes - OPEL VECTRA C (Z02) 1.8 (F69) (De 04.2002 Até 07.2008) 81kW 110cv 1796cm3 três volumes - OPEL VECTRA C (Z02) 1.8 (F69) (De 08.2005 Até 08.2008) 103kW 140cv 1796cm3 três volumes - OPEL VECTRA C (Z02) 1.8 16V (De 04.2000...</p> <p>d16x28x41mm</p>		<p>UMB84011 NO. 031126</p> <p>TAMPÃO BLOCO MOTOR</p> <p>OPEL VECTRA C GTS (Z02) 1.6 (F68) (De 08-2005 Até ...) 74kW 100CV 1598cc Hatchback OPEL VECTRA C (Z02) 1.6 16V (F69) (De 06-2004 Até ...) 74kW 100CV 1598cc três volumes</p> <p>d-18x8mm di-16mm</p>
	<p>UMB84011L NO. 11062402 - 2060675</p> <p>TAMPÃO BLOCO DE MOTOR (RELAS)</p> <p>OPEL VECTRA C GTS (Z02) 1.6 (F68) (De 08-2005 Até ...) 74kW 100CV 1598cc Hatchback OPEL VECTRA C (Z02) 1.6 16V (F69) (De 06-2004 Até ...) 74kW 100CV 1598cc três volumes</p> <p>d-18x8mm di-16mm</p>		<p>UMB84019 NO. 2060668</p> <p>TAMPÃO BLOCO MOTOR</p> <p>OPEL VECTRA C GTS (Z02) 1.6 (F68) (De 08-2005 Até ...) 74kW 100CV 1598cc Hatchback OPEL VECTRA C GTS (Z02) 1.8 16V (F68) (De 08-2002 Até 12-2006) 81kW 110CV 1796cc Hatchback OPEL VECTRA C GTS (Z02) 1.8 16V (F68) (De 08-2002 Até ...) 90kW 122CV 1796cc Hatchback OPEL VECTRA C (Z02) 1.6 16V (F69) (De 06-2004 Até ...) 74kW 100CV 1598cc três volumes OPEL VECTRA C (Z02) 1.8 (F69) (De 04-2002 Até</p> <p>d-26x9,5mm di-23,3mm</p>
	<p>UMB84019L NO. 2060668</p> <p>TAMPÃO BLOCO DE MOTOR (RELAS)</p> <p>OPEL VECTRA C GTS (Z02) 1.6 (F68) (De 08-2005 Até ...) 74kW 100CV 1598cc Hatchback OPEL VECTRA C GTS (Z02) 1.8 16V (F68) (De 08-2002 Até 12-2006) 81kW 110CV 1796cc Hatchback OPEL VECTRA C GTS (Z02) 1.8 16V (F68) (De 08-2002 Até ...) 90kW 122CV 1796cc Hatchback OPEL VECTRA C (Z02) 1.6 16V (F69) (De 06-2004 Até ...) 74kW 100CV 1598cc três volumes OPEL VECTRA C (Z02) 1.8 (F69) (De 04-2002 Até ...) 81...</p> <p>d-26x9,5mm di-23,3mm</p>		<p>UMB84021 NO. 2060673</p> <p>TAMPÃO BLOCO MOTOR</p> <p>OPEL VECTRA C GTS (Z02) 1.6 (F68) (De 08-2005 Até ...) 74kW 100CV 1598cc Hatchback OPEL VECTRA C (Z02) 1.6 16V (F69) (De 06-2004 Até ...) 74kW 100CV 1598cc três volumes</p> <p>d-28x7mm di-25,6mm</p>

	<p>UMB84021L NO. 2060673</p> <p>TAMPÃO BLOCO DE MOTOR (RELAS)</p> <p>OPEL VECTRA C GTS (Z02) 1.6 (F68) (De 08-2005 Até ...) 74kW 100CV 1598cc Hatchback OPEL VECTRA C (Z02) 1.6 16V (F69) (De 06-2004 Até ...) 74kW 100CV 1598cc três volumes</p> <p>d-28x7mm di-25,6mm</p>		<p>UMB84029 NO. 2060946</p> <p>TAMPÃO BLOCO MOTOR</p> <p>OPEL VECTRA C GTS (Z02) 1.6 (F68) (08.05 A 08.08) 100cv 1598cc Hatchback - OPEL VECTRA C Combi (Z02) 1.8 (F35) (08.05 A 08.08) 140cv 1796cc Combi</p> <p>d36x10mm di-32mm</p>
	<p>UMR26950 NO. 5738918 - 93176676</p> <p>REVESTIMENTO MANETE ALAVANCA VELOCIDADES</p> <p>OPEL VECTRA C GTS (Z02): 3.0 CDTi (F68) 08.2005/08.2008 135KW 184CV 2959CC - OPEL VECTRA C (Z02): 1.6 16V (F69) 06.2004/09.2008 74KW 100CV 1598CC - OPEL VECTRA C (Z02): 1.8 (F69) 08.2005/08.2008 103KW 140CV 1796CC - OPEL VECTRA C (Z02): 1.8 16V 04.2002/09.2008 90KW 122CV 1796CC - OPEL VECTRA C (Z02): 2.0 16V Turbo (F69) 03.2003/08.2008 129KW 175CV 1998CC - OPEL VECTRA C (Z02): 2.2 16V (F69) 04.200...</p> <p>43x31x43mm</p>		<p>UMV25415 NO. 24456028 - 738125</p> <p>MANETE ALAVANCA VELOCIDADES CROMADA (5 VELOCIDADES)</p> <p>OPEL VECTRA C GTS (Z02): 1.6 (F68) 08.2005/08.2008 74KW 100CV 1598CC - OPEL VECTRA C GTS (Z02): 1.6 (F68) 01.2006/08.2008 77KW 105CV 1598CC - OPEL VECTRA C GTS (Z02): 1.8 16V (F68) 08.2002/12.2006 81KW 110CV 1796CC - OPEL VECTRA C GTS (Z02): 1.8 16V (F68) 08.2002/09.2008 90KW 122CV 1796CC - OPEL VECTRA C GTS (Z02): 1.8 (F68) 08.2005/08.2008 103KW 140CV 1796CC - OPEL VECTRA C GTS (Z02): 2.0 16V Tur...</p> <p>d51x55mm 1f-d31mm</p>
	<p>UMV25434 NO. 5738946 - 93186142</p> <p>MANETE PUNHO TOPO ALAVANCA MUDANÇAS 6 VELOCIDADES F31MM</p> <p>OPEL VECTRA C (Z02) 1.6 (F69) 08.2005/08.2008 77KW 105CV 1598CC Z 16 XEP 0035AAD - OPEL VECTRA C (Z02) 1.6 16V (F69) 07.2004/10.2005 74KW 100CV 1598CC Z 16 XE 0035ABK 0035070 0035444 - OPEL VECTRA C (Z02) 1.8 (F69) 04.2002/07.2008 81KW 110CV 1796CC Z 18 XEL 0035ABM 0035076 0035446 0035ABZ - OPEL VECTRA C (Z02) 1.8 (F69) 08.2005/08.2008 103KW 140CV 1796CC Z 18 XER 0035AAG - OPEL VECTRA C (Z02) 1....</p> <p>d52x60mm 1f-d31mm</p>		<p>UMV25434 NO. 5738946 - 93186142</p> <p>MANETE PUNHO TOPO ALAVANCA MUDANÇAS 6 VELOCIDADES F31MM</p> <p>OPEL VECTRA C (Z02) 1.6 (F68) 08.2005/08.2008 74KW 100CV 1598CC Z 16 XE 0035071 0035454 0035ABX - OPEL VECTRA C GTS (Z02) 1.6 (F68) 01.2006/08.2008 77KW 105CV 1598CC Z 16 XEP 0035AAE - OPEL VECTRA C GTS (Z02) 1.8 (F68) 08.2005/08.2008 103KW 140CV 1796CC Z 18 XER 0035AAF - OPEL VECTRA C GTS (Z02) 1.8 16V (F68) 08.2002/12.2006 81KW 110CV 1796CC Z 18 XEL 0035077 0035456 - OPEL VECTRA C GTS (Z02) ...</p> <p>d52x60mm 1f-d31mm</p>
	<p>UMV25443 NO. 55557637</p> <p>MANETE PUNHO TOPO ALAVANCA MUDANÇAS 5 VELOCIDADES F13MM</p> <p>OPEL VECTRA C (Z02) 1.6 (F69) 08.2005/08.2008 77KW 105CV 1598CC Z 16 XEP 0035AAD - OPEL VECTRA C (Z02) 1.6 16V (F69) 04.2002/10.2005 74KW 100CV 1598CC Z 16 XE 0035ABK 0035070 0035444 - OPEL VECTRA C (Z02) 1.8 (F69) 04.2002/07.2008 81KW 110CV 1796CC Z 18 XEL 0035ABM 0035076 0035446 0035ABZ - OPEL VECTRA C (Z02) 1.8 (F69) 08.2005/08.2008 103KW 140CV 1796CC Z 18 XER 0035AAG - OPEL VECTRA C (Z02) 1....</p> <p>52x54x53mm 1f-d13mm</p>		<p>UMV25444 NO. 55557637</p> <p>MANETE PUNHO TOPO ALAVANCA MUDANÇAS 6 VELOCIDADES F13MM</p> <p>OPEL VECTRA C (Z02) 1.6 (F69) 08.2005/08.2008 77KW 105CV 1598CC Z 16 XEP 0035AAD - OPEL VECTRA C (Z02) 1.6 16V (F69) 04.2002/10.2005 74KW 100CV 1598CC Z 16 XE 0035ABK 0035070 0035444 - OPEL VECTRA C (Z02) 1.8 (F69) 04.2002/07.2008 81KW 110CV 1796CC Z 18 XEL 0035ABM 0035076 0035446 0035ABZ - OPEL VECTRA C (Z02) 1.8 (F69) 08.2005/08.2008 103KW 140CV 1796CC Z 18 XER 0035AAG - OPEL VECTRA C (Z02) 1.8 ...</p> <p>52x54x53mm 1f-d13mm</p>
	<p>UMV26809 NO. 5738737 - 90540619 - 9200972</p> <p>MANETE PUNHO TOPO ALAVANCA MUDANÇAS 5 VELOCIDADES F32MM</p> <p>OPEL VECTRA C Combi (Z02): 1.8 (F35) 10.2003/09.2006 90KW 122CV 1796CC</p> <p>d50x51mm 1f-d32mm</p>		<p>UTR0817 NO. 21430-AX300 - 21430-AX600 - 21430AX30A - 4408066 - 7700805131 - 8200048024 - 91166192</p> <p>TAMPÃO RESERVATÓRIO LIQUIDO REFRIGERAÇÃO</p> <p>OPEL VECTRA C Combi 1.8 (A Partir de 01.06) 140cv 1796cc Combi - OPEL VECTRA C Combi 1.9 CDTI (A Partir de 10.05) 100cv 1910cc Combi</p> <p>53x36mm 1f-d46x18mm</p>
	<p>UTR0821 NO. 1304677 - 9202799</p> <p>TAMPÃO RESERVATÓRIO LIQUIDO REFRIGERAÇÃO</p> <p>OPEL VECTRA C GTS 1.6 (A Partir de 08.05) 100cv 1598cc Hatchback - OPEL VECTRA C GTS 1.6 (A Partir de 01.06) 105 1598cc Hatchback - OPEL VECTRA C GTS 1.8 16 V (08.02 A 12.06) 110cv 1796cc Hatchback - OPEL VECTRA C GTS 1.8 16 V (A Partir de 08.02) 122cv 1796cc Hatchback - OPEL VECTRA C GTS 1.8 (A Partir de 01.06) 140cv 1796cc Hatchback - OPEL VECTRA C GTS 2.0 16 V Turbo (A Partir de 03.03...)</p> <p>61x35mm 1f-d52x15mm</p>		<p>UTR1300 NO. 00650090 - 05650831</p> <p>TAMPÃO RESERVATÓRIO DO OLEO</p> <p>OPEL VECTRA C GTS (Z02) 1.8 (F68) (De 08-2005 Até 08-2008) 103kW 140CV 1796cc Hatchback OPEL VECTRA C GTS (Z02) 3.2 V6 (F68) (De 08-2002 Até 07-2006) 155kW 211CV 3175cc Hatchback OPEL VECTRA C GTS (Z02) 3.0 CDTI (F68) (De 06-2003 Até 07-2005) 130kW 177CV 2958cc Hatchback OPEL VECTRA C GTS (Z02) 3.0 CDTI (F68) (De 08-2005 Até 08-2008) 135kW 184CV 2959cc Hatchback OPEL VECTRA C (Z02) 1.8 (F68) 08.2005/08.2008 77KW 105CV 1598CC</p> <p>65x34mm d45x12mm</p>
	<p>UTR1305 NO. 0650089 - 650089</p> <p>TAMPÃO DO RESERVATÓRIO ÓLEO</p> <p>OPEL VECTRA C (Z02) 1.6 (F69) (08.2005 -08.2008) 77kw 105cv 1598cm3 três volumes OPEL VECTRA C (Z02) 1.6 16V (F69) (04.2002 -10.2005) 74kw 100cv 1598cm3 três volumes OPEL VECTRA C (Z02) 1.8 (F69) (04.2002 -07.2008) 81kw 110cv 1796cm3 três volumes OPEL VECTRA C (Z02) 1.8 (F69) (08.2005 -08.2008) 103kw 140cv 1796cm3 três volumes OPEL VECTRA C (Z02) 1.8 16V (04.2002 -09.2008) 90kw 122cv 1796cm3 três ...</p> <p>d61x23mm d32x19mm</p>		<p>UTR1305 NO. 0650089 - 650089</p> <p>TAMPÃO DO RESERVATÓRIO ÓLEO</p> <p>OPEL VECTRA C Combi (Z02) 1.8 (F35) (10.2003 -09.2006) 90kw 122cv 1796cm3 Combi OPEL VECTRA C Combi (Z02) 1.8 (F35) (08.2005 -08.2008) 103kw 140cv 1796cm3 Combi OPEL VECTRA C Combi (Z02) 1.9 CDTI (F35) (06.2005 -08.2008) 74kw 100cv 1910cm3 Combi OPEL VECTRA C Combi (Z02) 1.9 CDTI (F35) (04.2004 -01.2009) 88kw 120cv 1910cm3 Combi OPEL VECTRA C Combi (Z02) 1.9 CDTI (F35) (04.2004 -08.2008) 110kw 150...</p> <p>d61x23mm d32x19mm</p>
	<p>UTR1305 NO. 0650089 - 650089</p> <p>TAMPÃO DO RESERVATÓRIO ÓLEO</p> <p>OPEL VECTRA C GTS (Z02) 1.6 (F68) (08.2005 -08.2008) 74kw 100cv 1598cm3 Hatchback OPEL VECTRA C GTS (Z02) 1.6 (F68) (01.2006 -08.2008) 77kw 105cv 1598cm3 Hatchback OPEL VECTRA C GTS (Z02) 1.8 (F68) (08.2005 -08.2008) 103kw 140cv 1796cm3 Hatchback OPEL VECTRA C GTS (Z02) 1.8 16V (F68) (08.2002 -09.2008) 90kw 122cv 1796cm3 Hatchback OPEL VECTRA C GTS (Z02) 1.9 CDTI (F68) (06.2005 -08.2008) 74kw 100c...</p> <p>d61x23mm d32x19mm</p>		<p>UTV83019 NO. 0652315 - 0652477 - 652315 - 652477 - 90502556 - 96023264</p> <p>TAMPÃO VEDAÇÃO BUJÃO</p> <p>OPEL VECTRA C GTS (Z02) 1.6 (F68) (De 08-2005 Até 08-2008) 74KW 100CV 1598cc Hatchback OPEL VECTRA C GTS (Z02) 1.6 (F68) (De 01-2006 Até 08-2008) 77KW 105CV 1598cc Hatchback OPEL VECTRA C GTS (Z02) 1.8 16V (F68) (De 08-2002 Até 12-2006) 81KW 110CV 1796cc Hatchback OPEL VECTRA C GTS (Z02) 1.8 16V (F68) (De 08-2002 Até 09-2008) 90KW 122CV 1796cc Hatchback OPEL VECTRA C GTS (Z02) 1.8 (F68) (De 08...</p> <p>d25x14mm c9mm d13mm</p>

	W5051	NO. 0614411 - 09128177 - 09544461 - 55351711 - 5535171169 - 5614415 - 5614437 - 614411 - 614444 - 9...		W5107	NO. 5614425 - 5614431 - 9129209
	POLIE DA CAMBOTA (6 PISTAS) OPEL VECTRA C (Z02) 2.0 DTI 16V (F69) 04.2002/08.2006 74KW 101CV 1995CC Y 20 DTH 0035072 0035073 0035453 - OPEL VECTRA C (Z02) 2.2 DTI 16V (F69) 04.2002/12.2004 86KW 117CV 2172CC Y 22 DTR 0035448 - OPEL VECTRA C (Z02) 2.2 DTI 16V (F69) 04.2002/07.2004 92KW 125CV 2172CC Y 22 DTR 0035078 0035447 - OPEL VECTRA C Combi (Z02) 2.0 DTI (F35) 10.2003/08.2005 74KW 100CV 1995CC Y 20 DTH 0035065 0035020 - OP...			POLIE DA CAMBOTA (5 PISTAS) OPEL VECTRA C 1.6 16V Z 16 XE 100CV (APÓS 06-2004) - 1.8 Z 18 XEL 110CV (APÓS 04-2002) - 1.8 Z 18 XER 140CV (APÓS 01-2006) - 1.8 16V Z 18 XE 122CV (APÓS 04-2002) - OPEL VECTRA C GTS 1.6 Z 16 XE 100CV (APÓS 08-2005) - 1.8 Z 18 XER 140CV (APÓS 01-2006) - 1.	
d153mm		d35mm	d160m 1f-d26mm		
	W5107	NO. 5614425 - 5614431 - 9129209		W5145	NO. 93178819 - 0614359 - 614359 - 93192547
	POLIE DA CAMBOTA (5 PISTAS) OPEL VECTRA C Station wagon 1.8 Z 18 XE 122CV (APÓS 10-2003) - 1.8 Z 18 XER 140CV (APÓS 01-2006)			POLIE DA CAMBOTA 6 PISTAS OPEL VECTRA C GTS 1.9 CDTI (APÓS 10.05) 100cv 1910cc Hatchback - OPEL VECTRA C GTS 1.9 CDTI (APÓS 04.04) 120cv 1910cc Hatchback - OPEL VECTRA C 1.9 CDTI (APÓS 10.05) 100cv 1910cc três volumes - OPEL VECTRA C 1.9 CDTI (APÓS 04.04) 120cv 1910cc três volumes - OPEL VECTRA C Combi 1.9 CDTI (APÓS 10.05) 100cv 1910cc Combi - OPEL VECTRA C Combi 1.9 CDTI (APÓS 04.04) 120cv 1910cc Combi	
d160m 1f-d26mm			d169mm		d30,5mm
	W5166	NO. 0614584 - 55564573 - 614584		Y3212	NO. 1008501 - 1008504 - 4709077
	POLIE DA CAMBOTA (6 PISTAS) OPEL VECTRA C (Z02) 1.9 CDTI (F69) 04.2004/08.2008 110KW 150CV 1910CC Z 19 DTH 0035ABT 0035092 0035025 - OPEL VECTRA C Combi (Z02) 1.9 CDTI (F35) 04.2004/08.2008 110KW 150CV 1910CC Z 19 DTH 0035069 0035022 0035ACP - OPEL VECTRA C GTS (Z02) 1.9 CDTI (F68) 04.2004/08.2008 110KW 150CV 1910CC Z 19 DTH 0035093 0035026 0035ACG			PARAFUSO PERNO RODA CHAVE 17 M12X1,50X48MM (BASE CONICA PARA JANTES AÇO E LIGA LEVE) OPEL VECTRA C (Z02) 1.6 (F68) (08.2005 - 08.2008) 77kw 105cv 1598cm3 três volumes OPEL VECTRA C (Z02) 1.6 16V (F69) (04.2002 - 10.2005) 74kw 100cv 1598 três volumes OPEL VECTRA C (Z02) 1.8 (F69) (04.2002 - 07.2008) 81kw 110cv 1796cm3 três volumes OPEL VECTRA C (Z02) 1.8 (F69) (08.2005 - 08.2008) 103kw 140cv 1796cm3 três volumes OPEL VECTRA C (Z02) 1.8 16V (04.2002 - 09.2008) 90kw 122cv 1796cm3 três...	
d165mm		d30mm	C48mm (Ch-17mm)		M12x1,50x22mm
	Y3212	NO. 1008501 - 1008504 - 4709077		Z55280	NO. 2228839
	PARAFUSO PERNO RODA CHAVE 17 M12X1,50X48MM (BASE CONICA PARA JANTES AÇO E LIGA LEVE) OPEL VECTRA C GTS (Z02) 1.6 (F68) (08.2005 - 08.2008) 74kw 100cv 1598cm3 Hatchback OPEL VECTRA C GTS (Z02) 1.6 (F68) (01.2006 - 08.2008) 77kw 105cv 1598cm3 Hatchback OPEL VECTRA C GTS (Z02) 1.8 (F68) (08.2005 - 08.2008) 103kw 140cv 1796cm3 Hatchback OPEL VECTRA C GTS (Z02) 1.8 16V (F68) (08.2002 - 12.2006) 81kw 110cv 1796cm3 Hatchback OPEL VECTRA C GTS (Z02) 1.8 16V (F68) (08.2002 - 09.2008) 90kw ...			MOLA PAINEL REVESTIMENTO DAS PORTAS OPEL VECTRA C (Z02) 1.6 (F69) 08.2005/08.2008 77KW 105CV 1598CC Z 16 XEP 0035AAD - OPEL VECTRA C (Z02) 1.6 16V (F69) 04.2002/10.2005 74KW 100CV 1598CC Z 16 XE 0035ABK 0035070 0035444 - OPEL VECTRA C (Z02) 1.8 (F69) 04.2002/07.2008 81KW 110CV 1796CC Z 18 XEL 0035ABM 0035076 0035446 0035ABZ - OPEL VECTRA C (Z02) 1.8 (F69) 08.2005/08.2008 103KW 140CV 1796CC Z 18 XER 0035AAG - OPEL VECTRA C (Z02) 1....	
C48mm (Ch-17mm)		M12x1,50x22mm	F-G-mm		T-27L-18H-12S-5mm
	Z55280	NO. 2228839		Z55280	NO. 2228839
	MOLA PAINEL REVESTIMENTO DAS PORTAS OPEL VECTRA C Combi (Z02) 1.6 (F35) 12.2005/08.2008 77KW 105CV 1598CC Z 16 XEP 0035AFJ 0035AAX - OPEL VECTRA C Combi (Z02) 1.8 (F35) 10.2003/09.2006 90KW 122CV 1796CC Z 18 XE 0035060 0035013 0035ACK - OPEL VECTRA C Combi (Z02) 1.8 (F35) 08.2005/08.2008 103KW 140CV 1796CC Z 18 XER 0035AAJ - OPEL VECTRA C Combi (Z02) 1.9 CDTI (F35) 04.2004/01.2009 88KW 120CV 1910CC Z 19 DT 0035068 0035021 0035ACN - ...			MOLA PAINEL REVESTIMENTO DAS PORTAS OPEL VECTRA C GTS (Z02) 1.6 (F68) 08.2005/08.2008 74KW 100CV 1598CC Z 16 XE 0035071 0035454 0035ABX - OPEL VECTRA C GTS (Z02) 1.6 (F68) 01.2006/08.2008 77KW 105CV 1598CC Z 16 XEP 0035AAE - OPEL VECTRA C GTS (Z02) 1.8 (F68) 08.2005/08.2008 103KW 140CV 1796CC Z 18 XER 0035AAF - OPEL VECTRA C GTS (Z02) 1.8 16V (F68) 08.2002/12.2006 81KW 110CV 1796CC Z 18 XEL 0035077 0035456 - OPEL VECTRA C GTS (Z02) ...	
F-G-mm		T-27L-18H-12S-5mm	F-G-mm		T-27L-18H-12S-5mm
	Z80846	NO. 1104881 - 1104882 - 90450482			
	Rebite OPEL VECTRA C				
d19x29mm		1p-d8-15.2mm			





OPHEL VIVARO

	A2218	NO. 1f-d13mm 1f-18x12mm 1f-16x11mm 1f-		A2583	NO. 4418051 - 93853290
	APOIO DO MOTOR LADO DIREITO OPEL VIVARO A Autocarro (X83) 1.9 DTI (F7, J7, A07) 08.2001/07.2014 74KW 101CV 1870CC F9Q 760 0035AGG 0035AGH 0035512 0035513 0035429 0035430 - OPEL VIVARO A Autocarro (X83) 2.0 16V (F7, J7, A07) 08.2001/07.2006 88KW 120CV 1998CC F4R 720 0035508 0035509 0035440 0035441 - OPEL VIVARO A Autocarro (X83) 2.0 CDTI (F7, J7, A07) 08.2006/07.2014 66KW 90CV 1995CC M9R 786 M9R 782 M9R 780 M9R 692 M9R 630 00...			APOIO DO MOTOR PARTE DA FRENTE LADO DIREITO OPEL VIVARO A Autocarro (X83) 2.0 CDTI (F7, J7, A07) 08.2006/07.2014 66KW 90CV 1995CC M9R 786 M9R 780 M9R 692 M9R 630 0035AQC 0035AQQ - OPEL VIVARO A Autocarro (X83) 2.0 CDTI (F7, J7, A07) 08.2006/07.2014 84KW 114CV 1995CC M9R 786 M9R 630 M9R 788 M9R 784 M9R 780 M9R 692 0035AGE 0035AQP - OPEL VIVARO A Autocarro (X83) 2.5 CDTI (F7, J7, A07) 08.2006/03.2010 84KW 114CV 2464CC G9U 630 0035AIE ...	
188x126x109mm		1f-d13mm 1f-18x12mm 1f-16x11mm 1f-14	180x131x123mm		1f-13x18m 2f-10x16mm 1p-d10x33mm

	<p>BE22 NO. 4401363 - 4501620 - 860151</p> <p>ABRAÇADEIRA ESCAPE</p> <p>OPEL VIVARO</p> <p>96x100x18mm 1p-d10-75mm</p>		<p>E0602-M NO. 4416894 - 820040271 - 93853920 - 6000617697 - 11356-00Q0A - 093853920</p> <p>ESTICADOR SUPORTE APOIO MOTOR FRENTE</p> <p>OPEL VIVARO A Autocarro (X83) 2.0 CDTI (F7, J7, A07) 08.2006/07.2014 66kW 90CV 1995CC M9R 786 M9R 782 M9R 780 M9R 692 M9R 630 0035AGC 0035AQO - OPEL VIVARO A Autocarro (X83) 2.0 CDTI (F7, J7, A07) 08.2006/07.2014 84kW 114CV 1995CC M9R 786 M9R 630 M9R 788 M9R 784 M9R 780 M9R 692 0035AGE 0035AQP - OPEL VIVARO A Caixa (X83) 2.0 CDTI (F7) 08.2006/07.2014 66kW 90CV 1995CC M9R 786 M9R 630 M9R 782 M9R 78...</p> <p>180x54x84mm 1f-d11mm 1f-12x16mm</p>
	<p>E0626-M NO. 4408761 - 91166684 - 1123800QAA</p> <p>ESTICADOR SUPORTE APOIO MOTOR TRAS</p> <p>OPEL VIVARO A Autocarro (X83) 1.9 DI (F7, J7, A07) 08.2001/07.2006 60KW 80CV 1870CC F9Q 762 0035510 0035511 0035431 0035432 - OPEL VIVARO A Autocarro (X83) 1.9 DTI (F7, J7, A07) 08.2001/07.2014 74KW 101CV 1870CC F9Q 760 0035AGG 0035AGH 0035512 0035513 0035429 0035430 - OPEL VIVARO A Autocarro (X83) 2.0 16V (F7, J7, A07) 08.2001/07.2006 88KW 120CV 1998CC F4R 720 0035508 0035509 0035440 0035441 - OP...</p> <p>190x95x53mm 1f-d13mm 1f-d14mm</p>		<p>E1117 NO. 4410148 - 4422016 - 91166194 - 93865793</p> <p>ESTICADOR DO ESCAPE</p> <p>OPEL VIVARO Combi (J7) 2.0 ECOTEC (A Partir de 08.06) 117cv 1998cc Autocarro - OPEL VIVARO Combi (J7) 2.0 16V (A Partir de 08.01) 120cv 1998cc Autocarro - OPEL VIVARO Combi (J7) 1.9 DI (A Partir de 08.01) 80cv 1870cc Autocarro - OPEL VIVARO Combi (J7) 1.9 DTI (A Partir de 08.01) 101cv 1870cc Autocarro - OPEL VIVARO Combi (J7) 2.5 DTI (A Partir de 05.03) 135cv 2463cc Autocarro - OPEL VIVA...</p> <p>68x40x38mm 2f-d12mm</p>
	<p>F1701K3I NO. 4501297</p> <p>FOLE DA TRANSMISSÃO JUNTO À CAIXA</p> <p>OPEL VIVARO 1.9 Di - 1.9 DTi - 2.0i 16v - 2.5 DTi (APÓS 2001)</p> <p>d85x200mm 1f-d75mm 1f-d25mm</p>		<p>F4256 NO. 333513425</p> <p>FOLE CAPA PROTEÇÃO AMORTECEDOR TRÁS (GASTA 2 UNIDADES)</p> <p>OPEL VIVARO A Autocarro (X83) 1.9 DI (F7, J7, A07) (De 08.2001 Até 07.2006) 60kW 80cv 1870cm3 Autocarro - OPEL VIVARO A Autocarro (X83) 1.9 DTI (F7, J7, A07) (De 08.2001 Até 07.2014) 74kW 101cv 1870cm3 Autocarro - OPEL VIVARO A Caixa (X83) 1.9 DI (F7) (De 08.2001 Até 07.2006) 60kW 80cv 1870cm3 Caixa - OPEL VIVARO A Caixa (X83) 1.9 DTI (F7) (De 08.2001 Até 07.2014) 74kW 101cv 1870cm3 Caixa - OPEL V...</p> <p>d71x175mm 1f-d47mm 1f-d61mm</p>
	<p>F4319 NO. 4412968</p> <p>FOLE ALAVANCA VELOCIDADES C/ ARO CROMADO</p> <p>OPEL VIVARO A Autocarro (X83) 1.9 DI (F7, J7, A07) 08.2001/07.2006 60KW 80CV 1870CC F9Q 762 0035510 0035511 0035431 0035432 - OPEL VIVARO A Autocarro (X83) 1.9 DTI (F7, J7, A07) 08.2001/07.2014 74KW 101CV 1870CC F9Q 760 0035AGG 0035AGH 0035512 0035513 0035429 0035430 - OPEL VIVARO A Autocarro (X83) 2.0 16V (F7, J7, A07) 08.2001/07.2006 88KW 120CV 1998CC F4R 720 0035508 0035509 0035440 0035441 - OP...</p> <p>204x133x147mm 1f-100x107mm</p>		<p>KF2362-T NO. 1603232 - 1603278 - 1603281 - 1603284 - 93182574</p> <p>KIT DE FOLE DO CARDAN JUNTO À RODA</p> <p>OPEL VIVARO (APÓS 2001) 1.9 Di - 1.9DTI - 2.0i 16V - 2.5DTi</p> <p>d104x130mm 1f-d91mm 1f-d27mm</p>
	<p>Q2013 NO. 173633 - 4411730 - 4418063 - 4433515</p> <p>UNIÃO DO ESCAPE 60x64,5x90mm</p> <p>OPEL VIVARO</p> <p>90x70x92mm 1f-d60mm</p>		<p>R220578 NO. 04413497 - 04414223 - 091167045 - 091167779 - 093851706 - 1446300QAH - 1446300QAM - 4413497 - 441422...</p> <p>TUBO DO AR SOBREALIMENTAÇÃO</p> <p>OPEL VIVARO A Autocarro (X83) 1.9 DI (F7, J7, A07) 08.2001/07.2006 60KW 80CV 1870CC F9Q 762 0035510 0035511 0035431 0035432 - OPEL VIVARO A Autocarro (X83) 1.9 DTI (F7, J7, A07) 08.2001/07.2014 74KW 101CV 1870CC F9Q 760 0035AGG 0035AGH 0035512 0035513 0035429 0035430 - OPEL VIVARO A Autocarro (X83) 2.0 CDTI (F7, J7, A07) 08.2006/07.2014 66kW 90CV 1995CC M9R 786 M9R 782 M9R 780 M9R 692 M9R 630 0035...</p> <p>B510-d47/d52mm mm</p>
	<p>R223378 NO. 4414705</p> <p>TUBO INFERIOR DO RADIADOR</p> <p>OPEL VIVARO A Autocarro (X83) 1.9 DI (F7, J7, A07) 08.2001/07.2006 60KW 80CV 1870CC F9Q 762 0035510 0035511 0035431 0035432 - OPEL VIVARO A Autocarro (X83) 1.9 DTI (F7, J7, A07) 08.2001/07.2014 74KW 101CV 1870CC F9Q 760 0035AGG 0035AGH 0035512 0035513 0035429 0035430 - OPEL VIVARO A Caixa (X83) 1.9 DI (F7) 08.2001/07.2006 60KW 80CV 1870CC F9Q 762 0035AFF 0039135 0035001 - OPEL VIVARO A Caixa (X83)...</p> <p>B610-d28/d29mm mm</p>		<p>R225632 NO. 4418876 - 4419135 - 4421903 - 4422279 - 44416867 - 93455390</p> <p>TUBO DO AR SOBREALIMENTAÇÃO</p> <p>OPEL VIVARO A Autocarro (X83) 2.0 CDTI (F7, J7, A07) (De 08.2006 Até 07.2014) 66kW 90cv 1995cm3 Autocarro - OPEL VIVARO A Autocarro (X83) 2.0 CDTI (F7, J7, A07) (De 08.2006 Até 07.2014) 84kW 114cv 1995cm3 Autocarro - OPEL VIVARO A Caixa (X83) 2.0 CDTI (F7) (De 08.2006 Até 07.2014) 66kW 90cv 1995cm3 Caixa - OPEL VIVARO A Caixa (X83) 2.0 CDTI (F7) (De 08.2006 Até 07.2014) 84kW 114cv 1995cm3 Caixa - ...</p> <p>B200-34/38mm 125x82mm</p>
	<p>R8233 NO. 4404011 - 4416866</p> <p>TUBO DO AR SOBREALIMENTAÇÃO</p> <p>OPEL VIVARO A Autocarro (X83) 2.0 CDTI (F7, J7, A07) (08.2006 - 07.2014) 66kw 90cv 1995cm3 Autocarro OPEL VIVARO A Autocarro (X83) 2.0 CDTI (F7, J7, A07) (08.2006 - 07.2014) 84kw 114cv 1995cm3 Autocarro</p> <p>B270-50/55mm 57-140-143-115-83-114mm</p>		<p>R8233 NO. 4404011 - 4416866</p> <p>TUBO DO AR SOBREALIMENTAÇÃO</p> <p>OPEL VIVARO A Caixa (X83) 2.0 CDTI (F7) (08.2006 - 07.2014) 66kw 90cv 1995cm3 Caixa OPEL VIVARO A Caixa (X83) 2.0 CDTI (F7) (08.2006 - 07.2014) 84kw 114cv 1995cm3 Caixa</p> <p>B270-50/55mm 57-140-143-115-83-114mm</p>
	<p>R8233 NO. 4404011 - 4416866</p> <p>TUBO DO AR SOBREALIMENTAÇÃO</p> <p>OPEL VIVARO A Camião de plataforma/chassis (X83) 2.0 CDTI (01.2006 - 07.2014) 66kw 90cv 1995cm3 Camião de plataforma/chassis OPEL VIVARO A Camião de plataforma/chassis (X83) 2.0 CDTI (08.2006 - 07.2014) 84kw 114cv 1995cm3 Camião de plataforma/chassis</p> <p>B270-50/55mm 57-140-143-115-83-114mm</p>		<p>RT80200 NO. 4416297 - 93859698</p> <p>TUBO DE TRAVÃO FRENTE LH-RH</p> <p>OPEL VIVARO A Autocarro (X83) 1.9 DI (F7, J7, A07) 08.2001/07.2006 60KW 80CV 1870CC F9Q 762 0035510 0035511 0035431 0035432 - OPEL VIVARO A Autocarro (X83) 1.9 DTI (F7, J7, A07) 08.2001/07.2014 74KW 101CV 1870CC F9Q 760 0035AGG 0035AGH 0035512 0035513 0035429 0035430 - OPEL VIVARO A Autocarro (X83) 2.0 16V (F7, J7, A07) 08.2001/07.2006 88KW 120CV 1998CC F4R 720 0035508 0035509 0035440 0035441 - OP...</p> <p>415mm FZ - MC11</p>

	<p>RT80201 NO. 4409165</p> <p>TUBO DE TRAVÃO TRÁS LH-RH</p> <p>OPEL VIVARO A Autocarro (X83) 1.9 DI (F7, J7, A07) 08.2001/07.2006 60KW 80CV 1870CC F9Q 762 0035510 0035511 0035431 0035432 - OPEL VIVARO A Autocarro (X83) 1.9 DTI (F7, J7, A07) 08.2001/07.2014 74KW 101CV 1870CC F9Q 760 0035AGG 0035AGH 0035512 0035513 0035429 0035430 - OPEL VIVARO A Autocarro (X83) 2.0 16V (F7, J7, A07) 08.2001/07.2006 88KW 120CV 1998CC F4R 720 0035508 0035509 0035440 0035441 - OP...</p> <p>230mm FZ - FZ</p>		<p>RT80252 NO. 4412727</p> <p>TUBO DE TRAVÃO TRÁS LH-RH</p> <p>OPEL VIVARO A Autocarro (X83) 1.9 DI (F7, J7, A07) 08.2001/07.2006 60KW 80CV 1870CC F9Q 762 0035510 0035511 0035431 0035432 - OPEL VIVARO A Autocarro (X83) 1.9 DTI (F7, J7, A07) 08.2001/07.2014 74KW 101CV 1870CC F9Q 760 0035AGG 0035AGH 0035512 0035513 0035429 0035430 - OPEL VIVARO A Autocarro (X83) 2.0 16V (F7, J7, A07) 08.2001/07.2006 88KW 120CV 1998CC F4R 720 0035508 0035509 0035440 0035441 - OP...</p> <p>250mm FZ - MC11</p>
	<p>S1636 NO. 8200002869</p> <p>SILENT-BLOC DO BRAÇO SUSPENSÃO DA FRENTE</p> <p>OPEL VIVARO A Combi (X83) 2.0 ECOTEC (F7 - A07 - J7) (De 08-2006 Até ...) 86kW 117CV 1998cc Autocarro OPEL VIVARO A Combi (X83) 2.0 16V (F7 - J7 - A07) (De 08-2001 Até ...) 88kW 120CV 1998cc Autocarro OPEL VIVARO A Combi (X83) 1.9 DTI (F7 - J7 - A07) (De 08-2001 Até ...) 74kW 101CV 1870cc Autocarro OPEL VIVARO A Combi (X83) 2.0 CDTI (F7 - J7 - A07) (De 08-2006 Até ...) 86kW 90CV 1995cc Autoc...</p> <p>d58x53mm c30mm 1f-d15mm</p>		<p>S1655 NO. 4408065 - 4417149 - 4418113 - 91166633 - 93459571 - 93854457 - 93858866</p> <p>SILENT-BLOC DO BRAÇO SUSPENSÃO DA FRENTE</p> <p>OPEL VIVARO A Autocarro (X83): 2.0 ECOTEC (F7, A07, J7) 08.2006/>>>> 86KW 117CV 1998CC - OPEL VIVARO A Autocarro (X83): 2.0 16V (F7, J7, A07) 08.2001/>>>> 88KW 120CV 1998CC - OPEL VIVARO A Autocarro (X83): 1.9 DI (F7, J7, A07) 08.2001/>>>> 60KW 80CV 1870CC - OPEL VIVARO A Autocarro (X83): 1.9 DTI (F7, J7, A07) 08.2001/>>>> 74KW 101CV 1870CC - OPEL VIVARO A Autocarro (X83): 2.0 16V (F7, J7, A07) 08.2001/>>>> 88KW 120CV 1998CC - OPEL VIVARO A Autocarro (X83): 2.0 CDTI (F7, J7, A07) 08.2006/...</p> <p>d70x80mm c59mm d52mm 1f-d17mm</p>
	<p>S2124 NO. 55466-00Q0A - 5546600QAA</p> <p>SILENT-BLOC DO EIXO SUSPENSÃO TRÁS</p> <p>OPEL VIVARO A Autocarro (X83) 1.9 DI (F7, J7, A07) (08.2001 - 07.2006) 60kw 80cv 1870cm3 Autocarro OPEL VIVARO A Autocarro (X83) 1.9 DI (F7, J7, A07) (08.2001 - 07.2006) 60kw 80cv 1870cm3 Autocarro OPEL VIVARO A Autocarro (X83) 1.9 DTI (F7, J7, A07) (08.2001 - 07.2014) 74kw 101cv 1870cm3 Autocarro OPEL VIVARO A Autocarro (X83) 1.9 DTI (F7, J7, A07) (08.2001 - 07.2014) 74kw 101cv 1870cm3 Autocarro ...</p> <p>d70x70mm c45mm-1f-d12mm</p>		<p>S2124 NO. 55466-00Q0A - 5546600QAA</p> <p>SILENT-BLOC DO EIXO SUSPENSÃO TRÁS</p> <p>OPEL VIVARO A Caixa (X83) 1.9 DI (F7) (08.2001 - 07.2006) 60kw 80cv 1870cm3 Caixa OPEL VIVARO A Caixa (X83) 1.9 DI (F7) (08.2001 - 07.2006) 60kw 80cv 1870cm3 Caixa OPEL VIVARO A Caixa (X83) 1.9 DTI (F7) (08.2001 - 07.2014) 74kw 101cv 1870cm3 Caixa OPEL VIVARO A Caixa (X83) 1.9 DTI (F7) (08.2001 - 07.2014) 74kw 101cv 1870cm3 Caixa OPEL VIVARO A Caixa (X83) 2.0 16V (F7) (08.2001 - 07.2006) 88kw 120cv...</p> <p>d70x70mm c45mm-1f-d12mm</p>
	<p>S2124 NO. 55466-00Q0A - 5546600QAA</p> <p>SILENT-BLOC DO EIXO SUSPENSÃO TRÁS</p> <p>OPEL VIVARO A Camião de plataforma/chassis (X83) 1.9 DTI (02.2001 - 12.2010) 74kw 101cv 1870cm3 Camião de plataforma/chassis OPEL VIVARO A Camião de plataforma/chassis (X83) 1.9 DTI (02.2001 - 12.2010) 74kw 101cv 1870cm3 Camião de plataforma/chassis OPEL VIVARO A Camião de plataforma/chassis (X83) 1.9 DI (08.2001 - 07.2014) 60kw 82cv 1870cm3 Camião de plataforma/chassis OPEL VIVARO A Camião de pla...</p> <p>d70x70mm c45mm-1f-d12mm</p>		<p>T1167 NO. 4408905 - 4417971 - 4418991 - 4419790 - 5461100QA4E - 8200048177 - 8200273459 - 8200629180 - 8200629...</p> <p>BATENTE DA BARRA ESTABILIZADORA DA FRENTE</p> <p>OPEL VIVARO A Combi (X83) 2.0 ECOTEC (F7 - A07 - J7) (De 08-2006 Até ...) 86kW 117CV 1998cc Autocarro OPEL VIVARO A Combi (X83) 2.0 16V (F7 - J7 - A07) (De 08-2001 Até ...) 88kW 120CV 1998cc Autocarro OPEL VIVARO A Combi (X83) 1.9 DI (F7 - J7 - A07) (De 08-2001 Até ...) 74kW 101CV 1870cc Autocarro OPEL VIVARO A Combi (X83) 1.9 DTI (F7 - J7 - A07) (De 08-2001 Até ...) 74kW 101CV 1870cc Autocarro...</p> <p>46x57mm 1f-22mm</p>
	<p>UAP81637 NO. 09110702 - 4402702 - 9110702</p> <p>ANILHA PROTEÇÃO TÉRMICA INJECTORES</p> <p>OPEL VIVARO A Camião de plataforma/chassis (X83) 2.0 CDTI (De 2006.08 -) 84kW 114cv 1995cm3 Camião de plataforma/chassis -</p> <p>d15x3mm 1f-d7mm</p>		<p>UAP81637 NO. 09110702 - 4402702 - 9110702</p> <p>ANILHA PROTEÇÃO TÉRMICA INJECTORES</p> <p>OPEL VIVARO B Combi (X82) 1.6 CDTI (06) (De 2014.06 -) 66kW 90cv 1598cm3 Autocarro - OPEL VIVARO B Combi (X82) 1.6 CDTI (06) (De 2015.04 -) 70kW 95cv 1598cm3 Autocarro - OPEL VIVARO B Combi (X82) 1.6 CDTI (06) (De 2014.06 -) 85kW 116cv 1598cm3 Autocarro - OPEL VIVARO B Combi (X82) 1.6 CDTI (06) (De 2014.06 -) 88kW 120cv 1598cm3 Autocarro - OPEL VIVARO B Combi (X82) 1.6 CDTI (06) (De 2014.06 -) 88kW 120cv 1598cm3 Autocarro - OPEL VIVARO B Combi (X82) 1.6 CDTI (06) (De 2014.06 -) 88kW 120cv 1598cm3 Autocarro -</p> <p>d15x2mm 1f-d7mm</p>
	<p>UAP81637 NO. 09110702 - 4402702 - 9110702</p> <p>ANILHA PROTEÇÃO TÉRMICA INJECTORES</p> <p>OPEL VIVARO A Combi (X83) 1.9 DI (F7, J7, A07) (De 2001.08 -) 60KW 80cv 1870cm3 Autocarro - OPEL VIVARO A Combi (X83) 1.9 DTI (F7, J7, A07) (De 2001.08 -) 74KW 101cv 1870cm3 Autocarro - OPEL VIVARO A Combi (X83) 2.0 CDTI (F7, J7, A07) (De 2006.08 -) 66kW 90cv 1995cm3 Autocarro - OPEL VIVARO A Combi (X83) 2.0 CDTI (F7, J7, A07) (De 2006.08 -) 84kW 114cv 1995cm3 Autocarro -</p> <p>Ø15x3mm 1f-d7mm</p>		<p>UAP83244 NO. 055565375 - 55565375</p> <p>ANILHA PROTEÇÃO TÉRMICA INJECTORES</p> <p>OPEL VIVARO A Combi (X83) 2.0 CDTI (F7 - J7 - A07) (De 08-2006 Até ...) 66kW 90CV 1995cc Autocarro OPEL VIVARO A Combi (X83) 2.0 CDTI (F7 - J7 - A07) (De 08-2006 Até ...) 84kW 114CV 1995cc Autocarro OPEL VIVARO A Caixa (X83) 2.0 CDTI (F7) (De 08-2006 Até ...) 66kW 90CV 1995cc Caixa OPEL VIVARO A Caixa (X83) 2.0 CDTI (F7) (De 08-2006 Até ...) 84kW 114CV 1995cc Caixa</p> <p>d15x2mm 1f-d7mm</p>
	<p>UMB80660 NO. 04410493 - 4410493</p> <p>TAMPÃO BLOCO MOTOR</p> <p>OPEL VIVARO A Combi (X83) 2.0 ECOTEC (F7 - A07 - J7) (De 08-2006 Até ...) 86kW 117CV 1998cc Autocarro OPEL VIVARO A Combi (X83) 2.0 16V (F7 - J7 - A07) (De 08-2001 Até ...) 88kW 120CV 1998cc Autocarro OPEL VIVARO A Caixa (X83) 2.0 ECOTEC (F7) (De 08-2006 Até ...) 86kW 117CV 1998cc Caixa OPEL VIVARO A Caixa (X83) 2.0 16V (F7) (De 08-2001 Até ...) 88kW 120CV 1998cc Caixa OPEL VIVARO A Camião...</p> <p>d-57,3x10mm di-52,7mm</p>		<p>UMB80661 NO. 4409161 - 4412302 - 91160211 - 93161003</p> <p>TAMPÃO BLOCO MOTOR</p> <p>OPEL VIVARO A Combi (X83) 2.0 ECOTEC (F7 - A07 - J7) (De 08-2006 Até ...) 86kW 117CV 1998cc Autocarro OPEL VIVARO A Combi (X83) 2.0 16V (F7 - J7 - A07) (De 08-2001 Até ...) 88kW 120CV 1998cc Autocarro OPEL VIVARO A Caixa (X83) 2.0 ECOTEC (F7) (De 08-2006 Até ...) 86kW 117CV 1998cc Caixa OPEL VIVARO A Caixa (X83) 2.0 16V (F7) (De 08-2001 Até ...) 88kW 120CV 1998cc Caixa OPEL VIVARO A Camião...</p> <p>d42x8mm di-38x7mm</p>
	<p>UMV25270 NO. 96738472XJ</p> <p>MANETE PUNHO TOPO ALAVANCA MUDANÇAS PSA 6 VELOCIDADES</p> <p>OPEL VIVARO C Autocarro (K0) 1.5 desde 03.2019 75KW 102CV 1499CC D 15 DT (DV5RUCD) 3003BAW - OPEL VIVARO C Autocarro (K0) 1.5 desde 03.2019 88KW 120CV 1499CC D 15 DTH (DV5RUC) 3003BAX - OPEL VIVARO C Autocarro (K0) 2.0 desde 03.2019 90KW 122CV 1997CC D 20 DTL (DW10FE) 3003BAY - OPEL VIVARO C Autocarro (K0) 2.0 desde 03.2019 110KW 150CV 1997CC D 20 DTH (DW10FD) 3003BAZ - OPEL VIVARO C Autocarro (K0)...</p> <p>50x54x45mm 1f-d12mm</p>		<p>UMV25270 NO. 96738472XJ</p> <p>MANETE PUNHO TOPO ALAVANCA MUDANÇAS PSA 6 VELOCIDADES</p> <p>OPEL VIVARO C Caixa (K0) 1.5 desde 03.2019 75KW 102CV 1499CC D 15 DT (DV5RUCD) 3003BAK - OPEL VIVARO C Caixa (K0) 1.5 desde 03.2019 88KW 120CV 1499CC D 15 DTH (DV5RUC) 3003BAL - OPEL VIVARO C Caixa (K0) 1.5 4x4 desde 03.2019 88KW 120CV 1499CC D 15 DTH (DV5RUC) - OPEL VIVARO C Caixa (K0) 2.0 desde 03.2019 90KW 122CV 1997CC D 20 DTL (DW10FE) 3003AWZ - OPEL VIVARO C Caixa (K0) 2.0 desde 03.2019 110KW...</p> <p>50x54x45mm 1f-d12mm</p>

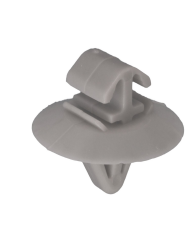
	<p>UMV25270 NO. 96738472XJ</p> <p>MANETE PUNHO TOPO ALAVANCA MUDANÇAS PSA 6 VELOCIDADES</p> <p>OPEL VIVARO C Platform Cabin (K0) 2.0 desde 03.2019 90KW 122CV 1997CC D 20 DTL (DW10FE) - OPEL VIVARO C Platform Cabin (K0) 2.0 desde 03.2019 110KW 150CV 1997CC D 20 DTH (DW10FD) - OPEL VIVARO C Platform Cabin (K0) 2.0 desde 04.2023 106KW 144CV 1997CC DW10FDDU340 - OPEL VIVARO C Platform Cabin (K0) VIVARO-E 09.2020/03.2024 100KW 136CV ZKX (ZK01)</p> <p>50x54x45mm 1f-d12mm</p>		<p>UMV25276 NO. 96738472VV</p> <p>MANETE PUNHO TOPO ALAVANCA MUDANÇAS PSA 6 VELOCIDADES</p> <p>OPEL VIVARO C Autocarro (K0) 1.5 desde 03.2019 75KW 102CV 1499CC D 15 DT (DV5RUCD) 3003BAW - OPEL VIVARO C Autocarro (K0) 1.5 desde 03.2019 88KW 120CV 1499CC D 15 DTH (DV5RUC) 3003BAX - OPEL VIVARO C Autocarro (K0) 2.0 desde 03.2019 90KW 122CV 1997CC D 20 DTL (DW10FE) 3003BAY - OPEL VIVARO C Autocarro (K0) 2.0 desde 03.2019 110KW 150CV 1997CC D 20 DTH (DW10FD) 3003BAZ - OPEL VIVARO C Autocarro (K0)...</p> <p>50x54x47mm 1f-d12mm</p>
	<p>UMV25276 NO. 96738472VV</p> <p>MANETE PUNHO TOPO ALAVANCA MUDANÇAS PSA 6 VELOCIDADES</p> <p>OPEL VIVARO C Caixa (K0) 1.5 desde 03.2019 75KW 102CV 1499CC D 15 DT (DV5RUCD) 3003BAK - OPEL VIVARO C Caixa (K0) 1.5 desde 03.2019 88KW 120CV 1499CC D 15 DTH (DV5RUC) 3003BAL - OPEL VIVARO C Caixa (K0) 1.5 4x4 desde 03.2019 88KW 120CV 1499CC D 15 DTH (DV5RUC) - OPEL VIVARO C Caixa (K0) 2.0 desde 03.2019 90KW 122CV 1997CC D 20 DTL (DW10FE) 3003AWZ - OPEL VIVARO C Caixa (K0) 2.0 desde 03.2019 110KW...</p> <p>50x54x47mm 1f-d12mm</p>		<p>UMV25613 NO. 4412968 - 4417064</p> <p>MANETE PUNHO TOPO ALAVANCA MUDANÇAS 6 VELOCIDADES F13MM</p> <p>OPEL VIVARO A Combi (X83): 2.0 ECOTEC (F7, A07, J7) 08.2006/>>> 86KW 117CV 1998CC - OPEL VIVARO A Combi (X83): 2.0 16V (F7, J7, A07) 08.2001/>>> 88KW 120CV 1998CC - OPEL VIVARO A Combi (X83): 1.9 DI (F7, J7, A07) 08.2001/ 60KW 80CV 1870CC - OPEL VIVARO A Combi (X83): 1.9 DTI (F7, J7, A07) 08.2001/ 74KW 101CV 1870CC - OPEL VIVARO A Combi (X83): 2.0 CDTI (F7, J7, A07) 08.2006/>>> 66KW 90CV 1995CC - ...</p> <p>d52x63mm 1f-d13mm</p>
	<p>UMV25614 NO. 4412968 - 4417064 - 820050644-4412968</p> <p>MANETE PUNHO TOPO ALAVANCA MUDANÇAS 6 VELOCIDADES F14MM</p> <p>OPEL VIVARO A Combi (X83): 2.0 ECOTEC (F7, A07, J7) 08.2006/>>> 86KW 117CV 1998CC - OPEL VIVARO A Combi (X83): 2.0 16V (F7, J7, A07) 08.2001/>>> 88KW 120CV 1998CC - OPEL VIVARO A Combi (X83): 1.9 DI (F7, J7, A07) 08.2001/ 60KW 80CV 1870CC - OPEL VIVARO A Combi (X83): 1.9 DTI (F7, J7, A07) 08.2001/ 74KW 101CV 1870CC - OPEL VIVARO A Combi (X83): 2.0 CDTI (F7, J7, A07) 08.2006/>>> 66KW 90CV 1995CC - ...</p> <p>d52x63mm 1f-d14mm</p>		<p>UTR0803 NO. 1H0121321A - 1H0121321B - 1H0121321C - 357121321 - 357121321A - 357121321C</p> <p>TAMPÃO RESERVATÓRIO LIQUIDO REFRIGERAÇÃO</p> <p>OPEL VIVARO Combi (J7) 2.0 CDTI (APÓS 08.06) 90cv 1995cc Autocarro - OPEL VIVARO Caixa (F7) 2.0 ECOTEC (APÓS 08.06) 117cv 1998cc Caixa - OPEL VIVARO Caixa (F7) 2.0 CDTI (APÓS 08.06) 90cv 1995cc Caixa - OPEL VIVARO Caixa (F7) 2.5 CDTI (APÓS 08.06) 146cv 2463cc Caixa</p> <p>d79x36mm d53x20mm</p>
	<p>UTR0817 NO. 21430-AX300 - 21430-AX600 - 21430AX30A - 4408066 - 7700805131 - 8200048024 - 91166192</p> <p>TAMPÃO RESERVATÓRIO LIQUIDO REFRIGERAÇÃO</p> <p>OPEL VIVARO Combi (J7) 2.0 16V (A Partir de 08.01) 120cv 1998cc Autocarro - OPEL VIVARO Combi (J7) 1.9 DI (A Partir de 08.01) 80cv 1870cc Autocarro - OPEL VIVARO Combi (J7) 1.9 DTI (A Partir de 08.01) 101cv 1870cc Autocarro - OPEL VIVARO Combi (J7) 2.5 DTI (A Partir de 05.03) 135cv 2463cc Autocarro - OPEL VIVARO Caixa (F7) 2.0 16V (A Partir de 08.01) 120cv 1998cc Caixa - OPEL VIVARO Caixa...</p> <p>53x36mm 1f-d46x18mm</p>		<p>UTR0839 NO. 1H0121321A - 1H0121321B - 1H0121321C - 357121321 - 357121321A - 357121321C</p> <p>TAMPÃO RESERVATÓRIO LIQUIDO REFRIGERAÇÃO</p> <p>OPEL VIVARO Combi (X83) 2.0 CDTI (A Partir de 08.06) 90cv 1995cc Autocarro - OPEL VIVARO Caixa (F7) 2.0 ECOTEC (A Partir de 08.06) 117cv 1998cc Caixa - OPEL VIVARO Caixa (F7) 2.0 CDTI (A Partir de 08.06) 90cv 1995cc Caixa - OPEL VIVARO Caixa (F7) 2.5 CDTI (A Partir de 08.06) 146cv 2463cc Caixa</p> <p>d80x38mm d58x20mm</p>
	<p>UTR1305 NO. 0650089 - 650089</p> <p>TAMPÃO DO RESERVATÓRIO ÓLEO</p> <p>OPEL VIVARO A Autocarro (X83) 1.9 DI (F7, J7, A07) (08.2001 -07.2006) 60kw 80cv 1870cm3 Autocarro OPEL VIVARO A Autocarro (X83) 1.9 DTI (F7, J7, A07) (08.2001 -07.2014) 74kw 101cv 1870cm3 Autocarro OPEL VIVARO A Autocarro (X83) 2.0 16V (F7, J7, A07) (08.2001 -07.2006) 88kw 120cv 1998cm3 Autocarro OPEL VIVARO A Autocarro (X83) 2.5 DTI (F7, J7, A07) (04.2003 -03.2010) 99kw 135cv 2463cm3 Autocarro</p> <p>d61x23mm d32x19mm</p>		<p>UTR1305 NO. 0650089 - 650089</p> <p>TAMPÃO DO RESERVATÓRIO ÓLEO</p> <p>OPEL VIVARO A Caixa (X83) 1.9 DI (F7) (08.2001 -07.2006) 60kw 80cv 1870cm3 Caixa OPEL VIVARO A Caixa (X83) 1.9 DTI (F7) (08.2001 -07.2014) 74kw 101cv 1870cm3 Caixa OPEL VIVARO A Caixa (X83) 2.0 16V (F7) (08.2001 -07.2006) 88kw 120cv 1998cm3 Caixa OPEL VIVARO A Caixa (X83) 2.5 DTI (F7) (04.2003 -03.2010) 99kw 135cv 2463cm3 Caixa</p> <p>d61x23mm d32x19mm</p>
	<p>UTR1403 NO. 7701470950 - 7701471585</p> <p>TAMPÃO DEPÓSITO COMBUSTIVEL</p> <p>OPEL VIVARO A Autocarro (X83) 1.9 DI (F7, J7, A07) 08.2001/07.2006 60KW 80CV 1870CC F9Q 762 0035510 0035511 0035431 0035432 - OPEL VIVARO A Autocarro (X83) 1.9 DTI (F7, J7, A07) 08.2001/07.2014 74KW 101CV 1870CC F9Q 760 0035AGG 0035AGH 0035512 0035513 0035429 0035430 - OPEL VIVARO A Autocarro (X83) 2.0 16V (F7, J7, A07) 08.2001/07.2006 88KW 120CV 1998CC F4R 720 0035508 0035509 0035440 0035441 - OP...</p> <p>d73x67mm d37mm</p>		<p>UTV83018 NO. 09110558 - 4402558 - 4418098 - 9110558 - 93192517</p> <p>TAMPÃO VEDAÇÃO BUJÃO</p> <p>OPEL VIVARO A Combi (X83) 2.0 ECOTEC (F7 - A07 - J7) (De 08-2006 Até ...) 86kW 117CV 1998cc Autocarro OPEL VIVARO A Combi (X83) 2.0 16V (F7 - J7 - A07) (De 08-2001 Até ...) 88kW 120CV 1998cc Autocarro OPEL VIVARO A Combi (X83) 1.9 DI (F7 - J7 - A07) (De 08-2001 Até ...) 60kW 80CV 1870cc Autocarro OPEL VIVARO A Combi (X83) 1.9 DTI (F7 - J7 - A07) (De 08-2001 Até ...) 74kW 101CV 1870cc Autocar...</p> <p>d21x18mm c14mm d15mm</p>
	<p>W5083 NO. 4405268 - 4416426 - 4416535 - 4418765 - 4433564 - 9121101 - 931188615 - 93187473 - 93196089 ...</p> <p>POLIE DA CABBOTA (7 PISTAS)</p> <p>OPEL VIVARO Combi (J7) 2.5 DTI Autocarro 135CV 2463cc (APÓS 05-2003) - 2.5 CDTI 146CV 2463cc (APÓS 08-2006) - VIVARO Caixa (F7) - 2.5 DTI 135CV 2463cc (APÓS 05-2003) - 2.5 CDTI 146CV 2463cc (APÓS 08-2006) - VIVARO Camião de plataforma-chassis (E7) - 2.5 C</p> <p>d152/162mm d30/58mm</p>		<p>W5089 NO. 55217839</p> <p>POLIE DA CABBOTA (7 PISTAS)</p> <p>OPEL VIVARO A Autocarro (X83): 2.0 ECOTEC (F7, A07, J7) 08.2006/>>> 86KW 117CV 1998CC - OPEL VIVARO A Autocarro (X83): 2.0 16V (F7, J7, A07) 08.2001/>>> 88KW 120CV 1998CC - OPEL VIVARO A Caixa (X83): 2.0 ECOTEC (F7) 08.2006/>>> 86KW 117CV 1998CC - OPEL VIVARO A Caixa (X83): 2.0 16V (F7) 08.2001/>>> 88KW 120CV 1998CC - OPEL VIVARO A Camião de plataforma/chassis (X83): 2.0 ECOTEC 08.2006/>>> 86KW 11...</p> <p>d151mm d24.5mm</p>
	<p>W5095 NO. 4405269 - 9121102</p> <p>POLIE DA CABBOTA (7 PISTAS)</p> <p>OPEL VIVARO A Autocarro (X83) 2.5 CDTI (F7, J7, A07) 08.2006/03.2010 84KW 114CV 2464CC G9U 630 0035AIE - OPEL VIVARO A Autocarro (X83) 2.5 CDTI (F7, J7, A07) 08.2006/07.2014 107KW 146CV 2463CC G9U 630 0035AQQ 0035AGK - OPEL VIVARO A Caixa (X83) 2.5 CDTI (F7) 08.2006/03.2010 84KW 114CV 2464CC G9U 630 0035AIF - OPEL VIVARO A Caixa (X83) 2.5 CDTI (F7) 08.2006/07.2014 107KW 146CV 2463CC G9U 630 G9MB6 ...</p> <p>d146.5mm d30mm</p>		<p>W5214 NO. 210511238R</p> <p>POLIE DA BOMBA DE ÁGUA (7 PISTAS)</p> <p>OPEL VIVARO 2 (1.6 DCI R9M)</p> <p>d104x31mm 1f-d50mm 3f-d8mm</p>









	<p>Y3218 NO. 9818845080</p> <p>PARAFUSO PERNO RODA CHAVE 17 M12X1,25X48MM (BASE CONICA PARA JANTES DE AÇO E LIGA LEVE)</p> <p>OPEL VIVARO C Autocarro (K0) 1.5 (03.2019 -) 75kw 102cv 1499cm3 Autocarro OPEL VIVARO C Autocarro (K0) 1.5 (03.2019 -) 88kw 120cv 1499cm3 Autocarro OPEL VIVARO C Autocarro (K0) 2.0 (03.2019 -) 90kw 122cv 1997cm3 Autocarro OPEL VIVARO C Autocarro (K0) 2.0 (03.2019 -) 110kw 150cv 1997cm3 Autocarro</p> <p>C48mm (Ch-17mm) M12x1,25x24mm</p>		<p>Y3218 NO. 9818845080</p> <p>PARAFUSO PERNO RODA CHAVE 17 M12X1,25X48MM (BASE CONICA PARA JANTES DE AÇO E LIGA LEVE)</p> <p>OPEL VIVARO C Caixa (K0) 1.5 (03.2019 -) 75kw 102cv 1499cm3 Caixa OPEL VIVARO C Caixa (K0) 1.5 (03.2019 -) 88kw 120cv 1499cm3 Caixa OPEL VIVARO C Caixa (K0) 1.5 4x4 (03.2019 -) 88kw 120cv 1499cm3 Caixa OPEL VIVARO C Caixa (K0) 2.0 (03.2019 -) 90kw 122cv 1997cm3 Caixa OPEL VIVARO C Caixa (K0) 2.0 (03.2019 -) 110kw 150cv 1997cm3 Caixa OPEL VIVARO C Caixa (K0) 2.0 (03.2019 -) 130kw 177cv 1997cm3 Caix...</p> <p>C48mm (Ch-17mm) M12x1,25x24mm</p>
	<p>Y3218 NO. 9818845080</p> <p>PARAFUSO PERNO RODA CHAVE 17 M12X1,25X48MM (BASE CONICA PARA JANTES DE AÇO E LIGA LEVE)</p> <p>OPEL VIVARO C Platform Cabin (K0) 2.0 (03.2019 -) 90kw 122cv 1997cm3 Camião de plataforma/chassis OPEL VIVARO C Platform Cabin (K0) 2.0 (03.2019 -) 110kw 150cv 1997cm3 Camião de plataforma/chassis</p> <p>C48mm (Ch-17mm) M12x1,25x24mm</p>		<p>Z80758 NO. 7703077421</p> <p>MOLA DE FRISO</p> <p>OPEL VIVARO</p> <p>d20x16.5mm 1p-8x8-6.5mm</p>
	<p>Z9200 NO. 7701208109</p> <p>MOLA DO PEDAL DA EMBRAIAGEM</p> <p>OPEL VIVARO A Autocarro (X83) 1.9 DI (F7, J7, A07) 08.2001/07.2006 60KW 80CV 1870CC F9Q 762 0035510 0035511 0035431 0035432 - OPEL VIVARO A Autocarro (X83) 1.9 DTI (F7, J7, A07) 08.2001/07.2014 74KW 101CV 1870CC F9Q 760 0035AGG 0035AGH 0035512 0035513 0035429 0035430 - OPEL VIVARO A Autocarro (X83) 2.0 16V (F7, J7, A07) 08.2001/07.2006 88KW 120CV 1998CC F4R 720 0035508 0035509 0035440 0035441 - OP...</p> <p>98x21x20mm 2f-d9mm</p>		

OPEL ZAFIRA - SINTRA

	<p>A1384 NO. 1040404</p> <p>APOIO DO MOTOR FRENTE LADO ESQUERDO</p> <p>OPEL ZAFIRA / ZAFIRA FAMILY B (A05): 1.6 (M75) 07.2005/09.2012 77KW 105CV 1598CC</p> <p>160x100x70mm 1p-d12-30mm</p>		<p>A1631 NO. 0682502 - 09191558 - 24427641 - 5682534 - 682502 - 9191558</p> <p>APOIO DO MOTOR PARTE DE TRÁS</p> <p>OPEL ZAFIRA 2.0 Dti 16v (09-2000 A 06-2005)</p> <p>130x150x90mm 1f-d13/19mm 1f-d12mm</p>
	<p>A1643 NO. 5684048 - 5684049 - 90575459 - 90575460</p> <p>APOIO DO MOTOR PARTE DA FRENTE ESQUERDO</p> <p>OPEL ZAFIRA A Veículo multiuso (T98) 2.0 DI 16V (F75) 07.1999/06.2005 60KW 82CV 1995CC X 20 DTL 0035375 - OPEL ZAFIRA A Veículo multiuso (T98) 2.0 DTI 16V (F75) 09.2000/06.2005 74KW 101CV 1995CC Y 20 DTH 0035401 - OPEL ZAFIRA A Veículo multiuso (T98) 2.0 OPC (F75) 09.2001/06.2005 141KW 192CV 1998CC Z 20 LET 0035435 - OPEL ZAFIRA A Veículo multiuso (T98) 2.0 OPC (F75) 11.2002/06.2005 147KW ...</p> <p>160x120x70mm 1f-d13mm</p>		<p>A1644 NO. 5684045 - 5684046 - 90575456 - 90575457</p> <p>APOIO DO MOTOR PARTE DA FRENTE ESQUERDO</p> <p>OPEL ZAFIRA 1.6 16v - 1.8 16v (1999 A 2005)</p> <p>170x105x70mm 1f-d13mm</p>
	<p>A1647 NO. 5684051 - 5684053 - 5684054 - 90575772</p> <p>APOIO DO MOTOR PARTE DA FRENTE DIREITO</p> <p>OPEL ZAFIRA A Veículo multiuso (T98) 1.6 16V (F75) 04.1999/06.2005 74KW 101CV 1598CC Z 16 XEX 16 XEL 0035373 - OPEL ZAFIRA A Veículo multiuso (T98) 1.6 CNG (F75) 09.2001/06.2005 71KW 97CV 1598CC Z 16 YNG 0035442 - OPEL ZAFIRA A Veículo multiuso (T98) 1.8 16V (F75) 04.1999/09.2000 85KW 116CV 1796CC X 18 XE1 0035374 - OPEL ZAFIRA A Veículo multiuso (T98) 1.8 16V (F75) 09.2000/06.2005 92KW 125CV 1796...</p> <p>170x140x120mm 1f-d12 - 7mm</p>		<p>A1651 NO. 0684692 - 684692 - 90576047</p> <p>APOIO DO MOTOR PARTE DA FRENTE CENTRAL</p> <p>OPEL ZAFIRA 1.2 16v - 1.6 - 1.7TD - 1.7DTi (1999 A 2005)</p> <p>230x130x80mm 1f-d16mm</p>
	<p>A1685 NO. 684693</p> <p>APOIO DO MOTOR PARTE DA FRENTE</p> <p>OPEL ZAFIRA 1.6 16v - 1.8 16v (COM TRANSMISSÃO AUTOMÁTICA) (1999 A 2005)</p> <p>145x125x75mm 1f-d16mm</p>		<p>A1691 NO. 0684697 - 684697 - 90576048</p> <p>APOIO DO MOTOR PARTE DA FRENTE</p> <p>OPEL ZAFIRA A Veículo multiuso (T98) 2.0 DI 16V (F75) 07.1999/06.2005 60KW 82CV 1995CC X 20 DTL 0035375 - OPEL ZAFIRA A Veículo multiuso (T98) 2.0 DTI 16V (F75) 09.2000/06.2005 74KW 101CV 1995CC Y 20 DTH 0035401</p> <p>170x123x75mm 1f-d16mm</p>

	<p>A1692 NO. 5682519 - 90538582</p> <p>APOIO DO MOTOR PARTE DE TRÁS</p> <p>OPEL ZAFIRA / ZAFIRA FAMILY B (A05) 1.6 (M75) 07.2005/09.2012 77kW 105CV 1598CC Z 16 XE12 16 XEP 0035AE0 0035100 - OPEL ZAFIRA / ZAFIRA FAMILY B (A05) 1.6 (M75) 01.2008/04.2015 85kW 115CV 1598CC A 16 XERZ 16 XER 0035AJJ - OPEL ZAFIRA / ZAFIRA FAMILY B (A05) 1.8 (M75) 07.2005/04.2015 103kW 140CV 1796CC Z 18 XERA 18 XER 0035AER 0035101 - OPEL ZAFIRA / ZAFIRA FAMILY B (A05) 1.9 CDTI (M75) 07.2005/12....</p> <p>155x125x92mm 1f-d12mm</p>		<p>A1694 NO. 0684168 - 0684695 - 09156951 - 09191564 - 5684162 - 684168 - 684695 - 90575190 - 9156951 - 91915...</p> <p>APOIO DO MOTOR PARTE DA FRENTE CENTRAL</p> <p>OPEL ZAFIRA 2.0 OPC (09-2001 A 06-2005)</p> <p>170x120x75mm 1f-d16mm</p>
	<p>A2059 NO. 24459803 - 5684137</p> <p>APOIO DO MOTOR PARTE DA FRENTE</p> <p>OPEL ZAFIRA B (A05) 1.6 CNG (M75) (De 01-2006 Até 04-2015) 69kW 94CV 1598cc Veículo multiuso OPEL ZAFIRA B (A05) 1.6 (M75) (De 07-2005 Até 09-2012) 77kW 105CV 1598cc Veículo multiuso OPEL ZAFIRA B (A05) 1.6 (M75) (De 01-2008 Até 04-2015) 85kW 115CV 1598cc Veículo multiuso OPEL ZAFIRA B (A05) 1.8 (M75) (De 07-2005 Até ...) 103kW 140CV 1796cc Veículo multiuso</p> <p>222x91x74mm 2f-d13mm 1f-d16mm</p>		<p>A2339 NO. 13159996 - 5684654</p> <p>APOIO DO MOTOR LADO ESQUERDO</p> <p>OPEL ZAFIRA / ZAFIRA FAMILY B (A05) 2.0 (M75) (De 07.2005 Até 12.2010) 147kW 200cv 1998cm3 Veículo multiuso - OPEL ZAFIRA / ZAFIRA FAMILY B (A05) 2.0 (M75) (De 01.2006 Até 12.2010) 177kW 241cv 1998cm3 Veículo multiuso - OPEL ZAFIRA / ZAFIRA FAMILY B (A05) 2.2 (M75) (De 07.2005 Até 12.2012) 110kW 150cv 2198cm3 Veículo multiuso -</p> <p>146x120x66mm 1p-d8x14mm 4f-d9mm 1f-d12mm</p>
	<p>A2545 NO. 5684644</p> <p>APOIO DO MOTOR PARTE DA FRENTE LADO DIREITO</p> <p>OPEL ZAFIRA / ZAFIRA FAMILY B (A05) 1.7 CDTI (M75) (De 01.2008 Até 04.2015) 81kW 110cv 1686cm3 Veículo multiuso - OPEL ZAFIRA / ZAFIRA FAMILY B (A05) 1.7 CDTI (M75) (De 03.2007 Até 04.2015) 92kW 125cv 1686cm3 Veículo multiuso - OPEL ZAFIRA / ZAFIRA FAMILY B (A05) 1.9 CDTI (M75) (De 07.2005 Até 12.2010) 74kW 100cv 1910cm3 Veículo multiuso - OPEL ZAFIRA / ZAFIRA FAMILY B (A05) 1.9 CDTI (M75) (De 07....</p> <p>170x65x114mm 2f-d10mm 1f-d12mm 1f-d13mm</p>		<p>B450 NO. 164987</p> <p>ABRAÇADEIRA DO REVESTIMENTO DO HABITÁCULO</p> <p>OPEL ZAFIRA A Veículo multiuso (T98) 1.6 (F75) (10.2003 - 06.2005) 76kW 103cv 1598cm3 Veículo multiuso OPEL ZAFIRA A Veículo multiuso (T98) 1.6 16V (F75) (04.1999 - 06.2005) 74kW 101cv 1598cm3 Veículo multiuso OPEL ZAFIRA A Veículo multiuso (T98) 1.6 CNG (F75) (09.2001 - 06.2005) 71kW 97cv 1598cm3 Veículo multiuso OPEL ZAFIRA A Veículo multiuso (T98) 1.8 16V (F75) (04.1999 - 09.2000) 85kW 116cv 1... </p> <p>245x38x11mm</p>
	<p>C0233 NO. 1160724 - 90054143</p> <p>BOTÃO AFINAÇÃO CAPÔT</p> <p>OPEL ZAFIRA A (F75_) 1.6 CNG (09.01 A 06.05) 97cv 1598cc Veículo multiuso OPEL ZAFIRA A (F75_) 1.6 16V (04.99 A 06.05) 101cv 1598cc Veículo multiuso - OPEL ZAFIRA A (F75_) 1.8 16V (04.99 A 09.00) 116cv 1796cc Veículo multiuso - OPEL ZAFIRA A (F75_) 1.8 16V (09.00 A 06.05) 125cv 1796cc Veículo multiuso - OPEL ZAFIRA A (F75_) 2.0 OPC (09.01 A 06.05) 192cv 1998cc Veículo multiuso ...</p> <p>d19x31mm</p>		<p>C0233 NO. 1160724 - 90054143</p> <p>BOTÃO AFINAÇÃO CAPÔT</p> <p>OPEL ZAFIRA B (A05) 1.6 CNG (A Partir de 01.06) 94cv 1598cc Veículo multiuso - OPEL ZAFIRA B (A05) 1.6 (A Partir de 07.05) 105cv 1598cc Veículo multiuso - OPEL ZAFIRA B (A05) 1.6 (A partir de 01.08) 115cv 1598cc Veículo multiuso - OPEL ZAFIRA B (A05) 1.6 CNG Turbo (A Partir de 02.09) 150cv 1598cc Veículo multiuso OPEL ZAFIRA B (A05) 1.8 (A Partir de 07.05) 140cv 1796 Veículo multiuso...</p> <p>d19x31mm</p>
	<p>C0233 NO. 1160724 - 90054143</p> <p>BOTÃO AFINAÇÃO CAPÔT</p> <p>OPEL ZAFIRA TOURER C (P 12) 1.4 (A Partir de 10.11) 120cv 1364cc Veículo multiuso - OPEL ZAFIRA TOURER C (P 12) 1.4 (A Partir de 10.11) 140cv 1364cc Veículo multiuso - OPEL ZAFIRA TOURER C (P 12) 1.4 LPG (A Partir de 10.11) 140cv 1364cc Veículo multiuso - OPEL ZAFIRA TOURER C (P 12) 1.6 CNG (A Partir de 10.11) 150cv 1598cc Veículo multiuso - OPEL ZAFIRA TOURER C (P 12) 1.6 SIDI (A Partir de ...</p> <p>d19x31mm</p>		<p>E0163 NO. 0350611 - 0350614 - 350611 - 350614 - 90498745</p> <p>ESTICADOR DA BARRA ESTABILIZADORA DA FRENTE</p> <p>OPEL ZAFIRA A Veículo multiuso (T98): 1.6 CNG (F75) 09.2001/06.2005 71kW 97CV 1598CC - OPEL ZAFIRA A Veículo multiuso (T98): 1.6 16V (F75) 04.1999/06.2005 74kW 101CV 1598CC - OPEL ZAFIRA A Veículo multiuso (T98): 1.8 16V (F75) 04.1999/09.2000 85kW 116CV 1796CC - OPEL ZAFIRA A Veículo multiuso (T98): 1.8 16V (F75) 09.2000/06.2005 92kW 125CV 1796CC - OPEL ZAFIRA A Veículo multiuso (T98): 2.0 OPC (F7...)</p> <p>340x37x37mm 2p-d12-25mm</p>
	<p>E1092 NO. 0852726 - 13276148 - 852577 - 852726 - 90466668</p> <p>ESTICADOR DE ESCAPE</p> <p>OPEL ZAFIRA A Veículo multiuso (T98): 1.6 CNG (F75) 09.2001/06.2005 71kW 97CV 1598CC - OPEL ZAFIRA A Veículo multiuso (T98): 1.6 16V (F75) 04.1999/06.2005 74kW 101CV 1598CC - OPEL ZAFIRA A Veículo multiuso (T98): 1.8 16V (F75) 04.1999/09.2000 85kW 116CV 1796CC - OPEL ZAFIRA A Veículo multiuso (T98): 1.8 16V (F75) 09.2000/06.2005 92kW 125CV 1796CC - OPEL ZAFIRA A Veículo multiuso (T98): 2.0 OPC (F7...)</p> <p>55x40x35mm</p>		<p>E23401-V NO. 0758801 - 758801 - 90250156</p> <p>ESTICADOR MANETE CAIXA DE VELOCIDADES</p> <p>OPEL ZAFIRA A Veículo multiuso (T98) 1.6 CNG (F75) (De 09-2001 Até 06-2005) 71kW 97CV 1598cc Veículo multiuso OPEL ZAFIRA A Veículo multiuso (T98) 1.6 16V (F75) (De 04-1999 Até 06-2005) 74kW 101CV 1598cc Veículo multiuso OPEL ZAFIRA A Veículo multiuso (T98) 1.8 16V (F75) (De 04-1999 Até 09-2000) 85kW 116CV 1796cc Veículo multiuso OPEL ZAFIRA A Veículo multiuso (T98) 1.8 16V (F75) (De 09-2000 Até...)</p> <p>207x17x18mm 2f-d11mm</p>
	<p>E23401-V NO. 0758801 - 758801 - 90250156</p> <p>ESTICADOR MANETE CAIXA DE VELOCIDADES</p> <p>OPEL ZAFIRA B (A05) 1.6 CNG (M75) (De 07-2005 Até 04-2015) 69kW 94CV 1598cc Veículo multiuso OPEL ZAFIRA B (A05) 1.6 (M75) (De 07-2005 Até 09-2012) 77kW 105CV 1598cc Veículo multiuso OPEL ZAFIRA B (A05) 1.6 (M75) (De 01-2008 Até 04-2015) 85kW 115CV 1598cc Veículo multiuso OPEL ZAFIRA B (A05) 1.6 CNG Turbo (M75) (De 02-2009 Até 04-2015) 110kW 150CV 1598cc Veículo multiuso OPEL ZAFIRA B (A05) 1....</p> <p>207x17x18mm 2f-d11mm</p>		<p>F1650A-I NO. 1604252 - 1604300 - 90510398</p> <p>FOLE DA TRANSMISSÃO JUNTO À CAIXA</p> <p>OPEL ZAFIRA (1) 1.8i 16V - 2.0 Di 16V (1999 A 2005)</p> <p>d110x125mm 4f-d108mm 1f-d25mm</p>
	<p>F1848-I NO. 1603014 - 1603183 - 1603238 - 374014 - 374319 - 374429 - 90543336</p> <p>FOLE DA TRANSMISSÃO JUNTO À CAIXA</p> <p>OPEL ZAFIRA 1.6i CN(G) - 1.8i 16v - 2.0 DTi 16v - 2.2i 16v (APÓS 1999)</p> <p>d95x100mm 1f-d65mm 1f-d24mm</p>		<p>F3773-T NO. 39241BM525 - 39241BM526 - 39241BM527</p> <p>FOLE TRANSMISSÃO JUNTO À RODA</p> <p>OPEL ZAFIRA</p> <p>d93x121mm 1f-d76mm 1f-d23mm</p>

	<p>F4099 NO. 5738419 - 93182743</p> <p>FOLE ALAVANCA VELOCIDADES</p> <p>OPEL ZAFIRA A Veículo multiuso (T98): 1.6 CNG (F75) 09.2001/06.2005 71KW 97CV 1598CC - OPEL ZAFIRA A Veículo multiuso (T98): 1.6 16V (F75) 04.1999/06.2005 74KW 101CV 1598CC - OPEL ZAFIRA A Veículo multiuso (T98): 1.8 16V (F75) 04.1999/09.2000 85KW 116CV 1796CC - OPEL ZAFIRA A Veículo multiuso (T98): 1.8 16V (F75) 09.2000/06.2005 92KW 125CV 1796CC - OPEL ZAFIRA A Veículo multiuso (T98): 2.0 OPC (F7...)</p> <p>160x110x190mm 1f-d45mm 1f-140x95mm</p>		<p>F4100 NO. 5738420 - 93182744</p> <p>FOLE ALAVANCA VELOCIDADES</p> <p>OPEL ZAFIRA A Veículo multiuso (T98): 1.6 CNG (F75) 09.2001/06.2005 71KW 97CV 1598CC - OPEL ZAFIRA A Veículo multiuso (T98): 1.6 16V (F75) 04.1999/06.2005 74KW 101CV 1598CC - OPEL ZAFIRA A Veículo multiuso (T98): 1.8 16V (F75) 04.1999/09.2000 85KW 116CV 1796CC - OPEL ZAFIRA A Veículo multiuso (T98): 1.8 16V (F75) 09.2000/06.2005 92KW 125CV 1796CC - OPEL ZAFIRA A Veículo multiuso (T98): 2.0 OPC (F7...)</p> <p>160x115x190mm 1f-d45mm 1f-140x95mm</p>
	<p>F4142 NO. 5738025 - 93180984</p> <p>FOLE ALAVANCA VELOCIDADES</p> <p>OPEL ZAFIRA B 2005/2010</p> <p>155x133x160mm 1f-d22mm</p>		<p>F4233 NO. 93329526</p> <p>FOLE ALAVANCA VELOCIDADES C/ ARO CROMADO</p> <p>OPEL ZAFIRA / ZAFIRA FAMILY B (A05): 1.6 CNG (M75) 07.2005/04.2015 69KW 94CV 1598CC - OPEL ZAFIRA / ZAFIRA FAMILY B (A05): 1.6 (M75) 07.2005/09.2012 77KW 105CV 1598CC - OPEL ZAFIRA / ZAFIRA FAMILY B (A05): 1.6 (M75) 01.2008/04.2015 85KW 115CV 1598CC - OPEL ZAFIRA / ZAFIRA FAMILY B (A05): 1.6 FlexFuel (M75) 08.2008/12.2012 85KW 116CV 1598CC - OPEL ZAFIRA / ZAFIRA FAMILY B (A05): 1.6 CNG Turbo (M75)...</p> <p>157x166x143mm 1f-123x132mm</p>
	<p>F4263 NO. 55354140 - 5555718 - 55568376 - 5738036 - 738536</p> <p>FOLE ALAVANCA VELOCIDADES C/ MANETE PUNHO TOPO COMPLETO 5 VELOCIDADES</p> <p>OPEL ZAFIRA / ZAFIRA FAMILY B (A05) 1.6 (M75) 07.2005/09.2012 77KW 105CV 1598CC Z 16 XE1 Z 16 XEP 0035AEO 0035100 - OPEL ZAFIRA / ZAFIRA FAMILY B (A05) 1.6 (M75) 01.2008/04.2015 85KW 115CV 1598CC A 16 XER Z 16 XER 0035AJJ - OPEL ZAFIRA / ZAFIRA FAMILY B (A05) 1.6 CNG (M75) 07.2005/04.2015 69KW 94CV 1598CC Z 16 YNG 0035AFA 0035ANS - OPEL ZAFIRA / ZAFIRA FAMILY B (A05) 1.6 CNG Turbo (M75) 04.2010/04...</p> <p>244x167x125mm 1f-140x99mm</p>		<p>F4263 NO. 55354140 - 5555718 - 55568376 - 5738036 - 738536</p> <p>FOLE ALAVANCA VELOCIDADES C/ MANETE PUNHO TOPO COMPLETO 5 VELOCIDADES</p> <p>OPEL ZAFIRA B Caixa/monovolume (A05) 1.6 CNG Turbo VAN (M75) 02.2009/04.2015 110KW 150CV 1598CC A 16 XNT Z 16 XNT 0035AQN 0035AUB - OPEL ZAFIRA B Caixa/monovolume (A05) 1.6 CNG VAN (M75) 07.2005/04.2015 69KW 94CV 1598CC Z 16 YNG - OPEL ZAFIRA B Caixa/monovolume (A05) 1.7 CDTI VAN (M75) 01.2008/04.2015 81KW 110CV 1686CC Z 17 DTJ A 17 DTJ 0035AQM 0035ATZ - OPEL ZAFIRA B Caixa/monovolume (A05) 1.7 CD...</p> <p>244x167x125mm 1f-140x99mm</p>
	<p>F4269 NO. 759607 - 9118424</p> <p>FOLE ALAVANCA VELOCIDADES</p> <p>OPEL ZAFIRA A Veículo multiuso (T98) 1.6 (F75) (De 10.2003 Até 06.2005) 76KW 103cv 1598cm3 Veículo multiuso - OPEL ZAFIRA A Veículo multiuso (T98) 1.6 16V (F75) (De 04.1999 Até 06.2005) 74KW 101cv 1598cm3 Veículo multiuso - OPEL ZAFIRA A Veículo multiuso (T98) 1.6 CNG (F75) (De 09.2001 Até 06.2005) 71KW 97cv 1598cm3 Veículo multiuso - OPEL ZAFIRA A Veículo multiuso (T98) 1.8 16V (F75) (De 04.1999 ...</p> <p>180x150x70mm 1f-127x47mm</p>		<p>KF2271-T NO. 1603259 - 374434</p> <p>KIT DE FOLE DO CARDAN JUNTO À RODA</p> <p>OPEL ZAFIRA 1.6i CN(G) - 1.8i 16v - 2.0 DTi 16v (APÓS 1999)</p> <p>d105x125mm 1f-d83mm 1f-d25mm</p>
	<p>KF3480 NO. 09198502 - 09200338 - 1603011 - 1603220 - 1603221</p> <p>KIT DE FOLE DO CARDAN JUNTO À RODA</p> <p>OPEL ZAFIRA 2.0 OPC 192CV (09-2001 A 06-2005) - 2.0 OPC 200CV (11-2002 A 06-2005) - 2.2 DTi 16V 125CV (01-2002 A 06-2005)</p> <p>d93x98mm 1f-d26mm 1f-d83mm</p>		<p>KF3760-T NO. 09201727 - 1603012 - 96391553 - 96489655</p> <p>KIT DE FOLE DO CARDAN JUNTO À RODA</p> <p>OPEL ZAFIRA</p> <p>d106x122mm 1f-d82mm 1f-d24mm</p>
	<p>KL80449 NO. 198283 - 607813 - 90412865</p> <p>KIT CASQUILHOS COBERTURA TAMPA MOTOR</p> <p>OPEL ZAFIRA A Veículo multiuso (T98): 1.6 CNG (F75) 09.2001/06.2005 71KW 97CV 1598CC - OPEL ZAFIRA A Veículo multiuso (T98): 1.6 16V (F75) 04.1999/06.2005 74KW 101CV 1598CC - OPEL ZAFIRA A Veículo multiuso (T98): 1.8 16V (F75) 04.1999/09.2000 85KW 116CV 1796CC - OPEL ZAFIRA A Veículo multiuso (T98): 2.0 DI 16V (F75) 07.1999/06.2005 60KW 82KW 1995CC - OPEL ZAFIRA A Veículo multiuso (T98): 2.0 DTI 1...</p> <p>d16x10mm 1f-d6mm</p>		<p>KUBT3044 NO. 1f-d32mm 1f-d42mm 1f-d8mm 1f-d5mm</p> <p>KIT BORRACHAS TRAVÃO DE TRÁS</p> <p>OPEL ZAFIRA B Caixa/monovolume (A05) 1.6 CNG Turbo VAN (M75) (02.2009 - 04.2015) 110kw 150cv 1598cm3 Caixa/monovolume OPEL ZAFIRA B Caixa/monovolume (A05) 1.6 CNG VAN (M75) (07.2005 - 04.2015) 69kw 94cv 1598cm3 Caixa/monovolume OPEL ZAFIRA B Caixa/monovolume (A05) 1.7 CDTI VAN (M75) (01.2008 - 04.2015) 81kw 110cv 1686cm3 Caixa/monovolume OPEL ZAFIRA B Caixa/monovolume (A05) 1.7 CDTI VAN (M75) (01....</p> <p>d54x14mm d48x3mm d53x11mm d41x10mm d41x10mm d26x28mm d210mm</p>
	<p>P1081 NO. 0842736 - 842736 - 90232022</p> <p>CAPA PEDAL ACELARADOR</p> <p>OPEL ZAFIRA A Veículo multiuso (T98) 1.6 16V (F75) 04.1999/06.2005 74KW 101CV 1598CC Z 16 XE X 16 XEL 0035373 - OPEL ZAFIRA A Veículo multiuso (T98) 1.8 16V (F75) 04.1999/09.2000 85KW 116CV 1796CC X 18 XE1 0035374 - OPEL ZAFIRA A Veículo multiuso (T98) 1.8 16V (F75) 09.2000/06.2005 92KW 125CV 1796CC Z 18 XE 0035400 - OPEL ZAFIRA A Veículo multiuso (T98) 2.0 DTI 16V (F75) 09.2000/06.2005 74KW 101CV...</p> <p>132x53x14mm</p>		<p>P1103 NO. 0560804 - 09191205 - 560804 - 9191205</p> <p>CAPA PEDAL TRAVÃO (VEÍCULOS CAIXA AUTOMÁTICA)</p> <p>OPEL ZAFIRA A Veículo multiuso (T98) 1.6 16V (F75) 04.1999/06.2005 74KW 101CV 1598CC Z 16 XE X 16 XEL 0035373 - OPEL ZAFIRA A Veículo multiuso (T98) 1.6 CNG (F75) 09.2001/06.2005 71KW 97CV 1598CC Z 16 YNG 0035442 - OPEL ZAFIRA A Veículo multiuso (T98) 1.8 16V (F75) 04.1999/09.2000 85KW 116CV 1796CC X 18 XE1 0035374 - OPEL ZAFIRA A Veículo multiuso (T98) 1.8 16V (F75) 09.2000/06.2005 92KW 125CV 1796CC Z 18 XE1 0035400 - OPEL ZAFIRA A Veículo multiuso (T98) 2.0 DTI 16V (F75) 09.2000/06.2005 74KW 101CV...</p> <p>110x65x45mm</p>
	<p>R080253 NO. 06336007 - 09128719</p> <p>TUBO LÍQUIDO REFRIGERAÇÃO</p> <p>OPEL ZAFIRA / ZAFIRA FAMILY B (A05) 1.6 CNG (M75) 07.2005/04.2015 69KW 94CV 1598CC Z 16 YNG 0035AFA 0035ANS - OPEL ZAFIRA A Veículo multiuso (T98) 1.6 16V (F75) 04.1999/06.2005 74KW 101CV 1598CC Z 16 XE X 16 XEL 0035373 - OPEL ZAFIRA A Veículo multiuso (T98) 1.8 16V (F75) 04.1999/09.2000 85KW 116CV 1796CC Z 18 XE1 0035374 - OPEL ZAFIRA A Veículo multiuso (T98) 1.8 16V (F75) 09.2000/06.2005 92KW 125CV 1796CC Z 18 XE 0035400 - OPEL ZAFIRA A Veículo multiuso (T98) 2.0 DTI 16V (F75) 09.2000/06.2005 74KW 101CV...</p> <p>B340-30/35mm ch-d13-29mm ch-d13-30mm</p>		<p>R221427 NO. 13117572 - 1337734</p> <p>TUBO SUPERIOR DO RADIADOR</p> <p>OPEL ZAFIRA / ZAFIRA FAMILY B (A05) 1.9 CDTI (M75) 07.2005/12.2010 74KW 100CV 1910CC Z 19 DTL 0035AEL 0035104 - OPEL ZAFIRA / ZAFIRA FAMILY B (A05) 1.9 CDTI (M75) 07.2005/04.2015 88KW 120CV 1910CC Z 19 DT 0035AEM 0035105 - OPEL ZAFIRA / ZAFIRA FAMILY B (A05) 1.9 CDTI (M75) 07.2005/04.2015 110KW 150CV 1910CC Z 19 DTH 0035AEN 0035106</p> <p>B245-31/32mm 52x49x58x79x56mm</p>

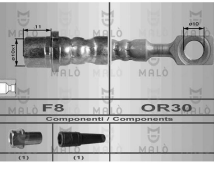
	<p>R222703 NO. 1337582 - 24413975</p> <p>TUBO SUPERIOR DO RADIADOR</p> <p>OPEL ZAFIRA A Veículo multiuso (T98) 1.6 16V (F75) 04.1999/06.2005 74KW 101CV 1598CC Z 16 XEX 16 XEL 0035373 - OPEL ZAFIRA A Veículo multiuso (T98) 1.6 CNG (F75) 09.2001/06.2005 71KW 97CV 1598CC Z 16 YNG 0035442 - OPEL ZAFIRA A Veículo multiuso (T98) 2.0 OPC (F75) 11.2002/06.2005 147KW 200CV 1998CC Z 20 LET 0035479</p> <p>B190-d34/34mm 55-70-90-80-50-60mm</p>		<p>R222704 NO. 1337556 - 9202896</p> <p>TUBO INFERIOR DO RADIADOR</p> <p>OPEL ZAFIRA A Veículo multiuso (T98) 1.6 16V (F75) 04.1999/06.2005 74KW 101CV 1598CC Z 16 XEX 16 XEL 0035373 - OPEL ZAFIRA A Veículo multiuso (T98) 1.6 CNG (F75) 09.2001/06.2005 71KW 97CV 1598CC Z 16 YNG 0035442 - OPEL ZAFIRA A Veículo multiuso (T98) 2.0 OPC (F75) 11.2002/06.2005 147KW 200CV 1998CC Z 20 LET 0035479</p> <p>B455-d38/33mm 255-60-100-70-70mm</p>
	<p>R222707 NO. 1337521 - 9129152</p> <p>TUBO DE LIGAÇÃO TERMOSTATO À BOMBA DE ÁGUA</p> <p>OPEL ZAFIRA A Veículo multiuso (T98) 1.6 16V (F75) (De 1999.04 Até 2005.06) 74kW 101cv 1598cm3 Veículo multiuso -</p> <p>B156-28/36mm 61x75x37mm ch-d26x50x42mm</p>		<p>R222715 NO. 1377542</p> <p>TUBO SUPERIOR DO RADIADOR</p> <p>Opel Zafira 1.7 TD (1998 a 2005)</p> <p>B320-d34/34mm 80-110-150-120mm</p>
	<p>R222723 NO. 1337565 - 24421116</p> <p>TUBO SUPERIOR DO RADIADOR</p> <p>OPEL ZAFIRA A Veículo multiuso (T98) 2.0 DI 16V (F75) 07.1999/06.2005 60KW 82CV 1995CC X 20 DTL Y 20 DTL 0035375 - OPEL ZAFIRA A Veículo multiuso (T98) 2.0 DTI 16V (F75) 09.2000/06.2005 74KW 101CV 1995CC Y 20 DTH 0035401 - OPEL ZAFIRA A Veículo multiuso (T98) 2.2 DTI 16V (F75) 01.2002/06.2005 92KW 125CV 2172CC Y 22 DTR 0035443</p> <p>B170-d34/34mm 70-60-100-60-85mm</p>		<p>R222724 NO. 1337502 - 90573220 - 91156066</p> <p>TUBO INFERIOR DO RADIADOR</p> <p>OPEL ZAFIRA A Veículo multiuso (T98) 2.0 DI 16V (F75) 07.1999/06.2005 60KW 82CV 1995CC X 20 DTL Y 20 DTL 0035375 - OPEL ZAFIRA A Veículo multiuso (T98) 2.0 DTI 16V (F75) 09.2000/06.2005 74KW 101CV 1995CC Y 20 DTH 0035401 - OPEL ZAFIRA A Veículo multiuso (T98) 2.2 DTI 16V (F75) 01.2002/06.2005 92KW 125CV 2172CC Y 22 DTR 0035443</p> <p>B220-d33/33mm 60-100-35-60-60mm</p>
	<p>R222731 NO. 1337588</p> <p>TUBO INFERIOR DO RADIADOR</p> <p>OPEL ZAFIRA A Veículo multiuso (T98) 2.0 OPC (F75) (De 09.2001 Até 06.2005) 141kW 192cv 1998cm3 Veículo multiuso - OPEL ZAFIRA A Veículo multiuso (T98) 2.0 OPC (F75) (De 11.2002 Até 06.2005) 147kW 200cv 1998cm3 Veículo multiuso -</p> <p>B440-33/41m 58x56x85x54x105x40x58mm</p>		<p>R222749 NO. 055353829 - 06302612 - 1302574 - 55353831 - 55557037 - 6302611</p> <p>TUBO DO AR SOBRELIMENTAÇÃO</p> <p>OPEL ZAFIRA / ZAFIRA FAMILY B (A05) 1.9 CDTI (M75) (07.2005 - 12.2010) 74kw 100cv 1910cm3 Veículo multiuso OPEL ZAFIRA / ZAFIRA FAMILY B (A05) 1.9 CDTI (M75) (07.2005 - 04.2015) 88kw 120cv 1910cm3 Veículo multiuso OPEL ZAFIRA / ZAFIRA FAMILY B (A05) 1.9 CDTI (M75) (07.2005 - 04.2015) 110kw 150cv 1910cm3 Veículo multiuso</p> <p>boca a boca253mmd1-39mm253mm60-47</p>
	<p>R222779 NO. 1337519 - 1337583 - 24413976 - 9129413</p> <p>TUBO SUPERIOR DO RADIADOR LADO DA ADMISSÃO</p> <p>OPEL ZAFIRA A Veículo multiuso (T98) 1.6 16V (F75) (De 04.1999 Até 06.2005) 74kW 101cv 1598cm3 Veículo multiuso - OPEL ZAFIRA A Veículo multiuso (T98) 1.6 CNG (F75) (De 09.2001 Até 06.2005) 71kW 97cv 1598cm3 Veículo multiuso -</p> <p>B140-32/33mm 103x97x87x28x44mm</p>		<p>R222798 NO. 13118275 - 6818568</p> <p>TUBO SUPERIOR RADIADOR</p> <p>OPEL ZAFIRA B (A05) 1.6 (M75) (De 07-2005 Até ...) 77kW 105CV 1598cc Veículo multiuso</p> <p>B320-18/23mm 96-75-75-40mm</p>
	<p>R225200 NO. 68-44-146-60-60mm - chauf d15-53-6</p> <p>TUBO INFERIOR DO RADIADOR LADO DIREITO</p> <p>OPEL ZAFIRA / ZAFIRA FAMILY B (A05) 1.7 CDTI (M75) 03.2007/04.2015 92KW 125CV 1686CC A 17 DTR Z 17 DTR 0035AIL - OPEL ZAFIRA / ZAFIRA FAMILY B (A05) 1.7 CDTI (M75) 01.2008/04.2015 81KW 110CV 1686CC Z 17 DTJ A 17 DTJ 0035AIK - OPEL ZAFIRA B Caixa/monovolume (A05) 1.7 CDTI VAN (M75) 01.2008/04.2015 81KW 110CV 1686CC Z 17 DTJ A 17 DTJ 0035AQM 0035ATZ</p> <p>B300-d32/d32mm 68-44-146-60-60mm - chauf d15-53-63-58</p>		<p>R225245 NO. 1337517 - 9157129</p> <p>TUBO CHAUFAGEM CONEXÃO PARA O MOTOR</p> <p>OPEL ZAFIRA A Veículo multiuso (T98) 2.0 DI 16V (F75) (De 07.1999 Até 06.2005) 60kW 82cv 1995cm3 Veículo multiuso - OPEL ZAFIRA A Veículo multiuso (T98) 2.0 DTI 16V (F75) (De 09.2000 Até 06.2005) 74kW 101cv 1995cm3 Veículo multiuso -</p> <p>B225-d13/d18mm mm</p>
	<p>R225642 NO. 13026005 - 24451329 - 55559701 - 5860500</p> <p>TUBO DO AR SOBREALIMENTAÇÃO</p> <p>OPEL ZAFIRA A Veículo multiuso (T98) 2.0 DTI 16V (F75) 09.2000/06.2005 74KW 101CV 1995CC Y 20 DTH 0035401 - OPEL ZAFIRA A Veículo multiuso (T98) 2.2 DTI 16V (F75) 01.2002/06.2005 92KW 125CV 2172 C Y 22 DTR 0035443</p> <p>B238-41/50mm 65-70-29-61mm</p>		<p>RT08934 NO. 562377 - 90498319</p> <p>TUBO DE TRAVÃO FRENTE LH-RH</p> <p>OPEL ZAFIRA TT (APÓS 04-1999)</p> <p>396mm F8 - OR30</p>
	<p>RT80277 NO. 13136715 - 5562260 - 562161</p> <p>TUBO DE TRAVÃO FRENTE LH-RH</p> <p>OPEL ZAFIRA II TT (APÓS 07-2005)</p> <p>440mm F8 - OR30</p>		<p>RT80582 NO. 5562248</p> <p>TUBO DE TRAVÃO TRÁS RH (COM DISCO)</p> <p>OPEL ZAFIRA 1.6 (motor Z 16 XEP) (APÓS 7-2005) - 1.6 (motor Z 16 XER) (APÓS 01-2008) - 1.6 (motor Z 16 YNG) (APÓS 01-2008) - 1.7 CDTI (motor A 17 DTJ) (APÓS 01-2008) - 1.7 CDTI (motor A 17 DTR) (APÓS 01-2008) - 1.8 (motor Z 18 XEP) (APÓS 07-2005) - 1.9 CD</p> <p>760mm</p>

	<p>RT80583 NO. 5562247</p> <p>TUBO DE TRAVÃO TRÁS LH (COM DISCO)</p> <p>OPEL ZAFIRA 1.6 (motor Z 16 XEP) (APÓS 7-2005) - 1.6 (motor Z 16 XER) (APÓS 01-2008) - 1.6 (motor Z 16 YNG) (APÓS 01-2006) - 1.7 CDTi (motor A 17 DTJ) (APÓS 01-2008) - 1.7 CDTi (motor A 17 DTR) (APÓS 01-2008) - 1.8 (motor Z 18 XEP) (APÓS 07-2005) - 1.9 CD</p>		<p>S1333 NO. 3523.65 - 90498740</p> <p>SILENT-BLOC DO BRAÇO SUSPENSÃO FRENTE(PARTE DE TRÁS)</p> <p>OPEL ZAFIRA A Veículo multiuso (T98): 1.6 CNG (F75) 09.2001/06.2005 71KW 97CV 1598CC - OPEL ZAFIRA A Veículo multiuso (T98): 1.6 16V (F75) 04.1999/06.2005 74KW 101CV 1598CC - OPEL ZAFIRA A Veículo multiuso (T98): 1.8 16V (F75) 04.1999/09.2000 85KW 116CV 1796CC - OPEL ZAFIRA A Veículo multiuso (T98): 1.8 16V (F75) 09.2000/06.2005 92KW 125CV 1796CC - OPEL ZAFIRA A Veículo multiuso (T98): 2.0 OPC (F7...)</p>
	<p>S1473 NO. 0352364 - 352364 - 90498738</p> <p>SILENT BLOC DO BRAÇO SA SUSPENSÃO DA FRENTE</p> <p>OPEL ZAFIRA 1.6 16V - 1.6CNG - 1.8 - 1.8 16V - 1.9CDTi - 2.0 OPC - 2.0Di 16V - 2.0DTi 16V - 2.2 16V - 2.2DTi 16V</p>		<p>S1714 NO. 0302275 - 0302290 - 09223022 - 302275 - 302290 - 90498689 - 9223022</p> <p>SILENT-BLOC DA SUSPENSÃO SUB-CHASSI DA FRENTE</p> <p>OPEL ZAFIRA A Veículo multiuso (T98) 1.6 CNG (F75) (De 2001.09 Até 2005.06) 71kW 97cv 1598cm3 Veículo multiuso - OPEL ZAFIRA A Veículo multiuso (T98) 1.6 16V (F75) (De 1999.04 Até 2005.06) 74kW 101cv 1598cm3 Veículo multiuso - OPEL ZAFIRA A Veículo multiuso (T98) 1.8 16V (F75) (De 1999.04 Até 2000.09) 85kW 116cv 1796cm3 Veículo multiuso - OPEL ZAFIRA A Veículo multiuso (T98) 1.8 ...</p>
	<p>S1714 NO. 0302275 - 0302290 - 09223022 - 302275 - 302290 - 90498689 - 9223022</p> <p>SILENT-BLOC DA SUSPENSÃO SUB-CHASSI DA FRENTE</p> <p>OPEL ZAFIRA B (A05) 1.6 CNG Turbo (M75) (De 2009.02 Até 2015.04) 110kW 150cv 1598cm3 Veículo multiuso - OPEL ZAFIRA B (A05) 1.8 LPG (M75) (De 2009.07 Até 2015.04) 103kW 140cv 1796cm3 Veículo multiuso - OPEL ZAFIRA B (A05) 1.8 (M75) (De 2005.07 Até 2015.04) 103kW 140cv 1796cm3 Veículo multiuso - OPEL ZAFIRA B (A05) 2.0 (M75) (De 2005.07 Até 2010.12) 147kW 200cv 1998cm3 Veículo...</p>		<p>S1715 NO. 0302067 - 13107328 - 302067</p> <p>SILENT-BLOC DA SUSPENSÃO SUB-CHASSI FRENTE</p> <p>OPEL ZAFIRA A Veículo multiuso (T98) 1.6 CNG (F75) (De 2001.09 Até 2005.06) 71kW 97cv 1598cm3 Veículo multiuso - OPEL ZAFIRA A Veículo multiuso (T98) 1.6 16V (F75) (De 1999.04 Até 2005.06) 74kW 101cv 1598cm3 Veículo multiuso - OPEL ZAFIRA A Veículo multiuso (T98) 1.8 16V (F75) (De 1999.04 Até 2000.09) 85kW 116cv 1796cm3 Veículo multiuso - OPEL ZAFIRA A Veículo multiuso (T98) 1.8 ...</p>
	<p>S1715 NO. 0302067 - 13107328 - 302067</p> <p>SILENT-BLOC DA SUSPENSÃO SUB-CHASSI FRENTE</p> <p>OPEL ZAFIRA B (A05) 1.6 CNG (M75) (De 2005.07 Até 2015.04) 69kW 94cv 1598cm3 Veículo multiuso - OPEL ZAFIRA B (A05) 1.6 (M75) (De 2005.07 Até 2012.09) 77kW 105cv 1598cm3 Veículo multiuso - OPEL ZAFIRA B (A05) 1.6 (M75) (De 2008.01 Até 2015.04) 85kW 115cv 1598cm3 Veículo multiuso - OPEL ZAFIRA B (A05) 1.6 CNG Turbo (M75) (De 2009.02 Até 2015.04) 110kW 150cv 1598cm3 Veículo mult...</p>		<p>S1978 NO. 0352324</p> <p>SILENT-BLOC DO BRAÇO SUSPENSÃO FRENTE PARTE DE TRÁS</p> <p>OPEL ZAFIRA / ZAFIRA FAMILY B (A05) 1.6 (M75) (De 07.2005 Até 09.2012) 77kW 105cv 1598cm3 Veículo multiuso - OPEL ZAFIRA / ZAFIRA FAMILY B (A05) 1.6 (M75) (De 01.2008 Até 04.2015) 85kW 115cv 1598cm3 Veículo multiuso - OPEL ZAFIRA / ZAFIRA FAMILY B (A05) 1.6 (M75) (De 01.2008 Até 04.2015) 85kW 115cv 1598cm3 Veículo multiuso - OPEL ZAFIRA / ZAFIRA FAMILY B (A05) 1.6 CNG (M75) (De 07.2005 Até 04.2015) 69kW 94cv 1598cm3 Veículo multiuso - OPEL ZAFIRA / ZAFIRA FAMILY B (A05) 1.6 CNG Turbo (M75) (De 04.2010 At...</p>
	<p>S1978 NO. 0352324</p> <p>SILENT-BLOC DO BRAÇO SUSPENSÃO FRENTE PARTE DE TRÁS</p> <p>OPEL ZAFIRA A Veículo multiuso (T98) 1.6 (F75) (De 10.2003 Até 06.2005) 76kW 103cv 1598cm3 Veículo multiuso - OPEL ZAFIRA A Veículo multiuso (T98) 1.6 (F75) (De 10.2003 Até 06.2005) 76kW 103cv 1598cm3 Veículo multiuso - OPEL ZAFIRA A Veículo multiuso (T98) 1.6 16V (F75) (De 04.1999 Até 06.2005) 74kW 101cv 1598cm3 Veículo multiuso - OPEL ZAFIRA A Veículo multiuso (T98) 1.6 16V (F75) (De 04.1999 Até 06.2005) 74kW 101cv 1598cm3 Veículo multiuso - OPEL ZAFIRA A Veículo multiuso (T98) 1.6 16V (F75) (De 04.1999 Até...</p>		<p>S1990 NO. 0402952 - 13110418 - 13267215 - 13267216 - 402952 - 5402637 - 5402639</p> <p>SILENT-BLOC DO EIXO DA SUSPENSÃO DE TRÁS DIREITO E ESQUERDO</p> <p>OPEL ZAFIRA / ZAFIRA FAMILY B (A05) 1.6 (M75) (De 07.2005 Até 09.2012) 77kW 105cv 1598cm3 Veículo multiuso - OPEL ZAFIRA / ZAFIRA FAMILY B (A05) 1.6 (M75) (De 01.2008 Até 04.2015) 85kW 115cv 1598cm3 Veículo multiuso - OPEL ZAFIRA / ZAFIRA FAMILY B (A05) 1.6 CNG (M75) (De 07.2005 Até 04.2015) 69kW 94cv 1598cm3 Veículo multiuso - OPEL ZAFIRA / ZAFIRA FAMILY B (A05) 1.6 CNG Turbo (M75) (De 04.2010 At...</p>
	<p>T0645-I NO. 0344417 - 0344417 - 344417 - 90468644</p> <p>BATENTE SUSPENSÃO DA FRENTE</p> <p>OPEL ZAFIRA A (F75_) 1.6 CNG (09.01 A 06.05) 97cv 1598cc Veículo multiuso - OPEL ZAFIRA A (F 75) 1.6 16 V (04.99 A 06.05) 101cv 1598cc Veículo multiuso - OPEL ZAFIRA A (F 75_) 1.8 16 V (04.99 A 09.00) 116cv 1796cc Veículo multiuso - OPEL ZAFIRA A (F 75_) 1.8 16 V (09.00 A 06.05) 125cv 1796cc Veículo multiuso - OPEL ZAFIRA A (F 75_) 2.0 OPC (09.01 A 06.05) 192cv 1998cc Veículo multiuso - OP...</p>		<p>T0739-I NO. 13173321 - 22697919 - 24411014 - 90095608 - 90216605 - 90216613 - 90250393</p> <p>BATENTE APOIO DE SUSPENSÃO TRÁS (GASTA 2 UNIDADES)</p> <p>OPEL ZAFIRA / ZAFIRA FAMILY B (A05) 1.6 (M75) (De 07.2005 Até 09.2012) 77kW 105cv 1598cm3 Veículo multiuso - OPEL ZAFIRA / ZAFIRA FAMILY B (A05) 1.6 (M75) (De 01.2008 Até 04.2015) 85kW 115cv 1598cm3 Veículo multiuso - OPEL ZAFIRA / ZAFIRA FAMILY B (A05) 1.6 CNG (M75) (De 07.2005 Até 04.2015) 69kW 94cv 1598cm3 Veículo multiuso - OPEL ZAFIRA / ZAFIRA FAMILY B (A05) 1.6 CNG Turbo (M75) (De 04.2010 At...</p>
	<p>T0739-I NO. 13173321 - 22697919 - 24411014 - 90095608 - 90216605 - 90216613 - 90250393</p> <p>BATENTE APOIO DE SUSPENSÃO TRÁS (GASTA 2 UNIDADES)</p> <p>OPEL ZAFIRA A Veículo multiuso (T98) 1.6 16V (F75) (De 04.1999 Até 06.2005) 74kW 101cv 1598cm3 Veículo multiuso - OPEL ZAFIRA A Veículo multiuso (T98) 1.6 CNG (F75) (De 09.2001 Até 06.2005) 71kW 97cv 1598cm3 Veículo multiuso - OPEL ZAFIRA A Veículo multiuso (T98) 1.8 16V (F75) (De 04.1999 Até 09.2000) 85kW 116cv 1796cm3 Veículo multiuso - OPEL ZAFIRA A Veículo multiuso (T98) 1.8 16V (F75) (De 09.2000...</p>		<p>T1076 NO. 0350087 - 0350093 - 350087 - 350093 - 9223176</p> <p>BATENTE DA BARRA ESTABILIZADORA FRENTE</p> <p>OPEL ZAFIRA A Veículo multiuso (T98): 1.6 CNG (F75) 09.2001/06.2005 71KW 97CV 1598CC - OPEL ZAFIRA A Veículo multiuso (T98): 1.6 16V (F75) 04.1999/06.2005 74KW 101CV 1598CC - OPEL ZAFIRA A Veículo multiuso (T98): 1.6 (F75) 10.2003/06.2005 76KW 103CV 1598CC - OPEL ZAFIRA A Veículo multiuso (T98): 1.8 16V (F75) 04.1999/09.2000 85KW 116CV 1796CC - OPEL ZAFIRA A Veículo multiuso (T98): 1.8 16V (F75) ...</p>
	<p>T1077 NO. 350140</p> <p>BATENTE DA BARRA ESTABILIZADORA FRENTE</p> <p>OPEL ZAFIRA (APÓS 1999) 1.6 - 1.8 - 2.0 - 2.0 DTI APÓS Y2168371 (BARRA (24mm)</p>		<p>U0314 NO. 0424761</p> <p>ANILHA DA SUSPENSÃO DAS MOLAS DE TRÁS INFERIOR</p> <p>OPEL ZAFIRA A Veículo multiuso (T98) 1.6 (F75) (10.2003 - 06.2005) 76kW 103cv 1598cm3 Veículo multiuso OPEL ZAFIRA A Veículo multiuso (T98) 1.6 16V (F75) (04.1999 - 06.2005) 74kW 101cv 1598cm3 Veículo multiuso OPEL ZAFIRA A Veículo multiuso (T98) 1.6 CNG (F75) (09.2001 - 06.2005) 71kW 97cv 1598cm3 Veículo multiuso OPEL ZAFIRA A Veículo multiuso (T98) 1.8 16V (F75) (04.1999 - 09.2000) 85kW 116cv 17...</p>

	<p>U0314 NO. 0424761</p> <p>ANILHA DA SUSPENSÃO DAS MOLAS DE TRÁS INFERIOR</p> <p>OPEL ZAFIRA B Caixa/monovolume (A05) 1.6 CNG Turbo VAN (M75) (02.2009 - 04.2015) 110kw 150cv 1598cm3 Caixa/monovolume OPEL ZAFIRA B Caixa/monovolume (A05) 1.6 CNG VAN (M75) (07.2005 - 04.2015) 69kw 94cv 1598cm3 Caixa/monovolume OPEL ZAFIRA B Caixa/monovolume (A05) 1.7 CDTi VAN (M75) (01.2008 - 04.2015) 92kw 125cv 1686cm3 Caixa/monovolume OPEL ZAFIRA B Caixa/monovolume (A05) 1.7 CDTi VAN (M75) (01....</p> <p>d132x22mm 1f-d33mm</p>		<p>U0314 NO. 0424761</p> <p>ANILHA DA SUSPENSÃO DAS MOLAS DE TRÁS INFERIOR</p> <p>OPEL ZAFIRA TOURER C (P12) 1.6 (75) (12.2012 -) 125kw 170cv 1598cm3 Veículo multiuso OPEL ZAFIRA TOURER C (P12) 2.0 CDTi (75) (10.2011 -) 121kw 165cv 1956cm3 Veículo multiuso</p> <p>d132x22mm 1f-d33mm</p>
	<p>UAP83244 NO. 055565375 - 55565375</p> <p>ANILHA PROTEÇÃO TÉRMICA INJECTORES</p> <p>OPEL ZAFIRA TOURER C (P12) 2.0 CDTi (75) (De 01-2015 Até .1-20 -) 125kW 170CV 1956cc Veículo multiuso</p> <p>d15x2mm 1f-d7mm</p>		<p>UCRZ1055 NO. 0905000 - 0905005 - 0905009 - 5905104</p> <p>CRUZETA VEIO DIREÇÃO D16X39MM</p> <p>OPEL ZAFIRA TOURER C (P12) 1.6 (75) (De 12.2012 -) 125kW 170cv 1598cm3 Veículo multiuso - OPEL ZAFIRA TOURER C (P12) 2.0 CDTi (75) (De 10.2011 -) 121kW 165cv 1956cm3 Veículo multiuso -</p> <p>d16x28x41mm</p>
	<p>UCRZ1057 NO. 0905122</p> <p>CRUZETA VEIO DIREÇÃO D15X38MM</p> <p>OPEL ZAFIRA A Veículo multiuso (T98) 1.6 (F75) (De 10.2003 Até 06.2005) 76kW 103cv 1598cm3 Veículo multiuso - OPEL ZAFIRA A Veículo multiuso (T98) 1.6 16V (F75) (De 04.1999 Até 06.2005) 74kW 101cv 1598cm3 Veículo multiuso - OPEL ZAFIRA A Veículo multiuso (T98) 1.6 CNG (F75) (De 09.2001 Até 06.2005) 71kW 97cv 1598cm3 Veículo multiuso - OPEL ZAFIRA A Veículo multiuso (T98) 1.8 16V (F75) (De 04.1999 ...</p> <p>d15x28x41mm</p>		<p>UMB84011 NO. 031126</p> <p>TAMPÃO BLOCO MOTOR</p> <p>OPEL ZAFIRA A Veículo multiuso (T98) 1.6 CNG (F75) (De 09-2001 Até 06-2005) 71kW 97CV 1598cc Veículo multiuso OPEL ZAFIRA A Veículo multiuso (T98) 1.6 16V (F75) (De 04-1999 Até 06-2005) 74kW 101CV 1598cc Veículo multiuso OPEL ZAFIRA B (A05) 1.6 CNG (M75) (De 01-2006 Até ...) 69kW 94CV 1598cc Veículo multiuso</p> <p>d-18x8mm di-16mm</p>
	<p>UMB84011L NO. 11062402 - 2060675</p> <p>TAMPÃO BLOCO DE MOTOR (RELAS)</p> <p>OPEL ZAFIRA A Veículo multiuso (T98) 1.6 CNG (F75) (De 09-2001 Até 06-2005) 71kW 97CV 1598cc Veículo multiuso OPEL ZAFIRA A Veículo multiuso (T98) 1.6 16V (F75) (De 04-1999 Até 06-2005) 74kW 101CV 1598cc Veículo multiuso OPEL ZAFIRA B (A05) 1.6 CNG (M75) (De 01-2006 Até ...) 69kW 94CV 1598cc Veículo multiuso</p> <p>d-18x8mm di-16mm</p>		<p>UMB84019 NO. 2060668</p> <p>TAMPÃO BLOCO MOTOR</p> <p>OPEL ZAFIRA A Veículo multiuso (T98) 1.6 CNG (F75) (De 09-2001 Até 06-2005) 71kW 97CV 1598cc Veículo multiuso OPEL ZAFIRA A Veículo multiuso (T98) 1.6 16V (F75) (De 04-1999 Até 06-2005) 74kW 101CV 1598cc Veículo multiuso OPEL ZAFIRA A Veículo multiuso (T98) 1.8 16V (F75) (De 04-1999 Até 09-2000) 85kW 116CV 1796cc Veículo multiuso OPEL ZAFIRA A Veículo multiuso (T98) 1.8 16V (F75) (De 09-2000 At...</p> <p>d-26x9,5mm di-23,3mm</p>
	<p>UMB84019L NO. 2060668</p> <p>TAMPÃO BLOCO DE MOTOR (RELAS)</p> <p>OPEL ZAFIRA A Veículo multiuso (T98) 1.6 CNG (F75) (De 09-2001 Até 06-2005) 71kW 97CV 1598cc Veículo multiuso OPEL ZAFIRA A Veículo multiuso (T98) 1.6 16V (F75) (De 04-1999 Até 06-2005) 74kW 101CV 1598cc Veículo multiuso OPEL ZAFIRA A Veículo multiuso (T98) 1.8 16V (F75) (De 04-1999 Até 09-2000) 85kW 116CV 1796cc Veículo multiuso OPEL ZAFIRA A Veículo multiuso (T98) 1.8 16V (F75) (De 09-2000 Até 0...</p> <p>d-26x9,5mm di-23,3mm</p>		<p>UMB84021 NO. 2060673</p> <p>TAMPÃO BLOCO MOTOR</p> <p>OPEL ZAFIRA A Veículo multiuso (T98) 1.6 CNG (F75) (De 09-2001 Até 06-2005) 71kW 97CV 1598cc Veículo multiuso OPEL ZAFIRA A Veículo multiuso (T98) 1.6 16V (F75) (De 04-1999 Até 06-2005) 74kW 101CV 1598cc Veículo multiuso OPEL ZAFIRA B (A05) 1.6 CNG (M75) (De 01-2006 Até ...) 69kW 94CV 1598cc Veículo multiuso</p> <p>d-28x7mm di-25,6mm</p>
	<p>UMB84021L NO. 2060673</p> <p>TAMPÃO BLOCO DE MOTOR (RELAS)</p> <p>OPEL ZAFIRA A Veículo multiuso (T98) 1.6 CNG (F75) (De 09-2001 Até 06-2005) 71kW 97CV 1598cc Veículo multiuso OPEL ZAFIRA A Veículo multiuso (T98) 1.6 16V (F75) (De 04-1999 Até 06-2005) 74kW 101CV 1598cc Veículo multiuso OPEL ZAFIRA B (A05) 1.6 CNG (M75) (De 01-2006 Até ...) 69kW 94CV 1598cc Veículo multiuso</p> <p>d-28x7mm di-25,6mm</p>		<p>UMB84026L NO. 11056093 - 2060665</p> <p>TAMPÃO BLOCO DE MOTOR (RELAS)</p> <p>OPEL ZAFIRA</p> <p>d-34x13mm di-31,2mm</p>
	<p>UMB84029 NO. 2060946</p> <p>TAMPÃO BLOCO MOTOR</p> <p>OPEL ZAFIRA B (A05) 1.6 CNG (M75) (07.05 A 04.15) 94cv 1598cc Veículo multiuso - OPEL ZAFIRA B Van (A05) 1.6 CNG Turbo (M75) (02.09 A 04.15) 150cv 1598cc Caixa</p> <p>d36x10mm di-32mm</p>		<p>UMB84029 NO. 2060946</p> <p>TAMPÃO BLOCO MOTOR</p> <p>OPEL ZAFIRA TOURt orER C (P12) 1.6 CNG (75) (A Partir de 10.11) 150cv 1598cc Veículo multiuso - OPEL ZAFIRA TOURER C (P12) 1.8 (75) (A Partir de 10.11) 140cv 1796cc Veículo multiuso</p> <p>d36x10mm di-32mm</p>
	<p>UMV25270 NO. 96738472XJ</p> <p>MANETE PUNHO TOPO ALAVANCA MUDANÇAS PSA 6 VELOCIDADES</p> <p>OPEL ZAFIRA LIFE Autocarro (K0) 1.5 desde 03.2019 75KW 102CV 1499CC D 15 DT (DV5RUCD) 3003BAE 3003BAW - OPEL ZAFIRA LIFE Autocarro (K0) 1.5 desde 03.2019 88KW 120CV 1499CC D 15 DTH (DV5RUC) 3003BAF 3003BAX - OPEL ZAFIRA LIFE Autocarro (K0) 2.0 desde 03.2019 110KW 150CV 1997CC D 20 DTH (DW10FD) 3003BAZ 3003BAH - OPEL ZAFIRA LIFE Autocarro (K0) 2.0 desde 03.2019 130KW 177CV 1997CC D 20 DTR (DW10FDCU...</p> <p>50x54x45mm 1f-d12mm</p>		<p>UMV25276 NO. 96738472VV</p> <p>MANETE PUNHO TOPO ALAVANCA MUDANÇAS PSA 6 VELOCIDADES</p> <p>OPEL VIVARO C Platform Cabin (K0) 2.0 desde 03.2019 90KW 122CV 1997CC D 20 DTL (DW10FE) - OPEL VIVARO C Platform Cabin (K0) 2.0 desde 03.2019 110KW 150CV 1997CC D 20 DTH (DW10FD) - OPEL VIVARO C Platform Cabin (K0) 2.0 desde 04.2023 106KW 144CV 1997CC DW10FDDU340 - OPEL VIVARO C Platform Cabin (K0) VIVARO-E 09.2020/03.2024 100KW 136CV ZXK (ZK01)</p> <p>50x54x47mm 1f-d12mm</p>

	<p>UTR0800 NO. 1304654 - 1304659 - 1304660 - 1304661 - 1304665 - 1304666 - 1304667 - 1304853 - 5951554 - 90352470 ...</p> <p>TAMPÃO RESERVATÓRIO LIQUIDO REFRIGERAÇÃO</p> <p>OPEL ZAFIRA A (F75_) 1.6 CNG (09.01 A 06.05) 97cv 1598cc Veículo multiuso OPEL ZAFIRA A (F75_) 1.6 16V (04.99 A 06.05) 101cv 1598cc Veículo multiuso - OPEL ZAFIRA A (F75_) 1.8 16V (04.99 A 09.00) 116cv 1796cc Veículo multiuso - OPEL ZAFIRA A (F75_) 1.8 16V (09.00 A 06.05) 125cv 1796cc Veículo multiuso - OPEL ZAFIRA A (F75_) 2.0 OPC (09.01 A 06.05) 192cv 1998cc Veículo multiuso - OPEL ZAFI...</p> <p>d62x25mm 1f-d53x14mm</p>		<p>UTR0811 NO. 1304659 - 1304660 - 1304661 - 1304665 - 1304666 - 1304853 - 4395513 - 90352470 - 90409256 - 90409257...</p> <p>TAMPÃO RESERVATÓRIO LIQUIDO REFRIGERAÇÃO</p> <p>OPEL ZAFIRA A 1.6 16V (04.99 A 06.05) 101cv 1598cc Veículo multiuso</p> <p>60x25mm 1f-d52x14mm</p>
	<p>UTR0817 NO. 21430-AX300 - 21430-AX600 - 21430AX30A - 4408066 - 7700805131 - 8200048024 - 91166192</p> <p>TAMPÃO RESERVATÓRIO LIQUIDO REFRIGERAÇÃO</p> <p>OPEL ZAFIRA B (A05) 2.0 (A Partir de 01.06) 241cv 1998cc Veículo multiuso</p> <p>53x36mm 1f-d46x18mm</p>		<p>UTR0820 NO. 90352470 - 90409256 - 90409257 - 9041032690497472 - 90467473</p> <p>TAMPÃO RESERVATÓRIO LIQUIDO REFRIGERAÇÃO</p> <p>OPEL ZAFIRA A (F75_) 1.6 CNG (09.01 A 06.05) 97cv 1598cc Veículo multiuso - OPEL ZAFIRA A (F75_) 1.6 16V (04.99 A 06.05) 101cc 1598 - Veículo multiuso OPEL ZAFIRA A (F75_) 1.8 16V (04.99 A 09.00) 116cv 1796cc Veículo multiuso - OPEL ZAFIRA A (F75_) 1.8 16V (09.00 A 06.05) 125cv 1796cc Veículo multiuso - OPEL ZAFIRA A (F75_) 2.0 OPC (09.01 A 06.05) 192cv 1998cc Veículo multiuso 13 / 13 ...</p> <p>d62x23mm 1f-d53x12mm</p>
	<p>UTR0821 NO. 1304677 - 9202799</p> <p>TAMPÃO RESERVATÓRIO LIQUIDO REFRIGERAÇÃO</p> <p>OPEL ZAFIRA B (A05) 1.6 CNG (A Partir de 01.06) 94cv 1598cc Veículo multiuso - OPEL ZAFIRA B (A05) 1.6 (A Partir de 07.05) 105cv 1598cc Veículo multiuso - OPEL ZAFIRA B (A05) 1.6 (A Partir de 01.08) 115cv 1598cc Veículo multiuso - OPEL ZAFIRA B (A05) 1.6 CNG Turbo (A Partir de 02.09) 150cv 1598cc Veículo multiuso - OPEL ZAFIRA B (A05) 1.8 (A Partir de 06.13) 120cv 1796cc Veículo multiuso ...</p> <p>61x35mm 1f-d52x15mm</p>		<p>UTR0856 NO. 1305248 - 13502353</p> <p>TAMPÃO RESERVATÓRIO LIQUIDO REFRIGERAÇÃO</p> <p>OPEL ZAFIRA TOURER C (P12) 1.4 (A Partir de 10.11) 120cv 1364cc Veículo multiuso - OPEL ZAFIRA TOURER C (P12) 1.4 (A Partir de 10.11) 140cv 1364cc Veículo multiuso - OPEL ZAFIRA TOURER C (P12) 1.4 LPG (A Partir de 10.11) 140cv 1364cc Veículo multiuso - OPEL ZAFIRA TOURER C (P12) 1.6 CNG (A Partir de 10.11) 150cv 1598cc Veículo multiuso - OPEL ZAFIRA TOURER C (P12) 1.6 SIDI (A Partir de 12....</p> <p>65x35mm 1f-d52x10mm</p>
	<p>UTR0856 NO. 1305248 - 13502353</p> <p>TAMPÃO RESERVATÓRIO LIQUIDO REFRIGERAÇÃO</p> <p>OPEL ZAFIRA B (A05) 1.8 (M75) (De 06-2013 Até .1-20 -) 88kW 120CV 1796cc Veículo multiuso OPEL ZAFIRA TOURER C (P12) 1.4 (75) (De 10-2011 Até .1-20 -) 88kW 120CV 1364cc Veículo multiuso OPEL ZAFIRA TOURER C (P12) 1.4 (75) (De 10-2011 Até .1-20 -) 103kW 140CV 1364cc Veículo multiuso OPEL ZAFIRA TOURER C (P12) 1.4 LPG (75) (De 10-2011 Até .1-20 -) 103kW 140CV 1364cc Veículo multiuso OPEL ZAFIRA ...</p> <p>65x35mm 1f-d52x10mm</p>		<p>UTR0856 NO. 13502353</p> <p>TAMPÃO RESERVATÓRIO LIQUIDO REFRIGERAÇÃO</p> <p>VAUXHALL ZAFIRA Mk III (P12) 1.6 CDTi (De 03-2013 Até .1-20 -) 100kW 136CV 1598cc Veículo multiuso</p> <p>65x35mm 1f-d52x10mm</p>
	<p>UTR0862 NO. 1305248 - 13502353</p> <p>TAMPÃO RESERVATÓRIO LIQUIDO REFRIGERAÇÃO</p> <p>OPEL ZAFIRA B (A05) 1.8 (M75) (De 06-2013 Até 04-2015) 88kW 120CV 1796cc Veículo multiuso OPEL ZAFIRA TOURER C (P12) 1.4 (75) (De 10-2011 Até .1-20 -) 88kW 120CV 1364cc Veículo multiuso OPEL ZAFIRA TOURER C (P12) 1.4 (75) (De 10-2011 Até .1-20 -) 103kW 140CV 1364cc Veículo multiuso OPEL ZAFIRA TOURER C (P12) 1.4 LPG (75) (De 10-2011 Até .1-20 -) 103kW 140CV 1364cc Veículo multiuso OPEL ZAFIRA...</p> <p>d65x35mm d48x15mm 1p-d39x32mm</p>		<p>UTR1202 NO. 13118170 - 6450562</p> <p>TAMPÃO RESERVATÓRIO LAVA VIDROS</p> <p>OPEL ZAFIRA / ZAFIRA FAMILY B (A05): 1.6 (M75) 07.2005/09.2012 77KW 105CV 1598CC - OPEL ZAFIRA / ZAFIRA FAMILY B (A05): 1.6 (M75) 01.2008/04.2015 85KW 115CV 1598CC - OPEL ZAFIRA / ZAFIRA FAMILY B (A05): 1.8 (M75) 07.2005/04.2015 103KW 140CV 1796CC</p> <p>50x35x7mm c133mm di-43x29mm</p>
	<p>UTR1300 NO. 00650090 - 05650831</p> <p>TAMPÃO RESERVATÓRIO DO OLEO</p> <p>OPEL ZAFIRA B (A05) 1.6 (M75) (De 07-2005 Até 09-2012) 77kW 105CV 1598cc Veículo multiuso OPEL ZAFIRA B (A05) 1.8 (M75) (De 07-2005 Até 04-2015) 103kW 140CV 1796cc Veículo multiuso</p> <p>d59x31mm d45x12mm</p>		<p>UTR1300 NO. 00650090 - 05650831</p> <p>TAMPÃO RESERVATÓRIO DO OLEO</p> <p>OPEL ZAFIRA TOURER C (P12) 1.4 (75) (De 10-2011 Até .1-20 -) 103kW 140CV 1364cc Veículo multiuso</p> <p>d59x31mm d45x12mm</p>
	<p>UTR1305 NO. 0650089 - 650089</p> <p>TAMPÃO DO RESERVATÓRIO ÓLEO</p> <p>OPEL SINTRA (APV) 2.2 DTI (07.1997 -04.1999) 85kw 116cv 2171cm3 Veículo multiuso OPEL SINTRA (APV) 2.2 i 16V (OUN16, Y94) (11.1996 -04.1999) 104kw 141cv 2198cm3 Veículo multiuso OPEL SINTRA (APV) 3.0 i 24V (OUN16, Y94) (11.1996 -04.1999) 148kw 201cv 2962cm3 Veículo multiuso</p> <p>d61x23mm d32x19mm</p>		<p>UTR1305 NO. 0650089 - 650089</p> <p>TAMPÃO DO RESERVATÓRIO ÓLEO</p> <p>OPEL ZAFIRA / ZAFIRA FAMILY B (A05) 1.6 (M75) (07.2005 -09.2012) 77kw 105cv 1598cm3 Veículo multiuso OPEL ZAFIRA / ZAFIRA FAMILY B (A05) 1.8 (M75) (07.2005 -04.2015) 103kw 140cv 1796cm3 Veículo multiuso OPEL ZAFIRA / ZAFIRA FAMILY B (A05) 1.9 CDTi (M75) (07.2005 -12.2010) 74kw 100cv 1910cm3 Veículo multiuso OPEL ZAFIRA / ZAFIRA FAMILY B (A05) 1.9 CDTi (M75) (07.2005 -04.2015) 88kw 120cv 1910cm3 Ve...</p> <p>d61x23mm d32x19mm</p>
	<p>UTV83011 NO. 0652475 - 09275631 - 652475 - 652491 - 90409376 - 9275631 - N90288901</p> <p>TAMPÃO VEDAÇÃO BUJÃO</p> <p>OPEL ZAFIRA A Veículo multiuso (T98) 1.6 16V (F75) (De 04-1999 Até 06-2005) 74kW 101CV 1598cc Veículo multiuso</p> <p>19x18mm c12mm d14mm</p>		<p>UTV83019 NO. 0652315 - 0652477 - 652315 - 652477 - 90502556 - 96023264</p> <p>TAMPÃO VEDAÇÃO BUJÃO</p> <p>OPEL ZAFIRA A Veículo multiuso (T98) 1.6 CNG (F75) (De 09-2001 Até 06-2005) 71KW 97CV 1598cc Veículo multiuso OPEL ZAFIRA A Veículo multiuso (T98) 1.6 16V (F75) (De 04-1999 Até 06-2005) 74kW 101CV 1598cc Veículo multiuso OPEL ZAFIRA A Veículo multiuso (T98) 1.8 16V (F75) (De 04-1999 Até 09-2000) 85kW 116CV 1796cc Veículo multiuso OPEL ZAFIRA A Veículo multiuso (T98) 1.8 16V (F75) (De 09-2000 Até...</p> <p>d25x14mm c9mm d13mm</p>

	<p>UTV83019 NO. 0652315 - 0652477 - 652315 - 652477 - 90502556 - 96023264</p> <p>TAMPÃO VEDAÇÃO BUJÃO</p> <p>OPEL ZAFIRA B (A05) 1.6 (M75) (De 07-2005 Até 09-2012) 77kW 105CV 1598cc Veículo multiuso OPEL ZAFIRA B (A05) 1.6 (M75) (De 01-2008 Até 04-2015) 85kW 115CV 1598cc Veículo multiuso OPEL ZAFIRA B (A05) 1.6 CNG Turbo (M75) (De 02-2009 Até 04-2015) 110kW 150CV 1598cc Veículo multiuso OPEL ZAFIRA B (A05) 1.8 (M75) (De 07-2005 Até 04-2015) 103kW 140CV 1796cc Veículo multiuso OPEL ZAFIRA B (A05) 2.0 ...</p> <p>d25x14mm c9mm d13mm</p>		<p>UTV83019 NO. 0652315 - 0652477 - 652315 - 652477 - 90502556 - 96023264</p> <p>TAMPÃO VEDAÇÃO BUJÃO</p> <p>OPEL ZAFIRA TOURER C (P12) 1.4 (75) (De 10-2011 Até .1-20 -) 88kW 120CV 1364cc Veículo multiuso OPEL ZAFIRA TOURER C (P12) 1.4 (75) (De 10-2011 Até .1-20 -) 103kW 140CV 1364cc Veículo multiuso OPEL ZAFIRA TOURER C (P12) 1.4 LPG (75) (De 10-2011 Até .1-20 -) 103kW 140CV 1364cc Veículo multiuso OPEL ZAFIRA TOURER C (P12) 1.6 CNG (75) (De 10-2011 Até .1-20 -) 110kW 150CV 1598cc Veículo multiuso O...</p> <p>d25x14mm c9mm d13mm</p>
	<p>W5051 NO. 0614411 - 09128177 - 09544461 - 55351711 - 5535171169 - 5614415 - 5614437 - 614411 - 614444 - 9...</p> <p>POLIE DA CAMBOTA (6 PISTAS)</p> <p>OPEL ZAFIRA A Veículo multiuso (T98) 2.0 DI 16V (F75) 07.1999/06.2005 60KW 82CV 1995CC X 20 DTL 0035375 - OPEL ZAFIRA A Veículo multiuso (T98) 2.0 DTI 16V (F75) 09.2000/06.2005 74KW 101CV 1995CC Y 20 DTH 0035401 - OPEL ZAFIRA A Veículo multiuso (T98) 2.2 DTI 16V (F75) 01.2002/06.2005 86KW 117CV 2172CC Y 22 DTR 0035498 - OPEL ZAFIRA A Veículo multiuso (T98) 2.2 DTI 16V (F75) 01.2002/06.2005...</p> <p>d153mm d35mm</p>		<p>W5051 NO. 0614411 - 09128177 - 09544461 - 55351711 - 5535171169 - 5614415 - 5614437 - 614411 - 614444 - 955296...</p> <p>POLIE DA CAMBOTA (6 PISTAS)</p> <p>OPEL SINTRA (APV) 2.2 DTI 07.1997/04.1999 85KW 116CV 2171CC X 22 DTH 0039174</p> <p>d153mm d35mm</p>
	<p>W5098 NO. 5614427 - 90531583</p> <p>POLIE DA CAMBOTA (4 PISTAS + 1 PISTA)</p> <p>OPEL ZAFIRA A Veículo multiuso (T98): 2.0 DI 16V (F75) 07.1999/06.2005 60KW 82CV 1995CC</p> <p>d144mm d42mm</p>		<p>W5107 NO. 5614425 - 5614431 - 9129209</p> <p>POLIE DA CAMBOTA (5 PISTAS)</p> <p>OPEL ZAFIRA 1.6 16V X 16 XEL - Z 16 XE 101CV (04-1999 A 06-2005) - 1.6 CNG Z 16 YNG 97CV (09-2001 A 06-2005) - 1.8 16V Z 18 XE 125CV (09-2000 A 06-2005)</p> <p>d160m 1f-d26mm</p>
	<p>W5145 NO. 93178819 - 0614359 - 614359 - 93192547</p> <p>POLIE DA CAMBOTA 6 PISTAS</p> <p>OPEL ZAFIRA B (A05) 1.9 CDTI (APÓS 07.05) 100cv 1910cc Veículo multiuso - OPEL ZAFIRA B (A05) 1.9 CDTI (APÓS 07.05) 120cv 1910cc Veículo multiuso</p> <p>d169mm d30,5mm</p>		<p>W5159 NO. 055575960 - 0614172 - 0614758 - 098022837 - 098039173 - 55575960 - 5614450 - 614172 - 614758 - 98022...</p> <p>POLIE CAMBOTA 6 PISTAS</p> <p>OPEL ZAFIRA / ZAFIRA FAMILY B (A05) 1.7 CDTI (M75) 03.2007/04.2015 92KW 125CV 1686CC A 17 DTR Z 17 DTR 0035A1L - OPEL ZAFIRA / ZAFIRA FAMILY B (A05) 1.7 CDTI (M75) 01.2008/04.2015 81KW 110CV 1686CC Z 17 DTJ A 17 DTJ 0035A1K - OPEL ZAFIRA B Caixa/monovolume (A05) 1.7 CDTI VAN (M75) 01.2008/04.2015 81KW 110CV 1686CC Z 17 DTJ A 17 DTJ 0035AQM 0035ATZ - OPEL ZAFIRA B Caixa/monovolume (A05) 1.7 CDTI VA...</p> <p>d154mm d48mm</p>
	<p>W5166 NO. 0614584 - 55564573 - 614584</p> <p>POLIE DA CAMBOTA (6 PISTAS)</p> <p>OPEL ZAFIRA / ZAFIRA FAMILY B (A05) 1.9 CDTI (M75) 07.2005/04.2015 110KW 150CV 1910CC Z 19 DTH 0035AEN 0035106</p> <p>d165mm d30mm</p>		<p>Y3212 NO. 1008501 - 1008504 - 4709077</p> <p>PARAFUSO PERNO RODA CHAVE 17 M12X1,50X48MM (BASE CONICA PARA JANTES AÇO E LIGA LEVE)</p> <p>OPEL ZAFIRA / ZAFIRA FAMILY B (A05) 1.6 (M75) (07.2005 - 09.2012) 77kw 105cv 1598cm3 Veículo multiuso OPEL ZAFIRA / ZAFIRA FAMILY B (A05) 1.6 (M75) (01.2008 - 04.2015) 85kw 115cv 1598cm3 Veículo multiuso OPEL ZAFIRA / ZAFIRA FAMILY B (A05) 1.6 CNG (M75) (07.2005 - 04.2015) 69kw 94cv 1598cm3 Veículo multiuso OPEL ZAFIRA / ZAFIRA FAMILY B (A05) 1.6 CNG Turbo (M75) (04.2010 - 04.2015) 110kw 150cv 159...</p> <p>C48mm (Ch-17mm) M12x1,50x22mm</p>
	<p>Y3212 NO. 1008501 - 1008504 - 4709077</p> <p>PARAFUSO PERNO RODA CHAVE 17 M12X1,50X48MM (BASE CONICA PARA JANTES AÇO E LIGA LEVE)</p> <p>OPEL ZAFIRA A Veículo multiuso (T98) 1.6 16V (F75) (04.1999 - 06.2005) 74kw 101cv 1598cm3 Veículo multiuso OPEL ZAFIRA A Veículo multiuso (T98) 1.6 CNG (F75) (09.2001 - 06.2005) 71kw 97cv 1598cm3 Veículo multiuso OPEL ZAFIRA A Veículo multiuso (T98) 1.8 16V (F75) (04.1999 - 09.2000) 85kw 116cv 1796cm3 Veículo multiuso OPEL ZAFIRA A Veículo multiuso (T98) 1.8 16V (F75) (09.2000 - 06.2005) 92kw 125c...</p> <p>C48mm (Ch-17mm) M12x1,50x22mm</p>		<p>Y3218 NO. 9818845080</p> <p>PARAFUSO PERNO RODA CHAVE 17 M12X1,25X48MM (BASE CONICA PARA JANTES DE AÇO E LIGA LEVE)</p> <p>OPEL ZAFIRA LIFE Autocarro (K0) 1.5 (03.2019 -) 75kw 102cv 1499cm3 Autocarro OPEL ZAFIRA LIFE Autocarro (K0) 1.5 (03.2019 -) 88kw 120cv 1499cm3 Autocarro OPEL ZAFIRA LIFE Autocarro (K0) 2.0 (08.2019 -) 90kw 122cv 1997cm3 Autocarro OPEL ZAFIRA LIFE Autocarro (K0) 2.0 (03.2019 -) 110kw 150cv 1997cm3 Autocarro OPEL ZAFIRA LIFE Autocarro (K0) 2.0 (03.2019 -) 130kw 177cv 1997cm3 Autocarro OPEL ZAFIRA L...</p> <p>C48mm (Ch-17mm) M12x1,25x24mm</p>
	<p>Y3227 NO. 0328004 - 09595179 - 09599302 - 11611063 - 15651585 - 9595179</p> <p>PARAFUSO DA RODA CAVILHA</p> <p>OPEL ZAFIRA TOURER C (P12) 1.6 (75) (12.2012 -) 125kw 170cv 1598cm3 Veículo multiuso OPEL ZAFIRA TOURER C (P12) 2.0 CDTi (75) (10.2011 -) 121kw 165cv 1956cm3 Veículo multiuso</p> <p>c56mm M12x1mm</p>		<p>Z50130 NO. 4811301 - YQ00159480</p> <p>MOLA REBITE FIXAÇÃO</p> <p>OPEL ZAFIRA TOURER C (P12) 1.4 (75) (10.2011 -) 88kw 120cv 1364cm3 Veículo multiuso OPEL ZAFIRA TOURER C (P12) 1.4 (75) (10.2011 -) 103kw 140cv 1364cm3 Veículo multiuso OPEL ZAFIRA TOURER C (P12) 1.4 LPG (75) (10.2011 -) 103kw 140cv 1364cm3 Veículo multiuso OPEL ZAFIRA TOURER C (P12) 1.6 (75) (09.2018 - 07.2019) 100kw 136cv 1598cm3 Veículo multiuso OPEL ZAFIRA TOURER C (P12) 1.6 (75) (12.2012 -) 1...</p> <p>d6x 18mm f-d17mm</p>
	<p>Z50130 NO. 4811301 - YQ00159480</p> <p>MOLA REBITE FIXAÇÃO</p> <p>OPEL ZAFIRA TOURER C VAN (P12) 2.0 CDTi (75) (01.2013 -) 81kw 110cv 1956cm3 Caixa/monovolume OPEL ZAFIRA TOURER C VAN (P12) 2.0 CDTi (75) (01.2012 -) 96kw 131cv 1956cm3 Caixa/monovolume OPEL ZAFIRA TOURER C VAN (P12) 2.0 CDTi (75) (01.2013 -) 121kw 165cv 1956cm3 Caixa/monovolume</p> <p>d6x 18mm f-d17mm</p>		<p>Z55280 NO. 2228839</p> <p>MOLA PAINEL REVESTIMENTO DAS PORTAS</p> <p>OPEL ZAFIRA / ZAFIRA FAMILY B (A05) 1.6 (M75) 07.2005/09.2012 77KW 105CV 1598CC Z 16 XE1 Z 16 XEP 0035AEO 0035100 - OPEL ZAFIRA / ZAFIRA FAMILY B (A05) 1.6 (M75) 01.2008/04.2015 85KW 115CV 1598CC A 16 XER Z 16 XER 0035AJU - OPEL ZAFIRA / ZAFIRA FAMILY B (A05) 1.6 CNG (M75) 07.2005/04.2015 69KW 94CV 1598CC Z 16 YNG 0035AFA 0035ANS - OPEL ZAFIRA / ZAFIRA FAMILY B (A05) 1.6 CNG Turbo (M75) 04.2010/04...</p> <p>F-G-mm T-27L-18H-12S-5mm</p>

	<p>Z55280 NO. 2228839</p> <p>MOLA PAINEL REVESTIMENTO DAS PORTAS</p> <p>OPEL ZAFIRA TOURER C (P12) 1.4 (75) desde 10.2011 88KW 120CV 1364CC B 14 NEL A 14 NEL 0035AWB 0035ASZ 0035ATA 1844AFU 1844AFV - OPEL ZAFIRA TOURER C (P12) 1.4 (75) desde 10.2011 103KW 140CV 1364CC B 14 NET A 14 NET 0035ATB 0035ATC 1844AFW 1844AFX - OPEL ZAFIRA TOURER C (P12) 1.4 LPG (75) desde 10.2011 103KW 140CV 1364CC B 14 NET A 14 NET 0035ATD 0035ATE 1844AFZ - OPEL ZAFIRA TOURER C (P12) 1844AFY...</p> <p>F-G-mm T-27L-18H-12S-5mm</p>		<p>Z57101 NO. 13252119</p> <p>MOLA DO PAINEL DA PORTA</p> <p>OPEL ZAFIRA (A partir de 2012)</p> <p>F9mm T17mm L15mm H20mm S1-6mm</p>
	<p>Z71500 NO. 13252118</p> <p>MOLA DO PAINEL DA PORTA</p> <p>OPEL ZAFIRA (A partir de 2012)</p> <p>F9mm T17mm L14mm H20mm S1-7mm</p>		<p>Z80792 NO. 174864</p> <p>Mola de painel</p> <p>OPEL ZAFIRA</p> <p>d17.6x18.8mm 1p-d8.5-14.5mm</p>
	<p>Z80846 NO. 1104881 - 1104882 - 90450482</p> <p>Rebite</p> <p>OPEL ZAFIRA B (Após 2005)</p> <p>d19x29mm 1p-d8-15.2mm</p>		<p>Z9011 NO. 1261479 - 1449282600 - 4709339 - 4711509 - 854880</p> <p>MOLA DE ESCAPE</p> <p>OPEL ZAFIRA</p> <p>d23x42mm</p>