

	<p><b>A1592</b> NO. 36499KOM - M4C3007COM</p> <p>APOIO DA TRANSMISSÃO</p> <p>FORD</p> <p>195x105x75mm 1f-d30mm</p>		<p><b>F1088-I</b> NO. 175422831 - 191422831 - 1H0422831</p> <p>FOLE DA DIREÇÃO</p> <p>FORD AMERICA F2</p> <p>d60x195mm 1f-d45mm 1f-d10mm</p>
	<p><b>H507</b> NO.</p> <p>PALA PVC</p> <p>FORD</p> <p>332x210x4mm</p>		<p><b>H813</b> NO.</p> <p>PALA MEIA LUA GRANDE</p> <p>FORD</p> <p>510x226x5mm</p>
	<p><b>H854</b> NO.</p> <p>PALA MEIA LUA PEQUENA</p> <p>FORD</p> <p>496x195x5mm 5 fixações</p>		<p><b>H924</b> NO.</p> <p>PALA JEEP/PICK-UP</p> <p>FORD</p> <p>490x310x4mm</p>
	<p><b>L0014</b> NO.</p> <p>CASQUILHO DE AMORTECEDORES (CÔNICOS)</p> <p>FORD</p> <p>d30x19mm d26mm 1f-d16mm</p>		<p><b>M6089</b> NO. 3250969 - 3846629</p> <p>JUNTA DE ESCAPE</p> <p>FORD ECONOVAN (APÓS 1995)</p> <p>108x68x1.5mm 1f-d58mm</p>
	<p><b>S1034</b> NO. 6146142 - 81DB5348AA</p> <p>SILENT-BLOC DE MOLAS</p> <p>FORD CARGO</p> <p>d51x78mm c76mm 1f-d20mm</p>		<p><b>UMV25711</b> NO. 8L0711184</p> <p>MANETE PUNHO TOPO ALAVANCA MUDANÇAS VAG 6 VELOCIDADES F15MM</p> <p>FORD - ADPATAVEL TODOS MODELOS COM HASTE 12mm</p> <p>110x51x38mm 1pino-d15mm</p>
	<p><b>UPCR5010</b> NO. 4634411 - 6L2Z1012BA - DE9Z-1012-A - F4TZ-1012-B - ZZL1-37-161A - ZZL1-37-161B - ZMZ2-26-161</p> <p>PORCA DA RODA CHAVE 21 M12X1,5X41MM ( BASE CONICA )</p> <p>FORD USA AEROSTAR 3.0 i V6 (09.1985 - 12.1997) 108kw 147cv 2986cm3 Veiculo multiuso FORD USA AEROSTAR 4.0 i V6 4WD (09.1989 - 12.1997) 115kw 156cv 3996cm3 Veiculo multiuso</p> <p>d23x41mm M12x36mm</p>		<p><b>UPCR5010</b> NO. 4634411 - 6L2Z1012BA</p> <p>PORCA DA RODA CHAVE 21 M12X1,5X41MM ( BASE CONICA )</p> <p>FORD USA BRONCO II 2.9 i V6 4x4 (09.1985 - 08.1990) 104kw 141cv 2935cm3 SUV</p> <p>d23x41mm M12x36mm</p>
	<p><b>UPCR5010</b> NO. 4634411 - 6L2Z1012BA</p> <p>PORCA DA RODA CHAVE 21 M12X1,5X41MM ( BASE CONICA )</p> <p>FORD USA EXPLORER (U2, U_) 4.0 (10.1999 - 08.2002) 150kw 204cv 3996cm3 SUV FORD USA EXPLORER (U2, U_) 4.0 (09.1996 - 08.2002) 152kw 207cv 4011cm3 SUV FORD USA EXPLORER (U2, U_) 4.0 4WD (09.1998 - 12.2001) 157kw 214cv 3996cm3 SUV FORD USA EXPLORER (U2, U_) 4.9 4WD (01.1996 - 12.2001) 157kw 213cv 4942cm3 SUV FORD USA EXPLORER (U5_) 3.5 (10.2010 -) 216kw 294cv 3496cm3 SUV FORD USA EXPLORER (U5_) 3.5 ...</p> <p>d23x41mm M12x36mm</p>		<p><b>UPCR5020</b> NO. 1377747 - 1382841 - 1428137 - 1676176 - 5196786 - 5275544</p> <p>PORCA DA RODA CHAVE 21 M14X1,5X34MM ( BASE CONICA )</p> <p>FORD USA EDGE 2.0 EcoBlue (08.2018 -) 110kw 150cv 1995cm3 SUV FORD USA EDGE 2.0 EcoBlue AWD (08.2018 -) 140kw 190cv 1995cm3 SUV FORD USA EDGE 2.0 EcoBlue AWD (08.2018 -) 175kw 238cv 1995cm3 SUV FORD USA EDGE 2.0 TDCi AWD (08.2015 - 07.2018) 132kw 180cv 1997cm3 SUV FORD USA EDGE 2.0 TDCi Bi-Turbo AWD (08.2015 - 07.2018) 154kw 210cv 1997cm3 SUV</p> <p>d28x34mm M14x32mm</p>
	<p><b>UPCR5020</b> NO. 1377747 - 1382841 - 1428137 - 1676176 - 5196786 - 5275544</p> <p>PORCA DA RODA CHAVE 21 M14X1,5X34MM ( BASE CONICA )</p> <p>FORD USA MUSTANG Convertible 2.3 EcoBoost (09.2017 -) 213kw 290cv 2261cm3 Cabriolet FORD USA MUSTANG Convertible 2.3 EcoBoost (12.2014 -) 228kw 310cv 2261cm3 Cabriolet FORD USA MUSTANG Convertible 2.3 EcoBoost (01.2015 -) 231kw 314cv 2264cm3 Cabriolet FORD USA MUSTANG Convertible 2.3 EcoBoost (07.2015 -) 233kw 317cv 2261cm3 Cabriolet FORD USA MUSTANG Convertible 5.0 (09.2010 -) 307kw 418cv 4952cm3...</p> <p>d28x34mm M14x32mm</p>		<p><b>UTR0919</b> NO. 85702172</p> <p>TAMPÃO DEPOSITO COMBUSTIVEL</p> <p>FORD (455C, 455D, 555C, 555D, 575D, 655C, 655D, 675D)</p> <p>d95x70mm d80x77mm</p>

	<p><b>UTR0950</b> NO. 38004222</p> <p>TAMPÃO DEPÓSITO COMBUSTIVEL</p> <p>TRACTOR FORD New Holland T6020, T6010, T6030, T6040, T6050, T6070, T6080, T7030, T7040, T7050, T7060, TM115, TM120, TM125, TM130, TM135, TM140, TM150, TM155, TM165, TM175, TM180, TM190, TS80, TS90 TS100, TS110, TS115, TS125, TS130, TS135</p> <p>d95x37mm      d64x33mm</p>		<p><b>UTR0951</b> NO. 2400E8100DA - 76896 - 80076896 - 81645535 - 81747955 - 81855444 - 83635904 - 87712918 - 90-7731T1 -</p> <p>TAMPÃO DO RADIADOR</p> <p>TRACTOR FORD</p> <p>d70x21mm      d56/38x23mm</p>
	<p><b>UTR0954</b> NO. 38007338</p> <p>TAMPÃO DEPÓSITO COMBUSTIVEL</p> <p>TRACTOR FORD NEW HOLLAND TL Serie TL100-TL70-TL80-TL90 TN Serie TN55-TN65-TN70-TN75T4000 Serie T4040-T4050 TNA Serie TN60 A-TN70 A-TN75 A-TN85 A-TN95 A</p> <p>d111x34mm      1f-d98x25mm</p>		<p><b>UTR0955</b> NO. 86507190 - 89841626 - 9841626</p> <p>TAMPÃO DEPOSITO REFRIGERAÇÃO</p> <p>TRACTOR FORD 54/151-247</p> <p>d63x21mm      1f-d52x18mm</p>
	<p><b>UTR0956</b> NO. 81874132 - 83971359 - E8NN8C038BA - E8NN8C083BB</p> <p>TAMPÃO DO RADIADOR</p> <p>TRACTOR FORD 5610 - 6610 - 6710 - 7610 - 7810 - 7910 - TS80 - TS90 - TS100 - TS115 - TS120</p> <p>d56x23mm      1f-d50x15mm</p>		<p><b>Z00531</b> NO. 1470998 - 207217563 - N0154322</p> <p>Mola porca rápida</p> <p>FORD (TODOS)</p> <p>24.6x16.2x5.5mm      1f-d6.3mm</p>
	<p><b>Z01561</b> NO. 211837223</p> <p>Mola porca rápida</p> <p>FORD (TODOS)</p> <p>24x11x4mm      1f-d4.2mm</p>		<p><b>Z70107</b> NO. 6103426</p> <p>MOLA DE FIXAÇÃO TIPO PORCA</p> <p>FORD (VÁRIOS MODELOS)</p> <p>d14x 10mm      f-d24mm</p>
	<p><b>Z80219</b> NO.</p> <p>Mola de friso</p> <p>Ford</p> <p>19x15x12.6mm      1p-d4.5-4.5mm</p>		<p><b>Z80459</b> NO. 823867299</p> <p>Mola de painel</p> <p>FORD (TODOS)</p> <p>d18x21.2mm      1p-d7.6-14.2mm</p>
	<p><b>Z80470</b> NO. 6028434 - E642280S</p> <p>Mola de fixação</p> <p>FORD (TODOS)</p> <p>d5x45mm</p>		<p><b>Z80624</b> NO. 7M0883069</p> <p>Mola de painel</p> <p>FORD (TODOS)</p> <p>d20.5x19mm      1p-d8.8-13mm</p>
	<p><b>Z80684</b> NO. 16131176747 - 1800940 - 90127883</p> <p>Mola de retenção</p> <p>FORD (TODOS)</p> <p>d16x10mm      1f-d6mm</p>		<p><b>Z80757</b> NO. 6992H3 - 7703079338 - 96015624</p> <p>Mola de painel</p> <p>FORD (TODOS)</p> <p>47.5x10x45.5mm      1p-d8-9mm</p>



	<p><b>A0355</b> NO. 105E-6038A - 109-6038A - 1710251 - 1710255</p> <p>APOIO DO MOTOR LADO DIREITO E ESQUERDO</p> <p>FORD CAPRI 1.4, 1.5 1961/1964 - FORD CONSUL Classic 1.4,1,5 1961/1964</p> <p>90x86x80mm 6f-d9mm</p>		<p><b>A0355</b> NO. 105E-6038A - 109-6038A - 1710251 - 1710255</p> <p>APOIO DO MOTOR LADO DIREITO E ESQUERDO</p> <p>FORD ANGLIA 105E 1.0 1959/1967 - FORD ANGLIA 123E 1.2 1959/1967 - FORD ANGLIA 7 cwt.Van 307E 1968/1975</p> <p>90x86x80mm 6f-d9mm</p>
	<p><b>A0405</b> NO. 11550756 - 1454274 - 1470480 - 6005152 - 711F.6038.AA</p> <p>APOIO SUPORTE DO MOTOR</p> <p>FORD GRANADA (GGTL, GGFL): 1.7 03.1972/02.1975 48KW 65CV 1699CC - FORD GRANADA (GGTL, GGFL): 1.7 12.1974/08.1977 51KW 70CV 1699CC - FORD GRANADA (GGTL, GGFL): 1.7 03.1972/02.1975 55KW 75CV 1699CC - FORD GRANADA (GGTL, GGFL): 2.0 01.1975/08.1977 66KW 90CV 1998CC - FORD GRANADA (GGTL, GGFL): 2.3 01.1972/02.1976 79KW 108CV 2294CC - FORD GRANADA (GGTL, GGFL): 2.3 01.1975/08.1977 79KW 108CV 2294CC - FO...</p> <p>d75x38mm 1p-d10-23mm 1p-d10-23mm</p>		<p><b>A0960</b> NO. 1454275 - 1515124 - 711F6068AB - 72HF.6068.AB - 72HF6068AA</p> <p>APOIO SUPORTE TRÁS DO MOTOR</p> <p>FORD GRANADA (GGTL, GGFL): 1.7 03.1972/02.1975 48KW 65CV 1699CC - FORD GRANADA (GGTL, GGFL): 1.7 12.1974/08.1977 51KW 70CV 1699CC - FORD GRANADA (GGTL, GGFL): 1.7 03.1972/02.1975 55KW 75CV 1699CC - FORD GRANADA Turnier (GGNL): 1.7 03.1972/02.1975 48KW 65CV 1699CC - FORD GRANADA Turnier (GGNL): 1.7 12.1974/08.1977 51KW 70CV 1699CC - FORD GRANADA Coupé (GGCL): 1.7 03.1972/02.1975 48KW 65CV 1699CC - ...</p> <p>166x97x55mm 1f-d13mm</p>
	<p><b>A1897</b> NO. 1443802 - 1461881 - 1547946 - 1564470 - 3047E-6038A - 78VB6038AA</p> <p>APOIO DO MOTOR</p> <p>FORD GRANADA (GGTL, GGFL): 1.7 03.1972/02.1975 48KW 65CV 1699CC - FORD GRANADA (GGTL, GGFL): 1.7 12.1974/08.1977 51KW 70CV 1699CC - FORD GRANADA (GGTL, GGFL): 1.7 03.1972/02.1975 55KW 75CV 1699CC - FORD GRANADA (GGTL, GGFL): 2.0 01.1975/08.1977 66KW 90CV 1998CC - FORD GRANADA (GGTL, GGFL): 2.3 01.1972/02.1976 79KW 108CV 2294CC - FORD GRANADA (GGTL, GGFL): 2.3 01.1975/08.1977 79KW 108CV 2294CC - FO...</p> <p>d75x46mm 1p-d10x23mm 1p-d10x23mm</p>		<p><b>D0037</b> NO. 1515117 - 1638947 - 6518778 - 83BG4684BA - 83GB4684BA - 88GG4684BA - GAF41</p> <p>CARDAN TRANSMISSÃO</p> <p>FORD GRANADA (GGTL, GGFL) 1.7 (03.72 A 02.75) 75cv 1699cc três volumes - FORD GRANADA (GGTL, GGFL) 2.0 (01.75 A 08.77) 90cv 1998cc três volumes - FORD GRANADA (GGTL, GGFL) 2.3 (01.75 A 08.77) 108cv 2294cc três volumes - FORD GRANADA (GU) 1.6 Ano fabric. a part ir de: 08.82, (07.81 A 08.85) 75cv 1593cc três volumes - FORD GRANADA (GU) 1.7 Ano fabric. até: 08.81, (08.77 A 05.82) 70cv 1699cc...</p> <p>120x135x40x46mm 6f-12x12mm</p>
	<p><b>E0008</b> NO. 0801909 - 1591419 - 6030483 - 70GB5281AA - 801909</p> <p>ESTICADOR DE ESCAPE</p> <p>FORD GRANADA (GU): 1.6 07.1981/08.1985 55KW 75CV 1593CC - FORD GRANADA (GU): 1.7 08.1977/05.1982 51KW 70CV 1699CC - FORD GRANADA (GU): 1.7 08.1977/07.1981 54KW 73CV 1699CC - FORD GRANADA (GU): 2.0 08.1977/08.1985 66KW 90CV 1998CC - FORD GRANADA (GU): 2.0 08.1979/08.1985 74KW 101CV 1993CC - FORD GRANADA (GU): 2.0 08.1981/08.1985 77KW 105CV 1993CC - FORD GRANADA (GU): 2.3 08.1977/06.1979 79KW 107CV ...</p> <p>d44x40mm</p>		<p><b>E0008</b> NO. 0801909 - 1591419 - 6030483 - 70GB5281AA - 801909</p> <p>ESTICADOR DE ESCAPE</p> <p>FORD CAPRI</p> <p>d44x40mm</p>
	<p><b>E0008</b> NO. 0801909 - 1591419 - 6030483 - 70GB5281AA - 801909</p> <p>ESTICADOR DE ESCAPE</p> <p>FORD CONSUL</p> <p>d44x40mm</p>		<p><b>F0456-I</b> NO. 1451308 - 1454203 - 1512346 - 6060790</p> <p>FOLE DA CREMALHEIRA DA DIRECÇÃO DIREITO (F1034)</p> <p>FORD CAPRI TT (excepto 3000)</p> <p>d55x160mm 1f-d33mm 1f-d9mm</p>
	<p><b>F0457-I</b> NO. 1454202 - 1467265 - 6060786</p> <p>FOLE DA CREMALHEIRA DA DIRECÇÃO ESQUERDO (F1035)</p> <p>FORD CAPRI TT (excepto 3000)</p> <p>d55x120mm 1f-d43mm 1f-d9mm</p>		<p><b>F0462-I</b> NO. 1568353 - 1568676</p> <p>FOLE DA CREMALHEIRA DA DIRECÇÃO ESQ. E DIR.</p> <p>FORD CAPRI 3000 (CAM RACK) (69 A 81)</p> <p>d65x150mm 1f-d47mm 1f-d9mm</p>
	<p><b>F0463-I</b> NO. 1568355</p> <p>FOLE DA DIRECÇÃO ESQUERDO</p> <p>FORD CAPRI 3000</p> <p>d62x205mm 1f-d26mm 1f-d10mm</p>		<p><b>F0469-I</b> NO. 1016761 - 1495776 - 1579855</p> <p>FOLE DA TRANSMISSÃO LADO DA CAIXA</p> <p>FORD CONSUL (GGFL): 1700 01.1972/12.1975 48KW 65CV 1699CC - FORD CONSUL (GGFL): 1700 01.1972/12.1975 55KW 75CV 1699CC - FORD CONSUL (GGFL): 2000 01.1972/12.1975 73KW 99CV 1993CC - FORD CONSUL Turnier (GGNL): 1700 01.1972/12.1975 55KW 75CV 1699CC</p> <p>d85x80mm 1f-d61mm 1f-d23mm</p>
	<p><b>F0469-I</b> NO. 1016761 - 1495776 - 1579855</p> <p>FOLE DA TRANSMISSÃO LADO DA CAIXA</p> <p>FORD GRANADA (GGTL, GGFL): 1.7 03.1972/02.1975 48KW 65CV 1699CC - FORD GRANADA (GGTL, GGFL): 2.0 01.1975/08.1977 66KW 90CV 1998CC - FORD GRANADA (GGTL, GGFL): 2.3 01.1972/02.1976 79KW 108CV 2294CC - FORD GRANADA Turnier (GGNL): 1.7 03.1972/02.1975 48KW 65CV 1699CC - FORD GRANADA Turnier (GGNL): 2.0 01.1975/08.1977 66KW 90CV 1998CC - FORD GRANADA Turnier (GGNL): 2.3 01.1972/02.1976 79KW 108CV 2294CC...</p> <p>d85x80mm 1f-d61mm 1f-d23mm</p>		<p><b>F0687-I</b> NO. 1160365 - 1610365 - 6060788 - 83BB3K661AA</p> <p>FOLE DA DIRECÇÃO</p> <p>FORD GRANADA (APÓS 1985)</p> <p>d60x230mm 1f-d48mm 1f-d10mm</p>

	<p><b>F0687-I</b> NO. 1160365 - 1610365 - 6060788 - 83BB3K661AA</p> <p>FOLE DA DIREÇÃO</p> <p>FORD GRANADA (APÓS 1985)</p> <p>d60x230mm 1f-d48mm 1f-d10mm</p>		<p><b>F1027</b> NO. 0440888 - 1649554 - 440888 - 83BG.4846.AA</p> <p>FOLE APOIO SUPORTE REPARAÇÃO TRANSMISSÃO</p> <p>FORD CAPRI I (ECJ): 1300 10.1972/12.1973 40KW 55CV 1297CC - FORD CAPRI I (ECJ): 1300 01.1973/12.1973 43KW 59CV 1297CC - FORD CAPRI I (ECJ): 1300 01.1971/12.1973 39KW 54CV 1298CC - FORD CAPRI I (ECJ): 1300 12.1968/12.1972 37KW 50CV 1305CC - FORD CAPRI I (ECJ): 1300 01.1971/12.1972 39KW 53CV 1305CC - FORD CAPRI I (ECJ): 1500 12.1968/02.1974 44KW 60CV 1498CC - FORD CAPRI I (ECJ): 1500 12.1968/02.1974...</p> <p>d94x62mm 1f-d54mm</p>
	<p><b>F1027</b> NO. 0440888 - 1649554 - 440888 - 83BG.4846.AA</p> <p>FOLE APOIO SUPORTE REPARAÇÃO TRANSMISSÃO</p> <p>FORD GRANADA (GGTL, GGFL): 1.7 03.1972/02.1975 48KW 65CV 1699CC - FORD GRANADA (GGTL, GGFL): 1.7 12.1974/08.1977 51KW 70CV 1699CC - FORD GRANADA (GGTL, GGFL): 1.7 03.1972/02.1975 55KW 75CV 1699CC - FORD GRANADA (GGTL, GGFL): 2.0 01.1975/08.1977 66KW 90CV 1998CC - FORD GRANADA (GGTL, GGFL): 2.3 01.1972/02.1976 79KW 108CV 2294CC - FORD GRANADA (GGTL, GGFL): 2.3 01.1975/08.1977 79KW 108CV 2294CC - FO...</p> <p>d94x62mm 1f-d54mm</p>		<p><b>F4022</b> NO. 1568353</p> <p>FOLE DIREÇÃO ESQUERDO</p> <p>FORD CAPRI 3.0 (1974 A 1977) - FORD CONSUL 3000 (1972 A 1975)</p> <p>d65x140mm 1f-d48mm 1f-d10mm</p>
	<p><b>F4023</b> NO. 1568355</p> <p>FOLE DIREÇÃO DIREITO</p> <p>FORD CAPRI 3.0 (1974 A 1977) - FORD CONSUL 3000 (1972 A 1975)</p> <p>d62x210mm d44mm 1f-d27mm 1f-d10mm</p>		<p><b>L0221</b> NO. 105E-5719 - 1710123</p> <p>CASQUILHO DE MOLAS</p> <p>FORD CAPRI MK I 1300, 1600CC 1968/1973 - FORD CAPRI MK I 1600 08.1972/1973 - FORD CAPRI MK I 2000 AUTOMATIC, 3000 08.1960/1973 - FORD CAPRI MK I 3000 MANUAL 08.1972/1973 - FORD CAPRI MK II, III 1300, 3000 1974/&gt;&gt;&gt; - FORD CAPRI MK II, III 1600, 2000 AUTOMATIC 1974/&gt;&gt;&gt;</p> <p>d24x35mm d20mm 1f-d12mm</p>
	<p><b>L0221</b> NO. 105E-5719 - 1710123</p> <p>CASQUILHO DE MOLAS</p> <p>FORD ANGLIA</p> <p>d24x35mm d20mm 1f-d12mm</p>		<p><b>L0221</b> NO. 105E-5719 - 1710123</p> <p>CASQUILHO DE MOLAS</p> <p>FORD CORSAIR</p> <p>d24x35mm d20mm 1f-d12mm</p>
	<p><b>L0221</b> NO. 105E-5719 - 1710123</p> <p>CASQUILHO DE MOLAS</p> <p>FORD THAMES</p> <p>d24x35mm d20mm 1f-d12mm</p>		<p><b>L0262</b> NO. 1487654</p> <p>CASQUILHO SILENT-BLOCO BRAÇO SUSPENSÃO FRENTE ( GASTA 2 UNIDADES )</p> <p>FORD CAPRI (ECJ): 1300 10.1972/12.1973 40KW 55CV 1297CC - FORD CAPRI (ECJ): 1300 01.1973/12.1973 43KW 59CV 1297CC - FORD CAPRI (ECJ): 1300 01.1971/12.1973 39KW 54CV 1298CC - FORD CAPRI (ECJ): 1300 12.1968/12.1972 37KW 50CV 1305CC - FORD CAPRI (ECJ): 1300 01.1971/12.1972 39KW 53CV 1305CC - FORD CAPRI (ECJ): 1500 12.1968/02.1974 44KW 60CV 1498CC - FORD CAPRI (ECJ): 1500 12.1968/02.1974 48KW 65CV 148...</p> <p>d30x40mm d25mm 1f-d9mm</p>
	<p><b>L1030</b> NO. 1412951 - 1421951 - 6100095</p> <p>CASQUILHO DE BRAÇOS DE SUSPENSÃO</p> <p>FORD CAPRI (ECJ): 1300 10.1972/12.1973 40KW 55CV 1297CC - FORD CAPRI (ECJ): 1300 01.1973/12.1973 43KW 59CV 1297CC - FORD CAPRI (ECJ): 1300 01.1971/12.1973 39KW 54CV 1298CC - FORD CAPRI (ECJ): 1300 12.1968/12.1972 37KW 50CV 1305CC - FORD CAPRI (ECJ): 1300 01.1971/12.1972 39KW 53CV 1305CC - FORD CAPRI (ECJ): 1500 12.1968/02.1974 44KW 60CV 1498CC - FORD CAPRI (ECJ): 1500 12.1968/02.1974 48KW 65CV 148...</p> <p>d41x37mm 1f-d20mm</p>		<p><b>L1044</b> NO. 1487654</p> <p>CASQUILHO SILENT-BLOCO BRAÇO SUSPENSÃO FRENTE ( GASTA 2 UNIDADES )</p> <p>FORD CAPRI (ECJ): 1300 10.1972/12.1973 40KW 55CV 1297CC - FORD CAPRI (ECJ): 1300 01.1973/12.1973 43KW 59CV 1297CC - FORD CAPRI (ECJ): 1300 01.1971/12.1973 39KW 54CV 1298CC - FORD CAPRI (ECJ): 1300 12.1968/12.1972 37KW 50CV 1305CC - FORD CAPRI (ECJ): 1300 01.1971/12.1972 39KW 53CV 1305CC - FORD CAPRI (ECJ): 1500 12.1968/02.1974 44KW 60CV 1498CC - FORD CAPRI (ECJ): 1500 12.1968/02.1974 48KW 65CV 148...</p> <p>d30x43mm d25mm 1f-d11mm</p>
	<p><b>M6079</b> NO. 1709852 - 6027648 - 749451BA</p> <p>JUNTA DE ESCAPE</p> <p>FORD CAPRI (1974 A 1985) - GRANADA (1972 A 1985)</p> <p>54x13mm 1f-d41mm</p>		<p><b>M6108</b> NO. 6026339</p> <p>JUNTA DE ESCAPE</p> <p>FORD GRANADA (75-82)</p> <p>57x14mm 1f-d43mm</p>
	<p><b>N1617</b> NO.</p> <p>ANEL DE ESCAPE</p> <p>FORD CAPRI MK I 1300 - 1600</p> <p>d65x13mm 1f-d40mm</p>		<p><b>N2336</b> NO. 1719466</p> <p>ANEL ESCAPE</p> <p>FORD CAPRI (ECJ): 2300 08.1969/02.1974 92KW 125CV 2294CC</p> <p>d62x14mm 1f-d36mm</p>

	<p><b>R227046</b> NO. 1604697 - 3396913 - 6047976 - 6051492 - 6079523 - 6115575 - 6126535 - 6136057 - 6136782</p> <p>TUBO SUPERIOR DO RADIADOR</p> <p>FORD GRANADA II (GU) 1.7 08.1977/07.1981 54KW 73CV 1699CC MY 0928482 0928422 - FORD GRANADA II (GU) 1.7 (GT, GF, GU) 08.1977/05.1982 51KW 70CV 1699CC TV 17 LC NWB 0928481 0928519 - FORD GRANADA Turnier (GNU) 1.7 08.1977/07.1981 54KW 74CV 1699CC MYE 0928489</p> <p>B175-d30/d31mm 74-42-62mm</p>	<p><b>R227046</b> NO. 1604697 - 3396913 - 6047976 - 6051492 - 6079523 - 6115575 - 6126535 - 6136057 - 6136782</p> <p>TUBO SUPERIOR DO RADIADOR</p> <p>FORD ORION I (AFD) 1.3 07.1983/03.1986 51KW 69CV 1296CC JPA 0928576 - FORD ORION I (AFD) 1.6 07.1983/03.1986 58KW 79CV 1597CC LP1 LPA 0928577 - FORD ORION I (AFD) 1.6 D 02.1984/03.1986 40KW 54CV 1608CC LTA 0928586 7528320 - FORD ORION I (AFD) 1.6 i 07.1983/03.1986 77KW 105CV 1597CC LRA LR1 0928578 7528315 - FORD ORION II (AFF) 1.6 D 12.1985/01.1989 40KW 54CV 1608CC LTC 0928627 7528330</p> <p>B175-d30/d31mm 74-42-62mm</p>
	<p><b>RT08565</b> NO. 1027745 - 6132910 - 6179304 - 6714710 - 91FB2282AA</p> <p>TUBO DE TRAVÃO TRÁS LH-RH</p> <p>FORD GRANADA TT (02-1985 A 1991)</p> <p>340mm MC40 - MC40</p>	<p><b>RT08600</b> NO. 1638393 - 1666247 - 1666460 - 6125634</p> <p>TUBO DE TRAVÃO TRÁS LH-RH</p> <p>FORD GRANADA TT (02-1985 A 1991)</p> <p>355mm MC11 - MC40</p>
	<p><b>S1039</b> NO. 1505928 - 6099528 - 81BB.5K789.AA</p> <p>SILENT-BLOC DE VAUS DE SUSPENSÃO (FURO 13mm)</p> <p>FORD CAPRI (ECJ): 1300 10.1972/12.1973 40KW 55CV 1297CC - FORD CAPRI (ECJ): 1300 01.1973/12.1973 43KW 59CV 1297CC - FORD CAPRI (ECJ): 1300 01.1971/12.1973 39KW 54CV 1298CC - FORD CAPRI (ECJ): 1300 12.1968/12.1972 37KW 50CV 1305CC - FORD CAPRI (ECJ): 1300 01.1971/12.1972 39KW 53CV 1305CC - FORD CAPRI (ECJ): 1500 12.1968/02.1974 44KW 60CV 1498CC - FORD CAPRI (ECJ): 1500 12.1968/02.1974 48KW 65CV 148...</p> <p>d39x46mm c32mm 1fd13mm</p>	<p><b>S1384</b> NO. 1520587 - 72GB3068AC</p> <p>SILENT-BLOC DO BRAÇO DA SUSPENSÃO DA FRENTE PARTE SUPERIOR</p> <p>FORD GRANADA</p> <p>d45x42mm d32mm 1f-d14mm</p>
	<p><b>UPCR5004</b> NO. 1454051 - 1567143 - 1678260</p> <p>PORCA DA RODA CHAVE 19 M12X1,50X30MM ( BASE CONICA )</p> <p>FORD CAPRI III (GCEP) 1.3 (01.1978 -06.1985) 40kw 54cv 1298cm3 Coupé FORD CAPRI III (GCEP) 2.0 (01.1978 -12.1985) 74kw 101cv 1993cm3 Coupé FORD CAPRI III (GCEP) 2.3 Super (06.1979 -12.1985) 84kw 114cv 2294cm3 Coupé FORD CAPRI III (GCEP) 2.8 Super Injection (01.1981 -04.1987) 118kw 160cv 2792cm3 Coupé FORD CAPRI III (GCEP) 2.8 i Turbo (01.1982 -04.1987) 138kw 188cv 2792cm3 Coupé</p> <p>d26x32mm M12x1,5mm</p>	<p><b>UPCR5004</b> NO. 1454051 - 1567143 - 1678260</p> <p>PORCA DA RODA CHAVE 19 M12X1,50X30MM ( BASE CONICA )</p> <p>FORD GRANADA II (GU) 1.6 (07.1981 -08.1985) 55kw 75cv 1593cm3 três volumes FORD GRANADA II (GU) 2.0 (08.1979 -08.1985) 74kw 101cv 1993cm3 três volumes FORD GRANADA II (GU) 2.0 (08.1981 -08.1985) 77kw 105cv 1993cm3 três volumes FORD GRANADA II (GU) 2.3 (06.1981 -08.1985) 82kw 112cv 2294cm3 três volumes FORD GRANADA II (GU) 2.3 (06.1979 -08.1985) 84kw 114cv 2294cm3 três volumes FORD GRANADA II (GU) ...</p> <p>d26x32mm M12x1,5mm</p>
	<p><b>UPCR5004</b> NO. 1454051 - 1567143 - 1678260</p> <p>PORCA DA RODA CHAVE 19 M12X1,50X30MM ( BASE CONICA )</p> <p>FORD GRANADA Turnier (GNU) 2.0 (08.1981 -08.1985) 77kw 105cv 1993cm3 Combi FORD GRANADA Turnier (GNU) 2.3 (06.1981 -06.1985) 82kw 111cv 2294cm3 Combi FORD GRANADA Turnier (GNU) 2.3 (06.1979 -08.1985) 84kw 114cv 2294cm3 Combi FORD GRANADA Turnier (GNU) 2.5 D (08.1982 -08.1985) 51kw 69cv 2498cm3 Combi FORD GRANADA Turnier (GNU) 2.8 (06.1981 -08.1985) 97kw 132cv 2792cm3 Combi FORD GRANADA Turnier (GN...</p> <p>d26x32mm M12x1,5mm</p>	<p><b>UTR0630</b> NO. 6045648</p> <p>TAMPÃO RADIADOR</p> <p>FORD CAPRI (ECJ) 1300 (De 1968.12 Até 1972.12) 37kW 50cv 1305cm3 Coupé - FORD CAPRI (ECJ) 1700 (De 1968.12 Até 1972.08) 55kW 75cv 1699cm3 Coupé - FORD CAPRI (ECJ) 2000 (De 1969.02 Até 1971.06) 63kW 86cv 1985cm3 Coupé - FORD CAPRI (ECJ) 2000 (De 1969.02 Até 1974.02) 66kW 90cv 1998cm3 Coupé - FORD CAPRI (ECJ) 2300 (De 1968.12 Até 1974.02) 79kW 108cv 2294cm3 Coupé - FORD GRANADA II (GU) 1.6 (De 1981.07 Até 1985.08) 55kW 75cv 1593cm3 três volumes</p> <p>d23x26mm c15mm d13mm</p>
	<p><b>UTR0630</b> NO. 6045648</p> <p>TAMPÃO RADIADOR</p> <p>FORD GRANADA (GGTL, GGFL) 2.3 (De 1975.01 Até 1977.08) 79kW 108cv 2294cm3 três volumes - FORD GRANADA Turnier (GGNL) 1.7 (De 1972.03 Até 1975.02) 48kW 65cv 1699cm3 Combi - FORD GRANADA Turnier (GGNL) 1.7 (De 1974.12 Até 1977.08) 51kW 70cv 1699cm3 Combi - FORD GRANADA Turnier (GGNL) 2.0 (De 1975.01 Até 1977.08) 66kW 90cv 1998cm3 Combi - FORD GRANADA Turnier (GGNL) 2.5 D (De 1982.08 Até 1985.08) 51kW 69cv 2498cm3 Combi</p> <p>d23x26mm c15mm d13mm</p>	<p><b>UTV83012</b> NO. 1457117 - 1657022 - 1663906 - 6093527 - 6186775 - 6732529 - 70TM6730AA - 89FF6730AA</p> <p>TAMPÃO VEDAÇÃO BUJÃO</p> <p>FORD CAPRI (ECJ) 1300 (De 10-1972 Até 12-1973) 40kW 55CV 1297cc Coupé FORD CAPRI (ECJ) 1600 (De 08-1972 Até 02-1974) 65kW 88CV 1593cc Coupé</p> <p>d23x26mm c15mm d13mm</p>
	<p><b>UTV83012</b> NO. 1457117 - 1657022 - 1663906 - 6093527 - 6186775 - 6732529 - 70TM6730AA - 89FF6730AA</p> <p>TAMPÃO VEDAÇÃO BUJÃO</p> <p>FORD CAPRI II (GCEP) 1.6 (De 09-1974 Até 12-1977) 50kW 68CV 1593cc Coupé FORD CAPRI II (GCEP) 1.6 (De 02-1974 Até 12-1977) 53kW 72CV 1593cc Coupé FORD CAPRI II (GCEP) 1.6 (De 02-1974 Até 12-1977) 65kW 88CV 1593cc Coupé</p> <p>d23x26mm c15mm d13mm</p>	<p><b>UTV83012</b> NO. 1457117 - 1657022 - 1663906 - 6093527 - 6186775 - 6732529 - 70TM6730AA - 89FF6730AA</p> <p>TAMPÃO VEDAÇÃO BUJÃO</p> <p>FORD CAPRI III (GCEP) 1.6 (De 01-1978 Até 04-1987) 54kW 73CV 1593cc Coupé FORD CAPRI III (GCEP) 2.0 (De 01-1978 Até 12-1985) 74kW 101CV 1993cc Coupé</p> <p>d23x26mm c15mm d13mm</p>

	<p><b>E0256-M</b> NO. 1513114 - 1141459 - 1313587 - 1526696 - 1695146 - 2S616P082AB - 3S616P082AA - 8V51.6P082AC - 8V51...</p> <p><b>ESTICADOR SUPORTE APOIO MOTOR TRAS</b></p> <p>FORD B-MAX (JK) 1.0 EcoBoost desde 10.2012/&gt;&gt;&gt;&gt; 74KW 100CV 998CC SFJA, SFJB, SFJD, SFJC 8566BFM - FORD B-MAX (JK) 1.0 EcoBoost desde 10.2012/&gt;&gt;&gt;&gt; 88KW 120CV 998CC M1JA 8566BFL - FORD B-MAX (JK) 1.0 EcoBoost desde 10.2012/&gt;&gt;&gt;&gt; 92KW 125CV 998CC M1JE, M1JH 8566BGH - FORD B-MAX (JK) 1.4 desde 10.2012/&gt;&gt;&gt;&gt; 66KW 90CV 1388CC SPJE, SPJD 8566BFN - FORD B-MAX (JK) 1.4 LPG desde 08.2013/&gt;&gt;&gt;&gt; 66KW 90CV 1388CC RTJC...</p> <p>170x90x85mm 1f-d10,5mm 3f-d11mm</p>		<p><b>E0258</b> NO. 1513343 - 1745924 - 1790310 - 1905043 - 8V51.3B438.BA - 8V51.3B438.BB - 8V51.3B438.AB - 8V51.34170</p> <p><b>ESTICADOR BARRA ESTABILIZADORA FRENTE ( GASTA 2 UNIDADES )</b></p> <p>FORD B-MAX (JK): 1.0 EcoBoost 10.2012/&gt;&gt;&gt;&gt; 74KW 100CV 998CC - FORD B-MAX (JK): 1.0 EcoBoost 10.2012/&gt;&gt;&gt;&gt; 88KW 120CV 998CC - FORD B-MAX (JK): 1.0 EcoBoost 10.2012/&gt;&gt;&gt;&gt; 92KW 125CV 998CC - FORD B-MAX (JK): 1.0 EcoBoost 02.2016/&gt;&gt;&gt;&gt; 103KW 140CV 998CC - FORD B-MAX (JK): 1.4 10.2012/&gt;&gt;&gt;&gt; 66KW 90CV 1388CC - FORD B-MAX (JK): 1.4 LPG 08.2013/&gt;&gt;&gt;&gt; 66KW 90CV 1388CC - FORD B-MAX (JK): 1.6 Ti 10.2012/&gt;&gt;&gt;&gt; 77KW 105CV ...</p> <p>290x36x35mm 2p-d10x25mm</p>
	<p><b>R221378</b> NO. 1514152 - 1704985 - 1827185 - 8V218B273BB - 8V218B273BC</p> <p><b>TUBO INFERIOR DO RADIADOR</b></p> <p>FORD B-MAX (JK) 1.5 TDCi desde 10.2012 55KW 75CV 1499CC XUJA XUJB UGJG UGJC 8566BFP - FORD B-MAX (JK) 1.5 TDCi desde 04.2015 70KW 95CV 1499CC XVJC XVJA 8566BKT - FORD B-MAX (JK) 1.6 TDCi desde 10.2012 70KW 95CV 1560CC T3JB 8566BFO - FORD B-MAX Van (JK) 1.5 TDCi desde 10.2012 55KW 75CV 1499CC XUJB XUJA UGJC UGJG - FORD B-MAX Van (JK) 1.5 TDCi desde 04.2015 70KW 95CV 1499CC XVJC XVJA - FORD B-MAX Va...</p> <p>B540-d28/d30mm 78-142-300-90-67mm</p>		<p><b>R221383</b> NO. 55-72-137-78-36-36-33-61-104mm ch-</p> <p><b>TUBO DO DEPOSITO EXPANSÃO AO RADIADOR</b></p> <p>FORD B-MAX (JK) 1.4 desde 10.2012 66KW 90CV 1388CC SPJE SPJD 8566BFN - FORD B-MAX (JK) 1.6 Ti desde 10.2012 77KW 105CV 1596CC IQJA IQJC 8566BFK - FORD B-MAX Van (JK) 1.4 desde 10.2012 66KW 90CV 1388CC SPJD SPJE - FORD B-MAX (JK) 1.6 Ti desde 10.2012 77KW 105CV 1596CC IQJA IQJC</p> <p>B630-18/22mm 55-72-137-78-36-36-33-61-104mm ch-d36x74-99-51-3</p>
	<p><b>R225775</b> NO. 1710178 - 1710179 - AV216C646AD - AV216K863AE</p> <p><b>TUBO DO AR SOBREALIMENTAÇÃO</b></p> <p>FORD B-MAX (JK) 1.5 TDCi desde 10.2012 55KW 75CV 1499CC XUJA XUJB UGJG UGJC 8566BFP - FORD B-MAX (JK) 1.5 TDCi desde 04.2015 70KW 95CV 1499CC XVJC XVJA 8566BKT - FORD B-MAX (JK) 1.6 TDCi desde 10.2012 70KW 95CV 1560CC T3JB 8566BFO</p> <p>B174-d47/d47mm 174mm</p>		<p><b>UAP83244</b> NO. 1230952 - 1432205 - 3M5QE568AA - M5Q9E568CA</p> <p><b>ANILHA PROTEÇÃO TÉRMICA INJECTORES</b></p> <p>FORD B-MAX (JK) 1.5 TDCi (De 10-2012 Até .1-20 -) 55kW 75CV 1499cc Veículo multiuso - FORD B-MAX (JK) 1.5 TDCi (De 04-2015 Até .1-20 -) 70kW 95CV 1499cc Veículo multiuso - FORD B-MAX (JK) 1.6 TDCi (De 10-2012 Até .1-20 -) 70kW 95CV 1560cc Veículo multiuso</p> <p>d15x2mm 1f-d7mm</p>
	<p><b>UMV25325</b> NO. 1580939 - AM8A6J-7J132-ABT</p> <p><b>MANETE PUNHO TOPO ALAVANCA MUDANÇAS 5 VELOCIDADES F14MM</b></p> <p>FORD B-MAX (JK) 1.0 EcoBoost (De 10.2012 -) 74KW 100cv 998cm3 Veículo multiuso - FORD B-MAX (JK) 1.0 EcoBoost (De 10.2012 -) 88KW 120cv 998cm3 Veículo multiuso - FORD B-MAX (JK) 1.0 EcoBoost (De 10.2012 -) 92KW 125cv 998cm3 Veículo multiuso - FORD B-MAX (JK) 1.0 EcoBoost (De 02.2016 -) 103KW 140cv 998cm3 Veículo multiuso - FORD B-MAX (JK) 1.4 (De 10.2012 -) 66KW 90cv 1388cm3 Veículo multiuso - FOR...</p> <p>d46x90mm 1f-d14mm</p>		<p><b>UTR0847</b> NO. 1224233 - 1301104 - 3M5H8100AC</p> <p><b>TAMPÃO RESERVATÓRIO LIQUIDO REFRIGERAÇÃO</b></p> <p>FORD B-MAX (JK) 1.0 EcoBoost (A Partir de 10.12) 100cv 998cc Veículo multiuso - FORD B-MAX (JK) 1.0 EcoBoost (A Partir de 10.12) 120cv 998cc Veículo multiuso - FORD B-MAX (JK) 1.0 EcoBoost (A Partir de 10.12) 125cv 998cc Veículo multiuso - FORD B-MAX (JK) 1.0 EcoBoost (A Partir de 02.16) 140cv 998cc Veículo multiuso - FORD B-MAX (JK) 1.4 (A Partir de 10.12) 90cv 1388cc Veículo multiuso ...</p> <p>d62x35mm 1f-d50x16mm</p>
	<p><b>W5165</b> NO. 1539704 - 1752282 - 8A6G6B321AB - 8A6G6B321AC</p> <p><b>POLIE DA CAMBOTA (6 PISTAS)</b></p> <p>FORD B-MAX (JK) 1.4 (De 10-2012 Até .1-20 -) 66kW 90CV 1388cc Veículo multiuso - FORD B-MAX (JK) 1.4 LPG (De 08-2013 Até .1-20 -) 66kW 90CV 1388cc Veículo multiuso - FORD B-MAX (JK) 1.6 Ti (De 10-2012 Até .1-20 -) 77kW 105CV 1596cc Veículo multiuso</p> <p>d138mm d25mm</p>		<p><b>W5177</b> NO. 1305988 - 1490906 - 1753154 - 4M5G-6B32-1ZA - 4M5G-6B32-1ZB - 4M5G-6B32-1ZC</p> <p><b>POLIE DA CAMBOTA (5 + 6 PISTAS)</b></p> <p>FORD B-MAX (JK): 1.6 Ti 10.2012/&gt;&gt;&gt;&gt; 77KW 105CV 1596CC</p> <p>d138mm d24mm</p>
	<p><b>Z41158</b> NO. 1656747 - 1825595 - 1752024 - 6740771 - 4852244</p> <p><b>MOLA DE FIXAÇÃO TIPO PORCA</b></p> <p>FORD B-MAX (JK) 1.0 EcoBoost (10.2012 -) 74kw 100cv 998cm3 Veículo multiuso - FORD B-MAX (JK) 1.0 EcoBoost (10.2012 -) 88kw 120cv 998cm3 Veículo multiuso - FORD B-MAX (JK) 1.0 EcoBoost (10.2012 -) 92kw 125cv 998cm3 Veículo multiuso - FORD B-MAX (JK) 1.0 EcoBoost (02.2016 -) 103kw 140cv 998cm3 Veículo multiuso - FORD B-MAX (JK) 1.4 (10.2012 -) 66kw 90cv 1388cm3 Veículo multiuso - FORD B-MAX (JK) 1.4 LPG (08....</p> <p>d12x 11mm f-d24mm</p>		<p><b>Z41158</b> NO. 1656747 - 1825595 - 1752024 - 6740771 - 4852244</p> <p><b>MOLA DE FIXAÇÃO TIPO PORCA</b></p> <p>FORD B-MAX Van (JK) 1.0 EcoBoost (10.2012 -) 74kw 100cv 998cm3 Caixa/monovolume - FORD B-MAX Van (JK) 1.0 EcoBoost (08.2012 -) 88kw 120cv 998cm3 Caixa/monovolume - FORD B-MAX Van (JK) 1.0 EcoBoost (10.2012 -) 92kw 125cv 998cm3 Caixa/monovolume - FORD B-MAX Van (JK) 1.4 (10.2012 -) 66kw 90cv 1388cm3 Caixa/monovolume - FORD B-MAX Van (JK) 1.4 LPG (10.2012 -) 66kw 90cv 1388cm3 Caixa/monovolume - FORD B-MAX Van...</p> <p>d12x 11mm f-d24mm</p>

## FORD C-MAX - GRAND C-MAX

	<p><b>A1780</b> NO. 123092 - 1230982 - 1233493 - 1250618 - 1345657 - 1437549 - 1567937 - 1568052 - 1930320 - 3063687...</p> <p><b>APOIO DO MOTOR FRENTE</b></p> <p>FORD GRAND C-MAX (DXA/CB7, DXA/CEU) 1.6 TDCi 12.2010/06.2019 70KW 95CV 1560CC T3DB T3DA 8566AUE 8566AUI - FORD GRAND C-MAX (DXA/CB7, DXA/CEU) 1.6 TDCi 12.2010/06.2019 85KW 115CV 1560CC T1DB T1DA 8566AUD 8566AU</p> <p>256x140x120mm 1f-d12mm 1f-d13mm 2f-18x20mm</p>		<p><b>A1784</b> NO. 1224049 - 1250824 - 1355357 - 1370874 - 1404996 - 1420044 - 1522138 - 1533046 - 1751001 - 3M516P082A...</p> <p><b>APOIO DA CAIXA VELOCIDADES</b></p> <p>FORD C-MAX (DM2): 1.6 02.2007/09.2010 74KW 100CV 1596CC - FORD C-MAX (DM2): 1.6 04.2007/09.2010 85KW 116CV 1596CC - FORD C-MAX (DM2): 1.8 02.2007/09.2010 90KW 122CV 1798CC - FORD C-MAX (DM2): 1.8 02.2007/09.2010 92KW 125CV 1798CC - FORD C-MAX (DM2): 1.8 Flexifuel 02.2007/09.2010 92KW 125CV 1798CC - FORD C-MAX (DM2): 1.6 TDCi 02.2007/09.2010 66KW 90CV 1560CC - FORD C-MAX (DM2): 1.6 TDCi 02.2007/09....</p> <p>160x1005x45mm 2f-d12mm 1f-M12</p>
--	--	--	--

	<p><b>A1823</b> NO. 1370378 - 3M516P090AC</p> <p>APOIO DA CAIXA DE VELOCIDADES</p> <p>FORD C-MAX (DM2) 1.6 (02.07 - 09.10) 100cv 1596cc - FORD C-MAX (DM2) 1.8 (04.07 - 09.10) 116cv 1596cc - FORD C-MAX (DM2) 1.8 (02.07 - 09.10) 122cv 1798cc - FORD C-MAX (DM2) 1.8 (02.07 - 09.10) 125cv 1798cc - FORD C-MAX (DM2) 1.8 Flexifuel (02.07 - 09.10)</p> <p>72x67x40mm 3f-d12mm</p>		<p><b>A1824</b> NO. 1224051 - 1256701 - 1347798 - 3M516P093AC - 3M516P093AE</p> <p>APOIO DA CAIXA DE VELOCIDADES</p> <p>FORD FOCUS C-MAX 1.6 TDCi (02.05 - 03.07) 90cv 1560cc - FORD FOCUS C-MAX 1.6 TDCi (10.03 - 03.07) 109cv 1560cc - FORD FOCUS C-MAX 1.8 TDCi (01.05 - 03.07) 115cv 1753cc - FORD FOCUS C-MAX 2.0 TDCi (10.03 - 03.07) 136cv 1997cc - FORD FOCUS II (DA_) 1.6 TDCi</p> <p>170x130x80mm 2f-d10mm 2f-d12mm</p>
	<p><b>A1825</b> NO. 1233950 - 3M5118A116AB - 1300459 - 1490983 - 3M5118A116GB - BR55-28-910E</p> <p>APOIO DO AMORTECEDOR DE TRÁS</p> <p>FORD C-MAX (DM2) 1.6 (02.07 - 09.10) 100cv 1596cc - FORD C-MAX (DM2) 1.6 (04.07 - 09.10) 116cv 1596cc - FORD C-MAX (DM2) 1.8 (02.07 - 09.10) 122cv 1798cc - FORD C-MAX (DM2) 1.8 (02.07 - 09.10) 125cv 1798cc - FORD C-MAX (DM2) 1.8 Flexifuel (02.07 - 09.10)</p> <p>125x60x40mm 3f-d8mm</p>		<p><b>A1827</b> NO. 1230960 - 1255747 - 1305330 - 1305954 - 1308718 - 1308719 - 1320605 - 1323599 - 1334230 - 1...</p> <p>APOIO DO AMORTECEDOR DA FRENTE DIREITO E ESQUERDO</p> <p>FORD C-MAX (DM2) 1.6 (02.07 - 09.10) 100cv 1596cc Veículo multiuso - FORD C-MAX (DM2) 1.6 (04.07 - 09.10) 116cv 1596cc Veículo multiuso - FORD C-MAX (DM2) 1.8 (02.07 - 09.10) 122cv 1798cc Veículo multiuso - FORD C-MAX (DM2) 1.8 (02.07 - 09.10) 122cv 1798cc Veículo multiuso - FORD C-MAX (DM2) 1.8 (02.07 - 09.10) 125cv 1798cc</p> <p>140x32mm 1f-d12mm 3r-d8mm</p>
	<p><b>A1829</b> NO. 1224260 - 1235847 - 1244260 - 3M5H8B204AA - 3M5H8B204AB</p> <p>APOIO SUPORTE RADIADOR INFERIOR</p> <p>FORD C-MAX (DM2) 1.6 (02.07 - 09.10) 100cv 1596cc - FORD C-MAX (DM2) 1.8 (02.07 - 09.10) 122cv 1798cc - FORD C-MAX (DM2) 1.8 (02.07 - 09.10) 125cv 1798cc - FORD C-MAX (DM2) 1.8 Flexifuel (02.07 - 09.10) 125cv 1798cc - FORD C-MAX (DM2) 2.0 (02.07 - 09.10)</p> <p>38x38mm 1f-d14mm</p>		<p><b>A2302</b> NO. 1224049 - 1355357 - 1404996 - 1420044</p> <p>APOIO CAIXA VELOCIDADES</p> <p>FORD C-MAX (DM2): 1.6 02.2007/09.2010 74KW 100CV 1596CC - FORD C-MAX (DM2): 1.8 02.2007/09.2010 90KW 122CV 1798CC - FORD C-MAX (DM2): 1.8 02.2007/09.2010 92KW 125CC 1798CC - FORD C-MAX (DM2): 1.8 Flexifuel 02.2007/09.2010 92KW 125CV 1798CC - FORD C-MAX (DM2): 2.0 02.2007/09.2010 107KW 145CV 1999CC - FORD C-MAX (DM2): 2.0 LPG 06.2008/09.2010 107KW 145CV 1999CC - FORD C-MAX (DM2): 2.0 CNG 04.2009/0...</p> <p>175x108x43mm 1f-d12mm 1f-d14mm 1r-d11mm</p>
	<p><b>A2380</b> NO. 1872079 - 2111961 - F1F16F012AA - F1F16F012BB</p> <p>APOIO DO MOTOR LADO DIREITO</p> <p>FORD C-MAX II (DXA/CB7, DXA/CEU) 1.5 TDCi (De 03.2015 -) 70kW 95cv 1499cm3 Veículo multiuso - FORD C-MAX II (DXA/CB7, DXA/CEU) 1.5 TDCi (De 03.2015 -) 88kW 120cv 1499cm3 Veículo multiuso - FORD C-MAX II (DXA/CB7, DXA/CEU) 1.5 TDCi ECOnetic (De 03.2015 -) 77kW 105cv 1499cm3 Veículo multiuso -</p> <p>259x158x152mm 3f-d14mm 1f-d10mm 2f-19x21mm</p>		<p><b>A2380</b> NO. 1872079 - 2111961 - F1F16F012AA - F1F16F012BB</p> <p>APOIO DO MOTOR LADO DIREITO</p> <p>FORD GRAND C-MAX (DXA/CB7, DXA/CEU) 1.5 TDCi (De 03.2015 -) 70kW 95cv 1499cm3 Veículo multiuso - FORD GRAND C-MAX (DXA/CB7, DXA/CEU) 1.5 TDCi (De 03.2015 -) 88kW 120cv 1499cm3 Veículo multiuso -</p> <p>259x158x152mm 3f-d14mm 1f-d10mm 2f-19x21mm</p>
	<p><b>A2471</b> NO. 1684926 - 3M516P093DC - AV616P093NA</p> <p>APOIO DO MOTOR LADO CAIXA VELOCIDADES</p> <p>FORD C-MAX II (DXA/CB7, DXA/CEU): 1.5 EcoBoost 03.2015/&gt;&gt;&gt;&gt; 110kW 150CV 1498CC - FORD C-MAX II (DXA/CB7, DXA/CEU): 1.6 EcoBoost 12.2010/&gt;&gt;&gt;&gt; 110kW 150CV 1596CC - FORD C-MAX II (DXA/CB7, DXA/CEU): 1.6 EcoBoost 12.2010/&gt;&gt;&gt;&gt; 134kW 182CV 1596CC - FORD C-MAX II (DXA/CB7, DXA/CEU): 1.5 TDCi 03.2015/&gt;&gt;&gt;&gt; 70KW 95CV 1499CC - FORD C-MAX II (DXA/CB7, DXA/CEU): 1.5 TDCi ECOnetic 03.2015/&gt;&gt;&gt;&gt; 77KW 105CV 1499CC - FO...</p> <p>170x110x98mm 1f-d11mm 1f-d12mm 1f-d13mm 1f-d14mm</p>		<p><b>A2471</b> NO. 1684926 - 3M516P093DC - AV616P093NA</p> <p>APOIO DO MOTOR LADO CAIXA VELOCIDADES</p> <p>FORD GRAND C-MAX (DXA/CB7, DXA/CEU): 1.5 EcoBoost 03.2015/&gt;&gt;&gt;&gt; 110kW 150CV 1498CC - FORD GRAND C-MAX (DXA/CB7, DXA/CEU): 1.5 EcoBoost 03.2015/&gt;&gt;&gt;&gt; 134kW 182CV 1498CC - FORD GRAND C-MAX (DXA/CB7, DXA/CEU): 1.5 TDCi 03.2015/&gt;&gt;&gt;&gt; 70KW 95CV 1499CC - FORD GRAND C-MAX (DXA/CB7, DXA/CEU): 1.5 TDCi 03.2015/&gt;&gt;&gt;&gt; 88KW 120CV 1499CC - FORD GRAND C-MAX (DXA/CB7, DXA/CEU): 1.6 TDCi 12.2010/&gt;&gt;&gt;&gt; 70KW 95CV 1560CC - ...</p> <p>170x110x98mm 1f-d11mm 1f-d12mm 1f-d13mm 1f-d14mm</p>
	<p><b>A2497</b> NO. 1686911 - 1701509 - 1742411 - 1753974</p> <p>APOIO DO MOTOR PARTE DA FRENTE LADO DIREITO</p> <p>FORD C-MAX II (DXA/CB7, DXA/CEU) 1.5 EcoBoost (De 03.2015 -) 110kW 150cv 1498cm3 Veículo multiuso - FORD C-MAX II (DXA/CB7, DXA/CEU) 1.5 EcoBoost (De 03.2015 -) 134kW 182cv 1498cm3 Veículo multiuso - FORD C-MAX II (DXA/CB7, DXA/CEU) 1.6 EcoBoost (De 12.2010 -) 110kW 150cv 1596cm3 Veículo multiuso - FORD C-MAX II (DXA/CB7, DXA/CEU) 1.6 EcoBoost (De 12.2010 -) 134kW 182cv 1596cm3 Veículo multiuso - ...</p> <p>254x140x102mm 3f-d12mm 2f-20x22mm</p>		<p><b>A2516</b> NO. 1224047 - 1251749 - 1255094 - 1256702 - 1315539 - 1345226 - 1376724 - 1387787 - 1510904 - 1543750 - ...</p> <p>APOIO DO MOTOR PARTE DA FRENTE LADO DIREITO</p> <p>FORD C-MAX (DM2) 2.0 TDCi (De 02.2008 Até 09.2010) 81kW 110cv 1997cm3 Veículo multiuso - FORD C-MAX (DM2) 2.0 TDCi (De 02.2007 Até 09.2010) 98kW 133cv 1997cm3 Veículo multiuso - FORD C-MAX (DM2) 2.0 TDCi (De 02.2007 Até 09.2010) 100kW 136cv 1997cm3 Veículo multiuso -</p> <p>255x157x140mm 1f-d14mm 1f-14x15mm 2f-18x20mm</p>
	<p><b>A2516</b> NO. 1223973 - 1224047 - 1251749 - 1255094 - 1256702 - 1315539 - 1345226 - 1376724 - 1510904</p> <p>APOIO DO MOTOR PARTE DA FRENTE LADO DIREITO</p> <p>FORD C-MAX II (DXA/CB7, DXA/CEU) 2.0 TDCi (De 02.2011 Até 06.2019) 85kW 115cv 1997cm3 Veículo multiuso - FORD C-MAX II (DXA/CB7, DXA/CEU) 2.0 TDCi (De 02.2011 Até 06.2019) 100kW 136cv 1997cm3 Veículo multiuso - FORD C-MAX II (DXA/CB7, DXA/CEU) 2.0 TDCi (De 04.2010 Até 06.2019) 103kW 140cv 1997cm3 Veículo multiuso - FORD C-MAX II (DXA/CB7, DXA/CEU) 2.0 TDCi (De 12.2010 Até 06.2019) 120kW 163cv 199...</p> <p>255x157x140mm 1f-d14mm 1f-14x15mm 2f-18x20mm</p>		<p><b>A2516</b> NO. 1223973 - 1224047 - 1251749 - 1255094 - 1256702 - 1315539 - 1345226 - 1376724 - 1510904</p> <p>APOIO DO MOTOR PARTE DA FRENTE LADO DIREITO</p> <p>FORD GRAND C-MAX (DXA/CB7, DXA/CEU) 2.0 TDCi (De 02.2011 Até 06.2019) 100kW 136cv 1997cm3 Veículo multiuso - FORD GRAND C-MAX (DXA/CB7, DXA/CEU) 2.0 TDCi (De 02.2011 Até 06.2019) 103kW 140cv 1997cm3 Veículo multiuso -</p> <p>255x157x140mm 1f-d14mm 1f-14x15mm 2f-18x20mm</p>
	<p><b>E1070</b> NO. 1003890 - 1016405 - 1099277 - 1118218</p> <p>ESTICADOR DE ESCAPE</p> <p>FORD C-MAX</p> <p>70x50x27mm</p>		<p><b>E24307-V</b> NO. 1332491 - XS4R7412BA</p> <p>ESTICADOR MANETE CAIXA VELOCIDADES</p> <p>FORD C-MAX (DM2) 1.6 TDCi 02.2007/09.2010 66KW 90CV 1560CC GPDA HHDB HHDA 8566AAK - FORD C-MAX (DM2) 1.6 TDCi 02.2007/09.2010 74KW 101CV 1560CC MTPDA G8DC 8566AKH - FORD C-MAX (DM2) 1.6 TDCi 02.2007/09.2010 80KW 109CV 1560CC G8DB G8DD G8DA 8566AAJ - FORD C-MAX (DM2) 1.8 Flexifuel 02.2007/09.2010 92KW 125CV 1798CC Q7DA 8566ATL - FORD C-MAX (DM2) 1.8 TDCi 02.2007/09.2010 85KW 115CV 1753CC KKDA KKDB 8...</p> <p>d33x21x75mm 1f-13x19mm</p>

	<b>F4236</b> NO. 1223834 - 1305329 <b>FOLE CAPA PROTECÇÃO AMORTECEDOR FRENTE ( GASTA 2 UNIDADES )</b> FORD C-MAX II (DXA/CB7, DXA/CEU): 1.0 EcoBoost 10.2012/>>> 74KW 100CV 998CC - FORD C-MAX II (DXA/CB7, DXA/CEU): 1.0 EcoBoost 10.2012/>>> 92KW 125CV 998CC - FORD C-MAX II (DXA/CB7, DXA/CEU): 1.5 EcoBoost 03.2015/>>> 110KW 150CV 1498CC - FORD C-MAX II (DXA/CB7, DXA/CEU): 1.5 EcoBoost 03.2015/>>> 134KW 182CV 1498CC - FORD C-MAX II (DXA/CB7, DXA/CEU): 1.6 Ti 12.2010/>>> 63KW 85CV 1596CC - FORD C-MAX I... d79x241mm 1f-d61mm 1f-d64mm		<b>F4317</b> NO. 8M5R7H409BK <b>FOLE ALAVANCA VELOCIDADES C/ ARO CROMADO</b> FORD C-MAX (DM2) 1.6 02.2007/09.2010 74KW 100CV 1596CC SHDC SHDB HWDB HWDA SHDA 8566AAL - FORD C-MAX (DM2) 1.6 04.2007/09.2010 85KW 116CV 1596CC SIDA HXDB HXDA 8566AAM - FORD C-MAX (DM2) 1.6 TDCi 02.2007/09.2010 66KW 90CV 1560CC GPDA HHDB HHDA 8566AAK - FORD C-MAX (DM2) 1.6 TDCi 02.2007/09.2010 74KW 101CV 1560CC MTDA G8DC 8566AKH - FORD C-MAX (DM2) 1.6 TDCi 02.2007/09.2010 80KW 109CV 1560CC G8DB G... 170x157x137mm 1f-120x108mm
	<b>F4364</b> NO. 1639784 - 8V4R7P002KB <b>FOLE ALAVANCA VELOCIDADES C/ ARO CROMADO</b> FORD C-MAX (DM2) 1.6 02.2007/09.2010 74KW 100CV 1596CF SHDC SHDB HWDB HWDA SHDA 8566AAL - FORD C-MAX (DM2) 1.6 04.2007/09.2010 85KW 116CV 1596CC SIDA HXDB HXDA 8566AAM - FORD C-MAX (DM2) 1.6 TDCi 02.2007/09.2010 66KW 90CV 1560CC GPDA HHDB HHDA 8566AAK - FORD C-MAX (DM2) 1.6 TDCi 02.2007/09.2010 74KW 101CV 1560CC MTDA G8DC 8566AKH - FORD C-MAX (DM2) 1.6 TDCi 02.2007/09.2010 80KW... 138x124mm 1f-117x96mm 1f-d25mm		<b>F9011H-I</b> NO. 1061867 - 1119226 - 1119227 - 1306052 - 1349165 - 1355188 - 1360390 - 1363787 - 1447559 - 1447560 - ... <b>FOLE DA TRANSMISSÃO JUNTO À RODA</b> FORD C-MAX (DM2) 1.6 TDCi (De 02-2007 Até 09-2010) 66kW 90CV 1560cc Veículo multiuso FORD C-MAX (DM2) 1.6 TDCi (De 02-2007 Até 09-2010) 74kW 101CV 1560cc Veículo multiuso FORD C-MAX (DM2) 1.6 TDCi (De 02-2007 Até 09-2010) 80kW 109CV 1560cc Veículo multiuso d95x109mm 1f-d31mm 1f-d79mm
	<b>KF1896-I</b> NO. 1444324 - 1501164 - 1501167 - 1552978 <b>KIT DE FOLE DO CARDAN JUNTO À CAIXA</b> FORD C-MAX (DM2) 2.0 TDCi 02.2007/09.2010 100KW 136CV 1997CC G6DG G6DD G6DB G6DA 8566AAH d96x87mm 1f-d84mm 1f-d21mm		<b>KF9016</b> NO. 1f-885mm 1f-d35mm - 1f-80mm 1f-d35 <b>KIT DE FOLE DO CARDAN JUNTO À RODA E CAIXA LADO DIREITO</b> FORD C-MAX (DM2) 1.6 TDCi (02.07 - 09.10) 90cv 1560cc - FORD C-MAX (DM2) 1.8 TDCi (02.07 - 09.10) 115cv 1753cc - FORD FOCUS II (DA_) 1.6 TDCi Hatchback (01.05 - 09.12) 90cv 1560cc - FORD FOCUS II (DA_) 1.6 TDCi Hatchback (11.04 - 09.12) 109cv 1560cc - FOR 110x120mm - 90x100mm 1f-d85mm 1f-d35mm - 1f-80mm 1f-d35mm...
	<b>KF9017</b> NO. 1359667 - 1439366 - 1493022 - 1676323 - 3M514A084BB - 3M514A084BC - 3M5W3A331DA - 7M514C062BA... <b>KIT DE FOLE DO JUNTO À CAIXA E RODA LADO ESQUERDO</b> FORD C-MAX (DM2) 1.6 TDCi (02.07 - 09.10) 90cv 1560cc - FORD C-MAX (DM2) 1.6 TDCi (02.07 - 09.10) 101cv 1560cc - FORD C-MAX (DM2) 1.6 TDCi (02.07 - 09.10) 109cv 1560cc - FORD C-MAX (DM2) 1.8 TDCi (02.07 - 09.10) 115cv 1753cc - FORD FOCUS C-MAX 1.6 TDCi (0 110x120mm - 90x100mm 1f-d85mm 1f-d29mm - 1f-80mm 1f-d25		<b>KF9020</b> NO. 1302513 - 1359669 - 1439367 - 1439850 - 1485324 - 1493017 - 1493023 - 1676324 - 3M51.4A084.F... <b>KIT DE FOLE DO CARDAN LADO DA CAIXA</b> FORD C-MAX (DM2) 1.6 TDCi (02.07 - 09.10) 90cv 1560cc - FORD C-MAX (DM2) 1.6 TDCi (02.07 - 09.10) 101cv 1560cc - FORD C-MAX (DM2) 1.6 TDCi (02.07 - 09.10) 109cv 1560cc - FORD C-MAX (DM2) 1.8 TDCi (02.07 - 09.10) 115cv 1753cc - FORD FOCUS C-MAX 1.6 TDCi (0 90x100mm 1f-80mm 1f-d35mm
	<b>KF9021</b> NO. 1359667 - 1359670 - 1438787 - 1439366 - 1485325 - 1492884 - 1493016 - 1493022 - 1493022A - 1... <b>KIT DE FOLE DO CARDAN JUNTO À CAIXA LADO ESQUERDO</b> FORD C-MAX (DM2) 1.6 TDCi (02.07 - 09.10) 90cv 1560cc - FORD C-MAX (DM2) 1.6 TDCi (02.07 - 09.10) 101cv 1560cc - FORD C-MAX (DM2) 1.6 TDCi (02.07 - 09.10) 109cv 1560cc - FORD C-MAX (DM2) 1.8 TDCi (02.07 - 09.10) 115cv 1753cc - FORD FOCUS C-MAX 1.6 TDCi (0 90x100mm 1f-25mm 1f-80mm		<b>R222449</b> NO. 1306044 - 1321521 - 1384145 - 30741964 - 3M5H8286BG - 3M5H8286BH - 3M5H8286BJ <b>TUBO INFERIOR DO RADIADOR LADO DIREITO</b> FORD C-MAX (DM2) 1.6 (02.2007 - 09.2010) 74kw 100cv 1596cm3 Veículo multiuso FORD C-MAX (DM2) 1.6 (04.2007 - 09.2010) 85kw 116cv 1596cm3 Veículo multiuso boca a boca310mmd1-28mmx25mm1f0-73-50-62
	<b>R222452</b> NO. 1353884 - 1359243 - 1386843 - 1520173 - 3M5H9Y438AA - 3M5H9Y438AB - 3M5H9Y438AC - 3M5H9Y438AD <b>TUBO DO RADIADOR LADO DA ADMISSÃO</b> FORD C-MAX (DM2) 1.8 TDCi (02.2007 - 09.2010) 85kw 115cv 1753cm3 Veículo multiuso B350-15/18mm 41-17-52-180-77-48mm		<b>R222452</b> NO. 1353884 - 1359243 - 1386843 - 1520173 - 3M5H9Y438AA - 3M5H9Y438AB - 3M5H9Y438AC - 3M5H9Y438AD <b>TUBO DO RADIADOR LADO DA ADMISSÃO</b> FORD FOCUS C-MAX (DM2) 1.8 TDCi (01.2005 - 03.2007) 85kw 115cv 1753cm3 Veículo multiuso B350-15/18mm 41-17-52-180-77-48mm
	<b>R222452</b> NO. 1353884 - 1359243 - 1386843 - 1520173 - 3M5H9Y438AA - 3M5H9Y438AB - 3M5H9Y438AC - 3M5H9Y438AD <b>TUBO DO RADIADOR LADO DA ADMISSÃO</b> FORD FOCUS II (DA_, HCP, DP) 1.8 TDCi (01.2005 - 09.2012) 85kw 115cv 1753cm3 Hatchback B350-15/18mm 41-17-52-180-77-48mm		<b>R222452</b> NO. 1353884 - 1359243 - 1386843 - 1520173 - 3M5H9Y438AA - 3M5H9Y438AB - 3M5H9Y438AC - 3M5H9Y438AD <b>TUBO DO RADIADOR LADO DA ADMISSÃO</b> FORD FOCUS II Turnier (DA_, FFS, DS) 1.8 TDCi (07.2004 - 09.2012) 85kw 115cv 1753cm3 Combi B350-15/18mm 41-17-52-180-77-48mm
	<b>R222452</b> NO. 1353884 - 1359243 - 1386843 - 1520173 - 3M5H9Y438AA - 3M5H9Y438AB - 3M5H9Y438AC - 3M5H9Y438AD <b>TUBO DO RADIADOR LADO DA ADMISSÃO</b> FORD FOCUS II três volumes (DB_, FCH, DH) 1.8 TDCi (04.2005 - 09.2012) 85kw 115cv 1753cm3 três volumes B350-15/18mm 41-17-52-180-77-48mm		<b>R224137</b> NO. 1231906 - 1252691 - 1314366 - 1346295 - 1439411 - 1496239 - 1525112 - 3M516C646AD - 3M516C646XB - 3M... <b>TUBO DO AR SOBREALIMENTAÇÃO</b> FORD C-MAX (DM2) 1.6 TDCi (De 2007.02 Até 2010.09) 66kW 90cv 1560cm3 Veículo multiuso - B425-48/52mm 82x144x67x106mm



	<p><b>R224143</b> NO. 1440439 - 30756067 - 3M5Q9351CD</p> <p>TUBO ADMISSÃO FILTRO DE AR</p> <p>FORD C-MAX (DM2) 1.6 TDCi 02.2007/09.2010 80KW 109CV 1560CC G8DB G8DD G8DA 8566AAJ</p> <p>160x100x70mm 3f-d7mm 3f-d4mm 1f-d50x41 1f-d59mm</p>		<p><b>R224144</b> NO. 1440440 - 3M5Q9351EB</p> <p>TUBO DE ADMISSÃO FILTRO DE AR</p> <p>FORD C-MAX (DM2) 1.6 TDCi (De 02-2007 Até 09-2010) 66kW 90CV 1560cc Veículo multiuso FORD FOCUS C-MAX 1.6 TDCi (De 02-2005 Até 03-2007) 66kW 90CV 1560cc Veículo multiuso</p> <p>d100x155mm 1f-d59mm 3f-d8mm 50x41mm 73-25mm</p>
	<p><b>R225000</b> NO. 1324644 - 1324645 - 1344155 - 1530297 - 31261896 - 3M516C646YF - 3M516C646YG - 3M516C646YH - 6M516K9</p> <p>TUBO DO AR SOBREALIMENTAÇÃO</p> <p>FORD C-MAX (DM2): 2.0 TDCi 02.2008/09.2010 81KW 110CV 1997CC - FORD C-MAX (DM2): 2.0 TDCi 02.2007/09.2010 98KW 133CV 1997CC - FORD C-MAX (DM2): 2.0 TDCi 02.2007/09.2010 100KW 136CV 1997CC</p> <p>B515-48/50mm 43x47x98x111x155x49mm</p>		<p><b>R225000</b> NO. 1324644 - 1324645 - 1344155 - 1530297 - 31261896 - 3M516C646YF - 3M516C646YG - 3M516C646YH - 6M516K9</p> <p>TUBO DO AR SOBREALIMENTAÇÃO</p> <p>FORD GRAND C-MAX (DXA/CB7, DXA/CEU): 2.0 TDCi 02.2011/&gt;&gt;&gt;&gt; 85KW 115CV 1997CC - FORD GRAND C-MAX (DXA/CB7, DXA/CEU): 2.0 TDCi 02.2011/&gt;&gt;&gt;&gt; 100KW 136CV 1997CC - FORD GRAND C-MAX (DXA/CB7, DXA/CEU): 2.0 TDCi 02.2011/&gt;&gt;&gt;&gt; 103KW 140CV 1997CC - FORD GRAND C-MAX (DXA/CB7, DXA/CEU): 2.0 TDCi 03.2015/&gt;&gt;&gt;&gt; 110KW 150CV 1997CC - FORD GRAND C-MAX (DXA/CB7, DXA/CEU): 2.0 TDCi 12.2010/&gt;&gt;&gt;&gt; 120KW</p> <p>B515-48/50mm 43x47x98x111x155x49mm</p>
	<p><b>R225028</b> NO. 1708385 - 1710388 - 1717462 - 1784498 - AV616C646HE</p> <p>TUBO DO AR SOBREALIMENTAÇÃO</p> <p>FORD C-MAX II (DXA/CB7, DXA/CEU) 1.5 TDCi (De 03.2015 -) 70kW 95cv 1499cm3 Veículo multiuso - FORD C-MAX II (DXA/CB7, DXA/CEU) 1.5 TDCi (De 03.2015 -) 88kW 120cv 1499cm3 Veículo multiuso - FORD C-MAX II (DXA/CB7, DXA/CEU) 1.5 TDCi ECOnetic (De 03.2015 -) 77kW 105cv 1499cm3 Veículo multiuso -</p> <p>B204-45/55mm</p>		<p><b>R225074</b> NO. 1697700 - AV616C700AD</p> <p>TUBO DO AR SOBREALIMENTAÇÃO</p> <p>FORD C-MAX II (DXA/CB7, DXA/CEU) 2.0 TDCi (De 02.2011 Até 06.2019) 85kW 115cv 1997cm3 Veículo multiuso - FORD C-MAX II (DXA/CB7, DXA/CEU) 2.0 TDCi (De 12.2010 Até 06.2019) 120kW 163cv 1997cm3 Veículo multiuso -</p> <p>B73-42/47mm 73mm</p>
	<p><b>R225077</b> NO. 1439410 - 1672189 - 6M516C646GA - 6M516C646GC</p> <p>TUBO DO AR SOBREALIMENTAÇÃO</p> <p>FORD C-MAX (DM2) 1.6 TDCi (De 02.2007 Até 09.2010) 66kW 90cv 1560cm3 Veículo multiuso - FORD C-MAX (DM2) 1.6 TDCi (De 02.2007 Até 09.2010) 80kW 109cv 1560cm3 Veículo multiuso -</p> <p>B292-44/47mm 71x171x108mm</p>		<p><b>R225079</b> NO. 1697700 - AV616C700AD</p> <p>TUBO DO AR SOBREALIMENTAÇÃO</p> <p>FORD C-MAX II (DXA/CB7, DXA/CEU) 2.0 TDCi (De 02.2011 Até 06.2019) 85kW 115cv 1997cm3 Veículo multiuso - FORD C-MAX II (DXA/CB7, DXA/CEU) 2.0 TDCi (De 12.2010 Até 06.2019) 120kW 163cv 1997cm3 Veículo multiuso -</p> <p>B136-48/49mm 73x58mm</p>
	<p><b>R225421</b> NO. 1231901 - 1312657 - 1339071 - 1359107 - 1376266 - 1404782 - 1465156 - 3M5Q9F764CA - 3M5Q9F764CB - 3M...</p> <p>TUBO DO AR SOBREALIMENTAÇÃO</p> <p>FORD C-MAX (DM2) 1.6 TDCi 02.2007/09.2010 66KW 90CV 1560CC GPDA HHDB HHDA 8566AAK - FORD C-MAX (DM2) 1.6 TDCi 02.2007/09.2010 74KW 101CV 1560CC MTD A G8DC 8566AKH - FORD C-MAX (DM2) 1.6 TDCi 02.2007/09.2010 80KW 109CV 1560CC G8DB G8DD G8DA 8566AAJ - FORD FOCUS C-MAX (DM2) 1.6 TDCi 02.2003/03.2007 80KW 109CV 1560CC G8DB G8DA G8DD G8DF G8DE 8566AAJ 8566532 - FORD FOCUS C-MAX (DM2) 1.6 TDCi 02.2005/03...</p> <p>305x93x121mm 1f-d33mm 1r-d37mm 1r-d40mm</p>		<p><b>R225462</b> NO. 1303478 - 3M5Q6A646AA</p> <p>TUBO DO RADIADOR DO ÓLEO COM JUNTAS</p> <p>FORD C-MAX II (DXA/CB7, DXA/CEU) 2.0 TDCi 04.2010/06.2019 103KW 140CV 1997CC UFDB 8566AUM 8566AUR - FORD C-MAX II (DXA/CB7, DXA/CEU) 2.0 TDCi 12.2010/06.2019 120KW 163CV 1997CC TXDB 8566AUQ - FORD C-MAX II (DXA/CB7, DXA/CEU) 2.0 TDCi 02.2011/06.2019 85KW 115CV 1997CC TYDA 8566AUT 8566AUU - FORD GRAND C-MAX (DXA/CB7, DXA/CEU) 2.0 TDCi 12.2010/06.2019 120KW 163CV 1997CC TXDB 8566AUL 8566AUQ - FORD G...</p> <p>Ø81x4mm d27x3mm d72x4mm d22x97mm d21mm 1f-d19mm 1f-d14mm</p>
	<p><b>R225710</b> NO. 1439410 - 1672189 - 31273520 - 6M516C646GA - 6M516C646GC</p> <p>TUBO DO AR SOBREALIMENTAÇÃO</p> <p>FORD C-MAX (DM2) 1.6 TDCi 02.2007/09.2010 66KW 90CV 1560CC GPDA HHDB HHDA 8566AAK - FORD C-MAX (DM2) 1.6 TDCi 02.2007/09.2010 80KW 109CV 1560CC G8DB G8DD G8DA 8566AAJ</p> <p>B161-49/49mm 59x67mm</p>		<p><b>R230185</b> NO. 1495968 - 1674010 - 1684286 - 30792124 - 31201867 - 31293630 - 7M51-9A673-LC - 7M519A673LA - 7M519A6...</p> <p>TUBO DE ADMISSÃO FILTRO DE AR</p> <p>FORD C-MAX (DM2) 1.8 02.2007/09.2010 90KW 122CV 1798CC QQDC 8566AAP - FORD C-MAX (DM2) 1.8 02.2007/09.2010 92KW 125CV 1798CC QQDA QQDB 8566AAO - FORD C-MAX (DM2) 1.8 Flexifuel 02.2007/09.2010 92KW 125CV 1798CC Q7DA 8566ATL - FORD C-MAX (DM2) 2.0 02.2007/09.2010 107KW 145CV 1999CC SYDA AODE AODB AODA 8566AAG - FORD C-MAX (DM2) 2.0 CNG 04.2009/09.2010 107KW 145CV 1999CC SYDA 8566AQU - FORD C-MAX (DM...</p> <p>B147-69/69mm 46-100mm</p>
	<p><b>R8133</b> NO. 1439410 - 1672189 - 6M516C646GA - 6M516C646GC</p> <p>TUBO DO TURBO SOBREALIMENTAÇÃO</p> <p>FORD C-MAX (DM2) 1.6 TDCi (02.07 - 09.10) 90cv 1560cc Veículo multiuso - FORD C-MAX (DM2) 1.6 TDCi (02.07 - 09.10) 101cv 1560cc Veículo multiuso - FORD C-MAX (DM2) 1.6 TDCi (02.07 - 09.10) 109cv 1560cc Veículo multiuso - FORD FOCUS II (DA_) 1.6 TDCi (01.0</p> <p>B300-d47/44mm 130-180-100mm</p>		<p><b>R8200</b> NO. 1251783 - 1366216 - 1430644 - 4M5G-6758-FA - 4M5G-6758-HA - 6G9G-6758-AA</p> <p>TUBO DO RESPIRO DO CARTER DA CAMBOTA</p> <p>FORD C-MAX (DM2) 1.8 02.2007/09.2010 90KW 122CV 1798CC QQDC 8566AAP - FORD C-MAX (DM2) 1.8 02.2007/09.2010 92KW 125CV 1798CC QQDA QQDB 8566AAO - FORD C-MAX (DM2) 1.8 Flexifuel 02.2007/09.2010 92KW 125CV 1798CC Q7DA 8566ATL - FORD C-MAX (DM2) 2.0 02.2007/09.2010 107KW 145CV 1999CC SYDA AODE AODB AODA 8566AAG - FORD C-MAX (DM2) 2.0 CNG 04.2009/09.2010 107KW 145CV 1999CC SYDA 8566AQU - FORD C-MAX (DM...</p> <p>B117-14/14mm 37-62-38mm</p>
	<p><b>RF80419</b> NO. 1104177 - 1139037 - 1461332 - XS4Q8K579CE - XS4Q8K579CF - XS4Q9N271CC</p> <p>TUBO DE FERRO REFRIGERAÇÃO</p> <p>FORD C-MAX (DM2) 1.8 (De 02.2007 Até 09.2010) 90kW 122cv 1798cm3 Veículo multiuso - FORD C-MAX (DM2) 1.8 (De 02.2007 Até 09.2010) 92kW 125cv 1798cm3 Veículo multiuso - FORD C-MAX (DM2) 1.8 Flexifuel (De 02.2007 Até 09.2010) 92kW 125cv 1798cm3 Veículo multiuso -</p> <p>B345-28/31mm 89x56x109x51x52mm ch-d21x25x109mm</p>		<p><b>RT80388</b> NO. 1387264</p> <p>TUBO DE TRAVÃO FRENTE LH-RH</p> <p>FORD C-MAX TT (APÓS 02-2007)</p> <p>435mm FB78 - MCL2</p>



	<p><b>RT80450</b> NO. 1379911 - 1671020</p> <p><b>TUBO DE TRAVÃO FRENTE LH-RH</b></p> <p>FORD S-MAX 1.8 TDCi (APÓS 05-2006) - S-MAX 2.0 (APÓS 05-2006) - S-MAX 2.0 TDCi (APÓS 05-2006) - S-MAX 2.2 TDCi (APÓS 03-2008) - S-MAX 2.5 ST (APÓS 05-2006) - S-MAX 2.3 (APÓS 07-2007)</p> <p>420mm FB76 - MC64</p>	 <p><b>S1505</b> NO. 1234371 - 1234375 - 1254310 - 1254311 - 1305341 - 1305342 - 1309148 - 1328380 - 1355149 - 135...</p> <p><b>SILENT BLOC DO BRAÇO DA SUSPENSÃO DA FRENTE</b></p> <p>FORD - C-MAX - 1.6 Veículo multiuso 100CV 1596cc (APÓS 02-2007) - 1.8 Veículo multiuso 122CV 1798cc (APÓS 02-2007) - 1.8 Veículo multiuso 125CV 1798cc (APÓS 02-2007) - 1.8 Flexifuel Veículo multiuso 125CV 1798cc (APÓS 02-2007) - 2.0 Veículo multiuso 145C</p> <p>d45x65mm d40.5mm 1f-d14mm</p>
	<p><b>S1755</b> NO. 1061666 - 1064128 - 1150353 - 1335249 - 1357317 - 1357319 - 1502729 - 1548460 - 1718501 - 1782008 - ...</p> <p><b>SILENT-BLOC BRAÇO OSCILANTE SUSPENSÃO DE TRÁS</b></p> <p>FORD C-MAX (DM2) 1.6 02.2007/09.2010 74KW 100CV 1596CC SHDC SHDB HWDB HWD A SHDA 8566AAL - FORD C-MAX (DM2) 1.6 04.2007/09.2010 85KW 116CV 1596CC SIDA HXDB HXDA 8566AAM - FORD C-MAX (DM2) 1.6 TDCi 02.2007/09.2010 66KW 90CV 1560CC GPDA HHDB HHDA 8566AAK - FORD C-MAX (DM2) 1.6 TDCi 02.2007/09.2010 74KW 101CV 1560CC MTD A G8DC 8566AKH - FORD C-MAX (DM2) 1.6 TDCi 02.2007/09.2010 80KW 109CV 1560CC G8DB G... G...</p> <p>d36x45mm c36mm 1f-d12mm</p>	 <p><b>S1755</b> NO. 1061666 - 1064128 - 1150353 - 1335249 - 1357317 - 1357319 - 1502729 - 1548460 - 1718501 - 1782008 - ...</p> <p><b>SILENT-BLOC BRAÇO OSCILANTE SUSPENSÃO DE TRÁS</b></p> <p>FORD GRAND C-MAX (DXA/CB7, DXA/CEU) 1.6 Ti (De 2010.12 -) 92kW 125cv 1596cm3 Veículo multiuso - FORD GRAND C-MAX (DXA/CB7, DXA/CEU) 1.6 EcoBoost (De 2010.12 -) 110kW 150cv 1596cm3 Veículo multiuso - FORD GRAND C-MAX (DXA/CB7, DXA/CEU) 1.6 EcoBoost (De 2010.12 -) 134kW 182cv 1596cm3 Veículo multiuso - FORD GRAND C-MAX (DXA/CB7, DXA/CEU) 1.6 TDCi (De 2010.12 -) 70kW 95cv 1560cm3... ...</p> <p>d36x45mm c36mm 1f-d12mm</p>
	<p><b>S1756</b> NO. 1061666 - 1064128 - 1150353 - 1335249 - 1357317 - 1357319 - 1502729 - 1548460 - 1718501 - 1782008 - ...</p> <p><b>SILENT-BLOC BRAÇO OSCILANTE SUSPENSÃO TRÁS</b></p> <p>FORD C-MAX (DM2) 1.6 (De 2007.02 Até 2010.09) 74KW 100cv 1596cm3 Veículo multiuso - FORD C-MAX (DM2) 1.8 (De 2007.02 Até 2010.09) 90KW 122cv 1798cm3 Veículo multiuso - FORD C-MAX (DM2) 1.8 (De 2007.02 Até 2010.09) 92KW 125cv 1798cm3 Veículo multiuso - FORD C-MAX (DM2) 1.8 Flexifuel (De 2007.02 Até 2010.09) 92KW 125cv 1798cm3 Veículo multiuso - FORD C-MAX (DM2) 2.0 (De 2007.02 Até 2010.09) 92KW 125cv 1798cm3 Veículo multiuso - ...</p> <p>d36x45mm c36mm 1f-d12mm</p>	 <p><b>S1756</b> NO. 1061666 - 1064128 - 1150353 - 1335249 - 1357317 - 1357319 - 1502729 - 1548460 - 1718501 - 1782008 - ...</p> <p><b>SILENT-BLOC BRAÇO OSCILANTE SUSPENSÃO TRÁS</b></p> <p>FORD GRAND C-MAX (DXA/CB7, DXA/CEU) 1.6 Ti (De 2010.12 -) 77kW 105cv 1596cm3 Veículo multiuso - FORD GRAND C-MAX (DXA/CB7, DXA/CEU) 1.6 Ti (De 2010.12 -) 92kW 125cv 1596cm3 Veículo multiuso - FORD GRAND C-MAX (DXA/CB7, DXA/CEU) 1.6 EcoBoost (De 2010.12 -) 110kW 150cv 1596cm3 Veículo multiuso - FORD GRAND C-MAX (DXA/CB7, DXA/CEU) 1.6 EcoBoost (De 2010.12 -) 134kW 182cv 1596cm3... ...</p> <p>d32x55mm c49mm 1f-d12mm</p>
	<p><b>S1866</b> NO. 1865173</p> <p><b>SILENT-BLOC DO BRAÇO SUSPENSÃO DA FRENTE</b></p> <p>FORD C-MAX II (DXA/CB7, DXA/CEU) 1.0 EcoBoost (De 10.2012 -) 74kW 100cv 998cm3 Veículo multiuso - FORD C-MAX II (DXA/CB7, DXA/CEU) 1.0 EcoBoost (De 10.2012 -) 92kW 125cv 998cm3 Veículo multiuso - FORD C-MAX II (DXA/CB7, DXA/CEU) 1.6 EcoBoost (De 12.2010 -) 110kW 150cv 1596cm3 Veículo multiuso - FORD C-MAX II (DXA/CB7, DXA/CEU) 1.6 EcoBoost (De 12.2010 -) 134kW 182cv 1596cm3 Veículo multiuso - FORD... ...</p> <p>155x133x75mm 1f-d23mm 4f-15x19mm</p>	 <p><b>S1866</b> NO. 1865173</p> <p><b>SILENT-BLOC DO BRAÇO SUSPENSÃO DA FRENTE</b></p> <p>FORD GRAND C-MAX (DXA/CB7, DXA/CEU) 1.0 EcoBoost (De 10.2012 -) 74kW 100cv 998cm3 Veículo multiuso - FORD GRAND C-MAX (DXA/CB7, DXA/CEU) 1.0 EcoBoost (De 10.2012 -) 92kW 125cv 998cm3 Veículo multiuso - FORD GRAND C-MAX (DXA/CB7, DXA/CEU) 1.6 EcoBoost (De 12.2010 -) 110kW 150cv 1596cm3 Veículo multiuso - FORD GRAND C-MAX (DXA/CB7, DXA/CEU) 1.6 EcoBoost (De 12.2010 -) 134kW 182cv 1596cm3 Veículo multiuso - ... ...</p> <p>155x133x75mm 1f-d23mm 4f-15x19mm</p>
	<p><b>S1867</b> NO. 1889406</p> <p><b>SILENT-BLOC DO BRAÇO SUSPENSÃO FRENTE</b></p> <p>FORD C-MAX II (DXA/CB7, DXA/CEU) 1.0 EcoBoost (De 2010.2012 -) 74kW 100cv 998cm3 Veículo multiuso - FORD C-MAX II (DXA/CB7, DXA/CEU) 1.0 EcoBoost (De 2010.2012 -) 92kW 125cv 998cm3 Veículo multiuso - FORD C-MAX II (DXA/CB7, DXA/CEU) 1.5 EcoBoost (De 2003.2015 -) 110kW 150cv 1498cm3 Veículo multiuso - FORD C-MAX II (DXA/CB7, DXA/CEU) 1.5 EcoBoost (De 2003.2015 -) 134kW 182cv 1498cm3 Veículo multiuso... ...</p> <p>d54x64mm d38mm c40mm 1f-d14mm</p>	 <p><b>S1867</b> NO. 1889406</p> <p><b>SILENT-BLOC DO BRAÇO SUSPENSÃO FRENTE</b></p> <p>FORD GRAND C-MAX (DXA/CB7, DXA/CEU) 1.0 EcoBoost (De 2010.2012 -) 74kW 100cv 998cm3 Veículo multiuso - FORD GRAND C-MAX (DXA/CB7, DXA/CEU) 1.0 EcoBoost (De 2010.2012 -) 92kW 125cv 998cm3 Veículo multiuso - FORD GRAND C-MAX (DXA/CB7, DXA/CEU) 1.5 EcoBoost (De 2003.2015 -) 110kW 150cv 1498cm3 Veículo multiuso - FORD GRAND C-MAX (DXA/CB7, DXA/CEU) 1.5 EcoBoost (De 2003.2015 -) 134kW 182cv 1498cm3 Veí... ...</p> <p>d54x64mm d38mm c40mm 1f-d14mm</p>
	<p><b>S2132</b> NO. 1702970 - 1702983 - 1709424 - 1709466 - 1749593 - 1749991 - 1749992 - 1793236</p> <p><b>SILENT-BLOC DO BRAÇO SUSPENSÃO FRENTE PARTE DA FRENTE</b></p> <p>FORD C-MAX II (DXA/CB7, DXA/CEU) 1.0 EcoBoost (10.2012 - 06.2019) 74kw 100cv 998cm3 Veículo multiuso FORD C-MAX II (DXA/CB7, DXA/CEU) 1.0 EcoBoost (10.2012 - 06.2019) 92kw 125cv 998cm3 Veículo multiuso FORD C-MAX II (DXA/CB7, DXA/CEU) 1.5 EcoBoost (03.2015 - 06.2019) 110kw 150cv 1498cm3 Veículo multiuso FORD C-MAX II (DXA/CB7, DXA/CEU) 1.5 EcoBoost (03.2015 - 06.2019) 134kw 182cv 1498cm3 Veículo m... ...</p> <p>d53x 65mm c-38mm-dc-31mm-1f-d14mm</p>	 <p><b>S2132</b> NO. 1702970 - 1702983 - 1709424 - 1709466 - 1749593 - 1749991 - 1749992 - 1793236</p> <p><b>SILENT-BLOC DO BRAÇO SUSPENSÃO FRENTE PARTE DA FRENTE</b></p> <p>FORD C-MAX II Van 1.0 EcoBoost (10.2012 - 06.2019) 74kw 100cv 998cm3 Caixa/monovolume FORD C-MAX II Van 1.0 EcoBoost (10.2012 - 06.2019) 92kw 125cv 998cm3 Caixa/monovolume FORD C-MAX II Van 1.5 EcoBoost (03.2015 - 06.2019) 110kw 150cv 1498cm3 Caixa/monovolume FORD C-MAX II Van 1.5 EcoBoost (03.2015 - 06.2019) 134kw 182cv 1498cm3 Caixa/monovolume FORD C-MAX II Van 1.5 TDCi EConetic (03.2015 - 06.20... ...</p> <p>d53x 65mm c-38mm-dc-31mm-1f-d14mm</p>
	<p><b>T1220</b> NO. 1715440</p> <p><b>BATENTE DA BARRA ESTABILIZADORA DA FRENTE</b></p> <p>FORD C-MAX II (DXA/CB7, DXA/CEU) 1.0 EcoBoost (De 10.2012 -) 74kW 100cv 998cm3 Veículo multiuso - FORD C-MAX II (DXA/CB7, DXA/CEU) 1.0 EcoBoost (De 10.2012 -) 92kW 125cv 998cm3 Veículo multiuso - FORD C-MAX II (DXA/CB7, DXA/CEU) 1.5 EcoBoost (De 03.2015 -) 110kW 150cv 1498cm3 Veículo multiuso - FORD C-MAX II (DXA/CB7, DXA/CEU) 1.5 EcoBoost (De 03.2015 -) 134kW 182cv 1498cm3 Veículo multiuso - FORD... ...</p> <p>44x46x52mm 1f-d21mm</p>	 <p><b>T1220</b> NO. 1715440</p> <p><b>BATENTE DA BARRA ESTABILIZADORA DA FRENTE</b></p> <p>FORD GRAND C-MAX (DXA/CB7, DXA/CEU) 1.0 EcoBoost (De 10.2012 -) 74kW 100cv 998cm3 Veículo multiuso - FORD GRAND C-MAX (DXA/CB7, DXA/CEU) 1.0 EcoBoost (De 10.2012 -) 92kW 125cv 998cm3 Veículo multiuso - FORD GRAND C-MAX (DXA/CB7, DXA/CEU) 1.5 EcoBoost (De 03.2015 -) 110kW 150cv 1498cm3 Veículo multiuso - FORD GRAND C-MAX (DXA/CB7, DXA/CEU) 1.5 EcoBoost (De 03.2015 -) 134kW 182cv 1498cm3 Veículo multiuso... ...</p> <p>44x46x52mm 1f-d21mm</p>
	<p><b>T1221</b> NO. 1810326</p> <p><b>BATENTE DA BARRA ESTABILIZADORA DA FRENTE</b></p> <p>FORD C-MAX (DM2) 1.6 (De 04.2007 Até 2009.2010) 85kW 116cv 1596cm3 Veículo multiuso FORD C-MAX II (DXA/CB7, DXA/CEU) 1.0 EcoBoost (De 10.2012 -) 74kW 100cv 998cm3 Veículo multiuso - FORD C-MAX II (DXA/CB7, DXA/CEU) 1.0 EcoBoost (De 10.2012 -) 92kW 125cv 998cm3 Veículo multiuso - FORD C-MAX II (DXA/CB7, DXA/CEU) 1.5 EcoBoost (De 03.2015 -) 110kW 150cv 1498cm3 Veículo multiuso - FORD C-MAX II (DXA/CB7, DXA/CEU) 1.5 EcoBoost (De 03.2015 -) 134kW 182cv 1498cm3 Veículo multiuso - FORD C-MAX II (DXA/CB... ...</p> <p>44x47x52mm 1f-d23mm</p>	 <p><b>T1221</b> NO. 1810326</p> <p><b>BATENTE DA BARRA ESTABILIZADORA DA FRENTE</b></p> <p>FORD GRAND C-MAX (DXA/CB7, DXA/CEU) 1.0 EcoBoost (De 10.2012 -) 74kW 100cv 998cm3 Veículo multiuso - FORD GRAND C-MAX (DXA/CB7, DXA/CEU) 1.0 EcoBoost (De 10.2012 -) 92kW 125cv 998cm3 Veículo multiuso - FORD GRAND C-MAX (DXA/CB7, DXA/CEU) 1.5 EcoBoost (De 03.2015 -) 110kW 150cv 1498cm3 Veículo multiuso - FORD GRAND C-MAX (DXA/CB7, DXA/CEU) 1.5 EcoBoost (De 03.2015 -) 134kW 182cv 1498cm3 Veículo multiuso... ...</p> <p>44x47x52mm 1f-d23mm</p>

	<p><b>U7033K</b> NO. 1212679 - 1212679 - 1332662 - 1474287 - 1S7C-3334-AA - 3M51-3334-AA</p> <p><b>ORINGS BOMBA DIREÇÃO ASSISTIDA</b></p> <p>FORD C-MAX (DM2) 1.6 (02.2007 -09.2010) 74kw 100cv 1596cm3 Veículo multiuso FORD C-MAX (DM2) 1.6 (04.2007 -09.2010) 85kw 116cv 1596cm3 Veículo multiuso FORD C-MAX (DM2) 1.6 TDCi (02.2007 -09.2010) 66kw 90cv 1560cm3 Veículo multiuso FORD C-MAX (DM2) 1.6 TDCi (02.2007 -09.2010) 74kw 101cv 1560cm3 Veículo multiuso FORD C-MAX (DM2) 1.6 TDCi (02.2007 -09.2010) 80kw 109cv 1560cm3 Veículo multiuso FORD ...</p> <p>d11x2mm d10x2mm 1f-d7mm 1f-d6mm</p>		<p><b>UAP81312</b> NO. 1715204 - 9M5Q9E568BA</p> <p><b>ANILHA DE PROTEÇÃO TÉRMICA INJECTORES</b></p> <p>FORD C-MAX II (DXA/CB7, DXA/CEU) 2.0 TDCi (De 02.2011 Até 06.2019) 85kW 115cv 1997cm3 Veículo multiuso - FORD C-MAX II (DXA/CB7, DXA/CEU) 2.0 TDCi (De 04.2010 Até 06.2019) 103kW 140cv 1997cm3 Veículo multiuso - FORD C-MAX II (DXA/CB7, DXA/CEU) 2.0 TDCi (De 12.2010 Até 06.2019) 120kW 163cv 1997cm3 Veículo multiuso</p> <p>d14x1.5mm 1f-d7mm</p>
	<p><b>UAP81312</b> NO. 1715204 - 9M5Q9E568BA</p> <p><b>ANILHA DE PROTEÇÃO TÉRMICA INJECTORES</b></p> <p>FORD GRAND C-MAX (DXA/CB7, DXA/CEU) 2.0 TDCi (De 02.2011 Até 06.2019) 85kW 115cv 1997cm3 Veículo multiuso - FORD GRAND C-MAX (DXA/CB7, DXA/CEU) 2.0 TDCi (De 02.2011 Até 06.2019) 100kW 136cv 1997cm3 Veículo multiuso - FORD GRAND C-MAX (DXA/CB7, DXA/CEU) 2.0 TDCi (De 02.2011 Até 06.2019) 103kW 140cv 1997cm3 Veículo multiuso - FORD GRAND C-MAX (DXA/CB7, DXA/CEU) 2.0 TDCi (De 12.2010 Até 06.2019) 120kW...</p> <p>d14x1.5mm 1f-d7mm</p>		<p><b>UAP81313</b> NO. 1364301 - 4M5Q9M577AA</p> <p><b>ANILHA PROTEÇÃO TÉRMICA INJECTORES</b></p> <p>FORD C-MAX (DM2) 1.8 TDCi 02.2007/09.2010 85KW 115CV 1753CC KKDA KKDB 8566AAN</p> <p>d13x2mm 1f-d7mm</p>
	<p><b>UAP83244</b> NO. 1230952 - 1432205 - 3M5QE568AA - M5Q9E568CA</p> <p><b>ANILHA PROTEÇÃO TÉRMICA INJECTORES</b></p> <p>FORD C-MAX II (DXA/CB7 - DXA/CEU) 1.5 TDCi (De 03-2015 Até .1-20 -) 70kW 95CV 1499cc Veículo multiuso FORD C-MAX II (DXA/CB7 - DXA/CEU) 1.5 TDCi (De 03-2015 Até .1-20 -) 88kW 120CV 1499cc Veículo multiuso</p> <p>d15x2mm 1f-d7mm</p>		<p><b>UAP83252</b> NO. 1700379 - AV6Q9E568AA</p> <p><b>ANILHA PROTEÇÃO TÉRMICA INJECTORES</b></p> <p>FORD C-MAX II (DXA/CB7, DXA/CEU) 1.6 TDCi (12.2010 -06.2019) 70kw 95cv 1560cm3 Veículo multiuso FORD C-MAX II (DXA/CB7, DXA/CEU) 1.6 TDCi (12.2010 -06.2019) 85kw 115cv 1560cm3 Veículo multiuso</p> <p>d15x2mm 1f-d6mm</p>
	<p><b>UAP83252</b> NO. 1700379 - AV6Q9E568AA</p> <p><b>ANILHA PROTEÇÃO TÉRMICA INJECTORES</b></p> <p>FORD GRAND C-MAX (DXA/CB7, DXA/CEU) 1.6 TDCi (12.2010 -06.2019) 70kw 95cv 1560cm3 Veículo multiuso FORD GRAND C-MAX (DXA/CB7, DXA/CEU) 1.6 TDCi (12.2010 -06.2019) 85kw 115cv 1560cm3 Veículo multiuso</p> <p>d15x2mm 1f-d6mm</p>		<p><b>UCRZ1080</b> NO. 1746601 - 1805656 - 97FG-3W007-AA</p> <p><b>CRUZETA VEIO TRANSMISSÃO TRIPOIDE D32MM/22 DENTES</b></p> <p>FORD C-MAX (DM2) 1.6 (De 02.2007 Até 09.2010) 74kW 100cv 1596cm3 Veículo multiuso - FORD C-MAX (DM2) 1.6 (De 04.2007 Até 09.2010) 85kW 116cv 1596cm3 Veículo multiuso - FORD FOCUS C-MAX (DM2) 1.6 (De 10.2003 Até 03.2007) 74kW 100cv 1596cm3 Veículo multiuso - FORD FOCUS C-MAX (DM2) 1.6 Ti (De 08.2004 Até 03.2007) 85kW 115cv 1596cm3 Veículo multiuso -</p> <p>d30mm (22 dentes)</p>
	<p><b>UCRZ1080</b> NO. 1746601 - 1805656 - 97FG-3W007-AA</p> <p><b>CRUZETA VEIO TRANSMISSÃO TRIPOIDE D32MM/22 DENTES</b></p> <p>FORD C-MAX II (DXA/CB7, DXA/CEU) 1.6 EcoBoost (De 12.2010 Até 06.2019) 110kW 150cv 1596cm3 Veículo multiuso - FORD C-MAX II (DXA/CB7, DXA/CEU) 1.6 EcoBoost (De 12.2010 Até 06.2019) 134kW 182cv 1596cm3 Veículo multiuso - FORD C-MAX II (DXA/CB7, DXA/CEU) 1.6 Flexifuel (De 02.2011 Até 06.2019) 88kW 120cv 1596cm3 Veículo multiuso - FORD C-MAX II (DXA/CB7, DXA/CEU) 1.6 LPG (De 02.2012 Até 06.2019) 86kW...</p> <p>d30mm (22 dentes)</p>		<p><b>UCRZ1092</b> NO. 1061888 - 1322224 - 1451974 - 1461228</p> <p><b>CRUZETA TRANSMISSÃO TRIPOIDE D33,90MM/23 DENTES</b></p> <p>FORD C-MAX (DM2) 1.8 (De 02.2007 Até 09.2010) 90kW 122cv 1798cm3 Veículo multiuso - FORD C-MAX (DM2) 1.8 (De 02.2007 Até 09.2010) 92kW 125cv 1798cm3 Veículo multiuso - FORD C-MAX (DM2) 1.8 Flexifuel (De 02.2007 Até 09.2010) 92kW 125cv 1798cm3 Veículo multiuso - FORD C-MAX (DM2) 2.0 (De 02.2007 Até 09.2010) 107kW 145cv 1999cm3 Veículo multiuso - FORD C-MAX (DM2) 2.0 CNG (De 04.2009 Até 09.2010) 107...</p> <p>d33.9mm (23 dentes)</p>
	<p><b>UCRZ1096</b> NO. 1113727 - 1364028 - 1454211 - 1475130 - 1486231 - 1528656 - 1552939 - 1552948 - 1686115</p> <p><b>CRUZETA TRANSMISSÃO TRIPOIDE D40MM/23 DENTES</b></p> <p>FORD C-MAX (DM2) 2.0 02.2007/09.2010 107KW 145CV 1999CC SYDA AODE AODB AODA 8566AAG - FORD C-MAX (DM2) 2.0 CNG 04.2009/09.2010 107KW 145CV 1999CC SYDA 8566AQU - FORD C-MAX (DM2) 2.0 LPG 06.2008/09.2010 107KW 145CV 1999CC SYDA 8566APT - FORD FOCUS C-MAX (DM2) 2.0 03.2004/03.2007 107KW 145CV 1999CC AODE SYDA AODB AODA 8566552 8566AAG</p> <p>d40mm (23 dentes)</p>		<p><b>UMV26813</b> NO. 1798600 - 7G9R7217CKD</p> <p><b>MANETE PUNHO TOPO ALAVANCA MUDANÇAS 6 VELOCIDADES F11/30MM</b></p> <p>FORD C-MAX (DM2): 1.6 02.2007/09.2010 74KW 100CV 1596CC - FORD C-MAX (DM2): 1.6 04.2007/09.2010 85KW 116CV 1596CC - FORD C-MAX (DM2): 1.8 02.2007/09.2010 90KW 122CV 1798CC - FORD C-MAX (DM2): 1.8 02.2007/09.2010 92KW 125CV 1798CC - FORD C-MAX (DM2): 1.8 02.2007/09.2010 92KW 125CV 1798CC - FORD C-MAX (DM2): 1.8 Flexifuel 02.2007/09.2010 92KW 125CV 1798CC - FORD C-MAX (DM2): 2.0 02.2007/09.2010 107KW 145CV 1999CC AODE SYDA AODB AODA 8566552 8566AAG</p> <p>53x47x54mm 1f-d11/30mm</p>
	<p><b>UPCR5004</b> NO. 1454051 - 1567143 - 1678260</p> <p><b>PORCA DA RODA CHAVE 19 M12X1,50X30MM ( BASE CONICA )</b></p> <p>FORD C-MAX (DM2) 1.6 (02.2007 -09.2010) 74kw 100cv 1596cm3 Veículo multiuso FORD C-MAX (DM2) 1.6 TDCi (02.2007 -09.2010) 66kw 90cv 1560cm3 Veículo multiuso FORD C-MAX (DM2) 1.6 TDCi (02.2007 -09.2010) 74kw 101cv 1560cm3 Veículo multiuso FORD C-MAX (DM2) 1.6 TDCi (02.2007 -09.2010) 80kw 109cv 1560cm3 Veículo multiuso FORD C-MAX (DM2) 1.8 (02.2007 -09.2010) 90kw 122cv 1798cm3 Veículo multiuso FORD C...</p> <p>d26x32mm M12x1,5mm</p>		<p><b>UPCR5004</b> NO. 1454051 - 1567143 - 1678260</p> <p><b>PORCA DA RODA CHAVE 19 M12X1,50X30MM ( BASE CONICA )</b></p> <p>FORD C-MAX II (DXA/CB7, DXA/CEU) 1.0 EcoBoost (10.2012 -06.2019) 74kw 100cv 998cm3 Veículo multiuso FORD C-MAX II (DXA/CB7, DXA/CEU) 1.0 EcoBoost (10.2012 -06.2019) 92kw 125cv 998cm3 Veículo multiuso FORD C-MAX II (DXA/CB7, DXA/CEU) 1.6 EcoBoost (12.2010 -06.2019) 110kw 150cv 1596cm3 Veículo multiuso FORD C-MAX II (DXA/CB7, DXA/CEU) 1.6 EcoBoost (12.2010 -06.2019) 134kw 182cv 1596cm3 Veículo multi...</p> <p>d26x32mm M12x1,5mm</p>
	<p><b>UPCR5004</b> NO. 1454051 - 1567143 - 1678260</p> <p><b>PORCA DA RODA CHAVE 19 M12X1,50X30MM ( BASE CONICA )</b></p> <p>FORD GRAND C-MAX (DXA/CB7, DXA/CEU) 1.0 EcoBoost (10.2012 -06.2019) 74kw 100cv 998cm3 Veículo multiuso FORD GRAND C-MAX (DXA/CB7, DXA/CEU) 1.0 EcoBoost (10.2012 -06.2019) 92kw 125cv 998cm3 Veículo multiuso FORD GRAND C-MAX (DXA/CB7, DXA/CEU) 1.6 EcoBoost (12.2010 -06.2019) 110kw 150cv 1596cm3 Veículo multiuso FORD GRAND C-MAX (DXA/CB7, DXA/CEU) 1.6 EcoBoost (12.2010 -06.2019) 134kw 182cv 1596cm3 V...</p> <p>d26x32mm M12x1,5mm</p>		<p><b>UPCR5018</b> NO. 1007487 - 1447852 - 1470843</p> <p><b>PORCA DA RODA CHAVE 19 M12X1,50X16MM ( BASE CONICA PARA JANTE DE AÇO )</b></p> <p>FORD C-MAX (DM2) 1.6 (02.2007 - 09.2010) 74kw 100cv 1596cm3 Veículo multiuso FORD C-MAX (DM2) 1.6 (04.2007 - 09.2010) 85kw 116cv 1596cm3 Veículo multiuso FORD C-MAX (DM2) 1.6 TDCi (02.2007 - 09.2010) 66kw 90cv 1560cm3 Veículo multiuso FORD C-MAX (DM2) 1.6 TDCi (02.2007 - 09.2010) 74kw 101cv 1560cm3 Veículo multiuso FORD C-MAX (DM2) 1.6 TDCi (02.2007 - 09.2010) 80kw 109cv 1560cm3 Veículo multiuso F...</p> <p>d19x15mm M12x15mm</p>







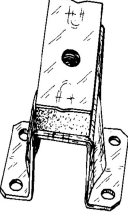
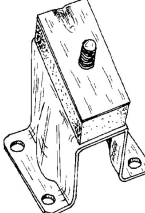

	<p><b>W5165</b> NO. 1539704 - 1752282 - 8A6G6B321AB - 8A6G6B321AC</p> <p>POLIE DA CAMBOTA (6 PISTAS)</p> <p>FORD C-MAX II (DXA/CB7 - DXA/CEU) 1.6 Ti (De 12-2010 Até .1-20 -) 77kW 105CV 1596cc Veículo multiuso FORD C-MAX II (DXA/CB7 - DXA/CEU) 1.6 LPG (De 02-2012 Até .1-20 -) 88kW 120CV 1596cc Veículo multiuso FORD C-MAX II (DXA/CB7 - DXA/CEU) 1.6 Ti (De 02-2012 Até .1-20 -) 88kW 120CV 1596cc Veículo multiuso FORD C-MAX II (DXA/CB7 - DXA/CEU) 1.6 Flexifuel (De 02-2011 Até .1-20 -) 88kW 120CV 1596cc Ve...</p> <p>d138mm d25mm</p>		<p><b>W5165</b> NO. 1539704 - 1752282 - 8A6G6B321AB - 8A6G6B321AC</p> <p>POLIE DA CAMBOTA (6 PISTAS)</p> <p>FORD GRAND C-MAX (DXA/CB7 - DXA/CEU) 1.6 Ti (De 12-2010 Até .1-20 -) 77kW 105CV 1596cc Veículo multiuso FORD GRAND C-MAX (DXA/CB7 - DXA/CEU) 1.6 Ti (De 12-2010 Até .1-20 -) 92kW 125CV 1596cc Veículo multiuso</p> <p>d138mm d25mm</p>
	<p><b>W5177</b> NO. 1305988 - 1490906 - 1753154 - 4M5G-6B32-1ZA - 4M5G-6B32-1ZB - 4M5G-6B321-ZC</p> <p>POLIE DA CAMBOTA (5 + 6 PISTAS)</p> <p>FORD C-MAX (DM2): 1.6 02.2007/09.2010 74KW 100CV 1596CC - FORD C-MAX (DM2): 1.6 04.2007/09.2010 85KW 116CV 1596CC - FORD C-MAX (DM2): 1.6 02.2007/09.2010 74KW 100CV 1596CC - FORD C-MAX II (DXA/CB7, DXA/CEU): 1.6 Ti 12.2010/&gt;&gt;&gt; 77KW 105CV 1596CC - FORD C-MAX II (DXA/CB7, DXA/CEU): 1.6 Ti 12.2010/&gt;&gt;&gt; 92KW 125CV 1596CC</p> <p>d138mm d24mm</p>		<p><b>W5181</b> NO. 1141497 - 1753151 - 2S6G6B321AA - 2S6G6B321AB</p> <p>POLIE DA CAMBOTA (5+6 PISTAS)</p> <p>FORD FOCUS C-MAX (DM2): 1.6 10.2003/03.2007 74KW 100CV 1596CC - FORD FOCUS C-MAX (DM2): 1.6 TDCi 10.2003/03.2007 80KW 109CV 1560CC</p> <p>d138/83mm d24mm</p>
	<p><b>Z50130</b> NO. 11589289</p> <p>MOLA REBITE FIXAÇÃO</p> <p>FORD C-MAX II (DXA/CB7, DXA/CEU) 1.0 EcoBoost (10.2012 -06.2019) 74kw 100cv 998cm3 Veículo multiuso FORD C-MAX II (DXA/CB7, DXA/CEU) 1.0 EcoBoost (10.2012 -06.2019) 92kw 125cv 998cm3 Veículo multiuso FORD C-MAX II (DXA/CB7, DXA/CEU) 1.0 EcoBoost (07.2018 -06.2019) 74kw 100cv 999cm3 Veículo multiuso FORD C-MAX II (DXA/CB7, DXA/CEU) 1.0 EcoBoost (07.2018 -06.2019) 92kw 125cv 999cm3 Veículo multiuso ...</p> <p>d6x 18mm f-d17mm</p>		<p><b>Z50130</b> NO. 11589289</p> <p>MOLA REBITE FIXAÇÃO</p> <p>FORD GRAND C-MAX (DXA/CB7, DXA/CEU) 1.0 EcoBoost (10.2012 -06.2019) 74kw 100cv 998cm3 Veículo multiuso FORD GRAND C-MAX (DXA/CB7, DXA/CEU) 1.0 EcoBoost (10.2012 -06.2019) 92kw 125cv 998cm3 Veículo multiuso FORD GRAND C-MAX (DXA/CB7, DXA/CEU) 1.0 EcoBoost (07.2018 -06.2019) 74kw 100cv 999cm3 Veículo multiuso FORD GRAND C-MAX (DXA/CB7, DXA/CEU) 1.0 EcoBoost (07.2018 -06.2019) 92kw 125cv 999cm3 Veículo multiuso ...</p> <p>d6x 18mm f-d17mm</p>
	<p><b>Z50130</b> NO. 11589289</p> <p>MOLA REBITE FIXAÇÃO</p> <p>FORD GRAND C-MAX Van 1.0 EcoBoost (10.2012 -06.2018) 74kw 100cv 998cm3 Caixa/monovolume FORD GRAND C-MAX Van 1.0 EcoBoost (10.2012 -06.2019) 92kw 125cv 998cm3 Caixa/monovolume FORD GRAND C-MAX Van 1.5 EcoBoost (03.2015 -06.2019) 110kw 150cv 1498cm3 Caixa/monovolume FORD GRAND C-MAX Van 1.5 TDCi (03.2015 -06.2019) 88kw 120cv 1499cm3 Caixa/monovolume FORD GRAND C-MAX Van 1.6 EcoBoost (12.2010 -06.20...</p> <p>d6x 18mm f-d17mm</p>		<p><b>Z57104</b> NO. 4831516</p> <p>MOLA DO PAINEL DA PORTA</p> <p>FORD C-MAX (A partir de 2015)</p> <p>F12mm T21mm L18mm 28mm S1-12mm</p>
	<p><b>Z80848</b> NO. 1257376 - W709004S300</p> <p>Mola de painel</p> <p>FORD C-MAX (De 2003 A 2010)</p> <p>d18x27.5mm 1p-d8.5-10.5mm</p>		



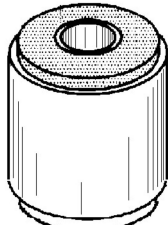
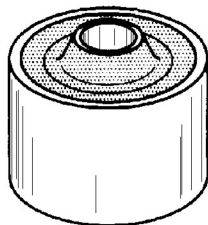

FORD CORTINA- P100 PICK-UP

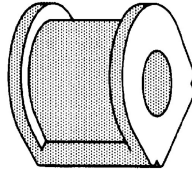
	<p><b>A0466</b> NO. 113E-6038A - 1710256 - 1743751</p> <p>APOIO DE MOTOR FRENTE DIREITO E ESQUERDO</p> <p>FORD CORTINA MK1 1200,1500 1962/1966</p> <p>80x82x78mm 1r-d10mm 4f-d9mm</p>		<p><b>A0551</b> NO. 3f-d9mm (distância entre furos 83m)</p> <p>APOIO DA CAIXA DE VELOCIDADES</p> <p>FORD CORTINA</p> <p>111x68x40mm 3f-d9mm (distância entre furos 83mm)...</p>
	<p><b>A0644</b> NO. 3034E - 691F-6038B</p> <p>APOIO SUPORTE DO MOTOR S/ PERNO</p> <p>FORD CORTINA</p> <p>128x91x86mm 1r-d8mm</p>		<p><b>A0644P</b> NO. 1463559 - 1477079 - 3034E - 691F-6038AB - 701F 6038 AB</p> <p>APOIO SUPORTE DO MOTOR C/ PERNO</p> <p>FORD CORTINA MK II 1300CC 1966/08.1967 - FORD CORTINA MK II 1300CC 08.1967/1970</p> <p>135x92x90mm 1p-d10-22mm</p>

	<p><b>E0008</b> NO. 0801909 - 1591419 - 6030483 - 70GB5281AA - 801909</p> <p>ESTICADOR DE ESCAPE</p> <p>FORD CORTINA MK III - MK IV</p>		<p><b>F0462-I</b> NO. 1568353 - 1568676</p> <p>FOLE DA CREMALHEIRA DA DIREÇÃO ESQ. E DIR.</p> <p>FORD CORTINA</p>
	<p><b>F0463-I</b> NO. 1568355</p> <p>FOLE DA DIREÇÃO ESQUERDO</p> <p>FORD CORTINA - TAUNUS - CAPRI 3000 - P100 PICK UP</p>		<p><b>F0599-M</b> NO. 428028</p> <p>FOLE DA TRANSMISSÃO</p> <p>FORD CORTINA</p>
	<p><b>F4022</b> NO. 1568353</p> <p>FOLE DIREÇÃO ESQUERDO</p> <p>FORD CORTINA 1100 (1970 A 1972)</p>		<p><b>F4022</b> NO. 1568353</p> <p>FOLE DIREÇÃO ESQUERDO</p> <p>FORD TAUNUS 12M 1.3 (1966 A 1971)</p>
	<p><b>F4023</b> NO. 1568355</p> <p>FOLE DIREÇÃO DIREITO</p> <p>FORD CORTINA 1100 (1970 A 1972)</p>		<p><b>L0221</b> NO. 105E-5719 - 1710123</p> <p>CASQUILHO DE MOLAS</p> <p>FORD CORTINA MK I 1200, 1500CC 1962/1966 - FORD CORTINA MK I, II 1959/1969 - FORD CORTINA MK II 1966/1970 - FORD CORTINA MK II 1300CC 1966/08.1967 - FORD CORTINA MK II 1300CC 08.1967/1970 - FORD CORTINA MK II 1500CC 1966/1967</p>
	<p><b>L0262</b> NO. 1487654</p> <p>CASQUILHO SILENT-BLOCO BRAÇO SUSPENSÃO FRENTE ( GASTA 2 UNIDADES )</p> <p>FORD CORTINA: 1300 10.1966/03.1972 40KW 54CV 1298CC - FORD CORTINA: 1600 GT 10.1967/09.1970 60KW 82CV 1599CC - FORD CORTINA Coupé: 1300 10.1966/03.1972 37KW 50CV 1298CC - FORD CORTINA Coupé: 1300 10.1966/03.1972 40KW 54CV 1298CC</p>		<p><b>L1030</b> NO. 1412951 - 1421951 - 6100095</p> <p>CASQUILHO DE BRAÇOS DE SUSPENSÃO</p> <p>FORD CORTINA: 1300 10.1966/03.1972 40KW 54CV 1298CC - FORD CORTINA: 1600 GT 10.1967/09.1970 60KW 82CV 1599CC - FORD CORTINA Coupé: 1300 10.1966/03.1972 37KW 50CV 1298CC - FORD CORTINA Coupé: 1300 10.1966/03.1972 40KW 54CV 1298CC</p>
	<p><b>L1044</b> NO. 1487654</p> <p>CASQUILHO SILENT-BLOCO BRAÇO SUSPENSÃO FRENTE ( GASTA 2 UNIDADES )</p> <p>FORD CORTINA: 1300 10.1966/03.1972 40KW 54CV 1298CC - FORD CORTINA: 1600 GT 10.1967/09.1970 60KW 82CV 1599CC - FORD CORTINA Coupé: 1300 10.1966/03.1972 37KW 50CV 1298CC - FORD CORTINA Coupé: 1300 10.1966/03.1972 40KW 54CV 1298CC</p>		<p><b>L3008</b> NO. 1610371</p> <p>CASQUILHO DA DIREÇÃO</p> <p>FORD CORTINA 1100 (01-1970 A 03-1972)</p>
	<p><b>L3015</b> NO.</p> <p>CASQUILHO DA BARRA ESTABILIZADORA</p> <p>FORD CORTINA</p>		<p><b>L3041</b> NO. 6005983 - 74BB.3B197.AA</p> <p>CASQUILHO DA BARRA ESTABILIZADORA</p> <p>FORD CORTINA - TAUNUS (1976 A 1992)</p>
	<p><b>L3043</b> NO. 1481463 - 1481464 - 71BB.5K498.BB - LEM1700</p> <p>CASQUILHO DAS PONTAS DA BARRA ESTABILIZADORA</p> <p>FORD CORTINA 1300 10.1966/03.1972 40KW 54CV 1298CC KL 13 H - FORD CORTINA 1600 01.1970/03.1972 45KW 62CV 1599CC OHV KL 16 L - FORD CORTINA 1600 10.1970/03.1972 50KW 68CV 1599CC OHV KL 16 L - FORD CORTINA 1600 GT 10.1967/09.1970 60KW 82CV 1599CC KL 16 G - FORD CORTINA 1600 GT 10.1970/03.1972 63KW 86CV 1593CC LCJ - FORD CORTINA Coupé 1300 10.1966/03.1972 37KW 50CV 1298CC KL 13 L - FORD CORTINA 1300 ...</p>		<p><b>N1617</b> NO.</p> <p>ANEL DE ESCAPE</p> <p>FORD CORTINA</p>

	<p><b>N2002</b> NO. 113E5381B - 1719466</p> <p>ANEL DE ESCAPE</p> <p>FORD CORTINA 1200 - 1300 - 1500 - GT</p> <p>d43x12mm 1f-d19mm</p>		<p><b>R220442</b> NO. 105E8260A - 1465390 - 1546886 - 691F8260AA - 691G8260AA - 72AB8260AA</p> <p>TUBO DE RADIADOR SUPERIOR</p> <p>FORD CORTINA: 1300 10.1966/03.1972 40KW 54CV 1298CC - FORD CORTINA: 1600 GT 10.1970/03.1972 63KW 86CV 1593CC - FORD CORTINA: 1600?01.1970/03.1972 45KW 62CV 1599CC - FORD CORTINA: 1600 10.1970/03.1972 50KW 68CV 1599CC - FORD CORTINA: 1600 GT 10.1967/09.1970 60KW 82CV 1599CC - FORD CORTINA Coupé: 1300 10.1966/03.1972 37KW 50CV 1298CC - FORD CORTINA Coupé: 1300 10.1966/03.1972 40KW 54CV 1298CC - FORD...</p> <p>B190-d31/38mm 40-150-150mm</p>
	<p><b>S1039</b> NO. 1505928 - 6099528 - 81BB.5K789.AA</p> <p>SILENT-BLOC DE VAUS DE SUSPENSÃO (FURO 13mm)</p> <p>FORD CORTINA: 1300 10.1966/03.1972 40KW 54CV 1298CC - FORD CORTINA: 1600 GT 10.1970/03.1972 63KW 86CV 1593CC - FORD CORTINA: 1600 GT 10.1967/09.1970 60KW 82CV 1599CC - FORD CORTINA Coupé: 1300 10.1966/03.1972 37KW 50CV 1298CC - FORD CORTINA Coupé: 1300 10.1966/03.1972 40KW 54CV 1298CC</p> <p>d39x46mm c32mm 1fd13mm</p>		<p><b>S1047</b> NO. 1517555 - 1551776 - 6099529 - 6099529 - 81BB.5K790.AA</p> <p>SILENT-BLOC DO TRIANGULO DA SUSPENSÃO</p> <p>FORD CORTINA: 1300 10.1966/03.1972 40KW 54CV 1298CC - FORD CORTINA: 1600 GT 10.1970/03.1972 63KW 86CV 1593CC</p> <p>d43x65mm c52mm 1f-d12mm</p>
	<p><b>S1863</b> NO. 6018791</p> <p>SILENT-BLOC DO BRAÇO SUSPENSÃO DE TRÁS PARTE DA FRENTE</p> <p>FORD CORTINA: 1300 10.1966/03.1972 40KW 54CV 1298CC - FORD CORTINA: 1600 GT 10.1970/03.1972 63KW 86CV 1593CC - FORD CORTINA: 1600 GT 10.1967/09.1970 60KW 82CV 1599CC - FORD CORTINA Coupé: 1300 10.1966/03.1972 37KW 50CV 1298CC - FORD CORTINA Coupé: 1300 10.1966/03.1972 40KW 54CV 1298CC</p> <p>d39x44mm c33mm 1f-d12mm</p>		<p><b>S1864</b> NO. 1481426</p> <p>SILENT-BLOC DO BRAÇO SUSPENSÃO DE TRÁS</p> <p>FORD CORTINA: 1600 GT 10.1970/03.1972 63KW 86CV 1593CC</p> <p>d43x44mm c33mm 1f-d12mm</p>
	<p><b>S1865</b> NO. 6028454 - 76BB5K792AA</p> <p>SILENT-BLOC DO BRAÇO SUSPENSÃO TRÁS PARTE INFERIOR</p> <p>FORD CORTINA: 1300 10.1966/03.1972 40KW 54CV 1298CC - FORD CORTINA: 1600 GT 10.1970/03.1972 63KW 86CV 1593CC - FORD CORTINA Coupé: 1300 10.1966/03.1972 37KW 50CV 1298CC - FORD CORTINA Coupé: 1300 10.1966/03.1972 40KW 54CV 1298CC</p> <p>d51x44mm c36mm 1f-d12mm</p>		<p><b>T0003</b> NO. 0204460 - 204460</p> <p>BATENTE DA BARRA ESTABILIZADORA</p> <p>FORD CORTINA</p> <p>41x39x36mm 1f-d18mm</p>

FORD COUGAR





	<p><b>A1388</b> NO. 6838725 - 93BB.18198.BC</p> <p>APOIO DA SUSPENSÃO DE TRÁS (AMORTECEDOR)</p> <p>FORD COUGAR (EC_) 2.0 16V 08.1998/12.2001 96KW 131CV 1988CC EDBA EDBD EDBC EDBB 8566341 - FORD COUGAR (EC_) 2.5 V6 24V 08.1998/12.2001 125KW 170CV 2544CC - FORD COUGAR (EC_) LCBA LCBB LCBC LCBE 8566342 - FORD COUGAR (EC_) 2.5 V6 24V 06.2000/12.2001 125KW 170CV 2495CC LCBC LCBB LCBE 8566372</p> <p>174x172x44mm 1f-d12mm 2f-d8mm</p>		<p><b>A1591</b> NO. 1024959 - 1097914 - 6803993 - 6911968 - 98BB.6P082.AA</p> <p>APOIO CAIXA VELOCIDADES</p> <p>FORD COUGAR (EC_) 2.0 16V 08.1998/12.2001 96KW 131CV 1988CC EDBA EDBD EDBC EDBB 8566341 - FORD COUGAR (EC_) 2.5 ST 200 01.2000/12.2001 151KW 205CV 2495CC SGA 8566373 - FORD COUGAR (EC_) 2.5 V6 24V 08.1998/12.2001 125KW 170CV 2544CC LCBA LCBB LCBC LCBE 8566342 - FORD COUGAR (EC_) 2.5 V6 24V 06.2000/12.2001 125KW 170CV 2495CC LCBC LCBB LCBE 8566372</p> <p>140x130x125mm 1f-d20mm</p>
	<p><b>A1593</b> NO. 1793880 - 6799585 - 93BB.3K155.AC - 93BB3K1555AC - 93BJ.3K155.AC - 93BB3K155AB</p> <p>APOIO AMORTECEDOR FRENTE ( GASTA 2 UNIDADES )</p> <p>FORD COUGAR (EC_) 2.0 16V 08.1998/12.2001 96KW 131CV 1988CC EDBA EDBD EDBC EDBB 8566341 - FORD COUGAR (EC_) 2.5 ST 200 01.2000/12.2001 151KW 205CV 2495CC SGA 8566373 - FORD COUGAR (EC_) 2.5 V6 24V 08.1998/12.2001 125KW 170CV 2544CC LCBA LCBB LCBC LCBE 8566342 - FORD COUGAR (EC_) 2.5 V6 24V 06.2000/12.2001 125KW 170CV 2495CC LCBC LCBB LCBE 8566372</p> <p>d120x51mm 1f-d12mm</p>		<p><b>C0231</b> NO. 6483712 - 91AB.16C618.AA</p> <p>BOTÃO DE AFINAÇÃO DE CAPOT</p> <p>FORD COUGAR (1998 A 2000)</p> <p>d27x44mm</p>
	<p><b>E1018</b> NO. 1027374 - 6831302 - 6866417 - 93B85A262F - 93B85A262G - 93BB5A262GA</p> <p>ESTICADOR DE ESCAPE</p> <p>FORD COUGAR</p> <p>66x54x19mm</p>		<p><b>F1618-I</b> NO. 157C3K661AB - 3904122 - 4119193 - 6772173 - F6RC.3K661.AA</p> <p>FOLE DA DIREÇÃO ASSISTIDA LADO DIREITO E ESQUERDO</p> <p>FORD COUGAR APÓS 1998 2.0 16V - 2.5i V6 24V</p> <p>d58x215mm 1f-d55mm 1f-d15mm</p>

	<b>F1659E-I</b> NO. 1016769 - 6757643 - 6757645 - 93BG3L537AB - 93BG3L537CB FOLE DA TRANSMISSÃO JUNTO À CAIXA FORD COUGAR 2.0 16V - 2.5i V6 24V (APÓS 98)		<b>F1835-T</b> NO. 1073937 - 3940332 - F8RZ3A331C FOLE DA TRANSMISSÃO JUNTO À RODA FORD COUGAR 2.0 16V - 2.5i V6 24V (APÓS 1998)
	d96x126mm 1f-d85mm 1f-d25mm		d96x135mm 1f-d89mm 1f-d25mm
	<b>F4021</b> NO. 3904122 - F33.3K661.AA - F6RC3K661AA FOLE DIREÇÃO ASSISTIDA ( GASTA 2 UNIDADES ) FORD COUGAR 2.0 - 2.5i (APÓS 1998)		<b>KF9000</b> NO. 1073937 - 3940332 - F8RZ3A331C KIT DE FOLE LADO DA RODA FORD COUGAR 2.0 - 2.5i (APÓS 1998)
	d62x210mm d58mm d51mm 1f-d53mm 1f-d16mm		d95x135mm 1f-d92mm 1f-d25mm
	<b>P1010</b> NO. 1526242 - 72EB2457BA CAPA DE PEDAL DO TRAVÃO E EMBRAIAGEM FORD COUGAR (EC_) 2.0 16V 08.1998/12.2001 96KW 131CV 1988CC - FORD COUGAR (EC_) 2.0 16V 08.1998/12.2001 96KW 131CV 1988CC - FORD COUGAR (EC_) 2.5 V6 24V 06.2000/12.2001 125KW 170CV 2495CC - FORD COUGAR (EC_) 2.5 V6 24V 06.2000/12.2001 125KW 170CV 2495CC - FORD COUGAR (EC_) 2.5 V6 24V 08.1998/12.2001 125KW 170CV 2544CC (EC_) 2.5 V6 24V 08.1998/12.2001 125KW 170CV 2544CC (EC_) 2.5 V6 24V 08.1998/12.2001 125KW 170CV 2544CC		<b>P1026</b> NO. 6168375 - 89FB.2457.AA CAPA DE PEDAL TRAVÃO E EMBRAIAGEM FORD COUGAR (EC_) 2.0 16V 08.1998/12.2001 96KW 131CV 1988CC - FORD COUGAR (EC_) 2.5 V6 24V 06.2000/12.2001 125KW 170CV 2495CC - FORD COUGAR (EC_) 2.5 V6 24V 08.1998/12.2001 125KW 170CV 2544CC
	68x49x15mm PINO-39x11x4mm		68x54x14mm
	<b>RT08648</b> NO. 1025018 - 1071639 TUBO DE TRAVÃO TRÁS LH-RH FORD MONDEO II TRE VOLUMI 1.6 i (09-1996 A 11-2000) - MONDEO II TRE VOLUMI 1.6 i 16V (05-1998 A 11-2000) - MONDEO II TRE VOLUMI 1.8 i (09-1996 A 11-2000) - MONDEO II TRE VOLUMI 1.8 D (09-1996 A 11-2000) - MONDEO II TRE VOLUMI 2.0 i (09-1996 A 11-2000)		<b>S1445</b> NO. 1041683 - 1093772 - 1116608 - 1123275 - 1220005 - 1325326 - 1S71-5500-AA - 1S71-5500-AC - 1S... SILENT-BLOC DO BRAÇO DA SUSPENSÃO FORD COUGAR 2.0 16V - 2.5 V6 24V - 2.5 ST 200 (98 A 2001)
	ponteira-1MC11ponteira-2MC45x50mm		d36.5x35mm c28mm 1f-12.2mm
	<b>S2129</b> NO. 6782218 - 85352 - 93BB-5A103-AA - 93BBSA103AA - F5RZ-5A103-B - F5RZ5A103B SILENT-BLOC DA SUSPENSÃO FRENTE PARTE FRENTE FORD COUGAR (EC_) 2.0 16V 08.1998/12.2001 96KW 131CV 1988CC EDDB EDDB EDDB EDDB 8566341 - FORD COUGAR (EC_) 2.5 ST 200 01.2000/12.2001 151KW 205CV 2495CC SGA 8566373 - FORD COUGAR (EC_) 2.5 V6 24V 08.1998/12.2001 125KW 170CV 2544CC LCBA LCBB LCBC LCBE 8566342 - FORD COUGAR (EC_) 2.5 V6 24V 06.2000/12.2001 125KW 170CV 2495CC LCBC LCBB LCBE 8566372		<b>T1051</b> NO. 6714195 BATENTE DO CENTRO DA BARRA ESTABILIZADORA (FURO DIÂMETRO 20mm) FORD COUGAR 2.0 16V - 2.5 V6 24V - 2.5 ST200 (1998 A 2001)
	d54x40mm c27mm d44mm 1f-d14mm		43x39x30mm 1f-d20mm
	<b>UCRZ1087</b> NO. 1046892 - 1214378 - 1214381 - 1236787 - 1355195 - 1355198 - 1356229 - 1365235 CRUZETA VEIO TRANSMISSÃO TRIPOIDE D38,50MM/33 DENTES FORD COUGAR (EC_) 2.0 16V (De 08.1998 Até 12.2001) 9469kW 96cv 131cm3 1988 - FORD COUGAR (EC_) 2.5 V6 24V (De 08.1998 Até 12.2001) 9470kW 125cv 170cm3 2544 -		<b>UMV25326</b> NO. 7255562 - 94ZT7217AA MANETE PUNHO TOPO ALAVANCA MUDANÇAS 5 VELOCIDADES F13MM FORD COUGAR (EC_) 2.0 16V 08.1998/12.2001 96KW 131CV 1988CC EDDB EDDB EDDB EDDB 8566341 - FORD COUGAR (EC_) 2.5 ST 200 01.2000/12.2001 151KW 205CV 2495CC SGA 8566373 - FORD COUGAR (EC_) 2.5 V6 24V 08.1998/12.2001 125KW 170CV 2544CC LCBA LCBB LCBC LCBE 8566342 - FORD COUGAR (EC_) 2.5 V6 24V 06.2000/12.2001 125KW 170CV 2495CC LCBC LCBB LCBE 8566372
	d38.5mm (33 dentes)		53x48x52mm 1f-d13mm
	<b>UMV25326</b> NO. 7255562 - 94ZT7217AA MANETE PUNHO TOPO ALAVANCA MUDANÇAS 5 VELOCIDADES F13MM FORD MONDEO I (GBP) 1.6 i 16V 02.1993/08.1996 66KW 90CV 1597CC L1F 0928831 - FORD MONDEO I (GBP) 1.6 i 16V 07.1994/08.1996 65KW 88CV 1597CC L1J 0928884 - FORD MONDEO I (GBP) 1.8 i 16V 02.1993/08.1996 85KW 115CV 1796CC RKA 0928833 - FORD MONDEO I (GBP) 1.8 i 16V 07.1994/08.1996 82KW 112CV 1796CC RKB 0928869 - FORD MONDEO I (GBP) 1.8 i 16V 4x4 02.1993/08.1996 85KW 115CV 1796CC RKA - FORD MONDEO I (G...		<b>UMV25326</b> NO. 7255562 - 94ZT7217AA MANETE PUNHO TOPO ALAVANCA MUDANÇAS 5 VELOCIDADES F13MM FORD MONDEO II (BAP) 1.6 i 08.1996/09.2000 66KW 90CV 1597CC L1J 8566305 - FORD MONDEO II (BAP) 1.6 i 16V 05.1998/09.2000 70KW 95CV 1597CC L1L L1N L1Q 8566344 - FORD MONDEO II (BAP) 1.8 i 08.1996/09.2000 85KW 115CV 1796CC RKB RKJ RKF RKH RKK 8566306 - FORD MONDEO II (BAP) 1.8 TD 08.1996/09.2000 66KW 90CV 1753CC RFN 8566307 - FORD MONDEO II (BAP) 2.0 i 08.1996/09.2000 96KW 131CV 1988CC NGD NGB NGC...
	53x48x52mm 1f-d13mm		53x48x52mm 1f-d13mm
	<b>UPCR5004</b> NO. 1454051 - 1567143 - 1678260 PORCA DA RODA CHAVE 19 M12X1,50X30MM ( BASE CONICA ) FORD COUGAR (EC_) 2.0 16V (08.1998 -12.2001) 96kw 131cv 1988cm3 Coupé FORD COUGAR (EC_) 2.5 ST 200 (01.2000 -12.2001) 151kw 205cv 2495cm3 Coupé FORD COUGAR (EC_) 2.5 V6 24V (06.2000 -12.2001) 125kw 170cv 2495cm3 Coupé FORD COUGAR (EC_) 2.5 V6 24V (08.1998 -12.2001) 125kw 170cv 2544cm3 Coupé		<b>UTR0800</b> NO. 1647750 - 1647751 - 1650630 - 1659287 - 1659288 - 6157002 - 6160686 - 6854060 - 6893213 - 7267962 - ... TAMPÃO RESERVATÓRIO LIQUIDO REFRIGERAÇÃO FORD COUGAR (EC_) 2.0 16V (08.98 A 12.01) 131cv 1988cc Coupé - FORD COUGAR (EC_) 2.5 V6 24V (06.00 A 12.01) 170cv 2495cc Coupé - FORD COUGAR (EC_) 2.5 V6 24V (08.98 A 12.01) 170cv 2544cc Coupé - FORD COUGAR (EC_) 2.5 ST 200 (01.00 A 12.01) 205cv 2495cc Coupé
	d26x32mm M12x1,5mm		d62x25mm 1f-d53x14mm



	<p><b>UTR0819</b> NO. 1000249 - 1025558 - 1049625 - 1078160 - 1230968 - 97BB8K218DA - 97BB8K218DB - 97BB8K218DC - 98BB8100...</p> <p><b>TAMPÃO RESERVATÓRIO LIQUIDO REFRIGERAÇÃO</b></p> <p>FORD COUGAR (EC_) 2.0 16V (08.98 A 12.01) 131cv 1988cc Coupé - FORD COUGAR (EC_) 2.5 V6 24V (06.00 A 12.01) 170cv 2495cc Coupé - FORD COUGAR (EC_) 2.5 V6 24V (08.98 A 12.01) 170cv 2544cc Coupé - FORD COUGAR (EC_) 2.5 ST 200 (01.00 A 12.01) 205cv 2495cc Coupé</p> <p>62x37mm 1f-d52x12mm</p>		<p><b>UTR0820</b> NO. 90352470 - 90409256 - 90409257 - 9041032690497472 - 90467473</p> <p><b>TAMPÃO RESERVATÓRIO LIQUIDO REFRIGERAÇÃO</b></p> <p>FORD COUGAR (EC_) 2.0 16V (08.98 A 12.01) 131cv 1988cc Coupé - FORD COUGAR (EC_) 2.5 V6 24V (06.00 A 12.01) 170cv 2495cc Coupé - FORD COUGAR (EC_) 2.5 V6 24V (08.98 A 12.01) 170cv 2544cc Coupé - FORD COUGAR (EC_) 2.5 ST 200 (01.00 A 12.01) 205cv 2495cc Coupé</p> <p>d62x23mm 1f-d53x12mm</p>
	<p><b>UTR0859</b> NO. 1650630 - 94539597 - 96293957 - 96312510 - 96351578 - 96420303 - 96536649</p> <p><b>TAMPÃO RESERVATÓRIO LIQUIDO REFRIGERAÇÃO</b></p> <p>FORD COUGAR (EC_) 2.0 16V (08.98 A 12.01) 131cv 1988cc Coupé - FORD COUGAR (EC_) 2.5 V6 24V (06.00 A 12.01) 170cv 2495cc Coupé - FORD COUGAR (EC_) 2.5 V6 24V (08.98 A 12.01) 170cv 2544cc Coupé - FORD COUGAR (EC_) 2.5 ST 200 (01.00 A 12.01) 205cv 2495cc Coupé</p> <p>d63x23mm 1f-d53x11mm</p>		<p><b>UTV83010</b> NO. 1013938 - 97JM6730BA</p> <p><b>TAMPÃO VEDAÇÃO BUJÃO</b></p> <p>FORD COUGAR (EC_) 2.0 16V (De 08-1998 Até 12-2001) 96kW 131CV 1988cc Coupé</p> <p>d28x35mm c19mm d13mm</p>
	<p><b>W5026</b> NO. 1038330 - 1135052 - 1250444 - 26105255 - 6599021 - 928M6B320DB - 928M6B320DD - 928M6B320DE - 928M6B320E...</p> <p><b>POLIE CAMBOTA ( 6 PISTAS )</b></p> <p>FORD COUGAR (EC_) : 2.0 16V 08.1998/12.2001 96KW 131CV 1988CC</p> <p>d131.3mm d28mm</p>		<p><b>W5035</b> NO. 1135052</p> <p><b>POLIE DA CAMBOTA ( 6 PISTAS )</b></p> <p>FORD COUGAR 2.0 16V</p> <p>d132mm d28mm</p>
	<p><b>Y3233</b> NO. 1473166 - 1481984 - 3395499 - 4432023 - 6586309 - 6789185</p> <p><b>PARAFUSO DA RODA CAVILHA M12X1,50X48MM</b></p> <p>FORD COUGAR (EC_) 2.0 16V (08.1998 - 12.2001) 96kw 131 cv 1988cm3 Coupé FORD COUGAR (EC_) 2.5 V6 24V (08.1998 - 12.2001) 125kw 170cv 2544cm3 Coupé</p> <p>c48mm M12x1,5mm</p>		<p><b>Z41158</b> NO. 1656747 - 1825595 - 1752024 - 6740771 - 4852244</p> <p><b>MOLA DE FIXAÇÃO TIPO PORCA</b></p> <p>FORD COUGAR (EC_) 2.0 16V (08.1998 -12.2001) 96kw 131cv 1988cm3 Coupé FORD COUGAR (EC_) 2.5 ST 200 (01.2000 -12.2001) 151kw 205cv 2495cm3 Coupé FORD COUGAR (EC_) 2.5 V6 24V (06.2000 -12.2001) 125kw 170cv 2495cm3 Coupé FORD COUGAR (EC_) 2.5 V6 24V (08.1998 -12.2001) 125kw 170cv 2544cm3 Coupé</p> <p>d12x 11mm f-d24mm</p>
	<p><b>Z80787</b> NO. 1039463 - 8E0825267</p> <p><b>Mola de fixação</b></p> <p>FORD COUGAR</p> <p>d20x34mm 1p-d8.5-21mm</p>		

FORD ECOSPORT



	<p><b>E0258</b> NO. 1513343 - 1745924 - 1790310 - 1905043 - 8V51.3B438.BA - 8V51.3B438.BB - 8V513B438AB - 8V5134170</p> <p><b>ESTICADOR BARRA ESTABILIZADORA FRENTE ( GASTA 2 UNIDADES )</b></p> <p>FORD ECOSPORT: 1.0 EcoBoost 10.2013/»»» 92KW 125CV 998CC - FORD ECOSPORT: 1.0 EcoBoost 04.2018/»»» 74KW 100CV 998CC - FORD ECOSPORT: 1.0 EcoBoost 03.2016/»»» 103KW 140CV 998CC - FORD ECOSPORT: 1.5 Ti 10.2013/»»» 82KW 112CV 1499CC - FORD ECOSPORT: 1.5 TDCi 10.2013/»»» 66KW 90CV 1499CC - FORD ECOSPORT: 1.5 TDCi 05.2015/»»» 70KW 95CV 1499CC - FORD ECOSPORT: 1.5 TDCi 05.2015/»»» 74KW 100CV 1499CC - FO...</p> <p>290x36x35mm 2p-d10x25mm</p>		<p><b>UAP83244</b> NO. 1230952 - 1432205 - 3M5QE568AA - M5Q9E568CA</p> <p><b>ANILHA PROTEÇÃO TÉRMICA INJECTORES</b></p> <p>FORD ECOSPORT 1.5 TDCi (De 10-2013 Até .1-20 -) 66kW 90CV 1499cc Veículo todo-terreno fechado FORD ECOSPORT 1.5 TDCi (De 05-2015 Até .1-20 -) 70kW 95CV 1499cc Veículo todo-terreno fechado</p> <p>d15x2mm 1f-d7mm</p>
	<p><b>UTR0847</b> NO. 1224233 - 1301104 - 3M5H8100AC</p> <p><b>TAMPÃO RESERVATÓRIO LIQUIDO REFRIGERAÇÃO</b></p> <p>FORD ECOSPORT 1.0 EcoBoost (A Partir de 10.13) 125cv 998cc Veículo todo-terreno fechado - FORD ECOSPORT 1.0 EcoBoost (A Partir de 03.16) 140cv 998cc Veículo todo-terreno fechado - FORD ECOSPORT 1.5 Ti (A Partir de 10.13) 112cv 1498cc Veículo todo-terreno fechado - FORD ECOSPORT 1.5 TDCi (A Partir de 10.13) 90cv 1499cc Veículo todo-terreno fechado</p> <p>d62x35mm 1f-d50x16mm</p>		<p><b>UTV83002</b> NO. 2S6Q6730AA</p> <p><b>TAMPÃO VEDAÇÃO BUJÃO</b></p> <p>FORD ECOSPORT 1.5 TDCi (De 10-2013 Até .1-20 -) 66kW 90CV 1499cc Veículo todo-terreno fechado</p> <p>20x18mm c13mm d10mm</p>

# FORD ECOSPORT

*Rafri, Lda.*

	<p><b>W5165</b> NO. 1539704 - 1752282 - 8A6G6B321AB - 8A6G6B321AC</p> <p>POLIE DA CAMBOTA (6 PISTAS)</p> <p>FORD ECOSPORT 1.5 Ti (De 10-2013 Até .1-20 -) 82kw 112CV 1498cc Veículo todo-terreno fechado</p>		<p><b>Z41158</b> NO. 1656747 - 1825595 - 1752024 - 6740771 - 4852244</p> <p>MOLA DE FIXAÇÃO TIPO PORCA</p> <p>FORD ECOSPORT 1.0 EcoBoost (10.2013 -) 92kw 125cv 998cm3 SUV          FORD ECOSPORT 1.0 EcoBoost (03.2016 -) 103kw 140cv 998cm3 SUV          FORD ECOSPORT 1.5 EcoBlue TDCi (05.2015 -) 70kw 95cv 1499cm3 SUV          FORD ECOSPORT 1.5 TDCi (10.2013 -) 66kw 90cv 1499cm3 SUV          FORD ECOSPORT 1.5 Ti (10.2013 -) 82kw 112cv 1499cm3 SUV          FORD ECOSPORT 1.5 Ti-VCT (10.2013 -06.2022) 81kw 110cv 1498cm3 SUV</p>
	<p><b>Z50130</b> NO. 11589289</p> <p>MOLA REBITE FIXAÇÃO</p> <p>FORD ECOSPORT 1.0 EcoBoost (10.2013 -) 92kw 125cv 998cm3 SUV          FORD ECOSPORT 1.0 EcoBoost (03.2016 -) 103kw 140cv 998cm3 SUV          FORD ECOSPORT 1.5 EcoBlue TDCi (05.2015 -) 70kw 95cv 1499cm3 SUV          FORD ECOSPORT 1.5 TDCi (10.2013 -) 66kw 90cv 1499cm3 SUV          FORD ECOSPORT 1.5 Ti (10.2013 -) 82kw 112cv 1499cm3 SUV          FORD ECOSPORT 1.5 Ti-VCT (10.2013 -06.2022) 81kw 110cv 1498cm3 SUV</p>		<p><b>Z57104</b> NO. 4831516</p> <p>MOLA DO PAINEL DA PORTA</p> <p>FORD C-MAX (A partir de 2013)</p>
	<p><b>Z71162</b> NO. 5270438</p> <p>MOLA DO PAINEL EXTERIOR MOLDURAS</p> <p>FORD ECOSPORT (A partir de 2017)</p>		
d138mm	d25mm	d12x 11mm	f-d24mm
d6x 18mm	f-d17mm	F12mm T21mm L18mm	H28mm S1-12mm
F13mm T20mm L15mm	H20mm S1-7mm		

# FORD ESCAPE





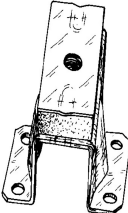









	<p><b>UTR0861</b> NO. YL8Z8100AA</p> <p>TAMPÃO RESERVATÓRIO LIQUIDO REFRIGERAÇÃO</p> <p>FORD ESCAPE 2.5L L4 ELECTRIC/GAS - 3.0L V6 FLEX (2001 A 2012)</p>		<p><b>UTR0861</b> NO. YL8Z-8100-AA</p> <p>TAMPÃO RESERVATÓRIO LIQUIDO REFRIGERAÇÃO</p> <p>FORD ESCAPE 2.5 L4 ELECTRIC/GAZ - 3.0L V6 FLEX (2001 A 2012)</p>
d56x37mm	d49x12mm 1p-d39x30mm	d56x37mm	d49x12mm 1p-d39x30mm













# FORD ESCORT-ORION

	<p><b>A0292</b> NO. 1619040 - 6140218 - 6140222 - 6140223 - 81AB6B032AK - 81AB6B049AK</p> <p>APOIO SUPORTE TRÁS E FRENTE DA CAIXA</p> <p>FORD ESCORT I (AFH, ATH) 1.6 08.1969/11.1974 62KW 84CV 1593CC          TL 16M - FORD ESCORT I (AFH, ATH) 1300 06.1968/06.1971 35KW 48CV 1298CC KL 13 L 1005238 - FORD ESCORT I (AFH, ATH) 1300 06.1968/06.1971 38KW 52CV 1298CC J2 1005239 1005505 - FORD ESCORT I (AFH, ATH) 1300 06.1970/02.1976 42KW 57CV 1298CC J2 1005522 1005526 - FORD ESCORT I (AFH, ATH) 1300 06.1970/02.1976 53KW 72CV 1298CC J3D 1005523 - FOR...</p>		<p><b>A0551</b> NO. 3f-d9mm (distância entre furos 83m</p> <p>APOIO DA CAIXA DE VELOCIDADES</p> <p>FORD ESCORT MK1</p>
	<p><b>A0551</b> NO. 3f-d9mm (distância entre furos 83m</p> <p>APOIO DA CAIXA DE VELOCIDADES</p> <p>FORD ESCORT MK2</p>		<p><b>A0644</b> NO. 3034E - 691F-6038B</p> <p>APOIO SUPORTE DO MOTOR S/ PERNO</p> <p>FORD ESCORT (1966 - 70)</p>
130x92x55mm	1f-d12mm	111x68x40mm	3f-d9mm (distância entre furos 83mm)...
111x68x40mm	3f-d9mm (distância entre furos 83mm)...	128x91x86mm	1r-d8mm

	<p><b>A0644P</b> NO. 1463559 - 1477079 - 3034E - 691F-6038AB - 701F 6038 AB</p> <p>APOIO SUPORTE DO MOTOR C/ PERNO</p> <p>FORD ESCORT MK I, II 1100, 1300CC 10.1967/1974 - FORD ESCORT MK I AUTOMATIC 08.1969/1974 - FORD ESCORT MK I VAN 04.1968/11.1973 - FORD ESCORT MK I VAN 04.1968/1975</p> <p>135x92x90mm 1p-d10-22mm</p>		<p><b>A0831</b> NO. 1564470</p> <p>APOIO ANTI-VIBRATÓRIO</p> <p>FORD ESCORT I (AFH, ATH) 1.6 08.1969/11.1974 62KW 84CV 1593CC TL 16M - FORD ESCORT I (AFH, ATH) 1100 01.1968/12.1974 32KW 45CV 1098CC G1 1005520 1005524 - FORD ESCORT I (AFH, ATH) 1100 06.1968/06.1971 29KW 40CV 1098CC KL11 1005236 1005502 - FORD ESCORT I (AFH, ATH) 1100 06.1968/06.1971 33KW 45CV 1098CC G1 1005237 1005503 - FORD ESCORT I (AFH, ATH) 1100 06.1970/02.1976 35KW 48CV 1098CC G2 1005521 1...</p> <p>d70x51mm 1p-d10-27mm 1p-d10-27mm</p>
	<p><b>A0960</b> NO. 1454275 - 1515124 - 711F6068AB - 72HF.6068.AB - 72HF6068AA</p> <p>APOIO SUPORTE TRÁS DO MOTOR</p> <p>FORD ESCORT I (AFH, ATH): 950 08.1968/08.1974 25KW 34CV 940CC - FORD ESCORT I (AFH, ATH): 1100 06.1968/06.1971 29KW 40CV 1098CC</p> <p>166x97x55mm 1f-d13mm</p>		<p><b>A0960</b> NO. 1454275 - 1515124 - 711F6068AB - 72HF.6068.AB - 72HF6068AA</p> <p>APOIO SUPORTE TRÁS DO MOTOR</p> <p>FORD ORION I (AFD): 1.3 07.1983/03.1986 51KW 69CV 1296CC - FORD ORION I (AFD): 1.6 07.1983/03.1986 58KW 79CV 1597CC - FORD ORION I (AFD): 1.6 D 02.1984/03.1986 40KW 54CV 1608CC - FORD ORION II (AFF): 1.3 12.1985/07.1990 44KW 60CV 1297CC - FORD ORION II (AFF): 1.4 03.1986/07.1990 52KW 72CV 1392CC - FORD ORION II (AFF): 1.4 01.1986/07.1990 54KW 73CV 1392CC - FORD ORION II (AFF): 1.4 12.1985/07.1990 ...</p> <p>166x97x55mm 1f-d13mm</p>
	<p><b>A1036</b> NO. 6845223 - 6845225 - 91AB.6L028.CB</p> <p>APOIO INFERIOR DA FRENTE DO MOTOR LADO CAIXA</p> <p>FORD ESCORT V (AAL, ABL) 1.3 07.1990/01.1995 44KW 60CV 1299CC J4B J6A 0928768 7528355 - FORD ESCORT V (AAL, ABL) 1.4 07.1990/01.1995 52KW 71CV 1392CC F6G F6F 0928770 7528357 - FORD ESCORT V (AAL, ABL) 1.6 07.1990/08.1992 66KW 90CV 1598CC LUJ LUK - FORD ESCORT V (AAL, ABL) 1.6 07.1990/08.1993 77KW 105CV 1598CC LJF 0928772 7528359 - FORD ESCORT V (AAL, ABL) 1.8 D 07.1990/01.1995 44KW 60CV 1753CC RTH...</p>		<p><b>A1036</b> NO. 6845223 - 6845225 - 91AB.6L028.CB</p> <p>APOIO INFERIOR DA FRENTE DO MOTOR LADO CAIXA</p> <p>FORD ORION II (AFF) 1.3 12.1985/07.1990 44KW 60CV 1297CC JBB JLA JLB 0928625 7528328 - FORD ORION II (AFF) 1.4 12.1985/07.1990 55KW 75CV 1392CC FUA 0928626 7528329 - FORD ORION II (AFF) 1.4 01.1986/07.1990 54KW 73CV 1392CC FUC 0928647 7528336 - FORD ORION II (AFF) 1.4 03.1986/07.1990 52KW 72CV 1392CC FUA 0928779 - FORD ORION II (AFF) 1.4 Cat 02.1987/07.1990 54KW 73CV 1392CC F6D F6B 0928647 - FO...</p>
	<p><b>A1037</b> NO. 6157620 - 6160229 - 6185027 - 86AB6038DB</p> <p>APOIO DIREITO DO MOTOR</p> <p>FORD ESCORT III (GAA) 1.6 D 02.1984/12.1985 40KW 54CV 1608CC LTA 0928587 7528316 - FORD ESCORT III Turnier (AWA) 1.6 D 02.1984/12.1985 40KW 54CV 1608CC LTA 0928588 - FORD ESCORT IV (GAF, AWF, ABFT) 1.6 D 01.1986/01.1989 40KW 54CV 1608CC LTC 0928622 7528325 - FORD ESCORT IV Turnier (AWF, AVF) 1.6 D 01.1986/01.1989 40KW 54CV 1608CC LTC 0928632</p> <p>152x85x60mm 1f-d12mm</p>		<p><b>A1037</b> NO. 6157620 - 6160229 - 6185027 - 86AB6038DB</p> <p>APOIO DIREITO DO MOTOR</p> <p>FORD ORION I (AFD) 1.6 D 02.1984/03.1986 40KW 54CV 1608CC LTA 0928586 7528320 - FORD ORION II (AFF) 1.6 D 12.1985/01.1989 40KW 54CV 1608CC LTC 0928627 7528330</p> <p>152x85x60mm 1f-d12mm</p>
	<p><b>A1057</b> NO. 1640021 - 6133904 - 6161628 - 84FB6038CD</p> <p>APOIO SUPORTE DIREITO FRENTE DO MOTOR</p> <p>FORD ESCORT IV (GAF, AWF, ABFT) 1.4 01.1986/07.1990 54KW 73CV 1392CC FUC F6D F6B 0928645 7528335 - FORD ESCORT IV (GAF, AWF, ABFT) 1.4 01.1986/07.1990 55KW 75CV 1392CC FUA 0928621 7528324 - FORD ESCORT IV (GAF, AWF, ABFT) 1.6 01.1986/05.1990 66KW 90CV 1598CC L4B LUC 0928623 7528326 - FORD ESCORT IV (GAF, AWF, ABFT) 1.6 Turbo RS 01.1986/07.1990 97KW 132CV 1597CC LNB 0928638 - FORD ESCORT IV (GAF,...</p> <p>130x110x50mm 3p-d10-27mm 1r-d6mm</p>		<p><b>A1057</b> NO. 1640021 - 6133904 - 6161628 - 84FB6038CD</p> <p>APOIO SUPORTE DIREITO FRENTE DO MOTOR</p> <p>FORD ORION I (AFD) 1.6 07.1983/03.1986 58KW 79CV 1597CC LP1 LPA 0928577 - FORD ORION I (AFD) 1.6 D 02.1984/03.1986 40KW 54CV 1608CC LTA 0928586 7528320 - FORD ORION II (AFF) 1.4 12.1985/07.1990 55KW 75CV 1392CC FUA 0928626 7528329 - FORD ORION II (AFF) 1.4 01.1986/07.1990 54KW 73CV 1392CC FUC 0928647 7528336 - FORD ORION II (AFF) 1.4 Cat 02.1987/07.1990 54KW 73CV 1392CC F6D F6B 0928647 - FORD ORIO...</p> <p>130x110x50mm 3p-d10-27mm 1r-d6mm</p>
	<p><b>A1058</b> NO. 6155714 - 6170427 - 86AB6038BB</p> <p>APOIO DA CAIXA DE VELOCIDADES FRENTE E TRÁS</p> <p>FORD ESCORT III (GAA) 1.6 09.1980/12.1985 58KW 79CV 1597CC LPA LP1 0928539 7528309 - FORD ESCORT III (GAA) 1.6 09.1980/10.1982 71KW 97CV 1597CC LUA 0928540 - FORD ESCORT III Cabriolet (ALD) 1.6 09.1983/12.1985 58KW 79CV 1597CC LPA LP1 0928584 - FORD ESCORT III Turnier (AWA) 1.6 09.1980/12.1985 58KW 79CV 1597CC LPA LP1 0928544 - FORD ESCORT IV (GAF, AWF, ABFT) 1.4 01.1986/07.1990 54KW 73CV 1392CC F...</p> <p>97x75x40mm 2p-d10-22mm</p>		<p><b>A1058</b> NO. 6155714 - 6170427 - 86AB6038BB</p> <p>APOIO DA CAIXA DE VELOCIDADES FRENTE E TRÁS</p> <p>FORD ORION II (AFF) 1.8 D 01.1989/07.1990 44KW 60CV 1753CC RTB RTA 0928700 - FORD ORION III (GAL) 1.8 D 11.1990/12.1993 44KW 60CV 1753CC RTH RTF RTE 2028332 0928775 7528362</p> <p>97x75x40mm 2p-d10-22mm</p>
	<p><b>A1068</b> NO. 1638511 - 6131375 - 6160228 - 84FB6038AF</p> <p>APOIO SUPORTE DIREITO FRENTE DO MOTOR</p> <p>FORD ESCORT III (GAA) 1.1 09.1980/08.1983 40KW 55CV 1117CC GMA GLB 0928536 7528307 - FORD ESCORT III (GAA) 1.1 09.1980/08.1983 43KW 59CV 1117CC GPA 0928537 0928542 - FORD ESCORT III (GAA) 1.1 08.1983/12.1985 37KW 50CV 1117CC GSE 0928580 7528310 - FORD ESCORT III (GAA) 1.3 09.1980/12.1985 51KW 69CV 1296CC JPA 0928538 7528308 - FORD ESCORT III Cabriolet (ALD) 1.3 09.1983/12.1985 51KW 69CV 1296CC JPA...</p> <p>160x100x65mm 1f-d12mm 1r-d10mm 1p-d10-20mm</p>		<p><b>A1188</b> NO. 6203710 - 89AB6B049AD</p> <p>APOIO TRASEIRO SUPERIOR ESQUERDO DO MOTOR</p> <p>FORD ESCORT III (GAA) 1.6 D 02.1984/12.1985 40KW 54CV 1608CC LTA 0928587 7528316 - FORD ESCORT III Turnier (AWA) 1.6 D 02.1984/12.1985 40KW 54CV 1608CC LTA 0928588 - FORD ESCORT IV (GAF, AWF, ABFT) 1.6 D 01.1986/01.1989 40KW 54CV 1608CC LTC 0928622 7528325 - FORD ESCORT IV (GAF, AWF, ABFT) 1.8 D 01.1989/07.1990 44KW 60CV 1753CC RTB RTA 0928698 - FORD ESCORT IV Express (AVF) 1.8 D 07.1988/07.1990 4...</p> <p>97x75x40mm 2p-d10-22mm</p>
	<p><b>A1188</b> NO. 6203710 - 89AB6B049AD</p> <p>APOIO TRASEIRO SUPERIOR ESQUERDO DO MOTOR</p> <p>FORD ORION I (AFD) 1.6 D 02.1984/03.1986 40KW 54CV 1608CC LTA 0928586 7528320 - FORD ORION II (AFF) 1.6 D 12.1985/01.1989 40KW 54CV 1608CC LTC 0928627 7528330 - FORD ORION II (AFF) 1.8 D 01.1989/07.1990 44KW 60CV 1753CC RTB RTA 0928700 - FORD ORION III (GAL) 1.8 D 11.1990/12.1993 44KW 60CV 1753CC RTH RTF RTE 2028332 0928775 7528362</p> <p>97x75x40mm 2p-d10-22mm</p>		<p><b>A1318</b> NO. 6138727 - 6172938 - 82AB6049CA - 82AB6B049CA</p> <p>APOIO SUPORTE DE TRÁS DO MOTOR</p> <p>FORD ESCORT III (GAA) 1.1 09.1980/08.1983 40KW 55CV 1117CC GMA GLB 0928536 7528307 - FORD ESCORT III (GAA) 1.1 09.1980/08.1983 43KW 59CV 1117CC GPA 0928537 0928542 - FORD ESCORT III (GAA) 1.1 08.1983/12.1985 37KW 50CV 1117CC GSE 0928580 7528310 - FORD ESCORT III (GAA) 1.3 09.1980/12.1985 51KW 69CV 1296CC JPA 0928538 7528308 - FORD ESCORT III (GAA) 1.6 09.1980/12.1985 58KW 79CV 1597CC LPA LP1 09285...</p> <p>140x109x105mm 1p-d10-35mm</p>

	<p><b>A1318</b> NO. 6138727 - 6172938 - 82AB6049CA - 82AB6B049CA</p> <p>APOIO SUPORTE DE TRÁS DO MOTOR</p> <p>FORD ORION I (AFD) 1.3 07.1983/03.1986 51KW 69CV 1296CC JPA 0928576 - FORD ORION I (AFD) 1.6 07.1983/03.1986 58KW 79CV 1597CC LP1 LPA 0928577 - FORD ORION I (AFD) 1.6 D 02.1984/03.1986 40KW 54CV 1608CC LTA 0928586 7528320 - FORD ORION I (AFD) 1.6 i 07.1983/03.1986 77KW 105CV 1597CC LRA LR1 0928578 7528315</p> <p>140x109x105mm 1p-d10-35mm</p>		<p><b>A1380</b> NO. 7350847 - 95AB3K155AD</p> <p>APOIO DA SUSPENSÃO DA FRENTE</p> <p>FORD ESCORT CLASSIC (AAL, ABL) 1.6 16V 10.1998/07.2000 66KW 90CV 1597CC L1E L1K 8566325 8566313 - FORD ESCORT CLASSIC (AAL, ABL) 1.8 TD 10.1998/07.2000 66KW 90CV 1753CC RFD RFK RFS 8566328 8566316 - FORD ESCORT CLASSIC Turnier (ANL) 1.6 16V 02.1999/07.2000 66KW 90CV 1597CC L1E L1K 8566331 - FORD ESCORT CLASSIC Turnier (ANL) 1.8 TD 02.1999/07.2000 66KW 90CV 1753CC RFK RFD RFS 8566334 - FORD ESCORT ...</p> <p>145x145x40mm 3p-d8-17mm</p>
	<p><b>A1382</b> NO. 6548783 - 6548783 - 91AB8125AC</p> <p>APOIO SUPORTE RADIADOR</p> <p>FORD ESCORT V (AAL, ABL) 1.3 07.1990/01.1995 44KW 60CV 1299CC J4B J6A 0928768 7528355 - FORD ESCORT V (AAL, ABL) 1.4 07.1990/01.1995 52KW 71CV 1392CC F6G F6F 0928770 7528357 - FORD ESCORT V (AAL, ABL) 1.4 09.1990/12.1994 55KW 75CV 1392CC FAB FUH 2028355 7528385 0928852 - FORD ESCORT V (AAL, ABL) 1.6 07.1990/08.1992 66KW 90CV 1598CC LUJ LUK - FORD ESCORT V (AAL, ABL) 1.6 07.1990/08.1993 77KW 105CV ...</p> <p>d32x33mm 1f-d13mm</p>		<p><b>A1384</b> NO. 1012893 - 1012895 - 1040403 - 1040404 - 7057298 - 7057299 - 7145504 - 7145505 - 94AB-6B049-CE - 94AB...</p> <p>APOIO DO MOTOR FRENTE LADO ESQUERDO</p> <p>FORD ESCORT V (AAL, ABL): 1.6 i 16V 01.1994/01.1995 65KW 88CV 1597CC - FORD ESCORT V (AAL, ABL): 1.6 i 16V 09.1992/01.1995 66KW 90CV 1597CC - FORD ESCORT V (AAL, ABL): 1.8 16V XR3i 02.1992/01.1995 77KW 105CV 1796CC - FORD ESCORT V (AAL, ABL): 1.8 16V XR3i 02.1992/01.1995 77KW 105CV 1796CC - FORD ESCORT V (AAL, ABL): 1.8 16V XR3i 02.1992/01.1995 77KW 105CV 1796CC - FORD ESCORT V (AAL, ABL): 1.8 16V XR3i 02.1992/01.1995 77KW 105CV 1796CC - FORD ESCORT V (AAL, ABL): RS 2000 05.1991/01.1995 110KW 150CV 1998CC - FORD ESCORT V (AAL, ABL): RS Cosworth...</p> <p>160x100x70mm 1p-d12-30mm</p>
	<p><b>A1384</b> NO. 1012893 - 1012895 - 1040403 - 1040404 - 7057298 - 7057299 - 7145504 - 7145505 - 94AB-6B049-CE - 94AB...</p> <p>APOIO DO MOTOR FRENTE LADO ESQUERDO</p> <p>FORD ORION III (GAL): 1.6 i 16V 07.1992/12.1993 66KW 90CV 1597CC - FORD ORION III (GAL): 1.8 i 16V 02.1992/12.1993 77KW 105CV 1796CC - FORD ORION III (GAL): 1.8 i 16V 01.1992/12.1993 96KW 130CV 1796CC - FORD ORION III (GAL): 1.8 D 11.1990/12.1993 44KW 60CV 1753CC - FORD ORION III (GAL): 1.8 TD 03.1992/12.1993 66KW 90CV 1753CC</p> <p>160x100x70mm 1p-d12-30mm</p>		<p><b>A1385</b> NO. 1113176 - 1561781 - 6179974 - 77BM.6K255.AF - 77BM6K255AC</p> <p>APOIO DO TENSOR DE EMBRAIAGEM</p> <p>FORD ESCORT III (GAA) 1.1 09.1980/08.1983 40KW 55CV 1117CC GMA GLB 0928536 7528307 - FORD ESCORT III (GAA) 1.1 08.1983/12.1985 37KW 50CV 1117CC GSE 0928580 7528310 - FORD ESCORT III Express (AVA) 1.1 03.1981/02.1986 37KW 50CV 1117CC GLB GMA 2028172 2028183 - FORD ESCORT III Turnier (AWA) 1.1 09.1980/08.1983 40KW 54CV 1117CC GMA GLB 0928541 - FORD ESCORT III Turnier (AWA) 1.1 08.1983/12.1985 37KW 50...</p> <p>63x16x13mm</p>
	<p><b>A1385</b> NO. 1113176 - 1561781 - 6179974 - 77BM.6K255.AF - 77BM6K255AC</p> <p>APOIO DO TENSOR DE EMBRAIAGEM</p> <p>FORD ORION II (AFF) 1.3 12.1985/07.1990 44KW 60CV 1297CC JBB JLA JLB 0928625 7528328 - FORD ORION III (GAL) 1.3 07.1990/12.1993 44KW 60CV 1299CC J4B J6A 0928769 7528356</p> <p>63x16x13mm</p>		<p><b>A1390</b> NO. 6610305 - 6766044 - 91AB6P071EA - 92AB6B049BA - 92AB6P071BA - T057300 - T102901</p> <p>APOIO DO MOTOR DE TRÁS</p> <p>FORD ESCORT V (AAL, ABL) 1.4 09.1990/12.1994 55KW 75CV 1392CC F4B FUH 2028355 7528385 0928852 - FORD ESCORT V (AAL, ABL) 1.6 i 16V 09.1992/01.1995 66KW 90CV 1597CC L1E 2028343 7528378 0928824 - FORD ESCORT V (AAL, ABL) 1.6 i 16V 01.1994/01.1995 65KW 88CV 1597CC L1H 2028363 7528392 0928865 - FORD ESCORT V (AAL, ABL) 1.8 TD 02.1993/01.1995 66KW 90CV 1753CC RFS RFK RFD 2028351 7528381 0928837 - FORD ...</p> <p>d87x90mm c56 2f-d13mm 1f-d18mm</p>
	<p><b>A1396</b> NO. 6137369 - 6185650 - 6532935 - 6532939 - 82AB6B032BC - 85HF6038EB - 88TF6038AB</p> <p>APOIO SUPORTE DO MOTOR DIREITO E ESQUERDO</p> <p>FORD ESCORT VI (GAL, AAL, ABL): 1.3 01.1995/10.1998 44KW 60CV 1299CC - FORD ESCORT VI (GAL, AAL, ABL): 1.4 01.1995/10.1998 55KW 75CV 1392CC - FORD ESCORT VI (GAL, AAL, ABL): 1.6 i 16V 01.1995/08.1995 65KW 88CV 1597CC - FORD ESCORT VI (GAL, AAL, ABL): 1.6 16V 01.1995/10.1998 66KW 90CV 1597CC - FORD ESCORT VI (GAL, AAL, ABL): 1.8 Turbo D 12.1995/10.1998 51KW 70CV 1753CC - FORD ESCORT VI (GAL, AAL, A...)</p> <p>d108x89mm 1p-d10-27mm 1p-d10-57mm</p>		<p><b>A1399</b> NO. 6494722 - 6552202 - 6575554 - 6610300 - 6793344 - 91AB6038AG - 92AB6038DA</p> <p>APOIO SUPORTE DE MOTOR DIREITO</p> <p>FORD ESCORT V (AAL, ABL) 1.3 07.1990/01.1995 44KW 60CV 1299CC J4B J6A 0928768 7528355 - FORD ESCORT V três volumes (AFL) 1.3 08.1993/01.1995 44KW 60CV 1299CC J4B J6A 0928769 2028335 7528356 - FORD ESCORT V Turnier (ANL) 1.6 07.1990/08.1992 66KW 90CV 1598CC LUK LUJ - FORD ESCORT V Turnier (ANL) 1.6 07.1990/09.1992 77KW 105CV 1598CC LUF 0928782 7528365 - FORD ESCORT VI (GAL, AAL, ABL) 1.3 01.1995/10...</p> <p>142x120x68mm 1f-d12mm 2p-d10-26mm 2p-d12-37mm</p>
	<p><b>A1399</b> NO. 6494722 - 6552202 - 6575554 - 6610300 - 6793344 - 91AB6038AG - 92AB6038DA</p> <p>APOIO SUPORTE DE MOTOR DIREITO</p> <p>FORD ORION III (GAL) 1.3 07.1990/12.1993 44KW 60CV 1299CC J4B J6A 0928769 7528356 - FORD ORION III (GAL) 1.4 07.1990/12.1993 52KW 71CV 1391CC F6F F6G 0928771 7528358 - FORD ORION III (GAL) 1.4 07.1990/12.1993 54KW 73CV 1392CC FUH - FORD ORION III (GAL) 1.6 07.1990/12.1992 66KW 90CV 1598CC LUK LUJ</p> <p>142x120x68mm 1f-d12mm 2p-d10-26mm 2p-d12-37mm</p>		<p><b>A1498</b> NO. 6178901 - 6186726 - 89AB6038BA - 89AB6038BB</p> <p>APOIO MOTOR LADO DIREITO</p> <p>FORD ESCORT IV (GAF, AWF, ABFT) 1.6 D 01.1986/01.1989 40KW 54CV 1608CC LTC 0928622 7528325 - FORD ESCORT IV (GAF, AWF, ABFT) 1.8 D 01.1989/07.1990 44KW 60CV 1753CC RTB RTA 0928698 - FORD ESCORT IV Express (AVF) 1.8 D 07.1988/07.1990 44KW 60CV 1753CC RTB RTA 2028190 - FORD ESCORT IV Turnier (AWF, AVF) 1.6 D 01.1986/01.1989 40KW 54CV 1608CC LTC 0928632 - FORD ESCORT IV Turnier (AWF, AVF) 1.8 D 01.19...</p> <p>155x95x61mm 1f-d12mm 1p-d10-26mm</p>
	<p><b>A2304</b> NO. 7204687 - 95AB6038CA</p> <p>APOIO DO MOTOR FRENTE LADO DIREITO</p> <p>FORD ESCORT V Turnier (ANL) 1.8 D (De 1990.07 Até 1995.01) 44KW 60cv 1753cm3 Combi - FORD ESCORT V Turnier (ANL) 1.8 TD (De 1993.02 Até 1995.01) 66KW 90cv 1753cm3 Combi - FORD ESCORT V três volumes (AFL) 1.8 D (De 1993.08 Até 1995.01) 44KW 60cv 1753cm3 três volumes - FORD ESCORT V três volumes (AFL) 1.8 TD (De 1993.08 Até 1995.01) 66KW 90cv 1753cm3 três volumes - FORD ESCORT V (GAL, AAL, ABL) 1.3 07.1990/12.1993 44KW 60CV 1299CC J4B J6A 0928769 7528356</p> <p>142x120x68mm 1f-d12mm 2p-d10-26mm 2p-d12x37mm</p>		<p><b>BB22</b> NO. 1003610</p> <p>ABRAÇADEIRA BARRA ESTABILIZADORA (GASTA 2 UNIDADES)</p> <p>FORD ESCORT V (AAL, ABL): 1.3 07.1990/01.1995 44KW 60CV 1299CC - FORD ESCORT V (AAL, ABL): 1.4 07.1990/01.1995 52KW 71CV 1392CC - FORD ESCORT V (AAL, ABL): 1.4 09.1990/12.1994 55KW 75CV 1392CC - FORD ESCORT V (AAL, ABL): 1.6 i 16V 01.1994/01.1995 65KW 88CV 1597CC - FORD ESCORT V (AAL, ABL): 1.6 i 16V 09.1992/01.1995 66KW 90CV 1597CC - FORD ESCORT V (AAL, ABL): 1.6 07.1990/08.1993 77KW 105KW 1598CC...</p>
	<p><b>BB23</b> NO. 6788739</p> <p>ABRAÇADEIRA BARRA ESTABILIZADORA (GASTA 2 UNIDADES)</p> <p>FORD ORION III (GAL): 1.3 07.1990/12.1993 44KW 60CV 1299CC - FORD ORION III (GAL): 1.4 07.1990/12.1993 52KW 71CV 1391CC - FORD ORION III (GAL): 1.6 i 16V 07.1992/12.1993 66KW 90CV 1597CC - FORD ORION III (GAL): 1.6 i 07.1990/09.1992 77KW 105CV 1598CC - FORD ORION III (GAL): 1.8 i 16V 02.1992/12.1993 77KW 105CV 1796CC - FORD ORION III (GAL): 1.8 i 16V 01.1992/12.1993 96KW 130CV 1796CC - FORD ORION ...</p>		<p><b>BB23</b> NO. 6788739</p> <p>ABRAÇADEIRA BARRA ESTABILIZADORA (GASTA 2 UNIDADES)</p> <p>FORD ESCORT V Turnier (ANL): 1.3 09.1991/01.1995 44KW 60CV 1299CC - FORD ESCORT V Turnier (ANL): 1.4 07.1990/01.1995 52KW 71CV 1392CC - FORD ESCORT V Turnier (ANL): 1.6 07.1990/08.1992 66KW 90CV 1598CC - FORD ESCORT V Turnier (ANL): 1.6 07.1990/09.1992 77KW 105CV 1598CC - FORD ESCORT V Turnier (ANL): 1.8 16V 02.1992/01.1995 77KW 105CV 1796CC - FORD ESCORT V Turnier (ANL): 1.8 D 07.1990/01.1995 44K...</p>

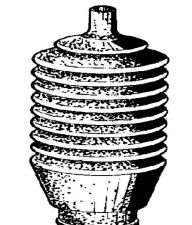
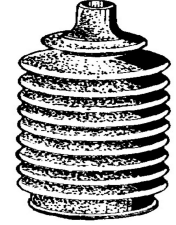
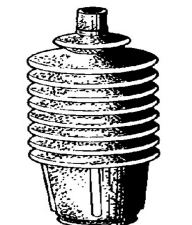
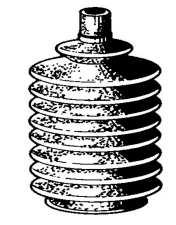
	<p><b>BB23</b> NO. 6788739</p> <p>ABRÇAQUEIRA BARRA ESTABILIZADORA ( GASTA 2 UNIDADES )</p> <p>FORD ORION III (GAL): 1.3 07.1990/12.1993 44KW 60CV 1299CC - FORD ORION III (GAL): 1.4 07.1990/12.1993 52KW 71CV 1391CC - FORD ORION III (GAL): 1.4 07.1990/12.1993 54KW 73CV 1392CC - FORD ORION III (GAL): 1.6 i 16V 07.1992/12.1993 66KW 90CV 1597CC - FORD ORION III (GAL): 1.6 07.1990/12.1992 66KW 90CV 1598CC - FORD ORION III (GAL): 1.6 i 07.1990/09.1992 77KW 105CV 1598CC - FORD ORION III (GAL): 1.8...</p>		<p><b>C0231</b> NO. 6483712 - 91AB.16C618.AA</p> <p>BOTÃO DE AFINAÇÃO DE CAPOT</p> <p>FORD ESCORT (APÓS 1995) - FORD ORION (07-1990 A 12-1993)</p>
	<p><b>D0012</b> NO. 72GG4684BA</p> <p>CARDAN TRANSMISSÃO D146X46MM 6 FUROS 12MM</p> <p>FORD ESCORT</p>		<p><b>D0037</b> NO. 1515117 - 1638947 - 6518778 - 83BG4684BA - 83GB4684BA - 88GG4684BA - GAF41</p> <p>CARDAN TRANSMISSÃO</p> <p>FORD ESCORT I (AFH, ATH) 950 (08.68 A 08.74) 34cv 940cc três volumes - FORD ESCORT I (AFH, ATH) 1100 (06.68 A 06.71) 40cv 1098cc três volumes</p>
	<p><b>D0037</b> NO. 1515117 - 1638947 - 6518778 - 83BG4684BA - 83GB4684BA - 88GG4684BA - GAF41</p> <p>CARDAN TRANSMISSÃO</p> <p>FORD ESCORT V (GAL) 1.3 Ano fabric. a partir de: 04.92, (07.90 A 09.92) 60cv 1299cc Hatchback - FORD ESCORT V (GAL) 1.4 Ano fabric. a part ir de: 04.92, (07.90 A 09.92) 71cv 1392cc Hatchback - FORD ESCORT V (GAL) 1.6 Ano fabric. a part ir de: 04.92, (07.90 A 08.92) 90cv 1598cc Hatchback - FORD ESCORT V (GAL) 1.6 Ano fabric. a part ir de: 04.92, (07.90 A 12.92) 105cv 1598cc Hatchback - FORD ...</p>		<p><b>D0037</b> NO. 1515117 - 1638947 - 6518778 - 83BG4684BA - 83GB4684BA - 88GG4684BA - GAF41</p> <p>CARDAN TRANSMISSÃO</p> <p>FORD ESCORT VI (GAL) 1.3 (09.92 A 01.95) 60cv 1299cc Hatchback - FORD ESCORT VI (GAL) 1.4 (01.94 A 01.95) 75cv 1392cc Hatchback - FORD ESCORT VI (GAL) 1.6 i 16V (01.94 A 01.95) 88cv 1597cc Hatchback - FORD ESCORT VI (GAL) 1.6 i 16V (09.92 A 01.95) 90cv 1597cc Hatchback - FORD ESCORT VI (GAL) 1.8 i 16V (09.92 A 01.95) 105cv 1796cc Hatchback - FORD ESCORT VI (GAL) 1.8 XR3i 16V 4x4 (08.93 A...</p>
	<p><b>D0037</b> NO. 1515117 - 1638947 - 6518778 - 83BG4684BA - 83GB4684BA - 88GG4684BA - GAF41</p> <p>CARDAN TRANSMISSÃO</p> <p>FORD ESCORT VII (GAL, AAL, ABL) 1.3 Ano fabric. até: 08.96, (01.95 A 10.98) 60cv 1299cc Hatchback - FORD ESCORT VII (GAL, AAL, ABL) 1.4 Ano fabric. até: 08.96, (01.95 A 10.98) 75cv 1392cc Hatchback - FORD ESCORT VII (GAL, AAL, ABL) 1.6 16V 4x4 (01.95 A 10.98) 90cv 1597cc Hatchback - FORD ESCORT VII (GAL, AAL, ABL) 1.8 16V (01.95 A 08.95) 105cv 1796cc Hatchback - FORD ESCORT VII (GAL, AAL, ...</p>		<p><b>E0008</b> NO. 0801909 - 1591419 - 6030483 - 70GB5281AA - 801909</p> <p>ESTICADOR DE ESCAPE</p> <p>FORD ESCORT I (AFH, ATH): 950 08.1968/08.1974 25KW 34CV 940CC - FORD ESCORT I (AFH, ATH): 950 08.1968/08.1974 26KW 36CV 940CC - FORD ESCORT I (AFH, ATH): 1100 06.1968/06.1971 29KW 40CV 1098CC - FORD ESCORT I (AFH, ATH): 1100 01.1968/12.1974 32KW 45CV 1098CC - FORD ESCORT I (AFH, ATH): 1100 06.1968/06.1971 33KW 45CV 1098CC - FORD ESCORT I (AFH, ATH): 1100 06.1970/02.1976 35KW 48CV 1098CC - FORD ESC...</p>
	<p><b>E0010</b> NO. 6048886 - 6053849 - 6111692 - 77FB5A262BD - 77FB5A262CA</p> <p>ESTICADOR DE ESCAPE</p> <p>FORD ESCORT (0.9-1.1-1.3-1.6 - DIESEL 1.6 - 1.8 (80 A 8-83) - ORION (APÓS 83)</p>		<p><b>E0012</b> NO. 553769 - 6030483 - 69AB5281BA</p> <p>ESTICADOR DE ESCAPE</p> <p>FORD ESCORT CATAL. (02-1975 A 08 1980)</p>
	<p><b>E0023</b> NO. 6111691 - 6120254 - 6122002 - 6136012 - 6162002 - 81AB5A262AC - 87BB3K661AA - 93BB5A262HA</p> <p>ESTICADOR DE ESCAPE</p> <p>FORD ORION 1.3 - 1.4 - 1.6 (9-1983 A 8-1991) - ESCORT 0.9 - 1.1 - 1.3 - 1.6 (9-83 A 8-91)</p>		<p><b>E0100</b> NO. 1061631 - 1067818 - 1071336 - 1130273 - 1661237 - 1E01-34-170A - 1561.38438.AA - 89FB38438A1E ...</p> <p>ESTICADOR BARRA ESTABILIZADORA FRENTE ( GASTA 2 UNIDADES )</p> <p>FORD ESCORT CLASSIC Turnier (ANL) 1.8 TD 02.1999/07.2000 66KW 90CC 1753CC RFK RFD RFS 8566334 - FORD ESCORT I (AFH, ATH) 1300 06.1968/06.1971 35KW 48CV 1298CC KL 13 L 1005238 - FORD ESCORT I (AFH, ATH) 1300 06.1968/06.1971 38KW 52CV 1298CC J2 1005239 1005505 - FORD ESCORT I (AFH, ATH) 1300 06.1970/02.1976 42KW 57CV 1298CC J2 1005522 1005526 - FORD ESCORT I (AFH, ATH) 1300 06.1970/02.1976 53KW 72CV...</p>
	<p><b>E0262</b> NO. 1061631 - 1107068 - 1111769 - 1135077 - 1209035 - 1471446 - 5090811 - 5S433B438AA - 98AG.3B4...</p> <p>ESTICADOR BARRA ESTABILIZADORA FRENTE ( GASTA 2 UNIDADES )</p> <p>FORD ESCORT V (AAL, ABL) 1.3 07.1990/01.1995 44KW 60CV 1299CC J4B J6A 0928768 7528355 - FORD ESCORT V (AAL, ABL) 1.4 07.1990/01.1995 52KW 71CV 1392CC F6G F6F 0928770 7528357 - FORD ESCORT V (AAL, ABL) 1.4 09.1990/12.1994 55KW 75CV 1392CC F4B FUH 2028355 7528385 0928852 - FORD ESCORT V (AAL, ABL) 1.6 07.1990/08.1992 66KW 90CV 1598CC LUJ LUK - FORD ESCORT V (AAL, ABL) 1.6 07.1990/08.1993 77KW 105CV ...</p>		<p><b>E1012</b> NO.</p> <p>ESTICADOR DE ESCAPE</p> <p>FORD ESCORT</p>
	<p><b>E1016</b> NO. 6788494 - 92AB5A262DC</p> <p>ESTICADOR DE ESCAPE</p> <p>FORD ESCORT CLASSIC (AAL, ABL) 1.6 16V 10.1998/07.2000 66KW 90CV 1597CC L1E L1K 8566325 8566313 - FORD ESCORT CLASSIC Turnier (ANL) 1.6 16V 02.1999/07.2000 66KW 90CV 1597CC L1E L1K 8566331 - FORD ESCORT VI (GAL, AAL, ABL) 1.6 16V 01.1995/10.1998 66KW 90CV 1597CC L1E L1K 2028343 8566325 8566313 7528378 0928824 - FORD ESCORT VI (GAL, AAL, ABL) 1.6 i 16V 01.1995/08.1995 65KW 88CV 1597CC L1H 2028363 7...</p>		<p><b>E1017</b> NO. 6905927 - 7131646 - 93AB.5A262.BA - 93AB5A262AA</p> <p>ESTICADOR DE ESCAPE</p> <p>FORD ESCORT KAT (1992 A 10-1995) - FORD ORION KAT (1992 A 1993)</p>

	<p><b>E1018</b> NO. 1027374 - 6831302 - 6866417 - 93B85A262F - 93B85A262G - 93BB5A262GA</p> <p>ESTICADOR DE ESCAPE</p> <p>FORD ESCORT IV</p> <p>66x54x19mm</p>		<p><b>E1029</b> NO. 6827033 - 6882943 - 92AB5A262CD</p> <p>ESTICADOR DE ESCAPE</p> <p>FORD ESCORT CLASSIC Turnier (ANL) 1.8 TD 02.1999/07.2000 66KW 90CV 1753CC RFK RFD RFS 8566334 - FORD ESCORT V (AAL, ABL) 1.6 i 16V 09.1992/01.1995 66KW 90CV 1597CC L1E 2028343 7528378 0928824 - FORD ESCORT V (AAL, ABL) 1.6 i 16V 01.1994/01.1995 65KW 88CV 1597CC L1H 2028363 7528392 0928865 - FORD ESCORT V (AAL, ABL) 1.8 16V XR3i 02.1992/01.1995 77KW 105CV 1796CC RDA 0928808 7528373 - FORD ESCORT V ...</p> <p>63x47x18mm</p>
	<p><b>E1070</b> NO. 1003890 - 1016405 - 1099277 - 1118218</p> <p>ESTICADOR DE ESCAPE</p> <p>FORD ESCORT V (AAL, ABL): 1.3 07.1990/01.1995 44KW 60CV 1299CC - FORD ESCORT VI (GAL, AAL, ABL): 1.3 01.1995/10.1998 44KW 60CV 1299CC - FORD ESCORT VI (GAL, AAL, ABL): 1.8 TD 01.1995/10.1998 66KW 90CV 1753CC</p> <p>70x50x27mm</p>		<p><b>E1070</b> NO. 1003890 - 1016405 - 1099277 - 1118218</p> <p>ESTICADOR DE ESCAPE</p> <p>FORD ORION</p> <p>70x50x27mm</p>
	<p><b>E1087</b> NO. 1022729</p> <p>ESTICADOR DO ESCAPE</p> <p>FORD ESCORT (1995 A 1999)</p> <p>70x50x25mm</p>		<p><b>E80344BC</b> NO. 6567507 - 924F9740AA</p> <p>ESTICADOR BOMBA DE COMBUSTIVEL</p> <p>FORD ESCORT III (GAA) 1.1 09.1980/08.1983 40KW 55CV 1117CC GMA GLB 0928536 7528307 - FORD ESCORT III (GAA) 1.1 09.1980/08.1983 43KW 59CV 1117CC GPA 0928537 0928542 - FORD ESCORT III (GAA) 1.1 08.1983/12.1985 37KW 50CV 1117CC GSE 0928580 7528310 - FORD ESCORT III (GAA) 1.3 09.1980/12.1985 51KW 69CV 1296CC JPA 0928538 7528308 - FORD ESCORT III (GAA) 1.6 09.1980/12.1985 58KW 79CV 1597CC LPA LP1 092...</p> <p>371x11x10mm</p>
	<p><b>E80344BC</b> NO. 6567507 - 924F9740AA</p> <p>ESTICADOR BOMBA DE COMBUSTIVEL</p> <p>FORD ESCORT IV (GAF, AWF, ABFT) 1.1 12.1985/07.1990 37KW 50CV 1117CC GSG 0928619 7528322 - FORD ESCORT IV (GAF, AWF, ABFT) 1.3 01.1986/07.1990 44KW 60CV 1297CC JBB JLA JLB 0928620 7528323 - FORD ESCORT IV (GAF, AWF, ABFT) 1.3 (GAF) 07.1988/10.1990 46KW 63CV 1297CC JBA 0928697 7528340 - FORD ESCORT IV (GAF, AWF, ABFT) 1.4 01.1986/07.1990 54KW 73CV 1392CC FUC F6D F6B 0928645 7528335 - FORD ESCORT IV...</p> <p>371x11x10mm</p>		<p><b>E80344BC</b> NO. 6567507 - 924F9740AA</p> <p>ESTICADOR BOMBA DE COMBUSTIVEL</p> <p>FORD ORION I (AFD) 1.3 07.1983/03.1986 51KW 69CV 1296CC JPA 0928576 - FORD ORION I (AFD) 1.6 07.1983/03.1986 58KW 79CV 1597CC LP1 LPA 0928577 - FORD ORION I (AFD) 1.6 D 02.1984/03.1986 40KW 54CV 1608CC LTA 0928586 7528320 - FORD ORION I (AFD) 1.6 i 07.1983/03.1986 77KW 105CV 1597CC LRA LR1 0928578 7528315</p> <p>371x11x10mm</p>
	<p><b>E80344BC</b> NO. 6567507 - 924F9740AA</p> <p>ESTICADOR BOMBA DE COMBUSTIVEL</p> <p>FORD ORION II (AFF) 1.3 12.1985/07.1990 44KW 60CV 1297CC JBB JLA JLB 0928625 7528328 - FORD ORION II (AFF) 1.4 12.1985/07.1990 55KW 75CV 1392CC FUA 0928626 7528329 - FORD ORION II (AFF) 1.4 01.1986/07.1990 54KW 73CV 1392CC FUC 0928647 7528336 - FORD ORION II (AFF) 1.4 03.1986/07.1990 52KW 72CV 1392CC FUAA 0928779 - FORD ORION II (AFF) 1.4 Cat 02.1987/07.1990 54KW 73CV 1392CC F6D F6B 0928647 - FORD...</p> <p>371x11x10mm</p>		<p><b>E80344BC</b> NO. 6567507 - 924F9740AA</p> <p>ESTICADOR BOMBA DE COMBUSTIVEL</p> <p>FORD ORION III (GAL) 1.3 07.1990 -12.1993) 44kw 60cv 1299cm3 três volumes FORD ORION III (GAL) 1.4 07.1990 -12.1993) 52kw 71cv 1391cm3 três volumes FORD ORION III (GAL) 1.4 07.1990 -12.1993) 54kw 73cv 1392cm3 três volumes FORD ORION III (GAL) 1.6 07.1990 -12.1992) 66kw 90cv 1598cm3 três volumes FORD ORION III (GAL) 1.6 i 07.1990 -09.1992) 77kw 105cv 1598cm3 três volumes FORD ORION III (GAL) 1.6 i ...</p> <p>371x11x10mm</p>
	<p><b>F0386-I</b> NO. 1470870 - 6047901 - 6079916</p> <p>FOLE DA CREMALHEIRA DA DIRECÇÃO ESQ. E DIR.</p> <p>FORD ESCORT TT(APÓS 80) - ORION TT</p> <p>d59x157mm 1f-d30mm 1f-d10mm</p>		<p><b>F0387-I</b> NO. 6047900 - 6047904</p> <p>FOLE DA CREMALHEIRA DA DIRECÇÃO ESQ. E DIR.</p> <p>FORD ESCORT III 1.1 - 1.3 - 1.6 - 1.6i (1980 A 1986)</p> <p>d58x127mm 1f-d47mm 1f-d8mm</p>
	<p><b>F0456-I</b> NO. 1451308 - 1454203 - 1512346 - 6060790</p> <p>FOLE DA CREMALHEIRA DA DIRECÇÃO DIREITO (F1034)</p> <p>FORD ESCORT (ATÉ 8-79)</p> <p>d55x160mm 1f-d33mm 1f-d9mm</p>		<p><b>F0457-I</b> NO. 1454202 - 1467265 - 6060786</p> <p>FOLE DA CREMALHEIRA DA DIRECÇÃO ESQUERDO (F1035)</p> <p>FORD ESCORT (ATÉ 8-79)</p> <p>d55x120mm 1f-d43mm 1f-d9mm</p>
	<p><b>F0462-I</b> NO. 1568353 - 1568676</p> <p>FOLE DA CREMALHEIRA DA DIRECÇÃO ESQ. E DIR.</p> <p>FORD ESCORT (ATÉ FINS 59) - PICK-UP (81 A 10-82)</p> <p>d65x150mm 1f-d47mm 1f-d9mm</p>		<p><b>F0469-I</b> NO. 1016761 - 1495776 - 1579855</p> <p>FOLE DA TRANSMISSÃO LADO DA CAIXA</p> <p>FORD ESCORT VI (GAL, AAL, ABL): RS 2000 4x4 02.1995/10.1998 110KW 150CV 1998CC</p> <p>d85x80mm 1f-d61mm 1f-d23mm</p>

	<p><b>F0538-I</b> NO. 1073846 - 6043191 - 77TTA331FA - 98AX.4A084.BA</p> <p>FOLE DO SEMI-EIXO JUNTO À RODA OU CAIXA DE VELOCIDADES FORD ESCORT 1.3 - 1.6 - ORION 1.3 - 1.6</p> <p>d92x100mm 1f-d75mm 1f-d20mm</p>		<p><b>F0539-I</b> NO. 1016756 - 556021105 - 6028724 - 77TT3A331AA</p> <p>FOLE DO SEMI-EIXO JUNTO À RODA FORD ESCORT 1.1</p> <p>d81x100mm 1f-d68mm 1f-d20mm</p>
	<p><b>F0547-I</b> NO. 1016758 - 1072806 - 1073802 - 1073803 - 6028751 - 6161378 - 77TT3A331BA - 86AG3A331AA - 98FX4A084BA...</p> <p>FOLE DO SEMI-EIXO JUNTO À CAIXA DE VELOCIDADES FORD ESCORT 1.1</p> <p>d63x93mm 1f-d72mm 1f-d19mm</p>		<p><b>F1027</b> NO. 0440888 - 1649554 - 440888 - 83BG.4846.AA</p> <p>FOLE APOIO SUPORTE REPARAÇÃO TRANSMISSÃO</p> <p>FORD ESCORT I (AFH, ATH): 950 08.1968/08.1974 25KW 34CV 940CC - FORD ESCORT I (AFH, ATH): 950 08.1968/08.1974 26KW 36CV 940CC - FORD ESCORT I (AFH, ATH): 1100 06.1968/06.1971 29KW 40CV 1098CC - FORD ESCORT I (AFH, ATH): 1100 01.1968/12.1974 32KW 45CV 1098CC - FORD ESCORT I (AFH, ATH): 1100 06.1968/06.1971 33KW 45CV 1098CC - FORD ESCORT I (AFH, ATH): 1100 06.1970/02.1976 35KW 48CV 1098CC - FORD ES...</p> <p>d94x62mm 1f-d54mm</p>
	<p><b>F1027</b> NO. 0440888 - 1649554 - 440888 - 83BG.4846.AA</p> <p>FOLE APOIO SUPORTE REPARAÇÃO TRANSMISSÃO</p> <p>FORD ORION I (AFD): 1.3 07.1983/03.1986 51KW 69CV 1296CC - FORD ORION I (AFD): 1.6 07.1983/03.1986 58KW 79CV 1597CC - FORD ORION II (AFF): 1.3 12.1985/07.1990 44KW 60CV 1297CC - FORD ORION II (AFF): 1.4 03.1986/07.1990 52KW 72CV 1392CC - FORD ORION II (AFF): 1.4 01.1986/07.1990 54KW 73CV 1392CC - FORD ORION II (AFF): 1.4 12.1985/07.1990 55KW 75CV 1392CC - FORD ORION II (AFF): 1.6 12.1985/07.1990 6...</p> <p>d94x62mm 1f-d54mm</p>		<p><b>F1043-18</b> NO. 1450821 - 69AB3025BA</p> <p>FOLE DO AMORTECEDOR DA SUSPENSÃO FRENTE</p> <p>FORD ESCORT (0.9-1.1-1.3-1.6) ESCORT DIESEL (1.6-1.8) - ORION(1.3-1.4-1.6) - DIESEL(1.6-1.8)</p> <p>d75x145mm 1f-d68mm 1f-d18mm</p>
	<p><b>F1081-I</b> NO. 1610365 - 617346 - 617347 - 84AB.3K661.AA</p> <p>FOLE DA DIRECÇÃO</p> <p>FORD ESCORT (APÓS 6-83) - FURGÃO VAN 55 - ORION (APÓS 6-83)</p> <p>d60x230mm 1f-d48mm 1f-d10mm</p>		<p><b>F1081-I</b> NO. 1610365 - 617346 - 617347 - 84AB.3K661.AA</p> <p>FOLE DA DIRECÇÃO</p> <p>FORD ESCORT (APÓS 6-83) - FURGÃO VAN 55 - ORION (APÓS 6-83)</p> <p>d60x230mm 1f-d48mm 1f-d10mm</p>
	<p><b>F1183-I</b> NO. 6676140 - 92AG003L537AA</p> <p>FOLE JUNTO À CAIXA DE VELOCIDADES</p> <p>FORD ESCORT VI 1.8i (1992 A 1995) - ESCORT VII 1.8i - 1.8D - 1.8TD (1995 A 2000)</p> <p>d100x103mm 1f-d85mm 1f-d23mm</p>		<p><b>F1294-I</b> NO. 6127744</p> <p>FOLE DA DIRECÇÃO LADO DIREITO E ESQUERDO</p> <p>FORD ESCORT MK IV 10-88 A 10-90 ESCORT MK V APÓS 9-90 - ORION APÓS 1983</p> <p>d60x220mm 1f-d37mm 1f-d11mm</p>
	<p><b>F1294-I</b> NO. 6127744</p> <p>FOLE DA DIRECÇÃO LADO DIREITO E ESQUERDO</p> <p>FORD ESCORT MK IV 10-88 A 10-90 ESCORT MK V APÓS 9-90 - ORION APÓS 1983</p> <p>d60x220mm 1f-d37mm 1f-d11mm</p>		<p><b>F1444-I</b> NO. 6676136 - 92TT3A331</p> <p>FOLE DA TRANSMISSÃO JUNTO À RODA</p> <p>FORD ESCORT VII 1.8 TD (1995 A 1999)</p> <p>d104x92mm 1f-d87mm 1f-d23mm</p>
	<p><b>F1649-I</b> NO. 1012814 - 3043575 - 7138554 - 94FB3K661AC</p> <p>FOLE DA DIRECÇÃO ASSISTIDA LADO DIREITO E ESQUERDO</p> <p>FORD ESCORT V (AAL, ABL): 1.3 07.1990/01.1995 44KW 60CV 1299CC - FORD ESCORT V (AAL, ABL): 1.4 07.1990/01.1995 52KW 71CV 1392CC - FORD ESCORT V (AAL, ABL): 1.4 09.1990/12.1994 55KW 75CV 1392CC - FORD ESCORT V (AAL, ABL): 1.6 i 16V 01.1994/01.1995 65KW 88CV 1597CC - FORD ESCORT V (AAL, ABL): 1.6 07.1990/08.1992 66KW 90CV 1598CC - FORD ESCORT V (AAL, ABL): 1.6 i 16V 09.1992/01.1995 66KW 90CV 1597CC ...</p> <p>d70x190mm 1f-d55mm 1f-d12mm</p>		<p><b>F1649-I</b> NO. 1012814 - 3043575 - 7138554 - 94FB3K661AC</p> <p>FOLE DA DIRECÇÃO ASSISTIDA LADO DIREITO E ESQUERDO</p> <p>FORD ORION III (GAL): 1.3 07.1990/12.1993 44KW 60CV 1299CC - FORD ORION III (GAL): 1.4 07.1990/12.1993 52KW 71CV 1391CC - FORD ORION III (GAL): 1.4 07.1990/12.1993 54KW 73CV 1392CC - FORD ORION III (GAL): 1.6 i 16V 07.1992/12.1993 66KW 90CV 1597CC - FORD ORION III (GAL): 1.6 07.1990/12.1992 66KW 90CV 1598CC - FORD ORION III (GAL): 1.6 i 07.1990/09.1992 77KW 105CV 1598CC - FORD ORION III (GAL): 1...</p> <p>d70x190mm 1f-d55mm 1f-d12mm</p>
	<p><b>F1668-I</b> NO. 1619061 - 83BB.3K661.BD</p> <p>FOLE DA DIRECÇÃO DIREITO E ESQUERDO</p> <p>FORD ESCORT MK III - MK IV - MK V</p> <p>d62x200mm 1f-d37mm 1f-d10mm</p>		<p><b>F1702-I</b> NO.</p> <p>FOLE DA DIRECÇÃO LADO DIREITO E ESQUERDO</p> <p>FORD ESCORT VII (1995 A 2000 1.6i &amp; XR3i 16V</p> <p>d59x160mm 1f-d45mm 1f-d11mm</p>

















	<p><b>F1716-T</b> NO. 1085517 - 3043575 - 6182818 - 87BB3K661AA</p> <p>FOLE DA DIRECÇÃO ASSISTIDA DIREITO E ESQUERDO</p> <p>FORD ORION 1.1 - 1.3 - 1.4 - 1.6 - 1.6 16V - 1.6 D - 1.8 16V - 1.8 D - 1.8 TD (APÓS 1990)</p> <p>d61x190mm 1f-d46mm 1f-d13mm</p>		<p><b>F1855-I</b> NO. 2T143K661AA - 4381841 - 6177346 - 6182218 - 6935233 - 86AB3K661A1A - 92AB3K661AA - 98AG3K661AA</p> <p>FOLE DA DIRECÇÃO LADO DIREITO E ESQUERDO</p> <p>FORD ESCORT V (AAL, ABL): 1.3 07.1990/01.1995 44KW 60CV 1299CC - FORD ESCORT V (AAL, ABL): 1.4 07.1990/01.1995 52KW 71CV 1392CC - FORD ESCORT V (AAL, ABL): 1.4 09.1990/12.1994 55KW 75CV 1392CC - FORD ESCORT V (AAL, ABL): 1.6 i 16V 01.1994/01.1995 65KW 88CV 1597CC - FORD ESCORT V (AAL, ABL): 1.6 07.1990/08.1992 66KW 90CV 1598CC - FORD ESCORT V (AAL, ABL): 1.6 i 16V 09.1992/01.1995 66KW 90CV 1597CC ...</p> <p>d60x220mm 1f-d37mm 1f-d13mm</p>
	<p><b>F1855-I</b> NO. 2T143K661AA - 4381841 - 6177346 - 6182218 - 6935233 - 86AB3K661A1A - 92AB3K661AA - 98AG3K661AA</p> <p>FOLE DA DIRECÇÃO LADO DIREITO E ESQUERDO</p> <p>FORD ORION II (AFF): 1.3 12.1985/07.1990 44KW 60CV 1297CC - FORD ORION II (AFF): 1.4 01.1986/07.1990 54KW 73CV 1392CC - FORD ORION II (AFF): 1.4 Cat 02.1987/07.1990 54KW 73CV 1392CC - FORD ORION II (AFF): 1.4 12.1985/07.1990 55KW 75CV 1392CC - FORD ORION II (AFF): 1.6 12.1985/07.1990 66KW 90CV 1597CC - FORD ORION II (AFF): 1.6 i Cat 03.1986/07.1990 66KW 90CV 1597CC - FORD ORION II (AFF): 1.6 i 08....</p> <p>d60x220mm 1f-d37mm 1f-d13mm</p>		<p><b>H731</b> NO.</p> <p>PALA ORIGINAL FORD ESCORT</p> <p>FORD ESCORT</p> <p>400x230mm</p>
	<p><b>KF1800</b> NO. 1016756 - 556021105 - 6028724 - 77TT3A331AA</p> <p>FOLE DO LADO DA RODA (DIAM. 68mm)</p> <p>FORD ESCORT 1.1 - ESCORT VAN MK III - ESCORT VAN DIESEL</p> <p>d89x100mm 1f-d20mm 1f-d68mm</p>		<p><b>KF1810</b> NO. 1016760 - 1073805 - 1073846 - 1638320 - 6043191 - 6053206 - 77TT3A331FA - 95SX4K258DA - 98AX.4A08...</p> <p>FOLE DO LADO DA RODA (DIAM. 78mm)</p> <p>FORD ESCORT 1.3 - 1.6 - ESCORT VAN MK III-P100 PICK-UP - ORION</p> <p>d93x103mm 1f-d20mm 1f-d78mm</p>
	<p><b>KF9002</b> NO. 1073803 - 86AG3A331AA - 98FX4A084CA</p> <p>KIT DE FOLE DO CARDAN LADO DA CAIXA</p> <p>FORD ESCORT 1.3 - 1.4 - 1.6 16V - 1.8D - 1.8i 16V - 1.8 TD APÓS 1995 (CAIXA (4 VELOCIDADES))</p> <p>d88x83mm 1f-d73mm 1f-d21mm</p>		<p><b>KL1066-I</b> NO. 6180329 - 6189055</p> <p>KIT DO PEDAL DA EMBRAIAGEM</p> <p>FORD ESCORT - ORION (2ª SÉRIE)</p> <p>123x70x20mm</p>
	<p><b>L0221</b> NO. 105E-5719 - 1710123</p> <p>CASQUILHO DE MOLAS</p> <p>FORD ESCORT MK I 10.1967/09.1968 - FORD ESCORT MK I 08.1968/1974 - FORD ESCORT MK I VAN 09.1968/1974</p> <p>d24x35mm d20mm 1f-d12mm</p>		<p><b>L0262</b> NO. 1487654</p> <p>CASQUILHO SILENT-BLOCO BRAÇO SUSPENSÃO FRENTE (GASTA 2 UNIDADES)</p> <p>FORD ESCORT I (AFH, ATH): 950 08.1968/08.1974 25KW 34CV 940CC - FORD ESCORT I (AFH, ATH): 950 08.1968/08.1974 26KW 36CV 940CC - FORD ESCORT I (AFH, ATH): 1100 06.1968/06.1971 29KW 40CV 1098CC - FORD ESCORT I (AFH, ATH): 1100 01.1968/12.1974 32KW 45CV 1098CC - FORD ESCORT I (AFH, ATH): 1100 06.1968/06.1971 33KW 45CV 1098CC - FORD ESCORT I (AFH, ATH): 1100 06.1970/02.1976 35KW 48CV 1098CC - FORD ESC...</p> <p>d30x40mm d25mm 1f-d9mm</p>
	<p><b>L1030</b> NO. 1412951 - 1421951 - 6100095</p> <p>CASQUILHO DE BRAÇOS DE SUSPENSÃO</p> <p>FORD ESCORT I (AFH, ATH): 950 08.1968/08.1974 25KW 34CV 940CC - FORD ESCORT I (AFH, ATH): 950 08.1968/08.1974 26KW 36CV 940CC - FORD ESCORT I (AFH, ATH): 1100 06.1968/06.1971 29KW 40CV 1098CC - FORD ESCORT I (AFH, ATH): 1100 01.1968/12.1974 32KW 45CV 1098CC - FORD ESCORT I (AFH, ATH): 1100 06.1968/06.1971 33KW 45CV 1098CC - FORD ESCORT I (AFH, ATH): 1100 06.1970/02.1976 35KW 48CV 1098CC - FORD ESC...</p> <p>d41x37mm 1f-d20mm</p>		<p><b>L1044</b> NO. 1487654</p> <p>CASQUILHO SILENT-BLOCO BRAÇO SUSPENSÃO FRENTE (GASTA 2 UNIDADES)</p> <p>FORD ESCORT I (AFH, ATH): 950 08.1968/08.1974 25KW 34CV 940CC - FORD ESCORT I (AFH, ATH): 950 08.1968/08.1974 26KW 36CV 940CC - FORD ESCORT I (AFH, ATH): 1100 06.1968/06.1971 29KW 40CV 1098CC - FORD ESCORT I (AFH, ATH): 1100 01.1968/12.1974 32KW 45CV 1098CC - FORD ESCORT I (AFH, ATH): 1100 06.1968/06.1971 33KW 45CV 1098CC - FORD ESCORT I (AFH, ATH): 1100 06.1970/02.1976 35KW 48CV 1098CC - FORD ESC...</p> <p>d30x43mm d25mm 1f-d11mm</p>
	<p><b>L3004</b> NO. 1652910 - 5021661 - 6107025 - 81AB.5K897.BB - 81AB5K897BA</p> <p>CASQUILHO DA BARRA ESTABILIZADORA DA FRENTE</p> <p>FORD ESCORT 0.9 - 1.1 - 1.3 - ESCORT DIESEL 1.6 - 1.8 - ORION 1.3 - 1.4 - 1.6 - ORION DIESEL 1.6 - 1.8</p> <p>d45x20mm d42mm 1f-d16mm</p>		<p><b>L3005</b> NO. 1568682 - 1610371 - 6076533</p> <p>CASQUILHO DA EXTREMIDADE DA CREMALHEIRA DA DIRECÇÃO</p> <p>FORD ESCORT I (AFH, ATH) 1100 01.1968/12.1974 32KW 45CV 1098CC G1 1005520 1005524 - FORD ESCORT I (AFH, ATH) 1100 06.1968/06.1971 29KW 40CV 1098CC KL.11 1005236 1005502 - FORD ESCORT I (AFH, ATH) 1100 06.1968/06.1971 33KW 45CV 1098CC G1 1005237 1005503 - FORD ESCORT I (AFH, ATH) 1100 06.1970/02.1976 35KW 48CV 1098CC G2 1005521 1005525 - FORD ESCORT I (AFH, ATH) 1300 06.1968/06.1971 35KW 48CV 1298CC...</p> <p>32x32x18mm 1f-d22mm</p>
	<p><b>L3008</b> NO. 1610371</p> <p>CASQUILHO DA DIRECÇÃO</p> <p>FORD ESCORT I (AFH, ATH) INFORMAÇÕES TIPO ANO DE CONSTRUÇÃO KW HP CC CÓDIGO(S) DO MOTOR NÚMERO KBA (ALEMANHA)</p>		







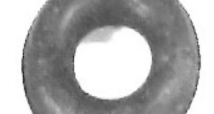







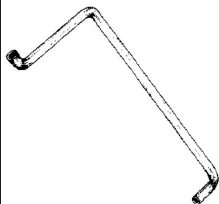

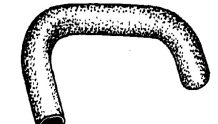







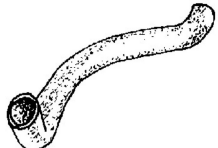

1100 01.1968 - 12.1974 32 45 1098  
G1  
1005520 1005524  
1100 06.1968 - 06.1971 29 40 1098  
KL11  
1005236 1005502  
1100 06.1968 - 06.1971 33 45 1098  
G1  
1005237 1005503  
1100 06.1970 - 02.1976 35 48 1098  
G2  
1005521 1005525  
1300 06.1968 - 06.1971 35 ...

















35x35x18mm	1f-d22mm







	<b>M6002</b> NO. 1656281 - 6156722 - 6166244 - 6201608 - 6616584 - 6688868
	JUNTA DE ESCAPE FORD ESCORT (1990 A 1992) - ORION (APÓS 1990)
d66x14mm	1f-d50mm

	<p><b>M6037</b> NO. 1565558 - 6065962 - 6115136 - 6134622 - 6134623 - 6615275 - 81AB9451AA</p> <p>JUNTA DE ESCAPE</p> <p>FORD ESCORT (1975 A 1994) - ORION (1983 A 1993)</p>		<p><b>M6043</b> NO. 1630835 - 6120644 - 6120664 - 6134624 - 6163389</p> <p>JUNTA DE ESCAPE</p> <p>FORD ESCORT (1983 A 1986) - ORION (1984 A 1993)</p>
	<p>107x80mm 2f-d42mm</p>		<p>120x80mm 2f-d42mm</p>
	<p><b>M6057</b> NO. 6692784 - 6797187 - 6993854</p> <p>JUNTA DE ESCAPE</p> <p>FORD ESCORT (APÓS 1991)</p>		<p><b>M6067</b> NO. 6642508 - 6692741</p> <p>JUNTA DE ESCAPE</p> <p>FORD ESCORT (APÓS 1991) - ORION (APÓS 1991)</p>
	<p>132x75mm 1f-d61.3mm</p>		<p>117x70mm 1f-d58mm</p>
	<p><b>M6069</b> NO. 6645622</p> <p>JUNTA DE ESCAPE</p> <p>FORD ESCORT (1983 A 1992) - ORION (1984 A 1993)</p>		<p><b>M6070</b> NO. 1664671</p> <p>JUNTA DE ESCAPE</p> <p>FORD ESCORT (APÓS 1989) - ORION (1990 A 1992)</p>
	<p>120x65mm 2f-d42mm</p>		<p>120x71mm 1f-d55mm</p>
	<p><b>M6071</b> NO. 6168647 - 6645621</p> <p>JUNTA DE ESCAPE</p> <p>FORD ESCORT (APÓS 1989) - ORION (1990 A 1992)</p>		<p><b>M6079</b> NO. 1709852 - 6027648 - 749451BA</p> <p>JUNTA DE ESCAPE</p> <p>FORD ESCORT (1974 A 1980)</p>
	<p>124x75mm 2f-d45mm</p>		<p>54x13mm 1f-d41mm</p>
	<p><b>M6087</b> NO. 1654627 - 6616586 - 6634401 - 6745092</p> <p>JUNTA DE ESCAPE</p> <p>FORD ESCORT (1986 A 1990)</p>		<p><b>M6095</b> NO. 6789153 - 7398780</p> <p>JUNTA DE ESCAPE</p> <p>FORD ESCORT (APÓS 1992) - ORION (1991 A 1993)</p>
	<p>d76x13mm 1f-d60mm</p>		<p>d95x13mm 1f-d75mm</p>
	<p><b>M6096</b> NO. 6504754 - 6616185 - 6688869 - 6745091</p> <p>JUNTA DE ESCAPE</p> <p>FORD ESCORT (1990 A 1992) - ORION (1990 A 1992)</p>		<p><b>M6102</b> NO. 6159982 - 6162279 - 6642511 - 6692744</p> <p>JUNTA DE ESCAPE</p> <p>FORD ESCORT (1995 A 2000) - ORION (1983 A 1991)</p>
	<p>d70x13mm 1f-d55mm</p>		<p>127x70x2mm 1f-d56mm</p>
	<p><b>M6108</b> NO. 6026339</p> <p>JUNTA DE ESCAPE</p> <p>FORD ESCORT (74-83) - ORION (APÓS 81)</p>		<p><b>N1617</b> NO.</p> <p>ANEL DE ESCAPE</p> <p>FORD ESCORT</p>
	<p>57x14mm 1f-d43mm</p>		<p>d65x13mm 1f-d40mm</p>
	<p><b>N2002</b> NO. 113E5381B - 1719466</p> <p>ANEL DE ESCAPE</p> <p>FORD ESCORT (1968 A 1999)</p>		<p><b>N2336</b> NO. 1719466</p> <p>ANEL ESCAPE</p> <p>FORD ESCORT I (AFH, ATH): 950 08.1968/08.1974 25KW 34CV 940CC - FORD ESCORT I (AFH, ATH): 950 08.1968/08.1974 26KW 36CV 940CC - FORD ESCORT I (AFH, ATH): 1100 06.1968/06.1971 29KW 40CV 1098CC - FORD ESCORT I (AFH, ATH): 1100 01.1968/12.1974 32KW 45CV 1098CC - FORD ESCORT I (AFH, ATH): 1100 06.1970/02.1976 35KW 48CV 1098CC - FORD ESCORT I (AFH, ATH): 1300 06.1968/06.1971 35KW 48CV 1298CC - FORD ESC...</p>
	<p>d43x12mm 1f-d19mm</p>		<p>d62x14mm 1f-d36mm</p>

	<p><b>P1010</b> NO. 1526242 - 72EB2457BA</p> <p><b>CAPA DE PEDAL DO TRAVÃO E EMBRAIAGEM</b></p> <p>FORD ESCORT I (AFH, ATH): 950 08.1968/08.1974 25KW 34CV 940CC - FORD ESCORT I (AFH, ATH): 950 08.1968/08.1974 26KW 36CV 940CC - FORD ESCORT I (AFH, ATH): 1100 06.1968/06.1971 29KW 40CV 1098CC - FORD ESCORT I (AFH, ATH): 1100 01.1968/12.1974 32KW 45CV 1098CC - FORD ESCORT I (AFH, ATH): 1100 06.1968/06.1971 33KW 45CV 1098CC - FORD ESCORT I (AFH, ATH): 1100 06.1968/06.1971 33KW 45CV 1098CC - FORD ESCORT I (AFH, ATH): 1100 06.1970/02.1976 35KW 48CV 1098CC - FORD ESC...</p> <p>68x49x15mm PINO-39x11x4mm</p>		<p><b>P1010</b> NO. 1526242 - 72EB2457BA</p> <p><b>CAPA DE PEDAL DO TRAVÃO E EMBRAIAGEM</b></p> <p>FORD ORION I (AFD): 1.3 07.1983/03.1986 51KW 69CV 1296CC - FORD ORION I (AFD): 1.6 07.1983/03.1986 58KW 79CV 1597CC - FORD ORION I (AFF): 1.6 07.1983/03.1986 77KW 105CV 1597CC - FORD ORION I (AFF): 1.6 02.1984/03.1986 40KW 54CV 1608CC - FORD ORION II (AFF): 1.3 12.1985/07.1990 44KW 60CV 1297CC - FORD ORION II (AFF): 1.4 03.1986/07.1990 52KW 72CV 1392CC - FORD ORION II (AFF): 1.4 03.1986/07.1990 52KW 72CV 1392CC - FORD ORION II (AFF): 1.4 01.1986/07.199...</p> <p>68x49x15mm PINO-39x11x4mm</p>
	<p><b>P1026</b> NO. 6168375 - 89FB.2457.AA</p> <p><b>CAPA DE PEDAL TRAVÃO E EMBRAIAGEM</b></p> <p>FORD ESCORT V (AAL, ABL): 1.3 07.1990/01.1995 44KW 60CV 1299CC - FORD ESCORT V (AAL, ABL): 1.4 07.1990/01.1995 52KW 71CV 1392CC - FORD ESCORT V (AAL, ABL): 1.4 09.1990/12.1994 55KW 75CV 1392CC - FORD ESCORT V (AAL, ABL): 1.6 i 16V 01.1994/01.1995 65KW 88CV 1597CC - FORD ESCORT V (AAL, ABL): 1.6 07.1990/08.1992 66KW 90CV 1598CC - FORD ESCORT V (AAL, ABL): 1.6 i 16V 09.1992/01.1995 66KW 90CV 1597CC ...</p> <p>68x54x14mm</p>		<p><b>P1026</b> NO. 6168375 - 89FB.2457.AA</p> <p><b>CAPA DE PEDAL TRAVÃO E EMBRAIAGEM</b></p> <p>FORD ORION I (AFD): 1.3 07.1983/03.1986 51KW 69CV 1296CC - FORD ORION I (AFD): 1.6 07.1983/03.1986 58KW 79CV 1597CC - FORD ORION II (AFF): 1.3 12.1985/07.1990 44KW 60CV 1297CC - FORD ORION II (AFF): 1.4 03.1986/07.1990 52KW 72CV 1392CC - FORD ORION II (AFF): 1.4 01.1986/07.1990 54KW 73CV 1392CC - FORD ORION II (AFF): 1.4 12.1985/07.1990 55KW 75CV 1392CC - FORD ORION II (AFF): 1.6 12.1985/07.1990 6...</p> <p>68x54x14mm</p>
	<p><b>R0685</b> NO.</p> <p><b>TUBO DA CHAUFAGE</b></p> <p>FORD ESCORT (APÓS 1977)</p> <p>B570-d13/11mm 40-265-500-80mm</p>		<p><b>R220209</b> NO. 6190366 - 89AB8260BC</p> <p><b>TUBO SUPERIOR DO RADIADOR</b></p> <p>FORD ORION II (AFF): 1.3 12.1985/07.1990 44KW 60CV 1297CC</p> <p>B285-d30/36mm 90-55-100-110mm</p>
	<p><b>R220209</b> NO. 6190366 - 89AB8260BC</p> <p><b>TUBO SUPERIOR DO RADIADOR</b></p> <p>FORD ESCORT IV (GAF, AWF, ABFT): 1.1 12.1985/07.1990 37KW 50CV 1117CC - FORD ESCORT IV (GAF, AWF, ABFT): 1.3 01.1986/07.1990 44KW 60CV 1297CC - FORD ESCORT IV (GAF, AWF, ABFT): 1.3 (GAF) 07.1988/10.1990 46KW 63CV 1297CC - FORD ESCORT IV Turnier (AWF, AVF): 1.1 10.1985/09.1990 37KW 50CV 1117CC - FORD ESCORT IV Turnier (AWF, AVF): 1.3 01.1986/07.1990 44KW 60CV 1297CC - FORD ESCORT 86 Express (AVF): ...</p> <p>B285-d30/36mm 90-55-100-110mm</p>		<p><b>R220440</b> NO. 1459488 - 1546885</p> <p><b>TUBO DE RADIADOR INFERIOR</b></p> <p>FORD ESCORT I (AFH, ATH) 1100 01.1968/12.1974 32KW 45CV 1098CC G1 1005520 1005524 - FORD ESCORT I (AFH, ATH) 1100 06.1968/06.1971 29KW 40CV 1098CC KL11 1005236 1005502 - FORD ESCORT I (AFH, ATH) 1100 06.1968/06.1971 33KW 45CV 1098CC G1 1005237 1005503 - FORD ESCORT I (AFH, ATH) 1100 06.1970/02.1976 35KW 48CV 1098CC - FORD ESCORT I (AFH, ATH) 1100 06.1970/02.1976 35KW 48CV 1098CC G2 1005521 1005525 - FORD ESCORT I Turnier (ADH) 1100 06.1968/06.1971 29KW 40CV 109...</p> <p>B240-d33/33mm 145-170-90mm</p>
	<p><b>R220441</b> NO. 1595579 - 6115579</p> <p><b>TUBO DE RADIADOR INFERIOR</b></p> <p>FORD ESCORT I (AFH, ATH) 1100 01.1968/12.1974 32KW 45CV 1098CC G1 1005520 1005524 - FORD ESCORT I (AFH, ATH) 1100 06.1968/06.1971 29KW 40CV 1098CC KL11 1005236 1005502 - FORD ESCORT I (AFH, ATH) 1100 06.1968/06.1971 33KW 45CV 1098CC G1 1005237 1005503 - FORD ESCORT I (AFH, ATH) 1100 06.1970/02.1976 35KW 48CV 1098CC G2 1005521 1005525 - FORD ESCORT I Turnier (ADH) 1100 06.1968/06.1971 29KW 40CV 109...</p> <p>B430-d32/32mm 80-70-240-140mm</p>		<p><b>R220442</b> NO. 105E8260A - 1465390 - 1546886 - 691F8260AA - 691G8260AA - 72AB8260AA</p> <p><b>TUBO DE RADIADOR SUPERIOR</b></p> <p>FORD ESCORT I (AFH, ATH): 1100 06.1968/06.1971 29KW 40CV 1098CC - FORD ESCORT I (AFH, ATH): 1100 01.1968/12.1974 32KW 45CV 1098CC - FORD ESCORT I (AFH, ATH): 1100 06.1968/06.1971 33KW 45CV 1098CC - FORD ESCORT I (AFH, ATH): 1100 06.1970/02.1976 35KW 48CV 1098CC - FORD ESCORT I Turnier (ADH): 1100 06.1968/06.1971 29KW 40CV 1098CC - FORD ESCORT I Turnier (ADH): 1100 06.1970/02.1976 32KW 44CV 1098CC ...</p> <p>B190-d31/38mm 40-150-150mm</p>
	<p><b>R220443</b> NO. 6088586</p> <p><b>TUBO DE RADIADOR SUPERIOR</b></p> <p>FORD ESCORT I (AFH, ATH) 1100 01.1968/12.1974 32KW 45CV 1098CC G1 1005520 1005524 - FORD ESCORT I (AFH, ATH) 1100 06.1968/06.1971 29KW 40CV 1098CC KL11 1005236 1005502 - FORD ESCORT I (AFH, ATH) 1100 06.1968/06.1971 33KW 45CV 1098CC G1 1005237 1005503 - FORD ESCORT I (AFH, ATH) 1100 06.1970/02.1976 35KW 48CV 1098CC G2 1005521 1005525 - FORD ESCORT I Turnier (ADH) 1100 06.1968/06.1971 29KW 40CV 109...</p> <p>B280-d31/33mm 120-90-70-70mm</p>		<p><b>R220445</b> NO. 6094482</p> <p><b>TUBO DE ENVIO DE ÁGUA AO AQUECIMENTO</b></p> <p>FORD ESCORT I (AFH, ATH) 1100 01.1968/12.1974 32KW 45CV 1098CC G1 1005520 1005524 - FORD ESCORT I (AFH, ATH) 1100 06.1968/06.1971 29KW 40CV 1098CC KL11 1005236 1005502 - FORD ESCORT I (AFH, ATH) 1100 06.1968/06.1971 33KW 45CV 1098CC G1 1005237 1005503 - FORD ESCORT I (AFH, ATH) 1100 06.1970/02.1976 35KW 48CV 1098CC G2 1005521 1005525 - FORD ESCORT I Turnier (ADH) 1100 06.1968/06.1971 29KW 40CV 109...</p> <p>B330-d16/16mm 80-90-190-75mm</p>
	<p><b>R220447</b> NO. 6070349 - 6070359</p> <p><b>TUBO DE RETORNO DA ÁGUA DO AQUECIMENTO</b></p> <p>FORD ESCORT I (AFH, ATH): 1100 06.1968/06.1971 29KW 40CV 1098CC - FORD ESCORT I (AFH, ATH): 1100 01.1968/12.1974 32KW 45CV 1098CC - FORD ESCORT I (AFH, ATH): 1100 06.1968/06.1971 33KW 45CV 1098CC - FORD ESCORT I (AFH, ATH): 1100 06.1970/02.1976 35KW 48CV 1098CC - FORD ESCORT I Turnier (ADH): 1100 06.1968/06.1971 29KW 40CV 1098CC - FORD ESCORT I Turnier (ADH): 1100 06.1970/02.1976 32KW 44CV 1098CC ...</p> <p>B410-d16/16mm 80-380-285-75mm</p>		<p><b>R220501</b> NO. 6079523 - 6115575</p> <p><b>TUBO DE RADIADOR SUPERIOR</b></p> <p>FORD ESCORT I (AFH, ATH) 1300 06.1968/06.1971 35KW 48CV 1298CC KL 13 L 1005238 - FORD ESCORT I (AFH, ATH) 1300 06.1968/06.1971 38KW 52CV 1298CC J2 1005239 1005505 - FORD ESCORT I (AFH, ATH) 1300 06.1970/02.1976 42KW 57CV 1298CC J2 1005522 1005526 - FORD ESCORT I (AFH, ATH) 1300 06.1970/02.1976 53KW 72CV 1298CC J3D 1005523 - FORD ESCORT I (AFH, ATH) 1300 09.1973/02.1976 40KW 54CV 1298CC J1F 1005590...</p> <p>B285-d32/32mm 70-135-65-50mm</p>
	<p><b>R220501</b> NO. 6079523 - 6115575</p> <p><b>TUBO DE RADIADOR SUPERIOR</b></p> <p>FORD ORION I (AFD) 1.3 07.1983/03.1986 51KW 69CV 1296CC JPA 0928576 - FORD ORION I (AFD) 1.6 07.1983/03.1986 58KW 79CV 1597CC LP1 LPA 0928577 - FORD ORION II (AFF) 1.3 12.1985/07.1990 44KW 60CV 1297CC JBB JLA JLB 0928625 7528328 - FORD ORION II (AFF) 1.6 12.1985/07.1990 66KW 90CV 1597CC LUC 0928628 7528331 - FORD ORION III (GAL) 1.3 07.1990/12.1993 44KW 60CV 1299CV J4B J6A 0928769 7528356 - FORD O...</p> <p>B285-d32/32mm 70-135-65-50mm</p>		<p><b>R220502</b> NO. 1595546 - 6099727</p> <p><b>TUBO DE RADIADOR INFERIOR</b></p> <p>FORD ESCORT I (AFH, ATH) 1300 06.1968/06.1971 35KW 48CV 1298CC KL 13 L 1005238 - FORD ESCORT I (AFH, ATH) 1300 06.1968/06.1971 38KW 52CV 1298CC J2 1005239 1005505 - FORD ESCORT I (AFH, ATH) 1300 06.1970/02.1976 42KW 57CV 1298CC J2 1005522 1005526 - FORD ESCORT I (AFH, ATH) 1300 06.1970/02.1976 53KW 72CV 1298CC J3D 1005523 - FORD ESCORT I (AFH, ATH) 1300 09.1973/02.1976 40KW 54CV 1298CC J1F 1005590...</p> <p>B300-d32/32mm 80-120-200-70mm</p>

	<p><b>R220503</b> NO. 6090019</p> <p>TUBO LIGAÇÃO AO DEPÓSITO COMBUSTIVEL</p> <p>FORD ESCORT I (AFH, ATH) 1100 06.1968/06.1971 29KW 40CV 1098CC KL11 1005236 1005502 - FORD ESCORT I (AFH, ATH) 950 08.1968/08.1974 25KW 34CV 940CC 123 - FORD ESCORT III (GAA) 1.1 09.1980/08.1983 40KW 55CV 1117CC GMA GLB 0928536 7528307 - FORD ESCORT III (GAA) 1.1 09.1980/08.1983 43KW 59CV 1117CC GPA 0928537 0928542 - FORD ESCORT III (GAA) 1.1 08.1983/12.1985 37KW 50CV 1117CC GSE 0928580 7528310 - ...</p> <p>B285-42/43mm 220x51mm</p>		<p><b>R220503</b> NO. 6090019</p> <p>TUBO LIGAÇÃO AO DEPÓSITO COMBUSTIVEL</p> <p>FORD ORION I (AFD) 1.3 07.1983/03.1986 51KW 69CV 1296CC JPA 0928576 - FORD ORION I (AFD) 1.6 07.1983/03.1986 58KW 79CV 1597CC LP1 LPA 0928577 - FORD ORION I (AFD) 1.6 D 02.1984/03.1986 40KW 54CV 1608CC LTA 0928586 7528320 - FORD ORION I (AFD) 1.6 I 07.1983/03.1986 77KW 105CV 1597CC LRA LR1 0928578 7528315 - FORD ORION II (AFF) 1.3 12.1985/07.1990 44KW 60CV 1297CC JBB JLA JLB 0928625 7528328 - FORD...</p> <p>B285-42/43mm 220x51mm</p>
	<p><b>R220504</b> NO. 6119164 - 91AB8286BE - 6690353</p> <p>TUBO DE RADIADOR INFERIOR</p> <p>FORD ESCORT I (AFH, ATH) 1300 06.1968/06.1971 35KW 48CV 1298CC KL 13 L 1005238 - FORD ESCORT I (AFH, ATH) 1300 06.1968/06.1971 38KW 52CV 1298CC J2 1005239 1005505 - FORD ESCORT I (AFH, ATH) 1300 06.1970/02.1976 42KW 57CV 1298CC J2 1005522 1005526 - FORD ESCORT I (AFH, ATH) 1300 06.1970/02.1976 53KW 72CV 1298CC J3D 1005523 - FORD ESCORT I (AFH, ATH) 1300 09.1973/02.1976 40KW 54CV 1298CC J1F 1005590...</p> <p>B300-d32/33mm 60-120-165-50-60mm</p>		<p><b>R220504</b> NO. 6119164</p> <p>TUBO DE RADIADOR INFERIOR</p> <p>FORD ORION I (AFD) 1.3 07.1983/03.1986 51KW 69CV 1296CC JPA 0928576 - FORD ORION I (AFD) 1.6 07.1983/03.1986 58KW 79CV 1597CC LP1 LPA 0928577 - FORD ORION II (AFF) - FORD ORION II (AFF) 1.3 12.1985/07.1990 44KW 60CV 1297CC JBB JLA JLB 0928625 7528328 - FORD ORION II (AFF) 1.6 12.1985/07.1990 66KW 90CV 1597CC LUC 0928628 7528331 - FORD ORION III (GAL) 1.3 07.1990/12.1993 44KW 60CV 1299CC J4B J6A 092...</p> <p>B300-d32/33mm 60-120-165-50-60mm</p>
	<p><b>R220505</b> NO. 1604864 - 6146420</p> <p>TUBO DE ENVIO DE ÁGUA AO AQUECIMENTO</p> <p>FORD ORION I (AFD): 1.3 07.1983/03.1986 51KW 69CV 1296CC - FORD ORION I (AFD): 1.6 07.1983/03.1986 58KW 79CV 1597CC - FORD ORION II (AFF): 1.3 12.1985/07.1990 44KW 60CV 1297CC - FORD ORION II (AFF): 1.6 12.1985/07.1990 66KW 90CV 1597CC - FORD ORION III (GAL): 1.3 07.1990/12.1993 44KW 60CV 1299CC - FORD ORION III (GAL): 1.6 07.1990/12.1992 66KW 90CV 1598CC</p> <p>B180-d15/15mm 55-265-385-115-105mm</p>		<p><b>R220505</b> NO. 1604864 - 6146420</p> <p>TUBO DE ENVIO DE ÁGUA AO AQUECIMENTO</p> <p>FORD ESCORT I (AFH, ATH): 1300 06.1968/06.1971 35KW 48CV 1298CC - FORD ESCORT I (AFH, ATH): 1300 06.1968/06.1971 38KW 52CV 1298CC - FORD ESCORT I (AFH, ATH): 1300 09.1973/02.1976 40KW 54CV 1298CC - FORD ESCORT I (AFH, ATH): 1300 06.1970/02.1976 42KW 57CV 1298CC - FORD ESCORT I (AFH, ATH): 1300 06.1970/02.1976 53KW 72CV 1298CC - FORD ESCORT I (AFH, ATH): 1.6 08.1969/11.1974 62KW 84CV 1593CC - FORD...</p> <p>B180-d15/15mm 55-265-385-115-105mm</p>
	<p><b>R220514</b> NO. 6114422</p> <p>TUBO DE ENVIO DE ÁGUA AO AQUECIMENTO</p> <p>RENAULT ESCORT III (GAA): 1.1 08.1983/12.1985 37KW 50CV 1117CC - FORD ESCORT IV (GAF, AWF, ABFT): 1.1 12.1985/07.1990 37KW 50CV 1117CC</p> <p>B220-d15/15mm 145-140-80mm</p>		<p><b>R220921</b> NO. 6182777</p> <p>TUBO SUPERIOR DO RADIADOR</p> <p>FORD ORION II (AFF) 1.8 D (De 1989.01 Até 1990.07) 44kW 60cv 1753cm3 três volumes - FORD ORION III (GAL) 1.8 D (De 1990.11 Até 1993.12) 44kW 60cv 1753cm3 três volumes -</p> <p>B380-30/32mm 48x285x48mm</p>
	<p><b>R221301</b> NO. B315-d32/33mm+ch760-d15mm+ch310-d1</p> <p>TUBO 4 VIAS INFERIOR DO RADIADOR</p> <p>FORD ESCORT III 1.6 (1980 A 1986) - ESCORT IV 1.6 (1986 A 1990) - ESCORT V 1.6 (1990 A 1992) - ORION I 1.6 (1983 A 1986) - ORION II 1.4 - 1.6 (1985 A 1990) - ORION III 1.4 - 1.6 (1990 A 1993)</p> <p>B305-d33/32mm B315-d32/33mm+ch760-d15mm+ch310-d1</p>		<p><b>R221330</b> NO. 6609334 - 6965910</p> <p>TUBO SUPERIOR DO RADIADOR</p> <p>FORD ESCORT 86 Express (AVF) 1.8 D (De 07.1988 Até 07.1990) 44kW 60cv 1753cm3 Caixa - FORD ESCORT 91 Express (AVF) 1.8 D (De 07.1990 Até 12.1994) 44kW 60cv 1753cm3 Caixa - FORD ESCORT 95 Caixa (AVL) 1.8 D (De 01.1995 Até 08.2000) 44kW 60cv 1753cm3 Caixa - FORD ESCORT IV (GAF, AWF, ABFT) 1.8 D (De 01.1989 Até 07.1990) 44kW 60cv 1753cm3 Hatchback - FORD ESCORT IV Turnier (AWF, AVF) 1.8 D (De 01.1989...</p> <p>B410-30/33mm 46x210x95x57mm ch/r-d28x20mm</p>
	<p><b>R221332</b> NO. 6187284 - 6965912</p> <p>TUBO SUPERIOR DO RADIADOR</p> <p>FORD ESCORT V (AAL, ABL) 1.8 TD (De 1993.02 Até 1995.01) 66kW 90cv 1753cm3 Hatchback - FORD ESCORT V Turnier (ANL) 1.8 TD (De 1993.02 Até 1995.01) 66kW 90cv 1753cm3 Combi - FORD ESCORT V três volumes (AFL) 1.8 TD (De 1993.08 Até 1995.01) 66kW 90cv 1753cm3 três volumes -</p> <p>B385-30/31mm 59-129-131-53mm</p>		<p><b>R221332</b> NO. 6187284 - 6965912</p> <p>TUBO SUPERIOR DO RADIADOR</p> <p>FORD ESCORT VI (GAL, AAL, ABL) 1.8 Turbo D (De 1995.12 Até 1998.10) 51kW 70cv 1753cm3 Hatchback - FORD ESCORT VI (GAL, AAL, ABL) 1.8 TD (De 1995.01 Até 1998.10) 66kW 90cv 1753cm3 Hatchback - FORD ESCORT VI três volumes (GAL, AFL) 1.8 Turbo D (De 1995.12 Até 1999.02) 51kW 70cv 1753cm3 três volumes - FORD ESCORT VI três volumes (GAL, AFL) 1.8 TD (De 1995.01 Até 1999.02) 66kW 90cv...</p> <p>B385-30/31mm 59-129-131-53mm</p>
	<p><b>R221332</b> NO. 6187284 - 6965912</p> <p>TUBO SUPERIOR DO RADIADOR</p> <p>FORD ORION III (GAL) 1.8 TD (De 1992.03 Até 1993.12) 66kW 90cv 1753cm3 três volumes -</p> <p>B385-30/31mm 59-129-131-53mm</p>		<p><b>R221333</b> NO. 50-88-86-158-66mm ch-d28mm 61-44-4</p> <p>TUBO INFERIOR DO RADIADOR</p> <p>FORD ESCORT V (AAL, ABL) 1.8 TD (De 1993.02 Até 1995.01) 66kW 90cv 1753cm3 Hatchback - FORD ESCORT V Turnier (ANL) 1.8 TD (De 1993.02 Até 1995.01) 66kW 90cv 1753cm3 Combi - FORD ESCORT V três volumes (AFL) 1.8 TD (De 1993.08 Até 1995.01) 66kW 90cv 1753cm3 três volumes -</p> <p>B310-31/31mm 50-88-86-158-66mm ch-d28mm 61-44-492-29mm...</p>
	<p><b>R221333</b> NO. 50-88-86-158-66mm ch-d28mm 61-44-4</p> <p>TUBO INFERIOR DO RADIADOR</p> <p>FORD ESCORT VI (GAL, AAL, ABL) 1.8 TD (De 1995.01 Até 1998.10) 66kW 90cv 1753cm3 Hatchback - FORD ESCORT VI três volumes (GAL, AFL) 1.8 TD (De 1995.01 Até 1999.02) 66kW 90cv 1753cm3 três volumes - FORD ESCORT VI Turnier (GAL, ANL) 1.8 TD (De 1995.01 Até 1999.02) 66kW 90cv 1753cm3 Combi - FORD ESCORT VI Cabriolet (ALL) 1.8 TD (De 1995.09 Até 1998.08) 66kW 90cv 1753cm3 Cabriolet...</p> <p>B310-31/31mm 50-88-86-158-66mm ch-d28mm 61-44-49</p>		<p><b>R221339</b> NO. 7021510 - 91AB8286AA - 93AB8B273AA</p> <p>TUBO INFERIOR DO RADIADOR</p> <p>FORD ESCORT I (AFH, ATH) 1300 (06.68 A 06.71) 48cv 1298cc três volumes - FORD ESCORT I (AFH, ATH) 1300 (06.68 A 06.71) 52cv 1298cc três volumes - FORD ESCORT I (AFH, ATH) 1300 (09.73 A 02.76) 54cv 1298cc três volumes - FORD ESCORT I (AFH, ATH) 1300 (06.70 A 02.76) 57cv 1298cc três volumes - FORD ESCORT I (AFH, ATH) 1300 (06.70 A 02.76) 72cv 1298cc três volumes - FORD ESCORT I Turnier (ADH) 1...</p> <p>B330-33/30mm 77-160-130-55mm</p>

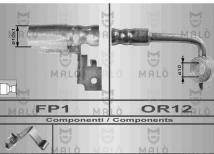
	<p><b>R221339</b> NO. 7021510 - 91AB8286AA - 93AB8B273AA</p> <p>TUBO INFERIOR DO RADIADOR</p> <p>FORD ESCORT II (ATH) 1.3 (12.74 A 08.80) 54cv 1298cc três volumes - FORD ESCORT II (ATH) 1.3 (12.74 A 08.80) 57cv 1298cc três volumes - FORD ESCORT II (ATH) 1.3 (03.79 A 08.80) 60cv 1298cc três volumes - FORD ESCORT II (ATH) 1.3 (12.74 A 08.80) 70cv 1298cc três volumes - FORD ESCORT II Turnier 1.3 (CADR) (04.75 A 01.79) 54cv 1298cc Combi - FORD ESCORT II Turnier 1.3 (04.75 A 08.80) 57cv 1298cc...</p> <p>B330-33/30mm 77-160-130-55mm</p>		<p><b>R221339</b> NO. 7021510 - 91AB8286AA - 93AB8B273AA</p> <p>TUBO INFERIOR DO RADIADOR</p> <p>FORD ESCORT III (GAA) 1.3 (09.80 A 12.85) 69cv 1296cc Hatchback - FORD ESCORT III Turnier (AWA) 1.3 (03.81 A 12.85) 69cv 1296cc Combi - FORD ESCORT III Cabriolet (ALD) 1.3 (09.83 A 12.85) 69cv 1296cc Cabriolet</p> <p>B330-33/30mm 77-160-130-55mm</p>
	<p><b>R221339</b> NO. 7021510 - 91AB8286AA - 93AB8B273AA</p> <p>TUBO INFERIOR DO RADIADOR</p> <p>FORD ESCORT IV (GAF, AWF, ABFT) 1.3 (01.86 A 07.90) 60cv 1297cc Hatchback - FORD ESCORT IV Turnier (AWF, AVF) 1.3 (01.86 A 07.90) 60cv 1297cc Combi</p> <p>B330-33/30mm 77-160-130-55mm</p>		<p><b>R221339</b> NO. 7021510 - 91AB8286AA - 93AB8B273AA</p> <p>TUBO INFERIOR DO RADIADOR</p> <p>FORD ESCORT V (GAL) 1.3 (07.90 A 09.92) 60cv 1299cc Hatchback - FORD ESCORT V Turnier (GAL, AVL) 1.3 (09.91 A 09.92) 60cv 1299cc Combi</p> <p>B330-33/30mm 77-160-130-55mm</p>
	<p><b>R221339</b> NO. 7021510 - 91AB8286AA - 93AB8B273AA</p> <p>TUBO INFERIOR DO RADIADOR</p> <p>FORD ESCORT VI (GAL) 1.3 (09.92 A 01.95) 60cv 1299cc Hatchback - FORD ESCORT VI três volumes (GAL) 1.3 (08.93 A 01.95) 60cv 1299cc três volumes - FORD ESCORT VI Turnier (GAL) 1.3 (09.92 A 01.95) 60cv 1299cc Combi - FORD ESCORT VII (GAL, AAL, ABL) 1.3 (01.95 A 10.98) 60cv 1299cc Hatchback</p> <p>B330-33/30mm 77-160-130-55mm</p>		<p><b>R221339</b> NO. 7021510 - 91AB8286AA - 93AB8B273AA</p> <p>TUBO INFERIOR DO RADIADOR</p> <p>FORD ESCORT VII (GAL, AAL, ABL) 1.8 Turbo D (12.95 A 10.98) 70cv 1753cc Hatchback - FORD ESCORT VII três volumes (GAL, AFL) 1.8 Turbo D (12.95 A 02.99) 70cv 1753cc três volumes - FORD ESCORT VII Turnier (GAL, ANL) 1.3 (01.95 A 01.99) 60cv 1299cc Combi - FORD ESCORT VII Turnier (GAL, ANL) 1.8 Turbo D (12.95 A 02.99) 70cv 1753cc Combi - FORD ESCORT VII Cabriolet (ALL) 1.8 Turbo D (10.96 A 08.99...</p> <p>B330-33/30mm 77-160-130-55mm</p>
	<p><b>R221339</b> NO. 7021510 - 91AB8286AA - 93AB8B273AA</p> <p>TUBO INFERIOR DO RADIADOR</p> <p>FORD FIESTA Caixa (J5_, J3_) 1.3 (02.96 A 08.03) 60cv 1299cc Caixa</p> <p>B330-33/30mm 77-160-130-55mm</p>		<p><b>R221339</b> NO. 7021510 - 91AB8286AA - 93AB8B273AA</p> <p>TUBO INFERIOR DO RADIADOR</p> <p>FORD ESCORT 81 Express (AVA) 1.3 (03.81 A 02.86) 69cv 1296cc Caixa</p> <p>B330-33/30mm 77-160-130-55mm</p>
	<p><b>R221339</b> NO. 7021510 - 91AB8286AA - 93AB8B273AA</p> <p>TUBO INFERIOR DO RADIADOR</p> <p>FORD ESCORT 86 Express (AVF) 1.3 (02.86 A 07.90) 60cv 1297cc Caixa</p> <p>B330-33/30mm 77-160-130-55mm</p>		<p><b>R221339</b> NO. 7021510 - 91AB8286AA - 93AB8B273AA</p> <p>TUBO INFERIOR DO RADIADOR</p> <p>FORD ESCORT 95 Caixa (AVL) 1.8 Turbo D (12.95 A 06.01) 70cv 1753cc Caixa</p> <p>B330-33/30mm 77-160-130-55mm</p>
	<p><b>R221341</b> NO. 85x157x121x98x62x59mm ch-d32x65x37</p> <p>TUBO INFERIOR DO RADIADOR</p> <p>FORD ESCORT V (AAL, ABL) 1.8 16V XR3i (De 1992.02 Até 1995.01) 77kW 105cv 1796cm3 Hatchback - FORD ESCORT V (AAL, ABL) 1.8 16V XR3i (De 1992.02 Até 1995.01) 96kW 130cv 1796cm3 Hatchback - FORD ESCORT V Cabriolet (ALL) 1.8 16V XR3i (De 1992.02 Até 1995.01) 77kW 105cv 1796cm3 Cabriolet - FORD ESCORT V Cabriolet (ALL) 1.8 16V XR3i (De 1992.02 Até 1995.01) 96kW 130cv 1796cm3 Cabr...</p> <p>B385-32/44mm 85x157x121x98x62x59mm ch-d32x65x37</p>		<p><b>R225016</b> NO. 1039359 - 1044342 - 1044344 - 1093550 - 96AB8B274AC - 96AB8B274HB - 96AB8B274HC - 96AB8B274HD</p> <p>TUBO SUPERIOR DO RADIADOR</p> <p>FORD ESCORT VI (GAL, AAL, ABL) 1.8 TD (De 01.1995 Até 10.1998) 66kW 90cv 1753cm3 Hatchback - FORD ESCORT VI (GAL, AAL, ABL) 1.8 Turbo D (De 12.1995 Até 10.1998) 51kW 70cv 1753cm3 Hatchback - FORD ESCORT VI Cabriolet (ALL) 1.8 TD (De 09.1995 Até 08.1998) 66kW 90cv 1753cm3 Cabriolet - FORD ESCORT VI Cabriolet (ALL) 1.8 Turbo D (De 10.1996 Até 08.1999) 51kW 70cv 1753cm3 Cabriolet - FORD ESCORT VI Cai...</p> <p>boca a boca 430 mm d1 31mmd2 32mm</p>
	<p><b>R227046</b> NO. 1604697 - 3396913 - 6047976 - 6051492 - 6079523 - 6115575 - 6126535 - 6136057 - 6136782</p> <p>TUBO SUPERIOR DO RADIADOR</p> <p>FORD ESCORT III (GAA) 1.3 09.1980/12.1985 51KW 69CV 1296CC JPA 0928538 7528308 - FORD ESCORT III (GAA) 1.6 09.1980/12.1985 58KW 79CV 1597CC LPA LP1 0928539 7528309 - FORD ESCORT III (GAA) 1.6 09.1980/10.1982 71KW 97CV 1597CC LUA 0928540 - FORD ESCORT III (GAA) 1.6 D 02.1984/12.1985 40KW 54CV 1608CC LTA 0928587 7528316 - FORD ESCORT III Cabriolet (ALD) 1.3 09.1983/12.1985 51KW 69CV 1296CC JPA 09285...</p> <p>B175-d30/d31mm 74-42-62mm</p>		<p><b>R227046</b> NO. 1604697 - 3396913 - 6047976 - 6051492 - 6079523 - 6115575 - 6126535 - 6136057 - 6136782</p> <p>TUBO SUPERIOR DO RADIADOR</p> <p>FORD ESCORT IV (GAF, AWF, ABFT) 1.6 D 01.1986/01.1989 40KW 54CV 1608CC LTC 0928622 7528325 - FORD ESCORT IV Express (AVF) 1.6 D 02.1986/07.1990 40KW 54CV 1608CC LTA LTC 2028187 - FORD ESCORT IV Turnier (AWF, AVF) 1.6 D 01.1986/01.1989 40KW 54CV 1608CC LTC 0928632</p> <p>B175-d30/d31mm 74-42-62mm</p>
	<p><b>R227046</b> NO. 1604697 - 3396913 - 6047976 - 6051492 - 6079523 - 6115575 - 6126535 - 6136057 - 6136782</p> <p>TUBO SUPERIOR DO RADIADOR</p> <p>FORD ESCORT V Express (AVF) 1.4 07.1990/12.1994 52KW 71CV 1391CC F6G F6F 2028193</p> <p>B175-d30/d31mm 74-42-62mm</p>		<p><b>R2473</b> NO.</p> <p>TUBO DA CHAUFAGE</p> <p>FORD ESCORT 1100 APÓS 1980</p> <p>B410-d19/19mm 200-125-160mm</p>

	<p><b>R8070</b> NO. 1015693 - 6557103 - 7405635 - 91AB.8260.FC - 91AB.8260.FG - 93AB.8B274.EB - 93AB.8B274.EC</p> <p><b>TUBO SUPERIOR DO RADIADOR</b></p> <p>FORD ESCORT IV (GAF, AWF, ABFT) 1.4 01.1986/07.1990 54KW 73CV 1392CC FUC F6D F6B 0928645 7528335 - FORD ESCORT IV (GAF, AWF, ABFT) 1.4 01.1986/07.1990 55KW 75CV 1392CC FUA 0928621 7528324 - FORD ESCORT IV Cabriolet (ALF) 1.4 01.1986/07.1990 55KW 75CV 1392CC FUA 0928634 - FORD ESCORT IV Cabriolet (ALF) 1.4 02.1987/07.1990 54KW 73CV 1392CC FUC F6D F6B 0928641 - FORD ESCORT IV Express (AVF) 1.4 i 02...</p> <p>B330-d32/32mm 1r-d22mm 75-90-155-55mm</p>	<p><b>R8070</b> NO. 1015693 - 6557103 - 7405635 - 91AB.8260.FC - 91AB.8260.FG - 93AB.8B274.EB - 93AB.8B274.EC</p> <p><b>TUBO SUPERIOR DO RADIADOR</b></p> <p>FORD ORION II (AFF) 1.4 12.1985/07.1990 55KW 75CV 1392CC FUA 0928626 7528329 - FORD ORION III (GAL) 1.4 07.1990/12.1993 52KW 71CV 1391CC F6F F6G 0928771 7528358 - FORD ORION III (GAL) 1.4 07.1990/12.1993 54KW 73CV 1392CC FUH - FORD ORION III (GAL) 1.6 07.1990/12.1992 66KW 90CV 1598CC LUK LUJ - FORD ORION III (GAL) 1.6 i 07.1990/09.1992 77KW 105CV 1598CC LUF 0928773 7528360 - FORD ORION III (GAL) 1...</p> <p>B330-d32/32mm 1r-d22mm 75-90-155-55mm</p>
	<p><b>R8071</b> NO. 2000018 - 6595567 - 6609706 - 6728929 - 6789090 - 7405637 - 7405638 - 92AB8260AG - 93AB.8B27...</p> <p><b>TUBO SUPERIOR DO RADIADOR</b></p> <p>FORD ESCORT CLASSIC (AAL, ABL) 1.6 16V 10.1998/07.2000 66KW 90CV 1597CC L1E L1K 8566325 8566313 - FORD ESCORT CLASSIC Turnier (ANL) 1.6 16V 02.1999/07.2000 66KW 90CV 1597CC L1E L1K 8566331 - FORD ESCORT V (AAL, ABL) 1.6 i 16V 09.1992/01.1995 66KW 90CV 1597CC L1E 2028343 7528378 0928824 - FORD ESCORT V (AAL, ABL) 1.6 i 16V 01.1994/01.1995 65KW 88CV 1597CC L1H 2028363 7528392 0928865 - FORD ESCORT V...</p> <p>B380-d31/31mm 1r-d22mm 100-245-95mm</p>	<p><b>R8071</b> NO. 2000018 - 6595567 - 6609706 - 6728929 - 6789090 - 7405637 - 7405638 - 92AB8260AG - 93AB.8B274.FB</p> <p><b>TUBO SUPERIOR DO RADIADOR</b></p> <p>FORD ORION III (GAL) 1.6 07.1990/12.1992 66KW 90CV 1598CC LUK LUJ - FORD ORION III (GAL) 1.6 i 07.1990/09.1992 77KW 105CV 1598CC LUF 0928773 7528360 - FORD ORION III (GAL) 1.6 i 16V 07.1992/12.1993 66KW 90CV 1597CC L1E 2028344 7528379 0928825 - FORD ORION III (GAL) 1.8 i 16V 01.1992/12.1993 96KW 130CV 1796CC RQB 0928812 7528377 - FORD ORION III (GAL) 1.8 i 16V 02.1992/12.1993 77KW 105CV 1796CC RDA...</p> <p>B380-d31/31mm 1r-d22mm 100-245-95mm</p>
	<p><b>R8140</b> NO. 6170465</p> <p><b>TUBO LIGAÇÃO CARBURADOR</b></p> <p>FORD ESCORT III (GAA) 1.3 09.1980/12.1985 51KW 69CV 1296CC JPA 0928538 7528308 - FORD ESCORT III (GAA) 1.6 09.1980/12.1985 58KW 79CV 1597CC LPA LP1 0928539 7528309</p> <p>B165-15/15mm 100-90-60mm</p>	<p><b>R8140</b> NO. 6170465</p> <p><b>TUBO LIGAÇÃO CARBURADOR</b></p> <p>FORD ESCORT IV (GAF, AWF, ABFT) 1.4 01.1986/07.1990 54KW 73CV 1392CC FUC F6D F6B 0928645 7528335 - FORD ESCORT IV (GAF, AWF, ABFT) 1.4 01.1986/07.1990 55KW 75CV 1392CC FUA 0928621 7528324 - FORD ESCORT IV (GAF, AWF, ABFT) 1.6 04.1989/07.1990 65KW 88CV 1598CC LUG 0928722 0928723</p> <p>B165-15/15mm 100-90-60mm</p>
	<p><b>R8140</b> NO. 6170465</p> <p><b>TUBO LIGAÇÃO CARBURADOR</b></p> <p>FORD ORION I (AFD) 1.3 07.1983/03.1986 51KW 69CV 1296CC JPA 0928576 - FORD ORION I (AFD) 1.6 07.1983/03.1986 58KW 79CV 1597CC LP1 LPA 0928577</p> <p>B165-15/15mm 100-90-60mm</p>	<p><b>R8140</b> NO. 6170465</p> <p><b>TUBO LIGAÇÃO CARBURADOR</b></p> <p>FORD ORION II (AFF) 1.4 12.1985/07.1990 55KW 75CV 1392CC FUA 0928626 7528329 - FORD ORION II (AFF) 1.4 01.1986/07.1990 54KW 73CV 1392CC FUC 0928647 7528336 - FORD ORION II (AFF) 1.4 03.1986/07.1990 52KW 72CV 1392CC FUAA 0928779 - FORD ORION II (AFF) 1.6 12.1985/07.1990 66KW 90CV 1597CC LUC 0928628 7528331</p> <p>B165-15/15mm 100-90-60mm</p>
	<p><b>RF80124</b> NO. 6180946</p> <p><b>TUBO DE FERRO REFRIGERAÇÃO</b></p> <p>FORD ESCORT IV (GAF - AWF - ABFT) 1.8 D (De 01-1989 Até 07-1990) 44kW 60CV 1753cc Hatchback FORD ESCORT IV Turnier (AWF - AVF) 1.8 D (De 01-1989 Até 07-1990) 44kW 60CV 1753cc Combi FORD ESCORT V (GAL) 1.8 D (De 07-1990 Até 12-1992) 44kW 60CV 1753cc Hatchback FORD ESCORT V Turnier (GAL - AVL) 1.8 D (De 07-1990 Até 12-1992) 44kW 60CV 1753cc Combi FORD ESCORT VI (GAL) 1.8 D (De 09-1992 Até 01-199...</p> <p>B76-28/28mm ch-d12-62mm 2f-d8mm</p>	<p><b>RT08578</b> NO. 7111983 - 92AB2078CC</p> <p><b>TUBO DE TRAVÃO FRENTE RH</b></p> <p>FORD ESCORT 1.6 16V(MOD 90) (-SW) (11-1994 A 12-1994) - TT (MOD 90) (-1.6 16V) (-TT-SW) (09-1990 A 1992) - TT SW (MOD 90) (09-1990 A12-1994)</p> <p>450mm FP1 - OR12</p>
	<p><b>RT08578</b> NO. 7111983 - 92AB2078CC</p> <p><b>TUBO DE TRAVÃO FRENTE RH</b></p> <p>FORD ORION TT (08-1990 A 03-1993)</p> <p>450mm FP1 - OR12</p>	<p><b>RT08580</b> NO. 1666294 - 6667473 - 91AB2282AD</p> <p><b>TUBO DE TRAVÃO TRÁS LH-RH</b></p> <p>FORD ESCORT 1.1 (12-1974 A 02-1986) - 1.3 (03-1981 A 02-1999) - 1.4 (01-1986 A 02-1999) - 1.4i (02-1986 A 07-1990) - 1.6 (05-1983 A 12-1992) - 1.6 16V (01-1995 A 02-1999) - 1.6 16V X R3i (12-1992 A 01-1995) - 1.8D (07-1998 A 02-1999) - 1.8TD (02-1993 A 06</p> <p>490mm MC11 - MC22</p>
	<p><b>RT08580</b> NO. 1666294 - 6667473 - 91AB2282AD</p> <p><b>TUBO DE TRAVÃO TRÁS LH-RH</b></p> <p>FORD ORION 1.3 (07-1983 A 03-1986)</p> <p>490mm MC11 - MC22</p>	<p><b>RT08582</b> NO. 1041775 - 1075807</p> <p><b>TUBO DE TRAVÃO FRENTE LH</b></p> <p>FORD ESCORT TT ESCORT VI (1992 A 1995)</p> <p>405999 FP2 - OR11</p>
	<p><b>RT08582</b> NO. 1041775 - 1075807</p> <p><b>TUBO DE TRAVÃO FRENTE LH</b></p> <p>FORD ESCORT TT ESCORT VII(1995 A 1999)</p> <p>405999 FP2 - OR11</p>	<p><b>RT08583</b> NO. 1041774 - 1075806</p> <p><b>TUBO DE TRAVÃO FRENTE RH</b></p> <p>FORD ESCORT VI (1992 A 1995) TT</p> <p>405mm FP1 - OR12</p>

	<p><b>RT08583</b> NO. 1041774 - 1075806</p> <p>TUBO DE TRAVÃO FRENTE RH</p> <p>FORD ESCORT VII (1995 A 1999)</p> <p>405mm FP1 - OR12</p>		<p><b>RT08584</b> NO. 1013455 - 7397508 - 95AB2282DB</p> <p>TUBO DE TRAVÃO FRENTE LH-RH</p> <p>FORD ESCORT V XR3i RS 2000(MOD.VII) (01-1995 A 09-1998)</p> <p>440mm MC11 - MC42</p>
	<p><b>RT08585</b> NO. 7402895</p> <p>TUBO DE TRAVÃO TRÁS LH-RH</p> <p>FORD ESCORT TT ESCORT VI (1992 A 1995) (EXCEPTO SW E VAN)</p> <p>335mm MC11 - MC42</p>		<p><b>RT08585</b> NO. 7402895</p> <p>TUBO DE TRAVÃO TRÁS LH-RH</p> <p>FORD ESCORT TT ESCORT VII (1995 A 1999)</p> <p>335mm MC11 - MC42</p>
	<p><b>RT08587</b> NO. 6508658 - 6639159 - 91AB2282BA</p> <p>TUBO DE TRAVÃO TRÁS LH-RH</p> <p>FORD ESCORT V TT (MOD.90) (09-1990 A 11-1990)</p> <p>450mm MC11 - MC22</p>		<p><b>RT08600</b> NO. 1638393 - 1666247 - 1666460 - 6125634</p> <p>TUBO DE TRAVÃO TRÁS LH-RH</p> <p>FORD ESCORT V TT SW (MOD.90) (12-1990 A 09-1991)</p> <p>355mm MC11 - MC40</p>
	<p><b>RT08689</b> NO. 1664958 - 6599243 - 6714709 - 91AB2282CB - D91AB2282CB</p> <p>TUBO DE TRAVÃO TRÁS LH-RH</p> <p>FORD ESCORT V III TT (APÓS 01-1995)</p> <p>435mm MC40 - MC40</p>		<p><b>RT08922</b> NO. 1011293</p> <p>TUBO DE TRAVÃO TRÁS LH-RH</p> <p>FORD ESCORT V-VI (90-92) - ESCORT VI (92-95) - ESCORT VII (APÓS 95) TT APÓS 01-1995</p> <p>365mm MC11 - MC42</p>
	<p><b>S1096</b> NO. 6042743 - 77FB3432AB</p> <p>SILENT-BLOC - CASQUILHO DO BRAÇO DA SUSPENSÃO DA FRENTE</p> <p>FORD ESCORT I 1100 (06-1968 A 06-1971)</p> <p>d39x46mm d31mm 1f-d14mm</p>		<p><b>S1097</b> NO. 1619120 - 3240198 - 3246127 - 5021460 - 5021461 - 5021729 - 6042740 - 6087890 - 6090611 - 6114614 - ...</p> <p>SILENT-BLOC DO TIRANTE DO BRAÇO DA SUSPENSÃO DA FRENTE</p> <p>FORD ESCORT II 1.1 (ATÉ 1980) - ESCORT III 1.1 (1980 A 1985) - ESCORT IV 1.1 (1985 A 1990)</p> <p>d37x51mm d32mm 1f-d10mm</p>
	<p><b>S1109</b> NO. 1035929 - 6193085-86 - 91AB3A262AA</p> <p>SILENT-BLOC DO BRAÇO FRENTE</p> <p>FORD ESCORT 0.9 - 1.1 - 1.3 - 1.6 - ESCORT DIESEL 1.6 - 1.8 - ORION 1.3 - 1.4 - 1.6 - ORION DIESEL 1.6 - 1.8</p> <p>d61x46mm d54mm 1f-d12mm</p>		<p><b>S1110</b> NO. 1000445 - 1829508 - 6193885-86 - 89FB.3063.A1D - 89FB.3063.AD - 89FB3063ADB492A - T128417</p> <p>SILENT-BLOC DO BRAÇO FRENTE</p> <p>FORD ESCORT 0.9 - 1.1 - 1.3 - 1.6 - ESCORT DIESEL 1.6 - 1.8</p> <p>d46x46mm 1f-d12mm</p>
	<p><b>S1197</b> NO. 1656752 - 5021729 - 6122507 - 6129161 - 6144628 - 85GB.5493.AB - 85GB.5493.BA - 88GB.5493.AA - 88GB....</p> <p>SILENT-BLOC CENTRAL DO BRAÇO DA SUSPENSÃO DIANTEIRO</p> <p>FORD ESCORT V (AAL, ABL): RS 2000 05.1991/01.1995 110KW 150CV 1998CC - FORD ESCORT V (AAL, ABL): RS 2000 4x4 05.1991/01.1995 110KW 150CV 1998CC - FORD ESCORT V (AAL, ABL): RS Cosworth 4x4 10.1991/01.1995 162KW 220CV 1994CC</p> <p>d65x23mm c8mm d48mm 1f-d16mm</p>		<p><b>S1197</b> NO. 1656752 - 5021729 - 6122507 - 6129161 - 6144628 - 85GB.5493.AB - 85GB.5493.BA - 88GB.5493.AA - 88GB....</p> <p>SILENT-BLOC CENTRAL DO BRAÇO DA SUSPENSÃO DIANTEIRO</p> <p>FORD ESCORT VI (GAL, AAL, ABL): RS 2000 02.1995/02.1998 110KW 150CV 1998CC - FORD ESCORT VI (GAL, AAL, ABL): RS 2000 4x4 02.1995/10.1998 110KW 150CV 1998CC - FORD ESCORT VI (GAL, AAL, ABL): RS Cosworth 4x4 02.1995/10.1998 162KW 220CV 1994CC</p> <p>d65x23mm c8mm d48mm 1f-d16mm</p>
	<p><b>S1219</b> NO. 1619120 - 6087890 - 81AB3063AA - 81AB3063BB</p> <p>SILENT-BLOC DO BRAÇO DA SUSPENSÃO DA FRENTE</p> <p>FORD ESCORT III (GAA) 1.1 09.1980/08.1983 40KW 55CV 1117CC GMA GLB 0928536 7528307 - FORD ESCORT III (GAA) 1.1 09.1980/08.1983 43KW 59CV 1117CC GPA 0928537 0928542 - FORD ESCORT III (GAA) 1.1 08.1983/12.1985 37KW 50CV 1117CC GSE 0928580 7528310 - FORD ESCORT III (GAA) 1.3 09.1980/12.1985 51KW 69CV 1296CC JPA 0928538 7528308 - FORD ESCORT III (GAA) 1.6 09.1980/12.1985 58KW 79CV 1597CC LPA LP1 092...</p> <p>d38x48mm d32mm 1f-d15mm</p>		<p><b>S1259</b> NO. 6163419 - 6745350 - 91AB.5K653.BB</p> <p>SILENT-BLOC DA SUSPENSÃO DE TRÁS</p> <p>FORD ESCORT I (AFH, ATH) 1100 06.1968/06.1971 29KW 40CV 1098CC KL11 1005236 1005502 - FORD ESCORT I (AFH, ATH) 950 08.1968/08.1974 25KW 34CV 940CC 123 - FORD ESCORT V (AAL, ABL) 1.3 07.1990/01.1995 44KW 60CV 1299CC J4B J6A 0928768 7528355 - FORD ESCORT V (AAL, ABL) 1.4 07.1990/01.1995 52KW 71CV 1392CC F6G F6F 0928770 7528357 - FORD ESCORT V (AAL, ABL) 1.4 09.1990/12.1994 55KW 75CV 1392CC F4B FUH...</p> <p>d59x70mm d52mm 1f-d12mm</p>





	<b>S1263</b> NO. 1041979 - 97AG5K653AA SILENT-BLOC DA SUSPENSÃO DE TRÁS FORD ESCORT (I - II - III) 1.3 (1968 A 1985) - ESCORT (IV - V) 1.3 - 1.4 - 1.8D (1986 A 1992) - ESCORT (VI - VII) 1.3 - 1.4 - 1.8 - 1.8D - 1.8TD (1992 A 1999) d68x70mm d64mm 1f-d12mm		<b>S1267</b> NO. 84A05K896A SILENT-BLOC DO BRAÇO DA SUSPENSÃO FRENTE FORD ESCORT d45x45mm d38mm 1f-d12mm
	<b>S1477</b> NO. 1S65K653AA - 4377687 - 7215747 - 7371059 - 95AB5K653CA - 97AG5K653AA - AB5K653AC SILENT BLOC DO EIXO TRASEIRO FORD ESCORT IV 1.8D (1989 A 1990) - ESCORT V 1.8D (1990 A 1992) - ESCORT VI 1.6i 16V - 1.8D (1992 A 1995) - ESCORT VII 1.3 - 1.4 - 1.6i 16V - 1.6 16V 4X4 - 1.8 16V - 1.8D - 1.8TD - RS 2000 4X4 - RS COSWORTH 4X4 (1995 A 2000) d75x70mm d64mm 1f-d12mm		<b>T0003</b> NO. 0204460 - 204460 BATENTE DA BARRA ESTABILIZADORA FORD ESCORT 41x39x36mm 1f-d18mm
	<b>T0605-I</b> NO. 6532212 - 90BB.3025.AA - 97FU.3025.AA BATENTE DA SUSPENSÃO DA FRENTE FORD ESCORT 1.3 - 1.4 - 1.4i - 1.6 16V XR3i - 1.6 16V - 1.8 16V - 1.8D - 1.8TD (1968 A 2000) - FORD ORION 1.3 - 1.4 - 1.6 - 1.6i 16V - 1.8i 16V - 1.8D - 1.8TD (1983 A 1993) d50x69mm 1f-d22mm 1f-d18mm		<b>T1050</b> NO. 1128725 - 1145272 - 1E00-34-156 - 6076407 - 6185809 - 6543416 - 7102392 - 81AB5484BA - 94AB.548... BATENTE DO CENTRO DA BARRA ESTABILIZADORA FORD ESCORT (APÓS 1990) - ORION (APÓS 1991) 39x35x30mm 1f-d15mm
	<b>U7003</b> NO. 6577961 - 82AB.B46812.ABY CORDÃO DA PRATELEIRA DA BAGAGEIRA FORD ESCORT 3-5 PORTAS (APÓS 1995) d5x300mm		<b>UPCR5004</b> NO. 1454051 - 1567143 - 1678260 PORCA DA RODA CHAVE 19 M12X1,50X30MM ( BASE CONICA ) FORD ESCORT CLASSIC (AAL, ABL) 1.6 16V (10.1998 -07.2000) 66kw 90cv 1597cm3 Hatchback FORD ESCORT CLASSIC (AAL, ABL) 1.8 TD (10.1998 -07.2000) 66kw 90cv 1753cm3 Hatchback FORD ESCORT CLASSIC Turnier (ANL) 1.6 16V (02.1999 -07.2000) 66kw 90cv 1597cm3 Combi FORD ESCORT CLASSIC Turnier (ANL) 1.8 TD (02.1999 -07.2000) 66kw 90cv 1753cm3 Combi d26x32mm M12x1,5mm
	<b>UPCR5004</b> NO. 1454051 - 1567143 - 1678260 PORCA DA RODA CHAVE 19 M12X1,50X30MM ( BASE CONICA ) FORD ESCORT V (AAL, ABL) 1.3 (07.1990 -01.1995) 44kw 60cv 1299cm3 Hatchback FORD ESCORT V (AAL, ABL) 1.4 (07.1990 -01.1995) 52kw 71cv 1392cm3 Hatchback FORD ESCORT V (AAL, ABL) 1.4 (09.1990 -12.1994) 55kw 75cv 1392cm3 Hatchback FORD ESCORT V (AAL, ABL) 1.6 (07.1990 -08.1992) 66kw 90cv 1598cm3 Hatchback FORD ESCORT V (AAL, ABL) 1.6 (07.1990 -08.1992) 66kw 90cv 1598cm3 Hatchback FORD ESCORT V (AAL, ABL) 1.6 (07.1990 -08.1992) 77kw 105cv 1598cm3 Hatchback FORD ESCORT V (AAL,.... d26x32mm M12x1,5mm		<b>UPCR5004</b> NO. 1454051 - 1567143 - 1678260 PORCA DA RODA CHAVE 19 M12X1,50X30MM ( BASE CONICA ) FORD ESCORT V Cabriolet (ALL) 1.4 (07.1990 -04.1994) 52kw 71cv 1392cm3 Cabriolet FORD ESCORT V Cabriolet (ALL) 1.4 i (07.1993 -01.1995) 55kw 75cv 1392cm3 Cabriolet FORD ESCORT V Cabriolet (ALL) 1.6 (07.1990 -08.1993) 77kw 105cv 1598cm3 Cabriolet FORD ESCORT V Cabriolet (ALL) 1.6 16V XR3i (12.1992 -01.1995) 66kw 90cv 1597cm3 Cabriolet FORD ESCORT V Cabriolet (ALL) 1.6 i 16V (02.1994 -01.1995) 65kw ... d26x32mm M12x1,5mm
	<b>UPCR5004</b> NO. 1454051 - 1567143 - 1678260 PORCA DA RODA CHAVE 19 M12X1,50X30MM ( BASE CONICA ) FORD ESCORT V Express (AVF) 1.3 (07.1990 -12.1994) 46kw 63cv 1299cm3 Caixa/Combi FORD ESCORT V Express (AVF) 1.4 (07.1990 -12.1994) 52kw 71cv 1391cm3 Caixa/Combi FORD ESCORT V Express (AVF) 1.8 D (07.1990 -12.1994) 44kw 60cv 1753cm3 Caixa/Combi d26x32mm M12x1,5mm		<b>UPCR5004</b> NO. 1454051 - 1567143 - 1678260 PORCA DA RODA CHAVE 19 M12X1,50X30MM ( BASE CONICA ) FORD ESCORT V Turnier (ANL) 1.3 (09.1991 -01.1995) 44kw 60cv 1299cm3 Combi FORD ESCORT V Turnier (ANL) 1.4 (07.1990 -01.1995) 52kw 71cv 1392cm3 Combi FORD ESCORT V Turnier (ANL) 1.4 (01.1994 -01.1995) 55kw 75cv 1392cm3 Combi FORD ESCORT V Turnier (ANL) 1.6 (07.1990 -08.1992) 66kw 90cv 1598cm3 Combi FORD ESCORT V Turnier (ANL) 1.6 (07.1990 -08.1992) 66kw 90cv 1598cm3 Combi FORD ESCORT V Turnier (ANL) 1.6 (07.1990 -09.1992) 77kw 105cv 1598cm3 Combi FORD ESCORT V Turnier (A... d26x32mm M12x1,5mm
	<b>UPCR5004</b> NO. 1454051 - 1567143 - 1678260 PORCA DA RODA CHAVE 19 M12X1,50X30MM ( BASE CONICA ) FORD ESCORT V três volumes (AFL) 1.3 (08.1993 -01.1995) 44kw 60cv 1299cm3 três volumes FORD ESCORT V três volumes (AFL) 1.4 (08.1993 -04.1994) 52kw 71cv 1392cm3 três volumes FORD ESCORT V três volumes (AFL) 1.4 (08.1993 -01.1995) 55kw 75cv 1392cm3 três volumes FORD ESCORT V três volumes (AFL) 1.6 i 16V (01.1994 -01.1995) 65kw 88cv 1597cm3 três volumes FORD ESCORT V três volumes (AFL) 1.6 i 16V (08... d26x32mm M12x1,5mm		<b>UPCR5004</b> NO. 1454051 - 1567143 - 1678260 PORCA DA RODA CHAVE 19 M12X1,50X30MM ( BASE CONICA ) FORD ESCORT VI (GAL, AAL, ABL) 1.3 (01.1995 -10.1998) 44kw 60cv 1299cm3 Hatchback FORD ESCORT VI (GAL, AAL, ABL) 1.4 (01.1995 -10.1998) 55kw 75cv 1392cm3 Hatchback FORD ESCORT VI (GAL, AAL, ABL) 1.6 16V (01.1995 -10.1998) 66kw 90cv 1597cm3 Hatchback FORD ESCORT VI (GAL, AAL, ABL) 1.6 16V 4x4 (01.1995 -10.1998) 66kw 90cv 1597cm3 Hatchback FORD ESCORT VI (GAL, AAL, ABL) 1.6 i 16V (01.1995 -08.1995) ... d26x32mm M12x1,5mm
	<b>UPCR5004</b> NO. 1454051 - 1567143 - 1678260 PORCA DA RODA CHAVE 19 M12X1,50X30MM ( BASE CONICA ) FORD ESCORT VI Cabriolet (ALL) 1.4 (02.1995 -08.1998) 55kw 75cv 1392cm3 Cabriolet FORD ESCORT VI Cabriolet (ALL) 1.6 16V XR3i (02.1995 -12.1996) 65kw 88cv 1597cm3 Cabriolet FORD ESCORT VI Cabriolet (ALL) 1.6 16V XR3i (02.1995 -09.1999) 66kw 90cv 1597cm3 Cabriolet FORD ESCORT VI Cabriolet (ALL) 1.8 16V XR3i (02.1995 -08.1998) 77kw 105cv 1796cm3 Cabriolet FORD ESCORT VI Cabriolet (ALL) 1.8 16V XR3i ... d26x32mm M12x1,5mm		<b>UPCR5004</b> NO. 1454051 - 1567143 - 1678260 PORCA DA RODA CHAVE 19 M12X1,50X30MM ( BASE CONICA ) FORD ESCORT VI Caixa/Combi (AVL) 1.4 (01.1995 -08.2000) 54kw 73cv 1392cm3 Caixa/Combi FORD ESCORT VI Caixa/Combi (AVL) 1.8 D (01.1995 -08.2000) 44kw 60cv 1753cm3 Caixa/Combi FORD ESCORT VI Caixa/Combi (AVL) 1.8 Turbo D (12.1995 -06.2001) 51kw 70cv 1753cm3 Caixa/Combi d26x32mm M12x1,5mm









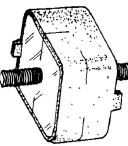

	<p><b>UPCR5004</b> NO. 1454051 - 1567143 - 1678260</p> <p>PORCA DA RODA CHAVE 19 M12X1,50X30MM ( BASE CONICA )</p> <p>FORD ESCORT VI Turnier (GAL, ANL) 1.3 (01.1995 -01.1999) 44kw 60cv 1299cm3 Combi FORD ESCORT VI Turnier (GAL, ANL) 1.4 (01.1995 -02.1999) 55kw 75cv 1392cm3 Combi FORD ESCORT VI Turnier (GAL, ANL) 1.6 16V (01.1995 -02.1999) 66kw 90cv 1597cm3 Combi FORD ESCORT VI Turnier (GAL, ANL) 1.6 i 16V (01.1995 -08.1995) 65kw 88cv 1597cm3 Combi FORD ESCORT VI Turnier (GAL, ANL) 1.8 16V (01.1995 -08.1995) 77kw ...</p> <p>d26x32mm M12x1,5mm</p>		<p><b>UPCR5004</b> NO. 1454051 - 1567143 - 1678260</p> <p>PORCA DA RODA CHAVE 19 M12X1,50X30MM ( BASE CONICA )</p> <p>FORD ESCORT VI três volumes (GAL, AFL) 1.3 (01.1995 -02.1999) 44kw 60cv 1299cm3 três volumes FORD ESCORT VI três volumes (GAL, AFL) 1.4 (01.1995 -02.1999) 55kw 75cv 1392cm3 três volumes FORD ESCORT VI três volumes (GAL, AFL) 1.6 i 16V (01.1995 -08.1995) 65kw 88cv 1597cm3 três volumes FORD ESCORT VI três volumes (GAL, AFL) 1.6 i 16V (01.1995 -02.1999) 66kw 90cv 1597cm3 três volumes FORD ESCORT VI t...</p> <p>d26x32mm M12x1,5mm</p>
	<p><b>UPCR5004</b> NO. 1454051 - 1567143 - 1678260</p> <p>PORCA DA RODA CHAVE 19 M12X1,50X30MM ( BASE CONICA )</p> <p>FORD ORION III (GAL) 1.3 (07.1990 -12.1993) 44kw 60cv 1299cm3 três volumes FORD ORION III (GAL) 1.4 (07.1990 -12.1993) 52kw 71cv 1391cm3 três volumes FORD ORION III (GAL) 1.4 (07.1990 -12.1993) 54kw 73cv 1392cm3 três volumes FORD ORION III (GAL) 1.6 (07.1990 -12.1992) 66kw 90cv 1598cm3 três volumes FORD ORION III (GAL) 1.6 i (07.1990 -09.1992) 77kw 105cv 1598cm3 três volumes FORD ORION III (GAL) 1...</p> <p>d26x32mm M12x1,5mm</p>		<p><b>UPCR5018</b> NO. 1007487 - 1447852 - 1470843</p> <p>PORCA DA RODA CHAVE 19 M12X1,50X16MM ( BASE CONICA PARA JANTE DE AÇO )</p> <p>FORD ESCORT V (AAL, ABL) 1.3 (07.1990 - 01.1995) 44kw 60cv 1299cm3 Hatchback FORD ESCORT V (AAL, ABL) 1.4 (07.1990 - 01.1995) 52kw 71cv 1392cm3 Hatchback FORD ESCORT V (AAL, ABL) 1.4 (09.1990 - 12.1994) 55kw 75cv 1392cm3 Hatchback FORD ESCORT V (AAL, ABL) 1.6 (07.1990 - 08.1992) 66kw 90cv 1598cm3 Hatchback FORD ESCORT V (AAL, ABL) 1.6 (07.1990 - 08.1993) 77kw 105cv 1598cm3 Hatchback FORD ESCORT V ...</p> <p>d19x15mm M12x15mm</p>
	<p><b>UPCR5018</b> NO. 1007487 - 1447852 - 1470843</p> <p>PORCA DA RODA CHAVE 19 M12X1,50X16MM ( BASE CONICA PARA JANTE DE AÇO )</p> <p>FORD ESCORT V Cabriolet (ALL) 1.4 (07.1990 - 04.1994) 52kw 71cv 1392cm3 Cabriolet FORD ESCORT V Cabriolet (ALL) 1.4 i (07.1993 - 01.1995) 55kw 75cv 1392cm3 Cabriolet FORD ESCORT V Cabriolet (ALL) 1.6 (07.1990 - 08.1993) 77kw 105cv 1598cm3 Cabriolet FORD ESCORT V Cabriolet (ALL) 1.6 16V XR3i (12.1992 - 01.1995) 66kw 90cv 1597cm3 Cabriolet FORD ESCORT V Cabriolet (ALL) 1.6 i 16V (02.1994 - 01.1995) ...</p> <p>d19x15mm M12x15mm</p>		<p><b>UPCR5018</b> NO. 1007487 - 1447852 - 1470843</p> <p>PORCA DA RODA CHAVE 19 M12X1,50X16MM ( BASE CONICA PARA JANTE DE AÇO )</p> <p>FORD ESCORT V Turnier (ANL) 1.3 (09.1991 - 01.1995) 44kw 60cv 1299cm3 Combi FORD ESCORT V Turnier (ANL) 1.4 (07.1990 - 01.1995) 52kw 71cv 1392cm3 Combi FORD ESCORT V Turnier (ANL) 1.4 (01.1994 - 01.1995) 55kw 75cv 1392cm3 Combi FORD ESCORT V Turnier (ANL) 1.6 (07.1990 - 08.1992) 66kw 90cv 1598cm3 Combi FORD ESCORT V Turnier (ANL) 1.6 (07.1990 - 09.1992) 77kw 105cv 1598cm3 Combi FORD ESCORT V Turni...</p> <p>d19x15mm M12x15mm</p>
	<p><b>UTR0630</b> NO. 6045648</p> <p>TAMPÃO RADIADOR</p> <p>FORD ORION I (AFD) 1.3 (De 1983.07 Até 1986.03) 51kW 69cv 1296cm3 três volumes - FORD ORION I (AFD) 1.6 (De 1983.07 Até 1986.03) 58kW 79cv 1597cm3 três volumes - FORD ORION I (AFD) 1.6 D (De 1984.02 Até 1986.03) 40kW 54cv 1608cm3 três volumes -</p> <p>d59/78x29mm d38x25mm</p>		<p><b>UTR0631</b> NO. 1508310 - 1613291 - 623086 - 78GB8100AC - ERS34</p> <p>TAMPÃO RADIADOR</p> <p>FORD ORION I (AFD) 1.3 (De 1983.07 Até 1986.03) 51kW 69cv 1296cm3 três volumes - FORD ORION I (AFD) 1.6 D (De 1984.02 Até 1986.03) 40kW 54cv 1608cm3 três volumes - FORD ORION II (AFF) 1.6 D (De 1985.12 Até 1989.01) 40kW 54cv 1608cm3 três volumes -</p> <p>d59/79x29mm d38x26mm</p>
	<p><b>UTR0800</b> NO. 1647750 - 1647751 - 1650630 - 1659287 - 1659288 - 6157002 - 6160686 - 6854060 - 6893213 - 7267962 - ...</p> <p>TAMPÃO RESERVATÓRIO LIQUIDO REFRIGERAÇÃO</p> <p>FORD ESCORT IV (GAF, AWF, ABFT) 1.1 (12.85 A 07.90) 50cv 1117cc Hatchback - FORD ESCORT IV (GAF, AWF, ABFT) 1.3 (01.86 A 07.90) 60cv 1297cc Hatchback - FORD ESCORT IV (GAF, AWF, ABFT) 1.3 (GAF) (07.88 A 10.90) 63cv 1297cc Hatchback - FORD ESCORT IV (GAF, AWF, ABFT) 1.4 (01.86 A 07.90) 73cv 1392cc Hatchback - FORD ESCORT IV (GAF, AWF, ABFT) 1.4 (01.86 A 07.90) 75cv 1392cc Hatchback - FORD ...</p> <p>d62x25mm 1f-d53x14mm</p>		<p><b>UTR0800</b> NO. 1647750 - 1647751 - 1650630 - 1659287 - 1659288 - 6157002 - 6160686 - 6854060 - 6893213 - 7267962 - ...</p> <p>TAMPÃO RESERVATÓRIO LIQUIDO REFRIGERAÇÃO</p> <p>FORD ESCORT V (GAL) 1.3 07.90 - 09.92 44 60 1299 Hatchback FORD ESCORT V (GAL) 1.4 07.90 - 09.92 52 71 1392 Hatchback FORD ESCORT V (GAL) 1.6 07.90 - 08.92 66 90 1598 Hatchback FORD ESCORT V (GAL) 1.6 07.90 - 12.92 77 105 1598 Hatchback FORD ESCORT V (GAL) 1.8 16V XR3i 02.92 - 12.92 77 105 1796 Hatchback FORD ESCORT V (GAL) 1.8 16V XR3i 02.92 - 12.92 96 130 1796 Hatchback FORD ESCORT V (GAL) RS 20...</p> <p>d62x25mm 1f-d53x14mm</p>
	<p><b>UTR0800</b> NO. 1647750 - 1647751 - 1650630 - 1659287 - 1659288 - 6157002 - 6160686 - 6854060 - 6893213 - 7267962 - ...</p> <p>TAMPÃO RESERVATÓRIO LIQUIDO REFRIGERAÇÃO</p> <p>FORD ESCORT VI (GAL) 1.3 09.92 - 01.95 44 60 1299 Hatchback FORD ESCORT VI (GAL) 1.4 09.92 - 01.95 52 71 1391 Hatchback FORD ESCORT VI (GAL) 1.4 01.94 - 01.95 55 75 1392 Hatchback FORD ESCORT VI (GAL) 1.6 i 16V 01.94 - 01.95 65 88 1597 Hatchback FORD ESCORT VI (GAL) 1.6 i 16V 09.92 - 01.95 66 90 1597 Hatchback FORD ESCORT VI (GAL) 1.8 i 16V 09.92 - 01.95 77 105 1796 Hatchback FORD ESCORT VI (GAL) ...</p> <p>d62x25mm 1f-d53x14mm</p>		<p><b>UTR0800</b> NO. 1647750 - 1647751 - 1650630 - 1659287 - 1659288 - 6157002 - 6160686 - 6854060 - 6893213 - 7267962 - ...</p> <p>TAMPÃO RESERVATÓRIO LIQUIDO REFRIGERAÇÃO</p> <p>FORD ESCORT VII (GAL, AAL, ABL) 1.3 01.95 - 10.98 44 60 1299 Hatchback FORD ESCORT VII (GAL, AAL, ABL) 1.4 01.95 - 12.99 54 73 1392 Hatchback FORD ESCORT VII (GAL, AAL, ABL) 1.4 01.95 - 10.98 55 75 1392 Hatchback FORD ESCORT VII (GAL, AAL, ABL) 1.6 i 16V 01.95 - 08.95 65 88 1597 Hatchback FORD ESCORT VII (GAL, AAL, ABL) 1.6 16V 01.95 - 10.98 66 90 1597 Hatchback FORD ESCORT VII (GAL, AAL, ABL) 1.6...</p> <p>d62x25mm 1f-d53x14mm</p>
	<p><b>UTR0800</b> NO. 1647750 - 1647751 - 1650630 - 1659287 - 1659288 - 6157002 - 6160686 - 6854060 - 6893213 - 7267962 - ...</p> <p>TAMPÃO RESERVATÓRIO LIQUIDO REFRIGERAÇÃO</p> <p>FORD ORION II (AFF) 1.3 (12.85 A 07.90) 60cv 1297cc três volumes - FORD ORION II (AFF) 1.4 (03.86 A 07.90) 72cv 1392cc três volumes - FORD ORION II (AFF) 1.4 (01.86 A 07.90) 73cv 1392cc três volumes - FORD ORION II (AFF) 1.4 (12.85 A 07.90) 75cv 1392cc três volumes - FORD ORION II (AFF) 1.6 (12.85 A 07.90) 90cv 1597cc três volumes - FORD ORION II (AFF) 1.6 i Cat (03.86 A 07.90) 90cv 15...</p> <p>d62x25mm 1f-d53x14mm</p>		<p><b>UTR0820</b> NO. 90352470 - 90409256 - 90409257 - 9041032690497472 - 90467473</p> <p>TAMPÃO RESERVATÓRIO LIQUIDO REFRIGERAÇÃO</p> <p>FORD ORION I (AFD) 1.6 D (02.84 A 03.86) 54cv 1608cc três volumes - FORD ORION II (AFF) 1.3 (12.85 A 07.90) 60cv 1297cc três volumes - FORD ORION II (AFF) 1.4 (03.86 A 07.90) 72cv 1392cc três volumes - FORD ORION II (AFF) 1.4 (01.86 A 07.90) 73cv 1392cc três volumes - FORD ORION II (AFF) 1.4 Cat (02.87 A 07.90) 73cv 1392cc três volumes - FORD ORION II (AFF) 1.4 (12.85 A 07.90) 75cv 1392cc...</p> <p>d62x23mm 1f-d53x12mm</p>
	<p><b>UTR0829</b> NO. 1647750 - 1650630 - 1659287 - 1659288 - 6157002 - 7267969</p> <p>TAMPÃO RESERVATÓRIO LIQUIDO REFRIGERAÇÃO</p> <p>FORD ORION II (AFF) 1.4 Ano fabric. a part ir de: 04.86 (03.86 A 07.90) 72cv 1392cc três volumes - FORD ORION II (AFF) 1.4 (01.86 A 07.90) 73cv 1392cc três volumes - FORD ORION II (AFF) 1.4 Cat Ano fabric. a part ir de: 03.87 (02.87 A 07.90) 73cv 1392cc três volumes - FORD ORION II (AFF) 1.4 Ano fabric. a part ir de: 01.86 (12.85 A 07.90) 75cv 1392cc três volumes</p> <p>d62x25mm 1f-d52x14mm</p>		<p><b>UTR0859</b> NO. 1650630 - 94539597 - 96293957 - 96312510 - 96351578 - 96420303 - 96536649</p> <p>TAMPÃO RESERVATÓRIO LIQUIDO REFRIGERAÇÃO</p> <p>FORD ORION II (AFF) 1.3 (12.85 A 07.90) 60cv 1297cc três volumes - FORD ORION II (AFF) 1.4 (03.86 A 07.90) 72cv 1392cc três volumes - FORD ORION II (AFF) 1.4 (01.86 A 07.90) 73cv 1392cc três volumes - FORD ORION II (AFF) 1.4 Cat (02.87 A 07.90) 73cv 1392cc três volumes - FORD ORION II (AFF) 1.4 (12.85 A 07.90) 75cv 1392cc três volumes - FORD ORION II (AFF) 1.6 (12.85 A 07.90) ...</p> <p>d63x23mm 1f-d53x11mm</p>

 	<p><b>UTR0878</b> NO. 1542591 - 1674083</p> <p>TAMPÃO RESERVATÓRIO LIQUIDO REFRIGERAÇÃO</p> <p>FORD ESCORT VI (GAL) 1.8 TD (De 02-1993 Até 01-1995) 66kW 90CV 1753cc Hatchback FORD ESCORT VI três volumes (GAL) 1.8 TD (De 08-1993 Até 01-1995) 66kW 90CV 1753cc três volumes FORD ESCORT VI Turnier (GAL) 1.8 TD (De 02-1993 Até 01-1995) 66kW 90CV 1753cc Combi</p> <p>d71x27mm d43x10mm 1p-d33x17mm</p>	 	<p><b>UTR0878</b> NO. 1542591 - 1674083</p> <p>TAMPÃO RESERVATÓRIO LIQUIDO REFRIGERAÇÃO</p> <p>FORD ESCORT VII (GAL - AAL - ABL) 1.8 Turbo D (De 12-1995 Até 10-1998) 51kW 70CV 1753cc Hatchback FORD ESCORT VII (GAL - AAL - ABL) 1.8 TD (De 01-1995 Até 10-1998) 66kW 90CV 1753cc Hatchback FORD ESCORT VII três volumes (GAL - AFL) 1.8 Turbo D (De 12-1995 Até 02-1999) 51kW 70CV 1753cc três volumes FORD ESCORT VII três volumes (GAL - AFL) 1.8 TD (De 01-1995 Até 02-1999) 66kW 90CV 1753cc três vol...</p> <p>d71x27mm d43x10mm 1p-d33x17mm</p>
 	<p><b>UTR0878</b> NO. 1542591 - 1674083</p> <p>TAMPÃO RESERVATÓRIO LIQUIDO REFRIGERAÇÃO</p> <p>FORD ESCORT CLASSIC (AAL - ABL) 1.8 TD (De 10-1998 Até 07-2000) 66kW 90CV 1753cc Hatchback FORD ESCORT CLASSIC Turnier (ANL) 1.8 TD (De 02-1999 Até 07-2000) 66kW 90CV 1753cc Combi</p> <p>d71x27mm d43x10mm 1p-d33x17mm</p>	 	<p><b>UTR0878</b> NO. 1542591 - 1674083</p> <p>TAMPÃO RESERVATÓRIO LIQUIDO REFRIGERAÇÃO</p> <p>FORD ORION III (GAL) 1.8 TD (De 03-1992 Até 12-1993) 66kW 90CV 1753cc três volumes</p> <p>d71x27mm d43x10mm 1p-d33x17mm</p>
 	<p><b>UTR0878</b> NO. 1674083- 1542591</p> <p>TAMPÃO RESERVATÓRIO LIQUIDO REFRIGERAÇÃO</p> <p>FORD ESCORT VI (GAL) 1.8 TD (De 02-1993 Até 01-1995) 66kW 90CV 1753cc Hatchback FORD ESCORT VI três volumes (GAL) 1.8 TD (De 08-1993 Até 01-1995) 66kW 90CV 1753cc três volumes FORD ESCORT VI Turnier (GAL) 1.8 TD (De 02-1993 Até 01-1995) 66kW 90CV 1753cc Combi</p> <p>d71x27mm d43x10mm 1p-d33x17mm</p>	 	<p><b>UTR0878</b> NO. 1674083- 1542591</p> <p>TAMPÃO RESERVATÓRIO LIQUIDO REFRIGERAÇÃO</p> <p>FORD ESCORT VII (GAL - AAL - ABL) 1.8 Turbo D (De 12-1995 Até 10-1998) 51kW 70CV 1753cc Hatchback FORD ESCORT VII (GAL - AAL - ABL) 1.8 TD (De 01-1995 Até 10-1998) 66kW 90CV 1753cc Hatchback FORD ESCORT VII três volumes (GAL - AFL) 1.8 Turbo D (De 12-1995 Até 02-1999) 51kW 70CV 1753cc três volumes FORD ESCORT VII três volumes (GAL - AFL) 1.8 TD (De 01-1995 Até 02-1999) 66kW 90CV 1753cc três vol...</p> <p>d71x27mm d43x10mm 1p-d33x17mm</p>
 	<p><b>UTR0878</b> NO. 1674083- 1542591</p> <p>TAMPÃO RESERVATÓRIO LIQUIDO REFRIGERAÇÃO</p> <p>FORD ESCORT CLASSIC (AAL - ABL) 1.8 TD (De 10-1998 Até 07-2000) 66kW 90CV 1753cc Hatchback FORD ESCORT CLASSIC Turnier (ANL) 1.8 TD (De 02-1999 Até 07-2000) 66kW 90CV 1753cc Combi</p> <p>d71x27mm d43x10mm 1p-d33x17mm</p>	 	<p><b>UTR0878</b> NO. 1674083- 1542591</p> <p>TAMPÃO RESERVATÓRIO LIQUIDO REFRIGERAÇÃO</p> <p>FORD ORION III (GAL) 1.8 TD (De 03-1992 Até 12-1993) 66kW 90CV 1753cc três volumes</p> <p>d71x27mm d43x10mm 1p-d33x17mm</p>
	<p><b>UTV83010</b> NO. 1013938 - 97JM6730BA</p> <p>TAMPÃO VEDAÇÃO BUJÃO</p> <p>FORD ESCORT VII (GAL - AAL - ABL) 1.3 (De 01-1995 Até 10-1998) 44kW 60CV 1299cc Hatchback FORD ESCORT VII (GAL - AAL - ABL) 1.6 16V (De 01-1995 Até 10-1998) 66kW 90CV 1597cc Hatchback FORD ESCORT VII (GAL - AAL - ABL) 1.6 16V 4x4 (De 01-1995 Até 10-1998) 66kW 90CV 1597cc Hatchback FORD ESCORT VII (GAL - AAL - ABL) 1.8 16V (De 01-1995 Até 10-1998) 85kW 115CV 1796cc Hatchback FORD ESCORT VII três vo...</p> <p>d28x35mm c19mm d13mm</p>		<p><b>UTV83012</b> NO. 1457117 - 1657022 - 1663906 - 6093527 - 6186775 - 6732529 - 70TM6730AA - 89FF6730AA</p> <p>TAMPÃO VEDAÇÃO BUJÃO</p> <p>FORD ESCORT I (AFH - ATH) 1100 (De 01-1968 Até 12-1974) 32kW 45CV 1098cc três volumes FORD ESCORT I (AFH - ATH) 1100 (De 06-1970 Até 02-1976) 35kW 48CV 1098cc três volumes FORD ESCORT I (AFH - ATH) 1300 (De 09-1973 Até 02-1976) 40kW 54CV 1298cc três volumes FORD ESCORT I (AFH - ATH) 1300 (De 06-1970 Até 02-1976) 42kW 57CV 1298cc três volumes FORD ESCORT I (AFH - ATH) 1300 (De 06-1970 Até 02-19...</p> <p>d23x26mm c15mm d13mm</p>
	<p><b>UTV83012</b> NO. 1457117 - 1657022 - 1663906 - 6093527 - 6186775 - 6732529 - 70TM6730AA - 89FF6730AA</p> <p>TAMPÃO VEDAÇÃO BUJÃO</p> <p>FORD ESCORT II (ATH) 1.1 (De 12-1974 Até 08-1980) 32kW 45CV 1098cc três volumes FORD ESCORT II (ATH) 1.1 (De 06-1975 Até 08-1980) 34kW 46CV 1098cc três volumes FORD ESCORT II (ATH) 1.1 (De 12-1974 Até 08-1980) 35kW 48CV 1098cc três volumes FORD ESCORT II (ATH) 1.3 (De 12-1974 Até 08-1980) 40kW 54CV 1298cc três volumes FORD ESCORT II (ATH) 1.3 (De 12-1974 Até 08-1980) 42kW 57CV 1298cc três volu...</p> <p>d23x26mm c15mm d13mm</p>		<p><b>UTV83012</b> NO. 1457117 - 1657022 - 1663906 - 6093527 - 6186775 - 6732529 - 70TM6730AA - 89FF6730AA</p> <p>TAMPÃO VEDAÇÃO BUJÃO</p> <p>FORD ESCORT III (GAA) 1.1 (De 08-1983 Até 12-1985) 37kW 50CV 1117cc Hatchback FORD ESCORT III (GAA) 1.1 (De 09-1980 Até 08-1983) 40kW 55CV 1117cc Hatchback FORD ESCORT III (GAA) 1.1 (De 09-1980 Até 08-1983) 43kW 59CV 1117cc Hatchback FORD ESCORT III (GAA) 1.3 (De 09-1980 Até 12-1985) 51kW 69CV 1296cc Hatchback FORD ESCORT III (GAA) 1.6 (De 09-1980 Até 12-1985) 58kW 79CV 1597cc Hatchback FORD ...</p> <p>d23x26mm c15mm d13mm</p>
	<p><b>UTV83012</b> NO. 1457117 - 1657022 - 1663906 - 6093527 - 6186775 - 6732529 - 70TM6730AA - 89FF6730AA</p> <p>TAMPÃO VEDAÇÃO BUJÃO</p> <p>FORD ESCORT IV (GAF - AWF - ABFT) 1.1 (De 12-1985 Até 07-1990) 37kW 50CV 1117cc Hatchback FORD ESCORT IV (GAF - AWF - ABFT) 1.3 (De 01-1986 Até 07-1990) 44kW 60CV 1297cc Hatchback FORD ESCORT IV (GAF - AWF - ABFT) 1.3 (GAF) (De 07-1988 Até 10-1990) 46kW 63CV 1297cc Hatchback FORD ESCORT IV (GAF - AWF - ABFT) 1.4 (De 01-1986 Até 07-1990) 54kW 73CV 1392cc Hatchback FORD ESCORT IV (GAF - ABFT) ...</p> <p>d23x26mm c15mm d13mm</p>		<p><b>UTV83012</b> NO. 1457117 - 1657022 - 1663906 - 6093527 - 6186775 - 6732529 - 70TM6730AA - 89FF6730AA</p> <p>TAMPÃO VEDAÇÃO BUJÃO</p> <p>FORD ESCORT V (GAL) 1.3 (De 07-1990 Até 09-1992) 44kW 60CV 1299cc Hatchback FORD ESCORT V (GAL) 1.4 (De 07-1990 Até 09-1992) 52kW 71CV 1392cc Hatchback FORD ESCORT V (GAL) 1.6 (De 07-1990 Até 08-1992) 66kW 90CV 1598cc Hatchback FORD ESCORT V (GAL) 1.6 (De 07-1990 Até 12-1992) 77kW 105CV 1598cc Hatchback FORD ESCORT V (GAL) RS 2000 (De 05-1991 Até 12-1992) 110kW 150CV 1998cc Hatchback FORD ESCORT V...</p> <p>d23x26mm c15mm d13mm</p>
	<p><b>UTV83012</b> NO. 1457117 - 1657022 - 1663906 - 6093527 - 6186775 - 6732529 - 70TM6730AA - 89FF6730AA</p> <p>TAMPÃO VEDAÇÃO BUJÃO</p> <p>FORD ESCORT VI (GAL) 1.4 (De 01-1994 Até 01-1995) 55kW 75CV 1392cc Hatchback FORD ESCORT VI (GAL) RS 2000 4x4 (De 08-1993 Até 01-1995) 110kW 150CV 1998cc Hatchback FORD ESCORT VI (GAL) RS Cosworth 4x4 (De 09-1992 Até 01-1995) 162kW 220CV 1994cc Hatchback FORD ESCORT VI (GAL) 1.8 TD (De 02-1993 Até 01-1995) 66kW 90CV 1753cc Hatchback FORD ESCORT VI três volumes (GAL) 1.3 (De 08-1993 Até 01-1995) 44...</p> <p>d23x26mm c15mm d13mm</p>		<p><b>UTV83012</b> NO. 1457117 - 1657022 - 1663906 - 6093527 - 6186775 - 6732529 - 70TM6730AA - 89FF6730AA</p> <p>TAMPÃO VEDAÇÃO BUJÃO</p> <p>FORD ESCORT VII (GAL - AAL - ABL) 1.3 (De 01-1995 Até 10-1998) 44kW 60CV 1299cc Hatchback FORD ESCORT VII (GAL - AAL - ABL) 1.4 (De 01-1995 Até 12-1999) 54kW 73CV 1392cc Hatchback FORD ESCORT VII (GAL - AAL - ABL) 1.4 (De 01-1995 Até 10-1998) 55kW 75CV 1392cc Hatchback FORD ESCORT VII (GAL - AAL - ABL) RS 2000 4x4 (De 02-1995 Até 10-1998) 110kW 150CV 1998cc Hatchback FORD ESCORT VII (GAL - AAL - A...</p> <p>d23x26mm c15mm d13mm</p>

	<p><b>UTV83012</b> NO. 1457117 - 1657022 - 1663906 - 6093527 - 6186775 - 6732529 - 70TM6730AA - 89FF6730AA</p> <p><b>TAMPÃO VEDAÇÃO BUJÃO</b></p> <p>FORD ORION II (AFF) 1.3 (De 12-1985 Até 07-1990) 44kW 60CV 1297cc três volumes FORD ORION II (AFF) 1.4 (De 01-1986 Até 07-1990) 54kW 73CV 1392cc três volumes FORD ORION II (AFF) 1.4 Cat (De 02-1987 Até 07-1990) 54kW 73CV 1392cc três volumes FORD ORION II (AFF) 1.4 (De 12-1985 Até 07-1990) 55kW 75CV 1392cc três volumes FORD ORION II (AFF) 1.6 (De 12-1985 Até 07-1990) 66kW 90CV 1597cc três volum...</p> <p>d23x26mm c15mm d13mm</p>		<p><b>UTV83012</b> NO. 1457117 - 1657022 - 1663906 - 6093527 - 6186775 - 6732529 - 70TM6730AA - 89FF6730AA</p> <p><b>TAMPÃO VEDAÇÃO BUJÃO</b></p> <p>FORD ORION III (GAL) 1.3 (De 07-1990 Até 12-1993) 44kW 60CV 1299cc três volumes FORD ORION III (GAL) 1.4 (De 07-1990 Até 12-1993) 52kW 71CV 1391cc três volumes FORD ORION III (GAL) 1.4 (De 07-1990 Até 12-1993) 54kW 73CV 1392cc três volumes FORD ORION III (GAL) 1.6 (De 07-1990 Até 12-1992) 66kW 90CV 1598cc três volumes FORD ORION III (GAL) 1.6 i (De 07-1990 Até 09-1992) 77kW 105CV 1598cc três v...</p> <p>d23x26mm c15mm d13mm</p>
	<p><b>W5025</b> NO. 1005817 - 1085938 - 96FF6B319AA</p> <p><b>POLIE DA CAMBOTA (5 pistas)</b></p> <p>FORD ESCORT VI (GAL, AAL, ABL) 1.8 TD 01.1995/10.1998 66KW 90CV 1753CC RFK RFD RFS 2028351, 8566328, 8566316, 7528381, 0928837 - FORD ESCORT VI três volumes (GAL, AFL) 1.8 TD 01.1995/02.1999 66KW 90CV 1753CC RFK RFD RFS 8566322 - FORD ESCORT VI três volumes (GAL, AFL) 1.8 Turbo D 12.1995/02.1999 51KW 70CV 1753CC RVA 2028370, 8566321, 7528397, 0928919</p> <p>d134.3mm d42mm</p>		<p><b>W5026</b> NO. 1038330 - 1135052 - 1250444 - 26105255 - 6599021 - 928M6B320DB - 928M6B320DD - 928M6B320DE - 928M6B320E</p> <p><b>POLIE CAMBOTA (6 PISTAS)</b></p> <p>FORD ESCORT V (AAL, ABL): 1.6 i 16V 01.1994/01.1995 65KW 88CV 1597CC - FORD ESCORT V (AAL, ABL): 1.6 i 16V 09.1992/01.1995 66KW 90CV 1597CC - FORD ESCORT V (AAL, ABL): 1.8 16V XR3i 02.1992/01.1995 77KW 105CV 1796CC - FORD ESCORT V (AAL, ABL): 1.8 XR3i 16V 4x4 08.1993/01.1995 77KW 105CV 1796CC - FORD ESCORT V (AAL, ABL): 1.8 16V XR3i 02.1992/01.1995 96KW 130CV 1796CC - FORD ESCORT V (AAL, ABL): 1.8...</p> <p>d131.3mm d28mm</p>
	<p><b>W5026</b> NO. 1038330 - 1135052 - 1250444 - 26105255 - 6599021 - 928M6B320DB - 928M6B320DD - 928M6B320DE - 928M6B320E</p> <p><b>POLIE CAMBOTA (6 PISTAS)</b></p> <p>FORD ORION III (GAL): 1.6 i 16V 07.1992/12.1993 66KW 90CV 1597CC - FORD ORION III (GAL): 1.8 i 16V 02.1992/12.1993 77KW 105CV 1796CC - FORD ORION III (GAL): 1.8 i 16V 01.1992/12.1993 96KW 130CV 1796CC</p> <p>d131.3mm d28mm</p>		<p><b>W5035</b> NO. 1135052</p> <p><b>POLIE DA CAMBOTA (6 PISTAS)</b></p> <p>FORD ORION III 1.6 (07-1990 A 12-1992) - 1.6i 16V - 1.8i 16V (1992 A 1993)</p> <p>d132mm d28mm</p>
	<p><b>W5036</b> NO. 6811202</p> <p><b>POLIE DA CAMBOTA (5 PISTAS)</b></p> <p>FORD ESCORT 1.8TD GT - GHIA - GLX - 16V 95D - TD - TDi</p> <p>d134mm d42mm</p>		<p><b>W5135</b> NO. 6186295</p> <p><b>POLIE DA CAMBOTA 3 PISTAS</b></p> <p>FORD ESCORT IV (GAF - AWF - ABFT) 1.8 D (01.89 A 07.90) 60cv 1753cc Hatchback - FORD ESCORT IV Combi (AWF - AVF) 1.8 D (01.89 A 07.90) 60cv 1753cc Combi</p> <p>d120/130mm d20,6mm</p>
	<p><b>Y3233</b> NO. 1473166 - 1481984 - 3395499 - 4432023 - 6586309 - 6789185</p> <p><b>PARAFUSO DA RODA CAVILHA M12X1,50X48MM</b></p> <p>FORD ESCORT V (AAL, ABL) 1.3 (07.1990 - 01.1995) 44kw 60cv 1299cm3 Hatchback FORD ESCORT V (AAL, ABL) 1.4 (07.1990 - 01.1995) 52kw 71cv 1392cm3 Hatchback FORD ESCORT V (AAL, ABL) 1.4 (09.1990 - 12.1994) 55kw 75cv 1392cm3 Hatchback FORD ESCORT V (AAL, ABL) 1.6 (07.1990 - 08.1992) 66kw 90cv 1598cm3 Hatchback FORD ESCORT V (AAL, ABL) 1.6 (07.1990 - 08.1993) 77kw 105cv 1598cm3 Hatchback FORD ESCORT V ...</p> <p>c48mm M12x1,5mm</p>		<p><b>Z55237</b> NO. 1104880</p> <p><b>MOLA DE FIXAÇÃO CAVA DE RODA</b></p> <p>FORD ESCORT</p> <p>F8mm T16mm S1-2mm H11mm L8mm S1mm Z23mm</p>
	<p><b>Z55254</b> NO. 1009164</p> <p><b>MOLA REBITE FIXAÇÃO</b></p> <p>FORD ESCORT</p> <p>d5.5x 16mm f-d11mm</p>		<p><b>Z80251</b> NO.</p> <p><b>Mola de friso</b></p> <p>FORD ESCORT</p> <p>18x17x14mm 1p-d6-5.5mm</p>
	<p><b>Z80598</b> NO. 6725950</p> <p><b>Mola de painel</b></p> <p>FORD ESCORT (Após 1995)</p> <p>d18x18.5mm 1p-d9.5-16mm</p>		<p><b>Z80617</b> NO. 6117693</p> <p><b>Mola de painel</b></p> <p>FORD ESCORT</p> <p>d18x16.5mm 1p-d7.4-11mm</p>
	<p><b>Z80623</b> NO.</p> <p><b>Mola de painel</b></p> <p>FORD ESCORT</p> <p>d25x30.6mm 1p-d12-14.5mm</p>		<p><b>Z80687</b> NO. 6448410 - 6678518 - 7700038445 - E866113S - N90710301 - W700671S300</p> <p><b>Mola de painel</b></p> <p>FORD ESCORT CLASSIC (AAL, ABL) 1.6 16V 10.1998/07.2000 66KW 90CV 1597CC L1E L1K 8566325 8566313 - FORD ESCORT CLASSIC (AAL, ABL) 1.8 TD 10.1998/07.2000 66KW 90CV 1753CC RFD RFK RFS 8566328 8566316 - FORD ESCORT CLASSIC Turnier (ANL) 1.6 16V 02.1999/07.2000 66KW 90CV 1597CC L1E L1K 8566331 - FORD ESCORT CLASSIC Turnier (ANL) 1.8 TD 02.1999/07.2000 66KW 90CV 1753CC RFK RFD RFS 8566334 - FORD ESCORT ...</p> <p>d25x14.5mm 1p-d9.3-12.5mm</p>

	<p><b>Z80704</b> NO. 500326189 - 6176723</p> <p>Mola de painel</p> <p>FORD ESCORT (Após 1995)</p> <p>d18x21mm 1p-d8.2-15mm</p>		<p><b>Z80717</b> NO. 6150260</p> <p>Mola de fixação</p> <p>FORD ESCORT</p> <p>d20x12.5mm 1p-8x11-10mm 1f-d5.5mm</p>
	<p><b>Z9005</b> NO. 1640227 - 6156718 - 6688870</p> <p>MOLA DE ESCAPE</p> <p>FORD ESCORT (APÓS 1983) - ORION (1986 A 1993)</p> <p>d25x28mm</p>		<p><b>Z9009</b> NO. 6142854 - 6146512</p> <p>MOLA DE ESCAPE</p> <p>FORD ESCORT (APÓS 1984) - ORION (1984 A 1993)</p> <p>d14x69mm</p>

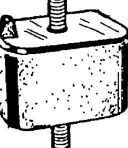
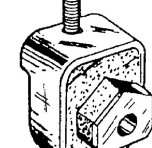





## FORD FIESTA-COURIER-FUSION-PUMA

	<p><b>A0075</b> NO. 6049904 - 6164624 - 6194624 - 77FB6038FD - 89FB6038FA</p> <p>APOIO SUPORTE FRENTE DO MOTOR</p> <p>FORD FIESTA Caixa/monovolume (F3L, F5L) 1.8 D 09.1991/02.1996 44KW 60CV 1753CC RTD RTG RTC 2028318 2028196 - FORD FIESTA Caixa/parte traseira inclinada (WFVT) 1.0 (WFVT) 10.1977/11.1986 29KW 40CV 957CC TKA 7528001 - FORD FIESTA Caixa/parte traseira inclinada (WFVT) 1.1 (WFVT) 10.1977/11.1986 39KW 53CV 1117CC GLA GL1 7528003 - FORD FIESTA I (GFBT) 0.9 05.1976/08.1983 29KW 40CV 957CC TKW TKA 0928475...</p> <p>72x56x40mm 2p-d10-25mm</p>		<p><b>A1036</b> NO. 6845223 - 6845225 - 91AB.6L028.CB</p> <p>APOIO INFERIOR DA FRENTE DO MOTOR LADO CAIXA</p> <p>FORD FIESTA Caixa/monovolume (J5, J3) 1.3 02.1996/08.2003 44KW 60CV 1299CC J4C J4T J4J J4R J4L J4Q 0928262 0928948 - FORD FIESTA I (GFBT) 1.1 (WFBT) 02.1981/08.1983 40KW 55CV 1117CC GLW 0928477 7528305 7528303 - FORD FIESTA III (GFJ) 1.8 16V 02.1992/12.1995 77KW 105CV 1796CC RDB 2028326 0928806 7528371</p>
	<p><b>A1037</b> NO. 6157620 - 6160229 - 6185027 - 86AB6038DB</p> <p>APOIO DIREITO DO MOTOR</p> <p>FORD FIESTA Caixa/monovolume (F3L, F5L) 1.8 D 09.1991/02.1996 44KW 60CV 1753CC RTD RTG RTC 2028318 2028196 - FORD FIESTA III (GFJ) 1.8 D 03.1989/12.1995 44KW 60CV 1753CC RTG RTG RTD 2028322 0928714 7528347</p> <p>152x85x60mm 1f-d12mm</p>		<p><b>A1057</b> NO. 1640021 - 6133904 - 6161628 - 84FB6038CD</p> <p>APOIO SUPORTE DIREITO FRENTE DO MOTOR</p> <p>FORD FIESTA III (GFJ) 1.1 03.1989/12.1995 37KW 50CV 1119CC G6A 2028321 0928712 0928785 7528368 7528345 - FORD FIESTA III (GFJ) 1.1 03.1989/12.1995 40KW 55CV 1119CC GUE GUD 2028320 0928711 0928784 7528367 7528344 - FORD FIESTA III (GFJ) 1.3 03.1989/12.1992 44KW 60CV 1299CC JBC 2028325 0928788 7528369 - FORD FIESTA III (GFJ) 1.3 Cat 05.1991/01.1997 44KW 60CV 1299CC J6B 2028325 0928788 7528369 - FORD...</p> <p>130x110x50mm 3p-d10-27mm 1r-d6mm</p>
	<p><b>A1058</b> NO. 6155714 - 6170427 - 86AB6038BB</p> <p>APOIO DA CAIXA DE VELOCIDADES FRENTE E TRÁS</p> <p>FORD FIESTA III (GFJ) 1.0 03.1989/12.1995 33KW 45CV 1001CC TLB - FORD FIESTA III (GFJ) 1.1 03.1989/12.1995 37KW 50CV 1119CC G6A 2028321 0928712 0928785 7528368 7528345 - FORD FIESTA III (GFJ) 1.1 03.1989/12.1995 40KW 55CV 1119CC GUE GUD 2028320 0928711 0928784 7528367 7528344 - FORD FIESTA III (GFJ) 1.3 03.1989/12.1992 44KW 60CV 1299CC JBC 2028325 0928788 7528369</p> <p>97x75x40mm 2p-d10-22mm</p>		<p><b>A1068</b> NO. 1638511 - 6131375 - 6160228 - 84FB6038AF</p> <p>APOIO SUPORTE DIREITO FRENTE DO MOTOR</p> <p>FORD FIESTA I (GFBT) 0.9 05.1976/08.1983 29KW 40CV 957CC TKW TKA 0928475 7528301 - FORD FIESTA I (GFBT) 0.9 05.1976/08.1983 33KW 45CV 957CC TLA 0928476 7528302 - FORD FIESTA II (FBD) 1.0 (FBD) 09.1983/02.1989 33KW 45CV 957CC TKB 0928581 7528311</p> <p>160x100x65mm 1f-d12mm 1r-d10mm 1p-d10-20mm</p>
	<p><b>A1077-I</b> NO. 6049904 - 6164624 - 6194624 - 77FB6038FD</p> <p>APOIO DO MOTOR FRENTE E TRÁS</p> <p>FORD FIESTA Caixa/monovolume (F3L, F5L) 1.8 D 09.1991/02.1996 44KW 60CV 1753CC RTD RTG RTC 2028318 2028196 - FORD FIESTA Caixa/parte traseira inclinada (WFVT) 1.0 (WFVT) 10.1977/11.1986 29KW 40CV 957CC TKA 7528001 - FORD FIESTA Caixa/parte traseira inclinada (WFVT) 1.1 (WFVT) 10.1977/11.1986 39KW 53CV 1117CC GLA GL1 7528003 - FORD FIESTA I (GFBT) 0.9 05.1976/08.1983 29KW 40CV 957CC TKW TKA 0928475...</p> <p>70x55x39mm 2p-d10-24mm</p>		<p><b>A1078-I</b> NO. 6045281 - 77FB6030EC</p> <p>APOIO SUPORTE FRENTE DO MOTOR (77FB6030EC)</p> <p>FORD FIESTA I (GFBT): 0.9 05.1976/08.1983 29KW 40CV 957CC - FORD FIESTA I (GFBT): 0.9 05.1976/08.1983 33KW 45CV 957CC - FORD FIESTA I (GFBT): 1.1 05.1976/08.1983 39KW 53CV 1117CC - FORD FIESTA I (GFBT): 1.3 08.1977/08.1983 49KW 66CV 1297CC - FORD FIESTA II (FBD): 1.1 (FBD) 05.1986/02.1989 36KW 49CV 1117CC - FORD FIESTA II (FBD): 1.1 (FBD) 09.1983/02.1989 37KW 50CV 1117CC - FORD FIESTA II (FBD): 1....</p> <p>75x66x63mm 1p-d10-40mm 1f-d12mm 1f-d18mm</p>
	<p><b>A1188</b> NO. 6203710 - 89AB6B049AD</p> <p>APOIO TRASEIRO SUPERIOR ESQUERDO DO MOTOR</p> <p>FORD FIESTA Caixa/monovolume (F3L, F5L) 1.8 D 09.1991/02.1996 44KW 60CV 1753CC RTD RTG RTC 2028318 2028196 - FORD FIESTA III (GFJ) 1.8 D 03.1989/12.1995 44KW 60CV 1753CC RTC RTG RTD 2028322 0928714 7528347</p> <p>97x75x40mm 2p-d10-22mm</p>		<p><b>A1318</b> NO. 6138727 - 6172938 - 82AB6049CA - 82AB6B049CA</p> <p>APOIO SUPORTE DE TRÁS DO MOTOR</p> <p>FORD FIESTA II (FBD) 1.6 D (FBD) 04.1984/02.1989 40KW 54CV 1608CC LTB 0928593 7528318</p> <p>140x109x105mm 1p-d10-35mm</p>

	<p><b>A1380</b> NO. 7350847 - 95AB3K155AD</p> <p><b>APOIO DA SUSPENSÃO DA FRENTE</b></p> <p>FORD FIESTA Caixa/monovolume (J5_, J3_) 1.3 02.1996/08.2003 44KW 60CV 1299CC J4C J4T J4J J4R J4L J4Q 0928262 0928948 - FORD FIESTA III (GFJ) 1.8 16V 02.1992/12.1995 77KW 105CV 1796CC RDB 2028326 0928806 7528371</p> <p>145x145x40mm 3p-d8-17mm</p>		<p><b>A1383</b> NO. 1013794 - 1E00-34-380 - 96AB.3K155.AG - 96FB 3K155AG - 96FB3K155AG</p> <p><b>APOIO DA SUSPENSÃO DA FRENTE</b></p> <p>FORD FIESTA Caixa/monovolume (F3L, F5L) 1.3 09.1991/02.1996 44KW 60CV 1299CC J6B 2028319 2028197 - FORD FIESTA Caixa/monovolume (F3L, F5L) 1.8 D 09.1991/02.1996 44KW 60CV 1753CC RTD RTG RTC 2028318 2028196 - FORD FIESTA Caixa/monovolume (J5_, J3_) 1.3 02.1996/08.2003 44KW 60CV 1299CC J4C J4T J4J J4R J4L J4Q 0928262 0928948 - FORD FIESTA Caixa/monovolume (J5_, J3_) 1.4 i 04.1996/10.1999 66KW 90CV 1...</p> <p>d105x49mm 1f-d23mm</p>
	<p><b>A1383</b> NO. 1013794 - 1E00-34-380 - 96AB.3K155.AG - 96FB 3K155AG - 96FB3K155AG</p> <p><b>APOIO DA SUSPENSÃO DA FRENTE</b></p> <p>FORD PUMA</p> <p>d105x49mm 1f-d23mm</p>		<p><b>A1384</b> NO. 1012893 - 1012895 - 1040403 - 1040404 - 7057298 - 7057299 - 7145504 - 7145505 - 94AB 6B049CF - 94A...</p> <p><b>APOIO DO MOTOR FRENTE LADO ESQUERDO</b></p> <p>FORD FIESTA III (GFJ): 1.8 16V 02.1992/12.1995 77KW 105CV 1796CC</p> <p>160x100x70mm 1p-d12-30mm</p>
	<p><b>A1385</b> NO. 1113176 - 1561781 - 6179974 - 77BM.6K255.AF - 77BM6K255AC</p> <p><b>APOIO DO TENSOR DE EMBRAIAGEM</b></p> <p>FORD FIESTA Caixa/monovolume (F3L, F5L) 1.3 09.1991/02.1996 44KW 60CV 1299CC J6B 2028319 2028197 - FORD FIESTA Caixa/monovolume (J5_, J3_) 1.3 02.1996/08.2003 44KW 60CV 1299CC J4C J4T J4J J4R J4L J4Q 0928262 0928948 - FORD FIESTA Caixa/parte traseira inclinada (WFVT) 1.0 (WFVT) 10.1977/11.1986 29KW 40CV 957CC TKA 7528001 - FORD FIESTA Caixa/parte traseira inclinada (WFVT) 1.1 (WFVT) 10.1977/11.1... 63x16x13mm</p>		<p><b>A1594</b> NO. 1143153 - 1146153 - 1151926 - 1203103 - 1253168 - 1469224 - 1697347 - 2561-3K155-AD - 2561.3K155...</p> <p><b>APOIO AMORTECEDOR FRENTE ( GASTA 2 UNIDADES )</b></p> <p>FORD FIESTA V (JH_, JD_): 1.25 16V 03.2003/06.2008 51KW 70CV 1242CC - FORD FIESTA V (JH_, JD_): 1.25 16V 05.2002/06.2008 55KW 75CV 1242CC - FORD FIESTA V (JH_, JD_): 1.3 11.2001/06.2008 44KW 60CV 1299CC - FORD FIESTA V (JH_, JD_): 1.3 11.2001/06.2008 51KW 69CV 1299CC - FORD FIESTA V (JH_, JD_): 1.4 16V 11.2001/06.2008 59KW 80CV 1388CC - FORD FIESTA V (JH_, JD_): 1.6 16V 11.2001/06.2008 74KW 100CV...</p> <p>108x108x34mm 3p-d8-22mm</p>
	<p><b>A1637</b> NO. 1010530 - 1014899 - 1086887 - 1096420 - 96FB7M121AJ</p> <p><b>APOIO DO MOTOR LADO DA CAIXA</b></p> <p>FORD FIESTA 4 96 A 01-99 1.8D R-96</p> <p>170x155x110mm 2r-d10mm</p>		<p><b>A1638</b> NO. 1021268 - 1060402 - 1099548 - 96FB6038BJ - 96FB6038BK - XS616038FA</p> <p><b>APOIO DO MOTOR PARTE DA FRENTE</b></p> <p>FORD FIESTA 4 APÓS 1996 1.8D R-96</p> <p>170x150x100mm 1p-d10-42mm</p>
	<p><b>A1639</b> NO. 1021267 - 1024123 - 1060401 - 1099547 - 96FB6038AK - 96FB6038AL - XS616038EA</p> <p><b>APOIO DO MOTOR PARTE DA FRENTE</b></p> <p>FORD FIESTA 4 APÓS 03-1998 1.0 R-96 - 1.2 16V R-96 - 1.3 R-96 - 1.4 16V R-96</p> <p>170x145x90mm 1p-d10-40mm</p>		<p><b>A1678</b> NO. 1202576 - 1214677 - 1232031 - 1301965 - 2S6116F012GC - 2S6116F012GC</p> <p><b>APOIO DO MOTOR</b></p> <p>FORD FIESTA (APÓS 2002)</p> <p>160x110x105mm</p>
	<p><b>A1817</b> NO. 1641111 - 7V2Q6030BB</p> <p><b>APOIO BASE DE REPARAÇÃO DO APOIO DO MOTOR</b></p> <p>FORD FIESTA (APÓS 2008)</p> <p>130x70x30mm</p>		<p><b>A1818</b> NO. 1526778 - 1526778S1 - 8V513K155BA</p> <p><b>APOIO SUPORTE AMORTECEDOR FRENTE ( GASTA 2 UNIDADES )</b></p> <p>FORD FIESTA VI 1.0 Hatchback (APÓS 01.13) 65cv 998cc - FORD FIESTA VI 1.0 Hatchback (APÓS 10.12) 80cv 998cc - FORD FIESTA VI 1.0 EcoBoost Hatchback (APÓS 01.13) 100cv 998cc - FORD FIESTA VI 1.0 EcoBoost Hatchback (APÓS 09.12) 125cv 998cc - FORD FIESTA VI</p> <p>106x114x35mm 1f-d12.5mm 3p-d8x22mm</p>
	<p><b>A1828</b> NO. 1141478 - 1141479 - 2S6H8125BA</p> <p><b>APOIO SUPORTE RADIADOR INFERIOR/SUPERIOR</b></p> <p>FORD FIESTA V (JH_ - JD_) 1.25 16V Hatchback (03.03 - 06.08) 70cv 1242cc - FORD FIESTA V (JH_ - JD_) 1.25 16V Hatchback (05.02 - 06.08) 75cv 1242cc - FORD FIESTA V (JH_ - JD_) 1.3 Hatchback (11.01 - 06.08) 44 60 1299 - FORD FIESTA V Hatchback (JH_ - JD_) 1.3</p> <p>38x33x30mm 1f-d15mm</p>		<p><b>A1924</b> NO. 1519590 - 1526663 - 1536951 - 1546649 - 1676770 - 1692614 - 1778550 - 8V516F012BB - 8V516F012BC - 8V...</p> <p><b>APOIO MOTOR LADO DIREITO</b></p> <p>FORD FIESTA VI 1.25 (A Partir de 06.08) 60cv 1242cc Hatchback - FORD FIESTA VI 1.25 (A Partir de 06.08) 82cv 1242cc Hatchback - FORD FIESTA VI 1.4 (A Partir de 06.08) 97cv 1388cc Hatchback - FORD FIESTA VI 1.4 LPG (A partir de 01.09) 92cv 1388cc Hatchback - FORD FIESTA VI 1.4 LPG (A partir de 01.09) 97cv 1388cc Hatchback - FORD FIESTA VI 1.6 Ti (A Partir de 06.08) 120cv 1596cc Hatchback...</p> <p>190x170x130mm 3f-d18mm 3f-d12mm</p>
	<p><b>A1925</b> NO. 1519602 - 1526662 - 1536950 - 1546648 - 1675990 - 1685701 - 1776911 - 8V516F012AB - 8V516F012AC - 8V...</p> <p><b>APOIO MOTOR PARTE FRENTE</b></p> <p>FORD FIESTA VI 1.4 TDCi (A Partir de 01.09) 68cv 1399cc Hatchback - FORD FIESTA VI 1.4 TDCi (A Partir de 07.10) 70cv 1399cc Hatchback - FORD FIESTA VI 1.6 TDCi (A Partir de 06.08) 75cv 1560cc Hatchback - FORD FIESTA VI 1.6 TDCi (A Partir de 06.08) 90cv 1560cc Hatchback - FORD FIESTA VI 1.6 TDCi (A Partir de 02.10) 95cv 1560cc Hatchback</p> <p>180x170x150mm 2f-d18mm 2f-d14mm</p>		<p><b>A1938</b> NO. 1513112 - 1526664 - 1529438 - 8V517M121AB - 8V517M121AC - 8V517M121AD - 8V517M121AE</p> <p><b>APOIO DO MOTOR LADO ESQUERDO CAIXA DE VELOCIDADES</b></p> <p>FORD FIESTA VI 1.25 (A Partir de 06.08) 60cv 1242cc Hatchback - FORD FIESTA VI 1.25 (A Partir de 06.08) 82cv 1242cc Hatchback - FORD FIESTA VI 1.4 (A Partir de 06.08) 97cv 1388cc Hatchback - FORD FIESTA VI 1.4 LPG (A Partir de 01.09) 97cv 1388cc Hatchback - FORD FIESTA VI 1.6 Ti (A Partir de 06.08) 120cv 1596cc Hatchback - FORD FIESTA VI 1.6 Ti (A Partir de 12.10) 134cv 1596cc Hatchbac...</p> <p>185x70x170mm 4f-20x12mm 2f-8mm 2p-M6x12mm</p>

	<p><b>A2258</b> NO. 1207864</p> <p>APOIO DO MOTOR LADO ESQUERDO EM CIMA</p> <p>FORD FIESTA V (JH_, JD_) 1.25 16V (De 2003.03 Até 2008.06) 51KW 70cv 1242cm3 Hatchback -            FORD FIESTA V (JH_, JD_) 1.25 16V (De 2002.05 Até 2008.06) 55KW 75cv 1242cm3 Hatchback -            FORD FIESTA V (JH_, JD_) 1.3 (De 2001.11 Até 2008.06) 44KW 60cv 1299cm3 Hatchback -            FORD FIESTA V (JH_, JD_) 1.3 (De 2001.11 Até 2008.06) 51KW 69cv 1299cm3 Hatchback -</p> <p>90x138x103mm 3f-d11mm 1r-d8mm</p>		<p><b>A2258</b> NO. 1207864</p> <p>APOIO DO MOTOR LADO ESQUERDO EM CIMA</p> <p>FORD FUSION (JU_) 1.25 (De 2004.08 Até 2012.12) 55KW 75cv 1242cm3 Combi -            FORD FUSION (JU_) 1.4 (De 2002.08 Até 2012.12) 59KW 80cv 1388cm3 Combi -            FORD FUSION (JU_) 1.6 (De 2002.08 Até 2008.11) 74KW 100cv 1596cm3 Combi -            FORD FUSION (JU_) 1.4 TDCi (De 2002.08 Até 2012.12) 50KW 68cv 1399cm3 Combi -</p> <p>90x138x103mm 3f-d11mm 1r-d8mm</p>
	<p><b>A2467</b> NO. 1140473 - 1146866 - 1207532 - 1822433 - 2S61-6F012-AD - 2S61-6F012-BD - CS69-6F012-AA</p> <p>APOIO DO MOTOR FRENTE LADO DIREITO</p> <p>FORD FIESTA V (JH_, JD_) : 1.6 16V 11.2001/06.2008 74KW 100CV 1596CC - FORD FIESTA VI (CB1, CCN): 1.6 01.2011/» » » 90KW 122CV 1597CC - FORD FIESTA V Van: 1.3 05.2002/08.2008 44KW 60CV 1299CC - FORD FIESTA V Van: 1.3 10.2003/07.2005 51KW 69CV 1299CC</p> <p>90x138x103mm 3f-d11mm 1r-d8mm</p>		<p><b>A2467</b> NO. 1140473 - 1146866 - 1207532 - 1822433 - 2S61-6F012-AD - 2S61-6F012-BD - CS69-6F012-AA</p> <p>APOIO DO MOTOR FRENTE LADO DIREITO</p> <p>FORD FIESTA VI Van: 1.25 01.2009/» » » 60KW 82CV 1242CC</p> <p>90x138x103mm 3f-d11mm 1r-d8mm</p>
	<p><b>BB22</b> NO. 1003610</p> <p>ABRAÇADEIRA BARRA ESTABILIZADORA ( GASTA 2 UNIDADES )</p> <p>FORD FIESTA III (GFJ): 1.6 i 16V 01.1994/12.1995 65KW 88CV 1597CC - FORD FIESTA III (GFJ): 1.8 16V 02.1992/12.1995 77KW 105CV 1796CC - FORD FIESTA III (GFJ): 1.8 XR2i 16V 02.1992/12.1995 96KW 130CV 1796CC - FORD FIESTA IV (JA_, JB_) : 1.8 D 08.1995/04.2000 44KW 60CV 1753CC - FORD FIESTA IV (JA_, JB_) : 1.8 DI 04.2000/01.2002 55KW 75CV 1753CC - FORD FIESTA Caixa (F3L, F5L): 1.3 09.1991/02.1996 44KW 6...</p>		<p><b>BB22</b> NO. 1003610</p> <p>ABRAÇADEIRA BARRA ESTABILIZADORA ( GASTA 2 UNIDADES )</p> <p>FORD PUMA (EC_) : 1.4 16V 11.1997/10.2000 66KW 90CV 1388CC - FORD PUMA (EC_) : 1.6 16V 08.2000/06.2002 76KW 103CV 1596CC - FORD PUMA (EC_) : 1.7 16V 03.1997/06.2002 92KW 125CV 1679CC</p>
	<p><b>BB23</b> NO. 6788739</p> <p>ABRAÇADEIRA BARRA ESTABILIZADORA ( GASTA 2 UNIDADES )</p> <p>FORD FIESTA III (GFJ): 1.6 i 16V 01.1994/12.1995 65KW 88CV 1597CC - FORD FIESTA III (GFJ): 1.8 16V 02.1992/12.1995 77KW 105CV 1796CC - FORD FIESTA III (GFJ): 1.8 XR2i 16V 02.1992/12.1995 96KW 130CV 1796CC - FORD FIESTA IV (JA_, JB_) : 1.8 DI 04.2000/01.2002 55KW 75CV 1753CC - FORD FIESTA Caixa (F3L, F5L): 1.3 09.1991/02.1996 44KW 6...</p>		<p><b>BB23</b> NO. 6788739</p> <p>ABRAÇADEIRA BARRA ESTABILIZADORA ( GASTA 2 UNIDADES )</p> <p>FORD PUMA (EC_) : 1.4 16V 11.1997/10.2000 66KW 90CV 1388CC - FORD PUMA (EC_) : 1.6 16V 08.2000/06.2002 76KW 103CV 1596CC - FORD PUMA (EC_) : 1.7 16V 03.1997/06.2002 92KW 125CV 1679CC</p>
	<p><b>C0231</b> NO. 6483712 - 91AB.16C618.AA</p> <p>BOTÃO DE AFINAÇÃO DE CAPOT</p> <p>FORD FIESTA (1989 A 1996)</p> <p>d27x44mm</p>		<p><b>C1002</b> NO. 6198161 - 6483712 - 89FBA04052AD</p> <p>BOTÃO DE CAPOT</p> <p>FORD FIESTA I (GFBT) 0.9 05.1976/08.1983 29KW 40CV 957CC TKW TKA 0928475 7528301 - FORD FIESTA I (GFBT) 0.9 05.1976/08.1983 33KW 45CV 957CC TLA 0928476 7528302 - FORD FIESTA I (GFBT) 1.1 05.1976/08.1983 39KW 53CV 1117CC GLA 0928477 7528303 - FORD FIESTA I (GFBT) 1.1 (WFBT) 02.1981/08.1983 40KW 55CV 1117CC GLW 0928477 7528305 7528303 - FORD FIESTA I (GFBT) 1.3 08.1977/08.1983 49KW 66CV 1297CC J3E 0...</p> <p>d21x39mm</p>
	<p><b>E0010</b> NO. 6048886 - 6053849 - 6111692 - 77FB5A262BD - 77FB5A262CA</p> <p>ESTICADOR DE ESCAPE</p> <p>FORD FIESTA - FIESTA DIESEL (ATÉ 8-83)</p> <p>73x47x38mm</p>		<p><b>E0023</b> NO. 6111691 - 6120254 - 6122002 - 6136012 - 6162002 - 81AB5A262AC - 93BB5A262HA</p> <p>ESTICADOR DE ESCAPE</p> <p>FORD FIESTA (0.9 - 1.1 - 1.3 - 1.4 - 1.6) - FIESTA DIESEL(APOS 8-83)</p> <p>92x58x38mm</p>
	<p><b>E0100</b> NO. 1061631 - 1067818 - 1071336 - 1130273 - 1661237 - 1E01-34-170A - 1S61.3B438.AA - 89FB3B438A1E ...</p> <p>ESTICADOR BARRA ESTABILIZADORA FRENTE ( GASTA 2 UNIDADES )</p> <p>FORD FIESTA Caixa/monovolume (F3L, F5L)   COURIER 1.3 09.1991/02.1996 44KW 60CV 1299CC J6B 2028319 2028197 - FORD FIESTA Caixa/monovolume (F3L, F5L)   COURIER 1.8 D 09.1991/02.1996 44KW 60CV 1753CC RTD RTG RTC 2028318 2028196 - FORD FIESTA Caixa/monovolume (J5_, J3_)   COURIER 1.3 02.1996/08.2003 44KW 60CV 1299CC J4C J4T J4J J4R J4L J4Q 0928262 0928948 - FORD FIESTA Caixa/monovolume (J5_, J3_)   C...</p> <p>275x34x34mm 2p-d10-20mm</p>		<p><b>E0101</b> NO. 1135077 - 1209035</p> <p>ESTICADOR DA BARRA ESTABILIZADORA DA FRENTE</p> <p>FORD FIESTA III 1.8 D (1989 A 1995 - FIESTA IV 1.8 D APOS 1996</p> <p>265x25x25mm 2p-d10-30mm</p>
	<p><b>E0102</b> NO. 1146150 - 1469212 - 1761200 - 2S61.3B438.AD - 2S61.3B438.AE - 2S613B438AC - DD3234170 - Y12561...</p> <p>ESTICADOR DA BARRA ESTABILIZADORA DA FRENTE</p> <p>FORD FIESTA V (JH_, JD_) : 1.25 16V 03.2003/06.2008 51KW 70CV 1242CC - FORD FIESTA V (JH_, JD_) : 1.25 16V 05.2002/06.2008 55KW 75CV 1242CC - FORD FIESTA V (JH_, JD_) : 1.3 11.2001/06.2008 44KW 60CV 1299CC - FORD FIESTA V (JH_, JD_) : 1.3 11.2001/06.2008 51KW 69CV 1299CC - FORD FIESTA V (JH_, JD_) : 1.4 16V 11.2001/06.2008 59KW 80CV 1388CC - FORD FIESTA V (JH_, JD_) : 1.6 16V 11.2001/06.2008 74KW 100CV ...</p> <p>320x34x34mm 2p-d10-28mm</p>		<p><b>E0102</b> NO. 1146150 - 1469212 - 1761200 - 2S61.3B438.AD - 2S61.3B438.AE - 2S613B438AC - DD3234170 - Y125613B438A...</p> <p>ESTICADOR DA BARRA ESTABILIZADORA DA FRENTE</p> <p>FORD FIESTA VI</p> <p>320x34x34mm 2p-d10-28mm</p>















	<p><b>E0102</b> NO. 1146150 - 1469212 - 1761200 - 2561.3B438.AD - 2561.3B438.AE - 25613B438AC - DD3234170 - Y125613B438A...</p> <p><b>ESTICADOR DA BARRA ESTABILIZADORA DA FRENTE</b></p> <p>FUSION (JU_): 1.25 08.2004 - 12.2012 55 75 1242                      FUSION (JU_): 1.4 08.2002 - 12.2012 59 80 1388                      FUSION (JU_): 1.6 08.2002 - 11.2009 74 100 1596                      FUSION (JU_): 1.4 TDCi 08.2002 - 12.2012 50 68 1399                      FUSION (JU_): 1.6 TDCi 11.2004 - 12.2012 66 90 1560</p> <p>320x34x34mm 2p-d10-28mm</p>	 <p><b>E0203-M</b> NO. 1055171 - 96FB6P082AE - 96FB6P082AD - XS616P082AA - XS616P082CA - 1004888 - 1091542 - 1093107 - 1E0...</p> <p><b>ESTICADOR SUPORTE APOIO MOTOR TRAS</b></p> <p>FORD FIESTA Caixa/monovolume (J5_ J3_)   COURIER 1.3 02.1996/08.2003 44KW 60CV 1299CC J4C J4T J4J J4R J4L J4Q 0928262 0928948 - FORD FIESTA IV (JA_ JB_) 1.0 i 04.1996/09.1999 38KW 52CV 999CC ZH10JRB - FORD FIESTA IV (JA_ JB_) 1.0 i 09.1999/01.2002 48KW 65CV 999CC C4E - FORD FIESTA IV (JA_ JB_) 1.25 i 16V 08.1995/01.2002 55KW 75CV 1242CC DHB DHA DHG DHE DHF DHD DHC 0928930 0928934 - FORD FIESTA...</p> <p>260x97x65mm 1f-d11mm 1f-d10mm</p>
	<p><b>E0221-M</b> NO. 1141459 - 1146866 - 1313587 - 1513114 - 1526696 - 1695146 - 25616P082AB - 3S616P082AA - 8V51.6P082...</p> <p><b>ESTICADOR SUPORTE APOIO MOTOR TRAS</b></p> <p>FORD FIESTA IV (JA_ JB_) 1.6 16V Sport 02.2000/01.2002 76KW 103CV 1596CC L1V L1T 8566455 8566396 - FORD FIESTA V (JH_ JD_)   IKON 1.25 16V 05.2002/06.2008 55KW 75CV 1242CC FUJB FUJA 8566514 8566518 8566ACT 8566ACL - FORD FIESTA V (JH_ JD_)   IKON 1.25 16V 03.2003/06.2008 51KW 70CV 1242CC M7JA M7JB 8566506 8566517 8566ACI 8566ACQ - FORD FIESTA V (JH_ JD_)   IKON 1.3 11.2001/06.2008 44KW 60CV 12...</p> <p>155x95x85mm</p>	 <p><b>E0256-M</b> NO. 1 513 114 - 1141459 - 1313587 - 1526696 - 1695146 - 25616P082AB - 3S616P082AA - 8V51.6P082AC - 8...</p> <p><b>ESTICADOR SUPORTE APOIO MOTOR TRAS</b></p> <p>FORD FIESTA VI (CB1, CCN) 1.25 desde 06.2008/&gt;&gt;&gt; 44KW 60CV 1242CC STJC STJB STJA STJD 8566A00 - FORD FIESTA VI (CB1, CCN) 1.25 desde 06.2008/&gt;&gt;&gt; 60KW 82CV 1242CC SNJD SNJA SNJC SNJB 8566AOP - FORD FIESTA VI (CB1, CCN) 1.4 desde 10.2008/&gt;&gt;&gt; 71KW 97CV 1388CC SPJA SPJC RTJB RTJA SPJE 8566A0Q - FORD FIESTA VI (CB1, CCN) 1.4 LPG desde 01.2009/&gt;&gt;&gt; 68KW 92CV 1388CC RTJB RTJA RTJD - FORD FIESTA VI (CB1, C...</p> <p>170x90x85mm 1f-d10,5mm 3f-d11mm</p>
	<p><b>E0256-M</b> NO. 1 513 114 - 1141459 - 1313587 - 1526696 - 1695146 - 25616P082AB - 3S616P082AA - 8V51.6P082AC - 8V51...</p> <p><b>ESTICADOR SUPORTE APOIO MOTOR TRAS</b></p> <p>FORD FIESTA V (JH_ JD_) 1.25 16V 05.2002/06.2008 55KW 75CV 1242CC FUJB, FUJA 8566514, 8566518, 8566ACT, 8566ACL - FORD FIESTA V (JH_ JD_) 1.25 16V 03.2003/06.2008 51KW 70CV 1242CC M7JA, M7JB 8566506, 8566517, 8566ACI, 8566ACQ - FORD FIESTA V (JH_ JD_) 1.3 11.2001/06.2008 44KW 60CV 1299CC BAJA 8566499, 8566505, 8566515, 8566ACR, 8566ACJ - FORD FIESTA V (JH_ JD_) 1.3 11.2001/06.2008 51KW 69CV 12...</p> <p>170x90x85mm 1f-d10,5mm 3f-d11mm</p>	 <p><b>E0256-M</b> NO. 1 513 114 - 1141459 - 1313587 - 1526696 - 1695146 - 25616P082AB - 3S616P082AA - 8V51.6P082AC - 8V51...</p> <p><b>ESTICADOR SUPORTE APOIO MOTOR TRAS</b></p> <p>FORD FUSION (JU_) 1.25 08.2004/12.2012 55KW 75CV 1242CC FUJB FUJA 8566ACB 8566545 - FORD FUSION (JU_) 1.4 08.2002/12.2012 59KW 80CV 1388CC FXJC FXJB FXJA 8566503 8566ABY - FORD FUSION (JU_) 1.4 TDCi 08.2002/12.2012 50KW 68CV 1399CC F6JA F6JB 8566502 8566ACC - FORD FUSION (JU_) 1.6 08.2002/11.2009 74KW 100CV 1596CC FYJC FYJB FYJA 8566504 8566ACA - FORD FUSION (JU_) 1.6 TDCi 11.2004/12.2012 66KW 90CV...</p> <p>170x90x85mm 1f-d10,5mm 3f-d11mm</p>
	<p><b>E0258</b> NO. 1513343 - 1745924 - 1790310 - 1905043 - 8V51.3B438.BA - 8V51.3B438.BB - 8V513B438AB - D6613417...</p> <p><b>ESTICADOR BARRA ESTABILIZADORA FRENTE ( GASTA 2 UNIDADES )</b></p> <p>FORD FIESTA VI (CB1, CCN): 1.0 01.2013/&gt;&gt;&gt; 48KW 65CV 998CC - FORD FIESTA VI (CB1, CCN): 1.0 10.2012/&gt;&gt;&gt; 59KW 80CV 998CC - FORD FIESTA VI (CB1, CCN): 1.0 EcoBoost 01.2013/&gt;&gt;&gt; 74KW 100CV 998CC - FORD FIESTA VI (CB1, CCN): 1.0 EcoBoost 09.2012/&gt;&gt;&gt; 92KW 125CV 998CC - FORD FIESTA VI (CB1, CCN): 1.0 Sport 05.2014/&gt;&gt;&gt; 103KW 140CV 998CC - FORD FIESTA VI (CB1, CCN): 1.25 06.2008/&gt;&gt;&gt; 44KW 60CV 1242CC - FORD...</p> <p>290x36x35mm 2p-d10x25mm</p>	 <p><b>E0638-M</b> NO. 1044418 - 1059003 - 1105798 - 97FB6P082BA - XS616P082DA</p> <p><b>ESTICADOR SUPORTE APOIO MOTOR TRAS</b></p> <p>FORD FIESTA Caixa/monovolume (J5_ J3_)   COURIER 1.8 D 02.1996/04.2002 44KW 60CV 1753CC RTK RTJ 0928261 0928949 - FORD FIESTA Caixa/monovolume (J5_ J3_)   COURIER 1.8 DI 09.2000/08.2003 55KW 75CV 1753CC RTP RTN 8566034 - FORD FIESTA Caixa/parte traseira inclinada (JV_)   COURIER D 1.8 05.1998/04.2002 44KW 60CV 1753CC RTJ RTK 0928260 - FORD FIESTA Caixa/parte traseira inclinada (JV_)   COURIER TD...</p> <p>d100x252x64mm 1f-d11mm 1f-d10mm</p>
	<p><b>E0638-M</b> NO. 1044418 - 1059003 - 1105798 - 97FB6P082BA - XS616P082DA</p> <p><b>ESTICADOR SUPORTE APOIO MOTOR TRAS</b></p> <p>FORD FIESTA IV (JA_ JB_) 1.8 D 08.1995/04.2000 44KW 60CV 1753CC RTK RTJ 0928931 0928935 - FORD FIESTA IV (JA_ JB_) 1.8 DI 04.2000/01.2002 55KW 75CV 1753CC RTQ RTP RTN 8566394 8566395</p> <p>d100x252x64mm 1f-d11mm 1f-d10mm</p>	 <p><b>E1018</b> NO. 1027374 - 6831302 - 6866417 - 93B85A262F - 93B85A262G - 93B85A262GA</p> <p><b>ESTICADOR DE ESCAPE</b></p> <p>FORD FIESTA</p> <p>66x54x19mm</p>
	<p><b>E1029</b> NO. 6827033 - 6882943 - 92AB5A262CD</p> <p><b>ESTICADOR DE ESCAPE</b></p> <p>FORD FIESTA I (GFBT) 0.9 05.1976/08.1983 29KW 40CV 957CC TKW TKA 0928475 7528301 - FORD FIESTA I (GFBT) 0.9 05.1976/08.1983 33KW 45CV 957CC TLA 0928476 7528302 - FORD FIESTA I (GFBT) 1.1 05.1976/08.1983 39KW 53CV 1117CC GLA 0928477 7528303 - FORD FIESTA I (GFBT) 1.3 08.1977/08.1983 49KW 66CV 1297CC J3E 0928494 7528304 - FORD FIESTA I (GFBT) 1.6 XR2 08.1981/08.1983 62KW 84CV 1598CC L3E 7528306 - FO...</p> <p>63x47x18mm</p>	 <p><b>E1070</b> NO. 1003890 - 1016405 - 1099277 - 1118218</p> <p><b>ESTICADOR DE ESCAPE</b></p> <p>FORD FIESTA IV (JA_ JB_) 1.0 i 04.1996/09.1999 38KW 52CV 999CC - FORD FIESTA IV (JA_ JB_) 1.0 i 09.1999/01.2002 48KW 65CV 999CC - FORD FIESTA IV (JA_ JB_) 1.1 09.1995/12.1996 37KW 50CV 1087CC - FORD FIESTA IV (JA_ JB_) 1.25 i 16V 08.1995/01.2002 55KW 75CV 1242CC - FORD FIESTA IV (JA_ JB_) 1.3 i 08.1995/01.2002 37KW 50CV 1299CC - FORD FIESTA IV (JA_ JB_) 1.3 i 08.1995/01.2002 44KW 60CV ...</p> <p>70x50x27mm</p>
	<p><b>E1070</b> NO. 1003890 - 1016405 - 1099277 - 1118218</p> <p><b>ESTICADOR DE ESCAPE</b></p> <p>FORD PUMA</p> <p>70x50x27mm</p>	 <p><b>E1087</b> NO. 1022729</p> <p><b>ESTICADOR DO ESCAPE</b></p> <p>FORD FIESTA (1995 A 2002) - PUMA (1997)</p> <p>70x50x25mm</p>
	<p><b>E80344BC</b> NO. 6567507 - 924F9740AA</p> <p><b>ESTICADOR BOMBA DE COMBUSTIVEL</b></p> <p>FORD FIESTA I (GFBT) 0.9 05.1976/08.1983 29KW 40CV 957CC TKW TKA 0928475 7528301 - FORD FIESTA I (GFBT) 0.9 05.1976/08.1983 33KW 45CV 957CC TLA 0928476 7528302 - FORD FIESTA I (GFBT) 1.1 05.1976/08.1983 39KW 53CV 1117CC GLA 0928477 7528303 - FORD FIESTA I (GFBT) 1.1 (WFBT) 02.1981/08.1983 40KW 55CV 1117CC GLW 0928477 7528305 7528303 - FORD FIESTA I (GFBT) 1.3 08.1977/08.1983 49KW 66CV 1297CC J3E...</p> <p>371x11x10mm</p>	 <p><b>E80344BC</b> NO. 6567507 - 924F9740AA</p> <p><b>ESTICADOR BOMBA DE COMBUSTIVEL</b></p> <p>FORD FIESTA II (FBD) 1.0 (FBD) 09.1983/02.1989 33KW 45CV 957CC TKB 0928581 7528311 - FORD FIESTA II (FBD) 1.1 (FBD) 09.1983/02.1989 37KW 50CV 1117CC GSF GLC 0928582 7528312 - FORD FIESTA II (FBD) 1.1 (FBD) 05.1986/02.1989 36KW 49CV 1117CC GSH 0928650 7528337 - FORD FIESTA II (FBD) 1.3 09.1983/09.1989 51KW 69CV 1297CC JPC - FORD FIESTA II (FBD) 1.3 (FBD) 09.1983/01.1987 51KW 69CV 1298CF JPC 0928592...</p> <p>371x11x10mm</p>



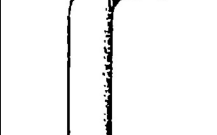









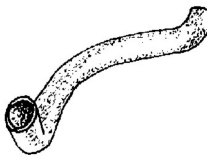

	<p><b>F0386-I</b> NO. 1470870 - 6047901 - 6079916</p> <p>FOLE DA CREMALHEIRA DA DIRECÇÃO ESQ. E DIR.</p> <p>FORD FIESTA TT (1976 A 1989)</p> <p>d59x157mm 1f-d30mm 1f-d10mm</p>		<p><b>F0387-I</b> NO. 6047900 - 6047904</p> <p>FOLE DA CREMALHEIRA DA DIRECÇÃO ESQ. E DIR.</p> <p>FORD FIESTA I 0.9 - 1.1 - 1.3 - 1.6 - (1976 A 1986) - FIESTA II 1.0 - 1.1 - 1.3 - 1.4 - 1.6 - 1.6D (1983 A 1989)</p> <p>d58x127mm 1f-d47mm 1f-d8mm</p>
	<p><b>F0538-I</b> NO. 1073846 - 6043191 - 77TTA331FA - 98AX.4A084.BA</p> <p>FOLE DO SEMI-EIXO JUNTO À RODA OU CAIXA DE VELOCIDADES</p> <p>FORD FIESTA TT (1976 A 2001) - FORD PUMA 1.4 - 1.7 (APOS 1997)</p> <p>d92x100mm 1f-d75mm 1f-d20mm</p>		<p><b>F0539-I</b> NO. 1016756 - 556021105 - 6028724 - 77TT3A331AA</p> <p>FOLE DO SEMI-EIXO JUNTO À RODA</p> <p>FORD FIESTA 0.9 - 1.0 - 1.1 (1976 A 1995)</p> <p>d81x100mm 1f-d68mm 1f-d20mm</p>
	<p><b>F0547-I</b> NO. 1016758 - 1072806 - 1073802 - 1073803 - 6028751 - 6161378 - 77TT3A331BA - 86AG3A331AA - 98FX4A084BA...</p> <p>FOLE DO SEMI-EIXO JUNTO À CAIXA DE VELOCIDADES</p> <p>FORD FIESTA 0.9 - 1.0 - 1.1 (1976 A 1995)</p> <p>d63x93mm 1f-d72mm 1f-d19mm</p>		<p><b>F1027</b> NO. 0440888 - 1649554 - 440888 - 83BG.4846.AA</p> <p>FOLE APOIO SUPORTE REPARAÇÃO TRANSMISSÃO</p> <p>FORD FIESTA I (GFBT): 1.1 (WFBT) 02.1981/08.1983 40KW 55CV 1117CC - FORD FIESTA Caixa/monovolume (J5_, J3_): 1.3 02.1996/08.2003 44KW 60CV 1299CC</p> <p>d94x62mm 1f-d54mm</p>
	<p><b>F1043-18</b> NO. 1450821 - 69AB3025BA</p> <p>FOLE DO AMORTECEDOR DA SUSPENSÃO FRENTE</p> <p>FORD FIESTA (0.9 - 1.1 - 1.3 - 1.4 - 1.6) - FIESTA DIESEL</p> <p>d75x145mm 1f-d68mm 1f-d18mm</p>		<p><b>F1183-I</b> NO. 6676140 - 92AG003L537AA</p> <p>FOLE JUNTO À CAIXA DE VELOCIDADES</p> <p>FORD FIESTA III 1.8 16V (02-1992 A 12-1993)</p> <p>d100x103mm 1f-d85mm 1f-d23mm</p>
	<p><b>F1444-I</b> NO. 6676136 - 92TT3A331</p> <p>FOLE DA TRANSMISSÃO JUNTO À RODA</p> <p>FORD FIESTA III 1.25i 16V - 1.3i - 1.4i 16V - 1.6i SPORT 16V - 1.8 D - 1.8 DI (1989 A 1995)</p> <p>d104x92mm 1f-d87mm 1f-d23mm</p>		<p><b>F1444-I</b> NO. 6676136 - 92TT3A331</p> <p>FOLE DA TRANSMISSÃO JUNTO À RODA</p> <p>FORD FIESTA IV 1.2i 16V - 1.3i - 1.4i 16V - 1.6i SPORT 16V - 1.8 D - 1.8 DI (1995 A 2001)</p> <p>d104x92mm 1f-d87mm 1f-d23mm</p>
	<p><b>F1615-I</b> NO. 1016772 - 1073804 - 6914763 - 98FX4A084DA</p> <p>FOLE TRANSMISSÃO JUNTO CAIXA TRIPOIDE 66MM ( GASTA 2 UNIDADES )</p> <p>FORD FIESTA III (GFJ): 1.1 03.1989/12.1995 37KW 50CV 1119CC - FORD FIESTA III (GFJ): 1.1 03.1989/12.1995 40KW 55CV 1119CC - FORD FIESTA III (GFJ): 1.3 03.1989/12.1992 44KW 60CV 1299CC - FORD FIESTA III (GFJ): 1.3 03.1989/12.1992 44KW 60CV 1299CC - FORD FIESTA III (GFJ): 1.3 Cat 05.1991/01.1997 44KW 60CV 1299CC - FORD FIESTA IV (JA_, JB_): 1.25i 16V 08.1995/01.2002 55KW 75CV 1242CC - FORD FIESTA IV (JA_, JB_): 1.3i 08.1995/01.2002 37KW 50CV 1299CC - FORD FI...</p> <p>d87x114mm 1f-d77mm 1f-d23mm</p>		<p><b>F1615-I</b> NO. 1016772 - 1073804 - 6914763 - 98FX4A084DA</p> <p>FOLE TRANSMISSÃO JUNTO CAIXA TRIPOIDE 66MM ( GASTA 2 UNIDADES )</p> <p>FORD FIESTA IV (JA_, JB_): 1.3i 08.1995/01.2002 37KW 50CV 1299CC - FORD FIESTA IV (JA_, JB_): 1.3i 08.1995/01.2002 44KW 60CV 1299CC - FORD FIESTA Caixa (F3L, F5L): 1.3 09.1991/02.1996 44KW 60CV 1299CC - FORD FIESTA Caixa (J5_, J3_): 1.3 02.1996/08.2003 44KW 60CV 1299CC - FORD FIESTA Caixa (J5_, J3_): 1.4i 04.1996/10.1999 66KW 90CV 1388CC</p> <p>d87x114mm 1f-d77mm 1f-d23mm</p>
	<p><b>F1623-I</b> NO. 1142811 - 1142813 - 1542346 - 2S61-3A331-AA - 2S61-4A084-AA - 2S61-4A084-BA - 2S61-4C062-AA</p> <p>FOLE DA TRANSMISSÃO JUNTO À RODA</p> <p>FORD FIESTA V (JH_, JD_): 1.6 16V 11.2001/06.2008 74KW 100CV 1596CC - FORD FIESTA V (JH_, JD_): 1.4 TDCi 11.2001/06.2008 50KW 68CV 1399CC</p> <p>d82x86mm 1f-d69mm 1f-d21mm</p>		<p><b>F1623-I</b> NO. 1142811 - 1142813 - 1542346 - 2S61-3A331-AA - 2S61-4A084-AA - 2S61-4A084-BA - 2S61-4C062-AA</p> <p>FOLE DA TRANSMISSÃO JUNTO À RODA</p> <p>FORD FUSION (JU_): 1.4 08.2002/12.2012 59KW 80CV 1388CC - FORD FUSION (JU_): 1.6 08.2002/11.2008 74KW 100CV 1596CC - FORD FUSION (JU_): 1.4 TDCi 08.2002/12.2012 50KW 68CV 1399CC</p> <p>d82x86mm 1f-d69mm 1f-d21mm</p>
	<p><b>F1649-I</b> NO. 1012814 - 3043575 - 7138554 - 94FB3K661AC</p> <p>FOLE DA DIRECÇÃO ASSISTIDA LADO DIREITO E ESQUERDO</p> <p>FORD FIESTA III (1989 A 1995 1.1i - 1.25i 16V - 1.3i - 1.4i - 1.4i 16V - 1.6i SPORT 16V - 1.8 D - 1.8 DI - FIESTA IV (1995 A 2001 1.25i - 1.3i - 1.4i - 1.6i - 1.8 D - 1.8 DI - COURIER APOS 1996 1.3i - 1.4i - 1.8 D - PUMA APOS 1997 1.4 16V - 1.7 16</p> <p>d70x190mm 1f-d55mm 1f-d12mm</p>		<p><b>F1649-I</b> NO. 1012814 - 3043575 - 7138554 - 94FB3K661AC</p> <p>FOLE DA DIRECÇÃO ASSISTIDA LADO DIREITO E ESQUERDO</p> <p>FORD PUMA (EC_): 1.4 16V 11.1997/10.2000 66KW 90CV 1388CC - FORD PUMA (EC_): 1.6 16V 08.2000/06.2002 76KW 103CV 1596CC - FORD PUMA (EC_): 1.7 16V 03.1997/06.2002 92KW 125CV 1679CC - FORD PUMA (EC_): Racing ST 160 06.1999/06.2002 114KW 155CV 1679CC</p> <p>d70x190mm 1f-d55mm 1f-d12mm</p>





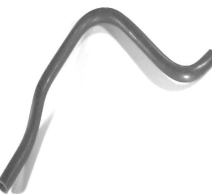
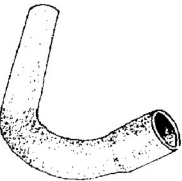











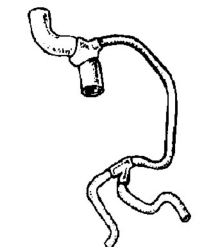











	<p><b>F1668-I</b> NO. 1619061 - 83BB.3K661.BD</p> <p>FOLE DA DIRECÇÃO DIREITO E ESQUERDO</p> <p>FORD FIESTA (1989 A 1992)</p>		<p><b>F1820-I</b> NO. 1142813 - 2S614A084AA</p> <p>FOLE DE TRANSMISSAO LADO DA CAIXA TRIPODE</p> <p>FORD FIESTA V (JH_, JD_): 1.4 TDCi 11.2001/06.2008 50KW 68CV 1399CC - MAZDA FIESTA V Van: 1.4 05.2002/09.2005 59KW 80CV 1388CC - FORD FIESTA V Van: 1.4 TDCi 10.2003/12.2010 50KW 68CV 1399CC</p>
	<p><b>F1820-I</b> NO. 1142813 - 2S614A084AA</p> <p>FOLE DE TRANSMISSAO LADO DA CAIXA TRIPODE</p> <p>FORD FUSION (JU_): 1.4 LPG 01.2010/12.2012 59KW 80CV 1388CC - FORD FUSION (JU_): 1.4 TDCi 08.2002/12.2012 50KW 68CV 1399CC - FORD FUSION (JU_): 1.6 TDCi 11.2004/12.2012 66CV 90CV 1560CC</p>		<p><b>F1844-I</b> NO. 1026905 - 1073806 - 1304000 - 1S5W3L537AA - 1S5W4A084AA - 1S5W4A084BA - 4453301 - 97FG3L537AB</p> <p>FOLE DA TRANSMISSÃO JUNTO À CAIXA</p> <p>FORD FIESTA IV (JA_, JB_): 1.25 i 16V 08.1995/01.2002 55KW 75CV 1242CC - FORD FIESTA IV (JA_, JB_): 1.3 i 08.1995/01.2002 37KW 50CV 1299CC - FORD FIESTA IV (JA_, JB_): 1.3 i 08.1995/01.2002 44KW 60CV 1299CC - FORD FIESTA IV (JA_, JB_): 1.4 i 16V 04.1996/01.2002 66KW 90CV 1388CC - FORD FIESTA IV (JA_, JB_): 1.6 16V Sport 02.2000/01.2002 76KW 103CV 1596CC - FORD FIESTA IV (JA_, JB_): 1.8 D 08.1995/0...</p>
	<p><b>F1844-I</b> NO. 1026905 - 1073806 - 1304000 - 1S5W3L537AA - 1S5W4A084AA - 1S5W4A084BA - 4453301 - 97FG3L537AB</p> <p>FOLE DA TRANSMISSÃO JUNTO À CAIXA</p> <p>FORD PUMA (EC_): 1.4 16V 11.1997/10.2000 66KW 90CV 1388CC - FORD PUMA (EC_): 1.6 16V 08.2000/06.2002 76KW 103CV 1596CC - FORD PUMA (EC_): 1.7 16V 03.1997/06.2002 92KW 125CV 1679CC - FORD PUMA (EC_): Racing ST 160 06.1999/06.2002 114KW 155CV 1679CC</p>		<p><b>F1855-I</b> NO. 21143K661AA - 4381841 - 6177346 - 6182218 - 6935233 - 86AB3K661A1A - 92AB3K661AA - 98AG3K661AA</p> <p>FOLE DA DIRECÇÃO LADO DIREITO E ESQUERDO</p> <p>FORD FIESTA III (GFJ): 1.8 16V 02.1992/12.1995 77KW 105CV 1796CC - FORD FIESTA III (GFJ): 1.8 XR2i 16V 02.1992/12.1995 96KW 130CV 1796CC - FORD FIESTA III (GFJ): 1.8 D 03.1989/12.1995 44KW 60CV 1753CC - FORD FIESTA IV (JA_, JB_): 1.0 i 02.1997/09.1999 38KW 52CV 999CC - FORD FIESTA IV (JA_, JB_): 1.0 i 09.1999/01.2002 48KW 65CV 999CC - FORD FIESTA IV (JA_, JB_): 1.1 09.1995/12.1996 37KW 50CV 1087CC...</p>
	<p><b>F4243</b> NO. 1702500 - 8A6R-7H409-NAA</p> <p>FOLE ALAVANCA VELOCIDADES C/ MANETE PUNHO TOPO COMPLETO 5 VELOCIDADES</p> <p>FORD FIESTA VI (CB1, CCN) 1.25 (De 06.2008 -) 44KW 60cv 1242cm3 Hatchback - FORD FIESTA VI (CB1, CCN) 1.25 (De 06.2008 -) 60KW 82cv 1242cm3 Hatchback - FORD FIESTA VI (CB1, CCN) 1.4 (De 10.2008 -) 71KW 97cv 1388cm3 Hatchback - FORD FIESTA VI (CB1, CCN) 1.6 TDCi (De 06.2008 -) 55KW 75cv 1560cm3 Hatchback - FORD FIESTA VI (CB1, CCN) 1.6 TDCi (De 06.2008 -) 66KW 90cv 1560cm3 Hatchback - FORD FIESTA V...</p>		<p><b>F4267</b> NO. 8A6R7H409MA - 8A6R7H409NAA</p> <p>FOLE ALAVANCA VELOCIDADES</p> <p>FORD FIESTA V (JH_, JD_)   IKON 1.25 16V 05.2002/06.2008 55KW 75CV 1242CC FUJB FUJA 8566514 8566518 8566ACT 8566ACL - FORD FIESTA V (JH_, JD_)   IKON 1.25 16V 03.2003/06.2008 51KW 70CV 1242CC M7JA M7JB 8566506 8566517 8566ACI 8566ACQ - FORD FIESTA V (JH_, JD_)   IKON 1.3 11.2001/06.2008 44KW 60CV 1299CC BAJA 8566499 8566505 8566515 8566ACR 8566ACJ - FORD FIESTA V (JH_, JD_)   IKON 1.3 11.2001/06.2...</p>
	<p><b>F4268</b> NO. 1702500 - 8A6R7H409MA - 8A6R7H409NAA</p> <p>FOLE ALAVANCA VELOCIDADES</p> <p>FORD FIESTA V (JH_, JD_)   IKON 1.25 16V 05.2002/06.2008 55KW 75CV 1242CC FUJB FUJA 8566514 8566518 8566ACT 8566ACL - FORD FIESTA V (JH_, JD_)   IKON 1.25 16V 03.2003/06.2008 51KW 70CV 1242CC M7JA M7JB 8566506 8566517 8566ACI 8566ACQ - FORD FIESTA V (JH_, JD_)   IKON 1.3 11.2001/06.2008 44KW 60CV 1299CC BAJA 8566499 8566505 8566515 8566ACR 8566ACJ - FORD FIESTA V (JH_, JD_)   IKON 1.3 11.2001/06.2...</p>		<p><b>F4316</b> NO. 1318360 - 1324957 - 1330115 - 1331570 - 1334955 - 1340103 - 1342945 - 4M51A045B79</p> <p>FOLE ALAVANCA VELOCIDADES</p> <p>FORD FIESTA VI (CB1, CCN) 1.0 10.2012/04.2017 59KW 80CV 998CC P4JD P4JA P4JC P4JB 8566BGJ - FORD FIESTA VI (CB1, CCN) 1.0 01.2013/04.2017 48KW 65CV 998CC XMJB XMJA XMJC XMJD 8566BGK - FORD FIESTA VI (CB1, CCN) 1.0 EcoBoost até 12.2017 74KW 100CV 998CC SFJA SFJB SFJF SFJC 8566BGD - FORD FIESTA VI (CB1, CCN) 1.0 EcoBoost até 12.2017 92KW 125CV 998CC M1JH M1JE 8566BGE - FORD FIESTA VI (CB1, CCN) 1.0 ...</p>
	<p><b>H312</b> NO.</p> <p>PALA ORIGINAL</p> <p>FORD FIESTA</p>		<p><b>KF1606</b> NO. 1142813 - 2S61-4A084-AA - 2S61-4A084-BA</p> <p>KIT DE FOLE DO CARDAN JUNTO À RODA</p> <p>FORD FIESTA V 1.4 TDCi - 1.6i 16V (APÓS 2001) - FUSION 1.4 TDCi - 1.6i (APÓS 2002)</p>
	<p><b>KF1800</b> NO. 1016756 - 556021105 - 6028724 - 77TT3A331AA</p> <p>FOLE DO LADO DA RODA (DIAM. 68mm)</p> <p>FORD FIESTA 1.0 - 1.1 - N. FIESTA - FIESTA VAN</p>		<p><b>KF1810</b> NO. 1016760 - 1073805 - 1073846 - 1638320 - 6043191 - 6053206 - 77TT3A331FA - 95SX4K258DA - 98AX.4A08...</p> <p>FOLE DO LADO DA RODA (DIAM. 78mm)</p> <p>FORD FIESTA 1.3 - 1.6 - NEW FIESTA</p>
	<p><b>KF9003</b> NO. 1073804 - 98FX4A084DA</p> <p>KIT DE FOLE DO CARDAN LADO DA CAIXA</p> <p>FORD FIESTA APÓS 1995</p>		<p><b>KF9005</b> NO. 1349165 - XS4J4A084DA</p> <p>KIT DE FOLE DO CARDAN LADO DA RODA</p> <p>FORD FIESTA APÓS 1995 - FOCUS APÓS 1998</p>

	<p><b>KF9008</b> NO. 1142817 - 2S614A084DA</p> <p>KIT DE FOLE DO LADO DA RODA</p> <p>FORD FIESTA APÓS 2002</p> <p>d80x80mm 1f-d67mm 1f-d21mm</p>		<p><b>KF9009</b> NO. 1142816 - 2S614A084CA</p> <p>KIT DE FOLE DA LADO DA CAIXA</p> <p>FORD FIESTA APÓS 2002</p> <p>d76x83mm 1f-d66mm 1f-d16mm</p>
	<p><b>KF9010</b> NO. 1142811 - 2S614A084AA</p> <p>KIT DE FOLE DO CARDAN JUNTO À RODA E CAIXA</p> <p>FORD FIESTA APÓS 2002 - FUSION</p> <p>d82x80mm d76x83mm 1f-d68mm 1f-d22mm 1f-d65mm 1f-d16mm</p>		<p><b>KL1066-I</b> NO. 6180329 - 6189055</p> <p>KIT DO PEDAL DA EMBRAIAGEM</p> <p>FORD FIESTA (2ª SÉRIE)</p> <p>123x70x20mm</p>
	<p><b>KUBT3015</b> NO. 1355131 - 1355133</p> <p>KIT BORRACHAS TRAVAO PINÇA DE TRAS C/EMBOLO LUCAS/TRW 34MM</p> <p>FORD FIESTA V (JH., JD.): ST150 03.2005/06.2008 110KW 150CV 1999CC</p> <p>d34x48mm d45x11mm d41x28mm/1f-d8mm 1f-d25mm 1f-d36mm</p>		<p><b>KUBT3015</b> NO. 1075553 - 1075554</p> <p>KIT BORRACHAS TRAVAO PINÇA DE TRAS C/EMBOLO LUCAS/TRW 34MM</p> <p>FORD FIESTA VI (CB1, CCN): 1.6 ST200 04.2016/»» 147KW 200CV 1596CC - FORD FIESTA VI (CB1, CCN): 1.5 TDCi 05.2015/»» 70KW 95CV 1499CC - FORD FIESTA VI Van: 1.5 TDCi 05.2015/»» 70KW 95CV 1499CC</p> <p>d34x48mm d45x11mm d41x28mm/1f-d8mm 1f-d25mm 1f-d36mm</p>
	<p><b>L3005</b> NO. 1568682 - 1610371 - 6076533</p> <p>CASQUILHO DA EXTREMIDADE DA CREMALHEIRA DA DIRECÇÃO</p> <p>FORD FIESTA Caixa/monovolume (J5., J3.)   COURIER 1.3 02.1996/08.2003 44KW 60CV 1299CC J4C J4T J4J J4R J4L J4Q 0928262 0928948 - FORD FIESTA I (GFBT) 0.9 05.1976/08.1983 29KW 40CV 957CC TKW TKA 0928475 7528301 - FORD FIESTA I (GFBT) 0.9 05.1976/08.1983 33KW 45CV 957CC TLA 0928476 7528302 - FORD FIESTA I (GFBT) 1.1 05.1976/08.1983 39KW 53CV 1117CC GLA 0928477 7528303 - FORD FIESTA I (GFBT) 1.1 (WFB...</p> <p>32x32x18mm 1f-d22mm</p>		<p><b>L3008</b> NO. 1568682 - 1610371 - 6076533 - 83BB3K723AA - E863085S82</p> <p>CASQUILHO DA DIRECÇÃO</p> <p>FORD FIESTA Caixa/monovolume (J5., J3.)   COURIER 1.3 02.1996/08.2003 44KW 60CV 1299CC J4C J4T J4J J4R J4L J4Q 0928262 0928948 - FORD FIESTA I (GFBT) 0.9 05.1976/08.1983 29KW 40CV 957CC TKW TKA 0928475 7528301 - FORD FIESTA I (GFBT) 0.9 05.1976/08.1983 33KW 45CV 957CC TLA 0928476 7528302 - FORD FIESTA I (GFBT) 1.1 05.1976/08.1983 39KW 53CV 1117CC GLA 0928477 7528303 - FORD FIESTA I (GFBT) 1.1 (WFB...</p> <p>35x35x18mm 1f-d22mm</p>
	<p><b>L3012</b> NO. 1621933 - 6100905 - 6140086</p> <p>CASQUILHO DA BARRA ESTABILIZADORA</p> <p>FORD FIESTA I (GFBT): 0.9 05.1976/08.1983 29KW 40CV 957CC - FORD FIESTA I (GFBT): 0.9 05.1976/08.1983 33KW 45CV 957CC - FORD FIESTA I (GFBT): 1.1 05.1976/08.1983 39KW 53CV 1117CC - FORD FIESTA I (GFBT): 1.3 08.1977/08.1983 49KW 66CV 1297CC - FORD FIESTA I (GFBT): 1.6 XR2 08.1981/08.1983 62KW 84CV 1598CC - FORD FIESTA II (FBD): 1.1 (FBD) 05.1986/02.1989 36KW 49CV 1117CC - FORD FIESTA II (FBD): 1.1 ...</p> <p>d41x15mm 1f-17mm</p>		<p><b>L3105</b> NO. 1204698 - 2S6Q9A510AA</p> <p>CASQUILHO DO INJECTOR</p> <p>FORD FIESTA (APÓS 2002)</p> <p>d24x10mm 1f-d20mm</p>
	<p><b>M6002</b> NO. 1656281 - 6156722 - 6166244 - 6201608 - 6616584 - 6688868</p> <p>JUNTA DE ESCAPE</p> <p>FORD FIESTA (1989 A 1992)</p> <p>d66x14mm 1f-d50mm</p>		<p><b>M6037</b> NO. 1565558 - 6065962 - 6115136 - 6134622 - 6134623 - 6615275 - 81AB9451AA</p> <p>JUNTA DE ESCAPE</p> <p>FORD FIESTA (1981 A 1995)</p> <p>107x80mm 2f-d42mm</p>
	<p><b>M6043</b> NO. 1630835 - 6120644 - 6120664 - 6134624 - 6163389</p> <p>JUNTA DE ESCAPE</p> <p>FORD FIESTA (1983 A 1995)</p> <p>120x80mm 2f-d42mm</p>		<p><b>M6069</b> NO. 6645622</p> <p>JUNTA DE ESCAPE</p> <p>FORD FIESTA (1983 A 1989)</p> <p>120x65mm 2f-d42mm</p>
	<p><b>M6070</b> NO. 1664671</p> <p>JUNTA DE ESCAPE</p> <p>FORD FIESTA (1989 A 1992)</p> <p>120x71mm 1f-d55mm</p>		<p><b>M6071</b> NO. 6168647 - 6645621</p> <p>JUNTA DE ESCAPE</p> <p>FORD FIESTA (1989 A 1992)</p> <p>124x75mm 2f-d45mm</p>









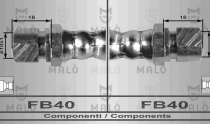
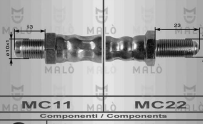
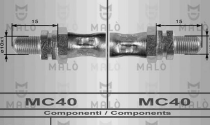

	<p><b>M6095</b> NO. 6789153 - 7398780</p> <p>JUNTA DE ESCAPE</p> <p>FORD FIESTA (1992 A 1995)</p> <p>d95x13mm 1f-d75mm</p>		<p><b>M6102</b> NO. 6159982 - 6162279 - 6642511 - 6692744</p> <p>JUNTA DE ESCAPE</p> <p>FORD FIESTA (1995 A 1999)</p> <p>127x70x2mm 1f-d56mm</p>
	<p><b>M6108</b> NO. 6026339</p> <p>JUNTA DE ESCAPE</p> <p>FORD FIESTA (81-84)</p> <p>57x14mm 1f-d43mm</p>		<p><b>N2002</b> NO. 113E5381B - 1719466</p> <p>ANEL DE ESCAPE</p> <p>FORD FIESTA (1981 A 1996)</p> <p>d43x12mm 1f-d19mm</p>
	<p><b>N2335</b> NO. 1473296</p> <p>ANEL ESCAPE</p> <p>FORD FIESTA IV (JA_, JB_): 1.8 D 08.1995/04.2000 44KW 60CV 1753CC</p> <p>d65x15mm 1f-d36mm</p>		<p><b>P1010</b> NO. 1526242 - 72EB2457BA</p> <p>CAPA DE PEDAL DO TRAVÃO E EMBRAIAGEM</p> <p>FORD FIESTA I (GFBT): 0.9 05.1976/08.1983 29KW 40CV 957CC - FORD FIESTA I (GFBT): 0.9 05.1976/08.1983 33KW 45CV 957CC - FORD FIESTA I (GFBT): 1.1 05.1976/08.1983 39KW 53CV 1117CC - FORD FIESTA I (GFBT): 1.1 (WFBT) 02.1981/08.1983 40KW 55CV 1117CC - FORD FIESTA I (GFBT): 1.3 08.1977/08.1983 49KW 66CV 1297CC - FORD FIESTA I (GFBT): 1.6 XR2 08.1981/08.1983 62KW 84CV 1598CC - FORD FIESTA II (FBD): 1.0...</p> <p>68x49x15mm PINO-39x11x4mm</p>
	<p><b>P1026</b> NO. 6168375 - 89FB.2457.AA</p> <p>CAPA DE PEDAL TRAVÃO E EMBRAIAGEM</p> <p>FORD FIESTA III (GFJ): 1.1 03.1989/12.1995 37KW 50CV 1119CC - FORD FIESTA III (GFJ): 1.1 03.1989/12.1995 40KW 55CV 1119CC - FORD FIESTA III (GFJ): 1.4 03.1989/12.1995 52KW 71CV 1391CC - FORD FIESTA III (GFJ): 1.4 03.1989/12.1995 54KW 73CV 1392CC - FORD FIESTA III (GFJ): 1.6 01.1989/01.1994 65KW 88CV 1597CC - FORD FIESTA III (GFJ): 1.6 i 16V 01.1994/12.1995 65KW 88CV 1597CC - FORD FIESTA IV (JA_, J...)</p> <p>68x54x14mm</p>		<p><b>P1026</b> NO. 6168375 - 89FB.2457.AA</p> <p>CAPA DE PEDAL TRAVÃO E EMBRAIAGEM</p> <p>FORD PUMA (EC_): 1.4 16V 11.1997/10.2000 66KW 90CV 1388CC - FORD PUMA (EC_): 1.6 16V 08.2000/06.2002 76KW 103CV 1596CC - FORD PUMA (EC_): 1.7 16V 03.1997/06.2002 92KW 125CV 1679CC</p> <p>68x54x14mm</p>
	<p><b>R220000</b> NO. 6047976 - 6827019</p> <p>TUBO SUPERIOR DO RADIADOR</p> <p>FORD FIESTA I (GFBT): 0.9 05.1976/08.1983 29KW 40CV 957CC - FORD FIESTA I (GFBT): 0.9 05.1976/08.1983 33KW 45CV 957CC - FORD FIESTA I (GFBT): 1.1 05.1976/08.1983 39KW 53CV 1117CC - FORD FIESTA I (GFBT): 1.1 (WFBT) 02.1981/08.1983 40KW 55CV 1117CC</p> <p>B315-d30/30mm 240-155mm</p>		<p><b>R220195</b> NO. 5006016 - 6051492 - 77FB8260AC</p> <p>TUBO SUPERIOR DO RADIADOR</p> <p>FORD FIESTA Caixa/parte traseira inclinada (WFVT) 1.0 (WFVT) 10.1977/11.1986 29KW 40CV 957CC TKA 7528001 - FORD FIESTA Caixa/parte traseira inclinada (WFVT) 1.1 (WFVT) 10.1977/11.1986 39KW 53CV 1117CC GLA 1.1 7528003 - FORD FIESTA I (GFBT) 0.9 05.1976/08.1983 29KW 40CV 957CC TKW TKA 0928475 7528301 - FORD FIESTA I (GFBT) 0.9 05.1976/08.1983 33KW 45CV 957CC TLA 0928476 7528302 - FORD FIESTA I (GFBT)...</p> <p>B250-30/30mm 56-62-70mm</p>
	<p><b>R220196</b> NO. 6047976 - 6827019</p> <p>TUBO DE RADIADOR INFERIOR</p> <p>FORD FIESTA I (GFBT): 0.9 05.1976/08.1983 29KW 40CV 957CC - FORD FIESTA I (GFBT): 0.9 05.1976/08.1983 33KW 45CV 957CC - FORD FIESTA I (GFBT): 1.1 05.1976/08.1983 39KW 53CV 1117CC - FORD FIESTA II (FBD): 1.1 (FBD) 05.1986/02.1989 36KW 49CV 1117CC - FORD FIESTA II (FBD): 1.1 (FBD) 09.1983/02.1989 37KW 50CV 1117CC</p> <p>B300-d31/31mm 120-250mm</p>		<p><b>R220198</b> NO. 1562615</p> <p>TUBO DO PERMUTADOR DO AQUECIMENTO</p> <p>FORD FIESTA I (GFBT) 0.9 05.1976/08.1983 29KW 40CV 957CC TKW TKA 0928475 7528301 - FORD FIESTA I (GFBT) 0.9 05.1976/08.1983 33KW 45CV 957CC TLA 0928476 7528302 - FORD FIESTA I (GFBT) 1.1 05.1976/08.1983 39KW 53CV 1117CC GLA 0928477 7528303</p> <p>B378-d16/d16mm 41-170-370-79mm</p>
	<p><b>R220198</b> NO. 1562615</p> <p>TUBO DO PERMUTADOR DO AQUECIMENTO</p> <p>FORD FIESTA II (FBD) 1.1 (FBD) 09.1983/02.1989 37KW 50CV 1117CC GSF GLC 0928582 7528312 - FORD FIESTA II (FBD) 1.1 (FBD) 05.1986/02.1989 36KW 49CV 1117CC GSH 0928650 7528337</p> <p>B378-d16/d16mm 41-170-370-79mm</p>		<p><b>R220440</b> NO. 1459488 - 1546885</p> <p>TUBO DE RADIADOR INFERIOR</p> <p>FORD FIESTA I (GFBT) 1.1 (WFBT) 02.1981/08.1983 40KW 55CV 1117CC GLW 0928477 7528305 7528303</p> <p>B240-d33/33mm 145-170-90mm</p>
	<p><b>R220441</b> NO. 1595579 - 6115579</p> <p>TUBO DE RADIADOR INFERIOR</p> <p>FORD FIESTA I (GFBT) 1.1 (WFBT) 02.1981/08.1983 40KW 55CV 1117CC GLW 0928477 7528305 7528303</p> <p>B430-d32/32mm 80-70-240-140mm</p>		<p><b>R220442</b> NO. 105E8260A - 1465390 - 1546886 - 691F8260AA - 691G8260AA - 72AB8260AA</p> <p>TUBO DE RADIADOR SUPERIOR</p> <p>FORD FIESTA I (GFBT): 1.1 (WFBT) 02.1981/08.1983 40KW 55CV 1117CC</p> <p>B190-d31/38mm 40-150-150mm</p>

	<p><b>R220443</b> NO. 6088586</p> <p>TUBO DE RADIADOR SUPERIOR</p> <p>FORD FIESTA I (GFBT) 1.1 (WFBT) 02.1981/08.1983 40KW 55CV 1117CC GLW 0928477 7528305 7528303</p> <p>B280-d31/33mm 120-90-70-70mm</p>		<p><b>R220445</b> NO. 6094482</p> <p>TUBO DE ENVIO DE ÁGUA AO AQUECIMENTO</p> <p>FORD FIESTA I (GFBT) 1.1 (WFBT) 02.1981/08.1983 40KW 55CV 1117CC GLW 0928477 7528305 7528303</p> <p>B330-d16/16mm 80-90-190-75mm</p>
	<p><b>R220447</b> NO. 6070349 - 6070359</p> <p>TUBO DE RETORNO DA ÁGUA DO AQUECIMENTO</p> <p>FORD FIESTA I (GFBT): 1.1 (WFBT) 02.1981/08.1983 40KW 55CV 1117CC</p> <p>B410-d16/16mm 80-380-285-75mm</p>		<p><b>R220501</b> NO. 6079523 - 6115575</p> <p>TUBO DE RADIADOR SUPERIOR</p> <p>FORD FIESTA Caixa/monovolume (J5_, J3_) 1.3 02.1996/08.2003 44KW 60CV 1299CC J4C J4T J4J J4R J4L J4Q 0928262 0928948</p> <p>B285-d32/32mm 70-135-65-50mm</p>
	<p><b>R220502</b> NO. 1595546 - 6099727</p> <p>TUBO DE RADIADOR INFERIOR</p> <p>FORD FIESTA Caixa/monovolume (J5_, J3_) 1.3 02.1996/08.2003 44KW 60CV 1299CC J4C J4T J4J J4R J4L J4Q 0928262 0928948</p> <p>B300-d32/32mm 80-120-200-70mm</p>		<p><b>R220504</b> NO. 6119164</p> <p>TUBO DE RADIADOR INFERIOR</p> <p>FORD FIESTA Caixa/monovolume (J5_, J3_) 1.3 02.1996/08.2003 44KW 60CV 1299CC J4C J4T J4J J4R J4L J4Q 0928262 0928948</p> <p>B300-d32/33mm 60-120-165-50-60mm</p>
	<p><b>R220505</b> NO. 1604864 - 6146420</p> <p>TUBO DE ENVIO DE ÁGUA AO AQUECIMENTO</p> <p>FORD FIESTA II (FBD): 1.3 (FBD) 09.1983/01.1987 51KW 69CV 1298CC - FORD FIESTA Caixa/monovolume (J5_, J3_) 1.3 02.1996/08.2003 44KW 60CV 1299CC</p> <p>B180-d15/15mm 55-265-385-115-105mm</p>		<p><b>R220510</b> NO. 11464032 - 6112689 - 84FB8260AA</p> <p>TUBO DE RADIADOR SUPERIOR</p> <p>FORD FIESTA I (GFBT) 0.9 05.1976/08.1983 29KW 40CV 957CC TKW TKA 0928475 7528301 - FORD FIESTA I (GFBT) 0.9 05.1976/08.1983 33KW 45CV 957CC TLA 0928476 7528302 - FORD FIESTA I (GFBT) 1.1 05.1976/08.1983 39KW 53CV 1117CC GLA 0928477 7528303 - FORD FIESTA II (FBD) 1.1 (FBD) 09.1983/02.1989 37KW 50CV 1117CC GSF GLC 0928582 7528312 - FORD FIESTA II (FBD) 1.1 (FBD) 05.1986/02.1989 36KW 49CV 1117CC GSH 0...</p> <p>B280-d32/32mm 80-145-145mm</p>
	<p><b>R220511</b> NO. 6133570 - 6139472</p> <p>TUBO DE RADIADOR INFERIOR</p> <p>FORD FIESTA I (GFBT) 0.9 05.1976/08.1983 29KW 40CV 957CC TKW TKA 0928475 7528301 - FORD FIESTA I (GFBT) 0.9 05.1976/08.1983 33KW 45CV 957CC TLA 0928476 7528302 - FORD FIESTA I (GFBT) 1.1 05.1976/08.1983 39KW 53CV 1117CC GLA 0928477 7528303 - FORD FIESTA II (FBD) 1.1 (FBD) 09.1983/02.1989 37KW 50CV 1117CC GSF GLC 0928582 7528312 - FORD FIESTA II (FBD) 1.1 (FBD) 05.1986/02.1989 36KW 49CV 1117CC GSH 0...</p> <p>B335-d31/31mm 85-225-70mm</p>		<p><b>R220512</b> NO. 4464791 - 6126535</p> <p>TUBO DE RADIADOR SUPERIOR</p> <p>FORD FIESTA II (FBD) 1.3 (FBD) 09.1983/01.1987 51KW 69CV 1298CC JPC 0928592 7528317 - FORD FIESTA II (FBD) 1.4 09.1983/01.1987 51KW 69CV 1392CC FUBA</p> <p>B240-d32/35mm 50-110-140mm</p>
	<p><b>R220514</b> NO. 6114422</p> <p>TUBO DE ENVIO DE ÁGUA AO AQUECIMENTO</p> <p>FORD FIESTA I (GFBT): 1.3 08.1977/08.1983 49KW 66CV 1297CC - FORD FIESTA II (FBD): 1.3 (FBD) 09.1983/01.1987 51KW 69CV 1298CC - FORD FIESTA II (FBD): 1.4 09.1983/01.1987 51KW 69CV 1392CC - FORD FIESTA II (FBD): 1.4 (FBD) 10.1986/02.1989 52KW 71CV 1392CC - FORD FIESTA II (FBD): 1.4 (FBD) 02.1987/02.1989 54KW 73CV 1392CC - FORD FIESTA II (FBD): 1.4 (FBD) 10.1985/11.1989 55KW 75CV 1392CC</p> <p>B220-d15/15mm 145-140-80mm</p>		<p><b>R220515</b> NO. 6114432</p> <p>TUBO DE RETORNO DA ÁGUA DO AQUECIMENTO</p> <p>FORD FIESTA I (GFBT) 1.3 08.1977/08.1983 49KW 66CV 1297CC J3E 0928494 7528304 - FORD FIESTA II (FBD) 1.3 (FBD) 09.1983/01.1987 51KW 69CV 1298CC JPC 0928592 7528317 - FORD FIESTA II (FBD) 1.4 09.1983/01.1987 51KW 69CV 1392CC FUBA - FORD FIESTA II (FBD) 1.4 (FBD) 10.1985/11.1989 55KW 75CV 1392CC FUB 0928614 7528321 - FORD FIESTA II (FBD) 1.4 (FBD) 10.1986/02.1989 52KW 71CV 1392CC F6CF6A 0928643 - FO...</p> <p>B435-d15/15mm 85-60-200-220-75mm</p>
	<p><b>R220910</b> NO. 6182772 - 6895396 - 89FB.8260.AC</p> <p>TUBO DE RADIADOR SUPERIOR</p> <p>FORD FIESTA III (GFJ) 1.0 03.1989/12.1995 33KW 45CV 1001CC TLB - FORD FIESTA III (GFJ) 1.1 03.1989/12.1995 37KW 50CV 1119CC G6A 2028321 0928712 0928785 7528368 7528345 - FORD FIESTA III (GFJ) 1.1 03.1989/12.1995 40KW 55CV 1119CC GUE GUD 2028320 0928711 0928784 7528367 7528344 - FORD FIESTA III (GFJ) 1.3 03.1989/12.1992 44KW 60CV 1299CC JBC 2028325 0928788 7528369</p> <p>B270-d30/30mm 70-85-210mm</p>		<p><b>R220911</b> NO. 6182778 - 6636802 - 6895397 - 89FB260AD - 89FB286AB - 89FB286AC - 89FB286AD - 89FB2860AD - 89FB286A</p> <p>TUBO DE RADIADOR INFERIOR</p> <p>FORD FIESTA III (GFJ) 1.0 03.1989/12.1995 33KW 45CV 1001CC TLB - FORD FIESTA III (GFJ) 1.1 03.1989/12.1995 37KW 50CV 1119CC G6A 2028321 0928712 0928785 7528368 7528345 - FORD FIESTA III (GFJ) 1.1 03.1989/12.1995 40KW 55CV 1119CC GUE GUD 2028320 0928711 0928784 7528367 7528344</p> <p>boca a boca 280 mm d1 25mm d2 27mm</p>
	<p><b>R220912</b> NO. 6187709 - 6895399</p> <p>TUBO DO DEPÓSITO DE REFRIGERAÇÃO AO RADIADOR</p> <p>FORD FIESTA III (GFJ) 1.0 03.1989/12.1995 33KW 45CV 1001CC TLB - FORD FIESTA III (GFJ) 1.1 03.1989/12.1995 37KW 50CV 1119CC G6A 2028321 0928712 0928785 7528368 7528345 - FORD FIESTA III (GFJ) 1.1 03.1989/12.1995 40KW 55CV 1119CC GUE GUD 2028320 0928711 0928784 7528367 7528344</p> <p>B465-d15/20mm 80-95-135-60-155-28mm</p>		<p><b>R220913</b> NO. 6182763 - 6711500</p> <p>TUBO DE LIGAÇÃO DO DEPÓSITO DE ARREFECIMENTO À BOMBA DE ÁGUA</p> <p>FORD FIESTA III 1.0 - 1.1 (03-1989 A 12-1995)</p> <p>B330-d9/7mm 100-175-90-75-50mm</p>

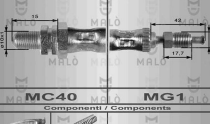
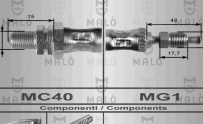
	<p><b>R220914</b> NO. 6186538</p> <p><b>TUBO DO AQUECIMENTO</b></p> <p>FORD FIESTA III (GFJ) 1.0 03.1989/12.1995 33KW 45CV 1001CC TLB - FORD FIESTA III (GFJ) - FORD FIESTA III (GFJ) 1.1 03.1989/12.1995 37KW 50CV 1119CC G6A 2028321 0928712 0928785 7528368 7528345 - FORD FIESTA III (GFJ) 1.1 03.1989/12.1995 40KW 55CV 1119CC GUE GUD 2028320 0928711 0928784 7528367 7528344</p> <p>B265-d15/15mm 70-160-90-90-75mm</p>		<p><b>R220915</b> NO. 6178704 - 6895394</p> <p><b>TUBO DE RETORNO DA ÁGUA AO DEPÓSITO DE ARREFECIMENTO</b></p> <p>FORD FIESTA III (GFJ) 1.1 03.1989/12.1995 37KW 50CV 1119CC G6A 2028321 0928712 0928785 7528368 7528345 - FORD FIESTA III (GFJ) 1.1 03.1989/12.1995 40KW 55CV 1119CC GUE GUD 2028320 0928711 0928784 7528367 7528344 - FORD FIESTA III (GFJ) 1.3 03.1989/12.1992 44KW 60CV 1299CC JBC 2028325 0928788 7528369</p> <p>B135-d16/16mm 55-55-50mm</p>
	<p><b>R220916</b> NO. 6178705 - 6895393</p> <p><b>TUBO DE RETORNO DE ÁGUA AO DEPÓSITO DE ARREFECIMENTO</b></p> <p>FORD FIESTA III (GFJ): 1.0 03.1989/12.1995 33KW 45CV 1001CC - FORD FIESTA III (GFJ): 1.1 03.1989/12.1995 37KW 50CV 1119CC - FORD FIESTA III (GFJ): 1.1 03.1989/12.1995 40KW 55CV 1119CC - FORD FIESTA III (GFJ): 1.3 03.1989/12.1992 44KW 60CV 1299CC</p> <p>B290-d17/16mm 65-130-70-130-80-70mm</p>		<p><b>R220921</b> NO. 6182777</p> <p><b>TUBO SUPERIOR DO RADIADOR</b></p> <p>FORD FIESTA Caixa (F3L, F5L) 1.8 D (De 1991.09 Até 1996.02) 44kW 60cv 1753cm3 Caixa - FORD FIESTA III (GFJ) 1.8 D (De 1989.03 Até 1995.12) 44kW 60cv 1753cm3 Hatchback -</p> <p>B380-30/32mm 48x285x48mm</p>
	<p><b>R220925</b> NO. 6663239 - 91FB8260AA</p> <p><b>TUBO SUPERIOR DO RADIADOR</b></p> <p>FORD FIESTA III (GFJ) 1.4 (De 1989.03 Até 1995.12) 52kW 71cv 1391cm3 Hatchback - FORD FIESTA III (GFJ) 1.4 (De 1989.03 Até 1995.12) 54kW 73cv 1391cm3 Hatchback - FORD FIESTA III (GFJ) 1.6 (De 1989.01 Até 1994.01) 65kW 88cv 1597cm3 Hatchback -</p> <p>B250-28/29mm 61x73x60x42mm</p>		<p><b>R220926</b> NO. 80-100-100-90mm+ch101-d16mm+ch410-d7mm...</p> <p><b>TUBO 4 VIAS INFERIOR DA SAÍDA DE ÁGUA DO RADIADOR</b></p> <p>FORD FIESTA III (GFJ) 1.4 03.1989/12.1995 52KW 71CV 1391CC F6E 2028324 0928716 7528349 - FORD FIESTA III (GFJ) 1.4 03.1989/12.1995 54KW 73CV 1392CC FUJ FUG F4A 0928713 2028361 7528346</p> <p>B250-d34/31mm 80-100-100-90mm+ch101-d16mm+ch410-d7mm...</p>
	<p><b>R220927</b> NO. 75-110-75mm + ch d16mm 65-155-140-</p> <p><b>TUBO DE RADIADOR INFERIOR COM 4 VIAS</b></p> <p>FORD FIESTA III (GFJ) 1.6 01.1989/01.1994 65KW 88CV 1597CC LUH 2028362 7528391 0928864</p> <p>B230-d32/32mm 75-110-75mm + ch d16mm 65-155-140-1</p>		<p><b>R221341</b> NO. 85x157x121x98x62x59mm ch-d32x65x37x54mm...</p> <p><b>TUBO INFERIOR DO RADIADOR</b></p> <p>FORD FIESTA III (GFJ) 1.8 16V (De 1992.02 Até 1995.12) 77kW 105cv 1796cm3 Hatchback -</p>
	<p><b>R221359</b> NO. 1040654 - 96FB8B274AG</p> <p><b>TUBO SUPERIOR DO RADIADOR</b></p> <p>FORD FIESTA III (GFJ) 1.3 Cat 05.1991/01.1997 44KW 60CV 1299CC J6B 2028325 0928788 7528369 - FORD FIESTA IV (JA_, JB_) 1.0 i 04.1996/09.1999 38KW 52CV 999CC ZH10 JRB - FORD FIESTA IV (JA_, JB_) 1.0 i 09.1999/01.2002 48KW 65CV 999CC C4E - FORD FIESTA IV (JA_, JB_) 1.3 i 08.1995/01.2002 37KW 50CV 1299CC JJC JJA JJM JJK JJJ JJE 0928928 0928932 - FORD FIESTA IV (JA_, JB_) 1.3 i 08.1995/01.2002 44KW 60...</p> <p>B340-d29/29mm 70-150-110-100mm + ch-d10mm 500mm</p>		<p><b>R221361</b> NO. 1041214 - 1106512</p> <p><b>TUBO DE LIGAÇÃO AO DEPOSITO AQUECIMENTO</b></p> <p>FORD FIESTA IV (JA_, JB_) 1.25 i 16V (De 08.1995 Até 01.2002) 55kW 75cv 1242cm3 Hatchback - FORD FIESTA IV (JA_, JB_) 1.4 i 16V (De 04.1996 Até 01.2002) 66kW 90cv 1388cm3 Hatchback -</p> <p>B894-6/9mm</p>
	<p><b>R221378</b> NO. 1514152 - 1704985 - 1827185 - 8V218B273BB - 8V218B273BC</p> <p><b>TUBO INFERIOR DO RADIADOR</b></p> <p>FORD FIESTA VI (CB1, CCN) 1.4 TDCi 08.2008/09.2012 50KW 68CV 1399CC F6JD F6JB 8566AOS - FORD FIESTA VI (CB1, CCN) 1.5 TDCi 09.2012/04.2017 55KW 75CV 1499CC XUJB XUJA UGJC 8566BGG - FORD FIESTA VI (CB1, CCN) 1.5 TDCi 05.2015/04.2017 70KW 95CV 1499CC XVJC XVJB 8566BKI - FORD FIESTA VI (CB1, CCN) 1.6 TDCi 06.2008/12.2012 55KW 75CV 1560CC UBJA HHJF 8566AQD - FORD FIESTA VI (CB1, CCN) 1.6 TDCi 06.2008/...</p> <p>B540-d28/d30mm 78-142-300-90-67mm</p>		<p><b>R221398</b> NO. 1007797</p> <p><b>TUBO LIGAÇÃO PERMUTADOR DE CALOR</b></p> <p>FORD FIESTA IV (JA_, JB_) 1.4 i 16V (De 1996.04 Até 2002.01) 66kW 90cv 1388cm3 Hatchback -</p> <p>B190-9/9mm 37-144-33mm ch-d16mm 24-25-20mm</p>
	<p><b>R221383</b> NO. 55-72-137-78-36-33-61-104mm ch-</p> <p><b>TUBO DO DEPOSITO EXPANSÃO AO RADIADOR</b></p> <p>FORD FIESTA VI (CB1, CCN) 1.4 até 12.2017 71KW 97CV 1388CC SPJA SPJC RTJB RTJA SPJE 8566AOQ - FORD FIESTA VI (CB1, CCN) 1.4 LPG 01.2009/04.2017 71KW 97CV 1388CC RTJA RTJB SPJA RTJD SPJE SPJC 8566AQW - FORD FIESTA VI (CB1, CCN) 1.6 Ti 06.2008/09.2012 88KW 120CV 1596CC HXJA HXJB HXJE RVJA 8566AOR - FORD FIESTA VI (CB1, CCN) 1.6 Ti 12.2010/04.2017 99KW 134CV 1596CC U5JA 8566AXL - FORD FIESTA VI (CB1, CCN)...</p> <p>B630-18/22mm 55-72-137-78-36-33-61-104mm ch-d36</p>		<p><b>R222329</b> NO. 1202492 - 2S6Q9C623BA</p> <p><b>TUBO ADMISSÃO FILTRO DE AR</b></p> <p>FORD FIESTA V (JH_, JD_) 1.4 TDCi 11.2001/06.2008 50KW 68CV 1399CC F6JA F6JB 8566489 8566516 8566ACS 8566ACK</p> <p>B170-40/44mm 110-45mm</p>
	<p><b>R221398</b> NO. 1007797</p> <p><b>TUBO LIGAÇÃO PERMUTADOR DE CALOR</b></p> <p>FORD FIESTA V (JH_, JD_) 1.4 16V (De 2001.11 Até 2008.06) 59kW 80cv 1388cm3 Hatchback -</p> <p>B190-9/9mm 37-144-33mm ch-d16mm 24-25-20mm</p>		<p><b>R222329</b> NO. 1202492 - 2S6Q9C623BA</p> <p><b>TUBO ADMISSÃO FILTRO DE AR</b></p> <p>FORD FIESTA V (JH_, JD_) 1.4 TDCi 11.2001/06.2008 50KW 68CV 1399CC F6JA F6JB 8566489 8566516 8566ACS 8566ACK</p> <p>B170-40/44mm 110-45mm</p>

	<p><b>R222329</b> NO. 1202492 - 2S6Q9C623BA</p> <p>TUBO ADMISSÃO FILTRO DE AR</p> <p>FORD FUSION (JU_) 1.4 TDCi 08.2002/12.2012 50KW 68CV 1399CC F6JA F6JB 8566502 8566ACC</p> <p>B170-40/44mm 110-45mm</p>		<p><b>R222388</b> NO. 49-230-55-73-111-48-68-137mm ch-d2</p> <p>TUBO RIGIDO DE REFRIGERAÇÃO</p> <p>FORD FIESTA V (JH_, JD_) 1.4 TDCi 11.2001/06.2008 50KW 68CV 1399CC F6JA F6JB 8566489 8566516 8566ACS 8566ACK - FORD FIESTA V Van 1.4 TDCi 10.2003/12.2010 50KW 68CV 1399CC F6JA F6JB 8566AMQ</p> <p>B556-22/32mm 49-230-55-73-111-48-68-137mm ch-d26-114-74-99-1</p>
	<p><b>R222388</b> NO. 49-230-55-73-111-48-68-137mm ch-d2</p> <p>TUBO RIGIDO DE REFRIGERAÇÃO</p> <p>FORD FIESTA VI (CB1, CCN) 1.4 TDCi 08.2008/09.2012 50KW 68CV 1399CC F6JD F6JB 8566AOS</p> <p>B556-22/32mm 49-230-55-73-111-48-68-137mm ch-d26-114-74-99-1</p>		<p><b>R222388</b> NO. 49-230-55-73-111-48-68-137mm ch-d2</p> <p>TUBO RIGIDO DE REFRIGERAÇÃO</p> <p>FORD FUSION (JU_) 1.4 TDCi 08.2002/12.2012 50KW 68CV 1399CC F6JA F6JB 8566502 8566ACC</p> <p>B556-22/32mm 49-230-55-73-111-48-68-137mm ch-d26-114-74-99-1</p>
	<p><b>R222394</b> NO. 1333636 - 2S6Q9C623CA</p> <p>TUBO ADMISSÃO FILTRO DE AR</p> <p>FORD FIESTA V (JH_, JD_) 1.4 TDCi 11.2001/06.2008 50KW 68CV 1399CC F6JA F6JB 8566489 8566516 8566ACS 8566ACK - FORD FIESTA VI (CB1, CCN) 1.4 TDCi 01.2009/09.2012 50KW 68CV 1399CC F6JD F6JB 8566AOS - FORD FIESTA VI (CB1, CCN) 1.4 TDCi 07.2010/09.2012 51KW 70CV 1399CC F6JD KVJA 8566AVO</p> <p>B155-40/43mm 97-49mm</p>		<p><b>R222394</b> NO. 1333636 - 2S6Q9C623CA</p> <p>TUBO ADMISSÃO FILTRO DE AR</p> <p>FORD FUSION (JU_) 1.4 TDCi 08.2002/12.2012 50KW 68CV 1399CC F6JA F6JB 8566502 8566ACC</p> <p>B155-40/43mm 97-49mm</p>
	<p><b>R222400</b> NO. 1059164 - 98FB8B874AB</p> <p>TUBO SUPERIOR DO RADIADOR</p> <p>FORD FIESTA IV (JA_, JB_) 1.0 i 04.1996/09.1999 38KW 52CV 999CC ZH10JRB - FORD FIESTA IV (JA_, JB_) 1.0 i 09.1999/01.2002 48KW 65CV 999CC C4E - FORD FIESTA IV (JA_, JB_) 1.3 i 08.1995/01.2002 37KW 50CV 1299CC JJC JJA JJM JJK JJJ JJE 0928928 0928932 - FORD FIESTA IV (JA_, JB_) 1.3 i 08.1995/01.2002 44KW 60CV 1299CC J4C J4J J4T J4R J4Q J4L J4M 0928929 0928933</p> <p>B295-d25/30mm 85-80-160mm</p>		<p><b>R222401</b> NO. 1037315 - 96FB8B274BE</p> <p>TUBO SUPERIOR DO RADIADOR</p> <p>FORD FIESTA III (GFJ) 1.6 i 16V 01.1994/12.1995 65KW 88CV 1597CC L1G 2028362 7528391 0928864 - FORD FIESTA IV (JA_, JB_) 1.25 i 16V 08.1995/01.2002 55KW 75CV 1242CC DHB DHA DHG DHE DHF DHD DHC 0928930 0928934 - FORD FIESTA IV (JA_, JB_) 1.4 i 16V 04.1996/01.2002 66K2 90CV 1388CC FHA FHE 0928956 0928954 - FORD FIESTA IV (JA_, JB_) 1.6 16V Sport 02.2000/01.2002 76KW 103CV 1596CC L1V L1T 8566455 8566...</p> <p>B390-d30/33mm 75-95-115-120-70mm</p>
	<p><b>R222401</b> NO. 1037315 - 96FB8B274BE</p> <p>TUBO SUPERIOR DO RADIADOR</p> <p>FORD PUMA (EC_) 1.4 16V 11.1997/10.2000 66KW 90CV 1388CC FHD FHF 8566340 - FORD PUMA (EC_) 1.7 16V 03.1997/06.2002 92KW 125CV 1679CC MHB MHA 8566310</p> <p>B390-d30/33mm 75-95-115-120-70mm</p>		<p><b>R222403</b> NO. 1010323 - 1023262 - 1037314 - 96FB8B273CD</p> <p>TUBO INFERIOR DO RADIADOR</p> <p>FORD FIESTA IV (JA_, JB_) 1.25 i 16V 08.1995/01.2002 55KW 75CV 1242CC DHB DHA DHG DHE DHF DHD DHC 0928930 0928934 - FORD FIESTA IV (JA_, JB_) 1.4 i 16V 04.1996/01.2002 66KW 90CV 1388CC FHA FHE 0928956 0928954 - FORD FIESTA IV (JA_, JB_) 1.6 16V Sport 02.2000/01.2002 76KW 103CV 1596CC L1V L1T 8566455 8566396</p> <p>B300-d34/32mm 80-50-210-95mm</p>
	<p><b>R222405</b> NO. 1049440 - 96FB8B274DB</p> <p>TUBO SUPERIOR DO RADIADOR</p> <p>FORD FIESTA Caixa/monovolume (J5_, J3_) 1.8 D 02.1996/04.2002 44KW 60CV 1753CC RTK RTJ 0928261 0928949 - FORD FIESTA Caixa/monovolume (JV_) D 1.8 05.1998/04.2002 44KW 60CV 1753CC RTJ RTK 0928260 - FORD FIESTA III (GFJ) 1.8 D 03.1989/12.1995 44KW 60CV 1753CC RTC RTG RTD 2028322 0928714 7528347 - FORD FIESTA IV (JA_, JB_) 1.8 D 08.1995/04.2000 44KW 60CV 1753CC RTK RTJ 0928931 0928935 - FORD FIESTA I...</p> <p>B380-d32/32mm 80-160-100-50-80mm</p>		<p><b>R222406</b> NO. 1049439 - 1086229 - XS6I8B273HA</p> <p>TUBO INFERIOR DO RADIADOR</p> <p>FORD FIESTA Caixa/monovolume (J5_, J3_) 1.8 D 02.1996/04.2002 44KW 60CV 1753CC RTK RTJ 0928261 0928949 - FORD FIESTA Caixa/monovolume (JV_) D 1.8 05.1998/04.2002 44KW 60CV 1753CC RTJ RTK 0928260 - FORD FIESTA IV (JA_, JB_) 1.8 D 08.1995/04.2000 44KW 60CV 1753CC RTK RTJ 0928931 0928935 - FORD FIESTA IV (JA_, JB_) 1.8 D 04.2000/01.2002 55KW 75CV 1753CC RTQ RTP RTN 8566394 8566395</p> <p>B255-d32/32mm 70-100-100-80-110mm</p>
	<p><b>R222407</b> NO. 1040652 - 96FB8B273DD</p> <p>TUBO INFERIOR DO RADIADOR</p> <p>FORD FIESTA IV (JA_, JB_) 1.25 i 16V 08.1995/01.2002 55KW 75CV 1242CC DHB DHA DHG DHE DHF DHD DHC 0928930 0928934 - FORD FIESTA IV (JA_, JB_) 1.4 i 16V 04.1996/01.2002 66KW 90CV 1388CC FHA FHE 0928956 0928954</p> <p>B245-d32/32mm 100-145-120mm</p>		<p><b>R223038</b> NO. 1148084 - 143413 - 1434F6 - 1670802 - 2S6Q9C623AA - 2S6Q9C623AB - SU00100657 - SU00100679</p> <p>TUBO ADMISSÃO FILTRO DE AR</p> <p>FORD FIESTA V (JH_, JD_) 1.4 TDCi 11.2001/06.2008 50KW 68CV 1399CC F6JA F6JB 8566489 8566516 8566ACS 8566ACK - FORD FIESTA VI (CB1, CCN) 1.4 TDCi 01.2009/09.2012 50KW 68CV 1399CC F6JD F6JB 8566AOS - FORD FIESTA VI (CB1, CCN) 1.4 TDCi 07.2010/09.2012 51KW 70CV 1399CC F6JD KVJA 8566AVO - FORD FIESTA VI Van 1.4 TDCi desde 01.2009 50K2 68CV 1399CC F6JD F6JB 8566AQM 8566AVJ 8566ATW - FORD FIESTA VI Van...</p> <p>B160-34/59mm 70-83-56mm ch-d19-52-56mm</p>
	<p><b>R223038</b> NO. 1148084 - 143413 - 1434F6 - 1670802 - 2S6Q9C623AA - 2S6Q9C623AB - SU00100657 - SU00100679</p> <p>TUBO ADMISSÃO FILTRO DE AR</p> <p>FORD FUSION (JU_) 1.4 TDCi 08.2002/12.2012 50KW 68CV 1399CC F6JA F6JB 8566502 8566ACC</p> <p>B160-34/59mm 70-83-56mm ch-d19-52-56mm</p>		<p><b>R224105</b> NO. 6135053 - 6136053 - 84FB8B081KB</p> <p>TUBO LIGAÇÃO AO DEPÓSITO COMPENSAÇÃO</p> <p>FORD FIESTA IV (JA_, JB_) 1.0 i 04.1996/09.1999 38KW 52CV 999CC ZH10JRB - FORD FIESTA IV (JA_, JB_) 1.0 i 09.1999/01.2002 48KW 65CV 999CC C4E</p> <p>B550-15/20mm 140-91-155-105-122-154-52mm</p>

	<p><b>R224109</b> NO. 1546447 - 256H8B273BE</p> <p>TUBO INFERIOR DO RADIADOR</p> <p>FORD FIESTA V (JH_, JD_) 1.4 TDCi (De 11.2001 Até 06.2008) 50kW 68cv 1399cm3 Hatchback -</p> <p>B425-23/25mm 73x82x152x65x54mm</p>		<p><b>R224109</b> NO. 1546447 - 256H8B273BE</p> <p>TUBO INFERIOR DO RADIADOR</p> <p>FORD FUSION (JU_) 1.4 TDCi (De 08.2002 Até 12.2012) 50kW 68cv 1399cm3 Combi -</p> <p>B425-23/25mm 73x82x152x65x54mm</p>
	<p><b>R224110</b> NO. 28-36-154-43-52-147mm ch-d27mm 81-</p> <p>TUBO LIGAÇÃO BOMBA DE ÁGUA</p> <p>FORD FIESTA V (JH_, JD_) 1.4 TDCi 11.2001/06.2008 50KW 68CV 1399CC F6JA F6JB 8566489 8566516 8566ACS 8566ACK - FORD FIESTA V Van 1.4 TDCi 10.2003/12.2010 50KW 68CV 1399CC F6JA F6JB 8566AMQ</p> <p>B565-29/29mm 28-36-154-43-52-147mm ch-d27mm 81-1</p>		<p><b>R224110</b> NO. 28-36-154-43-52-147mm ch-d27mm 81-</p> <p>TUBO LIGAÇÃO BOMBA DE ÁGUA</p> <p>FORD FIESTA VI (CB1, CCN) 1.4 TDCi 01.2009/09.2012 50KW 68CV 1399CC F6JD F6JB 8566AOS</p> <p>B565-29/29mm 28-36-154-43-52-147mm ch-d27mm 81-1</p>
	<p><b>R224110</b> NO. 28-36-154-43-52-147mm ch-d27mm 81-</p> <p>TUBO LIGAÇÃO BOMBA DE ÁGUA</p> <p>FORD FUSION (JU_) 1.4 TDCi 08.2002/12.2012 50KW 68CV 1399CC F6JA F6JB 8566502 8566ACC</p> <p>B565-29/29mm 28-36-154-43-52-147mm ch-d27mm 81-1</p>		<p><b>R224137</b> NO. 1231906 - 1252691 - 1314366 - 1346295 - 1439411 - 1496239 - 1525112 - 3M516C646AD - 3M516C646XB - 3M...</p> <p>TUBO DO AR SOBREALIMENTAÇÃO</p> <p>FORD FUSION (JU_) 1.4 (De 2002.08 Até 2012.12) 59KW 80cv 1388cm3 Combi -</p> <p>B425-42/25mm 82x144x67x106mm</p>
	<p><b>R224173</b> NO. 1546453 - 2S6H8B274BB</p> <p>TUBO SUPERIOR RADIADOR</p> <p>FORD FIESTA V (JH_, JD_) 1.4 TDCi (De 2001.11 Até 2008.06) 50kW 68cv 1399cm3 Hatchback -</p> <p>B340-22/25mm 34-35-174mm</p>		<p><b>R224173</b> NO. 1546453 - 2S6H8B274BB</p> <p>TUBO SUPERIOR RADIADOR</p> <p>FORD FUSION (JU_) 1.4 TDCi (De 2002.08 Até 2012.12) 50kW 68cv 1399cm3 Combi -</p> <p>B340-22/25mm 34-35-174mm</p>
	<p><b>R225015</b> NO. 1683553 - 9M5Q8K512AA</p> <p>TUBO RIGIDO DE REFRIGERAÇÃO</p> <p>FORD FIESTA VI (CB1, CCN) 1.4 TDCi 08.2008/09.2012 50KW 68CV 1399CC F6JD F6JB 8566AOS - FORD FIESTA VI (CB1, CCN) 1.4 TDCi 07.2010/09.2012 51KW 70CV 1399CC F6JD KVJA 8566AVO - FORD FIESTA VI Van 1.4 TDCi desde 01.2009 50KW 68CV 1399CC F6JD F6JB 8566AQM 8566AVJ 8566ATW - FORD FIESTA VI Van 1.4 TDCi desde 07.2010 51KW 70CV 1399CC F6JD KVJA 8566AVN</p> <p>B438-23/23mm 62x68x71mm ch-d30x106x119x119mm</p>		<p><b>R225015</b> NO. 1683553 - 9M5Q8K512AA</p> <p>TUBO RIGIDO DE REFRIGERAÇÃO</p> <p>FORD FUSION (JU_) 1.4 TDCi 08.2002/12.2012 50KW 68CV 1399CC F6JA F6JB 8566502 8566ACC</p> <p>B438-23/23mm 62x68x71mm ch-d30x106x119x119mm</p>
	<p><b>R225775</b> NO. 1710178 - 1710179 - AV216C646AD - AV216K863AE</p> <p>TUBO DO AR SOBREALIMENTAÇÃO</p> <p>FORD FIESTA VI (CB1, CCN) 1.5 TDCi 09.2012/04.2017 55KW 75CV 1499CC XUJB XUJA UGJC 8566BGG - FORD FIESTA VI (CB1, CCN) 1.5 TDCi 05.2015/04.2017 70KW 95CV 1499CC XVJC XVJB 8566BK1 - FORD FIESTA VI (CB1, CCN) 1.6 TDCi 02.2010/12.2015 70KW 95CV 1560CC T3JA TZJA TZJB 8566ATS</p> <p>B174-d47/d47mm 174mm</p>		<p><b>R227046</b> NO. 1604697 - 3396913 - 6047976 - 6051492 - 6079523 - 6115575 - 6126535 - 6136057 - 6136782</p> <p>TUBO SUPERIOR DO RADIADOR</p> <p>FORD FIESTA Caixa/parte traseira inclinada (FVD) 1.4 09.1986/09.1989 52KW 71CV 1392CC F6A - FORD FIESTA Caixa/parte traseira inclinada (FVD) 1.6 D 09.1983/09.1989 40KW 54CV 1608CC LTB - FORD FIESTA Caixa/parte traseira inclinada (WFVT) 1.0 (WFVT) 10.1977/11.1986 29KW 40CV 957CC TKA 7528001 - FORD FIESTA I (GFBT) 0.9 05.1976/08.1983 29KW 40CV 957CC TKW TKA 0928475 7528301 - FORD FIESTA I (GFBT) 0.9...</p> <p>B175-d30/d31mm 74-42-62mm</p>
	<p><b>R8135</b> NO. 6202491</p> <p>TUBO ACOPLAMENTO RADIADOR AQUECIMENTO</p> <p>FORD FIESTA III (GFJ) 1.8 D 03.1989/12.1995 44KW 60CV 1753CC RTC RTG RTD 2028322 0928714 7528347</p> <p>B360-16/16mm 60-40-150-180-100-60-90mm</p>		<p><b>R8140</b> NO. 6170465</p> <p>TUBO LIGAÇÃO CARBURADOR</p> <p>FORD FIESTA II (FBD) 1.3 (FBD) 09.1983/01.1987 51KW 69CV 1298CC JPC 0928592 7528317 - FORD FIESTA II (FBD) 1.4 (FBD) 10.1986/02.1989 52KW 71CV 1392CC F6C F6A 0928643 - FORD FIESTA II (FBD) 1.6 XR2 (FBD) 03.1984/02.1989 70KW 95CV 1597CC LUD 0928642 7528333 - FORD FIESTA II (FBD) 1.6 XR2 (FBD) 04.1984/02.1989 71KW 97CV 1597CC LUB 7528319</p> <p>B165-15/15mm 100-90-60mm</p>
	<p><b>R8140</b> NO. 6170465</p> <p>TUBO LIGAÇÃO CARBURADOR</p> <p>FORD FIESTA III (GFJ) 1.4 03.1989/12.1995 52KW 71CV 1391CC F6E 2028324 0928716 7528349</p> <p>B165-15/15mm 100-90-60mm</p>		<p><b>R8200</b> NO. 1251783 - 1366216 - 1430644 - 4M5G-6758-FA - 4M5G-6758-HA - 6G9G-6758-AA</p> <p>TUBO DO RESPIRO DO CARTER DA CABBOTA</p> <p>FORD FIESTA V (JH_, JD_)   IKON ST150 03.2005/06.2008 110KW 150CV 1999CC N4JB 8566591 8566ACP</p> <p>B117-14/14mm 37-62-38mm</p>

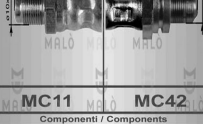
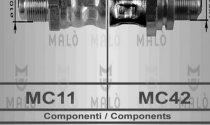
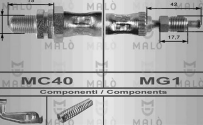
	<p><b>RF80124</b> NO. 6180946</p> <p>TUBO DE FERRO REFRIGERAÇÃO</p> <p>FORD FIESTA III (GFJ) 1.8 D (De 03-1989 Até 12-1995) 44kW 60CV 1753cc Hatchback</p> <p>B76-28/28mm ch-d12-62mm 2f-d8mm</p>		<p><b>RF80419</b> NO. 1104177 - 1139037 - 1461332 - XS4Q8K579CE - XS4Q8K579CF - XS4Q9N271CC</p> <p>TUBO DE FERRO REFRIGERAÇÃO</p> <p>FORD FIESTA IV (JA_ , JB_) 1.8 DI (De 04.2000 Até 01.2002) 55kW 75cv 1753cm3 Hatchback -</p> <p>B345-28/31mm 89x56x109x51x52mm ch-d21x25x109mm</p>
	<p><b>RT08222</b> NO. 1613347 - 1613348 - 5007396 - 6047604 - 6049556 - 77FB228KC</p> <p>TUBO DE TRAVÃO TRÁS LH-RH</p> <p>FORD FIESTA - FIESTA III 1.4 (03-1989 A 12-1995) - FIESTA III 1.4 CAT. (03-1989 A 12-1995) - FIESTA III 1.6 (01-1989 A 01-1994) - FIESTA III 1.6i 16V (01-1994 A 12-1995) - FIESTA III 1.6 TURBO (03-1990 A 10-1992) - FIESTA III 1.6 XR2i (03-1989 A 01-1994)</p> <p>315mm FB40 - FB40</p>		<p><b>RT08460</b> NO. 34321116515 - 6114613 - 84FB2078AA</p> <p>TUBO DE TRAVAO FRENTE LH-RH</p> <p>FORD FIESTA Caixa/parte traseira inclinada (FVD) 1.0 08.1983/11.1989 33KW 45CV 957CC TKB 7528005 - FORD FIESTA Caixa/parte traseira inclinada (FVD) 1.4 09.1986/09.1989 52KW 71CV 1392CC F6A - FORD FIESTA Caixa/parte traseira inclinada (FVD) 1.6 D 09.1983/09.1989 40KW 54CV 1608CC LTB - FORD FIESTA II (FBD) 1.0 (FBD) 09.1983/02.1989 33KW 45CV 957CC TKB 0928581 7528311 - FORD FIESTA II (FBD) 1.1 (FBD)...</p> <p>385mm MC11 - MC22</p>
	<p><b>RT08565</b> NO. 1027745 - 6132910 - 6179304 - 6714710 - 91FB2282AA</p> <p>TUBO DE TRAVÃO TRÁS LH-RH</p> <p>FORD FIESTA III - FIESTA IV TT (1989 A 07-1995)</p> <p>340mm MC40 - MC40</p>		<p><b>RT08580</b> NO. 1666294 - 6667473 - 91AB2282AD</p> <p>TUBO DE TRAVÃO TRÁS LH-RH</p> <p>FORD FIESTA 1.1 (02-1981 A 08-1983) - 1.8 16V (02-1992 A 12-1995)</p> <p>490mm MC11 - MC22</p>
	<p><b>RT08604</b> NO. 1016627 - 1021841 - 1033252 - 1036500 - 1066801 - 1109679 - 96FB2078CG - 96FB2078EA - 96FB2078J...</p> <p>TUBO DE TRAVÃO FRENTE RH</p> <p>FORD FIESTA Caixa/monovolume (J5_ , J3_ ) 1.3 02.1996/08.2003 44KW 60CV 1299CC J4C J4T J4J J4R J4L J4Q 0928262 0928948 - FORD FIESTA Caixa/monovolume (J5_ , J3_ ) 1.4 1.04.1996/10.1999 66KW 90CV 1388CC FHA 0928955 - FORD FIESTA Caixa/monovolume (J5_ , J3_ ) 1.8 D 02.1996/04.2002 44KW 60CV 1753CC RTK RTJ 0928261 0928949 - FORD FIESTA Caixa/monovolume (J5_ , J3_ ) 1.8 DI 09.2000/08.2003 55K2 75CV 1753CC RTP...</p> <p>415mm MC40 - MG1</p>		<p><b>RT08604</b> NO. 1016627 - 1021841 - 1033252 - 1036500 - 1066801 - 1109679 - 96FB2078CG - 96FB2078EA - 96FB2078J...</p> <p>TUBO DE TRAVÃO FRENTE LH</p> <p>FORD FIESTA IV (JA_ , JB_ ) 1.0 i 04.1996/09.1999 38KW 52CV 999CC ZH10JRB - FORD FIESTA IV (JA_ , JB_ ) 1.0 i 09.1999/01.2002 48KW 65CV 999CC C4E - FORD FIESTA IV (JA_ , JB_ ) 1.25 i 16V 08.1995/01.2002 55KW 75CV 1242CC DHB DHA DHG DHE DHF DHD DHC 0928930 0928934 - FORD FIESTA IV (JA_ , JB_ ) 1.3 i 08.1995/01.2002 37KW 50CV 1299CC JJC JJA JJM JJK JJJ JJE 0928928 0928932 - FORD FIESTA IV (JA_ , JB_ ) 1.3 i 0...</p> <p>415mm MC40 - MG1</p>
	<p><b>RT08604</b> NO. 1016627 - 1021841 - 1033252 - 1036500 - 1066801 - 1109679 - 96FB2078CG - 96FB2078EA - 96FB2078J...</p> <p>TUBO DE TRAVÃO FRENTE RH</p> <p>FORD PUMA (EC_ ) 1.4 16V 11.1997/10.2000 66KW 90CV 1388CC FHD FHF 8566340 - FORD PUMA (EC_ ) 1.6 16V 08.2000/06.2002 76KW 103CV 1596CC L1W 8566422 - FORD PUMA (EC_ ) 1.7 16V 03.1997/06.2002 92KW 125CV 1679CC MHB MHA 8566310 - FORD PUMA (EC_ ) Racing ST 160 06.1999/06.2002 114KW 155CV 1679CC MHA</p> <p>415mm MC40 - MG1</p>		<p><b>RT08605</b> NO. 1013815</p> <p>TUBO DE TRAVÃO FRENTE LH-RH</p> <p>FORD FIESTA III 1.0 (03-1989 A 12-1995) - 1.1 (03-1989 A 12-1995) - 1.3 (03-1989 A 12-1992) - 1.4 (03-1989 A 12-1995) - 1.6 (01-1989 A 01-1994) - 1.6i 16V (01-1994 A 12-1995) 1.6XRRI (03-1989 A 01-1994) - 1.8D (03-1989 A 12-1995)</p> <p>435mm MC11 - MC22</p>
	<p><b>RT08605</b> NO. 1013815</p> <p>TUBO DE TRAVÃO TRÁS LH</p> <p>FORD PUMA 1.4 16V (11-1997 A 10-2000) - 1.6 16V (APOS 08-2000) - 1.7 16V (APOS 03-1997)</p> <p>435mm MC11 - MC22</p>		<p><b>RT08605</b> NO. 1013815 - 1034192 - 6569119 - 7271916 - 96FB2078DA</p> <p>TUBO DE TRAVÃO FRENTE LH</p> <p>FORD COUGAR 2.0 16V (08-1998 A 12-2001) - COUGAR 2.5 ST 200 (01-2000 A 12-2001) - COUGAR 2.5 V6 24V (08-1998 A 12-2001)</p> <p>435mm MC11 - MC22</p>
	<p><b>RT08605</b> NO. 1013815 - 1034192 - 6569119 - 7271916 - 96FB2078DA</p> <p>TUBO DE TRAVÃO FRENTE LH</p> <p>FORD FIESTA FURGONATO 1.0 (10-1977 A 11-1989) - 1.1 (10-1977 A 11-1986) - FIESTA I 0.9 (05-1976 A 08-1983) - 1.1 (05-1976 A 08-1983) - 1.3 (08-1977 A 08-1983) - 1.6 XR2 (08-1981 A 08-1983) - FIESTA II 1.0 (09-1983 A 11-1989) - 1.1 (09-1983 A 02-1989) - 1.</p> <p>435mm MC11 - MC22</p>		<p><b>RT08607</b> NO. 1011342 - 1014204 - 96FB2282AC</p> <p>TUBO DE TRAVÃO TRÁS LH-RH</p> <p>FORD FIESTA IV (JA_ , JB_ ) 1.0 i 04.1996/09.1999 38KW 52CV 999CC ZH10JRB - FORD FIESTA IV (JA_ , JB_ ) 1.0 i 09.1999/01.2002 48KW 65CV 999CC C4E - FORD FIESTA IV (JA_ , JB_ ) 1.25 i 16V 08.1995/01.2002 55KW 75CV 1242CC DHB DHA DHG DHE DHF DHD DHC 0928930 0928934 - FORD FIESTA IV (JA_ , JB_ ) 1.3 i 08.1995/01.2002 37KW 50CV 1299CC JJC JJA JJM JJK JJJ JJE 0928928 0928932 - FORD FIESTA IV (JA_ , JB_ ) 1.3 i 0...</p> <p>335mm MC11 - MC42</p>
	<p><b>RT08607</b> NO. 1011342 - 1014204 - 96FB2282AC</p> <p>TUBO DE TRAVÃO TRÁS LH-RH</p> <p>FORD PUMA (EC_ ) 1.4 16V 11.1997/10.2000 66KW 90CV 1388CC FHD FHF 8566340 - FORD PUMA (EC_ ) 1.7 16V 03.1997/06.2002 92KW 125CV 1679CC MHB MHA 8566310 - FORD PUMA (EC_ ) Racing ST 160 06.1999/06.2002 114KW 155CV 1679CC MHA</p> <p>335mm MC11 - MC42</p>		<p><b>RT08687</b> NO. 1011341 - 1014201 - 1016623 - 1021839 - 1021841 - 1034192 - 1066796 - 1066801 - 1109678 - 1109679 ...</p> <p>TUBO DE TRAVÃO FRENTE LH</p> <p>FORD FIESTA Caixa/monovolume (J5_ , J3_ ) 1.3 02.1996/08.2003 44KW 60CV 1299CC J4C J4T J4J J4R J4L J4Q 0928262 0928948 - FORD FIESTA Caixa/monovolume (J5_ , J3_ ) 1.4 i 04.1996/10.1999 66KW 90CV 1388CC FHA 0928955 - FORD FIESTA Caixa/monovolume (J5_ , J3_ ) 1.8 D 02.1996/04.2002 44KW 60CV 1753CC RTK RTJ 0928261 0928949 - FORD FIESTA Caixa/monovolume (J5_ , J3_ ) 1.8 DI 09.2000/08.2003 55KW 75CV 1753CC RTP...</p> <p>415mm MC40 - MG1</p>



	<p><b>RT08687</b> NO. 1011341 - 1014201 - 1016623 - 1021839 - 1021841 - 1034192 - 1066796 - 1066801 - 1109678 - 1109679 ...</p> <p><b>TUBO DE TRAVÃO FRENTE LH</b></p> <p>FORD FIESTA IV (JA_ JB_) 1.0 i 04.1996/09.1999 38KW 52CV 999CC ZH10JRB - FORD FIESTA IV (JA_ JB_) 1.0 i 09.1999/01.2002 48KW 65CV 999CC C4E - FORD FIESTA IV (JA_ JB_) 1.25 i 16V 08.1995/01.2002 55KW 75CV 1242CC DHB DHA DHG DHE DHF DHD DHC 0928930 0928934 - FORD FIESTA IV (JA_ JB_) 1.3 i 08.1995/01.2002 37KW 50CV 1299CC JJC JJA JJM JJK JJJ JJE 0928928 0928932 - FORD FIESTA IV (JA_ JB_) 1.3 i 0...</p>		<p><b>RT08687</b> NO. 1011341 - 1014201 - 1016623 - 1021839 - 1021841 - 1034192 - 1066796 - 1066801 - 1109678 - 1109679 ...</p> <p><b>TUBO DE TRAVÃO FRENTE LH</b></p> <p>FORD PUMA (EC_) 1.4 16V 11.1997/10.2000 66KW 90CV 1388CC FHD FHF 8566340 - FORD PUMA (EC_) 1.6 16V 08.2000/06.2002 76KW 103CV 1596CC L1W 8566422 - FORD PUMA (EC_) 1.7 16V 03.1997/06.2002 92KW 125CV 1679CC MHB MHA 8566310 - FORD PUMA (EC_) Racing ST 160 06.1999/06.2002 114KW 155CV 1679CC MHA</p>
	<p><b>RT08914</b> NO. 1201141 - 1437504 - D43643980</p> <p><b>TUBO DE TRAVÃO FRENTE LH-RH</b></p> <p>FORD FIESTA V TT (APÓS 11-2001)</p>		<p><b>RT08970</b> NO. 1151027 - 1217819</p> <p><b>TUBO DE TRAVÃO TRÁS LH-RH</b></p> <p>FORD FIESTA V (APÓS 11-01) TT</p>
	<p><b>S1096</b> NO. 6042743 - 77FB3432AB</p> <p><b>SILENT-BLOC - CASQUILHO DO BRAÇO DA SUSPENSÃO DA FRENTE</b></p> <p>FORD FIESTA 0.9 - 1.1 - 1.3 - 1.4 - 1.6 (ATÉ 1989)</p>		<p><b>S1097</b> NO. 1619120 - 3240198 - 3246127 - 5021460 - 5021461 - 5021729 - 6042740 - 6087890 - 6090611 - 6114614 ...</p> <p><b>SILENT-BLOC DO TIRANTE DO BRAÇO DA SUSPENSÃO DA FRENTE</b></p> <p>FORD FIESTA 0.9 - 1.1 - 1.3 - 1.4 - 1.6 (ATÉ 1989)</p>
	<p><b>S1109</b> NO. 1035929 - 6193085-86 - 91AB3A262AA</p> <p><b>SILENT-BLOC DO BRAÇO FRENTE</b></p> <p>FORD FIESTA 0.9 - 1.1 - 1.3 - 1.4 - 1.6 - FIESTA DIESEL (APÓS 1989) - FORD KA 1.3i (1996 A 2002)</p>		<p><b>S1110</b> NO. 1000445 - 1829508 - 6193885-86 - 89FB.3063.A1D - 89FB.3063.AD - 89FB3063ADB492A - T128417</p> <p><b>SILENT-BLOC DO BRAÇO FRENTE</b></p> <p>FORD FIESTA (0.9 - 1.1 - 1.3 - 1.4 - 1.6) - FIESTA DIESEL DESDE 89</p>
	<p><b>S1259</b> NO. 6163419 - 6745350 - 91AB.5K653.BB</p> <p><b>SILENT-BLOC DA SUSPENSÃO DE TRÁS</b></p> <p>FORD FIESTA Caixa/monovolume (F3L, F5L)   COURIER 1.3 09.1991/02.1996 44KW 60CV 1299CC J6B 2028319 2028197 - FORD FIESTA Caixa/monovolume (F3L, F5L)   COURIER 1.8 D 09.1991/02.1996 44KW 60CV 1753CC RTD RTG RTC 2028318 2028196 - FORD FIESTA III (GFJ) 1.0 03.1989/12.1995 33KW 45CV 1001CC TLB - FORD FIESTA III (GFJ) 1.1 03.1989/12.1995 37KW 50CV 1119CC G6A 2028321 0928712 0928785 7528368 7528345 - FO...</p>		<p><b>S1264</b> NO. 1014654 - 1063372 - 1E01-34-153A - 96FB3A262AD - 96FB.3A262.AA</p> <p><b>SILENT-BLOC DO BRAÇO DA SUSPENSÃO FRENTE PARTE DE TRÁS</b></p> <p>FORD FIESTA Caixa/monovolume (J5_ J3_)   COURIER 1.3 02.1996/08.2003 44KW 60CV 1299CC J4C J4T J4J J4R J4L J4Q 0928262 0928948 - FORD FIESTA Caixa/monovolume (J5_ J3_)   COURIER 1.4 i 04.1996/10.1999 66KW 90CV 1388CC FHA 0928955 - FORD FIESTA Caixa/monovolume (J5_ J3_)   COURIER 1.8 D 02.1996/04.2002 44KW 60CV 1753CC RTK RTJ 0928261 0928949 - FORD FIESTA Caixa/monovolume (J5_ J3_)   COURIER 1.8...</p>
	<p><b>S1265</b> NO. 1010037 - 1055191 - 1E00-34-153A - 96FB3063AB - 96FB.3063.AA</p> <p><b>SILENT-BLOC DO BRAÇO DA SUSPENSÃO FRENTE PARTE DA FRENTE</b></p> <p>FORD FIESTA Caixa/monovolume (J5_ J3_)   COURIER 1.3 02.1996/08.2003 44KW 60CV 1299CC J4C J4T J4J J4R J4L J4Q 0928262 0928948 - FORD FIESTA Caixa/monovolume (J5_ J3_)   COURIER 1.4 i 04.1996/10.1999 66KW 90CV 1388CC FHA 0928955 - FORD FIESTA Caixa/monovolume (J5_ J3_)   COURIER 1.8 D 02.1996/04.2002 44KW 60CV 1753CC RTK RTJ 0928261 0928949 - FORD FIESTA Caixa/monovolume (J5_ J3_)   COURIER 1.8...</p>		<p><b>S1274</b> NO. 77TT7L259AF</p> <p><b>SILENT-BLOC REPARAÇÃO DA CAIXA DE VELOCIDADES</b></p> <p>FORD FIESTA</p>
	<p><b>S1418</b> NO. 1146160 - 1198236 - 1203039 - 1204338 - 1426699 - 2S61.5K653.AA - 2S61.5K653.AB - 2S61.5K653....</p> <p><b>SILENT BLOC DA SUSPENSÃO DE TRÁS</b></p> <p>FORD FIESTA V (APÓS 11-2001) - FUSION</p>		<p><b>S1442</b> NO. 1146131 - 1207448 - 121280752 - 1212809 - 2S613A262AD</p> <p><b>SILENT-BLOC DO BRAÇO DA SUSPENSÃO DA FRENTE PARTE EXTERNA</b></p> <p>FORD FIESTA (APÓS 2002) - FORD FUSION (APÓS 2002)</p>
	<p><b>S1449</b> NO. 1212807 - 121280751 - 2S613063CA</p> <p><b>SILENT-BLOC DO BRAÇO DA SUSPENSÃO DA FRENTE PARTE INTERNA</b></p> <p>FORD FIESTA (APÓS 2002) - FORD FUSION (APÓS 2002)</p>		<p><b>S1477</b> NO. 1041979 - 1S655K653AA - 4377687 - 7215747 - 7371059 - 95AB5K653CA - 97AG5K653AA - AB5K653AC</p> <p><b>SILENT BLOC DO EIXO TRASEIRO</b></p> <p>FORD FIESTA IV 1.0i - 1.25i 16V - 1.3i - 1.4i 16V - 1.6 16V SPORT - 1.8D - 1.8Di (1995 A 2002)</p>

	<p><b>S1576</b> NO. 1535296 - 1775568 - 1805815 - 8V51K155AA - 8V51K653AA - 8V51K653BA - D65128460</p> <p><b>SILENTBLOC SUSPENSÃO TRÁS</b></p> <p>FORD FIESTA VI 1.0 (A Partir de 01.13) 65cv 998cc Hatchback - FORD FIESTA VI 1.0 (A Partir de 10.12) 80cv 998cc Hatchback - FORD FIESTA VI 1.0 EcoBoost (A Partir de 01.13) 100cv 998cc Hatchback - FORD FIESTA VI 1.0 EcoBoost (A Partir de 09.12) 125cv 998cc Hatchback - FORD FIESTA VI 1.0 Sport (A Partir de 05.14) 140cv 998cc Hatchback - FORD FIESTA VI 1.25 (A Partir de 06.08) 60cv 1242cc ...</p> <p>d80x78mm c49mm d77mm 1f-d12mm</p>		<p><b>S1678</b> NO. 1067918 - 1149932 - 1149933 - 1209076 - 1209077 - 1212807 - 1212808 - 1332454 - 1332455 - 1355048 - ...</p> <p><b>SILENT-BLOC DO BRAÇO SUSPENSÃO FRENTE (SUPLENTE DO S1262)</b></p> <p>FORD FIESTA V (JH_, JD_) 1.3 (11.01 A 06.08) 60cv 1299cc Hatchback - FORD FIESTA V (JH_, JD_) 1.3 (11.01 A 06.08) 69cv 1299cc Hatchback - FORD FIESTA V (JH_, JD_) 1.4 16V (11.01 A 06.08) 80cv 1388cc Hatchback - FORD FIESTA V (JH_, JD_) 1.6 16V (11.01 A 06.08) 100cv 1596cc Hatchback - FORD FIESTA V (JH_, JD_) ST150 (03.05 A 06.08) 150cv 1999cc Hatchback - FORD FIESTA V (JH_, JD_) 1.4 TDCi (11....</p> <p>d57x65mm c55mm 1f-d22mm</p>
	<p><b>S1678</b> NO. 1067918 - 1149932 - 1149933 - 1209076 - 1209077 - 1212807 - 1212808 - 1332454 - 1332455 - 1355048 - ...</p> <p><b>SILENT-BLOC DO BRAÇO SUSPENSÃO FRENTE (SUPLENTE DO S1262)</b></p> <p>FORD FUSION (JU_) 1.4 (08.02 A 12.12) 80cv 1388cc Combi - FORD FUSION (JU_) 1.4 LPG (01.10 A 12.12) 80cv 1388cc Combi - FORD FUSION (JU_) 1.6 (08.02 A 11.08) 100cv 1596cc Combi - FORD FUSION (JU_) 1.4 TDCi (08.02 A 12.12) 68cv 1399cc Combi - FORD FUSION (JU_) 1.6 TDCi (11.04 A 12.12) 90cv 1560cc Combi</p> <p>d57x65mm c55mm 1f-d22mm</p>		<p><b>S1985</b> NO. 1540725 - 1712696 - 1712697 - 1737309 - 7250525</p> <p><b>SILENT-BLOC DO BRAÇO SUSPENSÃO FRENTE PARTE TRÁS</b></p> <p>FORD FIESTA V Van 1.4 TDCi (De 10.2003 Até 12.2010) 50kW 68cv 1399cm3 Caixa/parte traseira inclinada - FORD FIESTA V Van 1.6 TDCi (De 04.2007 Até 09.2009) 66kW 90cv 1560cm3 Caixa/parte traseira inclinada -</p> <p>d68x52mm c-32mm dc-61mm1f-d12mm</p>
	<p><b>S1985</b> NO. 1540725 - 1712696 - 1712697 - 1737309 - 7250525</p> <p><b>SILENT-BLOC DO BRAÇO SUSPENSÃO FRENTE PARTE TRÁS</b></p> <p>FORD FIESTA VI (CB1, CCN) 1.0 (De 01.2013 -) 48kW 65cv 998cm3 Hatchback - FORD FIESTA VI (CB1, CCN) 1.0 (De 10.2012 -) 59kW 80cv 998cm3 Hatchback - FORD FIESTA VI (CB1, CCN) 1.0 EcoBoost (De 01.2013 -) 74kW 100cv 998cm3 Hatchback - FORD FIESTA VI (CB1, CCN) 1.0 EcoBoost (De 09.2012 -) 92kW 125cv 998cm3 Hatchback - FORD FIESTA VI (CB1, CCN) 1.0 Sport (De 05.2014 -) 103kW 140cv 998cm3 Hatchback - FO...</p> <p>d68x52mm c-32mm dc-61mm1f-d12mm</p>		<p><b>S1985</b> NO. 1540725 - 1712696 - 1712697 - 1737309 - 7250525</p> <p><b>SILENT-BLOC DO BRAÇO SUSPENSÃO FRENTE PARTE TRÁS</b></p> <p>FORD FIESTA VII Van 1.0 EcoBoost (De 04.2019 -) 74kW 101cv 998cm3 Caixa/parte traseira inclinada - FORD FIESTA VII Van 1.0 EcoBoost (De 09.2018 -) 92kW 125cv 998cm3 Caixa/parte traseira inclinada - FORD FIESTA VII Van 1.0 EcoBoost (De 04.2019 -) 103kW 140cv 998cm3 Caixa/parte traseira inclinada - FORD FIESTA VII Van 1.5 TDCi (De 04.2019 -) 63kW 86cv 1499cm3 Caixa/parte traseira inclinada - FORD FI...</p> <p>d68x52mm c-32mm dc-61mm1f-d12mm</p>
	<p><b>S1986</b> NO. 1540724 - 1540725 - 1712696 - 1737305 - 1737309 - 7250481</p> <p><b>SILENT-BLOC DO BRAÇO SUSPENSÃO FRENTE PARTE DA FRENTE</b></p> <p>FORD FIESTA V Van 1.4 TDCi (De 10.2003 Até 12.2010) 50kW 68cv 1399cm3 Caixa/parte traseira inclinada - FORD FIESTA V Van 1.6 TDCi (De 04.2007 Até 09.2009) 66kW 90cv 1560cm3 Caixa/parte traseira inclinada -</p> <p>d35x54mm d35mm 1f-d12mm</p>		<p><b>S1986</b> NO. 1540724 - 1540725 - 1712696 - 1737305 - 1737309 - 7250481</p> <p><b>SILENT-BLOC DO BRAÇO SUSPENSÃO FRENTE PARTE DA FRENTE</b></p> <p>FORD FIESTA VI (CB1, CCN) 1.0 (De 01.2013 -) 48kW 65cv 998cm3 Hatchback - FORD FIESTA VI (CB1, CCN) 1.0 (De 10.2012 -) 59kW 80cv 998cm3 Hatchback - FORD FIESTA VI (CB1, CCN) 1.0 EcoBoost (De 01.2013 -) 74kW 100cv 998cm3 Hatchback - FORD FIESTA VI (CB1, CCN) 1.0 EcoBoost (De 09.2012 -) 92kW 125cv 998cm3 Hatchback - FORD FIESTA VI (CB1, CCN) 1.0 Sport (De 05.2014 -) 103kW 140cv 998cm3 Hatchback - FO...</p> <p>d35x54mm d35mm 1f-d12mm</p>
	<p><b>S1986</b> NO. 1540724 - 1540725 - 1712696 - 1737305 - 1737309 - 7250481</p> <p><b>SILENT-BLOC DO BRAÇO SUSPENSÃO FRENTE PARTE DA FRENTE</b></p> <p>FORD FIESTA VII Van 1.0 EcoBoost (De 04.2019 -) 74kW 101cv 998cm3 Caixa/parte traseira inclinada - FORD FIESTA VII Van 1.0 EcoBoost (De 09.2018 -) 92kW 125cv 998cm3 Caixa/parte traseira inclinada - FORD FIESTA VII Van 1.0 EcoBoost (De 04.2019 -) 103kW 140cv 998cm3 Caixa/parte traseira inclinada - FORD FIESTA VII Van 1.5 TDCi (De 04.2019 -) 63kW 86cv 1499cm3 Caixa/parte traseira inclinada - FORD FI...</p> <p>d35x54mm d35mm 1f-d12mm</p>		<p><b>S1997</b> NO. 1518904 - 1520778 - 1521773 - 1532421 - 1532433 - 1540724 - 1540725 - 1700809 - 1700810</p> <p><b>SILENT-BLOC DO BRAÇO SUSPENSÃO DA FRENTE PARTE DA FRENTE</b></p> <p>FORD FIESTA VI (CB1, CCN) 1.0 (De 01.2013 -) 48kW 65cv 998cm3 Hatchback - FORD FIESTA VI (CB1, CCN) 1.0 (De 10.2012 -) 59kW 80cv 998cm3 Hatchback - FORD FIESTA VI (CB1, CCN) 1.0 EcoBoost (De 01.2013 -) 74kW 100cv 998cm3 Hatchback - FORD FIESTA VI (CB1, CCN) 1.0 EcoBoost (De 09.2012 -) 92kW 125cv 998cm3 Hatchback - FORD FIESTA VI (CB1, CCN) 1.0 Sport (De 05.2014 -) 103kW 140cv 998cm3 Hatchback - FO...</p> <p>d61x52mm c36mm 1f-d12mm</p>
	<p><b>S1998</b> NO. 1518904 - 1520778 - 1521773 - 1532421 - 1532433 - 1540724 - 1540725 - 1700809 - 1700810</p> <p><b>SILENT-BLOC DO BRAÇO SUSPENSÃO DA FRENTE PARTE DE TRÁS</b></p> <p>FORD FIESTA VI (CB1, CCN) 1.0 (De 01.2013 -) 48kW 65cv 998cm3 Hatchback - FORD FIESTA VI (CB1, CCN) 1.0 (De 10.2012 -) 59kW 80cv 998cm3 Hatchback - FORD FIESTA VI (CB1, CCN) 1.0 EcoBoost (De 01.2013 -) 74kW 100cv 998cm3 Hatchback - FORD FIESTA VI (CB1, CCN) 1.0 EcoBoost (De 09.2012 -) 92kW 125cv 998cm3 Hatchback - FORD FIESTA VI (CB1, CCN) 1.0 Sport (De 05.2014 -) 103kW 140cv 998cm3 Hatchback - F...</p> <p>d37x53mm d31mm 1f-d12mm</p>		<p><b>S1998</b> NO. D65134300 - D65134300B - D65134300C - D65134300D - D65134350 - D65134350B</p> <p><b>SILENT-BLOC DO BRAÇO SUSPENSÃO DA FRENTE PARTE DE TRÁS</b></p> <p>MAZDA 2 (DE_, DH_) 1.3 (DE3FS) (De 10.2007 Até 06.2015) 55kW 75cv 1349cm3 Hatchback - MAZDA 2 (DE_, DH_) 1.3 (DE3FS) (De 10.2007 Até 06.2015) 63kW 86cv 1349cm3 Hatchback - MAZDA 2 (DE_, DH_) 1.3 BiFuel (De 05.2011 Até 11.2014) 55kW 75cv 1349cm3 Hatchback - MAZDA 2 (DE_, DH_) 1.3 MZR (DE3FS) (De 01.2010 Até 06.2015) 62kW 84cv 1349cm3 Hatchback - MAZDA 2 (DE_, DH_) 1.4 MZR-CD (De 01.2008 Até 06.2011...</p> <p>d37x53mm d31mm 1f-d12mm</p>
	<p><b>T0034</b> NO. 1145272 - 1E0034156A - 6185809 - 6543416 - 7102392 - 8200024373 - 89FB5474BA - 94AB5484AB</p> <p><b>BATENTE DA BARRA ESTABILIZADORA DA SUSPENSÃO TRÁS DIAM. 16mm</b></p> <p>FORD FIESTA III (GFJ) 1.0 03.1989/12.1995 33KW 45CV 1001CC TLB - FORD FIESTA III (GFJ) 1.1 03.1989/12.1995 37KW 50CV 1119CC G6A 2028321 0928712 0928785 7528368 7528345 - FORD FIESTA III (GFJ) 1.1 03.1989/12.1995 40KW 55CV 1119CC GUE GUD 2028320 0928711 0928784 7528367 7528344 - FORD FIESTA III (GFJ) 1.3 03.1989/12.1992 44KW 60CV 1299CC JBC 2028325 0928788 7528369 - FORD FIESTA III (GFJ) 1.3 03.198...</p> <p>41x38x32mm 1f-d16mm</p>		<p><b>T0605-I</b> NO. 6532212 - 90BB.3025.AA - 97FU.3025.AA</p> <p><b>BATENTE DA SUSPENSÃO DA FRENTE</b></p> <p>FORD FIESTA III 1.1 - 1.4 - 1.6 - 1.6i 16V (1989 A 1995) - FIESTA IV 1.0i - 1.25i 16V - 1.3i - 1.4i 16V - 1.8D (1995 A 2002) - FORD KA 1.0i (1997 A 1999) - FORD PUMA 1.7 16V (APÓS 03-1997</p> <p>d50x69mm 1f-d22mm 1f-d18mm</p>
	<p><b>T0720-I</b> NO. 2S615K570CA</p> <p><b>BATENTE DA SUSPENSÃO DE TRÁS</b></p> <p>FORD FIESTA V (JH_, JD_) 1.25 16V (De 2003.03 Até 2008.06) 51kW 70cv 1242cm3 Hatchback - FORD FIESTA V (JH_, JD_) 1.25 16V (De 2002.05 Até 2008.06) 55kW 75cv 1242cm3 Hatchback - FORD FIESTA V (JH_, JD_) 1.3 (De 2001.11 Até 2008.06) 44kW 60cv 1299cm3 Hatchback - FORD FIESTA V (JH_, JD_) 1.3 (De 2001.11 Até 2008.06) 51kW 69cv 1299cm3 Hatchback -</p> <p>65x40x25mm 1f-d13mm 1f-d16mm</p>		<p><b>T1030F11</b> NO. 6046476</p> <p><b>BATENTE BARRA ESTABILIZADORA (CENTRO)</b></p> <p>FORD FIESTA 1.0 - 1.1 - 1.3 - 1.4 - 1.6 - 1.6i 16V - 1.8D (1989 A 1995) - FORD COURIER 1.8D (09-1991 - A 02-1996)</p> <p>32x32x27mm 1f-d11mm</p>

	<p><b>T1030F12</b> NO. 1652936                      BATENTE BARRA ESTABILIZADORA (CENTRO)                      FORD FIESTA III 1.0 - 1.1 - 1.3 - 1.4 - 1.6 - 1.6i 16V - 1.8D (1989 A 1995) - FORD COURIER 1.8D (09-1991 A 02-1996)+F525</p>		<p><b>T1030F15</b> NO. 6057572 - 6057749 - 6154572 - 7144201 - 77AB4A037BB - 934A037EA                      BATENTE DA BARRA ESTABILIZADORA                      FORD FIESTA - MONDEO (APÓS 1996)</p>
	<p><b>T1045</b> NO. 1003609 - 96FB5484CA                      BATENTE DA BARRA ESTABILIZADORA FRENTE CENTRO                      FORD FIESTA IV 1.0i - 1.25i 16V - 1.3i - 1.4i 16V - 1.6 16V SPORT - 1.8D (1995 A 2002) - FORD KA 1.0i - 1.3i (1996 A 2002)</p>		<p><b>T1050</b> NO. 1128725 - 1145272 - 1E00-34-156 - 6076407 - 6185809 - 6543416 - 7102392 - 81AB5484BA - 94AB.548...                      BATENTE DO CENTRO DA BARRA ESTABILIZADORA                      FORD FIESTA 1.0 - 1.1 - 1.3 - 1.4 - 1.6 - 1.6i 16V - 1.8 16V - 1.8D (1989 A 1995) - FIESTA IV 1.4i 16V - 1.8D (1995 A 2002) - FORD PUMA 1.7 16V (APOS 03-1997)</p>
	<p><b>T1053F14</b> NO. 6154572                      BATENTE DA BARRA ESTABILIZADORA                      FORD FIESTA</p>		<p><b>T1111</b> NO. 1152852 - 1334004 - 2S615484DA - DD32-34-156                      BATENTE DA BARRA ESTABILIZADORA DA FRENTE                      FORD FIESTA V (APÓS 11-01) - FUSION (APÓS 2002)</p>
	<p><b>T1135</b> NO. 1514533 - 1514536 - 1528314 - 8V515484AA - 8V515484AB - 8V515484BA                      BATENTE DA BARRA ESTABILIZADORA DA FRENTE                      FORD FIESTA VI 1.25 Hatchback (APÓS 06.08) 60cv 1242cc - FORD FIESTA VI 1.25 Hatchback (APÓS 06.08) 82cv 1242cc - FORD FIESTA VI 1.4 Hatchback (APÓS 06.08) 97cv 1388cc - FORD FIESTA VI 1.4 LPG Hatchback (APÓS 01.09) 97cv 1388cc - FORD FIESTA VI 1.6 Ti Hat</p>		<p><b>U7033K</b> NO. 1212679 - 1212679 - 1332662 - 1474287 - 1S7C-3334-AA - 3M51-3334-AA                      ORINGS BOMBA DIREÇÃO ASSITIDA                      FORD FIESTA VI (CB1, CCN) 1.25 (06.2008 -04.2017) 44kw 60cv 1242cm3 Hatchback FORD FIESTA VI (CB1, CCN) 1.25 (06.2008 -04.2017) 60kw 82cv 1242cm3 Hatchback FORD FIESTA VI (CB1, CCN) 1.4 (10.2008 -04.2017) 71kw 97cv 1388cm3 Hatchback FORD FIESTA VI (CB1, CCN) 1.4 LPG (01.2009 -04.2017) 68kw 92cv 1388cm3 Hatchback FORD FIESTA VI (CB1, CCN) 1.4 LPG (01.2009 -04.2017) 71kw 97cv 1388cm3 Hatchback FORD...</p>
	<p><b>U7033K</b> NO. 1212679 - 1212679 - 1332662 - 1474287 - 1S7C-3334-AA - 3M51-3334-AA                      ORINGS BOMBA DIREÇÃO ASSITIDA                      FORD FIESTA V (JH_, JD_) 1.25 16V (03.2003 -06.2008) 51kw 70cv 1242cm3 Hatchback FORD FIESTA V (JH_, JD_) 1.25 16V (05.2002 -06.2008) 55kw 75cv 1242cm3 Hatchback FORD FIESTA V (JH_, JD_) 1.3 (11.2001 -06.2008) 44kw 60cv 1299cm3 Hatchback FORD FIESTA V (JH_, JD_) 1.3 (11.2001 -06.2008) 51kw 69cv 1299cm3 Hatchback FORD FIESTA V (JH_, JD_) 1.4 16V (11.2001 -06.2008) 59kw 80cv 1388cm3 Hatchback FORD ...</p>		<p><b>UAP81291</b> NO. 1148074 - 1348625 - 2S6Q9E568AA - 2S6Q9E568AB                      ANILHA PROTEÇÃO TÉRMICA INJECTORES                      FORD FIESTA V (JH_ - JD_) 1.4 TDCi (De 11-2001 Até 06-2008) 50kW 68CV 1399cc Hatchback - FORD FIESTA V Van 1.4 TDCi (De 10-2003 Até 12-2010) 50kW 68CV 1399cc Caixa</p>
	<p><b>UAP81291</b> NO. 1148074 - 1348625 - 2S6Q9E568AA - 2S6Q9E568AB                      ANILHA PROTEÇÃO TÉRMICA INJECTORES                      FORD FIESTA VI (CB1 - CCN) 1.4 TDCi (De 01-2009 Até ...) 50kW 68CV 1399cc Hatchback FORD FIESTA VI (CB1 - CCN) 1.4 TDCi (De 07-2010 Até .1-20 -) 51kW 70CV 1399cc Hatchback - FORD FIESTA VI Van 1.4 TDCi (De 01-2009 Até ...) 50kW 68CV 1399cc Caixa FORD FIESTA VI Van 1.4 TDCi (De 07-2010 Até .1-20 -) 51kW 70CV 1399cc Caixa</p>		<p><b>UAP81291</b> NO. 1148074 - 1348625 - 2S6Q9E568AA - 2S6Q9E568AB                      ANILHA PROTEÇÃO TÉRMICA INJECTORES                      FORD FIESTA V (JU_) 1.4 TDCi (De 08-2002 Até 12-2012) 50kW 68CV 1399cc Combi</p>
	<p><b>UAP83244</b> NO. 1230952 - 1432205 - 3M5QE568AA - M5Q9E568CA                      ANILHA PROTEÇÃO TÉRMICA INJECTORES                      FORD FIESTA V (JH_ - JD_) 1.6 TDCi (De 11-2004 Até 06-2008) 66kW 90CV 1560cc Hatchback</p>		<p><b>UAP83244</b> NO. 1230952 - 1432205 - 3M5QE568AA - M5Q9E568CA                      ANILHA PROTEÇÃO TÉRMICA INJECTORES                      FORD FIESTA VI (CB1 - CCN) 1.5 TDCi (De 09-2012 Até .1-20 -) 55kW 75CV 1499cc Hatchback FORD FIESTA VI (CB1 - CCN) 1.5 TDCi (De 05-2015 Até .1-20 -) 70kW 95CV 1499cc Hatchback FORD FIESTA VI (CB1 - CCN) 1.6 TDCi (De 06-2008 Até ...) 55kW 75CV 1560cc Hatchback FORD FIESTA VI (CB1 - CCN) 1.6 TDCi (De 06-2008 Até ...) 66kW 90CV 1560cc Hatchback FORD FIESTA VI (CB1 - CCN) 1.6 TDCi (De 02-2010 Até .1-20 -)</p>
	<p><b>UAP83244</b> NO. 1230952 - 1432205 - 3M5QE568AA - M5Q9E568CA                      ANILHA PROTEÇÃO TÉRMICA INJECTORES                      FORD FIESTA VII 1.5 TDCi (De 01-2017 Até .1-20 -) 63kW 85CV 1499cc Hatchback FORD FIESTA VII 1.5 TDCi (De 01-2017 Até .1-20 -) 88kW 120CV 1499cc Hatchback</p>		<p><b>UAP83244</b> NO. 1230952 - 1432205 - 3M5QE568AA - M5Q9E568CA                      ANILHA PROTEÇÃO TÉRMICA INJECTORES                      FORD FIESTA VII 1.5 TDCi (De 01-2017 Até .1-20 -) 63kW 85CV 1499cc Hatchback FORD FIESTA VII 1.5 TDCi (De 01-2017 Até .1-20 -) 88kW 120CV 1499cc Hatchback</p>

	<b>UAP83255</b> NO. 1118410 - YS4Q9E568AA <b>ANILHA PROTEÇÃO TÉRMICA INJECTORES</b> FORD FIESTA Caixa/monovolume (J5_ J3_)   COURIER 1.8 DI 09.2000/08.2003 55KW 75CV 1753CC RTP RTN 8566034 - FORD FIESTA Caixa/parte traseira inclinada (JV_)   COURIER TD 1.8 03.2000/08.2003 55KW 75CV 1753CC RTQ RTP RTN		<b>UAP83255</b> NO. 1118410 - YS4Q9E568AA <b>ANILHA PROTEÇÃO TÉRMICA INJECTORES</b> FORD FIESTA IV (JA_ JB_) 1.8 DI 04.2000/01.2002 55KW 75CV 1753CC RTQ RTP RTN 8566394 8566395
	<b>UCRZ1080</b> NO. 1746601 - 1805656 - 97FG-3W007-AA <b>CRUZETA VEIO TRANSMISSÃO TRIPOIDE D32MM/22 DENTES</b> FORD FIESTA VI (CB1, CCN) 1.4 (De 10.2008 Até 09.2012) 71KW 97cv 1388cm3 Hatchback - FORD FIESTA VI (CB1, CCN) 1.4 LPG (De 01.2009 Até 04.2017) 68KW 92cv 1388cm3 Hatchback - FORD FIESTA VI (CB1, CCN) 1.4 LPG (De 01.2009 Até 04.2017) 71KW 97cv 1388cm3 Hatchback -		<b>UFT90087</b> NO. 1148098 - 1348620 - 1485768 - 1516694 - 1633908 - 2S6Q8A586AA - 2S6Q8A586AB - 2S6Q8A586AC <b>FALANGE DO TERMOSTATO</b> FORD FIESTA V (JH_ JD_) 1.4 TDCi (De 11.2001 Até 06.2008) 50kW 68cv 1399cm3 Hatchback - FORD FIESTA V Van 1.4 TDCi (De 10.2003 Até 12.2010) 50kW 68cv 1399cm3 Caixa/parte traseira inclinada -
	<b>UFT90087</b> NO. 1148098 - 1348620 - 1485768 - 1516694 - 1633908 - 2S6Q8A586AA - 2S6Q8A586AB - 2S6Q8A586AC <b>FALANGE DO TERMOSTATO</b> FORD FIESTA VI (CB1, CCN) 1.4 TDCi (De 01.2009 Até 09.2012) 50kW 68cv 1399cm3 Hatchback - FORD FIESTA VI (CB1, CCN) 1.4 TDCi (De 07.2010 Até 09.2012) 51kW 70cv 1399cm3 Hatchback - FORD FIESTA VI (CB1, CCN) 1.6 TDCi (De 06.2008 Até 12.2012) 66kW 90cv 1560cm3 Hatchback - FORD FIESTA VI Van 1.4 TDCi (De 01.2009 -) 50kW 68cv 1399cm3 Caixa/parte traseira inclinada - FORD FIESTA VI Van 1.4 TDCi (De 07....		<b>UFT90087</b> NO. 1148098 - 1348620 - 1485768 - 1516694 - 1633908 - 2S6Q8A586AA - 2S6Q8A586AB - 2S6Q8A586AC <b>FALANGE DO TERMOSTATO</b> FORD FIESTA V (JU_) 1.4 TDCi (De 08.2002 Até 12.2012) 50kW 68cv 1399cm3 Combi -
	<b>UMV25305</b> NO. 1318360 - 1331570 - 4M51A045B79 <b>MANETE PUNHO TOPO ALAVANCA MUDANÇAS 5 VELOCIDADES F13MM</b> FORD FIESTA VI (CB1, CCN): 1.0 01.2013/>>>> 48KW 65CV 998CC - FORD FIESTA VI (CB1, CCN): 1.0 10.2012/>>>> 59KW 80CV 998CC - FORD FIESTA VI (CB1, CCN): 1.0 EcoBoost 01.2013/>>>> 74KW 100CV 998CC - FORD FIESTA VI (CB1, CCN): 1.0 EcoBoost 09.2012/>>>> 92KW 125CV 998CC - FORD FIESTA VI (CB1, CCN): 1.0 Sport 05.2014/>>>> 103KW 140CV 998CC - FORD FIESTA VI (CB1, CCN): 1.25 06.2008/>>>> 44KW 60CV 1242CC - FORD...		<b>UMV25306</b> NO. 1318360 - 1331570 - 4M51A045B79 <b>MANETE PUNHO TOPO ALAVANCA MUDANÇAS 5 VELOCIDADES F13MM</b> FORD FIESTA VI (CB1, CCN): 1.0 01.2013/>>>> 48KW 65CV 998CC - FORD FIESTA VI (CB1, CCN): 1.0 10.2012/>>>> 59KW 80CV 998CC - FORD FIESTA VI (CB1, CCN): 1.0 EcoBoost 01.2013/>>>> 74KW 100CV 998CC - FORD FIESTA VI (CB1, CCN): 1.0 EcoBoost 09.2012/>>>> 92KW 125CV 998CC - FORD FIESTA VI (CB1, CCN): 1.0 Sport 05.2014/>>>> 103KW 140CV 998CC - FORD FIESTA VI (CB1, CCN): 1.25 06.2008/>>>> 44KW 60CV 1242CC - FORD...
	<b>UMV25307</b> NO. 1151765 - 2S6R7217AA - 2S6R7217AC <b>MANETE PUNHO TOPO ALAVANCA MUDANÇAS 5 VELOCIDADES F28MM</b> FORD FIESTA IV (JA_ JB_) 1.0 i 04.1996/09.1999 38KW 52CV 999CC ZH10JRB - FORD FIESTA IV (JA_ JB_) 1.0 i 09.1999/01.2002 48KW 65CV 999CC C4E - FORD FIESTA IV (JA_ JB_) 1.3 i 08.1995/01.2002 37KW 50CV 1299CC JJC JJA JJM JJK JJJ JJE 0928928 0928932 - FORD FIESTA IV (JA_ JB_) 1.3 i 08.1995/01.2002 44KW 60CV 1299CC J4C J4J J4T J4R J4Q J4L J4C 0928929 0928933 - FORD FIESTA IV (JA_ JB_) 1.4 i 16V 04...		<b>UMV25317</b> NO. 1151765 - 2S6R7217AC <b>MANETE PUNHO TOPO ALAVANCA MUDANÇAS 5 VELOCIDADES F13MM</b> FORD FIESTA V (JH_ JD_)   IKON 1.25 16V 05.2002/06.2008 55KW 75CV 1242CC FUJB FUJA 8566514 8566518 8566ACT 8566ACL - FORD FIESTA V (JH_ JD_)   IKON 1.25 16V 03.2003/06.2008 51KW 70CV 1242CC M7JA M7JB 8566506 8566517 8566ACI 8566ACQ - FORD FIESTA V (JH_ JD_)   IKON 1.3 11.2001/06.2008 44KW 60CV 1299CC BAJA 8566499 8566505 8566515 8566ACR 8566ACJ - FORD FIESTA V (JH_ JD_)   IKON 1.3 11.2001/06.2...
	<b>UMV25317</b> NO. 1151765 - 2S6R7217AC <b>MANETE PUNHO TOPO ALAVANCA MUDANÇAS 5 VELOCIDADES F13MM</b> FORD FIESTA V (JH_ JD_) 1.25 08.2004/12.2012 55KW 75CV 1242CC FUJB FUJA 8566ACB 8566545 - FORD FIESTA V (JH_ JD_) 1.4 08.2002/12.2012 59KW 80CV 1388CC FXJC FXJB FXJA 8566503 8566ABY - FORD FIESTA V (JH_ JD_) 1.4 LPG 01.2010/12.2012 59KW 80CV 1388CC UTJA - FORD FIESTA V (JH_ JD_) 1.4 TDCi 08.2002/12.2012 50KW 68CV 1399CC F6JA F6JB 8566502 8566ACC - FORD FIESTA V (JH_ JD_) 1.6 08.2002/11.2009 74KW 100CV 1596CC FYJC FYJB FYJA 856...		<b>UMV25318</b> NO. 1151765 - 2S6R7217AC <b>MANETE PUNHO TOPO ALAVANCA MUDANÇAS 5 VELOCIDADES F22MM</b> FORD FIESTA V (JH_ JD_) 1.25 16V (De 03.2003 Até 06.2008) 51KW 70cv 1242cm3 Hatchback - FORD FIESTA V (JH_ JD_) 1.25 16V (De 05.2002 Até 06.2008) 55KW 75cv 1242cm3 Hatchback - FORD FIESTA V (JH_ JD_) 1.3 (De 11.2001 Até 06.2008) 44KW 60cv 1299cm3 Hatchback - FORD FIESTA V (JH_ JD_) 1.3 (De 11.2001 Até 06.2008) 51KW 69cv 1299cm3 Hatchback - FORD FIESTA V (JH_ JD_) 1.4 16V (De 11.2001 Até 06.20...
	<b>UMV25318</b> NO. 1151765 - 2S6R7217AC <b>MANETE PUNHO TOPO ALAVANCA MUDANÇAS 5 VELOCIDADES F22MM</b> FORD FIESTA V (JH_ JD_) 1.25 16V (De 03.2003 Até 06.2008) 51KW 70cv 1242cm3 Hatchback - FORD FIESTA V (JH_ JD_) 1.25 16V (De 05.2002 Até 06.2008) 55KW 75cv 1242cm3 Hatchback - FORD FIESTA V (JH_ JD_) 1.3 (De 11.2001 Até 06.2008) 44KW 60cv 1299cm3 Hatchback - FORD FIESTA V (JH_ JD_) 1.3 (De 11.2001 Até 06.2008) 51KW 69cv 1299cm3 Hatchback - FORD FIESTA V (JH_ JD_) 1.4 16V (De 11.2001 Até 06.20...		<b>UMV25325</b> NO. 1580939 - AM8A6J-7J132-ABT <b>MANETE PUNHO TOPO ALAVANCA MUDANÇAS 5 VELOCIDADES F14MM</b> FORD FIESTA V (JH_ JD_) 1.25 16V (De 03.2003 Até 06.2008) 51KW 70cv 1242cm3 Hatchback - FORD FIESTA V (JH_ JD_) 1.25 16V (De 05.2002 Até 06.2008) 55KW 75cv 1242cm3 Hatchback - FORD FIESTA V (JH_ JD_) 1.3 (De 11.2001 Até 06.2008) 44KW 60cv 1299cm3 Hatchback - FORD FIESTA V (JH_ JD_) 1.3 (De 11.2001 Até 06.2008) 51KW 69cv 1299cm3 Hatchback - FORD FIESTA V (JH_ JD_) 1.4 16V (De 11.2001 Até 06.20...
	<b>UMV25334</b> NO. XXXX <b>MANETE DA ALAVANCA VELOCIDADES CAIXA AUTOMÁTICA PRATA</b> FORD FIESTA Caixa/monovolume (J5_ J3_)   COURIER 1.3 02.1996/08.2003 44KW 60CV 1299CC J4C J4T J4J J4R J4L J4Q 0928262 0928948 - FORD FIESTA Caixa/monovolume (J5_ J3_)   COURIER 1.4 i 04.1996/10.1999 66KW 90CV 1388CC FHA 0928955 - FORD FIESTA Caixa/monovolume (J5_ J3_)   COURIER 1.8 D 02.1996/04.2002 44KW 60CV 1753CC RTK RTJ 0928261 0928949 - FORD FIESTA Caixa/monovolume (J5_ J3_)   COURIER 1.8...		<b>UMV26803</b> NO. 1151765 - 2S6R7217AC <b>MANETE PUNHO TOPO ALAVANCA MUDANÇAS 5 VELOCIDADES F14MM</b> FORD FIESTA V (JH_ JD_) 1.25 16V 05.2002/06.2008 55KW 75CV 1242CC - FORD FIESTA V (JH_ JD_) 1.4 16V 11.2001/06.2008 59KW 80CV 1388CC - FORD FIESTA V (JH_ JD_) 1.4 TDCi 11.2001/06.2008 50KW 68CV 1399CC

	<p><b>UMV26803</b> NO. 1151765 - 2S6R7217AC</p> <p>MANETE PUNHO TOPO ALAVANCA MUDANÇAS 5 VELOCIDADES F14MM</p> <p>FORD FIESTA MK VI (2008 A 2017) HATCHBACK 1.25 60/82cv 1242cc - 1.4 97cv 1388cc - 1.6 TDCi 75/90cv 1560cc - 1.6 Ti 120cv 1596cc</p>		<p><b>UMV26803</b> NO. 1151765 - 2S6R7217AC</p> <p>MANETE PUNHO TOPO ALAVANCA MUDANÇAS 5 VELOCIDADES F14MM</p> <p>FORD FIESTA MK VI (2008 A 2017) BOX 1.4 TDCi 68cv 1399cc</p>
	<p><b>UPCR5004</b> NO. 1454051 - 1567143 - 1678260</p> <p>PORCA DA RODA CHAVE 19 M12X1,50X30MM ( BASE CONICA )</p> <p>FORD FIESTA Caixa/monovolume (F3L, F5L) 1.3 (09.1991 -02.1996) 44kw 60cv 1299cm3 Caixa/monovolume FORD FIESTA Caixa/monovolume (F3L, F5L) 1.8 D (09.1991 -02.1996) 44kw 60cv 1753cm3 Caixa/monovolume FORD FIESTA Caixa/monovolume (J5_, J3_) 1.3 (02.1996 -08.2003) 44kw 60cv 1299cm3 Caixa/monovolume FORD FIESTA Caixa/monovolume (J5_, J3_) 1.4 (04.1996 -10.1999) 66kw 90cv 1388cm3 Caixa/monovolume FORD...</p>		<p><b>UPCR5004</b> NO. 1454051 - 1567143 - 1678260</p> <p>PORCA DA RODA CHAVE 19 M12X1,50X30MM ( BASE CONICA )</p> <p>FORD FIESTA III (GFJ) 1.1 (03.1989 -12.1995) 37kw 50cv 1119cm3 Hatchback FORD FIESTA III (GFJ) 1.1 (03.1989 -12.1995) 40kw 55cv 1119cm3 Hatchback FORD FIESTA III (GFJ) 1.3 (03.1989 -12.1995) 44kw 60cv 1299cm3 Hatchback FORD FIESTA III (GFJ) 1.3 (03.1989 -12.1992) 44kw 60cv 1299cm3 Hatchback FORD FIESTA III (GFJ) 1.3 Cat (05.1991 -01.1997) 44kw 60cv 1299cm3 Hatchback FORD FIESTA III (GFJ) 1.4 (03.1991...</p>
	<p><b>UPCR5004</b> NO. 1454051 - 1567143 - 1678260</p> <p>PORCA DA RODA CHAVE 19 M12X1,50X30MM ( BASE CONICA )</p> <p>FORD FIESTA IV (JA_, JB_) 1.0 i (04.1996 -09.1999) 38kw 52cv 999cm3 Hatchback FORD FIESTA IV (JA_, JB_) 1.0 i (09.1999 -01.2002) 48kw 65cv 999cm3 Hatchback FORD FIESTA IV (JA_, JB_) 1.25 i 16V (08.1995 -01.2002) 55kw 75cv 1242cm3 Hatchback FORD FIESTA IV (JA_, JB_) 1.3 i (08.1995 -01.2002) 37kw 50cv 1299cm3 Hatchback FORD FIESTA IV (JA_, JB_) 1.3 i (08.1995 -01.2002) 44kw 60cv 1299cm3 Hatchback FO...</p>		<p><b>UPCR5004</b> NO. 1454051 - 1567143 - 1678260</p> <p>PORCA DA RODA CHAVE 19 M12X1,50X30MM ( BASE CONICA )</p> <p>FORD FIESTA V (JH_, JD_) 1.25 16V (03.2003 -06.2008) 51kw 70cv 1242cm3 Hatchback FORD FIESTA V (JH_, JD_) 1.25 16V (05.2002 -06.2008) 55kw 75cv 1242cm3 Hatchback FORD FIESTA V (JH_, JD_) 1.3 (11.2001 -06.2008) 44kw 60cv 1299cm3 Hatchback FORD FIESTA V (JH_, JD_) 1.3 (11.2001 -06.2008) 51kw 69cv 1299cm3 Hatchback FORD FIESTA V (JH_, JD_) 1.4 16V (11.2001 -06.2008) 59kw 80cv 1388cm3 Hatchback FORD F...</p>
	<p><b>UPCR5004</b> NO. 1454051 - 1567143 - 1678260</p> <p>PORCA DA RODA CHAVE 19 M12X1,50X30MM ( BASE CONICA )</p> <p>FORD FIESTA VI (CB1, CCN) 1.25 (06.2008 -04.2017) 44kw 60cv 1242cm3 Hatchback FORD FIESTA VI (CB1, CCN) 1.25 (06.2008 -04.2017) 60kw 82cv 1242cm3 Hatchback FORD FIESTA VI (CB1, CCN) 1.4 (10.2008 -) 71kw 97cv 1388cm3 Hatchback FORD FIESTA VI (CB1, CCN) 1.4 LPG (01.2009 -04.2017) 68kw 92cv 1388cm3 Hatchback FORD FIESTA VI (CB1, CCN) 1.4 TDCi (08.2008 -09.2012) 50kw 68cv 1399cm3 Hatchback FORD FIESTA VI (CB1, CCN) 1.4 TDCi (07.2010 -09.2012) 51kw 70cv 1399cm3 Hatchback ...</p>		<p><b>UPCR5004</b> NO. 1454051 - 1567143 - 1678260</p> <p>PORCA DA RODA CHAVE 19 M12X1,50X30MM ( BASE CONICA )</p> <p>FORD FUSION (JU_) 1.25 (08.2004 -12.2012) 55kw 75cv 1242cm3 Combi FORD FUSION (JU_) 1.4 (08.2002 -12.2012) 59kw 80cv 1388cm3 Combi FORD FUSION (JU_) 1.4 LPG (01.2010 -12.2012) 59kw 80cv 1388cm3 Combi FORD FUSION (JU_) 1.4 TDCi (08.2002 -12.2012) 50kw 68cv 1399cm3 Combi FORD FUSION (JU_) 1.6 (08.2002 -11.2009) 74kw 100cv 1596cm3 Combi FORD FUSION (JU_) 1.6 TDCi (11.2004 -12.2012) 66kw 90cv 1560cm3 ...</p>
	<p><b>UPCR5004</b> NO. 1454051 - 1567143 - 1678260</p> <p>PORCA DA RODA CHAVE 19 M12X1,50X30MM ( BASE CONICA )</p> <p>FORD PUMA (EC_) 1.4 16V (11.1997 -10.2000) 66kw 90cv 1388cm3 Coupé FORD PUMA (EC_) 1.6 16V (08.2000 -06.2002) 76kw 103cv 1596cm3 Coupé FORD PUMA (EC_) 1.7 16V (03.1997 -06.2002) 92kw 125cv 1679cm3 Coupé FORD PUMA (EC_) Racing ST 160 (06.1999 -06.2002) 114kw 155cv 1679cm3 Coupé</p>		<p><b>UPCR5018</b> NO. 1007487 - 1447852 - 1470843</p> <p>PORCA DA RODA CHAVE 19 M12X1,50X16MM ( BASE CONICA PARA JANTE DE AÇO )</p> <p>FORD FIESTA V (JH_, JD_) 1.6 16V (11.2001 -06.2008) 74kw 100cv 1596cm3 Hatchback FORD FIESTA V (JH_, JD_) ST150 (03.2005 -06.2008) 110kw 150cv 1999cm3 Hatchback FORD FIESTA V Van 1.3 (05.2002 -08.2008) 44kw 60cv 1299cm3 Caixa/parte traseira inclinada FORD FIESTA V Van 1.3 (10.2003 -07.2005) 51kw 69cv 1299cm3 Caixa/parte traseira inclinada FORD FIESTA V Van 1.4 (05.2002 -09.2005) 59kw 80cv 138...</p>
	<p><b>UPCR5018</b> NO. 1007487 - 1447852 - 1470843</p> <p>PORCA DA RODA CHAVE 19 M12X1,50X16MM ( BASE CONICA PARA JANTE DE AÇO )</p> <p>FORD FIESTA VI (CB1, CCN) 1.4 (10.2008 -) 71kw 97cv 1388cm3 Hatchback FORD FIESTA VI (CB1, CCN) 1.4 LPG (01.2009 -04.2017) 68kw 92cv 1388cm3 Hatchback FORD FIESTA VI (CB1, CCN) 1.4 LPG (01.2009 -04.2017) 71kw 97cv 1388cm3 Hatchback FORD FIESTA VI (CB1, CCN) 1.4 TDCi (08.2008 -09.2012) 50kw 68cv 1399cm3 Hatchback FORD FIESTA VI (CB1, CCN) 1.4 TDCi (07.2010 -09.2012) 51kw 70cv 1399cm3 Hatchback ...</p>		<p><b>UPCR5018</b> NO. 1007487 - 1447852 - 1470843</p> <p>PORCA DA RODA CHAVE 19 M12X1,50X16MM ( BASE CONICA PARA JANTE DE AÇO )</p> <p>FORD PUMA (EC_) 1.4 16V 11.1997 - 10.2000 66kw 90cv 1388cm3 Coupé FORD PUMA (EC_) 1.6 16V 08.2000 -06.2002 76kw 103cv 1596cm3 Coupé FORD PUMA (EC_) 1.7 16V 03.1997 -06.2002 92kw 125cv 1679cm3 Coupé FORD PUMA (EC_) Racing ST 160 06.1999 -06.2002 114kw 155cv 1679cm3 Coupé</p>
	<p><b>UPCR5019</b> NO. 1366029 - 1366432 - 1678260 - 2179620 - 5114407 - 6111766</p> <p>PORCA DA RODA CHAVE 19 M12X1,50X31MM ( BASE CONICA )</p> <p>FORD PUMA (EC_) 1.4 16V (11.1997 -10.2000) 66kw 90cv 1388cm3 Coupé FORD PUMA (EC_) 1.6 16V (08.2000 -06.2002) 76kw 103cv 1596cm3 Coupé FORD PUMA (EC_) 1.7 16V (03.1997 -06.2002) 92kw 125cv 1679cm3 Coupé FORD PUMA (EC_) Racing ST 160 (06.1999 -06.2002) 114kw 155cv 1679cm3 Coupé FORD PUMA (J2K, CF7) 1.0 EcoBoost (09.2019 -) 70kw 95cv 999cm3 SUV FORD PUMA (J2K, CF7) 1.0 EcoBoost (09.2019 -) 92kw 125cv...</p>		<p><b>UTR0630</b> NO. 6045648</p> <p>TAMPÃO RADIADOR</p> <p>FORD FIESTA I (GFBT) 0.9 (De 1976.05 Até 1983.08) 29kW 40cv 957cm3 Hatchback -</p> <p>FORD FIESTA I (GFBT) 0.9 (De 1976.05 Até 1983.08) 33kW 45cv 957cm3 Hatchback -</p> <p>FORD FIESTA I (GFBT) 1.1 (De 1976.05 Até 1983.08) 39kW 53cv 1117cm3 Hatchback -</p> <p>FORD FIESTA I (GFBT) 1.1 (WFBT) (De 1981.02 Até 1983.08) 40kW 55cv 1117cm3 Hatchback -</p> <p>FORD FIESTA I (GFBT) 1.3 (De 1976.05 Até 1983.08) ...</p>
	<p><b>UTR0631</b> NO. 1508310 - 1613291 - 623086 - 78GB8100AC - ERS34</p> <p>TAMPÃO RADIADOR</p> <p>FORD FIESTA Caixa (WFVT) 1.1 (WFVT) (De 1977.10 Até 1986.11) 39kW 53cv 1117cm3 Caixa -</p>		<p><b>UTR0800</b> NO. 1647750 - 1647751 - 1650630 - 1659287 - 1659288 - 6157002 - 6160686 - 6854060 - 6893213 - 7267962 - ...</p> <p>TAMPÃO RESERVATÓRIO LÍQUIDO REFRIGERAÇÃO</p> <p>FORD FIESTA I (GFBT) 0.9 (05.76 A 08.83) 40cv 957cc Hatchback -</p> <p>FORD FIESTA I (GFBT) 0.9 (05.76 A 08.83) 45cv 957cc Hatchback -</p> <p>FORD FIESTA I (GFBT) 1.1 (05.76 A 08.83) 53cv 1117cc Hatchback -</p> <p>FORD FIESTA I (GFBT) 1.3 (08.77 A 08.83) 66cv 1297cc Hatchback -</p> <p>FORD FIESTA II (FBD) 1.0 (FBD) (09.83 A 02.89) 45cv 957cc Hatchback -</p> <p>FORD FIESTA II (FBD) 1.1 (FBD) (05.86 A 02.89) 49cv 1117cc Hat...</p>

















	<p><b>UTR0800</b> NO. 1647750 - 1647751 - 1650630 - 1659287 - 1659288 - 6157002 - 6160686 - 6854060 - 6893213 - 7267962 - ...</p> <p><b>TAMPÃO RESERVATÓRIO LIQUIDO REFRIGERAÇÃO</b></p> <p>FORD PUMA (EC_) 1.4 16 V (11.97 A 10.00) 90cv 1388cc Coupé - FORD PUMA (EC_) 1.6 16 V (08.00 A 06.02) 103cv 1596cc Coupé - FORD PUMA (EC_) 1.7 16 V (03.97 A 06.02) 125cv 1679cc Coupé - FORD PUMA (EC_) ST 160 (06.99 A 06.02) 160cv 1679cc C o u p é</p> <p>d62x25mm 1f-d53x14mm</p>		<p><b>UTR0817</b> NO. 21430-AX300 - 21430-AX600 - 21430AX30A - 4408066 - 7700805131 - 8200048024 - 91166192</p> <p><b>TAMPÃO RESERVATÓRIO LIQUIDO REFRIGERAÇÃO</b></p> <p>FORD FIESTA III (GFJ) 1.3 (03.89 A 12.95) 60cv 1299cc Hatchback</p> <p>53x36mm 1f-d46x18mm</p>
	<p><b>UTR0820</b> NO. 90352470 - 90409256 - 90409257 - 9041032690497472 - 90467473</p> <p><b>TAMPÃO RESERVATÓRIO LIQUIDO REFRIGERAÇÃO</b></p> <p>FORD FIESTA Caixa ( F V D ) 1.0 (08.83 A 11.89) 45cv 957cc Caixa - FORD FIESTA Caixa ( F V D ) 1.4 (09.86 A 09.89) 71cv 1392cc Caixa - FORD FIESTA Caixa ( F V D ) 1.6 D (09.83 A 09.89) 54cv 1608cc Caixa - FORD FIESTA Caixa ( F V D ) 1.8 D ( F V J ) (03.89 A 12.95) 60cv 1753cc Caixa - FORD FIESTA Caixa ( F 3 L , F 5 L ) 1.3 (09.91 A 02.96) 60cv 1299cc Caixa - FORD FIESTA Caixa ( F 3 L , F 5...</p> <p>d62x23mm 1f-d53x12mm</p>		<p><b>UTR0820</b> NO. 90352470 - 90409256 - 90409257 - 9041032690497472 - 90467473</p> <p><b>TAMPÃO RESERVATÓRIO LIQUIDO REFRIGERAÇÃO</b></p> <p>FORD FUSION (JU_) 1.25 (08.04 A 12.12) 75cv 1242cc Combi - FORD FUSION (JU_) 1.4 (08.02 A 12.12) 80cv 1388cc Combi - FORD FUSION (JU_) 1.4 LPG (01.10 A 12.12) 80cv 1388cc Combi - FORD FUSION (JU_) 1.6 (08.02 A 11.08) 100cv 1596cc Combi - FORD FUSION (JU_) 1.4 TDCi (08.02 A 12.12) 68cv 1399cc Combi - FORD FUSION (JU_) 1.6 TDCi (11.04 A 12.12) 90cv 1560cc Combi</p> <p>d62x23mm 1f-d53x12mm</p>
	<p><b>UTR0820</b> NO. 90352470 - 90409256 - 90409257 - 9041032690497472 - 90467473</p> <p><b>TAMPÃO RESERVATÓRIO LIQUIDO REFRIGERAÇÃO</b></p> <p>FORD PUMA (EC_) 1.4 16V (11.97 A 10.00) 90cv 1388cc Coupé - FORD PUMA (EC_) 1.6 16V (08.00 A 06.02) 103cv 1596cc Coupé - FORD PUMA (EC_) 1.7 16V (03.97 A 06.02) 125cv 1679cc Coupé - FORD PUMA (EC_) ST 160 (06.99 A 06.02) 160cv 1679cc Coupé</p> <p>d62x23mm 1f-d53x12mm</p>		<p><b>UTR0829</b> NO. 1647750 - 1650630 - 1659287 - 1659288 - 6157002 - 7267969</p> <p><b>TAMPÃO RESERVATÓRIO LIQUIDO REFRIGERAÇÃO</b></p> <p>FORD FIESTA Caixa (WFVT) 1.1 (WFVT) (10.77 A 11.86) 53cv 1117cc Caixa - FORD FIESTA Caixa (FVD) 1.4 (09.86 A 09.89) 71cv 1392cc Caixa</p> <p>d62x25mm 1f-d52x14mm</p>
	<p><b>UTR0847</b> NO. 1224233 - 1301104 - 3M5H8100AC</p> <p><b>TAMPÃO RESERVATÓRIO LIQUIDO REFRIGERAÇÃO</b></p> <p>FORD FIESTA VI 1.0 (A Partir de 01.13) 65cv 998cc Hatchback - FORD FIESTA VI 1.0 (A Partir de 10.12) 80cv 998cc Hatchback - FORD FIESTA VI 1.0 EcoBoost (A Partir de 01.13) 100cv 998cc Hatchback - FORD FIESTA VI 1.0 EcoBoost (A Partir de 09.12) 125cv 998cc Hatchback - FORD FIESTA VI 1.0 Sport (A Partir de 05.14) 140cv 998cc Hatchback - FORD FIESTA VI 1.25 (A Partir de 06.08) 60cv 1242cc ...</p> <p>d62x35mm 1f-d50x16mm</p>		<p><b>UTR0859</b> NO. 1650630 - 94539597 - 96293957 - 96312510 - 96351578 - 96420303 - 96536649</p> <p><b>TAMPÃO RESERVATÓRIO LIQUIDO REFRIGERAÇÃO</b></p> <p>FORD FIESTA Caixa ( FVD ) 1.0 (08.83 A 11.89) 45cv 957cc Caixa - FORD FIESTA Caixa ( FVD ) 1.8 D ( FVJ ) (03.89 A 12.95) 60cv 1753cc Caixa - FORD FIESTA Caixa ( F 3 L , F 5 L ) 1.3 (09.91 A 02.96) 60cv 1299cc Caixa - FORD FIESTA Caixa ( F3L , F5L ) 1.8 D (09.91 A 02.96) 60cv 1753cc Caixa - FORD FIESTA Caixa ( J 5 _ , J 3 _ ) 1.3 (02.96 A 08.03) 60cv 1299cc Caixa - FORD FIESTA Caixa ( J 5 ...</p> <p>d63x23mm 1f-d53x11mm</p>
	<p><b>UTR0859</b> NO. 1650630 - 94539597 - 96293957 - 96312510 - 96351578 - 96420303 - 96536649</p> <p><b>TAMPÃO RESERVATÓRIO LIQUIDO REFRIGERAÇÃO</b></p> <p>FORD FUSION (JU_) 1.25 08.04 A 12.12) 75cv 1242cc Combi - FORD FUSION (JU_) 1.4 (08.02 A 12.12) 80cv 1388cc Combi - FORD FUSION (JU_) 1.6 (08.02 A 11.08) 100cv 1596cc Combi - FORD FUSION (JU_) 1.4 TDCi (08.02 A 12.12) 68cv 1399cc Combi - FORD FUSION (JU_) 1.6 TDCi (11.04 A 12.12) 90cv 1560cc Combi</p> <p>d63x23mm 1f-d53x11mm</p>		<p><b>UTR0859</b> NO. 1650630 - 94539597 - 96293957 - 96312510 - 96351578 - 96420303 - 96536649</p> <p><b>TAMPÃO RESERVATÓRIO LIQUIDO REFRIGERAÇÃO</b></p> <p>FORD PUMA ( E C _ ) 1.4 16 V (11.97 A 10.00) 90cv 1388cc Coupé - FORD PUMA ( E C _ ) 1.6 16 V (08.00 A 06.02) 103cv 1596cc Coupé - FORD PUMA ( EC _ ) 1.7 16 V (03.97 A 06.02) 125cv 1679cc Coupé - FORD PUMA ( EC _ ) S T 160 (06.99 A 06.02) 160cv 1679cc Coupé</p> <p>d63x23mm 1f-d53x11mm</p>
	<p><b>UTV83002</b> NO. 2S6Q6730AA</p> <p><b>TAMPÃO VEDAÇÃO BUJÃO</b></p> <p>FORD FIESTA V (JH_ - JD_) 1.4 TDCi (De 11-2001 Até 06-2008) 50kW 68CV 1399cc Hatchback FORD FIESTA V (JH_ - JD_) 1.6 TDCi (De 11-2004 Até 06-2008) 66kW 90CV 1560cc Hatchback</p> <p>20x18mm c13mm d10mm</p>		<p><b>UTV83002</b> NO. 2S6Q6730AA</p> <p><b>TAMPÃO VEDAÇÃO BUJÃO</b></p> <p>FORD FIESTA VI (CB1 - CCN) 1.4 TDCi (De 01-2009 Até ...) 50kW 68CV 1399cc Hatchback FORD FIESTA VI (CB1 - CCN) 1.4 TDCi (De 07-2010 Até 1-20-) 51kW 70CV 1399cc Hatchback FORD FIESTA VI (CB1 - CCN) 1.6 TDCi (De 06-2008 Até ...) 55kW 75CV 1560cc Hatchback FORD FIESTA VI (CB1 - CCN) 1.6 TDCi (De 06-2008 Até ...) 66kW 90CV 1560cc Hatchback FORD FIESTA VI (CB1 - CCN) 1.6 TDCi (De 02-2010 Até 1-20-)...</p> <p>20x18mm c13mm d10mm</p>
	<p><b>UTV83002</b> NO. 2S6Q6730AA</p> <p><b>TAMPÃO VEDAÇÃO BUJÃO</b></p> <p>FORD FUSION (JU_) 1.4 TDCi (De 08-2002 Até 12-2012) 50kW 68CV 1399cc Combi FORD FUSION (JU_) 1.6 TDCi (De 11-2004 Até 12-2012) 66kW 90CV 1560cc Combi</p> <p>20x18mm c13mm d10mm</p>		<p><b>UTV83010</b> NO. 1013938 - 97JM6730BA</p> <p><b>TAMPÃO VEDAÇÃO BUJÃO</b></p> <p>FORD FIESTA IV (JA_ - JB_) 1.0 i (De 02-1997 Até 09-1999) 38kW 52CV 999cc Hatchback FORD FIESTA IV (JA_ - JB_) 1.0 i (De 09-1999 Até 01-2002) 48kW 65CV 999cc Hatchback FORD FIESTA IV (JA_ - JB_) 1.25 i 16V (De 08-1995 Até 01-2002) 55kW 75CV 1242cc Hatchback FORD FIESTA IV (JA_ - JB_) 1.3 i (De 08-1995 Até 01-2002) 37kW 50CV 1299cc Hatchback FORD FIESTA IV (JA_ - JB_) 1.3 i (De 08-1995 Até 01-2002)...</p> <p>d28x35mm c19mm d13mm</p>
	<p><b>UTV83010</b> NO. 1013938 - 97JM6730BA</p> <p><b>TAMPÃO VEDAÇÃO BUJÃO</b></p> <p>FORD FIESTA V (JH_ - JD_) 1.25 16V (De 03-2003 Até 06-2008) 51kW 70CV 1242cc Hatchback FORD FIESTA V (JH_ - JD_) 1.25 16V (De 05-2002 Até 06-2008) 55kW 75CV 1242cc Hatchback FORD FIESTA V (JH_ - JD_) 1.3 (De 11-2001 Até 06-2008) 44kW 60CV 1299cc Hatchback FORD FIESTA V (JH_ - JD_) 1.3 (De 11-2001 Até 06-2008) 51kW 69CV 1299cc Hatchback FORD FIESTA V (JH_ - JD_) 1.4 16V (De 11-2001 Até 06-2008) 59k...</p> <p>d28x35mm c19mm d13mm</p>		<p><b>UTV83010</b> NO. 1013938 - 97JM6730BA</p> <p><b>TAMPÃO VEDAÇÃO BUJÃO</b></p> <p>FORD FIESTA VI (CB1 - CCN) 1.25 (De 06-2008 Até ...) 44kW 60CV 1242cc Hatchback FORD FIESTA VI (CB1 - CCN) 1.25 (De 06-2008 Até ...) 60kW 82CV 1242cc Hatchback FORD FIESTA VI (CB1 - CCN) 1.4 (De 06-2008 Até ...) 71kW 97CV 1388cc Hatchback FORD FIESTA VI (CB1 - CCN) 1.4 LPG (De 01-2009 Até ...) 68kW 92CV 1388cc Hatchback FORD FIESTA VI (CB1 - CCN) 1.4 LPG (De 01-2009 Até ...) 71kW 97CV 1388cc Hatch...</p> <p>d28x35mm c19mm d13mm</p>

	<p><b>UTV83010</b> NO. 1013938 - 97JM6730BA</p> <p>TAMPÃO VEDAÇÃO BUJÃO</p> <p>FORD FIESTA Caixa (J5_ - J3_) 1.3 (De 02-1996 Até 08-2003) 44kW 60CV 1299cc Caixa FORD FIESTA Caixa (J5_ - J3_) 1.8 D (De 02-1996 Até 04-2002) 44kW 60CV 1753cc Caixa FORD FIESTA Caixa (J5_ - J3_) 1.8 Di (De 09-2000 Até 08-2003) 55kW 75CV 1753cc Caixa FORD FIESTA Caixa (JV_) D 1.8 (De 05-1998 Até 04-2002) 44kW 60CV 1753cc Caixa FORD FIESTA Caixa (JV_) TD 1.8 (De 03-2000 Até 08-2003) 55kW 75CV 1753cc...</p> <p>d28x35mm      c19mm d13mm</p>		<p><b>UTV83010</b> NO. 1013938 - 97JM6730BA</p> <p>TAMPÃO VEDAÇÃO BUJÃO</p> <p>FORD PUMA (EC_) 1.4 16V (De 11-1997 Até 10-2000) 66kW 90CV 1388cc Coupé FORD PUMA (EC_) 1.6 16V (De 08-2000 Até 06-2002) 76kW 103CV 1596cc Coupé FORD PUMA (EC_) 1.7 16V (De 03-1997 Até 06-2002) 92kW 125CV 1679cc Coupé FORD PUMA (EC_) Racing ST 160 (De 06-1999 Até 06-2002) 114kW 155CV 1679cc Coupé</p> <p>d28x35mm      c19mm d13mm</p>
	<p><b>UTV83012</b> NO. 1457117 - 1657022 - 1663906 - 6093527 - 6186775 - 6732529 - 70TM6730AA - 89FF6730AA</p> <p>TAMPÃO VEDAÇÃO BUJÃO</p> <p>FORD FIESTA I (GFBT) 0.9 (De 05-1976 Até 08-1983) 29kW 40CV 957cc Hatchback FORD FIESTA I (GFBT) 0.9 (De 05-1976 Até 08-1983) 33kW 45CV 957cc Hatchback</p> <p>d23x26mm      c15mm d13mm</p>		<p><b>UTV83012</b> NO. 1457117 - 1657022 - 1663906 - 6093527 - 6186775 - 6732529 - 70TM6730AA - 89FF6730AA</p> <p>TAMPÃO VEDAÇÃO BUJÃO</p> <p>FORD FIESTA II (FBD) 1.0 (FBD) (De 09-1983 Até 02-1989) 33kW 45CV 957cc Hatchback FORD FIESTA II (FBD) 1.1 (FBD) (De 05-1986 Até 02-1989) 36kW 49CV 1117cc Hatchback FORD FIESTA II (FBD) 1.1 (FBD) (De 09-1983 Até 02-1989) 37kW 50CV 1117cc Hatchback FORD FIESTA II (FBD) 1.3 (FBD) (De 09-1983 Até 01-1987) 51kW 69CV 1298cc Hatchback FORD FIESTA II (FBD) 1.4 (De 09-1983 Até 01-1987) 51kW 69CV 1392cc Ha...</p> <p>d23x26mm      c15mm d13mm</p>
	<p><b>UTV83012</b> NO. 1457117 - 1657022 - 1663906 - 6093527 - 6186775 - 6732529 - 70TM6730AA - 89FF6730AA</p> <p>TAMPÃO VEDAÇÃO BUJÃO</p> <p>FORD FIESTA III (GFJ) 1.0 (De 03-1989 Até 12-1995) 33kW 45CV 1001cc Hatchback FORD FIESTA III (GFJ) 1.1 (De 03-1989 Até 12-1995) 37kW 50CV 1119cc Hatchback FORD FIESTA III (GFJ) 1.1 (De 03-1989 Até 12-1995) 40kW 55CV 1119cc Hatchback FORD FIESTA III (GFJ) 1.3 (De 03-1989 Até 12-1995) 44kW 60CV 1299cc Hatchback FORD FIESTA III (GFJ) 1.3 (De 03-1989 Até 12-1992) 44kW 60CV 1299cc Hatchback FORD FIESTA...</p> <p>d23x26mm      c15mm d13mm</p>		<p><b>UTV83012</b> NO. 1457117 - 1657022 - 1663906 - 6093527 - 6186775 - 6732529 - 70TM6730AA - 89FF6730AA</p> <p>TAMPÃO VEDAÇÃO BUJÃO</p> <p>FORD FIESTA IV (JA_ - JB_) 1.0 i (De 02-1997 Até 09-1999) 38kW 52CV 999cc Hatchback FORD FIESTA IV (JA_ - JB_) 1.0 i (De 09-1999 Até 01-2002) 48kW 65CV 999cc Hatchback FORD FIESTA IV (JA_ - JB_) 1.3 i (De 08-1995 Até 01-2002) 37kW 50CV 1299cc Hatchback FORD FIESTA IV (JA_ - JB_) 1.3 i (De 08-1995 Até 01-2002) 44kW 60CV 1299cc Hatchback FORD FIESTA IV (JA_ - JB_) 1.8 D (De 08-1995 Até 04-2000) 44kW...</p> <p>d23x26mm      c15mm d13mm</p>
	<p><b>UTV83012</b> NO. 1457117 - 1657022 - 1663906 - 6093527 - 6186775 - 6732529 - 70TM6730AA - 89FF6730AA</p> <p>TAMPÃO VEDAÇÃO BUJÃO</p> <p>FORD FIESTA Caixa (WFVT) 1.0 (WFVT) (De 10-1977 Até 11-1986) 29kW 40CV 957cc Caixa FORD FIESTA Caixa (WFVT) 1.1 (WFVT) (De 10-1977 Até 11-1986) 39kW 53CV 1117cc Caixa FORD FIESTA Caixa (J5_ - J3_) 1.3 (De 02-1996 Até 08-2003) 44kW 60CV 1299cc Caixa FORD FIESTA Caixa (JV_) D 1.8 (De 05-1998 Até 04-2002) 44kW 60CV 1753cc Caixa FORD FIESTA Caixa (JV_) TD 1.8 (De 03-2000 Até 08-2003) 55kW 75CV 1753cc ...</p> <p>d23x26mm      c15mm d13mm</p>		<p><b>UVD80303</b> NO. 7257202 - 89FB3B734A2D</p> <p>VEIO DA COLUNA DE DIREÇÃO</p> <p>FORD FIESTA Caixa/monovolume (F3L, F5L) 1.3 09.1991/02.1996 44kW 60CV 1299CC J6B 2028319 2028197 - FORD FIESTA Caixa/monovolume (F3L, F5L) 1.8 D 09.1991/02.1996 44kW 60CV 1753CC RTD RTG RTC 2028318 2028196 - FORD FIESTA Caixa/monovolume (J5_ , J3_ ) 1.3 02.1996/08.2003 44kW 60CV 1299CC J4C J4T J4J J4R J4L J4Q 0928262 0928948 - FORD FIESTA Caixa/monovolume (J5_ , J3_ ) 1.4 i 04.1996/10.1999 66kW 90CV 1...</p> <p>118x42x36mm      1f-d13mm</p>
	<p><b>UVD80303</b> NO. 7257202 - 89FB3B734A2D</p> <p>VEIO DA COLUNA DE DIREÇÃO</p> <p>FORD FIESTA III (GFJ) 1.0 03.1989/12.1995 33kW 45CV 1001CC TLB - FORD FIESTA III (GFJ) 1.1 03.1989/12.1995 37kW 50CV 1119CC G6A 2028321 0928712 0928785 7528368 7528345 - FORD FIESTA III (GFJ) 1.1 03.1989/12.1995 40kW 55CV 1119CC GUE GUD 2028320 0928711 0928784 7528367 7528344 - FORD FIESTA III (GFJ) 1.3 03.1989/12.1992 44kW 60CV 1299CC JBC 2028325 0928788 7528369 - FORD FIESTA III (GFJ) 1.3 Cat 05...</p> <p>118x42x36mm      1f-d13mm</p>		<p><b>UVD80303</b> NO. 7257202 - 89FB3B734A2D</p> <p>VEIO DA COLUNA DE DIREÇÃO</p> <p>FORD FIESTA IV (JA_ , JB_ ) 1.8 D 08.1995/04.2000 44kW 60CV 1753CC RTK RTJ 0928931 0928935</p> <p>118x42x36mm      1f-d13mm</p>
	<p><b>W5015</b> NO. 1147683 - 1319519 - 1369546 - 1369548 - 1473366 - 1485765 - 1487861 - 1517975 - 1517976 - 2...</p> <p>POLIE DA CAMBOTA S/EMBRAIAGEM (6 pistas)</p> <p>FORD FIESTA V 1.4 TDCi (APÓS 11-2001) - 1.6 TDCi (APÓS 11-2004)</p> <p>d152.8mm      d30mm</p>		<p><b>W5015</b> NO. 1147683 - 1319519 - 1369546 - 1369548 - 1473366 - 1485765 - 1487861 - 1517975 - 1517976 - 2...</p> <p>POLIE DA CAMBOTA S/EMBRAIAGEM (6 pistas)</p> <p>FORD FIESTA V 1.4 TDCi (APÓS 08-2002) - 1.6 TDCi (APÓS 11-2004)</p> <p>d152.8mm      d30mm</p>
	<p><b>W5025</b> NO. 1005817 - 1085938 - 96FF6B319AA</p> <p>POLIE DA CAMBOTA (5 pistas)</p> <p>FORD FIESTA Caixa/monovolume (JV_) D 1.8 05.1998/04.2002 44kW 60CV 1753CC RTJ, RTK 0928260 - FORD FIESTA IV (JA_ , JB_ ) 1.8 D 08.1995/04.2000 44kW 60CV 1753CC RTK, RTJ 0928931, 0928935 - FORD FIESTA Caixa/monovolume (J5_ , J3_ ) 1.8 D 02.1996/04.2002 44kW 60CV 1753CC RTK, RTJ 0928261, 0928949 - FORD FIESTA Caixa/parte traseira inclinada (FVD) 1.8 D (FVJ) 03.1989/12.1995 43kW 60CV 1753CC RTC, RTG, RTD...</p> <p>d134.3mm      d42mm</p>		<p><b>W5026</b> NO. 1038330 - 1135052 - 1250444 - 26105255 - 6599021 - 928M6B320DB - 928M6B320DD - 928M6B320DE - 928M6B320DF</p> <p>POLIE CAMBOTA (6 PISTAS)</p> <p>FORD FIESTA III (GFJ): 1.6 i 16V 01.1994/12.1995 65kW 88CV 1597CC - FORD FIESTA III (GFJ): 1.6 03.1989/12.1992 66kW 90CV 1597CC - FORD FIESTA III (GFJ): 1.8 16V 02.1992/12.1995 77kW 105CV 1796CC - FORD FIESTA III (GFJ): 1.8 XR2i 16V 02.1992/12.1995 96kW 130CV 1796CC</p> <p>d131.3mm      d28mm</p>
	<p><b>W5035</b> NO. 1135052</p> <p>POLIE DA CAMBOTA (6 PISTAS)</p> <p>FORD FIESTA III 1.6i 16V (1994 A 12-1995) - 1.8 16V - 1.8 XR2i 16V (02-1992 A 12-1995) - 1.8 16V - 1.8 XR2i 16V (02-1992 A 12-1995) - FIESTA IV 1.6i 16V (APÓS 1996) - FIESTA IV 1.8 16V (APÓS 1996)</p> <p>d132mm      d28mm</p>		<p><b>W5120</b> NO. 1147683 - 1319519 - 1369546 - 1369548 - 1473366 - 1485765 - 1487861 - 1517975 - 1517976 - 2...</p> <p>POLIE DA CAMBOTA C/EMBRAIAGEM (6 pistas)</p> <p>FORD - FIESTA V (JH_ - JD_) - 1.4 TDCi (11.01 - 06.08) 68cv 1399cc Hatchback - FORD - FIESTA V (JH_ - JD_) - 1.6 TDCi (11.04 - 06.08) 90cv 1560cc Hatchback - FORD - FIESTA V Van - 1.4 TDCi (10.03 - 12.10) 68cv 1399cc Caixa</p> <p>d150/162mm      d29,5mm</p>

	<p><b>W5120</b> NO. 1147683 - 1319519 - 1369546 - 1369548 - 1473366 - 1485765 - 1487861 - 1517975 - 1517976 - 2...</p> <p>POLIE DA CAMBOTA C/EMBRAIAGEM (6 pistas)</p> <p>FORD - FIESTA VI - 1.4 TDCi Ano fabric. até: (12.09) (APÓS 01.09) 68cv 1399cc Hatchback - FORD - FIESTA VI - 1.6 TDCi Ano fabric. até: (12.09) (APÓS 06.08) 75cv 1560cc Hatchback - FORD - FIESTA VI - 1.6 TDCi Ano fabric. até: (12.09) (APÓS 06.08) 90cv 156</p> <p>d150/162mm d29,5mm</p>	<p><b>W5120</b> NO. 1147683 - 1319519 - 1369546 - 1369548 - 1473366 - 1485765 - 1487861 - 1517975 - 1517976 - 2...</p> <p>POLIE DA CAMBOTA C/EMBRAIAGEM (6 pistas)</p> <p>FORD - FUSION (JU_) - 1.4 TDCi Mod. t ipo: Fusion - ou: - Mod. t ipo: Ecosport (08.02 - 07.05) 68cv 1399cc Combi - FORD - FUSION (JU_) - 1.6 TDCi (11.04 - 12.12) 90cv 1560cc Combi</p> <p>d150/162mm d29,5mm</p>
	<p><b>W5135</b> NO. 6186295</p> <p>POLIE DA CAMBOTA 3 PISTAS</p> <p>FORD FIESTA III (GFJ) 1.8 D (03.89 A 12.95) 60cv 1753cc Hatchback</p> <p>d120/130mm d20,6mm</p>	<p><b>W5165</b> NO. 1539704 - 1752282 - 8A6G6B321AB - 8A6G6B321AC</p> <p>POLIE DA CAMBOTA (6 PISTAS)</p> <p>FORD FIESTA VI (CB1 - CCN) 1.25 (De 06-2008 Até ...) 44kW 60CV 1242cc Hatchback FORD FIESTA VI (CB1 - CCN) 1.25 (De 06-2008 Até ...) 60kW 82CV 1242cc Hatchback FORD FIESTA VI (CB1 - CCN) 1.4 (De 06-2008 Até ...) 71kW 97CV 1388cc Hatchback FORD FIESTA VI (CB1 - CCN) 1.4 LPG (De 01-2009 Até ...) 68kW 92CV 1388cc Hatchback FORD FIESTA VI (CB1 - CCN) 1.4 LPG (De 01-2009 Até ...) 71kW 97CV 1388cc Hatch...</p> <p>d138mm d25mm</p>
	<p><b>W5181</b> NO. 1141497 - 1753151 - 2S6G6B321AA - 2S6G6B321AB</p> <p>POLIE DA CAMBOTA (5+6 PISTAS)</p> <p>FORD FIESTA V (JH_, JD_): 1.25 16V 03.2003/06.2008 51KW 70CV 1242CC - FORD FIESTA V (JH_, JD_): 1.25 16V 05.2002/06.2008 55KW 75CV 1242CC - FORD FIESTA V (JH_, JD_): 1.4 16V 11.2001/06.2008 59KW 80CV 1388CC - FORD FIESTA V (JH_, JD_): 1.6 16V 11.2001/06.2008 74KW 100CV 1596CC - FORD FIESTA V (JH_, JD_): 1.4 TDCi 11.2001/06.2008 50KW 68CV 1399CC - FORD FIESTA V (JH_, JD_): 1.6 TDCi 11.2004/06.2008 ...</p> <p>d138/83mm d24mm</p>	<p><b>W5181</b> NO. 1141497 - 1753151 - 2S6G6B321AA - 2S6G6B321AB</p> <p>POLIE DA CAMBOTA (5+6 PISTAS)</p> <p>FORD FUSION (JU_): 1.25 08.2004/12.2012 55KW 75CV 1242CC - FORD FUSION (JU_): 1.4 08.2002/12.2012 59KW 80CV 1388CC - FORD FUSION (JU_): 1.4 LPG 01.2010/12.2012 59KW 80CV 1388CC - FORD FUSION (JU_): 1.6 08.2002/11.2009 74KW 100CV 1596CC - FORD FUSION (JU_): 1.4 TDCi 08.2002/12.2012 50KW 68CV 1399CC - FORD FUSION (JU_): 1.6 TDCi 11.2004/12.2012 66KW 90CV 1560CC</p> <p>d138/83mm d24mm</p>
	<p><b>W5181</b> NO. 1141497 - 1753151 - 2S6G6B321AA - 2S6G6B321AB</p> <p>POLIE DA CAMBOTA (5+6 PISTAS)</p> <p>FORD FIESTA IV (JA_, JB_): 1.6 16V Sport 02.2000/01.2002 76KW 103CV 1596CC</p> <p>d138/83mm d24mm</p>	<p><b>W5181</b> NO. 1141497 - 1753151 - 2S6G6B321AA - 2S6G6B321AB</p> <p>POLIE DA CAMBOTA (5+6 PISTAS)</p> <p>FORD FIESTA VI (CB1, CCN): 1.25 06.2008/&gt;&gt;&gt;&gt; 44KW 60CV 1242CC - FORD FIESTA VI (CB1, CCN): 1.25 06.2008/&gt;&gt;&gt;&gt; 60KW 82CV 1242CC - FORD FIESTA VI (CB1, CCN): 1.4 10.2008/&gt;&gt;&gt;&gt; 71KW 97CV 1388CC - FORD FIESTA VI (CB1, CCN): 1.6 Ti 06.2008/&gt;&gt;&gt;&gt; 88KW 120CV 1596CC</p> <p>d138/83mm d24mm</p>
	<p><b>W5187</b> NO. 1072126 - 10742126 - 1087321 - 98MM6B321BB - 98MM6B321BC</p> <p>POLIE DA CAMBOTA (6 PISTAS)</p> <p>FORD FIESTA IV (JA_, JB_): 1.25 i 16V 08.1995/01.2002 55KW 75CV 1242CC - FORD FIESTA IV (JA_, JB_): 1.6 16V Sport 02.2000/01.2002 76KW 103CV 1596CC</p> <p>d139mm d25mm</p>	<p><b>W5187</b> NO. 1072126 - 10742126 - 1087321 - 98MM6B321BB - 98MM6B321BC</p> <p>POLIE DA CAMBOTA (6 PISTAS)</p> <p>FORD PUMA (EC_): 1.6 16V 08.2000/06.2002 76KW 103CV 1596CC</p> <p>d139mm d25mm</p>
	<p><b>W5187</b> NO. 1072126 - 10742126 - 1087321 - 98MM6B321BB - 98MM6B321BC</p> <p>POLIE DA CAMBOTA (6 PISTAS)</p> <p>FORD FIESTA V (JH_, JD_): 1.6 16V 11.2001/06.2008 74KW 100CV 1596CC</p> <p>d139mm d25mm</p>	<p><b>W5187</b> NO. 1072126 - 10742126 - 1087321 - 98MM6B321BB - 98MM6B321BC</p> <p>POLIE DA CAMBOTA (6 PISTAS)</p> <p>FORD FUSION (JU_): 1.6 08.2002 - 11.2009 74KW 100CV 1596CC</p> <p>d139mm d25mm</p>
	<p><b>Y3233</b> NO. 1473166 - 1481984 - 3395499 - 4432023 - 6586309 - 6789185</p> <p>PARAFUSO DA RODA CAVILHA M12X1,50X48MM</p> <p>FORD FIESTA V (JH_, JD_) 1.6 16V (11.2001 - 06.2008) 74kw 100cv 1596cm3 Hatchback FORD FIESTA V (JH_, JD_) ST150 (03.2005 - 06.2008) 110kw 150cv 1999cm3 Hatchback FORD FIESTA V Van 1.3 (05.2002 - 08.2008) 44kw 60cv 1299cm3 Caixa/parte traseira inclinada FORD FIESTA V Van 1.3 (10.2003 - 07.2005) 51kw 69cv 1299cm3 Caixa/parte traseira inclinada FORD FIESTA V Van 1.4 (05.2002 - 09.2005) 59kw 80cv 138...</p> <p>c48mm M12x1,5mm</p>	<p><b>Y3233</b> NO. 1473166 - 1481984 - 3395499 - 4432023 - 6586309 - 6789185</p> <p>PARAFUSO DA RODA CAVILHA M12X1,50X48MM</p> <p>FORD FIESTA VI (CB1, CCN) 1.4 (10.2008 -) 71kw 97cv 1388cm3 Hatchback FORD FIESTA VI (CB1, CCN) 1.4 LPG (01.2009 - 04.2017) 68kw 92cv 1388cm3 Hatchback FORD FIESTA VI (CB1, CCN) 1.4 LPG (01.2009 - 04.2017) 71kw 97cv 1388cm3 Hatchback FORD FIESTA VI (CB1, CCN) 1.4 TDCi (08.2008 - 09.2012) 50kw 68cv 1399cm3 Hatchback FORD FIESTA VI (CB1, CCN) 1.4 TDCi (07.2010 - 09.2012) 51kw 70cv 1399cm3 Hatchback ...</p> <p>c48mm M12x1,5mm</p>
	<p><b>Y3233</b> NO. 1473166 - 1481984 - 3395499 - 4432023 - 6586309 - 6789185</p> <p>PARAFUSO DA RODA CAVILHA M12X1,50X48MM</p> <p>FORD PUMA (EC_) 1.4 16V (11.1997 - 10.2000) 66kw 90cv 1388cm3 Coupé FORD PUMA (EC_) 1.6 16V (08.2000 - 06.2002) 76kw 103cv 1596cm3 Coupé FORD PUMA (EC_) 1.7 16V (03.1997 - 06.2002) 92kw 125cv 1679cm3 Coupé FORD PUMA (EC_) Racing ST 160 (06.1999 - 06.2002) 114kw 155cv 1679cm3 Coupé</p> <p>c48mm M12x1,5mm</p>	<p><b>Z41158</b> NO. 1656747 - 1825595 - 1752024 - 6740771 - 4852244</p> <p>MOLA DE FIXAÇÃO TIPO PORCA</p> <p>FORD PUMA (EC_) 1.4 16V (11.1997 - 10.2000) 66kw 90cv 1388cm3 Coupé FORD PUMA (EC_) 1.6 16V (08.2000 - 06.2002) 76kw 103cv 1596cm3 Coupé FORD PUMA (EC_) 1.7 16V (03.1997 - 06.2002) 92kw 125cv 1679cm3 Coupé FORD PUMA (EC_) Racing ST 160 (06.1999 - 06.2002) 114kw 155cv 1679cm3 Coupé</p> <p>d12x 11mm f-d24mm</p>



	<p><b>Z50130</b> NO. 11589289</p> <p><i>MOLA REBITE FIXAÇÃO</i></p> <p>FORD FIESTA VI (CB1, CCN) 1.0 (01.2013 -04.2017) 48kw 65cv 998cm3 Hatchback FORD FIESTA VI (CB1, CCN) 1.0 (10.2012 -04.2017) 59kw 80cv 998cm3 Hatchback FORD FIESTA VI (CB1, CCN) 1.0 EcoBoost (01.2013 -04.2017) 74kw 100cv 998cm3 Hatchback FORD FIESTA VI (CB1, CCN) 1.0 EcoBoost (09.2012 -04.2017) 92kw 125cv 998cm3 Hatchback FORD FIESTA VI (CB1, CCN) 1.0 Sport (05.2014 -04.2017) 103kw 140cv 998cm3 Ha...</p> <p>d6x 18mm f-d17mm</p>		<p><b>Z50130</b> NO. 11589289</p> <p><i>MOLA REBITE FIXAÇÃO</i></p> <p>FORD FIESTA VI Van 1.0 (10.2012 -04.2017) 59kw 80cv 998cm3 Caixa/parte traseira inclinada FORD FIESTA VI Van 1.0 EcoBoost (05.2014 -04.2017) 103kw 140cv 998cm3 Caixa/parte traseira inclinada FORD FIESTA VI Van 1.25 (01.2009 -04.2017) 60kw 82cv 1242cm3 Caixa/parte traseira inclinada FORD FIESTA VI Van 1.4 TDCi (01.2009 -04.2017) 50kw 68cv 1399cm3 Caixa/parte traseira inclinada FORD FIESTA VI Van 1....</p> <p>d6x 18mm f-d17mm</p>
	<p><b>Z50130</b> NO. 11589289</p> <p><i>MOLA REBITE FIXAÇÃO</i></p> <p>FORD FIESTA VII (HJ, HF) 1.0 EcoBoost (04.2018 -) 63kw 85cv 998cm3 Hatchback FORD FIESTA VII (HJ, HF) 1.0 EcoBoost (05.2017 -) 74kw 101cv 998cm3 Hatchback FORD FIESTA VII (HJ, HF) 1.0 EcoBoost (05.2017 -) 92kw 125cv 998cm3 Hatchback FORD FIESTA VII (HJ, HF) 1.0 EcoBoost (06.2017 -) 103kw 140cv 998cm3 Hatchback FORD FIESTA VII (HJ, HF) 1.0 EcoBoost (12.2019 -) 70kw 95cv 999cm3 Hatchback FORD FIESTA...</p> <p>d6x 18mm f-d17mm</p>		<p><b>Z50130</b> NO. 11589289</p> <p><i>MOLA REBITE FIXAÇÃO</i></p> <p>FORD FIESTA VII Van 1.0 EcoBoost (04.2019 -) 74kw 101cv 998cm3 Caixa/parte traseira inclinada FORD FIESTA VII Van 1.0 EcoBoost (09.2018 -) 92kw 125cv 998cm3 Caixa/parte traseira inclinada FORD FIESTA VII Van 1.0 EcoBoost (04.2019 -) 103kw 140cv 998cm3 Caixa/parte traseira inclinada FORD FIESTA VII Van 1.0 EcoBoost (12.2019 -) 70kw 95cv 999cm3 Caixa/parte traseira inclinada FORD FIESTA VII Van 1.0 ...</p> <p>d6x 18mm f-d17mm</p>
	<p><b>Z50130</b> NO. 11589289</p> <p><i>MOLA REBITE FIXAÇÃO</i></p> <p>FORD PUMA (J2K, CF7) 1.0 EcoBoost (09.2019 -) 70kw 95cv 999cm3 SUV FORD PUMA (J2K, CF7) 1.0 EcoBoost (09.2019 -) 92kw 125cv 999cm3 SUV FORD PUMA (J2K, CF7) 1.0 EcoBoost mHEV (09.2019 -) 92kw 125cv 999cm3 SUV FORD PUMA (J2K, CF7) 1.0 EcoBoost mHEV (09.2019 -) 114kw 155cv 999cm3 SUV FORD PUMA (J2K, CF7) 1.0 Flexifuel (12.2021 -) 92kw 125cv 999cm3 SUV FORD PUMA (J2K, CF7) 1.5 EcoBlue (04.2020 -) 88kw...</p> <p>d6x 18mm f-d17mm</p>		<p><b>Z71162</b> NO. 5270438</p> <p><i>MOLA DO PAINEL EXTERIOR MOLDURAS</i></p> <p>FORD FIESTA (A partir de 2017)</p> <p>F13mm T20mm L15mm H20mm S1-7mm</p>
	<p><b>Z71162</b> NO. 5270438</p> <p><i>MOLA DO PAINEL EXTERIOR MOLDURAS</i></p> <p>FORD PUMA (A partir de 2019)</p> <p>F13mm T20mm L15mm H20mm S1-7mm</p>		<p><b>Z80487</b> NO. 6040784</p> <p><i>Mola de friso</i></p> <p>FORD FIESTA</p> <p>10x9.3x5mm</p>
	<p><b>Z80553</b> NO. 1443038</p> <p><i>Mola de painel</i></p> <p>FORD FIESTA</p> <p>d14x13mm 1p-d8-11mm</p>		<p><b>Z80598</b> NO. 6725950</p> <p><i>Mola de painel</i></p> <p>FORD FIESTA (De 1989 A 1996)</p> <p>d18x18.5mm 1p-d9.5-16mm</p>
	<p><b>Z80616</b> NO. 6099812</p> <p><i>Mola de painel</i></p> <p>FORD FIESTA</p> <p>d18x20.5mm 1p-d7.6-12mm</p>		<p><b>Z80617</b> NO. 6117693</p> <p><i>Mola de painel</i></p> <p>FORD FIESTA</p> <p>d18x16.5mm 1p-d7.4-11mm</p>
	<p><b>Z80623</b> NO.</p> <p><i>Mola de painel</i></p> <p>FORD FIESTA</p> <p>d25x30.6mm 1p-d12-14.5mm</p>		<p><b>Z80647</b> NO. 14222380</p> <p><i>Mola de fixação</i></p> <p>FORD FIESTA (Após 1989)</p> <p>12.5x12.5x19.2mm 1p-9.5x9.5-18mm 1f-d4.8mm</p>
	<p><b>Z80673</b> NO. 6142786</p> <p><i>Mola de painel</i></p> <p>FORD FIESTA (Após 1989)</p> <p>d25x17mm 1p-d12-15.5mm</p>		<p><b>Z80687</b> NO. 6448410</p> <p><i>Mola de painel</i></p> <p>FORD PUMA (EC_) 1.4 16V 11.1997/10.2000 66KW 90CV 1388CC FHD FHF 8566340 - FORD PUMA (EC_) 1.6 16V 08.2000/06.2002 76KW 103CV 1596CC L1W 8566422 - FORD PUMA (EC_) 1.7 16V 03.1997/06.2002 92KW 125CV 1679CC MHB MHA 8566310 - FORD PUMA (EC_) Racing ST 160 06.1999/06.2002 114KW 155CV 1679CC MHA</p> <p>d25x14.5mm 1p-d9.3-12.5mm</p>

	<p><b>Z80687</b> NO. 6448410</p> <p><i>Mola de painel</i></p> <p>FORD FIESTA Caixa/monovolume (F3L, F5L)   COURIER 1.3 09.1991/02.1996 44KW 60CV 1299CC J6B 2028319 2028197 - FORD FIESTA Caixa/monovolume (F3L, F5L)   COURIER 1.8 D 09.1991/02.1996 44KW 60CV 1753CC RTD RTG RTC 2028318 2028196 - FORD FIESTA Caixa/monovolume (J5_, J3_)   COURIER 1.3 02.1996/08.2003 44KW 60CV 1299CC J4C J4T J4J J4R J4L J4Q 0928262 0928948 - FORD FIESTA Caixa/monovolume (J5_, J3_)   C...</p> <p>d25x14.5mm 1p-d9.3-12.5mm</p>		<p><b>Z80697</b> NO. 1047847 - 1047848</p> <p><i>Mola de fixação</i></p> <p>FORD FIESTA (De 1989 A 1996)</p>
	<p><b>Z80698</b> NO. 1051701</p> <p><i>Mola de fixação</i></p> <p>FORD FIESTA (Após 1996)</p> <p>d16.4x25mm 1p-d7-8.5mm</p>		<p><b>Z80699</b> NO. 1007932</p> <p><i>Mola de fixação</i></p> <p>FORD FIESTA (Após 1996)</p> <p>d16x29mm 1p-d6.5-18mm</p>
	<p><b>Z80700</b> NO. 6181023</p> <p><i>Mola de fixação</i></p> <p>FORD FIESTA (De 1989 A 1996)</p> <p>12.5x10x30mm 1p-10x8-15.5mm</p>		<p><b>Z80704</b> NO. 500326189 - 6176723</p> <p><i>Mola de painel</i></p> <p>FORD PUMA</p> <p>d18x21mm 1p-d8.2-15mm</p>
	<p><b>Z80704</b> NO. 500326189 - 6176723</p> <p><i>Mola de painel</i></p> <p>FORD FIESTA (De 1989 A 1996)</p> <p>d18x21mm 1p-d8.2-15mm</p>		<p><b>Z80714</b> NO. 1591426 - 50283 - 6117693 - 6177722 - A0069884378 - E865220S</p> <p><i>Mola de painel</i></p> <p>FORD FIESTA Caixa/monovolume (F3L, F5L)   COURIER 1.3 09.1991/02.1996 44KW 60CV 1299CC J6B 2028319 2028197 - FORD FIESTA Caixa/monovolume (F3L, F5L)   COURIER 1.8 D 09.1991/02.1996 44KW 60CV 1753CC RTD RTG RTC 2028318 2028196 - FORD FIESTA Caixa/parte traseira inclinada (FVD) 1.8 D (FVJ) 03.1989/12.1995 44KW 60CV 1753CC RTC RTG RTD 0928251 - FORD FIESTA Caixa/parte traseira inclinada (WFVT) 1.0 (W...</p> <p>d18x18mm 1p-d9-12mm</p>
	<p><b>Z80717</b> NO. 6150260</p> <p><i>Mola de fixação</i></p> <p>FORD PUMA</p> <p>d20x12.5mm 1p-8x11-10mm 1f-d5.5mm</p>		<p><b>Z80717</b> NO. 6150260</p> <p><i>Mola de fixação</i></p> <p>FORD FIESTA (De 1989 A 1996)</p> <p>d20x12.5mm 1p-8x11-10mm 1f-d5.5mm</p>
	<p><b>Z80718</b> NO. 6634877</p> <p><i>Mola de retenção</i></p> <p>FORD FIESTA (Após 1989)</p> <p>d14x10mm 1f-d3.9mm</p>		<p><b>Z80787</b> NO. 1039463 - 8E0825267</p> <p><i>Mola de fixação</i></p> <p>FORD FUSION</p> <p>d20x34mm 1p-d8.5-21mm</p>
	<p><b>Z80787</b> NO. 1039463 - 8E0825267</p> <p><i>Mola de fixação</i></p> <p>FORD FIESTA</p> <p>d20x34mm 1p-d8.5-21mm</p>		<p><b>Z80845</b> NO. 1028521 - W701054S300</p> <p><i>Rebite</i></p> <p>FORD FUSION</p> <p>d25x42.5mm 1p-d8-24.5mm</p>
	<p><b>Z80845</b> NO. 1028521 - W701054S300</p> <p><i>Rebite</i></p> <p>FORD FIESTA (De 2002 A 2008)</p> <p>d25x42.5mm 1p-d8-24.5mm</p>		<p><b>Z9005</b> NO. 1640227 - 6156718 - 6688870</p> <p><i>MOLA DE ESCAPE</i></p> <p>FORD FIESTA (1986 A 1995)</p> <p>d25x28mm</p>

	<b>Z9009</b>	NO. 6142854 - 6146512		
	MOLA DE ESCAPE			
	FORD FIESTA (1984 A 1995)			
	d14x69mm			

FORD FOCUS - FOCUS C-MAX

	<b>A1387</b>	NO. 1061194 - 1070136 - 98AB8125EC		<b>A1569</b>	NO. 1061722 - 1064722 - 1087177 - 1104037 - 1106874 - 1115132 - 1117734 - 1122893 - 1480525 - 1S...
	APOIO SUPORTE RADIADOR INFERIOR/SUPERIOR			APOIO AMORTECEDOR FRENTE ( GASTA 2 UNIDADES )	
	FORD FOCUS I (DAW, DBW) 1.4 16V 10.1998/11.2004 55KW 75CV 1388CC FXDA FXDD FXDC FXDB 8566345 8566349 - FORD FOCUS I (DAW, DBW) 1.6 16V 10.1998/11.2004 74KW 100CV 1596CC FYDH FYDC FYDA FYDD FYDB 8566346 8566350 - FORD FOCUS I (DAW, DBW) 1.8 16V 10.1998/11.2004 85KW 115CV 1796CC EYDJ EYDL EYDI EYDG EYDC EYDF EYDD EYDE EYDB 8566347 8566351 - FORD FOCUS I (DAW, DBW) 1.8 DI / TDDi 08.1999/11.2004 55KW ...			FORD FOCUS I (DAW, DBW) 1.4 16V 10.1998/11.2004 55KW 75CV 1388CC FXDA FXDD FXDC FXDB 8566345 8566349 - FORD FOCUS I (DAW, DBW) 1.6 16V 10.1998/11.2004 74KW 100CV 1596CC FYDH FYDC FYDA FYDD FYDB 8566346 8566350 - FORD FOCUS I (DAW, DBW) 1.6 16V Flexifuel 01.2002/11.2004 75KW 102CV 1596CC FYDH - FORD FOCUS I (DAW, DBW) 1.8 16V 10.1998/11.2004 85KW 115CV 1796CC EYDJ EYDL EYDI EYDG EYDC EYDF EYDD EYDE...	
	d54x40mm	d41mm d38mm 1f-d25mm 1f-d13mm		110x110x30mm	3p-d8-23mm
	<b>A1589</b>	NO. 1061131 - 1066070 - 1092270 - 1092271 - 1133019 - 1133020 - 1309644 - 1355149 - 98AB.7M121.NB ...		<b>A1590</b>	NO. 1061107 - 1072571 - 1105977 - 1105997 - 1139257 - 98AB.6038.CK - 98AB6038CG - 98AB6038CH - 98...
	APOIO CAIXA VELOCIDADES AUTOMÁTICAS ESQUERDO			APOIO MOTOR DIREITO HIDRÁULICO	
	FORD FOCUS I (DAW, DBW) 1.4 16V 10.1998/11.2004 55KW 75CV 1388CC FXDA FXDD FXDC FXDB 8566345 8566349 - FORD FOCUS I (DAW, DBW) 1.6 16V 10.1998/11.2004 74KW 100CV 1596CC FYDH FYDC FYDA FYDD FYDB 8566346 8566350 - FORD FOCUS I (DAW, DBW) 1.6 16V Flexifuel 01.2002/11.2004 75KW 102CV 1596CC FYDH - FORD FOCUS I (DAW, DBW) 1.8 16V 10.1998/11.2004 85KW 115CV 1796CC EYDJ EYDL EYDI EYDG EYDC EYDF EYDD EYDE...			FORD FOCUS I (DAW, DBW) 1.4 16V 10.1998/11.2004 55KW 75CV 1388CC FXDA FXDD FXDC FXDB 8566345 8566349 - FORD FOCUS I (DAW, DBW) 1.4 16V 10.1998/09.1999 55KW 75CV 1388CC FXDA - FORD FOCUS I (DAW, DBW) 1.6 16V 10.1998/11.2004 74KW 100CV 1596CC FYDH FYDC FYDA FYDD FYDB 8566346 8566350 - FORD FOCUS I (DAW, DBW) 1.6 16V Flexifuel 01.2002/11.2004 75KW 102CV 1596CC FYDH - FORD FOCUS I (DAW, DBW) 1.8 16V 1...	
	165x130x65mm	1f-d15mm		138x107x92mm	1p-d12-31mm
	<b>A1680</b>	NO. 1000941 - 1100941 - 1104173 - 1142702 - 1332880 - 1M51.6F012.BB - 1M516F012AD - 1M516F012BA ...		<b>A1690</b>	NO. 1000941 - 1100941 - 1104173 - 1142702 - 1332880 - 1M51.6F012.AD - 1M51.6F012.BA - 1M51.6F012....
	APOIO DO MOTOR LADO DIREITO			APOIO DO MOTOR PARTE DA FRENTE	
	FORD FOCUS (DAW, DBW): 1.8 DI / TDDi 08.1999/11.2004 55KW 75CV 1753CC - FORD FOCUS (DAW, DBW): 1.8 Turbo DI / TDDi 10.1998/11.2004 66KW 90CV 1753CC - FORD FOCUS (DAW, DBW): 1.8 TDCi 08.2002/11.2004 74KW 100CV 1753CC - FORD FOCUS (DAW, DBW): 1.8 TDCi 03.2001/11.2004 85KW 115CV 1753CC - FORD FOCUS três volumes (DFW): 1.8 Turbo DI / TDDi 08.2001/03.2005 55KW 75CV 1753CC - FORD FOCUS três volumes (DFW)...			FORD FOCUS (DAW, DBW): 1.8 DI / TDDi 08.1999/11.2004 55KW 75CV 1753CC - FORD FOCUS (DAW, DBW): 1.8 Turbo DI / TDDi 10.1998/11.2004 66KW 90CV 1753CC - FORD FOCUS (DAW, DBW): 1.8 TDCi 08.2002/11.2004 74KW 100CV 1753CC - FORD FOCUS (DAW, DBW): 1.8 TDCi 03.2001/11.2004 85KW 115CV 1753CC - FORD FOCUS três volumes (DFW): 1.8 Turbo DI / TDDi 08.2001/03.2005 55KW 75CV 1753CC - FORD FOCUS três volumes (DFW)...	
	235x130x120mm			145x120x77mm	1f-d10mm
	<b>A1780</b>	NO. 123092 - 1230982 - 1233493 - 1250618 - 1345657 - 1437549 - 1567937 - 1568052 - 1930320 - 3063687...		<b>A1780</b>	NO. 123092 - 1230982 - 1233493 - 1250618 - 1345657 - 1437549 - 1567937 - 1568052 - 1930320 - 3063687...
	APOIO DO MOTOR FRENTE			APOIO DO MOTOR FRENTE	
	FOCUS C-MAX (DM2) 1.6 TDCi 10.2003/03.2007 80KW 109CV 1560CC G8DB G8DA G8DD G8DF G8DE 8566AAJ 8566532 - FOCUS C-MAX (DM2) 1.6 TDCi 02.2005/03.2007 66KW 90CV 1560CC HHDB HHDA 8566610 8566AAK - FOCUS C-MAX (DM2) 1.6 Ti 08.2004/03.2007 85KW 115CV 1596CC SIDA HXDA 8566571 8566AAM			FORD FOCUS III 1.6 TDCi 07.2010/12.2017 70KW 95CV 1560CC T3DB T3DA 8566AWF - FORD FOCUS III 1.6 TDCi 07.2010/12.2017 85KW 115CV 1560CC T1DB T1DA 8566AWG - FORD FOCUS III 1.6 TDCi ECONetic 05.2012/07.2015 77KW 105CV 1560CC NGDB NGDA 8566BFE - FORD FOCUS III Caixa/parte traseira inclinada 1.6 TDCi 02.2012/12.2017 85KW 115CV 1560CC T1DB T1DA - FORD FOCUS III três volumes 1.6 TDCi 07.2010/02.2020 70KW...	
	256x140x120mm	1f-d12mm 1f-d13mm 2f-18x20mm		256x140x120mm	1f-d12mm 1f-d13mm 2f-18x20mm
	<b>A1780</b>	NO. 123092 - 1230982 - 1233493 - 1250618 - 1345657 - 1437549 - 1567937 - 1568052 - 1825087 - 1857733...		<b>A1784</b>	NO. 1224049 - 1250824 - 1355357 - 1370874 - 1404996 - 1420044 - 1522138 - 1533046 - 1751001 - 3M51...
	APOIO DO MOTOR FRENTE			APOIO DA CAIXA VELOCIDADES	
	FORD FOCUS II (DA_, HCP, DP) 1.6 TDCi 07.2004/09.2012 74KW 100CV 1560CC MTD A G8DC 8566AKF - FORD FOCUS II (DA_, HCP, DP) 1.6 TDCi 07.2004/09.2012 80KW 109CV 1560CC G8DD G8DE G8DF G8DA G8DB 8566ABI 8566573 - FORD FOCUS II (DA_, HCP, DP) 1.6 TDCi 01.2005/09.2012 66KW 90CV 1560CC GPDA GPDB GPDC HHDB HHDA 8566ABK 8566600 - FORD FOCUS II (DA_, HCP, DP) 1.6 Ti 07.2004/09.2012 85KW 115CV 1596CC SIDA HXDB...			FORD FOCUS II (DA_, HCP, DP): 1.4 07.2004/09.2012 59KW 80CV 1388CC - FORD FOCUS II (DA_, HCP, DP): 1.6 07.2004/09.2012 74KW 100CV 1596CC - FORD FOCUS II (DA_, HCP, DP): 1.6 Ti 07.2004/09.2012 85KW 115CV 1596CC - FORD FOCUS II (DA_, HCP, DP): 1.6 LPG 10.2009/07.2011 85KW 115CV 1596CC - FORD FOCUS II (DA_, HCP, DP): 1.8 03.2006/09.2012 92KW 125CV 1798CC - FORD FOCUS II (DA_, HCP, DP): 1.8 Flexifuel ...	
	256x140x120mm	1f-d12mm 1f-d13mm 2f-18x20mm		160x1005x45mm	2f-d12mm 1f-M12
	<b>A1784</b>	NO. 1224049 - 1250824 - 1355357 - 1370874 - 1404996 - 1420044 - 1522138 - 1533046 - 1751001 - 3M51P082A...		<b>A1822</b>	NO. 1454284 - 1690298 - 1801350 - 3M517M121JC - AV617M121CB - AV617M121CC
	APOIO DA CAIXA VELOCIDADES			APOIO DA CAIXA DE VELOCIDADES	
	FORD FOCUS C-MAX (DM2): 1.8 10.2003/03.2007 88KW 120CV 1798CC - FORD FOCUS C-MAX (DM2): 1.8 09.2005/03.2007 90KW 122CV 1798CC - FORD FOCUS C-MAX (DM2): 1.8 04.2004/03.2007 92KW 125CV 1798CC - FORD FOCUS C-MAX (DM2): 1.8 Flexifuel 01.2006/03.2007 92KW 125CV 1798CC - FORD FOCUS C-MAX (DM2): 1.6 TDCi 02.2005/03.2007 66KW 90CV 1560CC - FORD FOCUS C-MAX (DM2): 1.6 TDCi 10.2003/03.2007 80KW 109CV 1560CC...			FORD FOCUS C-MAX (DM2): 1.6 10.2003/03.2007 74KW 100CV 1596CC - FORD FOCUS C-MAX (DM2): 1.6 Ti 08.2004/03.2007 85KW 115CV 1596CC - FORD FOCUS C-MAX (DM2): 1.8 10.2003/03.2007 88KW 120CV 1798CC - FORD FOCUS C-MAX (DM2): 1.8 04.2004/03.2007 92KW 125CV 1798CC - FORD FOCUS C-MAX (DM2): 1.8 Flexifuel 01.2006/03.2007 92KW 125CV 1798CC - FORD FOCUS C-MAX (DM2): 1.8 Flexifuel 01.2006/03.2007 92KW 125CV 1798CC - FORD FOCUS C-MAX (DM2): 2.0 03.2004/03.2007 107KW 145CV 1999CC	
	160x1005x45mm	2f-d12mm 1f-M12		230x160x70mm	4f-16x19mm 1f-d15mm

	<p><b>A1822</b> NO. 1454284 - 1690298 - 1801350 - 3M517M121JC - AV617M121CB - AV617M121CC</p> <p>APOIO DA CAIXA DE VELOCIDADES</p> <p>FORD FOCUS II</p>		<p><b>A1822</b> NO. 1454284 - 1690298 - 1801350 - 3M517M121JC - AV617M121CB - AV617M121CC</p> <p>APOIO DA CAIXA DE VELOCIDADES</p> <p>FORD FOCUS III</p>
	<p><b>A1827</b> NO. 1230960 - 1255747 - 1305330 - 1305954 - 1308718 - 1308719 - 1320605 - 1323599 - 1334230 - 1...</p> <p>APOIO DO AMORTECEDOR DA FRENTE DIREITO E ESQUERDO</p> <p>FORD FOCUS C-MAX 1.6 (10.03 - 03.07) 100cv 1596cc Veículo multiuso - FORD FOCUS C-MAX 1.6 Ti (08.04 - 03.07) 115cv 1596cc Veículo multiuso - FORD FOCUS C-MAX 1.8 (10.03 - 03.07) 120cv 1798cc Veículo multiuso - FORD FOCUS C-MAX 1.8 (09.05 - 03.07) 122cv 17</p>		<p><b>A1827</b> NO. 1230960 - 1255747 - 1305330 - 1305954 - 1308718 - 1308719 - 1320605 - 1323599 - 1334230 - 1...</p> <p>APOIO DO AMORTECEDOR DA FRENTE DIREITO E ESQUERDO</p> <p>FORD FOCUS II (DA_) 1.4 (07.04 - 09.12) 80cv 1388cc Hatchback - FORD FOCUS II (DA_) 1.6 Código do mot or: 1 - 6 PFI (07.04 - 09.12) 100cv 1596cc Hatchback - FORD FOCUS II (DA_) 1.6 Ti Código do mot or: 1 - 6 TI-VCT (07.04 - 09.12) 115cv 1596cc Hatchback - FOR</p>
	<p><b>A1924</b> NO. 1519590 - 1526663 - 1536951 - 1546649 - 1676770 - 1692614 - 1778550 - 8V516F012BB - 8V516F012BC - 8V...</p> <p>APOIO MOTOR LADO DIREITO</p> <p>FORD B-MAX (JK) 1.4 (a Partir de 10.12) 90cv 1388cc Veículo multiuso - FORD B-MAX (JK) 1.6 Ti (A Partir de 10.12) 105cv 1596cc Veículo multiuso</p>		<p><b>A1926</b> NO. 1072572 - 1102456 - 11102572 - 1112025 - 1S416038BA - 98AB6038DG - 98AB6038DH - YS416038BA</p> <p>APOIO MOTOR LADO DIREITO</p> <p>FORD FOCUS (DAW, DBW) 1.6 16V (10.98 A 11.04) 100cv 1596cc Hatchback - FORD FOCUS (DAW, DBW) 1.8 16V Local de montagem: à frente (10.98 A 11.04) 115cv 1796cc Hatchback - FORD FOCUS (DAW, DBW) 2.0 16V (10.98 A 11.04) 131cv 1988cc Hatchback - FORD FOCUS (DAW, DBW) ST170 Local de montagem: à frente (03.02 A 11.04) 173cv 1988cc Hatchback - FORD FOCUS três volumes (DFW) 1.6 16V (02.99 A 11.04) ...</p>
	<p><b>A1927</b> NO. 1322569 - 4M516P093FA</p> <p>APOIO CAIXA VELOCIDADES</p> <p>FORD FOCUS C-MAX 1.8 Ano fabric. a partir de: 05.04 10.03 - 03.07 88 120 1798 Veículo multiuso FORD FOCUS C-MAX 1.8 Ano fabric. a part ir de: 05.04 04.04 - 03.07 92 125 1798 Veículo multiuso FORD FOCUS C-MAX 2.0 Ano fabric. a part ir de: 05.04 03.04 - 03.07 107 145 1999 Veículo multiuso</p>		<p><b>A1927</b> NO. 1322569 - 4M516P093FA</p> <p>APOIO CAIXA VELOCIDADES</p> <p>FORD FOCUS II (DA_) 2.0 07.04 - 09.12 107 145 1999 Hatchback FORD FOCUS II três volumes (DA_) 2.0 04.05 - 07.11 107 145 1999 três volumes FORD FOCUS II Turnier (DA_) 2.0 07.04 - 09.12 107 145 1999 Combi</p>
	<p><b>A2302</b> NO. 1224049 - 1355357 - 1404996 - 1420044</p> <p>APOIO CAIXA VELOCIDADES</p> <p>FORD FOCUS C-MAX (DM2): 1.6 10.2003/03.2007 74KW 100CV 1596CC - FORD FOCUS C-MAX (DM2): 1.6 Ti 08.2004/03.2007 85KW 115CV 1596CC - FORD FOCUS C-MAX (DM2): 1.8 10.2003/03.2007 88KW 120CV 1798CC - FORD FOCUS C-MAX (DM2): 1.8 04.2004/03.2007 92KW 125CV 1798CC - FORD FOCUS C-MAX (DM2): 1.8 Flexifuel 01.2006/03.2007 92KW 125CV 1798CC - FORD FOCUS C-MAX (DM2): 2.0 03.2004/03.2007 107KW 145CV 1999CC - FO...</p>		<p><b>A2380</b> NO. 1872079 - 2111961 - F1F16F012AA - F1F16F012BB</p> <p>APOIO DO MOTOR LADO DIREITO</p> <p>FORD FOCUS III 1.5 TDCi (De 09.2014 -) 70KW 95cv 1499cm3 Hatchback - FORD FOCUS III 1.5 TDCi (De 09.2014 -) 88KW 120cv 1499cm3 Hatchback - FORD FOCUS III 1.5 TDCi ECONetic (De 09.2014 -) 77kW 105cv 1499cm3 Hatchback - FORD FOCUS III Turnier 1.5 TDCi (De 09.2014 -) 70KW 95cv 1499cm3 Combi - FORD FOCUS III Turnier 1.5 TDCi (De 09.2014 -) 88KW 120cv 1499cm3 Combi - FORD FOCUS III Turnier 1.5 TDCi ECO...</p>
	<p><b>A2471</b> NO. 1684926 - 3M516P093DC - AV616P093NA</p> <p>APOIO DO MOTOR LADO CAIXA VELOCIDADES</p> <p>FORD FOCUS III: 1.5 EcoBoost 09.2014/&gt;&gt;&gt; 110KW 150CV 1498CC - FORD FOCUS III: 1.5 EcoBoost 09.2014/&gt;&gt;&gt; 134KW 182CV 1498CC - FORD FOCUS III: 1.6 EcoBoost 07.2010/&gt;&gt;&gt; 110KW 150CV 1596CC - FORD FOCUS III: 1.6 Flexifuel 07.2013/&gt;&gt;&gt; 110KW 150CV 1596CC - FORD FOCUS III: 1.6 EcoBoost 07.2010/&gt;&gt;&gt; 134KW 182CV 1596CC - FORD FOCUS III: 1.5 TDCi 09.2014/&gt;&gt;&gt; 70KW 95CV 1499CC - FORD FOCUS III: 1.5 TDCi ECONetic...</p>		<p><b>A2484</b> NO. 1437544 - 1437545 - 1798908</p> <p>APOIO DO MOTOR LADO ESQUERDO</p> <p>FORD FOCUS C-MAX</p>
	<p><b>A2484</b> NO. 1437544 - 1437545 - 1798908</p> <p>APOIO DO MOTOR LADO ESQUERDO</p> <p>FORD FOCUS II</p>		<p><b>A2484</b> NO. 1437544 - 1437545 - 1798908</p> <p>APOIO DO MOTOR LADO ESQUERDO</p> <p>FORD FOCUS III</p>
	<p><b>A2497</b> NO. 1686911 - 1701509 - 1742411 - 1753974</p> <p>APOIO DO MOTOR PARTE DA FRENTE LADO DIREITO</p> <p>FORD FOCUS III 1.5 EcoBoost (De 09.2014 Até 12.2017) 110kW 150cv 1498cm3 Hatchback - FORD FOCUS III 1.5 EcoBoost (De 09.2014 Até 12.2017) 134kW 182cv 1498cm3 Hatchback - FORD FOCUS III 1.6 EcoBoost (De 07.2010 Até 06.2014) 110kW 150cv 1596cm3 Hatchback - FORD FOCUS III 1.6 EcoBoost (De 07.2010 Até 06.2014) 134kW 182cv 1596cm3 Hatchback - FORD FOCUS III Caixa/Combi 1.5 EcoBoost (De 09.2014 -) 11333...</p>		<p><b>A2516</b> NO. 1223973 - 1224047 - 1251749 - 1255094 - 1256702 - 1315539 - 1345226 - 1376724 - 1510904</p> <p>APOIO DO MOTOR PARTE DA FRENTE LADO DIREITO</p> <p>FORD FOCUS II (DA_, HCP, DP) 2.0 TDCi (De 02.2008 Até 07.2011) 81kW 110cv 1997cm3 Hatchback - FORD FOCUS II (DA_, HCP, DP) 2.0 TDCi (De 07.2004 Até 01.2008) 98kW 133cv 1997cm3 Hatchback - FORD FOCUS II (DA_, HCP, DP) 2.0 TDCi (De 07.2004 Até 09.2012) 100kW 136cv 1997cm3 Hatchback - FORD FOCUS II Cabriolet 2.0 TDCi (De 10.2006 Até 09.2010) 100kW 136cv 1997cm3 Cabriolet - FORD FOCUS II Turnier (DA_...</p>

















	<p><b>A2516</b> NO. 1223973 - 1224047 - 1251749 - 1255094 - 1256702 - 1315539 - 1345226 - 1376724 - 1510904</p> <p>APOIO DO MOTOR PARTE DA FRENTE LADO DIREITO</p> <p>FORD FOCUS III 2.0 TDCi (De 07.2010 Até 06.2014) 103kW 140cv 1997cm3 Hatchback - FORD FOCUS III 2.0 TDCi (De 07.2010 Até 06.2014) 120kW 163cv 1997cm3 Hatchback - FORD FOCUS III 2.0 TDCi (De 07.2010 Até 06.2014) 85kW 115cv 1997cm3 Hatchback - FORD FOCUS III 2.0 TDCi (De 07.2010 Até 06.2014) 100kW 136cv 1997cm3 Hatchback - FORD FOCUS III Turnier 2.0 TDCi (De 07.2010 -) 85kW 115cv 1997cm3 Combi - FO...</p> <p>255x157x140mm 1f-d14mm 1f-14x15mm 2f-18x20mm</p>		<p><b>C0231</b> NO. 6483712 - 91AB.16C618.AA</p> <p>BOTÃO DE AFINAÇÃO DE CAPOT</p> <p>FORD FOCUS (APÓS 1998)</p> <p>d27x44mm</p>
	<p><b>E0086</b> NO. 1203093 - 1487402 - 1500682 - 1719542 - 2M51.5E494.AB - 2M51.5E494.AA - 8M51.5E494.AB - 30760236</p> <p>ESTICADOR BARRA ESTABILIZADORA TRAS ( GASTA 2 UNIDADES )</p> <p>FORD FOCUS C-MAX (DM2) 1.6 10.2003/03.2007 74KW 100CV 1596CC SHDC SHDA HWDA SHDB HWDB 8566AAL 8566542 - FORD FOCUS C-MAX (DM2) 1.6 TDCi 10.2003/03.2007 80KW 109CV 1560CC G8DB G8DA G8DD G8DF G8DE 8566AAJ 8566532 - FORD FOCUS C-MAX (DM2) 1.6 TDCi 02.2005/03.2007 66KW 90CV 1560CC HHDB HHDA 8566610 8566AAK - FORD FOCUS C-MAX (DM2) 1.6 TI 08.2004/03.2007 85KW 115CV 1596CC SIDA HXDA 8566571 8566AAM - FO...</p> <p>d31x95mm 1p-d8-120mm</p>		<p><b>E0088</b> NO. 1061631 - 1107068 - 1111769 - 1135077 - 1209035 - 1471446 - 5090811 - 5S43.3B438.AB - 98AG.3...</p> <p>ESTICADOR BARRA ESTABILIZADORA FRENTE ( GASTA 2 UNIDADES )</p> <p>FORD FOCUS I (DAW, DBW) 1.4 16V 10.1998/11.2004 55KW 75CV 1388CC FXDA FXDD FXDC FXDB 8566345 8566349 - FORD FOCUS I (DAW, DBW) 1.4 16V 10.1998/09.1999 55KW 75CV 1388CC FXDA - FORD FOCUS I (DAW, DBW) 1.6 16V 10.1998/11.2004 74KW 100CV 1596CC FYDH FYDC FYDA FYDD FYDB 8566346 8566350 - FORD FOCUS I (DAW, DBW) 1.6 16V Flexifuel 01.2002/11.2004 75KW 102CV 1596CC FYDH - FORD FOCUS I (DAW, DBW) 1.8 16V 1...</p> <p>260x25x20mm 2p-d10-27mm</p>
	<p><b>E0101</b> NO. 1135077 - 1209035</p> <p>ESTICADOR DA BARRA ESTABILIZADORA DA FRENTE</p> <p>FORD FOCUS TT</p> <p>265x25x25mm 2p-d10-30mm</p>		<p><b>E0108</b> NO. 1061702 - 1061703 - 1136725 - 1203093 - 1424805 - 1424901 - 1487402 - 1719532 - 2M51.5E494.A...</p> <p>ESTICADOR DA BARRA ESTABILIZADORA DE TRÁS</p> <p>FORD FOCUS TT</p> <p>d31x90mm 1p-d8-110mm</p>
	<p><b>E0154</b> NO. 1332463 - 2T145C486AD - 4420546</p> <p>ESTICADOR DA BARRA ESTABILIZADORA DE TRÁS</p> <p>FORD CONNECT</p> <p>170x40x40mm 2p-d12-26mm</p>		<p><b>E0155</b> NO. 1332453 - 2T14.3B438.BB - 2T143B438BA - 4367012</p> <p>ESTICADOR DA BARRA ESTABILIZADORA DA FRENTE</p> <p>FORD CONNECT</p> <p>270x32x37mm 2p-d10-24mm</p>
	<p><b>E0178</b> NO. 1223792 - 1230909 - 1686594 - 1762149 - 1851900 - 3M51.3B438.AC - 3M51.3B438.AB - AV61.3B438.AA</p> <p>ESTICADOR DA BARRA ESTABILIZADORA DA FRENTE</p> <p>FORD C-MAX (DM2): 1.6 02.2007 - 09.2010 74 KW / 100 CV 1596 CC C-MAX (DM2): 1.6 04.2007 - 09.2010 82 KW / 112 CV</p> <p>2p-d10-22mm</p>		<p><b>E0191</b> NO. 1223923 - 1231452 - 1253969 - 1304120 - 1310333 - 1335548 - 1355548 - 1469208 - 1734866 - 3...</p> <p>ESTICADOR DA BARRA ESTABILIZADORA DE TRÁS</p> <p>FORD FOCUS MKII (07-2004 A 12-2007) - FOCUS MKIII (APÓS 12-2007) - FOCUS C-MAX (06-2003 A 01-2008) - C-MAX</p> <p>90x50x40mm 1p-d10-287mm 1p-d10-22mm</p>
	<p><b>E0211-M</b> NO. 1061205 - 1070177 - 1094591 - 1102416 - 5062530 - 5208219 - 98AB.6P082.AH - 98AB.6P082.MB - 98SB.6P...</p> <p>ESTICADOR SUPORTE APOIO MOTOR TRAS</p> <p>FORD FOCUS C-MAX (DM2) 1.6 10.2003/03.2007 74KW 100CV 1596CC SHDC SHDA HWDA SHDB HWDB 8566AAL 8566542 - FORD FOCUS C-MAX (DM2) 1.6 TDCi 10.2003/03.2007 80KW 109CV 1560CC G8DB G8DA G8DD G8DF G8DE 8566AAJ 8566532 - FORD FOCUS C-MAX (DM2) 1.6 TDCi 02.2005/03.2007 66KW 90CV 1560CC HHDB HHDA 8566610 8566AAK - FORD FOCUS C-MAX (DM2) 1.6 TI 08.2004/03.2007 85KW 115CV 1596CC SIDA HXDA 8566571 8566AAM - FO...</p> <p>1798 CC</p> <p>60x85x60mm</p>		<p><b>E0251</b> NO. 1061668 - 1105524 - 1231455 - 1253735 - 1388327 - 1500111 - 1686587 - 1703145 - 1712237 - 1753556...</p> <p>ESTICADOR BRAÇO SUSPENSÃO RODA EIXO TRASEIRO TRANSVERSAL ( GASTA 2 UNIDADES )</p> <p>FOCUS C-MAX (DM2) 1.6 10.2003/03.2007 74KW 100CV 1596CC SHDC SHDA HWDA SHDB HWDB 8566AAL 8566542 - FOCUS C-MAX (DM2) 1.6 TDCi 10.2003/03.2007 80KW 109CV 1560CC G8DB G8DA G8DD G8DF G8DE 8566AAJ 8566532 - FOCUS C-MAX (DM2) 1.6 TDCi 02.2005/03.2007 66KW 90CV 1560CC HHDB HHDA 8566610 8566AAK - FOCUS C-MAX (DM2) 1.6 TI 08.2004/03.2007 85KW 115CV 1596CC SIDA HXDA 8566571 8566AAM - FOCUS C-MAX (DM2) 1.8 ...</p> <p>280x58x35mm 2d-32mm 2f-11.2mm</p>
	<p><b>E1069</b> NO. 1118220 - 98AB.5A262.EA</p> <p>ESTICADOR DE ESCAPE</p> <p>FORD FOCUS (APÓS 1998)</p> <p>75x50x34mm</p>		<p><b>E1070</b> NO. 1003890 - 1016405 - 1099277 - 1118218</p> <p>ESTICADOR DE ESCAPE</p> <p>FORD FOCUS</p> <p>70x50x27mm</p>
	<p><b>E1087</b> NO. 1022729</p> <p>ESTICADOR DO ESCAPE</p> <p>FORD FOCUS (1998)</p> <p>70x50x25mm</p>		<p><b>E24307-V</b> NO. 1332491 - XS4R7412BA</p> <p>ESTICADOR MANETE CAIXA VELOCIDADES</p> <p>FORD FOCUS II (DA_, HCP, DP) 1.6 LPG 10.2009/07.2011 85KW 115CV 1596CC SIDA 8566ATM - FORD FOCUS II (DA_, HCP, DP) 1.6 TDCi 07.2004/09.2012 74KW 100CV 1560CC MTD A G8DC 8566AKF - FORD FOCUS II (DA_, HCP, DP) 1.6 TDCi 07.2004/09.2012 80KW 109CV 1560CC G8DD G8DE G8DF G8DA G8DB 8566ABI 8566573 - FORD FOCUS II (DA_, HCP, DP) 1.6 TDCi 01.2005/09.2012 66KW 90CV 1560CC GPDA GPDB GPDC HHDB HHDA 8566ABK 856...</p> <p>d33x21x75mm 1f-13x19mm</p>

	<p><b>E24307-V</b> NO. 1332491 - XS4R7412BA</p> <p>ESTICADOR MANETE CAIXA VELOCIDADES</p> <p>FORD FOCUS II Cabriolet 2.0 10.2006/09.2010 107KW 145CV 1999CC AODB AODA SYDA AODE 8566AEY - FORD FOCUS II Cabriolet 2.0 TDCi 10.2006/09.2010 100KW 136CV 1997CC G6DD G6DB G6DA G6DG 8566AEZ</p> <p>d33x21x75mm 1f-13x19mm</p>		<p><b>E24307-V</b> NO. 1332491 - XS4R7412BA</p> <p>ESTICADOR MANETE CAIXA VELOCIDADES</p> <p>FORD FOCUS II três volumes (DB_, FCH, DH) 1.6 TDCi 04.2005/09.2012 66KW 90CV 1560CC HHDB HHDA GPDC GPDB GPDA 8566AAV 8566606 - FORD FOCUS II três volumes (DB_, FCH, DH) 1.6 TDCi 04.2005/09.2012 74KW 100CV 1560CC MTTA G8DC 8566AKE - FORD FOCUS II três volumes (DB_, FCH, DH) 1.6 TDCi 04.2005/09.2012 80KW 109CV 1560CC G8DD G8DF G8DB G8DE G8DA 8566AAU 8566605 - FORD FOCUS II três volumes (DB_, FCH, DH)...</p> <p>d33x21x75mm 1f-13x19mm</p>
	<p><b>E24307-V</b> NO. 1332491 - XS4R7412BA</p> <p>ESTICADOR MANETE CAIXA VELOCIDADES</p> <p>FORD FOCUS II Turnier (DA_, FFS, DS) 1.6 LPG 10.2009/09.2012 85KW 115CV 1596CC SIDA 8566ATN - FORD FOCUS II Turnier (DA_, FFS, DS) 1.6 TDCi 07.2004/09.2012 66KW 90CV 1560CC GPDA GPDC HHDB HHDA GPDB 8566ABL 8566601 - FORD FOCUS II Turnier (DA_, FFS, DS) 1.6 TDCi 07.2004/09.2012 74KW 100CV 1560CC MTTA G8DC 8566AKG - FORD FOCUS II Turnier (DA_, FFS, DS) 1.6 TDCi 07.2004/09.2012 80KW 109CV 1560CC G8DD...</p> <p>d33x21x75mm 1f-13x19mm</p>		<p><b>F1649-I</b> NO. 1012814 - 3043575 - 7138554 - 94FB3K661AC</p> <p>FOLE DA DIRECÇÃO ASSISTIDA LADO DIREITO E ESQUERDO</p> <p>FORD FOCUS (DAW, DBW): 1.4 16V 10.1998/11.2004 55KW 75CV 1388CC - FORD FOCUS (DAW, DBW): 1.6 16V 10.1998/11.2004 74KW 100CV 1596CC - FORD FOCUS (DAW, DBW): 1.8 DI / TDDi 08.1999/11.2004 55KW 75KW 1753CC - FORD FOCUS (DAW, DBW): 1.8 Turbo DI / TDDi 10.1998/11.2004 66KW 90CV 1753CC - FORD FOCUS (DAW, DBW): 1.8 TDCi 08.2002/11.2004 74KW 100CV 1753CC - FORD FOCUS (DAW, DBW): 1.8 TDCi 03.2001/11.2004 8...</p> <p>d70x190mm 1f-d55mm 1f-d12mm</p>
	<p><b>F1662-I</b> NO. 1061879 - 1061881 - 1117223 - 1119227 - 1349166 - XS4J.4A084.BB</p> <p>FOLE DA TRANSMISSÃO LADO DA CAIXA</p> <p>FORD FOCUS 1.4i - 1.6i - 1.8i - 1.8 TDCi - 1.8 TDDi - 2.0i (1998 A 2004)</p> <p>d78x85mm 1f-d70mm 1f-d28mm</p>		<p><b>F1663-I</b> NO. 1061879 - 1061881 - 1117220 - 1117223 - 1119227 - 1349166 - XS4C3L537A1A - XS4J.4A084.BB</p> <p>FOLE TRANSMISSÃO LADO DA CAIXA</p> <p>FORD FOCUS 1.8 - 1.8 TD - 2.0 (APÓS 1998)</p> <p>d86x88mm 1f-d77mm 1f-d28mm</p>
	<p><b>F1664-I</b> NO. 102321 - 1061864 - 1061867 - 1073947 - XS4C3A331B1A</p> <p>FOLE DA TRANSMISSÃO LADO DA RODA</p> <p>FORD FOCUS 1.4i - 1.6i - 1.8i - 1.8 TDDi 2.0i (1998 A 2004)</p> <p>d96x102mm 1f-d78mm 1f-d28mm</p>		<p><b>F1716-T</b> NO. 1085517 - 3043575 - 6182818 - 87BB3K661AA</p> <p>FOLE DA DIRECÇÃO ASSISTIDA DIREITO E ESQUERDO</p> <p>FORD FOCUS (APÓS 1998) 1.4 - 1.6 - 1.8 - 1.8 TDDi - 2.0</p> <p>d61x190mm 1f-d46mm 1f-d13mm</p>
	<p><b>F1821-I</b> NO. 1061879 - 1061881 - 1117220 - 1117223 - 1119227 - 1349166 - 46308544 - XS4C3L537A1A - XS4J.4A0...</p> <p>FOLE DA TRANSMISSÃO JUNTO À CAIXA</p> <p>FORD FOCUS I 1.4i 16V - 1.6i 16V - 1.8TDCi - 1.8TDDi - 1.8i 16V - 2.0i 16V (98 A 04)</p> <p>d77x85mm 1f-d72mm 1f-d28mm</p>		<p><b>F4037</b> NO. YC153K661BA - 4059922 - 4602027 - YC153K661BB</p> <p>FOLE DIRECÇÃO (GASTA 2 UNIDADES)</p> <p>FORD FOCUS APÓS 1998 - 1.4 - 1.6 - 1.8 - 1.8 TDDi - 2.0</p> <p>d72/54x240mm 1f-d68mm 1f-d10mm</p>
	<p><b>F4038</b> NO. 1061720 - 98AG3K036AB</p> <p>FOLE GAPA PROTECÇÃO AMORTECEDOR FRENTE (GASTA 2 UNIDADES)</p> <p>FORD FOCUS APÓS 1998 - 1.4 - 1.6 - 1.8 - 1.8 TDDi - 2.0</p> <p>d90/65x180mm 1f-d61mm 1f-d21mm</p>		<p><b>F4154</b> NO. 1318360 - 1342945 - 1430852 - 4M51-A045B79-EG - 4M51A045B79EG3ZHE</p> <p>FOLE ALAVANCA VELOCIDADES</p> <p>FORD FOCUS 2004-2012 MK II ESTATE 1.4 80CV 1388CC - FORD FOCUS 1.6 100CV 1596CC - FORD FOCUS 1.6 TDCi 100CV/109CV/90CV 1506CC - FORD FOCUS 1.6 Ti 115CV 1560CC - FORD 1.8 TDCi 115CV 1753CC - FORD FOCUS 2.0 145CV 1999CC - FORD FOCUS 2.0 TDCi 133/136CV 1997CC</p> <p>120x108x139mm 1f-d12mm 1f-110x97mm</p>
	<p><b>F4154</b> NO. 1070042 - 98AB A044L48 BDYYFY - 98AB A044L48 BDYYFZ</p> <p>FOLE ALAVANCA VELOCIDADES</p> <p>FORD C-MAX 2003/2007 1.4 80CV 1388CC - FORD C-MAX 1.6 100CV 1596CC - FORD C-MAX 1.6 TDCi 100CV/109CV/90CV 1506CC - FORD C-MAX 1.6 Ti 115CV 1560CC - FORD C-MAX 1.8 TDCi 115CV 1753CC - FORD C-MAX 2.0 145CV 1999CC - FORD C-MAX 2.0 TDCi 133CV/136CV 1997CC</p> <p>120x108x139mm 1f-d12mm 1f-110x97mm</p>		<p><b>F4155</b> NO. 8M5R7H409AKA</p> <p>FOLE ALAVANCA VELOCIDADES</p> <p>FORD FOCUS 2008 MK II 2008/2012 ESTATE 1.4 80CV 1388CC - 1.6 100CV 1596CC - FORD FOCUS 1.6 TDCi 100CV/109CV/90CV 1506CC - FORD FOCUS 1.6 Ti 115CV 1560CC - FORD FOCUS 1.8 TDCi 115CV 1753CC - FORD FOCUS 2.0 145CV 1999CC - FORD FOCUS 2.0 TDCi 133CV/136CV 1997CC</p> <p>120x110x160mm 1f-d10mm 1f-105x105x95mm</p>
	<p><b>F4156</b> NO. 1070042 - 98AB A044L48 BDYYFY - 98AB A044L48 BDYYFZ</p> <p>FOLE ALAVANCA TRAVÃO DE MÃO</p> <p>FORD FOCUS MK1 DFW 1998/2005 SALOON 1.4 16V 75CV 1388CC - FORD FOCUS 1.6 16V 100CV 1596CC - FORD FOCUS 1.8 16V 115CV 1796CC - FORD FOCUS 1.8 Turbo DI/TDDi 90CV 1753CC - FORD FOCUS 2.0 16V 131CV 1988CC</p> <p>185x61x180mm 1f-d14mm 1f-162x54mm</p>		<p><b>F4156</b> NO. 1070042 - 98AB A044L48 BDYYFY - 98AB A044L48 BDYYFZ</p> <p>FOLE ALAVANCA TRAVÃO DE MÃO</p> <p>Ford Focus 2005 Diesel Saloon 1.8 Turbo DI / TDDi FWD DFW 1753CC 55KW 75HP BHDA;BHDB - Ford Focus 2005 Petrol/Liquidified Petroleum Gas (LPG) Estate 1.8 BiFuel FWD DNW 1796CC 82KW 111HP EYDL - Ford Focus 2004 Diesel Estate 1.8 DI / TDDi FWD DNW 1753CC 55KW 75HP BHDA;BHDB - Ford Focus 2004 Diesel Estate 1.8 TDCi FWD DNW 1753CC 74KW 100HP FFDA - Ford Focus 2004 Diesel Estate 1.8 TDCi FWD DNW 1753CC 85...</p> <p>185x61x180mm 1f-d14mm 1f-162x54mm</p>

	<p><b>F4185</b> NO. 1548262 - 8M5R-7H409-BKA</p> <p>FOLE ALAVANCA VELOCIDADES C/ MANETE PUNHO TOPO COMPLETO 5 VELOCIDADES                      FORD FOCUS MK2FL 2008/2011 1.6L TDCI 90CV - FORD FOCUS MK2FL 2008/2011 1.6L 110CV - FORD FOCUS MK2FL 2008/2011 1.6L GASOLINA</p> <p>133x107x230mm 1f-122x106mm</p>		<p><b>F4194</b> NO. 1574600 - 1580939 - 7M5R7H409AAB - AM8A6J7J132BB</p> <p>FOLE ALAVANCA VELOCIDADES C/ MANETE PUNHO TOPO COMPLETO 5 VELOCIDADES                      FORD FOCUS C-MAX (DM2): 1.8 09.2005/03.2007 90KW 122CV 1798CC - FORD FOCUS C-MAX (DM2): 1.6 TDCi 02.2005/03.2007 66KW 90CV 1560CC - FORD FOCUS C-MAX (DM2): 1.8 TDCi 01.2005/03.2007 85KW 115CV 1753CC</p> <p>121x113x222mm 1f-111x101mm</p>
	<p><b>F4194</b> NO. 1574600 - 1580939 - 7M5R7H409AAB - AM8A6J7J132BB</p> <p>FOLE ALAVANCA VELOCIDADES C/ MANETE PUNHO TOPO COMPLETO 5 VELOCIDADES                      FORD FOCUS II (DA_, HCP, DP): 2.5 ST 10.2005/09.2012 166KW 225CV 2522CC - FORD FOCUS II (DA_, HCP, DP): 1.6 TDCi 01.2005/09.2012 66KW 90CV 1560CC - FORD FOCUS II (DA_, HCP, DP): 1.8 TDCi 01.2005/09.2012 85KW 115CV 1753CC - FORD FOCUS II três volumes (DB_, FCH, DH): 1.4 04.2005/09.2012 59KW 80CV 1388CC - FORD FOCUS II três volumes (DB_, FCH, DH): 1.6 04.2005/09.2012 74KW 100CV 1596CC - FORD FOCUS I...</p> <p>121x113x222mm 1f-111x101mm</p>		<p><b>F4195</b> NO. 1548261 - 7M5R7H409BAA</p> <p>FOLE ALAVANCA VELOCIDADES C/ MANETE PUNHO TOPO COMPLETO 5 VELOCIDADES                      FORD FOCUS C-MAX (DM2): 1.6 10.2003/03.2007 74KW 100CV 1596CC - FORD FOCUS C-MAX (DM2): 1.6 TDCi 10.2003/03.2007 80KW 109CV 1560CC</p> <p>140x117x257mm 1f-119x97mm</p>
	<p><b>F4236</b> NO. 1223834 - 1305329</p> <p>FOLE CAPA PROTEÇÃO AMORTECEDOR FRENTE ( GASTA 2 UNIDADES )                      FORD FOCUS II (DA_, HCP, DP): 2.0 07.2004/09.2012 107KW 145CV 1999CC - FORD FOCUS II (DA_, HCP, DP): 2.5 ST 10.2005/09.2012 166KW 225CV 2522CC - FORD FOCUS II três volumes (DB_, FCH, DH): 2.0 04.2005/07.2011 107KW 145CV 1999CC - FORD FOCUS II Turnier (DA_, FFS, DS): 2.0 07.2004/09.2012 107KW 145CV 1999CC - FORD FOCUS II Caixa/Combi: 1.6 Ti-VCT 09.2005/07.2011 85KW 116CV 1596CC - FORD FOCUS II Caix...</p> <p>d79x241mm 1f-d61mm 1f-d64mm</p>		<p><b>F4236</b> NO. 1223834 - 1305329</p> <p>FOLE CAPA PROTEÇÃO AMORTECEDOR FRENTE ( GASTA 2 UNIDADES )                      FORD FOCUS III: 1.0 EcoBoost 02.2012/&gt;&gt;&gt;&gt; 74KW 100CV 998CC - FORD FOCUS III: 1.0 EcoBoost 02.2012/&gt;&gt;&gt;&gt; 92KW 125CV 998CC - FORD FOCUS III: 1.0 EcoBoost 10.2017/&gt;&gt;&gt;&gt; 103KW 140CV 998CC - FORD FOCUS III: 1.5 EcoBoost 09.2014/&gt;&gt;&gt;&gt; 110KW 150CV 1498CC - FORD FOCUS III: 1.5 EcoBoost 09.2014/&gt;&gt;&gt;&gt; 134KW 182CV 1498CC - FORD FOCUS III: 1.6 Ti 08.2011/&gt;&gt;&gt;&gt; 63K2 85CV 1596CC - FORD FOCUS III: 1.6 Ti 07.2010/&gt;&gt;&gt;&gt; 77KW 1...</p> <p>d79x241mm 1f-d61mm 1f-d64mm</p>
	<p><b>F4265</b> NO. 3M517Z289AD</p> <p>FOLE ALAVANCA VELOCIDADES                      FORD FOCUS C-MAX (DM2) 1.6 (De 10.2003 Até 03.2007) 74kW 100cv 1596cm3 Veículo multiuso - FORD FOCUS C-MAX (DM2) 1.6 TDCi (De 02.2005 Até 03.2007) 66kW 90cv 1560cm3 Veículo multiuso - FORD FOCUS C-MAX (DM2) 1.6 TDCi (De 10.2003 Até 03.2007) 80kW 109cv 1560cm3 Veículo multiuso - FORD FOCUS C-MAX (DM2) 1.6 Ti (De 08.2004 Até 03.2007) 85kW 115cv 1596cm3 Veículo multiuso - FORD FOCUS C-MAX (DM2) 1.8 (...)</p> <p>135x127x105mm 1f-124x93mm</p>		<p><b>F4304</b> NO. 1205907 - 1216373 - 2M51 7B118 ABYYFZ</p> <p>FOLE ALAVANCA VELOCIDADES                      FORD FOCUS I (DAW, DBW) 1.4 16V 10.1998/11.2004 55KW 75CV 1388CC FXDA FXDD FXDC FXDB 8566345 8566349 - FORD FOCUS I (DAW, DBW) 1.6 16V 10.1998/11.2004 74KW 100CV 1596CC FYDH FYDC FYDA FYDD FYDB 8566346 8566350 - FORD FOCUS I (DAW, DBW) 1.8 16V 10.1998/11.2004 85KW 115CV 1796CC EYDJ EYDL EYDI EYDG EYDC EYDF EYDD EYDE EYDB 8566347 8566351 - FORD FOCUS I (DAW, DBW) 1.8 DI / TDDi 08.1999/11.2004 55KW ...</p> <p>162x158x120mm 1f-132x100mm</p>
	<p><b>F4316</b> NO. 1318360 - 1324957 - 1330115 - 1331570 - 1334955 - 1340103 - 1342945 - 4M51A045B79</p> <p>FOLE ALAVANCA VELOCIDADES                      FORD FOCUS II (DA_, HCP, DP) 1.4 07.2004/09.2012 59KW 80CV 1388CC ASDB ASDA 8566583 8566ABC - FORD FOCUS II (DA_, HCP, DP) 1.6 07.2004/09.2012 74KW 100CV 1596CC SHDC SHDB HWDA HWDB SHDA 8566ABN 8566572 - FORD FOCUS II (DA_, HCP, DP) 1.6 LPG 10.2009/07.2011 85KW 115CV 1596CC SIDA 8566ATM - FORD FOCUS II (DA_, HCP, DP) 1.6 TDCi 07.2004/09.2012 74KW 100CV 1560CC MTD A G8DC 8566AKF - FORD FOCUS II (DA_...)</p> <p>107x107x104mm 111x100mm</p>		<p><b>F4317</b> NO. 8M5R7H409BK</p> <p>FOLE ALAVANCA VELOCIDADES C/ ARO CROMADO                      FORD FOCUS C-MAX (DM2) 1.6 10.2003/03.2007 74KW 100CV 1596CC SHDC SHDA HWDA SHDB HWDB 8566AAL 8566542 - FORD FOCUS C-MAX (DM2) 1.6 TDCi 10.2003/03.2007 80KW 109CV 1560CC G8DB G8DA G8DD G8DF G8DE 8566AAJ 8566532 - FORD FOCUS C-MAX (DM2) 1.6 TDCi 02.2005/03.2007 66KW 90CV 1560CC HHDB HDA 8566610 8566AAK - FORD FOCUS C-MAX (DM2) 1.6 Ti 08.2004/03.2007 85KW 115CV 1596CC SIDA HXDA 8566571 8566AAM - FO...</p> <p>170x157x137mm 1f-120x108mm</p>
	<p><b>F4317</b> NO. 8M5R7H409BK</p> <p>FOLE ALAVANCA VELOCIDADES C/ ARO CROMADO                      FORD FOCUS II (DA_, HCP, DP) 1.4 07.2004/09.2012 59KW 80CV 1388CC ASDB ASDA 8566583 8566ABC - FORD FOCUS II (DA_, HCP, DP) 1.6 07.2004/09.2012 74KW 100CV 1596CC SHDC SHDB HWDA HWDB SHDA 8566ABN 8566572 - FORD FOCUS II (DA_, HCP, DP) 1.6 LPG 10.2009/07.2011 85KW 115CV 1596CC SIDA 8566ATM - FORD FOCUS II (DA_, HCP, DP) 1.6 TDCi 07.2004/09.2012 74KW 100CV 1560CC MTD A G8DC 8566AKF - FORD FOCUS II (DA_...)</p> <p>170x157x137mm 1f-120x108mm</p>		<p><b>F4318</b> NO. 1548262 - 8M5R7H409BKA</p> <p>FOLE ALAVANCA VELOCIDADES                      FORD FOCUS II (DA_, HCP, DP) 1.4 07.2004/09.2012 59KW 80CV 1388CC ASDB ASDA 8566583 8566ABC - FORD FOCUS II (DA_, HCP, DP) 1.6 07.2004/09.2012 74KW 100CV 1596CC SHDC SHDB HWDA HWDB SHDA 8566ABN 8566572 - FORD FOCUS II (DA_, HCP, DP) 1.6 LPG 10.2009/07.2011 85KW 115CV 1596CC SIDA 8566ATM - FORD FOCUS II (DA_, HCP, DP) 1.6 TDCi 07.2004/09.2012 74KW 100CV 1560CC MTD A G8DC 8566AKF - FORD FOCUS II (DA_...)</p> <p>175x130x118mm 1f-123x110mm</p>
	<p><b>F9011H-I</b> NO. 1061867 - 1119226 - 1119227 - 1306052 - 1349165 - 1355188 - 1360390 - 1363787 - 1447559 - 1447560 - ...</p> <p>FOLE DA TRANSMISSÃO JUNTO Á RODA                      FORD FOCUS (DAW - DBW) 1.4 16V (De 10-1998 Até 11-2004) 55kW 75CV 1388cc Hatchback FORD FOCUS (DAW - DBW) 1.6 16V (De 10-1998 Até 11-2004) 74kW 100CV 1596cc Hatchback FORD FOCUS (DAW - DBW) 1.8 16V (De 10-1998 Até 11-2004) 85kW 115CV 1796cc Hatchback FORD FOCUS (DAW - DBW) 2.0 16V (De 10-1998 Até 11-2004) 96kW 131CV 1988cc Hatchback FORD FOCUS (DAW - DBW) ST170 (De 03-2002 Até 11-2004) 127kW 1...</p> <p>d95x109mm 1f-d31mm 1f-d79mm</p>		<p><b>F9011H-I</b> NO. 1061867 - 1119226 - 1119227 - 1306052 - 1349165 - 1355188 - 1360390 - 1363787 - 1447559 - 1447560 - ...</p> <p>FOLE DA TRANSMISSÃO JUNTO Á RODA                      FORD FOCUS C-MAX 1.6 TDCi (De 02-2005 Até 03-2007) 66kW 90CV 1560cc Veículo multiuso FORD FOCUS C-MAX 1.6 TDCi (De 10-2003 Até 03-2007) 80kW 109CV 1560cc Veículo multiuso</p> <p>d95x109mm 1f-d31mm 1f-d79mm</p>
	<p><b>F9011H-I</b> NO. 1061867 - 1119226 - 1119227 - 1306052 - 1349165 - 1355188 - 1360390 - 1363787 - 1447559 - 1447560 - ...</p> <p>FOLE DA TRANSMISSÃO JUNTO Á RODA                      FORD FOCUS II (DA_ - HCP) 1.6 TDCi (De 01-2005 Até 09-2012) 66kW 90CV 1560cc Hatchback FORD FOCUS II (DA_ - HCP) 1.6 TDCi (De 07-2004 Até 09-2012) 80kW 109CV 1560cc Hatchback FORD FOCUS II (DA_ - HCP) 1.8 TDCi (De 01-2005 Até 09-2012) 85kW 115CV 1753cc Hatchback</p> <p>d95x109mm 1f-d31mm 1f-d79mm</p>		<p><b>F9011H-I</b> NO. 1061867 - 1119226 - 1119227 - 1306052 - 1349165 - 1355188 - 1360390 - 1363787 - 1447559 - 1447560 - ...</p> <p>FOLE DA TRANSMISSÃO JUNTO Á RODA                      FORD FOCUS II três volumes (DB_ - FCH) 1.6 TDCi (De 04-2005 Até 09-2012) 66kW 90CV 1560cc três volumes FORD FOCUS II três volumes (DB_ - FCH) 1.6 TDCi (De 04-2005 Até 09-2012) 80kW 109CV 1560cc três volumes FORD FOCUS II três volumes (DB_ - FCH) 1.8 TDCi (De 04-2005 Até 09-2012) 85kW 115CV 1753cc três volumes</p> <p>d95x109mm 1f-d31mm 1f-d79mm</p>

	<p><b>F9011H-I</b> NO. 1061867 - 1119226 - 1119227 - 1306052 - 1349165 - 1355188 - 1360390 - 1363787 - 1447559 - 1447560 - ...</p> <p>FOLE DA TRANSMISSÃO JUNTO À RODA</p> <p>FORD FOCUS II Turnier (DA_ - FFS) 1.6 TDCi (De 07-2004 Até 09-2012) 66kW 90CV 1560cc Combi FORD FOCUS II Turnier (DA_ - FFS) 1.6 TDCi (De 07-2004 Até 09-2012) 80kW 109CV 1560cc Combi FORD FOCUS II Turnier (DA_ - FFS) 1.8 TDCi (De 07-2004 Até 09-2012) 85kW 115CV 1753cc Combi</p> <p>d95x109mm 1f-d31mm 1f-d79mm</p>		<p><b>KF1607</b> NO. 1329826 - 3M514A084-MA</p> <p>KIT DE FOLE DO CARDAN JUNTO À RODA</p> <p>FORD FOCUS 1.6 TDCi - 1.8i - 2.0i (APÓS 2004) - FOCUS C-MAX 1.6 TDCi - 1.8i (APÓS 2003)</p> <p>d90x90mm 1f-d78mm 1f-d21mm</p>
	<p><b>KF1685-T</b> NO. 3M514C062BA</p> <p>KIT DE FOLE DO CARDAN JUNTO À RODA</p> <p>FORD FOCUS II (APÓS 2004) 1.6i</p> <p>d96x123mm 1f-d82mm 1f-d24mm</p>		<p><b>KF1896-I</b> NO. 1444324 - 1501164 - 1501167 - 1552978</p> <p>KIT DE FOLE DO CARDAN JUNTO À CAIXA</p> <p>FORD FOCUS C-MAX (DM2) 2.0 TDCi 10.2003/03.2007 98KW 133CV 1997CC G6DF G6DE G6DC 8566AAI 8566541 - FORD FOCUS C-MAX (DM2) 2.0 TDCi 10.2003/03.2007 100KW 136CV 1997CC G6DG G6DD G6DB G6DA 8566AAH 8566531</p> <p>d96x87mm 1f-d84mm 1f-d21mm</p>
	<p><b>KF1896-I</b> NO. 1444324 - 1501164 - 1501167 - 1552978</p> <p>KIT DE FOLE DO CARDAN JUNTO À CAIXA</p> <p>FORD FOCUS II (DA_ , HCP, DP) 2.0 TDCi 07.2004/09.2012 100KW 136CV 1997CC G6DD G6DG G6DA G6DB 8566575 8566ABE - FORD FOCUS II Cabriolet 2.0 TDCi 10.2006/09.2010 100KW 136CV 1997CC G6DD G6DB G6DA G6DG 8566AEZ - FORD FOCUS II três volumes (DB_ , FCH, DH) 2.0 TDCi 04.2005/09.2012 100KW 136CV 1997CC G6DD G6DB G6DA G6DG 8566AAS 8566604 - FORD FOCUS II Turnier (DA_ , FFS, DS) 2.0 TDCi 07.2004/09.2012 100KW...</p> <p>d96x87mm 1f-d84mm 1f-d21mm</p>		<p><b>KF2271-T</b> NO. 2M54V4A084-AA - 2T14.4A084.CA - 4371803 - 4511120</p> <p>KIT DE FOLE DO CARDAN JUNTO À RODA</p> <p>FORD FOCUS I 2.0i ST170 (1998 A 2004) - TRANSIT CONNECT 1.8 Di (APÓS 2002)</p> <p>d105x125mm 1f-d83mm 1f-d25mm</p>
	<p><b>KF3760-T</b> NO. 1461280 - 1552971 - 1790570</p> <p>KIT DE FOLE DO CARDAN JUNTO À RODA</p> <p>FORD FOCUS</p> <p>d106x122mm 1f-d82mm 1f-d24mm</p>		<p><b>KF9004</b> NO. 1061879 - 1061881 - 1117220 - 1117223 - 1119227 - 1349166 - XS4C3L537A1A - XS4J.4A084.BB - XS4J...</p> <p>KIT DE FOLE DO CARDAN LADO DA CAIXA</p> <p>FORD FOCUS APÓS 1998</p> <p>d78x84mm 1f-d70mm 1f-d28mm</p>
	<p><b>KF9005</b> NO. 1349165 - XS4J4A084DA</p> <p>KIT DE FOLE DO CARDAN LADO DA RODA</p> <p>FORD FOCUS (APÓS 1998)</p> <p>d96x112mm 1f-d80mm 1f-d31mm</p>		<p><b>KF9006</b> NO. 1063498 - 1113729 - 1152464 - XS41.4A084.HB - XS414A084HA - XS4C.3B413.BA</p> <p>KIT DE FOLE DO CARDAN LADO DA RODA</p> <p>FORD FOCUS (APÓS 1998)</p> <p>d90x131mm 1f-d80mm 1f-d25mm</p>
	<p><b>KF9018</b> NO. 7M514C062EA</p> <p>KIT DE FOLE DO CARDAN LADO DA RODA</p> <p>FORD FOCUS (APÓS 2007)</p> <p>110x120mm 1f-d85mm 1f-d29mm</p>		<p><b>KF9019</b> NO. 1501167 - 7M514C062AA</p> <p>KIT DE FOLE DO CARDAN LADO DA RODA</p> <p>FORD FOCUS II (DA_) 2.0 TDCi Hatchback(02.08 - 07.11) 110cv 1997cc - FORD FOCUS II (DA_) 2.0 TDCi Hatchback (11.04 - 01.08) 133cv 1997cc - FORD FOCUS II (DA_) 2.0 TDCi Hatchback (11.04 - 09.12) 136cv 1997cc - FORD FOCUS II Combi (DA_) 2.0 TDCi (02.08 - 07</p> <p>105x120mm 1f-d85mm 1f-d38mm</p>
	<p><b>KUBT3015</b> NO. 1075553 - 1075554</p> <p>KIT BORRACHAS TRAVAO PINÇA DE TRAS C/EMBOLO LUCAS/TRW 34MM</p> <p>FORD FOCUS (DAW, DBW): 1.4 16V 10.1998/11.2004 55KW 75CV 1388CC - FORD FOCUS (DAW, DBW): 1.6 16V 10.1998/11.2004 74KW 100CV 1596CC - FORD FOCUS (DAW, DBW): 1.8 DI / TDDi 08.1999/11.2004 55KW 75CV 1753CC - FORD FOCUS (DAW, DBW): 1.8 TDCi 03.2001/11.2004 85KW 115CV 1753CC - FORD FOCUS (DAW, DBW): 1.8 16V 10.1998/11.2004 85KW 115CV 1796CC - FORD FOCUS (DAW, DBW): 2.0 16V 10.1998/11.2004 96KW 131CV 19...</p> <p>d34x48mm d45x11mm d41x12mm 1f-d8mm 1f-d25mm 1f-d36mm</p>		<p><b>KUE20209</b> NO. ---</p> <p>KIT REPARAÇÃO ELEVADOR DE PORTA (KIT COMPLETO) (PORTA ESQUERDA)</p> <p>FORD FOCUS (1998 Até 2005)</p> <p>118x24x19mm 59x35x29mm 60x33x29mm</p>
	<p><b>KUE20210</b> NO. ---</p> <p>KIT REPARAÇÃO ELEVADOR DE PORTA (KIT COMPLETO) (PORTA DIREITA)</p> <p>FORD FOCUS (1998 Até 2005)</p> <p>118x24x19mm 59x35x29mm 60x33x29mm</p>		<p><b>L3080</b> NO. 1061703 - 11503258 - 1150358 - 1M5Q5776AA - 98AG.5776.AB - YS4Z.5495.AA</p> <p>CASQUILHO DA BARRA ESTABILIZADORA DE TRÁS</p> <p>FORD FOCUS APÓS 1998</p> <p>d31x62mm 1f-d8mm</p>



	<p><b>P1048</b> NO. 1029040 - 1076899 - 6789917 - 94BB.7A624.AA - 94BB7A642AA - 97KB.2457.AB - 98AB.7A624.AA</p> <p>CAPA DE PEDAL DO TRAVÃO E EMBRAIAGEM</p> <p>FORD FOCUS (DAW, DBW): 1.4 16V 10.1998/11.2004 55KW 75CV 1388CC - FORD FOCUS (DAW, DBW): 1.6 16V 10.1998/11.2004 74KW 100CV 1596CC - FORD FOCUS (DAW, DBW): 1.8 DI / TDDi 08.1999/11.2004 55KW 75CV 1753CC - FORD FOCUS (DAW, DBW): 1.8 Turbo DI / TDDi 10.1998/11.2004 66KW 90CV 1753CC - FORD FOCUS (DAW, DBW): 1.8 TDCi 08.2002/11.2004 74KW 100CV 1753CC - FORD FOCUS (DAW, DBW): 1.8 TDCi 03.2001/11.2004 8...</p> <p>75x55x8mm</p>		<p><b>P1120</b> NO. 1251921 - 3M512457AA</p> <p>CAPA DE PEDAL DO TRAVÃO E EMBRAIAGEM</p> <p>FORD FOCUS II (DA_, HCP, DP): 1.4 07.2004/09.2012 59KW 80CV 1388CC - FORD FOCUS II (DA_, HCP, DP): 1.6 07.2004/09.2012 74KW 100CV 1596CC - FORD FOCUS II (DA_, HCP, DP): 1.6 Ti 07.2004/09.2012 85KW 115CV 1596CC - FORD FOCUS II (DA_, HCP, DP): 1.6 LPG 10.2009/07.2011 85KW 115CV 1596CC - FORD FOCUS II (DA_, HCP, DP): 1.8 03.2006/09.2012 92KW 125CV 1798CC - FORD FOCUS II (DA_, HCP, DP): 1.8 Flexifuel ...</p> <p>50x61x13mm 37x44mm</p>
	<p><b>P1120</b> NO. 1251921 - 3M512457AA</p> <p>CAPA DE PEDAL DO TRAVÃO E EMBRAIAGEM</p> <p>FOR FOCUS C-MAX</p> <p>50x61x13mm 37x44mm</p>		<p><b>R221362</b> NO. 1061215 - 1085687 - 1134580 - 98AB8B273EE - 98AB8B273EF - 98AB8B273EG</p> <p>TUBO INFERIOR DO RADIADOR</p> <p>FORD FOCUS I (DAW, DBW) 1.4 16V 10.1998/11.2004 55KW 75CV 1388CC FXDA FXDD FXDC FXDB 8566345 8566349 - FORD FOCUS I (DAW, DBW) 1.6 16V 10.1998/11.2004 74KW 100CV 1596CC FYDH FYDC FYDA FYDD FYDB 8566346 8566350 - FORD FOCUS I três volumes (DFW) 1.4 16V 02.1999/11.2004 55KW 75CV 1388CC FXDA FXDC FXDD FXDB 8566464 - FORD FOCUS I três volumes (DFW) 1.6 16V 02.1999/11.2004 74KW 100CV 1596CC FYDH FYDC F...</p> <p>B365-d30/30mm 90-90-150-40-130mm</p>
	<p><b>R221365</b> NO. 1062369 - 1077968 - 1136603 - 1148060 - 98AB18K579EE - 98AB18K579EF - 98AB18K579EG - 98AB18K579EH</p> <p>TUBO DO PERMUTADOR DO CALOR</p> <p>FORD FOCUS I (DAW, DBW) 1.4 16V 10.1998/11.2004 55KW 75CV 1388CC FXDA FXDD FXDC FXDB 8566345 8566349 - FORD FOCUS I (DAW, DBW) 1.4 16V 10.1998/09.1999 55KW 75CV 1388CC FXDA - FORD FOCUS I (DAW, DBW) 1.6 16V 10.1998/11.2004 74KW 100CV 1596CC FYDH FYDC FYDA FYDD FYDB 8566346 8566350 - FORD FOCUS I Caixa/Combi (DNW) 1.4 04.1999/03.2005 55KW 75CV 1388CC FXDC FXDA FXDB FXDD - FORD FOCUS I Caixa/Combi (...)</p> <p>B440-16/23mm 68-33-66-265-72-150- 46mm</p>		<p><b>R221366</b> NO. 1076258 - 1101018 - 1134873 - 98AB18K359EK - 98AB18K359EL</p> <p>TUBO DO PERMUTADOR DO CALOR</p> <p>FORD FOCUS I (DAW, DBW) 1.4 16V 10.1998/11.2004 55KW 75CV 1388CC FXDA FXDD FXDC FXDB 8566345 8566349 - FORD FOCUS I (DAW, DBW) 1.6 16V 10.1998/11.2004 74KW 100CV 1596CC FYDH FYDC FYDA FYDD FYDB 8566346 8566350 - FORD FOCUS I três volumes (DFW) 1.4 16V 02.1999/11.2004 55KW 75CV 1388CC FXDA FXDC FXDD FXDB 8566464 - FORD FOCUS I três volumes (DFW) 1.6 16V 02.1999/11.2004 74KW 100CV 1596CC FYDH FYDC FYDA FYDD...</p> <p>B430-14/16mm 67-47-225-117-218mm</p>
	<p><b>R221398</b> NO. 1007797</p> <p>TUBO LIGAÇÃO PERMUTADOR DE CALOR</p> <p>FORD FOCUS (DAW, DBW) 1.4 16V (De 1998.10 Até 2004.11) 55KW 75cv 1388cm3 Hatchback -</p> <p>B190-9/9mm 37-144-33mm ch-d16mm 24-25-20mm</p>		<p><b>R222414</b> NO. 1061214 - 1134579 - 1311177 - 98AB8B273DG - 98AB8B273DH - 98AB8B273DF</p> <p>TUBO INFERIOR DO RADIADOR</p> <p>FORD FOCUS I (DAW, DBW) 1.8 DI / TDDi 08.1999/11.2004 55KW 75CV 1753CC BHDB BHDA 8566402 8566377 - FORD FOCUS I (DAW, DBW) 1.8 TDCi 03.2001/11.2004 85KW 115CV 1753CC F9DB F9DA 8566460 8566459 - FORD FOCUS I (DAW, DBW) 1.8 TDCi 08.2002/11.2004 74KW 100CV 1753CC FFDA 8566510 8566509 - FORD FOCUS I (DAW, DBW) 1.8 Turbo DI / TDDi 10.1998/11.2004 66KW 90CV 1753CC C9DC C9DB C9DA 8566368 8566369 - FORD F...</p> <p>B400-d30/30mm 130-140-150-80-75mm</p>
	<p><b>R222415</b> NO. 1061209 - 1072458 - 98AB8B273AF</p> <p>TUBO INFERIOR DO RADIADOR</p> <p>FORD FOCUS I (DAW, DBW) 1.4 16V 10.1998/11.2004 55KW 75CV 1388CC FXDA FXDD FXDC FXDB 8566345 8566349 - FORD FOCUS I (DAW, DBW) 1.6 16V 10.1998/11.2004 74KW 100CV 1596CC FYDH FYDC FYDA FYDD FYDB 8566346 8566350 - FORD FOCUS I três volumes (DFW) 1.4 16V 02.1999/11.2004 55KW 75CV 1388CC FXDA FXDC FXDD FXDB 8566464 - FORD FOCUS I três volumes (DFW) 1.6 16V 02.1999/11.2004 74KW 100CV 1596CC FYDH FYDC F...</p> <p>B335-d31/31mm 70-100-210-100-100mm</p>		<p><b>R222425</b> NO. 1061220 - 1134058 - 98AB8B274DG</p> <p>TUBO SUPERIOR DO RADIADOR</p> <p>FORD FOCUS I (DAW, DBW) 1.8 DI / TDDi 08.1999/11.2004 55KW 75CV 1753CC BHDB BHDA 8566402 8566377 - FORD FOCUS I (DAW, DBW) 1.8 TDCi 03.2001/11.2004 85KW 115CV 1753CC F9DB F9DA 8566460 8566459 - FORD FOCUS I (DAW, DBW) 1.8 Turbo DI / TDDi 10.1998/11.2004 66KW 90CV 1753CC C9DC C9DB C9DA 8566368 8566369 - FORD FOCUS I Turmier (DNW) 1.8 DI / TDDi 08.1999/11.2004 55KW 75CV 1753CC BHDB BHDA 8566378 - FO...</p> <p>B415-d30/30mm 90-135-100-135-100-80mm</p>
	<p><b>R222426</b> NO. 1076923 - 1096829 - 1134581 - 98AB8B274AH - 98AB8B274AJ</p> <p>TUBO SUPERIOR DO RADIADOR</p> <p>FORD FOCUS 1.4 16V (MOTOR FXDA - FXDD - FXDB - FXDC) (1998 A 2004) 1.6 16V (MOTOR FYDD - FYDC - FYDA - FYDB) (1998 A 2004)</p> <p>B430-d28/30mm 80-110-140-90-110-110-75mm</p>		<p><b>R222435</b> NO. 1144890</p> <p>TUBO DE LIGAÇÃO AO DEPOSITO EXPANSÃO</p> <p>FORD FOCUS C-MAX (DM2) 1.8 TDCi 01.2005/03.2007 85KW 115CV 1753CC KKDB KKDA 8566611 85666AAN</p> <p>B390-d15/d17mm 96-68-79-74-148-67mm</p>
	<p><b>R222435</b> NO. 1144890</p> <p>TUBO DE LIGAÇÃO AO DEPOSITO EXPANSÃO</p> <p>FORD FOCUS I (DAW, DBW) 1.8 DI / TDDi 08.1999/11.2004 55KW 75CV 1753CC BHDB BHDA 8566402 8566377 - FORD FOCUS I (DAW, DBW) 1.8 TDCi 03.2001/11.2004 85KW 115CV 1753CC F9DB F9DA 8566460 8566459 - FORD FOCUS I (DAW, DBW) 1.8 TDCi 08.2002/11.2004 74KW 100CV 1753CC FFDA 8566510 8566509 - FORD FOCUS I (DAW, DBW) 1.8 Turbo DI / TDDi 10.1998/11.2004 66KW 90CV 1753CC C9DC C9DB C9DA 8566368 8566369</p> <p>B390-d15/d17mm 96-68-79-74-148-67mm</p>		<p><b>R222435</b> NO. 1144890</p> <p>TUBO DE LIGAÇÃO AO DEPOSITO EXPANSÃO</p> <p>FORD FOCUS II (DA_, HCP, DP) 1.8 TDCi 01.2005/09.2012 85KW 115CV 1753CC KKDA 85666ABW 8566598</p> <p>B390-d15/d17mm 96-68-79-74-148-67mm</p>
	<p><b>R222449</b> NO. 1306044 - 1321521 - 1384145 - 30741964 - 3M5H8286BG - 3M5H8286BH - 3M5H8286BJ</p> <p>TUBO INFERIOR DO RADIADOR LADO DIREITO</p> <p>FORD FOCUS I (DAW, DBW) 1.4 16V (10.1998 - 11.2004) 55kw 75cv 1388cm3 Hatchback FORD FOCUS I (DAW, DBW) 1.6 16V (10.1998 - 11.2004) 74kw 100cv 1596cm3 Hatchback FORD FOCUS I (DAW, DBW) 1.6 16V Flexifuel (01.2002 - 11.2004) 75kw 102cv 1596cm3 Hatchback</p> <p>boca a boca310mmd1-28mmx28mm101-73-50-62</p>		<p><b>R222449</b> NO. 1306044 - 1321521 - 1384145 - 30741964 - 3M5H8286BG - 3M5H8286BH - 3M5H8286BJ</p> <p>TUBO INFERIOR DO RADIADOR LADO DIREITO</p> <p>FORD FOCUS II (DA_, HCP, DP) 1.4 (07.2004 - 09.2012) 59kw 80cv 1388cm3 Hatchback FORD FOCUS II (DA_, HCP, DP) 1.6 (07.2004 - 09.2012) 74kw 100cv 1596cm3 Hatchback FORD FOCUS II (DA_, HCP, DP) 1.6 LPG (10.2009 - 07.2011) 85kw 115cv 1596cm3 Hatchback FORD FOCUS II (DA_, HCP, DP) 1.6 Ti (07.2004 - 09.2012) 85kw 115cv 1596cm3 Hatchback FORD FOCUS II Cabriolet 1.6 (10.2006 - 09.2010) 74kw 100cv 1596cm3...</p> <p>boca a boca310mmd1-28mmx28mm101-73-50-62</p>

	<p><b>R222449</b> NO. 1306044 - 1321521 - 1384145 - 30741964 - 3M5H8286BG - 3M5H8286BH - 3M5H8286BJ</p> <p><b>TUBO INFERIOR DO RADIADOR LADO DIREITO</b></p> <p>FORD FOCUS III 1.6 EcoBoost (07.2010 - 06.2014) 110kw 150cv 1596cm3 Hatchback FORD FOCUS III 1.6 EcoBoost (07.2010 - 06.2014) 134kw 182cv 1596cm3 Hatchback FORD FOCUS III 1.6 Flexifuel (07.2010 - 02.2020) 88kw 120cv 1596cm3 Hatchback FORD FOCUS III 1.6 Ti (07.2010 - 02.2020) 77kw 105cv 1596cm3 Hatchback FORD FOCUS III 1.6 Ti (07.2010 - 12.2017) 92kw 125cv 1596cm3 Hatchback FORD FOCUS III Turnier 1...</p> <p>boca a boca310mmd1-28mmx250mm1-73-50-62</p>		<p><b>R224130</b> NO. 1448610 - 1475090 - 1485712 - 1486600 - 1493258 - 1511205 - 1543828 - 1607484 - 1673571 - 1...</p> <p><b>TUBO DO FILTRO DE AR (ADMISSÃO)</b></p> <p>FORD FOCUS C-MAX (DM2) 1.6 TDCi 10.2003/03.2007 80KW 109CV 1560CC G8DB G8DA G8DD G8DF G8DE 8566AAJ 8566532 - FORD FOCUS C-MAX (DM2) 1.6 TDCi 02.2005/03.2007 66KW 90CV 1560CC HHDB HHDA 8566610 8566AAK - FORD FOCUS II (DA_, HCP, DP) 1.6 07.2004/09.2012 74KW 100CV 1560CC SHDC SHDB HWDA HWDB SHDA 8566ABN 8566572 - FORD FOCUS II (DA_, HCP, DP) 1.6 TDCi 07.2004/09.2012 74KW 100CV 1560CC MTDA G8DC 8566AK...</p> <p>B200-d70/42mm 1f-d22mm 200-140-90mm</p>
	<p><b>R224130</b> NO. 1448610 - 1475090 - 1485712 - 1486600 - 1493258 - 1511205 - 1543828 - 1607484 - 1673571 - 1...</p> <p><b>TUBO DO FILTRO DE AR (ADMISSÃO)</b></p> <p>FORD FOCUS C-MAX (DM2) 1.6 TDCi 10.2003/03.2007 80KW 109CV 1560CC G8DB G8DA G8DD G8DF G8DE 8566AAJ 8566532 - FORD FOCUS II (DA_, HCP, DP) 1.6 TDCi 07.2004/09.2012 80KW 109CV 1560CC G8DD G8DE G8DF G8DA G8DB 8566ABI 8566573 - FORD FOCUS II três volumes (DB_, FCH, DH) 1.6 TDCi 04.2005/09.2012 80KW 109CV 1560CC G8DD G8DF G8DB G8DE G8DA 8566AAU 8566605 - FORD FOCUS II Turnier (DA_, FFS, DS) 1.6 TDCi 07...</p> <p>B200-d70/42mm 1f-d22mm 200-140-90mm</p>		<p><b>R224131</b> NO. 1233195 - 1300470 - 1324641 - 1324908 - 1336611 - 30680738 - 30680774 - 3M519A673MC - 3M519A67...</p> <p><b>TUBO DE ADMISSÃO DO FILTRO DE AR</b></p> <p>FORD FOCUS C MAX 1.6 TDCi (10-2003 A 03-2007) 109CV 1560CC - FORD FOCUS II (DA) 1.6 TDCi (APÓS 11-2004) 100CV 1560CC - FORD FOCUS II (DA) 1.6 TDCi (APÓS 11-2004) 109CV 1560CC</p> <p>B255-44/70mm 250+ch140-70-d22mm</p>
	<p><b>R224137</b> NO. 1231906 - 1252691 - 1314366 - 1346295 - 1439411 - 1496239 - 1525112 - 3M516C646AD - 3M516C646XB - 3M...</p> <p><b>TUBO DO AR SOBREALIMENTAÇÃO</b></p> <p>FORD FOCUS C-MAX (DM2) 1.6 TDCi (De 2005.02 Até 2007.03) 66kW 90cv 1560cm3 Veículo multiuso - FORD FOCUS C-MAX (DM2) 1.6 TDCi (De 2003.10 Até 2007.03) 80kW 109cv 1560cm3 Veículo multiuso -</p> <p>B425-48/52mm 82x144x67x106mm</p>		<p><b>R224137</b> NO. 1231906 - 1252691 - 1314366 - 1346295 - 1439411 - 1496239 - 1525112 - 3M516C646AD - 3M516C646XB - 3M...</p> <p><b>TUBO DO AR SOBREALIMENTAÇÃO</b></p> <p>FORD FOCUS II (DA_, HCP, DP) 1.4 (De 2004.07 Até 2012.09) 59KW 80cv 1388cm3 Hatchback - FORD FOCUS II (DA_, HCP, DP) 1.6 (De 2004.07 Até 2012.09) 74KW 100cv 1596cm3 Hatchback - FORD FOCUS II (DA_, HCP, DP) 1.6 Ti (De 2004.07 Até 2012.09) 85KW 115cv 1596cm3 Hatchback - FORD FOCUS II (DA_, HCP, DP) 1.6 LPG (De 2009.10 Até 2011.07) 85KW 115cv 1596cm3 Hatchback -</p> <p>B425-48/52mm 82x144x67x106mm</p>
	<p><b>R224138</b> NO. 1329068 - 1348161 - 1369587</p> <p><b>TUBO DO AR SOBREALIMENTAÇÃO</b></p> <p>FORD FOCUS C-MAX (DM2): 1.6 TDCi 02.2005/03.2007 66KW 90CV 1560CC - FORD FOCUS C-MAX (DM2): 1.6 TDCi 10.2003/03.2007 80KW 109CV 1560CC</p> <p>B128-47/59mm 61x23mm</p>		<p><b>R224138</b> NO. 1329068 - 1348161 - 1369587</p> <p><b>TUBO DO AR SOBREALIMENTAÇÃO</b></p> <p>FORD FOCUS II (DA_, HCP, DP): 1.6 TDCi 01.2005/09.2012 66KW 90CV 1560CC - FORD FOCUS II (DA_, HCP, DP): 1.6 TDCi 07.2004/09.2012 74KW 100CV 1560CC - FORD FOCUS II (DA_, HCP, DP): 1.6 TDCi 07.2004/09.2012 80KW 109CV 1560CC - FORD FOCUS II três volumes (DB_, FCH, DH): 1.6 TDCi 04.2005/09.2012 66KW 90CV 1560CC - FORD FOCUS II três volumes (DB_, FCH, DH): 1.6 TDCi 04.2005/09.2012 74KW 100CV 1560CC - F...</p> <p>B128-47/59mm 61x23mm</p>
	<p><b>R224143</b> NO. 1440439 - 30756067 - 3M5Q9351CD</p> <p><b>TUBO ADMISSÃO FILTRO DE AR</b></p> <p>FORD FOCUS C-MAX (DM2) 1.6 TDCi 10.2003/03.2007 80KW 109CV 1560CC G8DB G8DA G8DD G8DF G8DE 8566AAJ 8566532 - FORD FOCUS II (DA_, HCP, DP) 1.6 TDCi 07.2004/09.2012 80KW 109CV 1560CC G8DD G8DE G8DF G8DA G8DB 8566ABI 8566573 - FORD FOCUS II três volumes (DB_, FCH, DH) 1.6 TDCi 04.2005/09.2012 80KW 109CV 1560CC G8DD G8DF G8DB G8DE G8DA 8566AAU 8566605 - FORD FOCUS II Turnier (DA_, FFS, DS) 1.6 TDCi 07...</p> <p>160x100x70mm 3f-d7mm 3f-d4mm 1f-d50x41 1f-d59mm</p>		<p><b>R224144</b> NO. 1440440 - 3M5Q9351EB</p> <p><b>TUBO DE ADMISSÃO FILTRO DE AR</b></p> <p>FORD FOCUS II (DA_ - HCP) 1.6 TDCi (De 01-2005 Até 09-2012) 66kW 90CV 1560cc Hatchback FORD FOCUS II três volumes (DB_ - FCH) 1.6 TDCi (De 04-2005 Até 09-2012) 66kW 90CV 1560cc três volumes</p> <p>d100x155mm 1f-d59mm 3f-d8mm 50x41mm 73-25mm</p>
	<p><b>R224199</b> NO. 1231908 - 1314277 - 1315664 - 1337786 - 1439412 - 1496240 - 6M516K863HA - 6M516K863HB</p> <p><b>TUBO DO AR SOBREALIMENTAÇÃO</b></p> <p>FORD FOCUS C-MAX (DM2) 1.6 TDCi 10.2003/03.2007 80KW 109CV 1560CC G8DB G8DA G8DD G8DF G8DE 8566AAJ 8566532 - FORD FOCUS C-MAX (DM2) 1.6 TDCi 02.2005/03.2007 66KW 90CV 1560CC HHDB HHDA 8566610 8566AAK</p> <p>B438-49/54mm 76x235x68mm</p>		<p><b>R224199</b> NO. 1231908 - 1314277 - 1315664 - 1337786 - 1439412 - 1496240 - 6M516K863HA - 6M516K863HB</p> <p><b>TUBO DO AR SOBREALIMENTAÇÃO</b></p> <p>FORD FOCUS II (DA_, HCP, DP) 1.6 TDCi 07.2004/09.2012 74KW 100CV 1560CC MTDA G8DC 8566AKF - FORD FOCUS II (DA_, HCP, DP) 1.6 TDCi 07.2004/09.2012 80KW 109CV 1560CC G8DD G8DE G8DF G8DA G8DB 8566ABI 8566573 - FORD FOCUS II (DA_, HCP, DP) 1.6 TDCi 01.2005/09.2012 66KW 90CV 1560CC GPDA GPDB GPDC HHDB HHDA 8566ABK 8566600 - FORD FOCUS II Caixa/Combi 1.6 TDCi 07.2004/07.2011 80KW 109CV 1560CC G8DA - FOR...</p> <p>B438-49/54mm 76x235x68mm</p>
	<p><b>R225000</b> NO. 1324644 - 1324645 - 1344155 - 1530297 - 31261896 - 3M516C646YF - 3M516C646YG - 3M516C646YH - 3M516K863...</p> <p><b>TUBO DO AR SOBREALIMENTAÇÃO</b></p> <p>FORD FOCUS C-MAX (DM2): 2.0 TDCi 10.2003/03.2007 98KW 133CV 1997CC - FORD FOCUS C-MAX (DM2): 2.0 TDCi 10.2003/03.2007 100KW 136CV 1997CC</p> <p>B515-48/50mm 43x47x98x111x155x49mm</p>		<p><b>R225000</b> NO. 1324644 - 1324645 - 1344155 - 1530297 - 31261896 - 3M516C646YF - 3M516C646YG - 3M516C646YH - 3M516K863...</p> <p><b>TUBO DO AR SOBREALIMENTAÇÃO</b></p> <p>FORD FOCUS II (DA_, HCP, DP): 1.6 TDCi 01.2005/09.2012 66KW 90CV 1560CC - FORD FOCUS II (DA_, HCP, DP): 1.6 TDCi 07.2004/09.2012 74KW 100CV 1560CC - FORD FOCUS II (DA_, HCP, DP): 1.6 TDCi 07.2004/09.2012 80KW 109CV 1560CC - FORD FOCUS II (DA_, HCP, DP): 2.0 TDCi 07.2004/09.2012 100KW 136CV 1997CC - FORD FOCUS II três volumes (DB_, FCH, DH): 1.6 TDCi 04.2005/09.2012 66KW 90CV 1560CC - FORD FOCUS II...</p> <p>B515-48/50mm 43x47x98x111x155x49mm</p>
	<p><b>R225008</b> NO. 1139450 - 1M5Q6K683CA</p> <p><b>TUBO DO AR SOBREALIMENTAÇÃO</b></p> <p>FORD FOCUS I (DAW, DBW) 1.8 TDCi (De 08.2002 Até 11.2004) 74kW 100cv 1753cm3 Hatchback - FORD FOCUS I (DAW, DBW) 1.8 TDCi (De 03.2001 Até 11.2004) 85kW 115cv 1753cm3 Hatchback - FORD FOCUS I Turnier (DNW) 1.8 TDCi (De 08.2002 Até 11.2004) 74kW 100cv 1753cm3 Combi - FORD FOCUS I Turnier (DNW) 1.8 TDCi (De 03.2001 Até 11.2004) 85kW 115cv 1753cm3 Combi - FORD FOCUS I três volumes (DFW) 1.8 TDCi (De ...</p> <p>B112-47/48mm 62x45mm</p>		<p><b>R225074</b> NO. 1697700 - AV616C700AD</p> <p><b>TUBO DO AR SOBREALIMENTAÇÃO</b></p> <p>FORD FOCUS III 2.0 TDCi (De 07.2010 Até 06.2014) 85kW 115cv 1997cm3 Hatchback - FORD FOCUS III 2.0 TDCi (De 07.2010 Até 06.2014) 103kW 140cv 1997cm3 Hatchback - FORD FOCUS III 2.0 TDCi (De 11.2014 Até 12.2017) 110kW 150cv 1997cm3 Hatchback - FORD FOCUS III 2.0 TDCi (De 07.2010 Até 06.2014) 120kW 163cv 1997cm3 Hatchback - FORD FOCUS III 2.0 TDCi ST (De 11.2014 Até 12.2017) 136kW 185cv 1997cm3 Hatc...</p> <p>B73-42/47mm 73mm</p>

	<p><b>R225077</b> NO. 1439410 - 1672189 - 6M516C646GA - 6M516C646GC</p> <p><b>TUBO DO AR SOBREALIMENTAÇÃO</b></p> <p>FORD FOCUS C-MAX (DM2) 1.6 TDCi (De 02.2005 Até 03.2007) 66kW 90cv 1560cm3 Veículo multiuso - FORD FOCUS C-MAX (DM2) 1.6 TDCi (De 10.2003 Até 03.2007) 80kW 109cv 1560cm3 Veículo multiuso -</p> <p>B292-44/47mm 71x171x108mm</p>		<p><b>R225077</b> NO. 1439410 - 1672189 - 6M516C646GA - 6M516C646GC</p> <p><b>TUBO DO AR SOBREALIMENTAÇÃO</b></p> <p>FORD FOCUS II (DA_, HCP, DP) 1.6 TDCi (De 01.2005 Até 09.2012) 66kW 90cv 1560cm3 Hatchback - FORD FOCUS II (DA_, HCP, DP) 1.6 TDCi (De 07.2004 Até 09.2012) 80kW 109cv 1560cm3 Hatchback - FORD FOCUS II Turnier (DA_, FFS, DS) 1.6 TDCi (De 07.2004 Até 09.2012) 66kW 90cv 1560cm3 Combi - FORD FOCUS II Turnier (DA_, FFS, DS) 1.6 TDCi (De 07.2004 Até 09.2012) 80kW 109cv 1560cm3 Combi - FORD FOCUS II três...</p> <p>B292-44/47mm 71x171x108mm</p>
	<p><b>R225079</b> NO. 1697700 - AV616C700AD</p> <p><b>TUBO DO AR SOBREALIMENTAÇÃO</b></p> <p>FORD FOCUS III 2.0 TDCi (De 07.2010 Até 06.2014) 85kW 115cv 1997cm3 Hatchback - FORD FOCUS III 2.0 TDCi (De 07.2010 Até 06.2014) 103kW 140cv 1997cm3 Hatchback - FORD FOCUS III 2.0 TDCi (De 11.2014 Até 12.2017) 110kW 150cv 1997cm3 Hatchback - FORD FOCUS III 2.0 TDCi (De 07.2010 Até 06.2014) 120kW 163cv 1997cm3 Hatchback - FORD FOCUS III 2.0 TDCi ST (De 11.2014 Até 12.2017) 136kW 185cv 1997cm3 Hatc...</p> <p>B136-48/49mm 73x58mm</p>		<p><b>R225421</b> NO. 1231901 - 1312657 - 1339071 - 1359107 - 1376266 - 1404782 - 1465156</p> <p><b>TUBO DO AR SOBREALIMENTAÇÃO</b></p> <p>FORD FOCUS II (DA_, HCP, DP) 1.6 TDCi 07.2004/09.2012 74kW 100CV 1560CC MTDA G8DC 8566AKF - FORD FOCUS II (DA_, HCP, DP) 1.6 TDCi 07.2004/09.2012 80kW 109CV 1560CC G8DD G8DE G8DF G8DA G8DB 8566ABI 8566573 - FORD FOCUS II (DA_, HCP, DP) 1.6 TDCi 01.2005/09.2012 66kW 90CV 1560CC GPDA GPDB GPDC HHDB HHTA 8566ABK 8566600 - FORD FOCUS II três volumes (DB_, FCH, DH) 1.6 TDCi 04.2005/09.2012 66kW 90CV 15...</p> <p>305x93x121mm 1f-d33mm 1r-d37mm 1r-d40mm</p>
	<p><b>R225462</b> NO. 1303478 - 3M5Q6A646AA</p> <p><b>TUBO DO RADIADOR DO ÓLEO COM JUNTAS</b></p> <p>FORD FOCUS III 2.0 TDCi 07.2010/06.2014 85KW 115CV 1997CC TYDA 8566AWH - FORD FOCUS III 2.0 TDCi 07.2010/06.2014 103KW 140CV 1997CC UFDB 8566AWJ - FORD FOCUS III 2.0 TDCi 07.2010/06.2014 120KW 163CV 1997CC TXDB 8566AWK - FORD FOCUS III três volumes 2.0 TDCi 07.2010/06.2014 85KW 115CV 1997CC TYDA 8566AVW - FORD FOCUS III três volumes 2.0 TDCi 07.2010/06.2014 103KW 140CV 1997CC UFDB 8566AVY - FORD F...</p> <p>d81x4mm d27x3mm d72x4mm d122x9mm 1f-d19mm 1f-d14mm</p>		<p><b>R225710</b> NO. 1439410 - 1672189 - 31273520 - 6M516C646GA - 6M516C646GC</p> <p><b>TUBO DO AR SOBREALIMENTAÇÃO</b></p> <p>FORD FOCUS C-MAX (DM2) 1.6 TDCi 10.2003/03.2007 80kW 109CV 1560CC G8DB G8DA G8DD G8DF G8DE 8566AAJ 8566532 - FORD FOCUS C-MAX (DM2) 1.6 TDCi 02.2005/03.2007 66kW 90CV 1560CC HHDB HHDA 8566610 8566AAK</p> <p>B161-49/49mm 59x67mm</p>
	<p><b>R225710</b> NO. 1439410 - 1672189 - 31273520 - 6M516C646GA - 6M516C646GC</p> <p><b>TUBO DO AR SOBREALIMENTAÇÃO</b></p> <p>FORD FOCUS II (DA_, HCP, DP) 1.6 TDCi 07.2004/09.2012 80kW 109CV 1560CC G8DD G8DE G8DF G8DA G8DB 8566ABI 8566573 - FORD FOCUS II (DA_, HCP, DP) 1.6 TDCi 01.2005/09.2012 66kW 90CV 1560CC GPDA GPDB GPDC HHDB HHDA 8566ABK 8566600 - FORD FOCUS II três volumes (DB_, FCH, DH) 1.6 TDCi 04.2005/09.2012 66kW 90CV 1560CC HHDB HHDA GPDC GPDB GPDA 8566AAV 8566606 - FORD FOCUS II três volumes (DB_, FCH, DH) 1...</p> <p>B161-49/49mm 59x67mm</p>		<p><b>R230185</b> NO. 1495968 - 1674010 - 1684286 - 7M51-9A673-LC - 7M519A673LA - 7M519A673LB</p> <p><b>TUBO DE ADMISSÃO FILTRO DE AR</b></p> <p>FORD FOCUS II (DA_, HCP, DP) 1.8 03.2006/09.2012 92kW 125CV 1798CC Q7DA QQDA QQDB 8566ABT 8566617 - FORD FOCUS II (DA_, HCP, DP) 1.8 Flexifuel 01.2006/09.2012 92kW 125CV 1798CC Q7DA QQDB QQDA 8566AQP - FORD FOCUS II (DA_, HCP, DP) 2.0 07.2004/09.2012 107kW 145CV 1999CC AODE AODB AODA SYDA 8566576 8566ABA - FORD FOCUS II (DA_, HCP, DP) 2.0 CNG 04.2009/07.2011 107kW 145CV 1999CC SYDA 8566AQV...</p> <p>B147-69/69mm 46-100mm</p>
	<p><b>R8118</b> NO. 1120153 - 1144861 - 1201165 - 1219716 - 1229499 - 1417829 - 2T1Q.6N650.AB - 3S4Q.6N650.AA - ...</p> <p><b>TUBO DO FILTRO DE AR</b></p> <p>FORD TRANSIT CONNECT (P65_, P70_, P80_): 1.8 Di 06.2002/12.2013 55kW 75CV 1753CC - FORD TRANSIT CONNECT (P65_, P70_, P80_): 1.8 TDCi 06.2002/12.2013 66kW 90CV 1753CC - FORD TRANSIT CONNECT (P65_, P70_, P80_): 1.8 TDCi 08.2006/12.2013 81kW 110CV 1753CC</p> <p>B120-d50/50mm 30-60-30mm</p>		<p><b>R8200</b> NO. 1251783 - 1366216 - 1430644 - 4M5G-6758-FA - 4M5G-6758-HA - 6G9G-6758-AA</p> <p><b>TUBO DO RESPIRO DO CARTER DA CAMBOTA</b></p> <p>FORD FOCUS I (DAW, DBW) 1.8 16V 10.1998/11.2004 85KW 115CV 1796CC EYDJ EYDL EYDI EYDG EYDC EYDF EYDD EYDE EYDB 8566347 8566351 - FORD FOCUS I (DAW, DBW) 1.8 16V BiFuel 09.2002/07.2004 85KW 115CV 1796CC EYDI EYDD EYDG - FORD FOCUS I (DAW, DBW) 2.0 16V 10.1998/11.2004 96KW 131CV 1988CC EDDC EDDF EDDD EDDB 8566348 8566352 - FORD FOCUS I (DAW, DBW) RS 10.2002/11.2004 158KW 215CV 1988CC HMDA 8566527 - ...</p> <p>B117-14/14mm 37-62-38mm</p>
	<p><b>R8200</b> NO. 1251783 - 1366216 - 1430644 - 4M5G-6758-FA - 4M5G-6758-HA - 6G9G-6758-AA</p> <p><b>TUBO DO RESPIRO DO CARTER DA CAMBOTA</b></p> <p>FORD FOCUS II (DA_, HCP, DP) 1.8 03.2006/09.2012 92KW 125CV 1798CC Q7DA QQDA QQDB 8566ABT 8566617 - FORD FOCUS II (DA_, HCP, DP) 1.8 Flexifuel 01.2006/09.2012 92KW 125CV 1798CC Q7DA QQDB QQDA 8566AQP - FORD FOCUS II (DA_, HCP, DP) 2.0 07.2004/09.2012 107KW 145CV 1999CC AODE AODB AODA SYDA 8566576 8566ABA - FORD FOCUS II (DA_, HCP, DP) 2.0 CNG 04.2009/07.2011 107KW 145CV 1999CC SYDA 8566AQV - FORD ...</p> <p>B117-14/14mm 37-62-38mm</p>		<p><b>RF80419</b> NO. 1104177 - 1139037 - 1461332 - XS4Q8K579CE - XS4Q8K579CF - XS4Q9N271CC</p> <p><b>TUBO DE FERRO REFRIGERAÇÃO</b></p> <p>FORD FOCUS I (DAW, DBW) 1.8 DI / TDDi (De 08.1999 Até 11.2004) 55kW 75cv 1753cm3 Hatchback -</p> <p>B345-28/31mm 89x56x109x51x52mm ch-d21x25x109mm</p>
	<p><b>RF80419</b> NO. 1104177 - 1139037 - 1461332 - XS4Q8K579CE - XS4Q8K579CF - XS4Q9N271CC</p> <p><b>TUBO DE FERRO REFRIGERAÇÃO</b></p> <p>FORD FOCUS II (DA_, HCP, DP) 1.8 (De 03.2006 Até 09.2012) 92kW 125cv 1798cm3 Hatchback - FORD FOCUS II (DA_, HCP, DP) 1.8 Flexifuel (De 01.2006 Até 09.2012) 92kW 125cv 1798cm3 Hatchback -</p> <p>B345-28/31mm 89x56x109x51x52mm ch-d21x25x109mm</p>		<p><b>RT08608</b> NO. 1068964</p> <p><b>TUBO DE TRAVÃO FRENTE LH-RH</b></p> <p>FORD FOCUS TT (APÓS 10-1998)</p> <p>B370mm FB42 - MC11</p>
	<p><b>RT08609</b> NO. 1064257</p> <p><b>TUBO DE TRAVÃO TRÁS LH-RH</b></p> <p>FORD FOCUS TT (APÓS 10-1998)</p> <p>225mm FB42 - FB42</p>		<p><b>RT08923</b> NO. 1068975</p> <p><b>TUBO DE TRAVÃO TRÁS LH-RH</b></p> <p>FORD FOCUS TT APÓS 10-1998</p> <p>195mm FB42 - MC49</p>

	<b>RT80246</b> NO. 1328519 - 1361292 - 1405497 TUBO DE TRAVÃO TRÁS LH-RH (COM TRAVÃO DE MÃO ELÉCTRICO) FORD FOCUS C-MAX TT (01-2004 A 03-2007)		<b>RT80246</b> NO. 1328519 - 1361292 - 1405497 TUBO DE TRAVÃO TRÁS LH-RH (COM TRAVÃO DE MÃO ELÉCTRICO) FORD FOCUS II TT (APÓS 01-2004)	
	438mm	FB42 - MCL	438mm	FB42 - MCL
	<b>RT80267</b> NO. 1124059 - 1148270 TUBO DE TRAVÃO TRÁS LH-RH FORD FOCUS TT (APÓS 09-2000)		<b>RT80306</b> NO. 1405494 TUBO DE TRAVÃO TRÁS LH-RH FORD FOCUS C-MAX TT (11-2004 A 03-2007)	
	445mm	FB42 - MC54	410mm	FB42 - MC55
	<b>RT80306</b> NO. 1405494 TUBO DE TRAVÃO TRÁS LH-RH FORD FOCUS II TT (APÓS 11-2004)		<b>RT80321</b> NO. 1309224 - 1387272 TUBO DE TRAVÃO TRÁS LH-RH FORD FIESTA FURGONATO 1.3 (09-1991 A 02-1996) - FURGONATO 1.8 D (03-1989 A 02-1996) - FIESTA III 1.0 (03-1989 A 12-1995) - FIESTA III 1.1 (03-1989 A 12-1995) - FIESTA III 1.3 (03-1989 A 12-1992) - FIESTA III 1.3 CAT.(05-1991 A 01-1997)	
	410mm	FB42 - MC55	440mm	FB42 - MC55
	<b>RT80321</b> NO. 1309224 - 1387272 TUBO DE TRAVÃO TRÁS LH-RH FORD FOCUS C-MAX 1.6 (10-2003 A 03-2007) - 1.6 TDCi (10-2003 A 03-2007) - 1.6 Ti (08-2004 A 03-2007) - 1.8 (10-2003 A 03-2007) - 2.0 (04-2004 A 03-2007) - 2.0 TDCi (10-2003 A 03-2007)		<b>RT80388</b> NO. 1387264 TUBO DE TRAVÃO FRENTE LH-RH FORD FOCUS C-MAX TT (10-2003 A 03-2007)	
	440mm	FB42 - MC55	435mm	FB78 - MCL2
	<b>RT80388</b> NO. 1387264 TUBO DE TRAVÃO FRENTE LH-RH FORD FOCUS II TT (APÓS 06-2003)		<b>RT80450</b> NO. 1379911 - 1671020 TUBO DE TRAVÃO FRENTE LH-RH FORD FOCUS II 1.4 (APÓS 11-2004) - 1.6 (APÓS 11-2004) - 1.6 TDCi (APÓS 11-2004) - 1.6 Ti (APÓS 11-2004) - 2.0 (APÓS 11-2004) - 2.0 TDCi (APÓS 11-2004) - FOCUS II TRE VOLUMI 1.8 FLUXIFUEL (APÓS 06-2006) - FOCUS II TURNIER 1.4 (APÓS 11-2004) - 1.6 (APÓS 11-	
	435mm	FB78 - MCL2	420mm	FB76 - MC64
	<b>S1261</b> NO. 1061570 - 98AG3063AE SILENT-BLOC DO BRAÇO DA SUSPENSÃO DA FRENTE CENTRO FORD FOCUS 1.4 16V - 1.6 16V - 1.8 16V - 1.8 TDDi - 1.8 TDCi - 2.0 16V (1998 A 2004)		<b>S1262</b> NO. 1067918 - 1090730 - 1093678 - 1097918 - 2T14.3A262.AA - 98AG.3A262AG - 98AG.3A262.AG - 98AG3A2 SILENT-BLOC DO BRAÇO DA SUSPENSÃO FRENTE (PONTAS) FORD FOCUS 1.4 16V - 1.6 16V - 1.8 16V - 1.8 TDDi - 1.8 TDCi - 2.0 16V (1998 A 2004)	
	d49x65mm	d40mm 1f-d12mm	155x75x65mm	1f-d22mm
	<b>S1376</b> NO. 1061670 - 1254368 - 1304124 - 3M515K896AC - 98AG.5K896.AB - C2Y6-28-46X SILENT-BLOC DA SUSPENSÃO DE TRÁS FORD FOCUS (DAW - DBW) 1.4 16V - 1.6 16V - 1.8 16V - 1.8 Di - 1.8 TDDi - 1.8 TDCi - 1.8 TURBO Di - 2.0 16V - RS - ST 170 10-98 A 11-04 - FOCUS C-MAX 1.6 - 1.6 TDCi - 1.6 Ti - 1.8 - 1.8 TDCi - 2.0 - 2.0TDCi APÓS 10-03 - FOCUS COMBI (DNW) 02-99 A 11-04 - FO		<b>S1443</b> NO. 98AG5K792AA SILENT-BLOC DO BRAÇO DA SUSPENSÃO DE TRÁS PARTE DA FRENTE FORD FOCUS (APÓS 1998)	
	d60x140mm	c37mm 2f-d14mm	d36.4x45mm	c35mm 1f-12.2mm
	<b>S1444</b> NO. 98AG5K790AA SILENT-BLOC DO BRAÇO DA SUSPENSÃO DE TRÁS PARTE DE TRÁS FORD FOCUS (APÓS 1998)		<b>S1448</b> NO. 2M51.3A262.CA - 2M513A262AD SILENT-BLOC DO BRAÇO DA SUSPENSÃO DA FRENTE PARTE EXTERNA FORD FOCUS (APÓS 2001)	
	d32.6x55mm	c45mm 1f-d12.2mm	160x75x80mm	1f-d21.6mm

	<p><b>S1505</b> NO. 1234371 - 1234375 - 1254310 - 1254311 - 1305341 - 1305342 - 1309148 - 1328380 - 1355149 - 135...</p> <p><b>SILENT BLOC DO BRAÇO DA SUSPENSÃO DA FRENTE</b></p> <p>FORD - FOCUS C-MAX - 1.6 Veículo multiuso 100CV 1596cc (10-2003 A 03-2007) - 1.6 Ti Veículo multiuso 115CV 1596cc (08-2004 A 03-2007) - 1.8 Veículo multiuso 120CV 1798cc (10-2003 A 03-2007) - 1.8 Veículo multiuso 125CV 1798cc (04-2004 A 03-2007) - 1.8 Fle</p> <p>d45x65mm d40.5mm 1f-d14mm</p>		<p><b>S1505</b> NO. 1234371 - 1234375 - 1254310 - 1254311 - 1305341 - 1305342 - 1309148 - 1328380 - 1355149 - 135...</p> <p><b>SILENT BLOC DO BRAÇO DA SUSPENSÃO DA FRENTE</b></p> <p>FORD - FOCUS II (DA_) - 1.4 Hatchback 80CV 1388cc (APÓS 11-2004) - 1.6 Hatchback 100CV 1596cc (APÓS 11-2004) - 1.6 Ti Hatchback 115CV 1596cc (APÓS 11-2004) - 1.6 LPG Hatchback 115CV 1596cc (APÓS 10-2009) - 1.8 Hatchback 125CV 1798cc (APÓS 03-2006) - 1.8 F</p> <p>d45x65mm d40.5mm 1f-d14mm</p>
	<p><b>S1506</b> NO. 1234371 - 1234375 - 1328380 - 1477858 - 1477858S1 - 1477858S3 - 1488110 - 1488111 - 1570284 - 1570...</p> <p><b>SILENT BLOCO DO BRAÇO SUSPENSÃO FRENTE PARTE DE TRÁS</b></p> <p>FORD FOCUS II (DA_) 1.4 (ASDA - ASDB) 80CV (APÓS 11-2004) - 1.6 (HWDA - HWDB) 100CV (APÓS 11-2004) - 1.6 LPG (SIDA) 115CV (APÓS 10-2009) - 1.6 TDCi (G8DA - G8D8) 109CV (APÓS 11-2004) - 1.6 TDCi (HHDA - HHDB) 90CV (APÓS 01-2005) - 1.6 Ti (HXDA) 115CV (APÓS 11-2004)</p> <p>123x82x93mm 1f-d21.7mm 2f-d13mm 2r-d12mm</p>		<p><b>S1755</b> NO. 1061666 - 1064128 - 1150353 - 1335249 - 1357317 - 1357319 - 1502729 - 1548460 - 1718501 - 1782008 - ...</p> <p><b>SILENT-BLOC BRAÇO OSCILANTE SUSPENSÃO DE TRÁS</b></p> <p>FORD FOCUS Turnier (DNW) 1.4 16V (De 1999.02 Até 2004.11) 55kW 75cv 1388cm3 Combi - FORD FOCUS Turnier (DNW) 1.6 16V (De 1999.02 Até 2004.11) 74kW 100cv 1596cm3 Combi - FORD FOCUS Turnier (DNW) 1.8 16V (De 1999.02 Até 2004.11) 85kW 115cv 1796cm3 Combi - FORD FOCUS Turnier (DNW) 2.0 16V (De 1999.02 Até 2004.11) 96kW 131cv 1988cm3 Combi - FORD FOCUS Turnier (DNW) 1.6 16V (De 1999.02 Até 2004.11) 74kW 100cv 1596cm3 Hatchback</p> <p>80x45x60mm c36mm 1f-d12mm</p>
	<p><b>S1755</b> NO. 1061666 - 1064128 - 1150353 - 1335249 - 1357317 - 1357319 - 1502729 - 1548460 - 1718501 - 1782008 - ...</p> <p><b>SILENT-BLOC BRAÇO OSCILANTE SUSPENSÃO DE TRÁS</b></p> <p>FORD FOCUS C-MAX (DM2) 1.6 (De 2003.10 Até 2007.03) 74kW 100cv 1596cm3 Veículo multiuso - FORD FOCUS C-MAX (DM2) 1.6 Ti (De 2004.08 Até 2007.03) 85kW 115cv 1596cm3 Veículo multiuso - FORD FOCUS C-MAX (DM2) 1.8 (De 2003.10 Até 2007.03) 88kW 120cv 1798cm3 Veículo multiuso - FORD FOCUS C-MAX (DM2) 1.8 (De 2005.09 Até 2007.03) 90kW 122cv 1798cm3 Veículo multiuso - FORD FOCUS C-MAX (DM2) 1.8 (De 2005.09 Até 2007.03) 90kW 122cv 1798cm3 Veículo multiuso -</p> <p>80x45x60mm c36mm 1f-d12mm</p>		<p><b>S1755</b> NO. 1061666 - 1064128 - 1150353 - 1335249 - 1357317 - 1357319 - 1502729 - 1548460 - 1718501 - 1782008 - ...</p> <p><b>SILENT-BLOC BRAÇO OSCILANTE SUSPENSÃO DE TRÁS</b></p> <p>FORD FOCUS (DAW, DBW) 1.4 16V (De 1998.10 Até 2004.11) 55kW 75cv 1388cm3 Hatchback - FORD FOCUS (DAW, DBW) 1.6 16V (De 1998.10 Até 2004.11) 74kW 100cv 1596cm3 Hatchback - FORD FOCUS (DAW, DBW) 1.8 16V (De 1998.10 Até 2004.11) 85kW 115cv 1796cm3 Hatchback - FORD FOCUS (DAW, DBW) 2.0 16V (De 1998.10 Até 2004.11) 96kW 131cv 1988cm3 Hatchback - FORD FOCUS (DAW, DBW) 1.6 16V (De 1998.10 Até 2004.11) 74kW 100cv 1596cm3 Hatchback</p> <p>80x45x60mm c36mm 1f-d12mm</p>
	<p><b>S1755</b> NO. 1061666 - 1064128 - 1150353 - 1335249 - 1357317 - 1357319 - 1502729 - 1548460 - 1718501 - 1782008 - ...</p> <p><b>SILENT-BLOC BRAÇO OSCILANTE SUSPENSÃO DE TRÁS</b></p> <p>FORD FOCUS II (DA_, HCP, DP) 1.6 LPG (De 2009.10 Até 2011.07) 85kW 115cv 1596cm3 Hatchback - FORD FOCUS II (DA_, HCP, DP) 1.8 (De 2006.03 Até 2012.09) 92kW 125cv 1798cm3 Hatchback - FORD FOCUS II (DA_, HCP, DP) 1.8 Flexifuel (De 2006.01 Até 2012.09) 92kW 125cv 1798cm3 Hatchback - FORD FOCUS II (DA_, HCP, DP) 2.0 (De 2004.07 Até 2012.09) 107kW 145cv 1999cm3 Hatchback -</p> <p>80x45x60mm c36mm 1f-d12mm</p>		<p><b>S1755</b> NO. 1061666 - 1064128 - 1150353 - 1335249 - 1357317 - 1357319 - 1502729 - 1548460 - 1718501 - 1782008 - ...</p> <p><b>SILENT-BLOC BRAÇO OSCILANTE SUSPENSÃO DE TRÁS</b></p> <p>FORD FOCUS III 1.6 Ti (De 2010.07 -) 92kW 125cv 1596cm3 Hatchback - FORD FOCUS III 1.6 LPG (De 2012.02 -) 86kW 117cv 1596cm3 Hatchback - FORD FOCUS III 1.6 LPG (De 2012.02 -) 88kW 120cv 1596cm3 Hatchback - FORD FOCUS III 1.6 Flexifuel (De 2010.07 -) 88kW 120cv 1596cm3 Hatchback - FORD FOCUS III 1.6 EcoBoost (De 2012.02 -) 92kW 125cv 1596cm3 Hatchback</p> <p>80x45x60mm c36mm 1f-d12mm</p>
	<p><b>S1756</b> NO. 1061666 - 1064128 - 1150353 - 1335249 - 1357317 - 1357319 - 1502729 - 1548460 - 1718501 - 1782008 - ...</p> <p><b>SILENT-BLOC BRAÇO OSCILANTE SUSPENSÃO TRÁS</b></p> <p>FORD FOCUS II três volumes (DB_, FCH, DH) 1.8 TDCi (De 2005.04 Até 2012.09) 85kW 115cv 1753cm3 três volumes - FORD FOCUS II três volumes (DB_, FCH, DH) 2.0 TDCi (De 2008.02 Até 2011.07) 81kW 110cv 1997cm3 três volumes - FORD FOCUS II três volumes (DB_, FCH, DH) 2.0 TDCi (De 2005.04 Até 2012.09) 100kW 136cv 1997cm3 três volumes - FORD FOCUS II Turnier (DA_, FFS, DS) 1.4 (De 2004...</p> <p>d32x55mm c49mm 1f-d12mm</p>		<p><b>S1755</b> NO. 1061666 - 1064128 - 1150353 - 1335249 - 1357317 - 1357319 - 1502729 - 1548460 - 1718501 - 1782008 - ...</p> <p><b>SILENT-BLOC BRAÇO OSCILANTE SUSPENSÃO TRÁS</b></p> <p>FORD FOCUS III 1.0 EcoBoost (De 2012.02 -) 74kW 100cv 998cm3 Hatchback - FORD FOCUS III 1.0 EcoBoost (De 2012.02 -) 92kW 125cv 998cm3 Hatchback - FORD FOCUS III 1.6 Ti (De 2011.08 -) 63kW 85cv 1596cm3 Hatchback - FORD FOCUS III 1.6 Ti (De 2010.07 -) 77kW 105cv 1596cm3 Hatchback - FORD FOCUS III 1.6 Ti (De 2010.07 -) 77kW 105cv 1596cm3 Hatchback</p> <p>80x45x60mm c36mm 1f-d12mm</p>
	<p><b>S1756</b> NO. 1061666 - 1064128 - 1150353 - 1335249 - 1357317 - 1357319 - 1502729 - 1548460 - 1718501 - 1782008 - ...</p> <p><b>SILENT-BLOC BRAÇO OSCILANTE SUSPENSÃO TRÁS</b></p> <p>FORD FOCUS Turnier (DNW) 1.4 16V (De 1999.02 Até 2004.11) 55kW 75cv 1388cm3 Combi - FORD FOCUS Turnier (DNW) 1.6 16V (De 1999.02 Até 2004.11) 74kW 100cv 1596cm3 Combi - FORD FOCUS Turnier (DNW) 1.8 16V (De 1999.02 Até 2004.11) 85kW 115cv 1796cm3 Combi - FORD FOCUS Turnier (DNW) 2.0 16V (De 1999.02 Até 2004.11) 96kW 131cv 1988cm3 Combi -</p> <p>80x45x60mm c36mm 1f-d12mm</p>		<p><b>S1755</b> NO. 1061666 - 1064128 - 1150353 - 1335249 - 1357317 - 1357319 - 1502729 - 1548460 - 1718501 - 1782008 - ...</p> <p><b>SILENT-BLOC BRAÇO OSCILANTE SUSPENSÃO TRÁS</b></p> <p>FORD FOCUS C-MAX (DM2) 1.6 (De 2003.10 Até 2007.03) 74kW 100cv 1596cm3 Veículo multiuso - FORD FOCUS C-MAX (DM2) 1.6 Ti (De 2004.08 Até 2007.03) 85kW 115cv 1596cm3 Veículo multiuso - FORD FOCUS C-MAX (DM2) 1.8 (De 2003.10 Até 2007.03) 88kW 120cv 1798cm3 Veículo multiuso - FORD FOCUS C-MAX (DM2) 1.8 (De 2005.09 Até 2007.03) 90kW 122cv 1798cm3 Veículo multiuso -</p> <p>80x45x60mm c36mm 1f-d12mm</p>
	<p><b>S1866</b> NO. 1865173</p> <p><b>SILENT-BLOC DO BRAÇO SUSPENSÃO DA FRENTE</b></p> <p>FORD FOCUS III 1.0 EcoBoost (De 02.2012 -) 74kW 100cv 998cm3 Hatchback - FORD FOCUS III 1.0 EcoBoost (De 02.2012 -) 92kW 125cv 998cm3 Hatchback - FORD FOCUS III 1.5 EcoBoost (De 09.2014 -) 110kW 150cv 1498cm3 Hatchback - FORD FOCUS III 1.5 EcoBoost (De 09.2014 -) 134kW 182cv 1498cm3 Hatchback - FORD FOCUS III 1.5 TDCi (De 09.2014 -) 70kW 95cv 1499cm3 Hatchback - FORD FOCUS III 1.5 TDCi (De 09.2014...</p> <p>155x133x75mm 1f-d23mm 4f-15x19mm</p>		<p><b>S1867</b> NO. 1889406</p> <p><b>SILENT-BLOC DO BRAÇO SUSPENSÃO FRENTE</b></p> <p>FORD FOCUS III 1.0 EcoBoost (De 2002.2012 -) 74kW 100cv 998cm3 Hatchback - FORD FOCUS III 1.0 EcoBoost (De 2002.2012 -) 92kW 125cv 998cm3 Hatchback - FORD FOCUS III 1.6 EcoBoost (De 2007.2010 -) 110kW 150cv 1596cm3 Hatchback - FORD FOCUS III 1.6 EcoBoost (De 2007.2010 -) 134kW 182cv 1596cm3 Hatchback - FORD FOCUS III 1.6 Flexifuel (De 2007.2010 -) 88kW 120cv 1596cm3 Hatchback - FORD FOCUS III 1.6 ...</p> <p>d54x64mm d38mm c40mm 1f-d14mm</p>
	<p><b>S2132</b> NO. 1702970 - 1702983 - 1709424 - 1709466 - 1749593 - 1749991 - 1749992 - 1793236</p> <p><b>SILENT-BLOC DO BRAÇO SUSPENSÃO FRENTE PARTE DA FRENTE</b></p> <p>FORD FOCUS III 1.0 EcoBoost (02.2012 - 12.2017) 74kW 100cv 998cm3 Hatchback FORD FOCUS III 1.0 EcoBoost (02.2012 - 12.2017) 92kW 125cv 998cm3 Hatchback FORD FOCUS III 1.0 EcoBoost (10.2017 - 02.2020) 103kW 140cv 998cm3 Hatchback FORD FOCUS III 1.5 EcoBoost (09.2014 - 12.2017) 110kW 150cv 1498cm3 Hatchback FORD FOCUS III 1.5 EcoBoost (09.2014 - 12.2017) 134kW 182cv 1498cm3 Hatchback FORD FOCUS III ...</p> <p>d53x 65mm c-38mm-dc-31mm-1f-d14mm</p>		<p><b>S2132</b> NO. 1702970 - 1702983 - 1709424 - 1709466 - 1749593 - 1749991 - 1749992 - 1793236</p> <p><b>SILENT-BLOC DO BRAÇO SUSPENSÃO FRENTE PARTE DA FRENTE</b></p> <p>FORD FOCUS III Caixa/Combi 1.5 EcoBoost (09.2014 - 02.2020) 110kW 150cv 1498cm3 Caixa/Combi FORD FOCUS III Caixa/Combi 1.5 TDCi (09.2014 - 02.2020) 88kW 120cv 1499cm3 Caixa/Combi FORD FOCUS III Caixa/parte traseira inclinada 1.5 EcoBoost (09.2014 - 12.2017) 110kW 150cv 1498cm3 Caixa/parte traseira inclinada FORD FOCUS III Caixa/parte traseira inclinada 1.5 TDCi (09.2014 - 12.2017) 88kW 120cv 1499cm3</p> <p>d53x 65mm c-38mm-dc-31mm-1f-d14mm</p>

	<p><b>S2132</b> NO. 1702970 - 1702983 - 1709424 - 1709466 - 1749593 - 1749991 - 1749992 - 1793236</p> <p><b>SILENT-BLOC DO BRAÇO SUSPENSÃO FRENTE PARTE DA FRENTE</b></p> <p>FORD FOCUS III Turnier 1.0 EcoBoost (02.2012 - 02.2020) 74kw 100cv 998cm3 Combi FORD FOCUS III Turnier 1.0 EcoBoost (02.2012 - 02.2020) 92kw 125cv 998cm3 Combi FORD FOCUS III Turnier 1.0 EcoBoost (10.2017 - 02.2020) 103kw 140cv 998cm3 Combi FORD FOCUS III Turnier 1.5 EcoBoost (09.2014 - 02.2020) 110kw 150cv 1498cm3 Combi FORD FOCUS III Turnier 1.5 EcoBoost (09.2014 - 02.2020) 134kw 182cv 1498cm3 C...</p> <p>d53x 65mm c-38mm-dc-31mm-1f-d14mm</p>	<p><b>S2132</b> NO. 1702970 - 1702983 - 1709424 - 1709466 - 1749593 - 1749991 - 1749992 - 1793236</p> <p><b>SILENT-BLOC DO BRAÇO SUSPENSÃO FRENTE PARTE DA FRENTE</b></p> <p>FORD FOCUS III três volumes 1.0 EcoBoost (02.2012 - 02.2020) 74kw 100cv 998cm3 três volumes FORD FOCUS III três volumes 1.0 EcoBoost (02.2012 - 02.2020) 92kw 125cv 998cm3 três volumes FORD FOCUS III três volumes 1.0 EcoBoost (10.2017 - 02.2020) 103kw 140cv 998cm3 três volumes FORD FOCUS III três volumes 1.5 EcoBoost (11.2014 - 02.2020) 110kw 150cv 1498cm3 três volumes FORD FOCUS III três volumes 1...</p> <p>d53x 65mm c-38mm-dc-31mm-1f-d14mm</p>
	<p><b>T0610-I</b> NO. 1064069 - 98AG3025AD</p> <p><b>BATEANTE DA SUSPENSÃO DA FRENTE</b></p> <p>FORD FOCUS (98 A 2004)</p> <p>d50x55mm 1f-d21/17mm</p>	<p><b>T1042</b> NO. 1067976 - 1073249 - 98AG4A037BA</p> <p><b>BATEANTE DA BARRA ESTABILIZADORA (CENTRO DE TRÁS)</b></p> <p>FORD FOCUS (1998 A 2004)</p> <p>45x46x32mm 1f-d20mm</p>
	<p><b>T1075</b> NO. 1061626 - 1073217 - 98AG5484DA</p> <p><b>BATEANTE DA BARRA ESTABILIZADORA DA FRENTE</b></p> <p>FORD FOCUS (1998 A 2004)</p> <p>48x48x39mm 1f-d18-19mm</p>	<p><b>T1128</b> NO. 1305960 - 1348231 - 30666266 - 3M51.5484.CA - 3N615484AA</p> <p><b>BATEANTE DA BARRA ESTABILIZADORA DA FRENTE</b></p> <p>FORD FOCUS C-MAX (DM2): 1.6 10.2003/03.2007 74KW 100CV 1596CC - FORD FOCUS C-MAX (DM2): 1.6 Ti 08.2004/03.2007 85KW 115CV 1596CC - FORD FOCUS C-MAX (DM2): 1.8 10.2003/03.2007 88KW 120CV 1798CC - FORD FOCUS C-MAX (DM2): 1.8 09.2005/03.2007 90KW 122CV 1798CC - FORD FOCUS C-MAX (DM2): 1.8 04.2004/03.2007 92KW 125CV 1798CC - FORD FOCUS C-MAX (DM2): 1.8 Flexifuel 01.2006/03.2007 92KW 125CV 1798CC - FOR...</p> <p>47x47x48mm 1f-d18mm</p>
	<p><b>T1128</b> NO. 1305960 - 1348231 - 30666266 - 3M51.5484.CA - 3N615484AA</p> <p><b>BATEANTE DA BARRA ESTABILIZADORA DA FRENTE</b></p> <p>FORD FOCUS II Turnier (DA_, FFS, DS): 1.4 07.2004/09.2012 59KW 80CV 1388CC - FORD FOCUS II Turnier (DA_, FFS, DS): 1.6 07.2004/07.2011 74KW 100CV 1596CC - FORD FOCUS II Turnier (DA_, FFS, DS): 1.6 Ti 07.2004/09.2012 85KW 115CV 1596CC - FORD FOCUS II Turnier (DA_, FFS, DS): 1.6 LPG 10.2009/09.2012 85KW 115CV 1596CC - FORD FOCUS II Turnier (DA_, FFS, DS): 1.8 03.2006/09.2012 92KW 125CV 1798CC - FORD...</p> <p>47x47x48mm 1f-d18mm</p>	<p><b>T1128</b> NO. 1305960 - 1348231 - 30666266 - 3M51.5484.CA - 3N615484AA</p> <p><b>BATEANTE DA BARRA ESTABILIZADORA DA FRENTE</b></p> <p>FORD FOCUS III: 1.6 Ti 07.2010/&gt;&gt;&gt;&gt; 77KW 105CV 1596CC - FORD FOCUS III: 1.6 Ti 07.2010/&gt;&gt;&gt;&gt; 92KW 125CV 1596CC - FORD FOCUS III: 1.6 Flexifuel 07.2010/&gt;&gt;&gt;&gt; 88KW 120CV 1596CC - FORD FOCUS III: 1.6 EcoBoost 07.2010/&gt;&gt;&gt;&gt; 110KW 150CV 1596CC - FORD FOCUS III: 1.6 EcoBoost 07.2010/&gt;&gt;&gt;&gt; 134KW 182CV 1596CC - FORD FOCUS III: 1.6 TDCi 07.2010/&gt;&gt;&gt;&gt; 70KW 95CV 1560CC - FORD FOCUS III: 1.6 TDCi 07.2010/&gt;&gt;&gt;&gt; 85KW 115CV ...</p> <p>47x47x48mm 1f-d18mm</p>
	<p><b>T1220</b> NO. 1715440</p> <p><b>BATEANTE DA BARRA ESTABILIZADORA DA FRENTE</b></p> <p>FORD FOCUS III 1.0 EcoBoost (De 02.2012 -) 74KW 100cv 998cm3 Hatchback FORD FOCUS III 1.0 EcoBoost (De 02.2012 -) 92KW 125cv 998cm3 Hatchback FORD FOCUS III 1.5 EcoBoost (De 09.2014 -) 110KW 150cv 1498cm3 Hatchback - FORD FOCUS III 1.5 EcoBoost (De 09.2014 -) 134KW 182cv 1498cm3 Hatchback - FORD FOCUS III 1.5 TDCi (De 09.2014 -) 70KW 95cv 1499cm3 Hatchback - FORD FOCUS III 1.5 TDCi (De 09.2014 -) 8...</p> <p>44x46x52mm 1f-d21mm</p>	<p><b>T1221</b> NO. 1810326</p> <p><b>BATEANTE DA BARRA ESTABILIZADORA DA FRENTE</b></p> <p>FORD FOCUS III 1.0 EcoBoost (De 02.2012 -) 74KW 100cv 998cm3 Hatchback - FORD FOCUS III 1.0 EcoBoost (De 02.2012 -) 92KW 125cv 998cm3 Hatchback - FORD FOCUS III 1.5 EcoBoost (De 09.2014 -) 110KW 150cv 1498cm3 Hatchback - FORD FOCUS III 1.5 EcoBoost (De 09.2014 -) 134KW 182cv 1498cm3 Hatchback - FORD FOCUS III 1.5 TDCi (De 09.2014 -) 70KW 95cv 1499cm3 Hatchback - FORD FOCUS III 1.5 TDCi (De 09.2014 -) 8...</p> <p>44x47x52mm 1f-d23mm</p>
	<p><b>U7033K</b> NO. 1212679 - 1212679 - 1332662 - 1474287 - 1S7C-3334-AA - 3M51-3334-AA</p> <p><b>ORINGS BOMBA DIREÇÃO ASSITIDA</b></p> <p>FORD FOCUS III três volumes 1.0 EcoBoost (02.2012 -02.2020) 74kw 100cv 998cm3 três volumes FORD FOCUS III três volumes 1.0 EcoBoost (02.2012 -02.2020) 92kw 125cv 998cm3 três volumes FORD FOCUS III três volumes 1.0 EcoBoost (10.2017 -02.2020) 103kw 140cv 998cm3 três volumes FORD FOCUS III três volumes 1.5 EcoBoost (11.2014 -02.2020) 134kw 182cv 1498cm3 três volumes FORD FOCUS III três volumes 1.5 ...</p> <p>d11x2mm d10x2mm 1f-d7mm 1f-d6mm</p>	<p><b>U7033K</b> NO. 1212679 - 1212679 - 1332662 - 1474287 - 1S7C-3334-AA - 3M51-3334-AA</p> <p><b>ORINGS BOMBA DIREÇÃO ASSITIDA</b></p> <p>FORD FOCUS III Turnier 1.0 EcoBoost (02.2012 -02.2020) 74kw 100cv 998cm3 Combi FORD FOCUS III Turnier 1.0 EcoBoost (02.2012 -02.2020) 92kw 125cv 998cm3 Combi FORD FOCUS III Turnier 1.0 EcoBoost (10.2017 -02.2020) 103kw 140cv 998cm3 Combi FORD FOCUS III Turnier 1.6 EcoBoost (07.2010 -06.2014) 134kw 182cv 1596cm3 Combi FORD FOCUS III Turnier 1.6 Flexifuel (07.2010 -02.2020) 88kw 120cv 1596cm3 Combi...</p> <p>d11x2mm d10x2mm 1f-d7mm 1f-d6mm</p>
	<p><b>U7033K</b> NO. 1212679 - 1212679 - 1332662 - 1474287 - 1S7C-3334-AA - 3M51-3334-AA</p> <p><b>ORINGS BOMBA DIREÇÃO ASSITIDA</b></p> <p>FORD FOCUS III Caixa/Combi 1.5 EcoBoost (09.2014 -02.2020) 110kw 150cv 1498cm3 Caixa/Combi FORD FOCUS III Caixa/Combi 1.5 TDCi (09.2014 -02.2020) 88kw 120cv 1499cm3 Caixa/Combi FORD FOCUS III Caixa/parte traseira inclinada 1.5 EcoBoost (09.2014 -12.2017) 110kw 150cv 1498cm3 Caixa/parte traseira inclinada FORD FOCUS III Caixa/parte traseira inclinada 1.5 TDCi (09.2014 -12.2017) 88kw 120cv 1499cm3 ...</p> <p>d11x2mm d10x2mm 1f-d7mm 1f-d6mm</p>	<p><b>U7033K</b> NO. 1212679 - 1212679 - 1332662 - 1474287 - 1S7C-3334-AA - 3M51-3334-AA</p> <p><b>ORINGS BOMBA DIREÇÃO ASSITIDA</b></p> <p>FORD FOCUS III 1.0 EcoBoost (02.2012 -12.2017) 74kw 100cv 998cm3 Hatchback FORD FOCUS III 1.0 EcoBoost (02.2012 -12.2017) 92kw 125cv 998cm3 Hatchback FORD FOCUS III 1.0 EcoBoost (10.2017 -02.2020) 103kw 140cv 998cm3 Hatchback FORD FOCUS III 1.5 EcoBoost (09.2014 -12.2017) 110kw 150cv 1498cm3 Hatchback FORD FOCUS III 1.5 EcoBoost (09.2014 -12.2017) 134kw 182cv 1498cm3 Hatchback FORD FOCUS III 1.5 ...</p> <p>d11x2mm d10x2mm 1f-d7mm 1f-d6mm</p>
	<p><b>U7033K</b> NO. 1212679 - 1212679 - 1332662 - 1474287 - 1S7C-3334-AA - 3M51-3334-AA</p> <p><b>ORINGS BOMBA DIREÇÃO ASSITIDA</b></p> <p>FORD FOCUS II três volumes (DB_, FCH, DH) 1.4 (04.2005 -09.2012) 59kw 80cv 1388cm3 três volumes FORD FOCUS II três volumes (DB_, FCH, DH) 1.6 (04.2005 -09.2012) 74kw 100cv 1596cm3 três volumes FORD FOCUS II três volumes (DB_, FCH, DH) 1.6 TDCi (04.2005 -09.2012) 66kw 90cv 1560cm3 três volumes FORD FOCUS II três volumes (DB_, FCH, DH) 1.6 TDCi (04.2005 -09.2012) 74kw 100cv 1560cm3 três volumes FOR...</p> <p>d11x2mm d10x2mm 1f-d7mm 1f-d6mm</p>	<p><b>U7033K</b> NO. 1212679 - 1212679 - 1332662 - 1474287 - 1S7C-3334-AA - 3M51-3334-AA</p> <p><b>ORINGS BOMBA DIREÇÃO ASSITIDA</b></p> <p>FORD FOCUS II Turnier (DA_, FFS, DS) 1.4 (07.2004 -09.2012) 59kw 80cv 1388cm3 Combi FORD FOCUS II Turnier (DA_, FFS, DS) 1.6 (07.2004 -07.2011) 74kw 100cv 1596cm3 Combi FORD FOCUS II Turnier (DA_, FFS, DS) 1.6 LPG (10.2009 -09.2012) 85kw 115cv 1596cm3 Combi FORD FOCUS II Turnier (DA_, FFS, DS) 1.6 TDCi (07.2004 -09.2012) 66kw 90cv 1560cm3 Combi FORD FOCUS II Turnier (DA_, FFS, DS) 1.6 TDCi (07.2004 -09.2012) 74kw 100cv 1596cm3 Combi FORD FOCUS II Turnier (DA_, FFS, DS) 1.6 TDCi (07.2004 -09.2012) 74kw 100cv 1596cm3 Combi...</p> <p>d11x2mm d10x2mm 1f-d7mm 1f-d6mm</p>

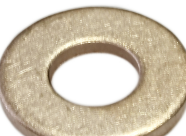
	<p><b>U7033K</b> NO. 1212679 - 1212679 - 1332662 - 1474287 - 1S7C-3334-AA - 3M51-3334-AA</p> <p><b>ORINGS BOMBA DIREÇÃO ASSITIDA</b></p> <p>FORD FOCUS II (DA_ HCP, DP) 1.4 (07.2004 -09.2012) 59kw 80cv 1388cm3 Hatchback FORD FOCUS II (DA_ HCP, DP) 1.6 (07.2004 -09.2012) 74kw 100cv 1596cm3 Hatchback FORD FOCUS II (DA_ HCP, DP) 1.6 LPG (10.2009 -07.2011) 85kw 115cv 1596cm3 Hatchback FORD FOCUS II (DA_ HCP, DP) 1.6 TDCi (01.2005 -09.2012) 66kw 90cv 1560cm3 Hatchback FORD FOCUS II (DA_ HCP, DP) 1.6 TDCi (07.2004 -09.2012) 74kw 100cv ...</p> <p>d11x2mm d10x2mm 1f-d7mm 1f-d6mm</p>		<p><b>U7033K</b> NO. 1212679 - 1212679 - 1332662 - 1474287 - 1S7C-3334-AA - 3M51-3334-AA</p> <p><b>ORINGS BOMBA DIREÇÃO ASSITIDA</b></p> <p>FORD FOCUS I (DAW, DBW) 1.4 16V (10.1998 -11.2004) 55kw 75cv 1388cm3 Hatchback FORD FOCUS I (DAW, DBW) 1.6 16V (10.1998 -11.2004) 74kw 100cv 1596cm3 Hatchback FORD FOCUS I (DAW, DBW) 1.6 16V Flexifuel (01.2002 -11.2004) 75kw 102cv 1596cm3 Hatchback FORD FOCUS I (DAW, DBW) 1.8 16V (10.1998 -11.2004) 85kw 115cv 1796cm3 Hatchback FORD FOCUS I (DAW, DBW) 1.8 16V BiFuel (09.2002 -07.2004) 85kw 115cv 1... </p> <p>d11x2mm d10x2mm 1f-d7mm 1f-d6mm</p>
	<p><b>U7033K</b> NO. 1212679 - 1212679 - 1332662 - 1474287 - 1S7C-3334-AA - 3M51-3334-AA</p> <p><b>ORINGS BOMBA DIREÇÃO ASSITIDA</b></p> <p>FORD FOCUS C-MAX (DM2) 1.6 (10.2003 -03.2007) 74kw 100cv 1596cm3 Veículo multiuso FORD FOCUS C-MAX (DM2) 1.6 TDCi (02.2005 -03.2007) 66kw 90cv 1560cm3 Veículo multiuso FORD FOCUS C-MAX (DM2) 1.6 TDCi (10.2003 -03.2007) 80kw 109cv 1560cm3 Veículo multiuso FORD FOCUS C-MAX (DM2) 1.6 Ti (08.2004 -03.2007) 85kw 115cv 1596cm3 Veículo multiuso FORD FOCUS C-MAX (DM2) 1.8 (10.2003 -03.2007) 88kw 120cv 17... </p> <p>d11x2mm d10x2mm 1f-d7mm 1f-d6mm</p>		<p><b>UAP81312</b> NO. 1715204 - 9M5Q9E568BA</p> <p><b>ANILHA DE PROTEÇÃO TÉRMICA INJECTORES</b></p> <p>FORD FOCUS III 2.0 TDCi (De 07.2010 Até 06.2014) 85kW 115cv 1997cm3 Hatchback - FORD FOCUS III 2.0 TDCi (De 07.2010 Até 06.2014) 103kW 140cv 1997cm3 Hatchback - FORD FOCUS III 2.0 TDCi (De 07.2010 Até 06.2014) 120kW 163cv 1997cm3 Hatchback - FORD FOCUS III Turnier 2.0 TDCi (De 07.2010 -) 85kW 115cv 1997cm3 Combi - FORD FOCUS III Turnier 2.0 TDCi (De 07.2010 -) 103kW 140cv 1997cm3 Combi - FORD FOCU... </p> <p>d14x1.5mm 1f-d7mm</p>
	<p><b>UAP81313</b> NO. 1364301 - 4M5Q9M577AA</p> <p><b>ANILHA PROTEÇÃO TÉRMICA INJECTORES</b></p> <p>FORD FOCUS C-MAX (DM2) 1.8 TDCi 01.2005/03.2007 85KW 115CV 1753CC KKDB KKDA 8566611 8566AAN</p> <p>d13x2mm 1f-d7mm</p>		<p><b>UAP81313</b> NO. 1364301 - 4M5Q9M577AA</p> <p><b>ANILHA PROTEÇÃO TÉRMICA INJECTORES</b></p> <p><b>PILOT</b> INFORMAÇÕES TIPO ANO DE CONSTRUÇÃO KW HP CC CÓDIGO(S) DO MOTOR M3MERO KBA (ALEMÃ) 3-5-4WD desde 01.2005 2432205 - M5Q9E568AA - M5Q9E568CA</p>
	<p><b>UAP83244</b> NO. 1230952 - 1432205 - 3M5QE568AA - M5Q9E568CA</p> <p><b>ANILHA PROTEÇÃO TÉRMICA INJECTORES</b></p> <p>FORD FOCUS II (DA_ HCP - DP) 1.6 TDCi (De 01-2005 Até 09-2012) 66kW 90CV 1560cc Hatchback FORD FOCUS II (DA_ HCP - DP) 1.6 TDCi (De 07-2004 Até 09-2012) 74kW 100CV 1560cc Hatchback FORD FOCUS II (DA_ HCP - DP) 1.6 TDCi (De 07-2004 Até 09-2012) 80kW 109CV 1560cc Hatchback FORD FOCUS II três volumes (DB_ FCH - DH) 1.6 TDCi (De 04-2005 Até 09-2012) 66kW 90CV 1560cc três volumes FORD FOCUS... </p> <p>d15x2mm 1f-d7mm</p>		<p><b>UAP83244</b> NO. 1230952 - 1432205 - 3M5QE568AA - M5Q9E568CA</p> <p><b>ANILHA PROTEÇÃO TÉRMICA INJECTORES</b></p> <p>FORD FOCUS III 1.5 TDCi (De 09-2014 Até .1-20 -) 70kW 95CV 1499cc Hatchback FORD FOCUS III 1.5 TDCi ECONetic (De 09-2014 Até .1-20 -) 77kW 105CV 1499cc Hatchback FORD FOCUS III 1.5 TDCi (De 09-2014 Até .1-20 -) 88kW 120CV 1499cc Hatchback FORD FOCUS III 1.6 TDCi (De 07-2010 Até .1-20 -) 70kW 95CV 1560cc Hatchback FORD FOCUS III 1.6 TDCi ECONetic (De 05-2012 Até .1-20 -) 77kW 105CV 1560cc Hatch... </p> <p>d15x2mm 1f-d7mm</p>
	<p><b>UAP83252</b> NO. 1700379 - AV6Q9E568AA</p> <p><b>ANILHA PROTEÇÃO TÉRMICA INJECTORES</b></p> <p>FORD FOCUS III 1.6 TDCi (07.2010 -12.2017) 70kw 95cv 1560cm3 Hatchback FORD FOCUS III 1.6 TDCi (07.2010 -12.2017) 85kw 115cv 1560cm3 Hatchback FORD FOCUS III 1.6 TDCi ECONetic (05.2012 -07.2015) 77kw 105cv 1560cm3 Hatchback</p> <p>d15x2mm 1f-d6mm</p>		<p><b>UAP83252</b> NO. 1700379 - AV6Q9E568AA</p> <p><b>ANILHA PROTEÇÃO TÉRMICA INJECTORES</b></p> <p>FORD FOCUS III Turnier 1.6 TDCi (07.2010 -02.2020) 70kw 95cv 1560cm3 Combi FORD FOCUS III Turnier 1.6 TDCi (07.2010 -02.2020) 85kw 115cv 1560cm3 Combi FORD FOCUS III Turnier 1.6 TDCi ECONetic (05.2012 -07.2015) 77kw 105cv 1560cm3 Combi</p> <p>d15x2mm 1f-d6mm</p>
	<p><b>UAP83252</b> NO. 1700379 - AV6Q9E568AA</p> <p><b>ANILHA PROTEÇÃO TÉRMICA INJECTORES</b></p> <p>FORD FOCUS III três volumes 1.6 TDCi (07.2010 -02.2020) 70kw 95cv 1560cm3 três volumes FORD FOCUS III três volumes 1.6 TDCi (07.2010 -02.2020) 85kw 115cv 1560cm3 três volumes</p> <p>d15x2mm 1f-d6mm</p>		<p><b>UAP83255</b> NO. 1118410 - YS4Q9E568AA</p> <p><b>ANILHA PROTEÇÃO TÉRMICA INJECTORES</b></p> <p>FORD FOCUS I (DAW, DBW) 1.8 DI / TDDi 08.1999/11.2004 55KW 75CV 1753CC BHDB BHDA 8566402 8566377 - FORD FOCUS I (DAW, DBW) 1.8 TDCi 03.2001/11.2004 85KW 115CV 1753CC F9DB F9DA 8566460 8566459 - FORD FOCUS I (DAW, DBW) 1.8 TDCi 08.2002/11.2004 74KW 100CV 1753CC FFDA 8566510 8566509 - FORD FOCUS I (DAW, DBW) 1.8 Turbo DI / TDDi 10.1998/11.2004 66KW 90CV 1753CC C9DC C9DB C9DA 8566368 8566369</p> <p>d16x1mm 1f-d7mm</p>
	<p><b>UAP83255</b> NO. 1118410 - YS4Q9E568AA</p> <p><b>ANILHA PROTEÇÃO TÉRMICA INJECTORES</b></p> <p>FORD FOCUS I três volumes (DFW) 1.8 TDCi 03.2001/11.2004 85KW 115CV 1753CC F9DB F9DA 8566461 - FORD FOCUS I três volumes (DFW) 1.8 TDCi 08.2002/11.2004 74KW 100CV 1753CC FFDA 8566508 - FORD FOCUS I três volumes (DFW) 1.8 Turbo DI / TDDi 02.1999/11.2004 66KW 90CV 1753CC C9DC C9DB C9DA 8566362 - FORD FOCUS I três volumes (DFW) 1.8 Turbo DI / TDDi 08.2001/03.2005 55KW 75CV 1753CC BHDB BHDA 8566463</p> <p>d16x1mm 1f-d7mm</p>		<p><b>UAP83255</b> NO. 1118410 - YS4Q9E568AA</p> <p><b>ANILHA PROTEÇÃO TÉRMICA INJECTORES</b></p> <p>FORD FOCUS I Turnier (DNW) 1.8 DI / TDDi 08.1999/11.2004 55KW 75CV 1753CC BHDB BHDA 8566378 - FORD FOCUS I Turnier (DNW) 1.8 TDCi 03.2001/11.2004 85KW 115CV 1753CC F9DB F9DA 8566462 - FORD FOCUS I Turnier (DNW) 1.8 TDCi 08.2002/11.2004 74KW 100CV 1753CC FFDA 8566507 - FORD FOCUS I Turnier (DNW) 1.8 Turbo DI / TDDi 02.1999/11.2004 66KW 90CV 1753CC C9DC C9DB C9DA 8566367</p> <p>d16x1mm 1f-d7mm</p>
	<p><b>UCRZ1080</b> NO. 1746601 - 1805656 - 97FG-3W007-AA</p> <p><b>CRUZETA VEIO TRANSMISSÃO TRIPOIDE D32MM/22 DENTES</b></p> <p>FORD FOCUS I (DAW, DBW) 1.4 16V (De 10.1998 Até 11.2004) 55kW 75cv 1388cm3 Hatchback - FORD FOCUS I (DAW, DBW) 1.6 16V (De 10.1998 Até 11.2004) 74kW 100cv 1596cm3 Hatchback - FORD FOCUS I (DAW, DBW) 1.6 16V Flexifuel (De 01.2002 Até 11.2004) 75kW 102cv 1596cm3 Hatchback -</p> <p>d30mm (22 dentes)</p>		<p><b>UCRZ1080</b> NO. 1746601 - 1805656 - 97FG-3W007-AA</p> <p><b>CRUZETA VEIO TRANSMISSÃO TRIPOIDE D32MM/22 DENTES</b></p> <p>FORD FOCUS II (DA_ HCP, DP) 1.4 (De 07.2004 Até 09.2012) 59kW 80cv 1388cm3 Hatchback - FORD FOCUS II (DA_ HCP, DP) 1.6 (De 07.2004 Até 09.2012) 74kW 100cv 1596cm3 Hatchback - FORD FOCUS II (DA_ HCP, DP) 1.6 LPG (De 10.2009 Até 07.2011) 85kW 115cv 1596cm3 Hatchback - FORD FOCUS II (DA_ HCP, DP) 1.6 Ti (De 07.2004 Até 09.2012) 85kW 115cv 1596cm3 Hatchback - FORD FOCUS II Cabriolet 1.6 (De 10.2000... </p> <p>d30mm (22 dentes)</p>

	<p><b>UCRZ1080</b> NO. 1746601 - 1805656 - 97FG-3W007-AA</p> <p><b>CRUZETA VEIO TRANSMISSÃO TRIPOIDE D32MM/22 DENTES</b></p> <p>FORD FOCUS III 1.0 EcoBoost (De 02.2012 Até 12.2017) 74kW 100cv 998cm3 Hatchback - FORD FOCUS III 1.0 EcoBoost (De 02.2012 Até 12.2017) 92kW 125cv 998cm3 Hatchback - FORD FOCUS III 1.6 EcoBoost (De 07.2010 Até 06.2014) 110kW 150cv 1596cm3 Hatchback - FORD FOCUS III 1.6 EcoBoost (De 07.2010 Até 06.2014) 134kW 182cv 1596cm3 Hatchback - FORD FOCUS III 1.6 Flexifuel (De 07.2010 -) 88kW 120cv 1596cm3 H...</p> <p>d30mm (22 dentes)</p>		<p><b>UCRZ1083</b> NO. 1328363 - 1451463 - 1451464 - 1477841 - 1477842 - 2114-3B436-CE - 4371796 - 4N51-3B436-KX</p> <p><b>CRUZETA VEIO TRANSMISSÃO TRIPOIDE D43,20MM/26 DENTES</b></p> <p>FORD FOCUS II (DA_, HCP, DP) 2.5 RS (De 01.2009 Até 07.2011) 224kW 305cv 2521cm3 Hatchback - FORD FOCUS II (DA_, HCP, DP) 2.5 RS 500 (De 05.2010 Até 07.2011) 257kW 350cv 2521cm3 Hatchback - FORD FOCUS II (DA_, HCP, DP) 2.5 ST (De 10.2005 Até 09.2012) 166kW 225cv 2522cm3 Hatchback -</p> <p>d43,2mm 26 dentes</p>
	<p><b>UCRZ1092</b> NO. 1061888 - 1322224 - 1451974 - 1461228</p> <p><b>CRUZETA TRANSMISSÃO TRIPOIDE D33,90MM/23 DENTES</b></p> <p>FORD FOCUS C-MAX (DM2) 1.6 (De 10.2003 Até 03.2007) 74kW 100cv 1596cm3 Veículo multiuso - FORD FOCUS C-MAX (DM2) 1.6 Ti (De 08.2004 Até 03.2007) 85kW 115cv 1596cm3 Veículo multiuso - FORD FOCUS C-MAX (DM2) 1.8 (De 10.2003 Até 03.2007) 88kW 120cv 1798cm3 Veículo multiuso - FORD FOCUS C-MAX (DM2) 1.8 (De 09.2005 Até 03.2007) 90kW 122cv 1798cm3 Veículo multiuso - FORD FOCUS C-MAX (DM2) 1.8 (De 04.200...</p> <p>d33,9mm (23 dentes)</p>		<p><b>UCRZ1092</b> NO. 1061888 - 1322224 - 1451974 - 1461228</p> <p><b>CRUZETA TRANSMISSÃO TRIPOIDE D33,90MM/23 DENTES</b></p> <p>FORD FOCUS I (DAW, DBW) 1.6 16V (De 10.1998 Até 11.2004) 74kW 100cv 1596cm3 Hatchback - FORD FOCUS I (DAW, DBW) 1.6 16V Flexifuel (De 01.2002 Até 11.2004) 75kW 102cv 1596cm3 Hatchback - FORD FOCUS I (DAW, DBW) 1.8 16V (De 10.1998 Até 11.2004) 85kW 115cv 1796cm3 Hatchback - FORD FOCUS I (DAW, DBW) 1.8 16V BiFuel (De 09.2002 Até 07.2004) 85kW 115cv 1796cm3 Hatchback - FORD FOCUS I (DAW, DBW) 1.8 DI ...</p> <p>d33,9mm (23 dentes)</p>
	<p><b>UCRZ1092</b> NO. 1061888 - 1322224 - 1451974 - 1461228</p> <p><b>CRUZETA TRANSMISSÃO TRIPOIDE D33,90MM/23 DENTES</b></p> <p>FORD FOCUS II (DA_, HCP, DP) 1.6 (De 07.2004 Até 09.2012) 74kW 100cv 1596cm3 Hatchback - FORD FOCUS II (DA_, HCP, DP) 1.6 LPG (De 10.2009 Até 07.2011) 85kW 115cv 1596cm3 Hatchback - FORD FOCUS II (DA_, HCP, DP) 1.6 Ti (De 07.2004 Até 09.2012) 85kW 115cv 1596cm3 Hatchback - FORD FOCUS II (DA_, HCP, DP) 1.8 (De 03.2006 Até 09.2012) 92kW 125cv 1798cm3 Hatchback - FORD FOCUS II (DA_, HCP, DP) 1.8 Flex...</p> <p>d33,9mm (23 dentes)</p>		<p><b>UCRZ1092</b> NO. 1061888 - 1322224 - 1451974 - 1461228</p> <p><b>CRUZETA TRANSMISSÃO TRIPOIDE D33,90MM/23 DENTES</b></p> <p>FORD FOCUS III 1.6 EcoBoost (De 07.2010 Até 06.2014) 110kW 150cv 1596cm3 Hatchback - FORD FOCUS III 1.6 EcoBoost (De 07.2010 Até 06.2014) 134kW 182cv 1596cm3 Hatchback - FORD FOCUS III 1.6 Flexifuel (De 07.2010 -) 88kW 120cv 1596cm3 Hatchback - FORD FOCUS III 1.6 Ti (De 07.2010 Até 05.2018) 77kW 105cv 1596cm3 Hatchback - FORD FOCUS III 1.6 Ti (De 07.2010 Até 12.2017) 92kW 125cv 1596cm3 Hatchback - ...</p> <p>d33,9mm (23 dentes)</p>
	<p><b>UCRZ1096</b> NO. 1113727 - 1364028 - 1454211 - 1475130 - 1486231 - 1528656 - 1552939 - 1552948 - 1686115</p> <p><b>CRUZETA TRANSMISSÃO TRIPOIDE D40MM/23 DENTES</b></p> <p>FORD FOCUS I (DAW, DBW) 1.6 16V 10.1998/11.2004 74kW 100CV 1596CC FYDH FYDC FYDA FYDD FYDB 8566346 8566350 - FORD FOCUS I (DAW, DBW) 1.6 16V Flexifuel 01.2002/11.2004 75KW 102CV 1596CC FYDH</p> <p>d40mm (23 dentes)</p>		<p><b>UCRZ1096</b> NO. 1113727 - 1364028 - 1454211 - 1475130 - 1486231 - 1528656 - 1552939 - 1552948 - 1686115</p> <p><b>CRUZETA TRANSMISSÃO TRIPOIDE D40MM/23 DENTES</b></p> <p>FORD FOCUS II (DA_, HCP, DP) 2.0 07.2004/09.2012 107KW 145CV 1999CC AODE AODB AODA SYDA 8566576 8566ABA - FORD FOCUS II (DA_, HCP, DP) 2.0 CNG 04.2009/07.2011 107KW 145CV 1999CC SYDA 8566A9V - FORD FOCUS II (DA_, HCP, DP) 2.0 LPG 06.2008/07.2011 107KW 145CV 1999CC SYDA 8566APR - FORD FOCUS II Cabriolet 2.0 10.2006/09.2010 107KW 145CV 1999CC AODB AODA SYDA AODE 8566AEY - FORD FOCUS II três volumes ...</p> <p>d40mm (23 dentes)</p>
	<p><b>UCRZ1100</b> NO. 25989508 - 4166925</p> <p><b>CRUZETA TRANSMISSÃO TRIPOIDE D35,50MM/24 DENTES</b></p> <p>FORD FOCUS I (DAW, DBW) 1.8 DI / TDDi 08.1999/11.2004 55KW 75CV 1753CC BHDB BHDA 8566402 8566377 - FORD FOCUS I (DAW, DBW) 1.8 TDCi 03.2001/11.2004 85KW 115CV 1753CC F9DB F9DA 8566460 8566459 - FORD FOCUS I (DAW, DBW) 1.8 TDCi 08.2002/11.2004 74KW 100CV 1753CC FFDA 8566510 8566509 - FORD FOCUS I (DAW, DBW) 1.8 Turbo DI / TDDi 10.1998/11.2004 66KW 90CV 1753CC C9DC C9DB C9DA 8566368 8566369</p> <p>d35,5mm (24 dentes)</p>		<p><b>UMV25305</b> NO. 1318360 - 1331570 - 4M51A045B79</p> <p><b>MANETE PUNHO TOPO ALAVANCA MUDANÇAS 5 VELOCIDADES F13MM</b></p> <p>FORD FOCUS II (DA_, HCP, DP): 1.4 07.2004/09.2012 59KW 80CV 1388CC - FORD FOCUS II (DA_, HCP, DP): 1.6 07.2004/09.2012 74KW 100CV 1596CC - FORD FOCUS II (DA_, HCP, DP): 1.6 Ti 07.2004/09.2012 85KW 115CV 1596CC - FORD FOCUS II (DA_, HCP, DP): 1.6 LPG 10.2009/07.2011 85KW 115CV 1596CC - FORD FOCUS II (DA_, HCP, DP): 1.8 03.2006/09.2012 92KW 125CV 1798CC - FORD FOCUS II (DA_, HCP, DP): 1.8 Flexifuel ...</p> <p>d51x88mm 1f-d13mm</p>
	<p><b>UMV25306</b> NO. 1318360 - 1331570 - 4M51A045B79</p> <p><b>MANETE PUNHO TOPO ALAVANCA MUDANÇAS 5 VELOCIDADES F13MM</b></p> <p>FORD FOCUS II (DA_, HCP, DP): 1.4 07.2004/09.2012 59KW 80CV 1388CC - FORD FOCUS II (DA_, HCP, DP): 1.6 07.2004/09.2012 74KW 100CV 1596CC - FORD FOCUS II (DA_, HCP, DP): 1.6 Ti 07.2004/09.2012 85KW 115CV 1596CC - FORD FOCUS II (DA_, HCP, DP): 1.6 LPG 10.2009/07.2011 85KW 115CV 1596CC - FORD FOCUS II (DA_, HCP, DP): 1.8 03.2006/09.2012 92KW 125CV 1798CC - FORD FOCUS II (DA_, HCP, DP): 1.8 Flexifuel ...</p> <p>d51x89mm 1f-d13mm</p>		<p><b>UMV25325</b> NO. 1580939 - AM8A6J-7J132-ABT</p> <p><b>MANETE PUNHO TOPO ALAVANCA MUDANÇAS 5 VELOCIDADES F14MM</b></p> <p>FORD FOCUS C-MAX (DM2) 1.6 (De 10.2003 Até 03.2007) 74kW 100cv 1596cm3 Veículo multiuso - FORD FOCUS C-MAX (DM2) 1.6 TDCi (De 02.2005 Até 03.2007) 66kW 90cv 1560cm3 Veículo multiuso - FORD FOCUS C-MAX (DM2) 1.6 TDCi (De 10.2003 Até 03.2007) 80kW 109cv 1560cm3 Veículo multiuso - FORD FOCUS C-MAX (DM2) 1.6 Ti (De 08.2004 Até 03.2007) 85kW 115cv 1596cm3 Veículo multiuso - FORD FOCUS C-MAX (DM2) 1.8 (...)</p> <p>d46x90mm 1f-d14mm</p>
	<p><b>UMV25325</b> NO. 1580939 - AM8A6J-7J132-ABT</p> <p><b>MANETE PUNHO TOPO ALAVANCA MUDANÇAS 5 VELOCIDADES F14MM</b></p> <p>FORD FOCUS II (DA_, HCP, DP) 1.4 (De 07.2004 Até 09.2012) 59kW 80cv 1388cm3 Hatchback - FORD FOCUS II (DA_, HCP, DP) 1.6 (De 07.2004 Até 09.2012) 74kW 100cv 1596cm3 Hatchback - FORD FOCUS II (DA_, HCP, DP) 1.6 LPG (De 10.2009 Até 07.2011) 85kW 115cv 1596cm3 Hatchback - FORD FOCUS II (DA_, HCP, DP) 1.6 TDCi (De 01.2005 Até 09.2012) 66kW 90cv 1560cm3 Hatchback - FORD FOCUS II (DA_, HCP, DP) 1.6 TDCi...</p> <p>d46x90mm 1f-d14mm</p>		<p><b>UMV25325</b> NO. 1580939 - AM8A6J-7J132-ABT</p> <p><b>MANETE PUNHO TOPO ALAVANCA MUDANÇAS 5 VELOCIDADES F14MM</b></p> <p>FORD FOCUS III 1.0 EcoBoost (De 02.2012 Até 12.2017) 74kW 100cv 998cm3 Hatchback - FORD FOCUS III 1.0 EcoBoost (De 02.2012 Até 12.2017) 92kW 125cv 998cm3 Hatchback - FORD FOCUS III 1.0 EcoBoost (De 10.2017 Até 06.2019) 103kW 140cv 998cm3 Hatchback - FORD FOCUS III 1.5 EcoBoost (De 09.2014 Até 12.2017) 110kW 150cv 1498cm3 Hatchback - FORD FOCUS III 1.5 EcoBoost (De 09.2014 Até 12.2017) 134kW 182cv ...</p> <p>d46x90mm 1f-d14mm</p>
	<p><b>UMV26801</b> NO. 1069044 - XS4R7217AA</p> <p><b>MANETE PUNHO TOPO ALAVANCA MUDANÇAS 5 VELOCIDADES F13MM</b></p> <p>FORD FOCUS (DAW, DBW): 1.4 16V 10.1998/11.2004 55KW 75CV 1388CC - FORD FOCUS (DAW, DBW): 1.6 16V 10.1998/11.2004 74KW 100CV 1596CC - FORD FOCUS (DAW, DBW): 1.8 DI / TDDi 08.1999/11.2004 55KW 75CV 1753CC - FORD FOCUS (DAW, DBW): 1.8 Turbo DI / TDDi 10.1998/11.2004 66KW 90CV 1753CC - FORD FOCUS (DAW, DBW): 1.8 TDCi 08.2002/11.2004 74KW 100CV 1753CC - FORD FOCUS (DAW, DBW): 1.8 TDCi 03.2001/11.2004 8...</p> <p>48x96x56mm 1f-d13mm</p>		<p><b>UMV26802</b> NO. 1580939 - AM8A6J7J132BB</p> <p><b>MANETE PUNHO TOPO ALAVANCA MUDANÇAS 5 VELOCIDADES F14MM</b></p> <p>FORD FOCUS C-MAX (DM2): 1.8 09.2005/03.2007 90KW 122CV 1798CC - FORD FOCUS C-MAX (DM2): 1.6 TDCi 02.2005/03.2007 66KW 90CV 1560CC - FORD FOCUS C-MAX (DM2): 1.8 TDCi 01.2005/03.2007 85KW 115CV 1753CC - FORD FOCUS II (DA_, HCP, DP): 2.5 ST 10.2005/09.2012 166kW 225CV 2522CC - FORD FOCUS II (DA_, HCP, DP): 1.6 TDCi 01.2005/09.2012 66kW 90CV 1560CC - FORD FOCUS II (DA_, HCP, DP): 1.8 TDCi 01.2005/09.2...</p> <p>46x90x51mm 1f-d14mm</p>







	<p><b>UMV26808</b> NO. 1571917 - AM8A6J-7J132-AB</p> <p>MANETE PUNHO TOPO ALAVANCA MUDANÇAS 5 VELOCIDADES F13MM</p> <p>FORD FOCUS II (DA_, HCP, DP): 2.5 ST 10.2005/09.2012 166KW 225CV 2522CC - FORD FOCUS II (DA_, HCP, DP): 1.6 TDCi 01.2005/09.2012 66KW 90CV 1560CC - FORD FOCUS II (DA_, HCP, DP): 1.8 TDCi 01.2005/09.2012 85KW 115CV 1753CC - FORD FOCUS II três volumes (DB_, FCH, DH): 1.4 04.2005/09.2012 59KW 80CV 1388CC - FORD FOCUS II três volumes (DB_, FCH, DH): 1.6 04.2005/09.2012 74KW 100CV 1596CC - FORD FOCUS I...</p> <p>51x46x79mm 1f-d13mm</p>		<p><b>UMV26808</b> NO. 1571917 - AM8A6J-7J132-AB</p> <p>MANETE PUNHO TOPO ALAVANCA MUDANÇAS 5 VELOCIDADES F13MM</p> <p>FORD FOCUS C-MAX (DM2): 1.8 09.2005/03.2007 90KW 122CV 1798CC - FORD FOCUS C-MAX (DM2): 1.6 TDCi 02.2005/03.2007 66KW 90CV 1560CC - FORD FOCUS C-MAX (DM2): 1.8 TDCi 01.2005/03.2007 85KW 115CV 1753CC</p> <p>51x46x79mm 1f-d13mm</p>
	<p><b>UMV26813</b> NO. 1798600 - 7G9R7217CKD</p> <p>MANETE PUNHO TOPO ALAVANCA MUDANÇAS 6 VELOCIDADES F11/30MM</p> <p>FORD FOCUS II (DA_, HCP, DP): 1.4 07.2004/09.2012 59KW 80CV 1388CC - FORD FOCUS II (DA_, HCP, DP): 1.6 07.2004/09.2012 74KW 100CV 1596CC - FORD FOCUS II (DA_, HCP, DP): 1.6 Ti 07.2004/09.2012 85KW 115CV 1596CC - FORD FOCUS II (DA_, HCP, DP): 1.6 LPG 10.2009/07.2011 85KW 115CV 1596CC - FORD FOCUS II (DA_, HCP, DP): 1.8 03.2006/09.2012 92KW 125CV 1798CC - FORD FOCUS II (DA_, HCP, DP): 1.8 Flexifuel ...</p> <p>53x47x54mm 1f-d11/30mm</p>		<p><b>UPCR5004</b> NO. 1454051 - 1567143 - 1678260</p> <p>PORCA DA RODA CHAVE 19 M12X1,50X30MM ( BASE CONICA )</p> <p>FORD FOCUS C-MAX (DM2) 1.6 (10.2003 -03.2007) 74kw 100cv 1596cm3 Veículo multiuso FORD FOCUS C-MAX (DM2) 1.6 TDCi (02.2005 -03.2007) 66kw 90cv 1560cm3 Veículo multiuso FORD FOCUS C-MAX (DM2) 1.6 TDCi (10.2003 -03.2007) 80kw 109cv 1560cm3 Veículo multiuso FORD FOCUS C-MAX (DM2) 1.6 Ti (08.2004 -03.2007) 85kw 115cv 1596cm3 Veículo multiuso FORD FOCUS C-MAX (DM2) 1.8 (10.2003 -03.2007) 88kw 120cv 179...</p> <p>d26x32mm M12x1,5mm</p>
	<p><b>UPCR5004</b> NO. 1454051 - 1567143 - 1678260</p> <p>PORCA DA RODA CHAVE 19 M12X1,50X30MM ( BASE CONICA )</p> <p>FORD FOCUS I (DAW, DBW) 1.4 16V (10.1998 -11.2004) 55kw 75cv 1388cm3 Hatchback FORD FOCUS I (DAW, DBW) 1.6 16V (10.1998 -11.2004) 74kw 100cv 1596cm3 Hatchback FORD FOCUS I (DAW, DBW) 1.8 16V (10.1998 -11.2004) 85kw 115cv 1796cm3 Hatchback FORD FOCUS I (DAW, DBW) 1.8 DI / TDDi (08.1999 -11.2004) 55kw 75cv 1753cm3 Hatchback FORD FOCUS I (DAW, DBW) 1.8 TDCi (08.2002 -11.2004) 74kw 100cv 1753cm3 Hatch...</p> <p>d26x32mm M12x1,5mm</p>		<p><b>UPCR5004</b> NO. 1454051 - 1567143 - 1678260</p> <p>PORCA DA RODA CHAVE 19 M12X1,50X30MM ( BASE CONICA )</p> <p>FORD FOCUS I Turnier (DNW) 1.4 16V (02.1999 -11.2004) 55kw 75cv 1388cm3 Combi FORD FOCUS I Turnier (DNW) 1.6 16V (02.1999 -11.2004) 74kw 100cv 1596cm3 Combi FORD FOCUS I Turnier (DNW) 1.8 16V (02.1999 -11.2004) 85kw 115cv 1796cm3 Combi FORD FOCUS I Turnier (DNW) 1.8 DI / TDDi (08.1999 -11.2004) 55kw 75cv 1753cm3 Combi FORD FOCUS I Turnier (DNW) 1.8 TDCi (03.2001 -11.2004) 85kw 115cv 1753cm3 Combi ...</p> <p>d26x32mm M12x1,5mm</p>
	<p><b>UPCR5004</b> NO. 1454051 - 1567143 - 1678260</p> <p>PORCA DA RODA CHAVE 19 M12X1,50X30MM ( BASE CONICA )</p> <p>FORD FOCUS I três volumes (DFW) 1.4 16V (02.1999 -11.2004) 55kw 75cv 1388cm3 três volumes FORD FOCUS I três volumes (DFW) 1.6 16V (02.1999 -11.2004) 74kw 100cv 1596cm3 três volumes FORD FOCUS I três volumes (DFW) 1.8 16V (02.1999 -11.2004) 85kw 115cv 1796cm3 três volumes FORD FOCUS I três volumes (DFW) 1.8 TDCi (08.2002 -11.2004) 74kw 100cv 1753cm3 três volumes FORD FOCUS I três volumes (DFW) 1.8 ...</p> <p>d26x32mm M12x1,5mm</p>		<p><b>UPCR5004</b> NO. 1454051 - 1567143 - 1678260</p> <p>PORCA DA RODA CHAVE 19 M12X1,50X30MM ( BASE CONICA )</p> <p>FORD FOCUS II (DA_, HCP, DP) 1.4 (07.2004 -09.2012) 59kw 80cv 1388cm3 Hatchback FORD FOCUS II (DA_, HCP, DP) 1.6 (07.2004 -09.2012) 74kw 100cv 1596cm3 Hatchback FORD FOCUS II (DA_, HCP, DP) 1.6 LPG (10.2009 -07.2011) 85kw 115cv 1596cm3 Hatchback FORD FOCUS II (DA_, HCP, DP) 1.6 TDCi (01.2005 -09.2012) 66kw 90cv 1560cm3 Hatchback FORD FOCUS II (DA_, HCP, DP) 1.6 TDCi (07.2004 -09.2012) 74kw 100cv 1...</p> <p>d26x32mm M12x1,5mm</p>
	<p><b>UPCR5004</b> NO. 1454051 - 1567143 - 1678260</p> <p>PORCA DA RODA CHAVE 19 M12X1,50X30MM ( BASE CONICA )</p> <p>FORD FOCUS II Cabriolet 1.6 (10.2006 -09.2010) 74kw 100cv 1596cm3 Cabriolet FORD FOCUS II Cabriolet 2.0 (10.2006 -09.2010) 107kw 145cv 1999cm3 Cabriolet FORD FOCUS II Cabriolet 2.0 TDCi (10.2006 -09.2010) 100kw 136cv 1997cm3 Cabriolet</p> <p>d26x32mm M12x1,5mm</p>		<p><b>UPCR5004</b> NO. 1454051 - 1567143 - 1678260</p> <p>PORCA DA RODA CHAVE 19 M12X1,50X30MM ( BASE CONICA )</p> <p>FORD FOCUS II Turnier (DA_, FFS, DS) 1.4 (07.2004 -09.2012) 59kw 80cv 1388cm3 Combi FORD FOCUS II Turnier (DA_, FFS, DS) 1.6 (07.2004 -07.2011) 74kw 100cv 1596cm3 Combi FORD FOCUS II Turnier (DA_, FFS, DS) 1.6 LPG (10.2009 -09.2012) 85kw 115cv 1596cm3 Combi FORD FOCUS II Turnier (DA_, FFS, DS) 1.6 TDCi (07.2004 -09.2012) 66kw 90cv 1560cm3 Combi FORD FOCUS II Turnier (DA_, FFS, DS) 1.6 TDCi (07.2004 -09.2012) 74kw 100cv 1...</p> <p>d26x32mm M12x1,5mm</p>
	<p><b>UPCR5004</b> NO. 1454051 - 1567143 - 1678260</p> <p>PORCA DA RODA CHAVE 19 M12X1,50X30MM ( BASE CONICA )</p> <p>FORD FOCUS II três volumes (DB_, FCH, DH) 1.4 (04.2005 -09.2012) 59kw 80cv 1388cm3 três volumes FORD FOCUS II três volumes (DB_, FCH, DH) 1.6 (04.2005 -09.2012) 74kw 100cv 1596cm3 três volumes FORD FOCUS II três volumes (DB_, FCH, DH) 1.6 TDCi (04.2005 -09.2012) 66kw 90cv 1560cm3 três volumes FORD FOCUS II três volumes (DB_, FCH, DH) 1.6 TDCi (04.2005 -09.2012) 74kw 100cv 1560cm3 três volumes FORD...</p> <p>d26x32mm M12x1,5mm</p>		<p><b>UPCR5004</b> NO. 1454051 - 1567143 - 1678260</p> <p>PORCA DA RODA CHAVE 19 M12X1,50X30MM ( BASE CONICA )</p> <p>FORD FOCUS III 1.0 EcoBoost (02.2012 -12.2017) 74kw 100cv 998cm3 Hatchback FORD FOCUS III 1.0 EcoBoost (02.2012 -12.2017) 92kw 125cv 998cm3 Hatchback FORD FOCUS III 1.6 EcoBoost (07.2010 -06.2014) 110kw 150cv 1596cm3 Hatchback FORD FOCUS III 1.6 EcoBoost (07.2010 -06.2014) 134kw 182cv 1596cm3 Hatchback FORD FOCUS III 1.6 Flexifuel (07.2010 -) 88kw 120cv 1596cm3 Hatchback FORD FOCUS III 1.6 Flexifuel...</p> <p>d26x32mm M12x1,5mm</p>
	<p><b>UPCR5004</b> NO. 1454051 - 1567143 - 1678260</p> <p>PORCA DA RODA CHAVE 19 M12X1,50X30MM ( BASE CONICA )</p> <p>FORD FOCUS III Turnier 1.0 EcoBoost (02.2012 -) 74kw 100cv 998cm3 Combi FORD FOCUS III Turnier 1.0 EcoBoost (02.2012 -) 92kw 125cv 998cm3 Combi FORD FOCUS III Turnier 1.6 EcoBoost (07.2010 -) 110kw 150cv 1596cm3 Combi FORD FOCUS III Turnier 1.6 EcoBoost (07.2010 -) 134kw 182cv 1596cm3 Combi FORD FOCUS III Turnier 1.6 Flexifuel (07.2013 -) 110kw 150cv 1596cm3 Combi FORD FOCUS III Turnier 1.6 Flexifuel...</p> <p>d26x32mm M12x1,5mm</p>		<p><b>UPCR5004</b> NO. 1454051 - 1567143 - 1678260</p> <p>PORCA DA RODA CHAVE 19 M12X1,50X30MM ( BASE CONICA )</p> <p>FORD FOCUS III três volumes 1.0 EcoBoost (02.2012 -) 74kw 100cv 998cm3 três volumes FORD FOCUS III três volumes 1.0 EcoBoost (02.2012 -) 92kw 125cv 998cm3 três volumes FORD FOCUS III três volumes 1.6 EcoBoost (07.2010 -) 110kw 150cv 1596cm3 três volumes FORD FOCUS III três volumes 1.6 EcoBoost (07.2010 -) 134kw 182cv 1596cm3 três volumes FORD FOCUS III três volumes 1.6 Flexifuel (07.2010 -) 88kw 1...</p> <p>d26x32mm M12x1,5mm</p>
	<p><b>UPCR5018</b> NO. 1007487 - 1447852 - 1470843</p> <p>PORCA DA RODA CHAVE 19 M12X1,50X16MM ( BASE CONICA PARA JANTE DE AÇO )</p> <p>FORD FOCUS C-MAX (DM2) 1.6 (10.2003 - 03.2007) 74kw 100cv 1596cm3 Veículo multiuso FORD FOCUS C-MAX (DM2) 1.6 TDCi (02.2005 - 03.2007) 66kw 90cv 1560cm3 Veículo multiuso FORD FOCUS C-MAX (DM2) 1.6 TDCi (10.2003 - 03.2007) 80kw 109cv 1560cm3 Veículo multiuso FORD FOCUS C-MAX (DM2) 1.6 Ti (08.2004 - 03.2007) 85kw 115cv 1596cm3 Veículo multiuso FORD FOCUS C-MAX (DM2) 1.8 (10.2003 - 03.2007) 88kw 120cv...</p> <p>d19x15mm M12x15mm</p>		<p><b>UPCR5018</b> NO. 1007487 - 1447852 - 1470843</p> <p>PORCA DA RODA CHAVE 19 M12X1,50X16MM ( BASE CONICA PARA JANTE DE AÇO )</p> <p>FORD FOCUS I (DAW, DBW) 1.4 16V (10.1998 - 11.2004) 55kw 75cv 1388 Hatchback FORD FOCUS I (DAW, DBW) 1.6 16V (10.1998 - 11.2004) 74kw 100cv 1596 Hatchback FORD FOCUS I (DAW, DBW) 1.6 16V Flexifuel (01.2002 - 11.2004) 75kw 102cv 1596 Hatchback FORD FOCUS I (DAW, DBW) 1.8 16V (10.1998 - 11.2004) 85kw 115cv 1796cm3 Hatchback FORD FOCUS I (DAW, DBW) 1.8 16V BiFuel (09.2002 - 07.2004) 85kw 115cv 1796cm...</p> <p>d19x15mm M12x15mm</p>

	<p><b>UPCR5018</b> NO. 1007487 - 1447852 - 1470843</p> <p>PORCA DA RODA CHAVE 19 M12X1,50X16MM ( BASE CONICA PARA JANTE DE AÇO )</p> <p>FORD FOCUS II (DA_, HCP, DP) 1.4 (07.2004 - 09.2012) 59kw 80cv 1388cm3 Hatchback FORD FOCUS II (DA_, HCP, DP) 1.6 (07.2004 - 09.2012) 74kw 100cv 1596cm3 Hatchback FORD FOCUS II (DA_, HCP, DP) 1.6 LPG (10.2009 - 07.2011) 85kw 115cv 1596cm3 Hatchback FORD FOCUS II (DA_, HCP, DP) 1.6 TDCi (01.2005 - 09.2012) 66kw 90cv 1560cm3 Hatchback FORD FOCUS II (DA_, HCP, DP) 1.6 TDCi (07.2004 - 09.2012) 74kw 10...</p> <p>d19x15mm M12x15mm</p>		<p><b>UPCR5018</b> NO. 1007487 - 1447852 - 1470843</p> <p>PORCA DA RODA CHAVE 19 M12X1,50X16MM ( BASE CONICA PARA JANTE DE AÇO )</p> <p>FORD FOCUS II Cabriolet 1.6 (10.2006 - 09.2010) 74kw 100cv 1596cm3 Cabriolet FORD FOCUS II Cabriolet 2.0 (10.2006 - 09.2010) 107kw 145cv 1999cm3 Cabriolet FORD FOCUS II Cabriolet 2.0 TDCi (10.2006 - 09.2010) 100kw 136cv 1997cm3 Cabriolet</p> <p>d19x15mm M12x15mm</p>
	<p><b>UPCR5018</b> NO. 1007487 - 1447852 - 1470843</p> <p>PORCA DA RODA CHAVE 19 M12X1,50X16MM ( BASE CONICA PARA JANTE DE AÇO )</p> <p>FORD FOCUS II Caixa/Combi 1.6 TDCi (09.2005 - 07.2011) 66kw 90cv 1560cm3 Caixa/Combi FORD FOCUS II Caixa/Combi 1.6 TDCi (07.2004 - 07.2011) 80kw 109cv 1560cm3 Caixa/Combi FORD FOCUS II Caixa/Combi 1.6 Ti-VCT (09.2005 - 07.2011) 85kw 116cv 1596cm3 Caixa/Combi</p> <p>d19x15mm M12x15mm</p>		<p><b>UPCR5018</b> NO. 1007487 - 1447852 - 1470843</p> <p>PORCA DA RODA CHAVE 19 M12X1,50X16MM ( BASE CONICA PARA JANTE DE AÇO )</p> <p>FORD FOCUS II Turnier (DA_, FFS, DS) 1.4 (07.2004 - 09.2012) 59kw 80cv 1388cm3 Combi FORD FOCUS II Turnier (DA_, FFS, DS) 1.6 (07.2004 - 07.2011) 74kw 100cv 1596cm3 Combi FORD FOCUS II Turnier (DA_, FFS, DS) 1.6 LPG (10.2009 - 09.2012) 85kw 115cv 1596cm3 Combi FORD FOCUS II Turnier (DA_, FFS, DS) 1.6 TDCi (07.2004 - 09.2012) 66kw 90cv 1560cm3 Combi FORD FOCUS II Turnier (DA_, FFS, DS) 1.6 TDCi (07...)</p> <p>d19x15mm M12x15mm</p>
	<p><b>UPCR5018</b> NO. 1007487 - 1447852 - 1470843</p> <p>PORCA DA RODA CHAVE 19 M12X1,50X16MM ( BASE CONICA PARA JANTE DE AÇO )</p> <p>FORD FOCUS II três volumes (DB_, FCH, DH) 1.4 (04.2005 - 09.2012) 59kw 80cv 1388cm3 três volumes FORD FOCUS II três volumes (DB_, FCH, DH) 1.6 (04.2005 - 09.2012) 74kw 100cv 1596cm3 três volumes FORD FOCUS II três volumes (DB_, FCH, DH) 1.6 TDCi (04.2005 - 09.2012) 74kw 100cv 1560cm3 três volumes FORD FOCUS II três volumes (DB_, FCH, DH) 1.6 TDCi (04.2005 - 09.2012) 80kw 109cv 1560cm3 três volumes...</p> <p>d19x15mm M12x15mm</p>		<p><b>UPCR5018</b> NO. 1007487 - 1447852 - 1470843</p> <p>PORCA DA RODA CHAVE 19 M12X1,50X16MM ( BASE CONICA PARA JANTE DE AÇO )</p> <p>FORD FOCUS III 1.0 EcoBoost (02.2012 - 12.2017) 74 100 998 Hatchback FORD FOCUS III 1.0 EcoBoost (02.2012 - 12.2017) 92 125 998 Hatchback FORD FOCUS III 1.6 EcoBoost (07.2010 - 06.2014) 110 150 1596 Hatchback FORD FOCUS III 1.6 EcoBoost (07.2010 - 06.2014) 134 182 1596 Hatchback FORD FOCUS III 1.6 Flexifuel (07.2010 - 02.2020) 88 120 1596 Hatchback FORD FOCUS III 1.6 Flexifuel (07.2013 - 02.2020) ...</p> <p>d19x15mm M12x15mm</p>
	<p><b>UPCR5018</b> NO. 1007487 - 1447852 - 1470843</p> <p>PORCA DA RODA CHAVE 19 M12X1,50X16MM ( BASE CONICA PARA JANTE DE AÇO )</p> <p>FORD FOCUS III Caixa/parte traseira inclinada 1.6 EcoBoost (11.2011 - 06.2014) 110kw 150cv 1596cm3 Caixa/parte traseira inclinada FORD FOCUS III Caixa/parte traseira inclinada 1.6 EcoBoost (11.2011 - 06.2014) 134kw 182cv 1596cm3 Caixa/parte traseira inclinada FORD FOCUS III Caixa/parte traseira inclinada 1.6 TDCi (01.2011 - 12.2017) 70kw 95cv 1560cm3 Caixa/parte traseira inclinada FORD FOCUS III C...</p> <p>d19x15mm M12x15mm</p>		<p><b>UPCR5018</b> NO. 1007487 - 1447852 - 1470843</p> <p>PORCA DA RODA CHAVE 19 M12X1,50X16MM ( BASE CONICA PARA JANTE DE AÇO )</p> <p>FORD FOCUS III Turnier 1.0 EcoBoost (02.2012 - 02.2020) 74kw 100cv 998cm3 Combi FORD FOCUS III Turnier 1.0 EcoBoost (02.2012 - 02.2020) 92kw 125cv 998cm3 Combi FORD FOCUS III Turnier 1.6 EcoBoost (07.2010 - 06.2014) 134kw 182cv 1596cm3 Combi FORD FOCUS III Turnier 1.6 Flexifuel (07.2010 - 02.2020) 88kw 120cv 1596cm3 Combi FORD FOCUS III Turnier 1.6 Flexifuel (07.2013 - 02.2020) 110kw 150cv 1596cm3...</p> <p>d19x15mm M12x15mm</p>
	<p><b>UPCR5018</b> NO. 1007487 - 1447852 - 1470843</p> <p>PORCA DA RODA CHAVE 19 M12X1,50X16MM ( BASE CONICA PARA JANTE DE AÇO )</p> <p>FORD FOCUS III três volumes 1.0 EcoBoost (02.2012 - 02.2020) 74kw 100cv 998cm3 três volumes FORD FOCUS III três volumes 1.0 EcoBoost (02.2012 - 02.2020) 92kw 125cv 998cm3 três volumes FORD FOCUS III três volumes 1.6 EcoBoost (07.2010 - 06.2014) 110kw 150cv 1596cm3 três volumes FORD FOCUS III três volumes 1.6 EcoBoost (07.2010 - 06.2014) 134kw 182cv 1596cm3 três volumes FORD FOCUS III três volumes ...</p> <p>d19x15mm M12x15mm</p>		<p><b>UPCR5020</b> NO. 1377747 - 1382841 - 1428137 - 1676176 - 5196786 - 5275544</p> <p>PORCA DA RODA CHAVE 21 M14X1,5X34MM ( BASE CONICA )</p> <p>FORD FOCUS III 1.0 EcoBoost (02.2012 - 12.2017) 74kw 100cv 998cm3 Hatchback FORD FOCUS III 1.0 EcoBoost (02.2012 - 12.2017) 92kw 125cv 998cm3 Hatchback FORD FOCUS III 1.0 EcoBoost (10.2017 - 06.2019) 103kw 140cv 998cm3 Hatchback FORD FOCUS III 1.5 EcoBoost (09.2014 - 12.2017) 110kw 150cv 1498cm3 Hatchback FORD FOCUS III 1.5 EcoBoost (09.2014 - 12.2017) 134kw 182cv 1498cm3 Hatchback FORD FOCUS III 1.5 T...</p> <p>d28x34mm M14x32mm</p>
	<p><b>UTR0820</b> NO. 90352470 - 90409256 - 90409257 - 9041032690497472 - 90467473</p> <p>TAMPÃO RESERVATÓRIO LIQUIDO REFRIGERAÇÃO</p> <p>FORD FOCUS ( DAW , DBW ) 1.4 16 V (10.98 A 11.04) 75cv 1388cc Hatchback - FORD FOCUS ( D A W , D B W ) 1.6 16 V (10.98 A 11.04) 100cv 1596cc Hatchback - FORD FOCUS ( D A W , D B W ) 1.8 16 V (10.98 A 11.04) 115cv 1796cc Hatchback - FORD FOCUS ( D A W , D B W ) 2.0 16 V (10.98 A 11.04) 131cv 1988cc Hatchback 5 / 13 - FORD FOCUS (DAW, DBW) ST170 (03.02 A 11.04) 173cv 1988cc Hatchback - FOR...</p> <p>d62x23mm 1f-d53x12mm</p>		<p><b>UTR0847</b> NO. 1224233 - 1301104 - 3M5H8100AC</p> <p>TAMPÃO RESERVATÓRIO LIQUIDO REFRIGERAÇÃO</p> <p>FORD FOCUS II (DA_, HCP) 1.4 (07.04 A 09.12) 80cv 1388cc Hatchback - FORD FOCUS II (DA_, HCP) 1.6 (07.04 A 09.12) 100cv 1596cc Hatchback - FORD FOCUS II (DA_, HCP) 1.6 Ti (07.04 A 09.12) 115cv 1596cc Hatchback - FORD FOCUS II (DA_, HCP) 1.6 LPG (10.09 A 07.11) 115cv 1596cc Hatchback - FORD FOCUS II (DA_, HCP) 1.8 (03.06 A 09.12) 125cv 1798cc Hatchback - FORD FOCUS II (DA_, HCP) 1.8 Flexi...</p> <p>d62x35mm 1f-d50x16mm</p>
	<p><b>UTR0850</b> NO. 1039234 - 1092327 - 1110205 - 7198459 - 95VW8100AA - 95VW8100AC - YM218100BAGYAA</p> <p>TAMPÃO RESERVATÓRIO LIQUIDO REFRIGERAÇÃO</p> <p>FORD FOCUS II Cabriolet 2.0 TDCi (10.06 A 09.10) 136cv 1997cc Cabriolet</p> <p>d80x48mm 1f-d48x26mm</p>		<p><b>UTR0859</b> NO. 1650630 - 94539597 - 96293957 - 96312510 - 96351578 - 96420303 - 96536649</p> <p>TAMPÃO RESERVATÓRIO LIQUIDO REFRIGERAÇÃO</p> <p>FORD FOCUS ( DAW , DBW ) 1.4 16 V (10.98 A 11.04) 75cv 1388cc Hatchback - FORD FOCUS ( DAW , DBW ) 1.6 16 V (10.98 A 11.04) 100cv 1596cc Hatchback - FORD FOCUS ( DAW , DBW ) 1.8 16 V (10.98 A 11.04) 115cv 1796cc Hatchback - FORD FOCUS - ( DAW , DBW ) 2.0 16 V (10.98 A 11.04) 131cv 1988cc Hatchback - FORD FOCUS ( DAW , DBW ) ST 170 (03.02 A 11.04) 173cv 1988cc Hatchback - FORD FOCUS ( D...</p> <p>d63x23mm 1f-d53x11mm</p>
	<p><b>UTV83002</b> NO. 2S6Q6730AA</p> <p>TAMPÃO VEDAÇÃO BUJÃO</p> <p>FORD FOCUS II (DA_ - HCP - DP) 1.6 Ti (De 07-2004 Até 09-2012) 85kw 115CV 1596cc Hatchback FORD FOCUS II (DA_ - HCP - DP) 1.6 TDCi (De 01-2005 Até 09-2012) 66kw 90CV 1560cc Hatchback FORD FOCUS II (DA_ - HCP - DP) 1.6 TDCi (De 07-2004 Até 09-2012) 74kw 100CV 1560cc Hatchback FORD FOCUS II (DA_ - HCP - DP) 1.6 TDCi (De 07-2004 Até 09-2012) 80kw 109CV 1560cc Hatchback FORD FOCUS II três volumes 20x18mm c13mm d10mm</p>		<p><b>UTV83002</b> NO. 2S6Q6730AA</p> <p>TAMPÃO VEDAÇÃO BUJÃO</p> <p>FORD FOCUS III 1.6 TDCi (De 07-2010 Até -1-20 -) 70kw 95CV 1560cc Hatchback FORD FOCUS III 1.6 TDCi ECOnetic (De 05-2012 Até -1-20 -) 77kw 105CV 1560cc Hatchback FORD FOCUS III 1.6 TDCi (De 07-2010 Até -1-20 -) 85kw 115CV 1560cc Hatchback FORD FOCUS III três volumes 1.6 TDCi (De 07-2010 Até -1-20 -) 70kw 95CV 1560cc três volumes FORD FOCUS III três volumes 1.6 TDCi (De 07-2010 Até -1-20 -) 85k...</p> <p>20x18mm c13mm d10mm</p>

	<p><b>UTV83010</b> NO. 1013938 - 97JM6730BA</p> <p>TAMPÃO VEDAÇÃO BUJÃO</p> <p>FORD FOCUS (DAW - DBW) 1.4 16V (De 10-1998 Até 11-2004) 55kW 75CV 1388cc Hatchback FORD FOCUS (DAW - DBW) 1.6 16V (De 10-1998 Até 11-2004) 74kW 100CV 1596cc Hatchback FORD FOCUS (DAW - DBW) 1.8 16V (De 10-1998 Até 11-2004) 85kW 115CV 1796cc Hatchback FORD FOCUS (DAW - DBW) 2.0 16V (De 10-1998 Até 11-2004) 96kW 131CV 1988cc Hatchback FORD FOCUS (DAW - DBW) 1.8 DI / TDDi (De 08-1999 Até 11-2004)...</p> <p>d28x35mm c19mm d13mm</p>		<p><b>UTV83010</b> NO. 1013938 - 97JM6730BA</p> <p>TAMPÃO VEDAÇÃO BUJÃO</p> <p>FORD FOCUS C-MAX 1.8 (De 10-2003 Até 03-2007) 88kW 120CV 1798cc Veículo multiuso FORD FOCUS C-MAX 1.8 (De 09-2005 Até 03-2007) 90kW 122CV 1798cc Veículo multiuso FORD FOCUS C-MAX 1.8 (De 04-2004 Até 03-2007) 92kW 125CV 1798cc Veículo multiuso FORD FOCUS C-MAX 1.8 Flexifuel (De 01-2006 Até 03-2007) 92kW 125CV 1798cc Veículo multiuso FORD FOCUS C-MAX 1.8 TDCi (De 01-2005 Até 03-2007) 85kW 115CV ...</p> <p>d28x35mm c19mm d13mm</p>
	<p><b>UTV83010</b> NO. 1013938 - 97JM6730BA</p> <p>TAMPÃO VEDAÇÃO BUJÃO</p> <p>FORD FOCUS II (DA_ - HCP - DP) 1.4 (De 07-2004 Até 09-2012) 59kW 80CV 1388cc Hatchback FORD FOCUS II (DA_ - HCP - DP) 1.6 (De 07-2004 Até 09-2012) 74kW 100CV 1596cc Hatchback FORD FOCUS II (DA_ - HCP - DP) 2.0 (De 07-2004 Até 09-2012) 107kW 145CV 1999cc Hatchback FORD FOCUS II (DA_ - HCP - DP) 2.0 LPG (De 06-2008 Até 07-2011) 107kW 145CV 1999cc Hatchback FORD FOCUS II (DA_ - HCP - DP) 2.0 TDCi...</p> <p>d28x35mm c19mm d13mm</p>		<p><b>UTV83010</b> NO. 1013938 - 97JM6730BA</p> <p>TAMPÃO VEDAÇÃO BUJÃO</p> <p>FORD FOCUS III 1.6 Ti (De 08-2011 Até .1-20 -) 63kW 85CV 1596cc Hatchback FORD FOCUS III 1.6 Ti (De 07-2010 Até .1-20 -) 77kW 105CV 1596cc Hatchback FORD FOCUS III 1.6 Ti (De 07-2010 Até .1-20 -) 92kW 125CV 1596cc Hatchback FORD FOCUS III três volumes 1.6 Ti (De 08-2011 Até .1-20 -) 63kW 85CV 1596cc três volumes FORD FOCUS III três volumes 1.6 Ti (De 07-2010 Até .1-20 -) 77kW 105CV 1596cc três...</p> <p>d28x35mm c19mm d13mm</p>
	<p><b>UTV83010</b> NO. 1013938 - 97JM6730BA</p> <p>TAMPÃO VEDAÇÃO BUJÃO</p> <p>FORD FUSION (JU_) 1.25 (De 08-2004 Até 12-2012) 55kW 75CV 1242cc Combi FORD FUSION (JU_) 1.4 (De 08-2002 Até 12-2012) 59kW 80CV 1388cc Combi</p> <p>d28x35mm c19mm d13mm</p>		<p><b>UTV83012</b> NO. 1457117 - 1657022 - 1663906 - 6093527 - 6186775 - 6732529 - 70TM6730AA - 89FF6730AA</p> <p>TAMPÃO VEDAÇÃO BUJÃO</p> <p>FORD FOCUS C-MAX 1.8 (De 10-2003 Até 03-2007) 88kW 120CV 1798cc Veículo multiuso FORD FOCUS C-MAX 1.8 (De 09-2005 Até 03-2007) 90kW 122CV 1798cc Veículo multiuso FORD FOCUS C-MAX 1.8 (De 04-2004 Até 03-2007) 92kW 125CV 1798cc Veículo multiuso FORD FOCUS C-MAX 1.8 TDCi (De 01-2005 Até 03-2007) 85kW 115CV 1753cc Veículo multiuso</p> <p>d23x26mm c15mm d13mm</p>
	<p><b>UVN81230</b> NO. 1695517 - 9M5Q6750CA - 9M5Q6750BA - 1624445 - 1318717</p> <p>VARETA DO NIVEL ÓLEO</p> <p>FORD FOCUS II (DA_, HCP, DP) 1.6 TDCi (01.2005 - 09.2012) 66kw 90cv 1560cm3 Hatchback FORD FOCUS II (DA_, HCP, DP) 1.6 TDCi (07.2004 - 09.2012) 74kw 100cv 1560cm3 Hatchback FORD FOCUS II (DA_, HCP, DP) 1.6 TDCi (07.2004 - 09.2012) 80kw 109cv 1560cm3 Hatchback</p> <p>595x6mm</p>		<p><b>UVN81230</b> NO. 1695517 - 9M5Q6750CA - 9M5Q6750BA - 1624445 - 1318717</p> <p>VARETA DO NIVEL ÓLEO</p> <p>FORD FOCUS II Turnier (DA_, FFS, DS) 1.6 TDCi (07.2004 - 09.2012) 66kw 90cv 1560cm3 Combi FORD FOCUS II Turnier (DA_, FFS, DS) 1.6 TDCi (07.2004 - 09.2012) 74kw 100cv 1560cm3 Combi FORD FOCUS II Turnier (DA_, FFS, DS) 1.6 TDCi (07.2004 - 09.2012) 80kw 109cv 1560cm3 Combi</p> <p>595x6mm</p>
	<p><b>W5015</b> NO. 1147683 - 1319519 - 1369546 - 1369548 - 1473366 - 1485765 - 1487861 - 1517975 - 1517976 - 2...</p> <p>POLIE DA CABBOTA S/EMBRAIAGEM (6 pistas)</p> <p>FORD FOCUS C-MAX 1.6 TDCi (10-2003 A 03-2007) - FOCUS 1.6 Ti - 1.6 TDCi (APÓS 11-2004)</p> <p>d152.8mm d30mm</p>		<p><b>W5016</b> NO. 1231959 - 1490842 - 1520590 - 1683820 - 1837783 - 3MSQ-6B319-AA - 7MSQ-6B319-AA - 7MSQ-6B319-AB - 8M...</p> <p>POLIE DA CABBOTA (6 pistas)</p> <p>FORD FOCUS II (DA_, HCP, DP) 2.0 TDCi 07.2004/09.2012 100KW 136CV 1997CC G6DD G6DG G6DA G6DB 8566575 8566ABE - FORD FOCUS II Turnier (DA_, FFS, DS) 2.0 TDCi 07.2004/09.2012 100KW 136CV 1997CC G6DG G6DD G6DB G6DA 8566586 8566ABF</p> <p>d152.5mm d16mm</p>
	<p><b>W5026</b> NO. 1038330 - 1135052 - 1250444 - 26105255 - 6599021 - 928M6B320DB - 928M6B320DD - 928M6B320DE - 928M6B3...</p> <p>POLIE CABBOTA (6 PISTAS)</p> <p>FORD FOCUS (DAW, DBW): 1.8 16V 10.1998/11.2004 85KW 115CV 1796CC - FORD FOCUS (DAW, DBW): 2.0 16V 10.1998/11.2004 96KW 131CV 1988CC - FORD FOCUS (DAW, DBW): ST170 03.2002/11.2004 127KW 173CV 1988CC - FORD FOCUS três volumes (DFW): 1.8 16V 02.1999/11.2004 85KW 115CV 1796CC - FORD FOCUS três volumes (DFW): 2.0 16V 02.1999/11.2004 96KW 131CV 1988CC - FORD FOCUS Turnier (DNW): 1.8 16V 02.1999/11.2004 ...</p> <p>d131.3mm d28mm</p>		<p><b>W5035</b> NO. 1135052</p> <p>POLIE DA CABBOTA (6 PISTAS)</p> <p>FORD FOCUS 1.8 16V - 2.0 16V</p> <p>d132mm d28mm</p>
	<p><b>W5055</b> NO. 1079166 - 1079188 - 1100051 - 1104415 - 1139286 - 1S4Q6A345AA - 1S4Q6A345M - XS4Q6A345AC - XS4Q6...</p> <p>POLIE DA CABBOTA (6 PISTAS)</p> <p>FORD FOCUS 1.8 Di (08-1999 A 11-2004 - Mtr BHDA - BHDB (75CV) - FOCUS 1.8 TDDi (10-1998 A 11-2004 - Mtr C9DA - DB - DC (90CV)</p> <p>d140/145mm d14mm</p>		<p><b>W5081</b> NO. 1079166 - 1104415 - 1139286 - 1143413 - 1151392 - 1S4Q6A345AA - 1S4Q6B318AE - 1S4Q6B319AE - 1S4...</p> <p>POLIE DA CABBOTA (6 PISTAS)</p> <p>FORD FOCUS I (DAW, DBW) 1.8 TDCi 03.2001/11.2004 85KW 115CV 1753CC F9DB F9DA 8566460 8566459 - FORD FOCUS I (DAW, DBW) 1.8 TDCi 08.2002/11.2004 74KW 100CV 1753CC FFDA 8566510 8566509 - FORD FOCUS I Caixa/Combi (DNW) 1.8 TDCi 08.2001/03.2005 85KW 116CV 1753CC F9DA F9DB - FORD FOCUS I Caixa/Combi (DNW) 1.8 TDCi 08.2002/03.2005 74KW 101CV 1753CC FFDA - FORD FOCUS I três volumes (DFW) 1.8 TDCi 03.2001...</p> <p>d140/153mm d14.6mm</p>
	<p><b>W5081</b> NO. 1079166 - 1104415 - 1139286 - 1143413 - 1151392 - 1S4Q6A345AA - 1S4Q6B318AE - 1S4Q6B319AE - 1S4...</p> <p>POLIE DA CABBOTA (6 PISTAS)</p> <p>FORD FOCUS I Turnier (DNW) 1.8 TDCi 03.2001/11.2004 85KW 115CV 1753CC F9DB F9DA 8566462 - FORD FOCUS I Turnier (DNW) 1.8 TDCi 08.2002/11.2004 74KW 100CV 1753CC FFDA 8566507</p> <p>d140/153mm d14.6mm</p>		<p><b>W5085</b> NO. 1232958</p> <p>POLIE DA CABBOTA (6 PISTAS)</p> <p>FORD FOCUS CAX 2.0 TDCi (136CV) (APÓS 10-2004) - FOCUS II 2.0 TDCi (136CV) (APÓS 06-2006)</p> <p>d153/158mm d16mm</p>

	<p><b>W5085</b> NO. 1232958</p> <p>POLIE DA CAMBOTA (6 PISTAS)</p> <p>FORD FOCUS C-MAX 2.0 TDCi (136CV) (APÓS 10-2004) - FOCUS II 2.0 TDCi (136CV) (APÓS 06-2006)</p> <p>d153/158mm d16mm</p>		<p><b>W5120</b> NO. 1147683 - 1319519 - 1369546 - 1369548 - 1473366 - 1485765 - 1487861 - 1517975 - 1517976 - 2...</p> <p>POLIE DA CAMBOTA C/EMBRAIAGEM (6 pistas)</p> <p>FORD - FOCUS C-MAX - 1.6 TDCi (02.05 - 03.07) 90cv 1560cc Veículo multiuso - FORD - FOCUS C-MAX - 1.6 TDCi (10.03 - 03.07) 109cv 1560cc Veículo multiuso - FORD - FOCUS II (DA_) - 1.6 TDCi Ano fabric. até: (12.09) (01.05 - 09.12) 90cv 1560cc Hatchback -</p> <p>d150/162mm d29,5mm</p>
	<p><b>W5120</b> NO. 1147683 - 1319519 - 1369546 - 1369548 - 1473366 - 1485765 - 1487861 - 1517975 - 1517976 - 2...</p> <p>POLIE DA CAMBOTA C/EMBRAIAGEM (6 pistas)</p> <p>FORD - FOCUS II (DA_) - 1.6 TDCi Ano fabric. até: (12.09) (01.05 - 09.12) 90cv 1560cc Hatchback - FORD - FOCUS II (DA_) - 1.6 TDCi Ano fabric. até: (12.09) (11.04 - 09.12) 100cv 1560cc Hatchback - FORD - FOCUS II (DA_) - 1.6 TDCi Ano fabric. até: (12.09)</p> <p>d150/162mm d29,5mm</p>		<p><b>W5165</b> NO. 1539704 - 1752282 - 8A6G6B321AB - 8A6G6B321AC</p> <p>POLIE DA CAMBOTA (6 PISTAS)</p> <p>FORD FOCUS III 1.6 Ti (De 08-2011 Até -1-20 -) 63kW 85CV 1596cc Hatchback FORD FOCUS III 1.6 Ti (De 07-2010 Até -1-20 -) 77kW 105CV 1596cc Hatchback FORD FOCUS III 1.6 Ti (De 02-2012 Até -1-20 -) 88kW 120CV 1596cc Hatchback FORD FOCUS III 1.6 Ti (De 07-2010 Até -1-20 -) 92kW 125CV 1596cc Hatchback FORD FOCUS III 1.6 LPG (De 02-2012 Até -1-20 -) 86kW 117CV 1596cc Hatchback FORD FOCUS III 1.6 L...</p> <p>d138mm d25mm</p>
	<p><b>W5177</b> NO. 1305988 - 1490906 - 1753154 - 4M5G-6B32-1ZA - 4M5G-6B32-1ZB - 4M5G-6B32-1ZC</p> <p>POLIE DA CAMBOTA (5 + 6 PISTAS)</p> <p>FORD FOCUS C-MAX (DM2): 1.6 10.2003/03.2007 74KW 100CV 1596CC - FORD FOCUS C-MAX (DM2): 1.6 Ti 08.2004/03.2007 85KW 115CV 1596CC - FORD FOCUS II (DA_, HCP, DP): 1.4 07.2004/09.2012 59KW 80CV 1388CC - FORD FOCUS II (DA_, HCP, DP): 1.6 07.2004/09.2012 74KW 100CV 1596CC - FORD FOCUS II (DA_, HCP, DP): 1.6 Ti 07.2004/09.2012 85KW 115CV 1596CC - FORD FOCUS II (DA_, HCP, DP): 1.6 LPG 10.2009/07.2011 85K...</p> <p>d138mm d24mm</p>		<p><b>W5181</b> NO. 1141497 - 1753151 - 2S6G6B321AA - 2S6G6B321AB</p> <p>POLIE DA CAMBOTA (5+6 PISTAS)</p> <p>FORD FOCUS I (DAW, DBW): 1.4 16V 10.1998/11.2004 55KW 75CV 1388CC - FORD FOCUS I (DAW, DBW): 1.4 16V 10.1998/09.1999 55KW 75CV 1388CC - FORD FOCUS I (DAW, DBW): 1.6 16V 10.1998/11.2004 74KW 100CV 1596CC - FORD FOCUS I (DAW, DBW): 1.6 16V Flexifuel 01.2002/11.2004 75KW 102CV 1596CC - FORD FOCUS I três volumes (DFW): 1.4 16V 02.1999/11.2004 55KW 75CV 1388CC - FORD FOCUS I três volumes (DFW): 1.6 16V...</p> <p>d138/83mm d24mm</p>
	<p><b>W5187</b> NO. 1072126 - 10742126 - 1087321 - 98MM6B321BB - 98MM6B321BC</p> <p>POLIE DA CAMBOTA (6 PISTAS)</p> <p>FORD FOCUS (DAW, DBW): 1.4 16V 10.1998/11.2004 55KW 75CV 1388CC - FORD FOCUS (DAW, DBW): 1.4 16V 10.1998/09.1999 55KW 75CV 1388CC - FORD FOCUS (DAW, DBW): 1.6 16V 10.1998/11.2004 74KW 100CV 1596CC - FORD FOCUS (DAW, DBW): 1.6 16V Flexifuel 01.2002/11.2004 75KW 102CV 1596CC - FORD FOCUS três volumes (DFW): 1.4 16V 02.1999/11.2004 55KW 75CV 1388CC - FORD FOCUS três volumes (DFW): 1.6 16V 02.1999/11...</p> <p>d139mm d25mm</p>		<p><b>Y3233</b> NO. 1473166 - 1481984 - 3395499 - 4432023 - 6586309 - 6789185</p> <p>PARAFUSO DA RODA CAVILHA M12X1,50X48MM</p> <p>FORD FOCUS I (DAW, DBW) 1.4 16V (10.1998 - 11.2004) 55kw 75cv 1388cm3 Hatchback FORD FOCUS I (DAW, DBW) 1.6 16V (10.1998 - 11.2004) 74kw 100cv 1596cm3 Hatchback FORD FOCUS I (DAW, DBW) 1.6 16V Flexifuel (01.2002 - 11.2004) 75kw 102cv 1596cm3 Hatchback FORD FOCUS I (DAW, DBW) 1.8 16V (10.1998 - 11.2004) 85kw 115cv 1796cm3 Hatchback FORD FOCUS I (DAW, DBW) 1.8 16V BiFuel (09.2002 - 07.2004) 85kw 115...</p> <p>c48mm M12x1,5mm</p>
	<p><b>Z41158</b> NO. 1656747 - 1825595 - 1752024 - 6740771 - 4852244</p> <p>MOLA DE FIXAÇÃO TIPO PORCA</p> <p>FORD FOCUS IV (HN) 1.0 EcoBoost (05.2018 -) 63kw 85cv 998cm3 Hatchback FORD FOCUS IV (HN) 1.0 EcoBoost (01.2018 -) 74kw 101cv 999cm3 Hatchback FORD FOCUS IV (HN) 1.0 EcoBoost (01.2018 -) 92kw 125cv 999cm3 Hatchback FORD FOCUS IV (HN) 1.0 EcoBoost mHEV (06.2020 -) 92kw 125cv 999cm3 Hatchback FORD FOCUS IV (HN) 1.0 EcoBoost mHEV (06.2020 -) 114kw 155cv 999cm3 Hatchback FORD FOCUS IV (HN) 1.0 EcoBoos...</p> <p>d12x 11mm f-d24mm</p>		<p><b>Z41158</b> NO. 1656747 - 1825595 - 1752024 - 6740771 - 4852244</p> <p>MOLA DE FIXAÇÃO TIPO PORCA</p> <p>FORD FOCUS IV Turnier (HP) 1.0 EcoBoost (09.2018 -) 63kw 85cv 998cm3 Combi FORD FOCUS IV Turnier (HP) 1.0 EcoBoost (09.2018 -) 74kw 100cv 999cm3 Combi FORD FOCUS IV Turnier (HP) 1.0 EcoBoost (09.2018 -) 92kw 125cv 999cm3 Combi FORD FOCUS IV Turnier (HP) 1.0 EcoBoost mHEV (07.2020 -) 92kw 125cv 999cm3 Combi FORD FOCUS IV Turnier (HP) 1.0 EcoBoost mHEV (07.2020 -) 114kw 155cv 999cm3 Combi FORD FOCUS...</p> <p>d12x 11mm f-d24mm</p>
	<p><b>Z41158</b> NO. 1656747 - 1825595 - 1752024 - 6740771 - 4852244</p> <p>MOLA DE FIXAÇÃO TIPO PORCA</p> <p>FORD FOCUS IV três volumes (HM) 1.0 EcoBoost (11.2018 -) 74kw 101cv 999cm3 três volumes FORD FOCUS IV três volumes (HM) 1.0 EcoBoost (11.2018 -) 92kw 125cv 999cm3 três volumes FORD FOCUS IV três volumes (HM) 1.5 EcoBlue (11.2018 -) 88kw 120cv 1499cm3 três volumes FORD FOCUS IV três volumes (HM) 1.5 EcoBlue (11.2018 -) 70kw 95cv 1499cm3 três volumes FORD FOCUS IV três volumes (HM) 1.5 EcoBoost (11....</p> <p>d12x 11mm f-d24mm</p>		<p><b>Z50130</b> NO. 11589289</p> <p>MOLA REBITE FIXAÇÃO</p> <p>FORD FOCUS III 1.0 EcoBoost (02.2012 -12.2017) 74kw 100cv 998cm3 Hatchback FORD FOCUS III 1.0 EcoBoost (02.2012 -12.2017) 92kw 125cv 998cm3 Hatchback FORD FOCUS III 1.0 EcoBoost (10.2017 -02.2020) 103kw 140cv 998cm3 Hatchback FORD FOCUS III 1.5 EcoBoost (09.2014 -12.2017) 110kw 150cv 1498cm3 Hatchback FORD FOCUS III 1.5 EcoBoost (09.2014 -12.2017) 134kw 182cv 1498cm3 Hatchback FORD FOCUS III 1.5 T...</p> <p>d6x 18mm f-d17mm</p>
	<p><b>Z50130</b> NO. 11589289</p> <p>MOLA REBITE FIXAÇÃO</p> <p>FORD FOCUS III Caixa/Combi 1.5 EcoBoost (09.2014 -02.2020) 110kw 150cv 1498cm3 Caixa/Combi FORD FOCUS III Caixa/Combi 1.5 TDCi (09.2014 -02.2020) 88kw 120cv 1499cm3 Caixa/Combi FORD FOCUS III Caixa/parte traseira inclinada 1.5 EcoBoost (09.2014 -12.2017) 110kw 150cv 1498cm3 Caixa/parte traseira inclinada FORD FOCUS III Caixa/parte traseira inclinada 1.5 TDCi (09.2014 -12.2017) 88kw 120cv 1499cm3 C...</p> <p>d6x 18mm f-d17mm</p>		<p><b>Z50130</b> NO. 11589289</p> <p>MOLA REBITE FIXAÇÃO</p> <p>FORD FOCUS III Turnier 1.0 EcoBoost (02.2012 -02.2020) 74kw 100cv 998cm3 Combi FORD FOCUS III Turnier 1.0 EcoBoost (02.2012 -02.2020) 92kw 125cv 998cm3 Combi FORD FOCUS III Turnier 1.0 EcoBoost (10.2017 -02.2020) 103kw 140cv 998cm3 Combi FORD FOCUS III Turnier 1.5 EcoBoost (09.2014 -12.2017) 110kw 150cv 1498cm3 Combi FORD FOCUS III Turnier 1.5 EcoBoost (09.2014 -02.2020) 134kw 182cv 1498cm3 Combi ...</p> <p>d6x 18mm f-d17mm</p>
	<p><b>Z50130</b> NO. 11589289</p> <p>MOLA REBITE FIXAÇÃO</p> <p>FORD FOCUS III três volumes 1.0 EcoBoost (02.2012 -02.2020) 74kw 100cv 998cm3 três volumes FORD FOCUS III três volumes 1.0 EcoBoost (02.2012 -02.2020) 92kw 125cv 998cm3 três volumes FORD FOCUS III três volumes 1.0 EcoBoost (10.2017 -02.2020) 103kw 140cv 998cm3 três volumes FORD FOCUS III três volumes 1.5 EcoBoost (11.2014 -02.2020) 110kw 150cv 1498cm3 três volumes FORD FOCUS III três volumes 1.5 E...</p> <p>d6x 18mm f-d17mm</p>		<p><b>Z57104</b> NO. 4831516</p> <p>MOLA DO PAINEL DA PORTA</p> <p>FORD FOCUS (A partir de 2011)</p> <p>F12mm T21mm L18mm H28mm S1-12mm</p>

	<b>Z80696</b>	NO. 6758612		<b>Z80706</b>	NO. 1070107
	<i>Mola de fixação</i> FORD FOCUS			<i>Mola de painel</i> FORD FOCUS	
d20.4x27mm		1p-d9-9mm	d18x25.4mm		1p-d8.5-15.9mm
	<b>Z80750</b>	NO. 1079129 - 6678518 - 6998849		<b>Z80845</b>	NO. 1028521 - W701054S300
	<i>Mola de painel</i> FORD FOCUS (De 1998 A 2005)			<i>Rebite</i> FORD FOCUS (De 2002 A 2005)	
d20x23mm		1p-d9-20mm	d25x42.5mm		1p-d8-24.5mm
	<b>Z80848</b>	NO. 1257376 - W709004S300			
	<i>Mola de painel</i> FORD FOCUS (Após 2004)				
d18x27.5mm		1p-d8.5-10.5mm			

FORD GALAXY

	<b>A1640</b>	NO. 7403748 - 7M0505221C - 95VW5K818BC		<b>A1937-C</b>	NO. 1102592 - 4503300051 - 7201592 - 7201688 - 95VW3K099AA - 95VW3K099AB
	<i>APOIO DO AMORTECEDOR DE TRÁS PARTE SUPERIOR</i> FORD GALAXY 1.9 TDi - 2.0 - 2.3 - 2.8			<i>APOIO DO AMORTECEDOR</i> FORD GALAXY (WGR) 2.0 i Posição/grau: 1 ° (11.95 A 05.08) 116cv 1998cc Veículo multiuso - FORD GALAXY (WGR) 2.3 16V Posição/grau: 1 ° (09.01 A 05.06) 140cv 2295cc Veículo multiuso - FORD GALAXY (WGR) 2.3 16V Posição/grau: 1 ° (01.97 A 05.06) 146cv 2295cc Veículo multiuso - FORD GALAXY (WGR) 2.8 i V6 Posição/grau: 1 ° (11.95 A 04.00) 174cv 2792cc Veículo multiuso - FORD GALAXY (WGR) 2.8 i V6 ...	
170x85x65mm		1r-d16mm 1f-d17mm	d82x55mm		1f-d14mm
	<b>A2120</b>	NO. 1109096		<b>A2120</b>	NO. 1109096
	<i>APOIO DE TRANSMISSÃO</i> FORD GALAXY (WGR) 2.8 V6 (04.00 A 05.06) 204cv 2792cc Veículo multiuso - FORD GALAXY (WGR) 1.9 TDI (03.95 A 05.06) 90cv 1896cc Veículo multiuso - FORD GALAXY (WGR) 1.9 TDI (04.00 A 05.06) 115cv 1896cc Veículo multiuso - FORD GALAXY (WGR) 1.9 TDI (02.03 A 05.06) 130cv 1896cc Veículo multiuso - FORD GALAXY (WGR) 1.9 TDI (05.05 A 05.06) 150cv 1896cc Veículo multiuso			<i>APOIO DE TRANSMISSÃO</i> FORD GALAXY (WGR) 2.8 V6 (04.00 A 05.06) 204cv 2792cc Veículo multiuso - FORD GALAXY (WGR) 1.9 TDI (03.95 A 05.06) 90cv 1896cc Veículo multiuso - FORD GALAXY (WGR) 1.9 TDI (04.00 A 05.06) 115cv 1896cc Veículo multiuso - FORD GALAXY (WGR) 1.9 TDI (02.03 A 05.06) 130cv 1896cc Veículo multiuso - FORD GALAXY (WGR) 1.9 TDI (05.05 A 05.06) 150cv 1896cc Veículo multiuso	
113x103x13mm		1f-d35mm 2f-d8mm 2f-8x10mm	113x103x13mm		1f-d35mm 2f-d8mm 2f-8x10mm
	<b>A2194</b>	NO. 1102593		<b>A2194</b>	NO. 7M0412341A
	<i>APOIO PRATO AMORTECEDOR FRENTE ( GASTA 2 UNIDADES )</i> FORD GALAXY (WGR) 2.0 i (De 1995.11 Até 2006.05) 85kW 116cv 1998cm3 Veículo multiuso - FORD GALAXY (WGR) 2.3 16V (De 2001.09 Até 2006.05) 103kW 140cv 2295cm3 Veículo multiuso - FORD GALAXY (WGR) 2.3 16V (De 1997.01 Até 2006.05) 107kW 146cv 2295cm3 Veículo multiuso - FORD GALAXY (WGR) 2.8 i V6 (De 1995.11 Até 2000.04) 128kW 174cv 2792cm3 Veículo multiuso - FORD GALAXY (WGR)...			<i>APOIO PRATO AMORTECEDOR FRENTE ( GASTA 2 UNIDADES )</i> SEAT ALHAMBRA (7V8, 7V9) 1.8 T 20V (De 1997.10 Até 2010.03) 110kW 150cv 1781cm3 Veículo multiuso - SEAT ALHAMBRA (7V8, 7V9) 2.0 i (De 1996.04 Até 2010.03) 85kW 115cv 1984cm3 Veículo multiuso - SEAT ALHAMBRA (7V8, 7V9) 2.8 V6 (De 2000.06 Até 2010.03) 150kW 204cv 2792cm3 Veículo multiuso - SEAT ALHAMBRA (7V8, 7V9) 2.8 V6 4motion (De 2000.06 Até 2010.03) 150kW 204cv 2792cm3 Veic...	
170x85x65mm		1f-d22mm	d116x20mm		1f-d22mm
	<b>A2323</b>	NO. 1376870 - 1417257 - 1453047 - 6G916F012DB - 6G916F012DC - 6G916F012DD		<b>A2460</b>	NO. 1377259 - 1381836 - 1406414 - 1441597 - 1734710 - 1761001 - 5183155 - AG913K155BAB
	<i>APOIO DO MOTOR FRENTE LADO DIREITO</i> FORD GALAXY II (WA6): 1.8 TDCi 05.2006/06.2015 74KW 100 1753 GALAXY II (WA6): 1.8 TDCi 05.2006 - 06.2015 92 125 1753			<i>APOIO SUPORTE AMORTECEDOR FRENTE ( GASTA 2 UNIDADES )</i> FORD GALAXY II (WA6) 1.6 EcoBoost 11.2010/06.2015 118KW 160CV 1596CC JTWB JTWA 8566AWW - FORD GALAXY II (WA6) 1.6 TDCi 02.2011/06.2015 85KW 115CV 1560CC T1WB T1WA 8566AXF - FORD GALAXY II (WA6) 1.8 TDCi 05.2006/06.2015 74KW 100CV 1753CC FFWA 8566AEV - FORD GALAXY II (WA6) 1.8 TDCi 05.2006/06.2015 92KW 125CV 1753CC QYWA 8566AEU - FORD GALAXY II (WA6) 2.0 05.2006/06.2015 107KW 145CV 1999CC AOWB AOWA...	
210x112x165mm		2f-d13mm 1f-d20mm	168x149x48mm		1f-d12mm 3f-d6mm 3f-d8mm

	<p><b>A2460</b> NO. 1377259 - 1381836 - 1406414 - 1441597 - 1734710 - 1761001 - 5183155 - AG913K155BAB</p> <p><b>APOIO SUPORTE AMORTECEDOR FRENTE ( GASTA 2 UNIDADES )</b></p> <p>FORD GALAXY III (CK) 1.5 EcoBoost 01.2015/06.2018 118KW 160CV 1499CC UNCK UNCK 8566BKJ - FORD GALAXY III (CK) 1.5 EcoBoost desde 07.2018 121KW 165CV 1499CC C15HDX 8566BRD - FORD GALAXY III (CK) 2.0 EcoBlue desde 07.2018 88KW 120CV 1995CC YNCA 8566BKL - FORD GALAXY III (CK) 2.0 EcoBlue desde 07.2018 110KW 150CV 1995CC YMCB 8566BKM - FORD GALAXY III (CK) 2.0 EcoBlue desde 07.2018 140KW 190CV 1995CC...</p> <p>168x149x48mm 1f-d12mm 3r-d6mm 3f-d8mm</p>	<p><b>A2460</b> NO. 1377259 - 1381836 - 1406414 - 1441597 - 1734710 - 1761001 - 5183155 - AG913K155BAB</p> <p><b>APOIO SUPORTE AMORTECEDOR FRENTE ( GASTA 2 UNIDADES )</b></p> <p>FORD GALAXY MK II VAN (WA6) TDCi 05.2006/06.2015 103KW 140CV 1997CC QXWA QXWB QXWC UFWA - FORD GALAXY MK II VAN (WA6) TDCi 11.2006/06.2015 96KW 131CV 1997CC AZWA - FORD GALAXY MK II VAN (WA6) TDCi 03.2013/06.2015 147KW 200CV 2179CC KNWA</p> <p>168x149x48mm 1f-d12mm 3r-d6mm 3f-d8mm</p>
	<p><b>A2546</b> NO. 1376871 - 1417258 - 1453215 - 1453239 - 6G91 6F012 EB - 6G91 6F012 EC - 6G91 6F012 ED - 6G91 6F012 E...</p> <p><b>APOIO DO MOTOR PARTE DA FRENTE LADO DIREITO</b></p> <p>FORD GALAXY II (WA6) 2.0 TDCi (De 11.2007 Até 06.2015) 85KW 115cv 1997cm3 Veículo multiuso - FORD GALAXY II (WA6) 2.0 TDCi (De 05.2006 Até 06.2015) 96KW 130cv 1997cm3 Veículo multiuso - FORD GALAXY II (WA6) 2.0 TDCi (De 05.2006 Até 06.2015) 100KW 136cv 1997cm3 Veículo multiuso - FORD GALAXY II (WA6) 2.0 TDCi (De 05.2006 Até 06.2015) 103KW 140cv 1997cm3 Veículo multiuso - FORD GALAXY II (WA6) 2.0 T...</p> <p>212x154x188mm 2f-d15mm 2f-d20mm</p>	<p><b>E0107</b> NO. 1009591 - 1141774 - 1232756 - 95VW5489AC</p> <p><b>ESTICADOR DA BARRA ESTABILIZADORA DA FRENTE</b></p> <p>FORD GALAXY TT (APÓS 03-195)</p> <p>245x35x35mm 2p-d12-25mm</p>
	<p><b>E0259</b> NO. 1377349 - 1377398 - 1377416 - 1425853 - 1502681 - 1783320 - 6G915C486XAA - 6G915C486XAB - 8V425C4...</p> <p><b>ESTICADOR BARRA ESTABILIZADORA TRAS ( GASTA 2 UNIDADES )</b></p> <p>FORD GALAXY II (WA6) 1.6 EcoBoost 11.2010/06.2015 118KW 160CV 1596CC JTWB JTWA 8566AWW - FORD GALAXY II (WA6) 1.6 TDCi 02.2011/06.2015 85KW 115CV 1560CC T1WB T1WA 8566AXF - FORD GALAXY II (WA6) 1.8 TDCi 05.2006/06.2015 74KW 100CV 1753CC FFWA 8566AEV - FORD GALAXY II (WA6) 1.8 TDCi 05.2006/06.2015 92KW 125CV 1753CC QYWA 8566AEU - FORD GALAXY II (WA6) 2.0 05.2006/06.2015 107KW 145CV 1999CC AOWB AOWA...</p> <p>200x36x36mm 1p-d10x20mm 1p-d8x22mm</p>	<p><b>E0260</b> NO. 1377849 - 6G9N3B438BA</p> <p><b>ESTICADOR DA BARRA ESTABILIZADORA DA FRENTE</b></p> <p>FORD GALAXY II (WA6) 1.6 EcoBoost 11.2010/06.2015 118KW 160CV 1596CC JTWB JTWA 8566AWW - FORD GALAXY II (WA6) 1.6 TDCi 02.2011/06.2015 85KW 115CV 1560CC T1WB T1WA 8566AXF - FORD GALAXY II (WA6) 1.8 TDCi 05.2006/06.2015 74KW 100CV 1753CC FFWA 8566AEV - FORD GALAXY II (WA6) 1.8 TDCi 05.2006/06.2015 92KW 125CV 1753CC QYWA 8566AEU - FORD GALAXY II (WA6) 2.0 05.2006/06.2015 107KW 145CV 1999CC AOWB AOWA...</p> <p>330x36x36mm 2p-d10x25mm</p>
	<p><b>E0603-M</b> NO. 1089033 - XM216A026BA - 1025168 - 1045518 - 1065852 - 1073017 - 95VW6A026RC - 95VW6A026RD - XM216A02...</p> <p><b>ESTICADOR SUPORTE APOIO MOTOR TRAS</b></p> <p>FORD GALAXY I (WGR) 1.9 TDI 03.1995/05.2006 66KW 90CV 1896CC 1Z AHU ANU 0928908 - FORD GALAXY I (WGR) 1.9 TDI 08.1997/04.2000 81KW 110CV 1896CC AVG AFN 0928287 - FORD GALAXY I (WGR) 1.9 TDI 04.2000/05.2006 85KW 115CV 1896CC AUY 8566397 - FORD GALAXY I (WGR) 1.9 TDI 02.2003/05.2006 96KW 130CV 1896CC ASZ 8566528 - FORD GALAXY I (WGR) 1.9 TDI 05.2005/05.2006 110KW 150CV 1896CC BTB 8566597 - FORD GALA...</p> <p>278x74x85mm 1f-d12mm</p>	<p><b>E1086</b> NO. 1H0253147B - 1H0253147C - 6K0253147 - 6X0253147 - 7196820</p> <p><b>ESTICADOR DO ESCAPE PARTE CENTRAL</b></p> <p>FORD GALAXY I (WGR) 1.9 TDI 08.1997/04.2000 81KW 110CV 1896CC AVG AFN 0928287 - FORD GALAXY I (WGR) 1.9 TDI 04.2000/05.2006 85KW 115CV 1896CC AUY 8566397 - FORD GALAXY I (WGR) 1.9 TDI 02.2003/05.2006 96KW 130CV 1896CC ASZ 8566528 - FORD GALAXY I (WGR) 1.9 TDI 05.2005/05.2006 110KW 150CV 1896CC BTB 8566597 - FORD GALAXY I (WGR) 2.0 i 11.1995/05.2006 85KW 116CV 1998CC ZVSA NSE 0928909 - FORD GALAXY ...</p> <p>69x49x34mm</p>
	<p><b>F1669-I</b> NO. 7398680</p> <p><b>FOLE DA DIREÇÃO ASSISTIDA LADO DIREITO E ESQUERDO</b></p> <p>FORD GALAXY TT (APÓS 03-1995)</p> <p>d77x180mm 1f-d50mm 1f-d10mm</p>	<p><b>F1825-I</b> NO. 1008225 - 1008228</p> <p><b>FOLE DA TRANSMISSÃO JUNTO À CAIXA</b></p> <p>FORD GALAXY I (WGR) 1.9 TDI 04.2000/05.2006 85KW 115CV 1896CC AUY 8566397</p> <p>d95x120mm 1f-d84mm 1f-d25mm</p>
	<p><b>F9001H-I</b> NO. 1075638</p> <p><b>FOLE DA TRANSMISSÃO JUNTO À RODA</b></p> <p>FORD GALAXY (WGR) 2.0 i (De 11-1995 Até 05-2006) 85KW 116CV 1998cc Veículo multiuso FORD GALAXY (WGR) 2.3 16V (De 01-1997 Até 05-2006) 107KW 146CV 2295cc Veículo multiuso FORD GALAXY (WGR) 2.8 i V6 (De 11-1995 Até 04-2000) 128KW 174CV 2792cc Veículo multiuso FORD GALAXY (WGR) 2.8 i V6 4x4 (De 04-1996 Até 04-2000) 128KW 174CV 2792cc Veículo multiuso FORD GALAXY (WGR) 1.9 TDI (De 03-1995 Até 05-...</p> <p>d112x150mm 1f-d96mm 1f-d30mm</p>	<p><b>F9039H-I</b> NO. 1446300</p> <p><b>FOLE DO CARDAN LADO DA RODA</b></p> <p>FORD GALAXY 1.8 TDCi (FFWA) 0100CV (APÓS 05-2006) - 1.8 TDCi (QYWA) 125CV (APÓS 05-2006) - 2.0 (AOWA - AOWB) 145CV (APÓS 05-2006) - 2.0 EcoBoost (TNWA) 203CV (APÓS 03-2010) - 2.0 Flexifuel (TBWA - TBWB) 145CV (APÓS 05-2006) - 2.0 TDCi (AZWA) 130CV (APÓS 05-2</p> <p>d96x130mm 1f-d29mm 1f-d94mm</p>
	<p><b>KF1473-T</b> NO.</p> <p><b>KIT DE FOLE DO CARDAN JUNTO À RODA</b></p> <p>FORD GALAXY 1.9 TDI - 2.0i - 2.3i 16V - 2.8i VR6 - 2.8i VR6 4X4 (APÓS 1995)</p> <p>d110x150mm 1f-d98mm 1f-d29mm</p>	<p><b>KF2539-T</b> NO. 1075638 - 95VW7L606AB</p> <p><b>KIT DE FOLE DO CARDAN JUNTO À RODA</b></p> <p>FORD GALAXY 1.9 TDi - 1.9 TDi PD - 2.0i - 2.3i 16V - 2.8i VR6 (APÓS 1995)</p> <p>d110x150mm 1f-d98mm 1f-d30mm</p>
	<p><b>KF8020-T</b> NO.</p> <p><b>KIT DE FOLE DO CARDAN JUNTO À RODA</b></p> <p>FORD GALAXY 1.9 TDI - 2.0i - 2.3i 16V - 2.8i VR6 - 2.8i VR6 4X4 (APÓS 1995)</p> <p>d110x150mm 1f-d98mm 1f-d29mm</p>	<p><b>KL2763</b> NO. 028103638G - 028103665 - 028103937</p> <p><b>KIT CASQUILHOS REPARAÇÃO TAMPA MOTOR</b></p> <p>FORD GALAXY (WGR): 2.0 i 11.1995/05.2006 85KW 116CV 1998CC - FORD GALAXY (WGR): 2.3 16V 09.2001/05.2006 103KW 140CV 2295CV - FORD GALAXY (WGR): 2.3 16V 01.1997/05.2006 107KW 146CV 2295CC - FORD GALAXY (WGR): 2.8 i V6 11.1995/04.2000 128KW 174CV 2792CC - FORD GALAXY (WGR): 2.8 i V6 4x4 04.1996/04.2000 128KW 174CV 2792CC - FORD GALAXY (WGR): 2.8 V6 04.2000/05.2006 150KW 204CV 2792CC - FORD GALAXY (W...</p> <p>d28x19mm 1f-d9mm</p>

	<p><b>KUBT3021</b> NO. 1K0698470</p> <p><b>KIT BORRACHAS PINÇA TRAVÃO TRÁS LUCAS (PERNOS DE GUIA)</b></p> <p>FORD GALAXY I (WGR) 2.8 V6 04.2000/05.2006 150KW 204CV 2792CC AYL 8566398 - FORD GALAXY MK I VAN (WGR) 1.9 TDI 09.1996/03.2006 66KW 90CV 1896CC AHU ANU - FORD GALAXY MK I VAN (WGR) 1.9 TDI 05.2000/03.2006 85KW 116CV 1896CC AUY - FORD GALAXY MK I VAN (WGR) 2.0 03.1996/03.2006 85KW 116CV 1998CC ZVSA NSE - FORD GALAXY MK I VAN (WGR) 2.3 05.2000/10.2002 107KW 145CV 2295CC E5SA - FORD GALAXY MK I VAN (...)</p> <p>d20x31mm(x2) 2p-d8x57mm(d22x63x22mm)(x2)</p>		<p><b>KUBT3027</b> NO. 1223615 - 1223616 - 1583139 - 1583140 - 3M5Z-2221-BB - 6G91-2B294-AC - CV6Z-2B121-AA</p> <p><b>KIT BORRACHAS TRAVAO PINÇA FRENTE ATE/TEVES 57MM</b></p> <p>FORD GALAXY II (WA6) 1.6 EcoBoost 11.2010/06.2015 118KW 160CV 1596CC JTWB JTWA 8566AWW - FORD GALAXY II (WA6) 1.6 TDCi 02.2011/06.2015 85KW 115CV 1560CC T1WB T1WA 8566AXF - FORD GALAXY II (WA6) 2.0 05.2006/06.2015 107KW 145CV 1999CF AOWB AOWA TBWB TBWA 8566AER - FORD GALAXY II (WA6) 2.0 EcoBoost 03.2010/06.2015 149KW 203CV 1999CC TNWA 8566ATI - FORD GALAXY II (WA6) 2.0 Flexifuel 05.2006/06.2015 10...</p> <p>d70x13mm d66x3mm d14x6mm d18mm 1f59mm 1f-d5mm</p>
	<p><b>M6109</b> NO. 1005891</p> <p><b>JUNTA DE ESCAPE</b></p> <p>FORD GALAXY (APÓS 08-97)</p> <p>82x41mm 1f-38/27mm</p>		<p><b>P1017</b> NO. 7213141</p> <p><b>CAPA DE PEDAL TRAVAO/EMBRAIAGEM ( GASTA 2 UNIDADES )</b></p> <p>FORD GALAXY (WGR): 2.0 i 11.1995/05.2006 85KW 116CV 1998CC - FORD GALAXY (WGR): 2.3 16V 09.2001/05.2006 103KW 140CV 2295CC - FORD GALAXY (WGR): 2.3 16V 01.1997/05.2006 107KW 146CV 2295CC - FORD GALAXY (WGR): 2.8 i V6 11.1995/04.2000 128KW 174CV 2792CC - FORD GALAXY (WGR): 1.9 TDI 03.1995/05.2006 66KW 90CV 1896CC - FORD GALAXY (WGR): 1.9 TDI 08.1997/04.2000 81KW 110CV 1896CC - FORD GALAXY (WGR): 1....</p> <p>67x55x10mm</p>
	<p><b>Q2013</b> NO. 1048510 - 1475481 - 1754892 - 6171239</p> <p><b>UNIÃO DO ESCAPE 60x64,5x90mm</b></p> <p>FORD GALAXY</p> <p>90x70x92mm 1f-d60mm</p>		<p><b>R220764</b> NO. 028121053B - 028121053L - 028121053P - 028121053Q - 028121053S</p> <p><b>TUBO LIGAÇÃO TERMOSTATO BOMBA DE ÁGUA</b></p> <p>FORD GALAXY (WGR) 1.9 TDI 03-1995/05-2006 66KW 90CV 1896CC - FORD GALAXY (WGR) 1.9 TDI 08-1997/04-2000 81KW 110CV 1896CC</p> <p>B290-24/24mm 80-100-60-60mm ch-d15-80-40mm</p>
	<p><b>R221912</b> NO. 1H0145834 - 1H0145834E - 1H0145834J - 1H0145837</p> <p><b>TUBO DE LIGAÇÃO DO AR AO TURBO</b></p> <p>FORD GALAXY I (WGR) 1.9 TDI 03.1995/05.2006 66KW 90CV 1896CC 1Z AHU ANU 0928908 - FORD GALAXY I (WGR) 1.9 TDI 08.1997/04.2000 81KW 110CV 1896CC AVG AFN 0928287</p> <p>B55-50/50mm 55mm</p>		<p><b>R222004</b> NO. 7M3145828</p> <p><b>TUBO ADMISSÃO FILTRO DE AR</b></p> <p>FORD GALAXY (WGR) 1.9 TDI (De 04-2000 Até 05-2006) 85KW 115CV 1896cc Veículo multiuso</p> <p>B380-43/45mm 180-210mm</p>
	<p><b>R222452</b> NO. 1353884 - 1359243 - 1386843 - 1520173 - 3M5H9Y438AA - 3M5H9Y438AB - 3M5H9Y438AC - 3M5H9Y438AD</p> <p><b>TUBO DO RADIADOR LADO DA ADMISSÃO</b></p> <p>FORD GALAXY II (WA6) 1.8 TDCi (05.2006 - 06.2015) 74kw 100cv 1753cm3 Veículo multiuso FORD GALAXY II (WA6) 1.8 TDCi (05.2006 - 06.2015) 92kw 125cv 1753cm3 Veículo multiuso</p> <p>B350-15/18mm 41-17-52-180-77-48mm</p>		<p><b>R223678</b> NO. 1008540 - VX028103491VXJ</p> <p><b>TUBO DO RESPIRO DA TAMPA CABEÇA DO MOTOR</b></p> <p>FORD GALAXY I (WGR) 1.9 TDI (De 03.1995 Até 05.2006) 66kW 90cv 1896cm3 Veículo multiuso - FORD GALAXY I (WGR) 1.9 TDI (De 08.1997 Até 04.2000) 81KW 110cv 1896cm3 Veículo multiuso - FORD GALAXY I (WGR) 1.9 TDI (De 04.2000 Até 05.2006) 85kW 115cv 1896cm3 Veículo multiuso -</p> <p>B345-22/32mm 86-128-115-46mm</p>
	<p><b>R225074</b> NO. 1697700 - AV616C700AD</p> <p><b>TUBO DO AR SOBREALIMENTAÇÃO</b></p> <p>FORD GALAXY II (WA6) 2.0 TDCi (De 11.2007 Até 06.2015) 85kW 115cv 1997cm3 Veículo multiuso - FORD GALAXY II (WA6) 2.0 TDCi (De 03.2010 Até 06.2015) 120kW 163cv 1997cm3 Veículo multiuso -</p> <p>B73-42/47mm 73mm</p>		<p><b>R225079</b> NO. 1697700 - AV616C700AD</p> <p><b>TUBO DO AR SOBREALIMENTAÇÃO</b></p> <p>FORD GALAXY II (WA6) 2.0 TDCi (De 11.2007 Até 06.2015) 85kW 115cv 1997cm3 Veículo multiuso - FORD GALAXY II (WA6) 2.0 TDCi (De 03.2010 Até 06.2015) 120kW 163cv 1997cm3 Veículo multiuso -</p> <p>B136-48/49mm 73x58mm</p>
	<p><b>R225462</b> NO. 1303478 - 3M5Q6A646AA</p> <p><b>TUBO DO RADIADOR DO ÓLEO COM JUNTAS</b></p> <p>FORD GALAXY II (WA6) 2.0 TDCi 05.2006/06.2015 100KW 136CV 1997CC UKWA AZWC 8566APW - FORD GALAXY II (WA6) 2.0 TDCi 05.2006/06.2015 103KW 140CV 1997CC UFWA QXWC QXWB QXWA 8566AES - FORD GALAXY II (WA6) 2.0 TDCi 11.2007/06.2015 85KW 115CV 1997CC KLWA TYWA 8566AML - FORD GALAXY II (WA6) 2.0 TDCi 03.2010/06.2015 120KW 163CV 1997CC TXWA 8566ATH</p> <p>d81x4mm d27x3mm d72x4mm d22x97mm 1f-d19mm 1f-d14mm</p>		<p><b>R8200</b> NO. 1251783 - 1366216 - 1430644 - 4M5G-6758-FA - 4M5G-6758-HA - 6G9G-6758-AA</p> <p><b>TUBO DO RESPIRO DO CARTER DA CABBOTA</b></p> <p>FORD GALAXY II (WA6) 2.0 05.2006/06.2015 107KW 145CV 1999CC AOWB AOWA TBWB TBWA 8566AER - FORD GALAXY II (WA6) 2.0 EcoBoost 03.2010/06.2015 149KW 203CV 1999CC TNWA 8566ATI - FORD GALAXY II (WA6) 2.0 Flexifuel 05.2006/06.2015 107KW 145CV 1999CC TBWA TBWB 8566AQY</p> <p>B117-14/14mm 37-62-38mm</p>
	<p><b>RT08924</b> NO. 7335771</p> <p><b>TUBO DE TRAVÃO FRENTE LH-RH</b></p> <p>FORD GALAXY TT (APÓS 11-1995)</p> <p>500mm FB54 - MCL</p>		<p><b>RT80244</b> NO. 7335770 - 7M0611775C - 7M0611775E - 95VW2282AD</p> <p><b>TUBO DE TRAVÃO TRÁS LH-RH</b></p> <p>FORD GALAXY TT (APÓS 11-1995)</p> <p>400mm F - FB54</p>

	<p><b>RT80258</b> NO. 1121359 - 1304007</p> <p>TUBO DE TRAVÃO FRENTE LH-RH</p> <p>FORD GALAXY TT (APÓS 04-2000)</p> <p>480mm F5 - FB24</p>		<p><b>S1367</b> NO. 7201717 - 95VW5A638CA</p> <p>SILENT-BLOC DO BRAÇO DA SUSPENSÃO DA FRENTE</p> <p>FORD GALAXY 1.9 TDI - 2.0 - 2.3 - 2.8</p> <p>d60x50mm c28mm 1f-d18mm</p>
	<p><b>S2157</b> NO. 2051600 - E1GC-5K067-AD</p> <p>SILENT-BLOC DO EIXO DA SUSPENSÃO TRÁS PARTE DA FRENTE</p> <p>FORD GALAXY III (CK) 1.5 EcoBoost (01.2015 - 06.2018) 118kw 160cv 1499cm3 Veículo multiuso FORD GALAXY III (CK) 2.0 EcoBoost (01.2015 -) 176kw 240cv 1999cm3 Veículo multiuso FORD GALAXY III (CK) 2.0 TDCi (01.2015 - 06.2018) 88kw 120cv 1997cm3 Veículo multiuso FORD GALAXY III (CK) 2.0 TDCi (01.2015 - 06.2018) 110kw 150cv 1997cm3 Veículo multiuso FORD GALAXY III (CK) 2.0 TDCi (01.2015 - 06.2018) 132...</p> <p>d68x74mm c-48mm-dc-60mm-1f-d26mm</p>		<p><b>S2158</b> NO. 2051600 - E1GC-5K067-AD</p> <p>SILENT-BLOC DO EIXO DA SUSPENSÃO TRÁS PARTE DE TRÁS</p> <p>FORD GALAXY III (CK) 1.5 EcoBoost (01.2015 - 06.2018) 118kw 160cv 1499cm3 Veículo multiuso FORD GALAXY III (CK) 2.0 EcoBoost (01.2015 -) 176kw 240cv 1999cm3 Veículo multiuso FORD GALAXY III (CK) 2.0 TDCi (01.2015 - 06.2018) 88kw 120cv 1997cm3 Veículo multiuso FORD GALAXY III (CK) 2.0 TDCi (01.2015 - 06.2018) 110kw 150cv 1997cm3 Veículo multiuso FORD GALAXY III (CK) 2.0 TDCi (01.2015 - 06.2018) 132...</p> <p>d70x78mm c-48mm-dc-60mm-1f-d26mm</p>
	<p><b>T1096</b> NO. 1009649</p> <p>BATENTE DA BARRA ESTABILIZADORA DE TRÁS LADO LATERAL</p> <p>FORD GALAXY (1995 A 2000) 1.9 TDi - 2.0 - 2.3 - 2.8</p> <p>d35x30mm 1f-d21mm</p>		<p><b>T1264</b> NO. 1405532 - 1453257 - 1469020 - 1478582 - 6G9N5484GA - 6G9N5484GB - 6G9N5484UA - 6G9N5484UB</p> <p>BATENTE DA BARRA ESTABILIZADORA DA FRENTE</p> <p>FORD GALAXY II (WA6) 1.6 EcoBoost 11.2010/06.2015 118KW 160CV 1596CC JTWB JTWA 8566AWW - FORD GALAXY II (WA6) 1.6 TDCi 02.2011/06.2015 85KW 115CV 1560CC T1WB T1WA 8566AXF - FORD GALAXY II (WA6) 1.8 TDCi 05.2006/06.2015 74KW 100CV 1753CC FFWA 8566AEV - FORD GALAXY II (WA6) 1.8 TDCi 05.2006/06.2015 92KW 125CV 1753CC QYWA 8566AEU - FORD GALAXY II (WA6) 2.0 05.2006/06.2015 107KW 145CV 1999CC AOWB AOWA...</p> <p>52x46x47mm 1f-d22mm</p>
	<p><b>U7033K</b> NO. 1212679 - 1212679 - 1332662 - 1474287 - 1S7C-3334-AA - 3M51-3334-AA</p> <p>ORINGS BOMBA DIREÇÃO ASSITIDA</p> <p>FORD GALAXY II (WA6) 1.6 EcoBoost (11.2010 -06.2015) 118kw 160cv 1596cm3 Veículo multiuso FORD GALAXY II (WA6) 1.6 TDCi (02.2011 -06.2015) 85kw 115cv 1560cm3 Veículo multiuso FORD GALAXY II (WA6) 1.8 TDCi (05.2006 -06.2015) 74kw 100cv 1753cm3 Veículo multiuso FORD GALAXY II (WA6) 1.8 TDCi (05.2006 -06.2015) 92kw 125cv 1753cm3 Veículo multiuso FORD GALAXY II (WA6) 2.0 (05.2006 -06.2015) 107kw 145c...</p> <p>d11x2mm d10x2mm 1f-d7mm 1f-d6mm</p>		<p><b>UAP81292</b> NO. 1748294 - BG9Q9E568AA</p> <p>ANILHA PROTEÇÃO TÉRMICA INJECTORES</p> <p>FORD GALAXY (WM) 2.2 TDCi (De 03-2008 Até 12-2012) 129kW 175CV 2179cc Veículo multiuso FORD GALAXY (WM) 2.2 TDCi (De 11-2010 Até 06-2015) 147kW 200CV 2179cc Veículo multiuso</p> <p>d16x1mm 1f-d7mm</p>
	<p><b>UAP81292</b> NO. 1748294 - BG9Q9E568AA</p> <p>ANILHA PROTEÇÃO TÉRMICA INJECTORES</p> <p>FORD GALAXY (WM) 2.2 TDCi (De 03-2008 Até 12-2012) 129kW 175CV 2179cc Veículo multiuso FORD GALAXY (WM) 2.2 TDCi (De 11-2010 Até 06-2015) 147kW 200CV 2179cc Veículo multiuso</p> <p>d16x1mm 1f-d7mm</p>		<p><b>UAP81312</b> NO. 1715204 - 9M5Q9E568BA</p> <p>ANILHA DE PROTEÇÃO TÉRMICA INJECTORES</p> <p>FORD GALAXY II (WA6) 2.0 TDCi (De 11.2007 Até 06.2015) 85kW 115cv 1997cm3 Veículo multiuso - FORD GALAXY II (WA6) 2.0 TDCi (De 05.2006 Até 06.2015) 100kW 136cv 1997cm3 Veículo multiuso - FORD GALAXY II (WA6) 2.0 TDCi (De 05.2006 Até 06.2015) 103kW 140cv 1997cm3 Veículo multiuso - FORD GALAXY II (WA6) 2.0 TDCi (De 03.2010 Até 06.2015) 120kW 163cv 1997cm3 Veículo multiuso -</p> <p>d14x1.5mm 1f-d7mm</p>
	<p><b>UAP81313</b> NO. 1364301 - 4M5Q9M577AA</p> <p>ANILHA PROTEÇÃO TÉRMICA INJECTORES</p> <p>FORD GALAXY II (WA6) 1.8 TDCi 05.2006/06.2015 74KW 100CV 1753CC FFWA 8566AEV - FORD GALAXY II (WA6) 1.8 TDCi 05.2006/06.2015 92KW 125CV 1753CC QYWA 8566AEU</p> <p>d13x2mm 1f-d7mm</p>		<p><b>UAP83252</b> NO. 1700379 - AV6Q9E568AA</p> <p>ANILHA PROTEÇÃO TÉRMICA INJECTORES</p> <p>FORD GALAXY II (WA6) 1.6 TDCi (02.2011 -06.2015) 85kw 115cv 1560cm3 Veículo multiuso</p> <p>d15x2mm 1f-d6mm</p>
	<p><b>UCRZ1103</b> NO. 1504137 - 1504139 - 1505652 - 1505654 - 1600370 - 1600374 - 1727233 - 1727237 - 1757879 - 1774665 - ...</p> <p>CRUZETA TRANSMISSÃO TRIPOIDE D45MM/26 DENTES</p> <p>FORD GALAXY II (WA6) 2.0 05.2006/06.2015 107KW 145CV 1999CC AOWB AOWA TBWB TBWA 8566AER - FORD GALAXY II (WA6) 2.0 EcoBoost 03.2010/06.2015 149KW 203CV 1999CC TNWA 8566ATI - FORD GALAXY II (WA6) 2.0 Flexifuel 05.2006/06.2015 107KW 145CV 1999CC TBWA TBWB 8566AQY - FORD GALAXY II (WA6) 2.0 TDCi 05.2006/06.2015 96KW 130CV 1997CC AZWA 8566AET - FORD GALAXY II (WA6) 2.0 TDCi 05.2006/06.2015 100KW 136CV...</p> <p>45mm 26 DENTES</p>		<p><b>UCRZ1103</b> NO. 1504137 - 1504139 - 1505652 - 1505654 - 1600370 - 1600374 - 1727233 - 1727237 - 1757879 - 1774665 - ...</p> <p>CRUZETA TRANSMISSÃO TRIPOIDE D45MM/26 DENTES</p> <p>FORD GALAXY MK II VAN (WA6) TDCi 05.2006/06.2015 103KW 140CV 1997CC QXWA QXWB QXWC UFWA - FORD GALAXY MK II VAN (WA6) TDCi 11.2006/06.2015 96KW 131CV 1997CC AZWA</p> <p>45mm 26 DENTES</p>
	<p><b>UMB84016</b> NO. N01191410 - N0119142 - N0119143 - N0119148</p> <p>TAMPÃO BLOCO MOTOR</p> <p>FORD GALAXY (WGR) 2.8 i V6 (De 11-1995 Até 04-2000) 128kW 174CV 2792cc Veículo multiuso FORD GALAXY (WGR) 2.8 i V6 4x4 (De 04-1996 Até 04-2000) 128kW 174CV 2792cc Veículo multiuso FORD GALAXY (WGR) 2.8 V6 (De 04-2000 Até 05-2006) 150kW 204CV 2792cc Veículo multiuso FORD GALAXY (WGR) 1.9 TDI (De 03-1995 Até 05-2006) 66kW 90CV 1896cc Veículo multiuso FORD GALAXY (WGR) 1.9 TDI (De 08-1997 Até 04-2000)...</p> <p>d-24x10,8mm di-21,6mm</p>		<p><b>UMB84016L</b> NO. 1005246 - N011914VX2</p> <p>TAMPÃO BLOCO DE MOTOR (RELAS)</p> <p>FORD GALAXY (WGR) 2.8 i V6 (De 11-1995 Até 04-2000) 128kW 174CV 2792cc Veículo multiuso FORD GALAXY (WGR) 2.8 i V6 4x4 (De 04-1996 Até 04-2000) 128kW 174CV 2792cc Veículo multiuso FORD GALAXY (WGR) 2.8 V6 (De 04-2000 Até 05-2006) 150kW 204CV 2792cc Veículo multiuso FORD GALAXY (WGR) 1.9 TDI (De 03-1995 Até 05-2006) 66kW 90CV 1896cc Veículo multiuso FORD GALAXY (WGR) 1.9 TDI (De 08-1997 Até 04-2000)...</p> <p>d-24x10,8mm di-21,6mm</p>









	<p><b>UMB84030</b> NO. 7402402 - 7402403 - VX059103113VX</p> <p>TAMPÃO BLOCO MOTOR</p> <p>FORD GALAXY (WGR) 2.8 i V6 (De 11-1995 Até 04-2000) 128kW 174CV 2792cc Veículo multiuso FORD GALAXY (WGR) 2.8 i V6 4x4 (De 04-1996 Até 04-2000) 128kW 174CV 2792cc Veículo multiuso FORD GALAXY (WGR) 2.8 V6 (De 04-2000 Até 05-2006) 150kW 204CV 2792cc Veículo multiuso FORD GALAXY (WGR) 1.9 TDI (De 03-1995 Até 05-2006) 66kW 90CV 1896cc Veículo multiuso FORD GALAXY (WGR) 1.9 TDI (De 08-1997 Até 04-...)</p> <p>d-36,6x9mm di-33,5mm</p>		<p><b>UMB84040</b> NO. 05073860AA</p> <p>TAMPÃO BLOCO MOTOR</p> <p>FORD GALAXY (WA6) 1.6 TDCi (De 02-2011 Até 06-2015) 85kW 115CV 1560cc Veículo multiuso</p> <p>d-47x9,1mm di-44,2mm</p>
	<p><b>UMB84057</b> NO. 05073837AA - 5073837AA</p> <p>TAMPÃO BLOCO MOTOR</p> <p>FORD GALAXY (WA6) 1.6 TDCi (De 02-2011 Até 06-2015) 85kW 115CV 1560cc Veículo multiuso</p> <p>d-46x13mm d-38x1,5mm</p>		<p><b>UMV25325</b> NO. 1580939 - AM8A6J-7J132-ABT</p> <p>MANETE PUNHO TOPO ALAVANCA MUDANÇAS 5 VELOCIDADES F14MM</p> <p>FORD GALAXY II (WA6) 1.6 EcoBoost (De 11.2010 Até 06.2015) 118kW 160cv 1596cm3 Veículo multiuso - FORD GALAXY II (WA6) 1.6 TDCi (De 02.2011 Até 06.2015) 85kW 115cv 1560cm3 Veículo multiuso - FORD GALAXY II (WA6) 1.8 TDCi (De 05.2006 Até 06.2015) 74kW 100cv 1753cm3 Veículo multiuso - FORD GALAXY II (WA6) 1.8 TDCi (De 05.2006 Até 06.2015) 92kW 125cv 1753cm3 Veículo multiuso - FORD GALAXY II (WA6) 2....</p> <p>d46x90mm 1f-d14mm</p>
	<p><b>UMV26813</b> NO. 1798600 - 7G9R7217CKD</p> <p>MANETE PUNHO TOPO ALAVANCA MUDANÇAS 6 VELOCIDADES F11/30MM</p> <p>FORD GALAXY II (WA6): 1.6 EcoBoost 11.2010/06.2015 118KW 160CV 1596CC - FORD GALAXY II (WA6): 2.0 05.2006/06.2015 107KW 145CV 1999CC - FORD GALAXY II (WA6): 2.0 Flexifuel 05.2006/06.2015 107KW 145CV 1999CC - FORD GALAXY II (WA6): 2.0 EcoBoost 03.2010/06.2015 149KW 203CV 1999CC - FORD GALAXY II (WA6): 2.3 09.2007/06.2015 118KW 160CV 2261CC - FORD GALAXY II (WA6): 1.6 TDCi 02.2011/06.2015 85KW 115CV...</p> <p>53x47x54mm 1f-d11/30mm</p>		<p><b>UPCR5020</b> NO. 1377747 - 1382841 - 1428137 - 1676176 - 5196786 - 5275544</p> <p>PORCA DA RODA CHAVE 21 M14X1,5X34MM ( BASE CONICA )</p> <p>FORD GALAXY II (WA6) 1.6 EcoBoost (11.2010 -06.2015) 118kw 160cv 1596cm3 Veículo multiuso FORD GALAXY II (WA6) 1.6 TDCi (02.2011 -06.2015) 85kw 115cv 1560cm3 Veículo multiuso FORD GALAXY II (WA6) 1.8 TDCi (05.2006 -06.2015) 74kw 100cv 1753cm3 Veículo multiuso FORD GALAXY II (WA6) 1.8 TDCi (05.2006 -06.2015) 92kw 125cv 1753cm3 Veículo multiuso FORD GALAXY II (WA6) 2.0 (05.2006 -06.2015) 107kw 145cv...</p> <p>d28x34mm M14x32mm</p>
	<p><b>UPCR5020</b> NO. 1377747 - 1382841 - 1428137 - 1676176 - 5196786 - 5275544</p> <p>PORCA DA RODA CHAVE 21 M14X1,5X34MM ( BASE CONICA )</p> <p>FORD GALAXY MK II VAN (WA6) TDCi (11.2006 -06.2015) 96kw 131cv 1997cm3 Caixa/monovolume FORD GALAXY MK II VAN (WA6) TDCi (05.2006 -06.2015) 103kw 140cv 1997cm3 Caixa/monovolume FORD GALAXY MK II VAN (WA6) TDCi (03.2013 -06.2015) 147kw 200cv 2179cm3 Caixa/monovolume</p> <p>d28x34mm M14x32mm</p>		<p><b>UTR0847</b> NO. 1224233 - 1301104 - 3M5H8100AC</p> <p>TAMPÃO RESERVATÓRIO LIQUIDO REFRIGERAÇÃO</p> <p>FORD GALAXY (WA6) 1.6 EcoBoost (11.10 A 06.15) 160cv 1596cc Veículo multiuso - FORD GALAXY (WA6) 2.0 (05.06 A 06.15) 145cv 1999cc Veículo multiuso - FORD GALAXY (WA6) 2.0 EcoBoost (03.10 A 06.15) 203cv 1999cc Veículo multiuso - FORD GALAXY (WA6) 2.3 (09.07 A 06.15) 160cv 2261cc Veículo multiuso - FORD GALAXY (WA6) 1.6 TDCi (02.11 A 06.15) 115cv 1560cc Veículo multiuso - FORD GALAXY (WA6)...</p> <p>d62x35mm 1f-d50x16mm</p>
	<p><b>UTR0850</b> NO. 1039234 - 1092327 - 1110205 - 7198459 - 95VW8100AA - 95VW8100AC - YM218100BAGYAA - YM218100BAW</p> <p>TAMPÃO RESERVATÓRIO LIQUIDO REFRIGERAÇÃO</p> <p>FORD GALAXY (WGR) 2.0 i (11.95 A 05.06) 116cv 1998cc Veículo multiuso - FORD GALAXY (WGR) 2.3 16V (09.01 A 05.06) 140cv 2295cc Veículo multiuso - FORD GALAXY (WGR) 2.3 16V (01.97 A 05.06) 146cv 2295cc Veículo multiuso - FORD GALAXY (WGR) 2.8 i V6 (11.95 A 04.00) 174cv 2792cc Veículo multiuso - FORD GALAXY (WGR) 2.8 i V6 4x4 (04.96 A 04.00) 174cv 2792cc Veículo multiuso - FORD GALAXY (WGR)...</p> <p>d80x48mm 1f-d48x26mm</p>		<p><b>UTR0850</b> NO. 7M0121321 - 7M0121321C - 7M3121321 - 7M5121321</p> <p>TAMPÃO RESERVATÓRIO LIQUIDO REFRIGERAÇÃO</p> <p>FORD GALAXY (WGR) 2.0 i (De 11-1995 Até 05-2006) 85kW 116CV 1998cc Veículo multiuso FORD GALAXY (WGR) 2.3 16V (De 09-2001 Até 05-2006) 103kW 140CV 2295cc Veículo multiuso FORD GALAXY (WGR) 2.3 16V (De 01-1997 Até 05-2006) 107kW 146CV 2295cc Veículo multiuso FORD GALAXY (WGR) 2.8 i V6 (De 11-1995 Até 04-2000) 128kW 174CV 2792cc Veículo multiuso FORD GALAXY (WGR) 2.8 i V6 4x4 (De 04-1996 Até 04-...)</p> <p>d80x48mm 1f-d48x26mm</p>
	<p><b>UTR0852</b> NO. 7M0121321 - 7M0121321C - 7M3121321 - 7M5121321</p> <p>TAMPÃO RESERVATÓRIO LIQUIDO REFRIGERAÇÃO</p> <p>FORD GALAXY (WGR) 2.0 i (De 11-1995 Até 05-2006) 85kW 116CV 1998cc Veículo multiuso FORD GALAXY (WGR) 2.3 16V (De 09-2001 Até 05-2006) 103kW 140CV 2295cc Veículo multiuso FORD GALAXY (WGR) 2.3 16V (De 01-1997 Até 05-2006) 107kW 146CV 2295cc Veículo multiuso FORD GALAXY (WGR) 2.8 i V6 (De 11-1995 Até 04-2000) 128kW 174CV 2792cc Veículo multiuso FORD GALAXY (WGR) 2.8 i V6 4x4 (De 04-1996 Até 04-...)</p> <p>d80x50mm 1f-d46x26mm</p>		<p><b>UTV83002</b> NO. 2S6Q6730AA</p> <p>TAMPÃO VEDAÇÃO BUJÃO</p> <p>FORD GALAXY (WM) 1.6 TDCi (De 02-2011 Até 06-2015) 85kW 115CV 1560cc Veículo multiuso</p> <p>20x18mm c13mm d10mm</p>
	<p><b>UTV83010</b> NO. 1013938 - 97JM6730BA</p> <p>TAMPÃO VEDAÇÃO BUJÃO</p> <p>FORD GALAXY (WM) 2.0 (De 05-2006 Até 06-2015) 107kW 145CV 1999cc Veículo multiuso FORD GALAXY (WM) 2.0 EcoBoost (De 03-2010 Até 06-2015) 149kW 203CV 1999cc Veículo multiuso</p> <p>d28x35mm c19mm d13mm</p>		<p><b>UTV83012</b> NO. 1457117 - 1657022 - 1663906 - 6093527 - 6186775 - 6732529 - 70TM6730AA - 89FF6730AA</p> <p>TAMPÃO VEDAÇÃO BUJÃO</p> <p>FORD GALAXY (WGR) 2.0 i (De 11-1995 Até 05-2006) 85kW 116CV 1998cc Veículo multiuso</p> <p>d23x26mm c15mm d13mm</p>
	<p><b>W5008</b> NO. 1069593 - 1100674 - 1669807 - 7198528 - 95VW6B321CA - 95VW6B321CB - XM216316AA</p> <p>POLIE DA CAMBOTA (6 pistas)</p> <p>FORD GALAXY 1.9 TDi MTr 1Z - AFN - AHU - AHV - ANU - AVG (APÓS 03-1995)</p> <p>d155.5mm d30mm</p>		<p><b>W5016</b> NO. 1231959 - 1490842 - 1520590 - 1683820 - 1837783 - 3MSQ-6B319-AA - 7MSQ-6B319-AA - 7MSQ-6B319-AB - 8M...</p> <p>POLIE DA CAMBOTA (6 PISTAS)</p> <p>FORD GALAXY II (WA6) 2.0 TDCi 05.2006/06.2015 96K2 130CV 1997CC AZWA 8566AET - FORD GALAXY II (WA6) 2.0 TDCi 05.2006/06.2015 103KW 140CV 1997CC UFWA QXWC QXWB QXWA 8566AES</p> <p>d152.5mm d16mm</p>

# FORD GALAXY

*Rafri, Lda.*

	<b>W5028</b> NO. 8627933 - 9163918 - 9180620 POLIE DA CAMBOTA (6 pistas) FORD GALAXY I (WGR): 1.9 TDI 03.1995/05.2006 66KW 90CV 1896CC		<b>W5039</b> NO. 038105243K - 038105268 POLIE DA CAMBOTA (6 PISTAS) FORD GALAXY I (WGR) 1.9 TDI 03.1995/05.2006 66KW 90CV 1896CC 1Z AHU ANU 0928908 - FORD GALAXY I (WGR) 1.9 TDI 04.2000/05.2006 85KW 115CV 1896CC AUJ 8566397 - FORD GALAXY I (WGR) 1.9 TDI 02.2003/05.2006 96KW 130CV 1896CC ASZ 8566528
d189mm	d18mm	d138mm	d30mm
	<b>W5048</b> NO. 1315782 - 3M216B320AA - 68001304AA - MN980049 POLIE DA CAMBOTA (6 PISTAS) FORD GALAXY 1.9 TDi Mtr ASZ 3M21-6B320AA (115-130-150CV) (APÓS 09-2003)		<b>W5081</b> NO. 1079166 - 1104415 - 1139286 - 1143413 - 1151392 - 1S4Q6A345AA - 1S4Q6B318AE - 1S4Q6B319AE - 1S4Q6B319AD POLIE DA CAMBOTA (6 PISTAS) FORD GALAXY II (WA6) 1.8 TDCi 05.2006/06.2015 74KW 100CV 1753CC FFWA 8566AEV - FORD GALAXY II (WA6) 1.8 TDCi 05.2006/06.2015 92KW 125CV 1753CC QYWA 8566AEU
d143mm	d30mm	d140/153mm	d14.6mm
	<b>W5180</b> NO. 1682158 - 31460551 - 5087792 - 5348415 - AG9E6B319AA - AG9E6B319AB - AG9E6B319AC - AG9E6B319AD POLIE DA CAMBOTA (6 PISTAS) FORD GALAXY II (WA6): 2.0 EcoBoost 03.2010/06.2015 149KW 203CV 1999CC		<b>Z50130</b> NO. 11589289 MOLA REBITE FIXAÇÃO FORD GALAXY II (WA6) 1.6 EcoBoost (11.2010 -06.2015) 118kw 160cv 1596cm3 Veiculo multiuso FORD GALAXY II (WA6) 1.6 TDCi (02.2011 -06.2015) 85kw 115cv 1560cm3 Veiculo multiuso FORD GALAXY II (WA6) 1.8 TDCi (05.2006 -06.2015) 74kw 100cv 1753cm3 Veiculo multiuso FORD GALAXY II (WA6) 1.8 TDCi (05.2006 -06.2015) 92kw 125cv 1753cm3 Veiculo multiuso FORD GALAXY II (WA6) 2.0 (05.2006 -06.2015) 107kw 145cv...
d162/153mm	d46mm	d6x 18mm	f-d17mm
	<b>Z50130</b> NO. 11589289 MOLA REBITE FIXAÇÃO FORD GALAXY III (CK) 1.5 EcoBoost (01.2015 -06.2018 118kw 160cv 1499cm3 Veiculo multiuso FORD GALAXY III (CK) 1.5 EcoBoost (07.2018 - 121kw 165cv 1499cm3 Veiculo multiuso FORD GALAXY III (CK) 2.0 EcoBlue (07.2018 - 88kw 120cv 1995cm3 Veiculo multiuso FORD GALAXY III (CK) 2.0 EcoBlue (07.2018 - 110kw 150cv 1995cm3 Veiculo multiuso FORD GALAXY III (CK) 2.0 EcoBlue (07.2018 - 140kw 190cv 1995cm3 Veic...		<b>Z50130</b> NO. 11589289 MOLA REBITE FIXAÇÃO FORD GALAXY MK II VAN (WA6) TDCi (11.2006 -06.2015) 96kw 131cv 1997cm3 Caixa/monovolume FORD GALAXY MK II VAN (WA6) TDCi (05.2006 -06.2015) 103kw 140cv 1997cm3 Caixa/monovolume FORD GALAXY MK II VAN (WA6) TDCi (03.2013 -06.2015) 147kw 200cv 2179cm3 Caixa/monovolume FORD GALAXY MK III VAN (CK) 2.0 EcoBlue (03.2019 - 110kw 150cv 1995cm3 Caixa/monovolume FORD GALAXY MK III VAN (CK) 2.0 EcoBlue AWD (...)
d6x 18mm	f-d17mm	d6x 18mm	f-d17mm

# FORD KA - STREET KA

	<b>A1383</b> NO. 1013794 - 1E00-34-380 - 96AB.3K155.AG - 96FB 3K155AG - 96FB3K155AG APOIO DA SUSPENSÃO DA FRENTE FORD KA		<b>A1679</b> NO. 1032120 - 97KB6038AD APOIO DO MOTOR PARTE DA FRENTE FORD KA 1.3 (APÓS 1996)
d105x49mm	1f-d23mm	185x140x58mm	
	<b>BB22</b> NO. 1003610 ABRAÇADEIRA BARRA ESTABILIZADORA ( GASTA 2 UNIDADES ) FORD KA (RB_) : 1.3 i 06.1998/11.2008 36KW 49CV 1299CC - FORD KA (RB_) : 1.3 i 09.1996/10.2002 37KW 50CV 1299CC - FORD KA (RB_) : 1.3 i 09.1996/11.2008 44KW 60CV 1299CC		<b>BB23</b> NO. 6788739 ABRAÇADEIRA BARRA ESTABILIZADORA ( GASTA 2 UNIDADES ) FORD KA (RB_) : 1.3 i 06.1998/11.2008 36KW 49CV 1299CC - FORD KA (RB_) : 1.3 i 09.1996/10.2002 37KW 50CV 1299CC - FORD KA (RB_) : 1.3 i 09.1996/11.2008 44KW 60CV 1299CC
	<b>E0256-M</b> NO. 1 513 114 - 1141459 - 1313587 - 1526696 - 1695146 - 2S616P082AB - 3S616P082AA - 8V51.6P082.AC - 8V51... ESTICADOR SUPORTE APOIO MOTOR TRAS FORD KA+ III (UK, FK) 1.2 desde 06.2016 51KW 70CV 1198CC B2KA 1778AAC - FORD KA+ III (UK, FK) 1.2 Ti-VCT desde 06.2016 63KW 85CV 1196CC YSKE YSKD 1778AAD		<b>E0258</b> NO. 1513343 - 1745924 - 1790310 - 1905043 - 8V51.3B438.BA - 8V51.3B438.BB - 8V513B438AB - D65134170 ESTICADOR BARRA ESTABILIZADORA FRENTE ( GASTA 2 UNIDADES ) FORD KA+ (UK, FK) : 1.2 Ti-VCT 06.2016/» » 63KW 85CV 1196CC - FORD KA+ (UK, FK) : 1.2 06.2016/» » 51KW 70CV 1198CC - FORD KA+ (UK, FK) : 1.5 TDCi 02.2018/» » 70KW 95CV 1499CC
170x90x85mm	1f-d10,5mm 3f-d11mm	290x36x35mm	2p-d10x25mm

	<p><b>E1018</b> NO. 1027374 - 6831302 - 6866417 - 93B85A262F - 93B85A262G - 93B85A262GA</p> <p>ESTICADOR DE ESCAPE</p> <p>FORD KA</p> <p>66x54x19mm</p>		<p><b>E1055</b> NO. 1025233 - 1079562 - 97KB5A262AB</p> <p>ESTICADOR DE ESCAPE</p> <p>FORD KA (RB_) 1.3 i 09.1996/10.2002 37KW 50CV 1299CC JJB 0928965 - FORD KA (RB_) 1.3 i 09.1996/11.2008 44KW 60CV 1299CC J4D J4S J4K J4P J4N J4M BAA 8566521 8566ACG 0928966 - FORD KA (RB_) 1.3 i 06.1998/11.2008 36KW 49CV 1299CC JLL JLD JH JJJ JJJF 8566353 - FORD KA (RB_) 1.3 i ROCAM 08.2002/11.2008 51KW 70CV 1299CC A9B A9A 8566522 8566ACF</p> <p>54x50x30mm 1f-d10mm</p>
	<p><b>E1070</b> NO. 1003890 - 1016405 - 1099277 - 1118218</p> <p>ESTICADOR DE ESCAPE</p> <p>FORD KA</p> <p>70x50x27mm</p>		<p><b>E1106</b> NO. 1755E9 - 1755F1</p> <p>ESTICADOR DO ESCAPE PARTE DE TRÁS</p> <p>FORD KA</p> <p>55x45x25mm 2f-d10mm</p>
	<p><b>F1649-I</b> NO. 1012814 - 3043575 - 7138554 - 94FB3K661AC</p> <p>FOLE DA DIRECÇÃO ASSISTIDA LADO DIREITO E ESQUERDO</p> <p>FORD KA (RB_): 1.0 i 07.1997/09.1999 38KW 52CV 999CC - FORD KA (RB_): 1.0 i 09.1999/11.2008 48KW 65CV 999CC - FORD KA (RB_): 1.3 i 06.1998/11.2008 36KW 49CV 1299CC - FORD MKA (RB_): 1.3 i 09.1996/10.2002 37KW 50CV 1299CC - FORD KA (RB_): 1.3 i 09.1996/11.2008 44KW 60CV 1299CC</p> <p>d70x190mm 1f-d55mm 1f-d12mm</p>		<p><b>F1649-I</b> NO. 1012814 - 3043575 - 7138554 - 94FB3K661AC</p> <p>FOLE DA DIRECÇÃO ASSISTIDA LADO DIREITO E ESQUERDO</p> <p>FORD STREET KA (RL2): 1.6 05.2003/07.2005 70KW 95CV 1599CC</p> <p>d70x190mm 1f-d55mm 1f-d12mm</p>
	<p><b>F1844-I</b> NO. 1026905 - 1073806 - 1304000 - 1S5W3L537AA - 1S5W4A084AA - 1S5W4A084BA - 4453301 - 97FG3L537AB</p> <p>FOLE DA TRANSMISSÃO JUNTO À CAIXA</p> <p>FORD KA (RB_): 1.3 i 06.1998/11.2008 36KW 49CV 1299CC - FORD KA (RB_): 1.3 i 09.1996/10.2002 37KW 50CV 1299CC - FORD KA (RB_): 1.3 i 09.1996/11.2008 44KW 60CV 1299CC - FORD KA (RB_): 1.3 i 08.2002/11.2008 51KW 70CV 1299CC - FORD KA (RB_): 1.6 i 02.2001/11.2008 70KW 95CV 1597CC</p> <p>d91x102mm 1f-d80mm 1f-d22mm</p>		<p><b>F1855-I</b> NO. 2T143K661AA - 4381841 - 6177346 - 6182218 - 6935233 - 86AB3K661A1A - 92AB3K661AA - 98AG3K661AA</p> <p>FOLE DA DIRECÇÃO LADO DIREITO E ESQUERDO</p> <p>FORD KA (RB_): 1.3 i 06.1998/11.2008 36KW 49CV 1299CC - FORD KA (RB_): 1.3 i 09.1996/10.2002 37KW 50CV 1299CC - FORD KA (RB_): 1.3 i 09.1996/11.2008 44KW 60CV 1299CC - FORD KA (RB_): 1.3 i 08.2002/11.2008 51KW 70CV 1299CC - FORD KA (RB_): 1.6 i 02.2001/11.2008 70KW 95CV 1597CC</p> <p>d60x220mm 1f-d37mm 1f-d13mm</p>
	<p><b>M6090</b> NO. 1030977 - 1953210</p> <p>JUNTA DE ESCAPE</p> <p>FORD KA (APÓS 1997)</p> <p>d53x4mm 1f-d45mm</p>		<p><b>P1026</b> NO. 6168375 - 89FB.2457.AA</p> <p>CAPA DE PEDAL TRAVÃO E EMBRAIAGEM</p> <p>FORD KA (RB_): 1.0 i 07.1997/09.1999 38KW 52CV 999CC - FORD KA (RB_): 1.3 i 09.1996/10.2002 37KW 50CV 1299CC - FORD KA (RB_): 1.3 i 09.1996/11.2008 44KW 60CV 1299CC - FORD KA (RB_): 1.3 i 08.2002/11.2008 51KW 70CV 1299CC - FORD KA (RB_): 1.6 i 02.2001/11.2008 70KW 95CV 1597CC - FORD KA (RB_): 1.6 i 02.2001/11.2008 70KW 95CV 1597CC</p> <p>68x54x14mm</p>
	<p><b>R019213</b> NO. CS519C993BA</p> <p>TUBO EXTRATOR COMBUSTIVEL</p> <p>FORD KA (RU8): 1.3 TDCi 10.2008/05.2016 55KW 75CV 1248CC</p> <p>B-340/3mm 4p-d5x10mm</p>		<p><b>R221359</b> NO. 1040654 - 96FB8B274AG</p> <p>TUBO SUPERIOR DO RADIADOR</p> <p>FORD KA (RB_) 1.0 i 07.1997/09.1999 38KW 52CV 999CC ZH10JRB</p> <p>B340-d29/29mm 70-150-110-100mm + ch-d10mm 500mm</p>
	<p><b>R222400</b> NO. 1059164 - 98FB8B874AB</p> <p>TUBO SUPERIOR DO RADIADOR</p> <p>FORD KA (RB_) 1.0 i 07.1997/09.1999 38KW 52CV 999CC ZH10JRB</p> <p>B295-d25/30mm 85-80-160mm</p>		<p><b>R225775</b> NO. 1710178 - 1710179 - AV216C646AD - AV216K863AE</p> <p>TUBO DO AR SOBREALIMENTAÇÃO</p> <p>FORD KA+ III (UK, FK) 1.5 TDCi desde 02.2018 70KW 95CV 1499CC 15DSOX 1778AAF</p> <p>B174-d47/d47mm 174mm</p>
	<p><b>T0728-I</b> NO. 1610383</p> <p>BATENTE APOIO DE SUSPENSÃO TRÁS ( GASTA 2 UNIDADES )</p> <p>FORD KA (RU8) 1.2 (De 10.2008 -) 51KW 69cv 1242cm3 Hatchback - FORD KA (RU8) 1.3 TDCi (De 10.2008 -) 55KW 75cv 1248cm3 Hatchback -</p> <p>d62x94mm 1p-d21x19mm</p>		<p><b>T1055</b> NO. 1035515 - 97KB5484AA</p> <p>BATENTE DA BARRA ESTABILIZADORA CENTRO FRENTE</p> <p>FORD KA 1.3i (APÓS 1997)</p> <p>40x37x31mm 1f-d14mm</p>

	<p><b>UCRZ1080</b> NO. 1746601 - 1805656 - 97FG-3W007-AA</p> <p>CRUZETA VEIO TRANSMISSÃO TRIPOIDE D32MM/22 DENTES</p> <p>FORD STREET KA (RL2) 1.6 (De 05.2003 Até 07.2005) 70kW 95cv 1599cm3 Cabriolet -</p>		<p><b>UPCR5004</b> NO. 1454051 - 1567143 - 1678260</p> <p>PORCA DA RODA CHAVE 19 M12X1,50X30MM ( BASE CONICA )</p> <p>FORD KA (RB_) 1.0 i (07.1997 -09.1999) 38kw 52cv 999cm3 Hatchback          FORD KA (RB_) 1.0 i (09.1999 -11.2008) 48kw 65cv 999cm3 Hatchback          FORD KA (RB_) 1.3 i (06.1998 -11.2008) 36kw 49cv 1299cm3 Hatchback          FORD KA (RB_) 1.3 i (09.1996 -10.2002) 37kw 50cv 1299cm3 Hatchback          FORD KA (RB_) 1.3 i (09.1996 -11.2008) 44kw 60cv 1299cm3 Hatchback          FORD KA (RB_) 1.3 i ROCAM (08.2002 -11.2008) 51kw 70cv 1299cm3 Hatc...</p>
	<p><b>UPCR5019</b> NO. 1366029 - 1366432 - 1678260 - 2179620 - 5114407 - 6111766</p> <p>PORCA DA RODA CHAVE 19 M12X1,50X31MM ( BASE CONICA )</p> <p>FORD STREET KA (RL2) 1.6 (05.2003 -07.2005) 70kw 95cv 1599cm3 Cabriolet</p>		<p><b>UTR080</b> NO. 1647750 - 1647751 - 1650630 - 1659287 - 1659288 - 6157002 - 6160686 - 6854060 - 6893213 - 7267962 - ...</p> <p>TAMPÃO RESERVATÓRIO LIQUIDO REFRIGERAÇÃO</p> <p>FORD KA (RB_) 1.0 i (07.97 A 09.99) 52cv 999cc Hatchback - FORD KA (RB_) 1.0 i (09.99 A 11.08) 65cv 999cc Hatchback - FORD KA (RB_) 1.3 i (06.98 A 11.08) 49cv 1299cc Hatchback - FORD KA (RB_) 1.3 i (09.96 A 10.02) 50cv 1299cc Hatchback - FORD KA (RB_) 1.3 i (09.96 A 11.08) 60cv 1299cc Hatchback - FORD KA (RB_) 1.3 i (08.02 A 11.08) 70cv 1299cc Hatchback - FORD KA (RB_) 1.6 i (07...</p>
	<p><b>UTR080</b> NO. 1647750 - 1647751 - 1650630 - 1659287 - 1659288 - 6157002 - 6160686 - 6854060 - 6893213 - 7267962 - ...</p> <p>TAMPÃO RESERVATÓRIO LIQUIDO REFRIGERAÇÃO</p> <p>FORD KA STREET (RL2) 1.6 (05.03 A 07.05) 95cv 1599cc Cabriolet</p>		<p><b>UTR0820</b> NO. 90352470 - 90409256 - 90409257 - 9041032690497472 - 90467473</p> <p>TAMPÃO RESERVATÓRIO LIQUIDO REFRIGERAÇÃO</p> <p>FORD KA (RB_) 1.0 i (07.97 A 09.99) 52cv 999cc Hatchback - FORD KA (RB_) 1.0 i (09.99 A 11.08) 65cv 999cc Hatchback - FORD KA (RB_) 1.3 i (06.98 A 11.08) 49cv 1299cc Hatchback - FORD KA (RB_) 1.3 i (09.96 A 10.02) 50cv 1299cc Hatchback - FORD KA (RB_) 1.3 i (09.96 A 11.08) 60cv 1299cc Hatchback - FORD KA (RB_) 1.3 i (08.02 A 11.08) 70cv 1299cc Hatchback - FORD KA (RB_) 1.6 i (07.03 A 1...</p>
	<p><b>UTR0820</b> NO. 90352470 - 90409256 - 90409257 - 9041032690497472 - 90467473</p> <p>TAMPÃO RESERVATÓRIO LIQUIDO REFRIGERAÇÃO</p> <p>FORD STREET KA (RL2) 1.6 (05.03 A 07.05) 95cv 1599cc Cabriolet</p>		<p><b>UTR0859</b> NO. 1650630 - 94539597 - 96293957 - 96312510 - 96351578 - 96420303 - 96536649</p> <p>TAMPÃO RESERVATÓRIO LIQUIDO REFRIGERAÇÃO</p> <p>FORD KA (RB_) 1.0 i (07.97 A 09.99) 52cv 999cc Hatchback - FORD KA (RB_) 1.0 i (09.99 A 11.08) 65cv 999cc Hatchback - FORD KA (RB_) 1.3 i (06.98 A 11.08) 49cv 1299cc Hatchback - FORD KA (RB_) 1.3 i (09.96 A 10.02) 50cv 1299cc Hatchback - FORD KA (RB_) 1.3 i (09.96 A 11.08) 60cv 1299cc Hatchback - FORD KA (RB_) 1.3 i (08.02 A 11.08) 70cv 1299cc Hatchback - FORD KA (RB_) 1.6 i (07.03 A 1...</p>
	<p><b>UTR0859</b> NO. 1650630 - 94539597 - 96293957 - 96312510 - 96351578 - 96420303 - 96536649</p> <p>TAMPÃO RESERVATÓRIO LIQUIDO REFRIGERAÇÃO</p> <p>FORD STREET KA (RL2) 1.6 (05.03 A 07.05) 95cv 1599cc Cabriolet</p>		<p><b>UTV83010</b> NO. 1013938 - 97JM6730BA</p> <p>TAMPÃO VEDAÇÃO BUJÃO</p> <p>FORD KA (RB_) 1.0 i (De 07-1997 Até 09-1999) 38kW 52CV 999cc Hatchback          FORD KA (RB_) 1.0 i (De 09-1999 Até 11-2008) 48kW 65CV 999cc Hatchback          FORD KA (RB_) 1.3 i (De 06-1998 Até 11-2008) 36kW 49CV 1299cc Hatchback          FORD KA (RB_) 1.3 i (De 09-1996 Até 10-2002) 37kW 50CV 1299cc Hatchback          FORD KA (RB_) 1.3 i (De 09-1996 Até 11-2008) 44kW 60CV 1299cc Hatchback          FORD KA (RB_) 1.3 i (De 08-2002 Até 11-200...</p>
	<p><b>UTV83010</b> NO. 1013938 - 97JM6730BA</p> <p>TAMPÃO VEDAÇÃO BUJÃO</p> <p>FORD STREET KA (RL2) 1.6 (De 05-2003 Até 07-2005) 70kW 95CV 1599cc Cabriolet</p>		<p><b>UTV83012</b> NO. 1457117 - 1657022 - 1663906 - 6093527 - 6186775 - 6732529 - 70TM6730AA - 89FF6730AA</p> <p>TAMPÃO VEDAÇÃO BUJÃO</p> <p>FORD KA (RB_) 1.3 i (De 06-1998 Até 11-2008) 36kW 49CV 1299cc Hatchback          FORD KA (RB_) 1.3 i (De 09-1996 Até 10-2002) 37kW 50CV 1299cc Hatchback</p>
	<p><b>UTV83026</b> NO. 1550024</p> <p>TAMPÃO VEDAÇÃO BUJÃO</p> <p>FORD KA (RU8) 1.2 (De 10-2008 Até ...) 51kW 69CV 1242cc Hatchback          FORD KA (RU8) 1.3 TDCi (De 10-2008 Até ...) 55kW 75CV 1248cc Hatchback</p>		<p><b>UVD80303</b> NO. 7257202 - 89FB3B734A2D</p> <p>VEIO DA COLUNA DE DIREÇÃO</p> <p>FORD KA (RB_) 1.3 i (09.1996/10.2002) 37KW 50CV 1299CC JJB 0928965 - FORD KA (RB_) 1.3 i (09.1996/11.2008) 44KW 60CV 1299CC J4D J4S J4K J4P J4N J4M BAA 8566521 8566ACG 0928966 - FORD KA (RB_) 1.3 i (06.1998/11.2008) 36KW 49CV 1299CC JJJ JJD JJH JJG JJF 8566353 - FORD KA (RB_) 1.3 i ROCAM 08.2002/11.2008 51KW 70CV 1299CF A9B A9A 8566522 8566ACF</p>
	<p><b>UVD80303</b> NO. 7257202 - 89FB3B734A2D</p> <p>VEIO DA COLUNA DE DIREÇÃO</p> <p>FORD STREET KA (RL2) 1.6 05.2003/07.2005 70KW 95CV 1599cc CDRB CDRA 8566529</p>		<p><b>Z41158</b> NO. 1656747 - 1825595 - 1752024 - 6740771 - 4852244</p> <p>MOLA DE FIXAÇÃO TIPO PORCA</p> <p>FORD KA (RB_) 1.3 i (06.1998 -11.2008) 36kw 49cv 1299cm3 Hatchback          FORD KA (RB_) 1.3 i (09.1996 -10.2002) 37kw 50cv 1299cm3 Hatchback          FORD KA (RB_) 1.3 i (09.1996 -11.2008) 44kw 60cv 1299cm3 Hatchback          FORD KA (RB_) 1.3 i ROCAM (08.2002 -11.2008) 51kw 70cv 1299cm3 Hatchback          FORD KA (RB_) 1.6 i (02.2001 -11.2008) 70kw 95cv 1597cm3 Hatchback</p>

	<b>Z50177</b>	NO. 1554685 - W303392		<b>Z55127</b>	NO. 1038008 - W704309S300
	MOLA DE FIXAÇÃO PAINEL FORD KA (RU8) 1.2 10.2008/05.2016 51KW 69CV 1242CC 169A4000 FP4 8566APU - FORD KA (RU8) 1.3 TDCi 10.2008/05.2016 55KW 75CV 1248CC FD4 169A1000 8566APV			MOLA DE PAINEL FORD KA (RB_) 1.3 i (06.1998 - 11.2008) 36kw 49cv 1299cm3 Hatchback FORD KA (RB_) 1.3 i (09.1996 - 10.2002) 37kw 50cv 1299cm3 Hatchback FORD KA (RB_) 1.3 i (09.1996 - 11.2008) 44kw 60cv 1299cm3 Hatchback FORD KA (RB_) 1.3 i ROCAM (08.2002 - 11.2008) 51kw 70cv 1299cm3 Hatchback FORD KA (RB_) 1.6 i (02.2001 - 11.2008) 70kw 95cv 1597cm3 Hatchback	
d8x 22mm		f-d20mm	d8x 20mm		f-d18mm
	<b>Z55127</b>	NO. 1038008 - W704309S300		<b>Z80677</b>	NO. 6786759
	MOLA DE PAINEL FORD STREET KA (RL2) 1.6 (05.2003 - 07.2005) 70kw 95cv 1599cm3 Cabriolet			Mola de painel FORD KA	
d8x 20mm		f-d18mm	d15x14.5mm		1p-d9,3-12.5mm
	<b>Z80704</b>	NO. 500326189 - 6176723		<b>Z80717</b>	NO. 6150260
	Mola de painel FORD KA (Após 1997)			Mola de fixação FORD KA	
d18x21mm		1p-d8.2-15mm	d20x12.5mm		1p-8x11-10mm 1f-d5.5mm

FORD KUGA





	<b>A1784</b>	NO. 1224049 - 1250824 - 1355357 - 1370874 - 1404996 - 1420044 - 1522138 - 1533046 - 1751001 - 3M51...		<b>A1822</b>	NO. 1454284 - 1690298 - 1801350 - 3M517M121JC - AV617M121CB - AV617M121CC
	APOIO DA CAIXA VELOCIDADES FORD KUGA I: 2.5 03.2009/11.2012 147KW 200CV 2522CC - FORD KUGA I: 2.5 4x4 02.2008/11.2012 147KW 200CV 2522CC - FORD KUGA I: 2.0 TDCi 03.2008/11.2012 100KW 136CV 1997CC - FORD KUGA I: 2.0 TDCi 4x4 03.2008/11.2012 100KW 136CV 1997CC - FORD KUGA I: 2.0 TDCi 03.2010/11.2012 103KW 140CV 1997CC - FORD KUGA I: 2.0 TDCi 4x4 03.2010/11.2012 103KW 140CV 1997CC - FORD KUGA I: 2.0 TDCi 4x4 03.2010/11.2012 12...			APOIO DA CAIXA VELOCIDADES FORD KUGA II	
160x1005x45mm		2f-d12mm 1f-M12	230x160x70mm		4f-16x19mm 1f-d15mm
	<b>A2302</b>	NO. 1224049 - 1355357 - 1404996 - 1420044		<b>A2484</b>	NO. 1437544 - 1437545 - 1798908
	APOIO CAIXA VELOCIDADES FORD KUGA I: 2.5 03.2009/11.2012 147KW 200CV 2522CC - FORD KUGA I: 2.5 4x4 02.2008/11.2012 147KW 200CV 2522CC - FORD KUGA I: 2.0 TDCi 03.2008/11.2012 100KW 136CV 1997CC - FORD KUGA I: 2.0 TDCi 4x4 03.2008/11.2012 100KW 136CV 1997CC - FORD KUGA I: 2.0 TDCi 03.2010/11.2012 103KW 140CV 1997CC - FORD KUGA I: 2.0 TDCi 4x4 03.2010/11.2012 103KW 140CV 1997CC - FORD KUGA I: 2.0 TDCi 4x4 03.2010/11.2012 12...			APOIO DO MOTOR LADO ESQUERDO FORD KUGA II	
175x108x43mm		1f-d12mm 1f-d14mm 1r-d11mm	228x157x62mm		1f-d14mm 4f-16x20mm
	<b>A2497</b>	NO. 1686911 - 1701509 - 1742411 - 1753974		<b>A2516</b>	NO. 1223973 - 1224047 - 1251749 - 1255094 - 1256702 - 1315539 - 1345226 - 1376724 - 1510904
	APOIO DO MOTOR PARTE DA FRENTE LADO DIREITO FORD KUGA II (DM2) 1.5 EcoBoost (De 09.2014 -) 110kW 150cv 1499cm3 SUV - FORD KUGA II (DM2) 1.5 EcoBoost 4x4 (De 09.2014 -) 134kW 182cv 1499cm3 SUV - FORD KUGA II (DM2) 1.6 EcoBoost (De 03.2013 -) 110kW 150cv 1596cm3 SUV - FORD KUGA II (DM2) 1.6 EcoBoost 4x4 (De 10.2012 Até 04.2015) 132kW 179cv 1596cm3 SUV - FORD KUGA II (DM2) 1.6 EcoBoost 4x4 (De 03.2013 -) 134kW 182cv 1596cm3 SUV -			APOIO DO MOTOR PARTE DA FRENTE LADO DIREITO FORD KUGA I 2.0 TDCi (De 03.2008 Até 11.2012) 100KW 136cv 1997cm3 SUV - FORD KUGA I 2.0 TDCi (De 03.2010 Até 11.2012) 103KW 140cv 1997cm3 SUV - FORD KUGA I 2.0 TDCi 4x4 (De 03.2008 Até 11.2012) 100KW 136cv 1997cm3 SUV - FORD KUGA I 2.0 TDCi 4x4 (De 03.2010 Até 11.2012) 103KW 140cv 1997cm3 SUV - FORD KUGA I 2.0 TDCi 4x4 (De 03.2010 Até 11.2012) 120kW 163cv 1997cm3 SUV -	
254x140x102mm		3f-d12mm 2f-20x22m	255x157x140mm		1f-d14mm 1f-14x15mm 2f-18x20mm
	<b>A2516</b>	NO. 1223973 - 1224047 - 1251749 - 1255094 - 1256702 - 1315539 - 1345226 - 1376724 - 1510904		<b>F4236</b>	NO. 1223834 - 1305329
	APOIO DO MOTOR PARTE DA FRENTE LADO DIREITO FORD KUGA II (DM2) 2.0 TDCi (De 03.2013 -) 85kW 115cv 1998cm3 SUV - FORD KUGA II (DM2) 2.0 TDCi (De 09.2014 -) 88kW 120cv 1998cm3 SUV - FORD KUGA II (DM2) 2.0 TDCi (De 03.2013 -) 100kW 136cv 1997cm3 SUV - FORD KUGA II (DM2) 2.0 TDCi (De 03.2013 -) 103kW 140cv 1997cm3 SUV - FORD KUGA II (DM2) 2.0 TDCi (De 09.2014 -) 110kW 150cv 1997cm3 SUV - FORD KUGA II (DM2) 2.0 TDCi 4x4 (De 03.2013 -) 100kW 136...			FOLE CAPA PROTEÇÃO AMORTECEDOR FRENTE ( GASTA 2 UNIDADES ) FORD KUGA I: 2.5 03.2009/11.2012 147KW 200CV 2522CC - FORD KUGA I: 2.5 4x4 02.2008/11.2012 147KW 200CV 2522CC - FORD KUGA I: 2.0 TDCi 03.2008/11.2012 100KW 136CV 1997CC - FORD KUGA I: 2.0 TDCi 4x4 03.2008/11.2012 100KW 136CV 1997CC - FORD KUGA I: 2.0 TDCi 03.2010/11.2012 103KW 140CV 1997CC - FORD KUGA I: 2.0 TDCi 4x4 03.2010/11.2012 103KW 140CV 1997CC - FORD KUGA I: 2.0 TDCi 4x4 03.2010/11.2012 120kW 163cv 1997cm3 SUV -	
255x157x140mm		1f-d14mm 1f-14x15mm 2f-18x20mm	d79x241mm		1f-d61mm 1f-d64mm

	<p><b>F4236</b> NO. 1223834 - 1305329</p> <p>FOLE CAPA PROTEÇÃO AMORTECEDOR FRENTE ( GASTA 2 UNIDADES )</p> <p>FORD KUGA II VAN: 1.5 EcoBoost 06.2019/&gt;&gt;&gt;&gt; 88KW 120CV 1499CC - FORD KUGA II VAN: 1.5 EcoBoost 4x4 06.2019/&gt;&gt;&gt;&gt; 129KW 176CV 1499CC - FORD KUGA II VAN: 1.5 EcoBoost 4x4 09.2014/&gt;&gt;&gt;&gt; 134KW 182CV 1499CC - FORD KUGA II VAN: 1.5 TDCi 01.2019/&gt;&gt;&gt;&gt; 88KW 120CV 1499CC - FORD KUGA II VAN: 2.0 TDCi 04.09.2014/&gt;&gt;&gt;&gt; 132KW 180CV 1998CC - FORD KUGA II VAN: 2.0 TDCi 06.2019/&gt;&gt;&gt;&gt; 88KW 120CV 1997CC</p> <p>d79x241mm 1f-d61mm 1f-d64mm</p>		<p><b>F4364</b> NO. 1639784 - 8V4R7P002KB</p> <p>FOLE ALAVANCA VELOCIDADES C/ ARO CROMADO</p> <p>FORD KUGA I 2.0 TDCi 03.2008/11.2012 100KW 136CV 1997CC G6DG UKDA 8566AAH - FORD KUGA I 2.0 TDCi 4x4 03.2008/11.2012 100KW 136CV 1997CC G6DG UKDA 8566AOM - FORD KUGA I 2.5 4x4 02.2008/11.2012 147KW 200CV 2522CC HYDB HYDC 8566AQC</p> <p>138x124mm 1f-117x96mm 1f-d25mm</p>
	<p><b>KF9037</b> NO. 1514345 - 1426856 - 1534276 - 1595106 - 1727141 - 1727147 - 1774394 - 1787355 - 1794505 - CC11-4C06...</p> <p>KIT DE FOLE TRANSMISSÃO LADO DA RODA</p> <p>FORD KUGA I 2.0 TDCi (De 03.2008 Até 11.2012) 100kW 136cv 1997cm3 SUV - FORD KUGA I 2.0 TDCi (De 03.2010 Até 11.2012) 103kW 140cv 1997cm3 SUV - FORD KUGA I 2.0 TDCi 4x4 (De 03.2008 Até 11.2012) 100kW 136cv 1997cm3 SUV - FORD KUGA I 2.0 TDCi 4x4 (De 03.2010 Até 11.2012) 103kW 140cv 1997cm3 SUV - FORD KUGA I 2.0 TDCi 4x4 (De 03.2010 Até 11.2012) 103kW 140cv 1997cm3 SUV - FORD KUGA I 2.0 TDCi 4x4 (De 03.2010 Até 11.2012) 120kW 163cv 1997cm3 SUV - FORD KUGA I 2.5 (De 03.2009...</p> <p>d118x136mm 1f-d109mm 1f-d29mm</p>		<p><b>R225074</b> NO. 1697700 - AV616C700AD</p> <p>TUBO DO AR SOBREALIMENTAÇÃO</p> <p>FORD KUGA I 2.0 TDCi (De 03.2010 Até 11.2012) 103kW 140cv 1997cm3 SUV -</p> <p>B73-42/47mm 73mm</p>
	<p><b>R225074</b> NO. 1697700 - AV616C700AD</p> <p>TUBO DO AR SOBREALIMENTAÇÃO</p> <p>FORD KUGA II (DM2) 2.0 TDCi (De 09.2014 Até 06.2019) 88kW 120cv 1997cm3 SUV - FORD KUGA II (DM2) 2.0 TDCi (De 03.2013 Até 09.2014) 103kW 140cv 1997cm3 SUV -</p> <p>B73-42/47mm 73mm</p>		<p><b>R225079</b> NO. 1697700 - AV616C700AD</p> <p>TUBO DO AR SOBREALIMENTAÇÃO</p> <p>FORD KUGA I 2.0 TDCi (De 03.2010 Até 11.2012) 103kW 140cv 1997cm3 SUV -</p> <p>B136-48/49mm 73x58mm</p>
	<p><b>R225079</b> NO. 1697700 - AV616C700AD</p> <p>TUBO DO AR SOBREALIMENTAÇÃO</p> <p>FORD KUGA II (DM2) 2.0 TDCi (De 09.2014 Até 06.2019) 88kW 120cv 1997cm3 SUV - FORD KUGA II (DM2) 2.0 TDCi (De 03.2013 Até 09.2014) 103kW 140cv 1997cm3 SUV -</p> <p>B136-48/49mm 73x58mm</p>		<p><b>R225462</b> NO. 1303478 - 3M5Q6A646AA</p> <p>TUBO DO RADIADOR DO ÓLEO COM JUNTAS</p> <p>FORD KUGA I 2.0 TDCi 03.2008/11.2012 100KW 136CV 1997CC G6DG UKDA 8566AAH - FORD KUGA I 2.0 TDCi 03.2010/11.2012 103KW 140CV 1997CC UFDA 8566ATR - FORD KUGA I 2.0 TDCi 4x4 03.2008/11.2012 100KW 136CV 1997CC G6DG UKDA 8566AOM - FORD KUGA I 2.0 TDCi 4x4 03.2010/11.2012 103KW 140CV 1997CC UFDA 8566ATQ - FORD KUGA I 2.0 TDCi 4x4 03.2010/11.2012 120KW 163CV 1997CC TXDA 8566ATO</p> <p>d81x4mm d27x3mm d72x4mm d22x97mm 1f-d19mm 1f-d14mm</p>
	<p><b>R225462</b> NO. 1303478 - 3M5Q6A646AA</p> <p>TUBO DO RADIADOR DO ÓLEO COM JUNTAS</p> <p>FORD KUGA II (DM2)   ESCAPE 2.0 TDCi 03.2013/12.2019 100KW 136CV 1997CC UKMA 8566AAH - FORD KUGA II (DM2)   ESCAPE 2.0 TDCi 03.2013/09.2014 103KW 140CV 1997CC UFMA 8566ATR - FORD KUGA II (DM2)   ESCAPE 2.0 TDCi 4x4 03.2013/12.2019 100KW 136CV 1997CC UKMA 8566AOM - FORD KUGA II (DM2)   ESCAPE 2.0 TDCi 4x4 03.2013/09.2014 103KW 140CV 1997CC UFMA 8566ATQ - FORD KUGA II (DM2)   ESCAPE 2.0 TDCi 4x4 03....</p> <p>d81x4mm d27x3mm d72x4mm d22x97mm 1f-d19mm 1f-d14mm</p>		<p><b>R230483</b> NO. 2584513 - KV616K863BA</p> <p>TUBO DO AR SOBREALIMENTAÇÃO</p> <p>FORD KUGA III (DFK)   ESCAPE 1.5 EcoBoost desde 07.2019 88KW 120CV 1496CC UNDA 8566BTF - FORD KUGA III (DFK)   ESCAPE 1.5 EcoBoost desde 07.2019 110KW 150CV 1496CC YZDB YZDA 8566BTI - FORD KUGA III (DFK)   ESCAPE 1.5 EcoBoost desde 09.2019 134KW 183CV 1496CC 996 Y1DA 8566BTZ</p> <p>B105-d46/d47mm 47-57mm</p>
	<p><b>S1756</b> NO. 1061866 - 1064128 - 1150353 - 1335249 - 1357317 - 1357319 - 1502729 - 1548460 - 1718501 - 1762008 - ...</p> <p>SILENT-BLOC BRAÇO OSCILANTE SUSPENSÃO TRÁS</p> <p>FORD KUGA I 2.5 (De 2009.03 Até 2012.11) 147KW 200cv 2522cm3 Veículo todo-terreno fechado - FORD KUGA I 2.5 4x4 (De 2008.02 Até 2012.11) 147kW 200cv 2522cm3 Veículo todo-terreno fechado - FORD KUGA I 2.0 TDCi (De 2008.03 Até 2012.11) 100KW 136cv 1997cm3 Veículo todo-terreno fechado - FORD KUGA I 2.0 TDCi 4x4 (De 2008.03 Até 2012.11) 100KW 136cv 1997cm3 Veículo todo-terreno fe...</p> <p>d32x55mm c49mm 1f-d12mm</p>		<p><b>S2132</b> NO. 1702970 - 1702983 - 1709424 - 1709466 - 1749593 - 1749991 - 1749992 - 1793236</p> <p>SILENT-BLOC DO BRAÇO SUSPENSÃO FRENTE PARTE DA FRENTE</p> <p>FORD KUGA II (DM2) 1.5 EcoBoost (01.2016 - 06.2019) 88kw 120cv 1499cm3 SUV FORD KUGA II (DM2) 1.5 EcoBoost (09.2014 - 06.2019) 110kw 150cv 1499cm3 SUV FORD KUGA II (DM2) 1.5 EcoBoost 4x4 (08.2018 - 06.2019) 129kw 176cv 1499cm3 SUV FORD KUGA II (DM2) 1.5 EcoBoost 4x4 (09.2014 - 06.2018) 134kw 182cv 1499cm3 SUV FORD KUGA II (DM2) 1.5 EcoBoost 4x4 (07.2016 -) 110kw 150cv 1499cm3 SUV FORD KUGA II (DM2)...</p> <p>d53x 65mm c-38mm-dc-31mm-1f-d14mm</p>
	<p><b>S2132</b> NO. 1702970 - 1702983 - 1709424 - 1709466 - 1749593 - 1749991 - 1749992 - 1793236</p> <p>SILENT-BLOC DO BRAÇO SUSPENSÃO FRENTE PARTE DA FRENTE</p> <p>FORD KUGA II VAN 1.5 EcoBoost (06.2019 -) 88kw 120cv 1499cm3 Caixa/SUV FORD KUGA II VAN 1.5 EcoBoost 4x4 (06.2019 -) 129kw 176cv 1499cm3 Caixa/SUV FORD KUGA II VAN 1.5 EcoBoost 4x4 (09.2014 -) 134kw 182cv 1499cm3 Caixa/SUV FORD KUGA II VAN 1.5 TDCi (01.2019 -) 88kw 120cv 1499cm3 Caixa/SUV FORD KUGA II VAN 2.0 TDCi (06.2019 -) 88kw 120cv 1997cm3 Caixa/SUV FORD KUGA II VAN 2.0 TDCi 4x4 (09.2014 -) 1...</p> <p>d53x 65mm c-38mm-dc-31mm-1f-d14mm</p>		<p><b>T1128</b> NO. 1305960 - 1348231 - 30666266 - 3M51.5484.CA - 3N615484AA</p> <p>BATENTE DA BARRA ESTABILIZADORA DA FRENTE</p> <p>FORD KUGA I: 2.5 03.2009/11.2012 147KW 200CV 2522CC - FORD KUGA I: 2.5 4x4 02.2008/11.2012 147KW 200CV 2522CC - FORD KUGA I: 2.0 TDCi 03.2008/11.2012 100KW 136CV 1997CC - FORD KUGA I: 2.0 TDCi 4x4 03.2008/11.2012 100KW 136CV 1997CC - FORD KUGA I: 2.0 TDCi 4x4 03.2010/11.2012 103KW 140CV 1997CC - FORD KUGA I: 2.0 TDCi 4x4 03.2010/11.2012 103KW 140CV 1997CC - FORD KUGA I: 2.0 TDCi 4x4 03.2010/11.2012 12... </p> <p>47x47x48mm 1f-d18mm</p>
	<p><b>T1220</b> NO. 1715440</p> <p>BATENTE DA BARRA ESTABILIZADORA DA FRENTE</p> <p>FORD KUGA II (DM2) 1.5 EcoBoost (De 03.2013 -) 88kW 120cv 1499cm3 Veículo todo-terreno fechado - FORD KUGA II (DM2) 1.5 EcoBoost (De 09.2014 -) 110kW 150cv 1499cm3 Veículo todo-terreno fechado - FORD KUGA II (DM2) 1.5 EcoBoost 4x4 (De 09.2014 -) 134kW 182cv 1499cm3 Veículo todo-terreno fechado - FORD KUGA II (DM2) 1.5 TDCi (De 07.2016 -) 88kW 120cv 1499cm3 Veículo todo-terreno fechado - FORD KUGA ...</p> <p>44x46x52mm 1f-d21mm</p>		<p><b>T1221</b> NO. 1810326</p> <p>BATENTE DA BARRA ESTABILIZADORA DA FRENTE</p> <p>FORD KUGA II (DM2) 1.6 EcoBoost (De 03.2013 -) 110kW 150cv 1596cm3 Veículo todo-terreno fechado - FORD KUGA II (DM2) 1.6 EcoBoost 4x4 (De 03.2013 -) 134kW 182cv 1596cm3 Veículo todo-terreno fechado - FORD KUGA II (DM2) 2.0 TDCi (De 03.2013 -) 103kW 140cv 1997cm3 Veículo todo-terreno fechado - FORD KUGA II (DM2) 2.0 TDCi 4x4 (De 03.2013 -) 103kW 140cv 1997cm3 Veículo todo-terreno fechado - FORD KUGA II (DM2) 2.0 TDCi 4x4 (De 03.2013 -) 103kW 140cv 1997cm3 Veículo todo-terreno fechado - FORD KUG...</p> <p>44x47x52mm 1f-d23mm</p>









	<p><b>URTE6001</b> NO. 1956140</p> <p>RETENTOR VEIO DIFERENCIAL TRANSMISSÃO D42X76X12MM</p> <p>FORD MAVERICK (UDS, UNS): 2.4 i (UDS) 09.1996/04.1998 85KW 116CV 2389CC - FORD MAVERICK (UDS, UNS): 2.4 i 09.1996/04.1998 87KW 118CV 2389CC - FORD MAVERICK (UDS, UNS): 2.4 i 02.1993/08.1996 91KW 124CV 2389CC - FORD MAVERICK (UDS, UNS): 2.7 TD 02.1993/08.1996 74KW 100CV 2663CC - FORD MAVERICK (UDS, UNS): 2.7 TD 09.1996/04.1998 92KW 125CV 2664CC</p> <p>d76,15x21x12mm 1f-d40,2mm</p>		<p><b>URTE6001</b> NO. 1956140</p> <p>RETENTOR VEIO DIFERENCIAL TRANSMISSÃO D42X76X12MM</p> <p>FORD MAVERICK (UDS, UNS): 2.4 i (UDS) 09.1996/04.1998 85KW 116CV 2389CC - FORD MAVERICK (UDS, UNS): 2.4 i 09.1996/04.1998 87KW 118CV 2389CC - FORD MAVERICK (UDS, UNS): 2.4 i 02.1993/08.1996 91KW 124CV 2389CC - FORD MAVERICK (UDS, UNS): 2.7 TD 02.1993/08.1996 74KW 100CV 2663CC - FORD MAVERICK (UDS, UNS): 2.7 TD 09.1996/04.1998 92KW 125CV 2664CC</p> <p>d76,15x21x12mm 1f-d40,2mm</p>
	<p><b>URTE6008</b> NO. F003-27238-B</p> <p>RETENTOR VEIO DIFERENCIAL TRANSMISSÃO D35X56X9/14,8MM</p> <p>FORD MAVERICK 2.0 16V desde 02.2001 91KW 124CV 1989CC YF 8566511 8566457 - FORD MAVERICK 2.0 16V FWD desde 02.2001 91KW 124CV 1989CC YF - FORD MAVERICK 2.3 16V desde 03.2004 110KW 150CV 2261CC GZ 8566ACD 8566544 - FORD MAVERICK 3.0 V6 24V desde 02.2001 145KW 197CV 2967CC AJ 8566458 8566512 - FORD MAVERICK 3.0 V6 24V desde 03.2004 149KW 203CV 2967CC AJ 8566ACE 8566543 - FORD MAVERICK 3.0 V6 24V FWD...</p> <p>d56x15mm 1f-d34mm</p>		<p><b>URTE6008</b> NO. F003-27238-B</p> <p>RETENTOR VEIO DIFERENCIAL TRANSMISSÃO D35X56X9/14,8MM</p> <p>FORD MAVERICK 2.0 16V desde 02.2001 91KW 124CV 1989CC YF 8566511 8566457 - FORD MAVERICK 2.0 16V FWD desde 02.2001 91KW 124CV 1989CC YF - FORD MAVERICK 2.3 16V desde 03.2004 110KW 150CV 2261CC GZ 8566ACD 8566544 - FORD MAVERICK 3.0 V6 24V desde 02.2001 145KW 197CV 2967CC AJ 8566458 8566512 - FORD MAVERICK 3.0 V6 24V desde 03.2004 149KW 203CV 2967CC AJ 8566ACE 8566543 - FORD MAVERICK 3.0 V6 24V FWD...</p> <p>d56x15mm 1f-d34mm</p>
	<p><b>UTR0630</b> NO. 6045648</p> <p>TAMPÃO RADIADOR</p> <p>FORD MAVERICK (UDS, UNS) 2.4 i (UDS) (De 1996.09 Até 1998.04) 85KW 116cv 2389cm3 Veiculo todo-terreno fechado - FORD MAVERICK (UDS, UNS) 2.4 i (De 1996.09 Até 1998.04) 87kW 118cv 2389cm3 Veiculo todo-terreno fechado - FORD MAVERICK (UDS, UNS) 2.4 i (De 1993.02 Até 1996.08) 91KW 124cv 2389cm3 Veiculo todo-terreno fechado - FORD MAVERICK (UDS, UNS) 2.7 TD (De 1993.02 Até 1996.08) ...</p> <p>d59/78x29mm d38x25mm</p>		<p><b>UTR0864</b> NO. 39172-31G25 - 39712-31G25 - 39741-0F000 - 39741-0F00A - 39741-41W03 - 39741-41W25 - 39741-41W26</p> <p>TAMPÃO RESERVATÓRIO LIQUIDO REFRIGERAÇÃO</p> <p>FORD MAVERICK</p> <p>d65x30mm d48x14mm 1p-d40x32mm</p>
	<p><b>UTR0957</b> NO. XM348100AB - 1351958 - 1455876 - 4026783 - 4137897 - F87H8100AA - XM348100EB - YL848100HAA</p> <p>TAMPÃO DO RADIADOR</p> <p>FORD MAVERICK 2.0 16V (De 02.2001 -) 91kW 124cv 1989cm3 SUV - FORD MAVERICK 3.0 V6 24V (De 02.2001 -) 145kW 197cv 2967cm3 SUV - FORD MAVERICK 3.0 V6 24V (De 03.2004 -) 149kW 203cv 2967cm3 SUV -</p> <p>d45x25mm d28x22mm</p>		<p><b>UTR0958</b> NO. XM348100AB - 1351958 - 1455876 - 4026783 - 4137897 - F87H8100AA - XM348100EB - YL848100HAA</p> <p>TAMPÃO RADIADOR</p> <p>FORD MAVERICK 2.0 16V (De 02.2001 -) 91kW 124cv 1989cm3 SUV - FORD MAVERICK 2.0 16V FWD (De 02.2001 -) 91kW 124cv 1989cm3 SUV - FORD MAVERICK 3.0 V6 24V (De 02.2001 -) 145kW 197cv 2967cm3 SUV - FORD MAVERICK 3.0 V6 24V (De 03.2004 -) 149kW 203cv 2967cm3 SUV - FORD MAVERICK 3.0 V6 24V FWD (De 02.2001 -) 145kW 197cv 2967cm3 SUV -</p> <p>d45x29mm d28x21mm</p>
	<p><b>UTV83010</b> NO. 1013938 - 97JM6730BA</p> <p>TAMPÃO VEDAÇÃO BUJÃO</p> <p>FORD MAVERICK 2.0 16V (De 02-2001 Até ...) 91kW 124CV 1989cc Veiculo todo-terreno fechado</p> <p>d28x35mm c19mm d13mm</p>		<p><b>W5026</b> NO. 1038330 - 1135052 - 1250444 - 26105255 - 6599021 - 928M6B320DB - 928M6B320DD - 928M6B320DE - 928M6B3...</p> <p>POLIE CAMBOTA ( 6 PISTAS )</p> <p>FORD MAVERICK: 2.0 16V 02.2001/»»» 91KW 124CV 1989CC</p> <p>d131.3mm d28mm</p>

FORD MONDEO

	<p><b>A1388</b> NO. 6838725 - 93BB.18198.BC</p> <p>APOIO DA SUSPENSÃO DE TRÁS (AMORTECEDOR)</p> <p>FORD MONDEO I (GBP) 1.6 i 16V 02.1993/08.1996 66KW 90CV 1597CC L1F 0928831 - FORD MONDEO I (GBP) 1.6 i 16V 07.1994/08.1996 65KW 88CV 1597CC L1J 0928884 - FORD MONDEO I (GBP) 1.8 i 16V 02.1993/08.1996 85KW 115CV 1796CC RKA 0928833 - FORD MONDEO I (GBP) 1.8 i 16V 07.1994/08.1996 82KW 112CV 1796CC RKB 0928869 - FORD MONDEO I (GBP) 1.8 i 16V 4x4 02.1993/08.1996 85KW 115CV 1796CC RKA - FORD MONDEO I (G...</p> <p>174x172x44mm 1f-d12mm 2f-d8mm</p>		<p><b>A1591</b> NO. 1024959 - 1097914 - 6803993 - 6911968 - 98BB.6P082.AA</p> <p>APOIO CAIXA VELOCIDADES</p> <p>FORD MONDEO I (GBP) 1.6 i 16V 02.1993/08.1996 66KW 90CV 1597CC L1F 0928831 - FORD MONDEO I (GBP) 1.6 i 16V 07.1994/08.1996 65KW 88CV 1597CC L1J 0928884 - FORD MONDEO I (GBP) 1.8 i 16V 02.1993/08.1996 85KW 115CV 1796CC RKA 0928833 - FORD MONDEO I (GBP) 1.8 i 16V 07.1994/08.1996 82KW 112CV 1796CC RKB 0928869 - FORD MONDEO I (GBP) 1.8 i 16V 4x4 02.1993/08.1996 85KW 115CV 1796CC RKA - FORD MONDEO I (G...</p> <p>140x130x125mm 1f-d20mm</p>
	<p><b>A1595</b> NO. 6704254 - 7324691 - 948125 - 94BB.8125.BB</p> <p>APOIO SUPORTE RADIADOR INFERIOR</p> <p>FORD MONDEO I (GBP) TIPO ANO DE CONSTRUÇÃO KW HP CC CÓDIGO(S) DO MOTOR NÚMERO KBA (ALEMANHA) INFORMAÇÕES</p>		

1.6 i 16V 02.1993 - 08.1996 66 90 1597 L1F 0928831  
 1.6 i 16V 07.1994 - 08.1996 65 88 1597 L1J 0928884  
 1.8 i 16V 02.1993 - 08.1996 85 115 1796 RKA 0928833  
 1.8 TD 06.1993 - 08.1996 65 88 1753 RFNRFM 0928850  
 2.0 i 16V 12.1994 - 08.1996 97 132 1988 NGA  
 2.5 i 24V...

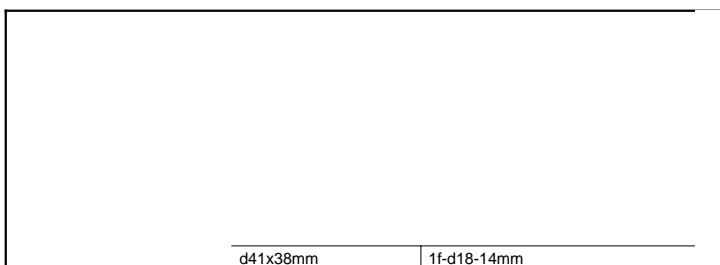

d41x38mm

1f-d18-14mm

**A1596**









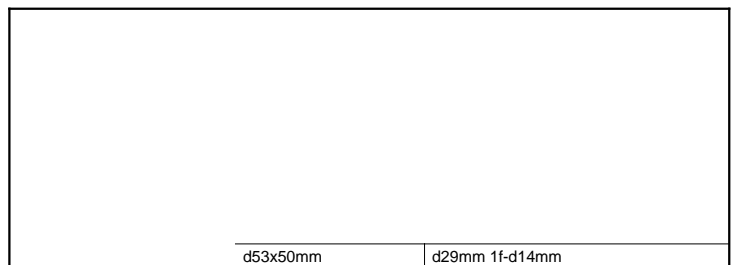







NO. 1354636 - 7324692 - 94BB.8125.CA

APOIO SUPORTE RADIADOR SUPERIOR

FORD  
 MONDEO III (B5Y)  
 Informações  
 Tipo  
 Ano de construção  
 kW  
 HP  
 cc  
 Código(s) do motor  
 Número KBA (Alemanha)





1.8 16V 10.2000 - 03.2007 81 110 1798  
CGBB CGBA  
8566AEG 8566410  
1.8 16V 10.2000 - 03.2007 92 125 1798  
CHBA CHBB  
8566AEH 8566411  
1.8 SCI 06.2003 - 03.2007 96 130 1798  
CFBA  
8566AEF 8566539  
2.0 16V 10.2000 - 03.2007 107 146 1999  
CJBB CJBA  
8566AEI 8566...





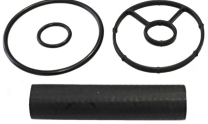



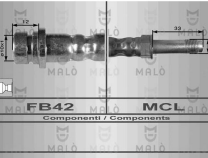
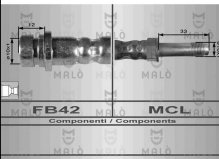
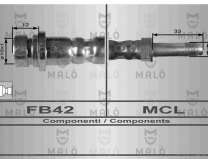



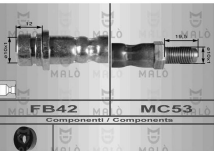
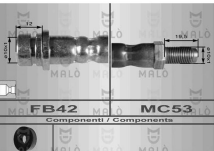
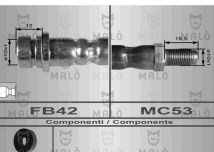
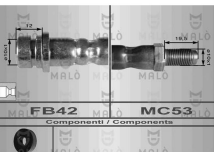

	<p><b>A1779</b> NO. 1117880 - 1212003 - 1213618 - 1220636 - 1332838</p> <p><b>APOIO DO MOTOR FRENTE PARTE SUPERIOR</b></p> <p>FORD MONDEO III 2.0 16V DI - TDDi - TDCi (D5BA - SDBA) 90CV (11-2000 A 08-2007) - 2.0 16V TDDi - TDCi (D6BA - HJBA - HJBB - HJBC) 115CV (11-2000 A 08-2007) - 2.0 TDCi (FMBA - N7BA) 130CV (10-2001 A 08-2007) - 2.2 TDCi (QJBA - QJBB) 155CV (09-2004 A 08-2007)</p> <p>195x140x130mm 2f-d8mm 2f-d13mm 2f-16x20mm</p>		<p><b>A1779</b> NO. 1117880 - 1212003 - 1213618 - 1220636 - 1332838</p> <p><b>APOIO DO MOTOR FRENTE PARTE SUPERIOR</b></p> <p>FORD MONDEO III STATION WAGON 2.0 16V Di - TDDi - TDCi (D5BA - SDBA) 90CV (11-2000 A 08-2007) - 2.0 16V TDDi - TDCi (D6BA - HJBA - HJBB - HJBC) 115CV (11-2000 A 08-2007) - 2.0 TDCi (FMBA - N7BA) 130CV (10-2001 A 08-2007) - 2.2 TDCi (QJBA - QJBB) 155CV (09-2004 A 08-2)</p> <p>195x140x130mm 2f-d8mm 2f-d13mm 2f-16x20mm</p>
	<p><b>A1779</b> NO. 1117880 - 1212003 - 1213618 - 1220636 - 1332838</p> <p><b>APOIO DO MOTOR FRENTE PARTE SUPERIOR</b></p> <p>FORD MONDEO III TRE VOLUMI 2.0 16V Di - TDDi - TDCi (D5BA - SDBA) 90CV (11-2000 A 08-2007) - 2.0 16V TDDi - TDCi (D6BA - HJBA - HJBB - HJBC) 115CV (11-2000 A 08-2007) - 2.0 TDCi (FMBA - N7BA) 130CV (10-2001 A 08-2007) - 2.2 TDCi (QJBA - QJBB) 155CV (09-2004 A 08-2007)</p> <p>195x140x130mm 2f-d8mm 2f-d13mm 2f-16x20mm</p>		<p><b>A1831</b> NO. 1205834 - 1205835 - 1303625 - 157118198AF - 157118198AG - 157118198AH</p> <p><b>APOIO SUPORTE AMORTECEDOR TRÁS ( GASTA 2 UNIDADES )</b></p> <p>FORD MONDEO III (B5Y) 1.8 16V Hatchback (10.00 - 03.07) 110cv 1798cc - FORD MONDEO III (B5Y) 1.8 16V Hatchback (10.00 - 03.07) 125cv 1798cc - FORD MONDEO III (B5Y) 1.8 SCl Hatchback (06.03 - 03.07) 130cv 1798cc - FORD MONDEO III (B5Y) 2.0 16V Hatchback (1</p> <p>170x160x70mm 2f-d10mm 1f-d12mm</p>
	<p><b>A2323</b> NO. 1377259 - 1417257 - 1453047 - 6G916F012DB - 6G916F012DC - 6G916F012DD</p> <p><b>APOIO DO MOTOR FRENTE LADO DIREITO</b></p> <p>FORD MONDEO IV (BA7): 1.8 TDCi 06.2007/01.2015 92KW 125CV 1753CC - FORD MONDEO IV três volumes (BA7): 1.8 TDCi 06.2007/01.2015 92KW 125CV 1753CC - FORD MONDEO IV Turnier (BA7): 1.8 TDCi 06.2007/12.2012 92KW 125CV 1753CC</p> <p>210x112x165mm 2f-d13mm 1f-d20mm</p>		<p><b>A2460</b> NO. 1377259 - 1381836 - 1406414 - 1441597 - 1734710 - 1761001 - 5183155 - AG913K155BAB</p> <p><b>APOIO SUPORTE AMORTECEDOR FRENTE ( GASTA 2 UNIDADES )</b></p> <p>FORD MONDEO IV (BA7) 1.6 EcoBoost 02.2011/01.2015 118KW 160CV 1596CC JTBB JTBA 8566AWY - FORD MONDEO IV (BA7) 1.6 TDCi 02.2011/01.2015 85KW 115CV 1560CC T1BC T1BB T1BA 8566AXJ - FORD MONDEO IV (BA7) 1.6 Ti 03.2007/01.2015 81KW 110CV 1596CC RHBA 8566ALE - FORD MONDEO IV (BA7) 1.6 Ti 03.2007/01.2015 92KW 125CV 1596CC PNBA 8566ALK - FORD MONDEO IV (BA7) 1.6 Ti 07.2010/01.2015 88KW 120CV 1596CC KGBA 8...</p> <p>168x149x48mm 1f-d12mm 3r-d6mm 3f-d8mm</p>
	<p><b>A2460</b> NO. 1377259 - 1381836 - 1406414 - 1441597 - 1734710 - 1761001 - 5183155 - AG913K155BAB</p> <p><b>APOIO SUPORTE AMORTECEDOR FRENTE ( GASTA 2 UNIDADES )</b></p> <p>FORD MONDEO V três volumes (CD) 2.0 Hybrid desde 09.2014 130KW 177CV 1999CC C20EDEF - FORD MONDEO V três volumes (CD) 2.0 Hybrid desde 09.2014 140KW 190CV 1999CC UACA UACC 8566BKG 8566BRN - FORD MONDEO V três volumes (CD) 2.0 Hybrid desde 01.2019 138KW 188CV 1999CC C20EDEF - FORD MONDEO V Turnier (CF) 2.0 Hybrid iVCT desde 01.2019 138KW 188CV 1999CC C20EDEF UACA 8566BQY 8566BRO</p> <p>168x149x48mm 1f-d12mm 3r-d6mm 3f-d8mm</p>		<p><b>A2546</b> NO. 1376871 - 1417258 - 1453215 - 1453239 - 6G91 6F012 EB - 6G91 6F012 EC - 6G91 6F012 ED - 6G91 6F012 E...</p> <p><b>APOIO DO MOTOR PARTE DA FRENTE LADO DIREITO</b></p> <p>FORD MONDEO IV (BA7) 2.0 TDCi (De 11.2007 Até 01.2015) 85kW 115cv 1997cm3 Hatchback - FORD MONDEO IV (BA7) 2.0 TDCi (De 03.2007 Até 01.2015) 96kW 130cv 1997cm3 Hatchback - FORD MONDEO IV (BA7) 2.0 TDCi (De 03.2007 Até 12.2014) 100kW 136cv 1997cm3 Hatchback - FORD MONDEO IV (BA7) 2.0 TDCi (De 03.2007 Até 01.2015) 103kW 140cv 1997cm3 Hatchback - FORD MONDEO IV (BA7) 2.0 TDCi (De 03.2010 Até 01.2015)...</p> <p>212x154x188mm 2f-d15mm 2f-d20mm</p>
	<p><b>C0231</b> NO. 6483712 - 91AB.16C618.AA</p> <p><b>BOTÃO DE AFINAÇÃO DE CAPOT</b></p> <p>FORD MONDEO (1992 A 2000)</p> <p>d27x44mm</p>		<p><b>D0037</b> NO. 1515117 - 1638947 - 6518778 - 83BG4684BA - 83BG4684BA - 88GG4684BA - GAF41</p> <p><b>CARDAN TRANSMISSÃO</b></p> <p>FORD MONDEO I (GBP) 1.6 i 16V (07.94 A 08.96) 88cv 1597cc Hatchback</p> <p>120x135x40x46mm 6f-12x12mm</p>
	<p><b>E0087</b> NO. 1117698 - 1219697 - 1S71.3B438.BA - 1S713B438AB - 01127646 - 1127646 - 1144374 - 1S713B438AC - 1S...</p> <p><b>ESTICADOR BARRA ESTABILIZADORA FRENTE ( GASTA 2 UNIDADES )</b></p> <p>FORD MONDEO I (GBP) 1.6 i 16V 02.1993/08.1996 66KW 90CV 1597CC L1F 0928831 - FORD MONDEO I (GBP) 1.6 i 16V 07.1994/08.1996 65KW 88CV 1597CC L1J 0928884 - FORD MONDEO I (GBP) 1.8 i 16V 02.1993/08.1996 85KW 115CV 1796CC RKA 0928833 - FORD MONDEO I (GBP) 1.8 i 16V 07.1994/08.1996 82KW 112CV 1796CC RKB 0928869 - FORD MONDEO I (GBP) 1.8 TD 06.1993/08.1996 65KW 88CV 1753CC RFN RFM 0928850 - FORD MONDEO ...</p> <p>285x35x35mm 2p-d10-25mm</p>		<p><b>E0103</b> NO. 1106269 - 5106965 - 5106995 - 6960036 - 93BB3B438CA - YS71.3B438.AB - YS713B438AA</p> <p><b>ESTICADOR DA BARRA ESTABILIZADORA DA FRENTE</b></p> <p>FORD MONDEO I TT (ATÉ 08-1996) - MONDEO II TT (09-1996 A 11-2000)</p> <p>265x26x26mm 2p-d10-30mm</p>
	<p><b>E0104</b> NO. 1022358 - 1035911 - 1039511 - 1054209 - 7230373 - 7365613 - 93BB5K566AG - 93BB5K566AH</p> <p><b>ESTICADOR DA BARRA ESTABILIZADORA DE TRÁS</b></p> <p>FORD MONDEO I TT (ATÉ 08-1996) - MONDEO II TT (09-1996 A 11-2000)</p> <p>120x32x22mm 1p-d10x45mm 1f-d10mm</p>		<p><b>E0105</b> NO. 1127646 - 1S71.3B438.AC - C2S3248</p> <p><b>ESTICADOR DA BARRA ESTABILIZADORA DA FRENTE</b></p> <p>FORD MONDEO III TT (APÓS 11-2000)</p> <p>290x36x36mm 2p-d10-28mm</p>
	<p><b>E0106</b> NO. 1117800 - 1127648 - 1S715C486AD</p> <p><b>ESTICADOR DA BARRA ESTABILIZADORA DA FRENTE</b></p> <p>FORD MONDEO III TT (APÓS 11-2000)</p> <p>290x40x40mm 2p-d10-23mm</p>		<p><b>E0137</b> NO. 6701505 - 6783835 - 6931610 - 7014210 - 93BB5K566AC</p> <p><b>ESTICADOR DA BARRA ESTABILIZADORA DE TRÁS</b></p> <p>FORD MONDEO I TT A 08-1996 - FORD MONDEO II TT (09-1996 A 11-2000)</p> <p>102x30x30mm 1p-d10-30mm 1f-d7mm</p>

	<p><b>E0157</b> NO. 1219697 - 1S713B438BA - C2S39552</p> <p>ESTICADOR DA BARRA ESTABILIZADORA</p> <p>FORD MONDEO (1993 A 1996)</p> <p>290x40x40mm 2p-d10-24mm</p>		<p><b>E0158</b> NO. 1130452 - 1S715C486BE</p> <p>ESTICADOR DA BARRA ESTABILIZADORA DE TRÁS</p> <p>FORD MONDEO (APÓS 2000)</p> <p>100x35x45x38mm 2p-d10-23mm</p>
	<p><b>E0258</b> NO. 1513343 - 1745924 - 1790310 - 1905043 - 8V51.3B438.BA - 8V51.3B438.BB - 8V513B438AB - D65134470</p> <p>ESTICADOR BARRA ESTABILIZADORA FRENTE ( GASTA 2 UNIDADES )</p> <p>FORD MONDEO III (B5Y): 1.8 16V 10.2000/03.2007 81KW 110CV 1798CC - FORD MONDEO III (B5Y): 1.8 16V 10.2000/03.2007 92KW 125CV 1798CC - FORD MONDEO III (B5Y): 2.0 16V 10.2000/03.2007 107KW 146CV 1999CC - FORD MONDEO III (B5Y): 2.5 V6 24V 10.2000/03.2007 125KW 170CV 2495CC - FORD MONDEO III (B5Y): 3.0 V6 24V 09.2004/03.2007 150KW 204CV 2967CC - FORD MONDEO III (B5Y): ST220 04.2002/03.2007 166KW 226CV...</p> <p>290x36x35mm 2p-d10x25mm</p>		<p><b>E0614-M</b> NO. 1376874 - 1387562 - 1434852 - 1376877 - 1387564 - 1434853 - 1486221 - 30680705 - 6G916P082AB - 6G916...</p> <p>ESTICADOR SUPORTE APOIO MOTOR TRAS</p> <p>FORD MONDEO IV (BA7) 1.6 EcoBoost 02.2011/01.2015 118KW 160CV 1596CC JTBB JTBA 8566AWY - FORD MONDEO IV (BA7) 1.6 Ti 03.2007/01.2015 81KW 110CV 1596CC RHBA 8566ALE - FORD MONDEO IV (BA7) 1.6 Ti 03.2007/01.2015 92KW 125CV 1596CC PNBA 8566ALK - FORD MONDEO IV (BA7) 1.6 Ti 07.2010/01.2015 88KW 120CV 1596CC KGBA 8566AUY - FORD MONDEO IV (BA7) 1.8 TDCi 03.2007/01.2015 74KW 100CV 1753CC FFBA 8566ALJ - F...</p> <p>170x91x45mm 2f-d12mm 1r-d10mm</p>
	<p><b>E1018</b> NO. 1027374 - 6831302 - 6866417 - 93B85A262F - 93B85A262G - 93B85A262GA</p> <p>ESTICADOR DE ESCAPE</p> <p>FORD MONDEO I (GBP): 1.6 i 16V 07.1994/08.1996 65KW 88CV 1597CC - FORD MONDEO I (GBP): 1.6 i 16V 02.1993/08.1996 66KW 90CV 1597CC - FORD MONDEO I (GBP): 1.8 i 16V 07.1994/08.1996 82KW 112CV 1796CC - FORD MONDEO I (GBP): 1.8 i 16V 02.1993/08.1996 85KW 115CV 1796CC - FORD MONDEO I (GBP): 1.8 i 16V 4x4 02.1993/08.1996 85KW 115CV 1796CC - FORD MONDEO I (GBP): 2.0 i 16V 12.1994/08.1996 97KW 132CV 1988...</p> <p>66x54x19mm</p>		<p><b>E80344BC</b> NO. 6567507 - 924F9740AA</p> <p>ESTICADOR BOMBA DE COMBUSTIVEL</p> <p>FORD MONDEO I (GBP) 1.6 i 16V 02.1993/08.1996 66KW 90CV 1597CC L1F 0928831 - FORD MONDEO I (GBP) 1.6 i 16V 07.1994/08.1996 65KW 88CV 1597CC L1J 0928884 - FORD MONDEO I (GBP) 1.8 i 16V 02.1993/08.1996 85KW 115CV 1796CC RKA 0928833 - FORD MONDEO I (GBP) 1.8 i 16V 07.1994/08.1996 82KW 112CV 1796CC RKB 0928869 - FORD MONDEO I (GBP) 1.8 i 16V 4x4 02.1993/08.1996 85KW 115CV 1796CC RKA - FORD MONDEO I (G...</p> <p>371x11x10mm</p>
	<p><b>E80344BC</b> NO. 6567507 - 924F9740AA</p> <p>ESTICADOR BOMBA DE COMBUSTIVEL</p> <p>FORD MONDEO II (BAP) 1.6 i 08.1996/09.2000 66KW 90CV 1597CC L1J 8566305 - FORD MONDEO II (BAP) 1.6 i 16V 05.1998/09.2000 70KW 95CV 1597CC L1L L1N L1Q 8566344 - FORD MONDEO II (BAP) 1.8 i 08.1996/09.2000 85KW 115CV 1796CC RKB RKJ RKF RKH RKK 8566306 - FORD MONDEO II (BAP) 1.8 TD 08.1996/09.2000 66KW 90CV 1753CC RFN 8566307 - FORD MONDEO II (BAP) 2.0 i 08.1996/09.2000 96KW 131CV 1988CC NGD NGB NGC N...</p> <p>371x11x10mm</p>		<p><b>E80344BC</b> NO. 6567507 - 924F9740AA</p> <p>ESTICADOR BOMBA DE COMBUSTIVEL</p> <p>FORD MONDEO II três volumes (BFP) 1.6 i 08.1996/09.2000 66KW 90CV 1597CC L1J 8566300 - FORD MONDEO II três volumes (BFP) 1.6 i 16V 05.1998/09.2000 70KW 95CV 1597CC L1L L1N L1Q 8566343 - FORD MONDEO II três volumes (BFP) 1.8 i 08.1996/09.2000 85KW 115CV 1796CC RKB RKJ RKF RKH RKK 8566301 - FORD MONDEO II três volumes (BFP) 1.8 TD 08.1996/09.2000 66KW 90CV 1753CC RFN 8566302 - FORD MONDEO II três vo...</p> <p>371x11x10mm</p>
	<p><b>E80344BC</b> NO. 6567507 - 924F9740AA</p> <p>ESTICADOR BOMBA DE COMBUSTIVEL</p> <p>FORD MONDEO III (B5Y) 1.8 16V 10.2000/03.2007 81KW 110CV 1798CC CGBB CGBA 8566AEG 8566410 - FORD MONDEO III (B5Y) 1.8 16V 10.2000/03.2007 92KW 125CV 1798CC CHBA CHBB 8566AEH 8566411 - FORD MONDEO III (B5Y) 1.8 SCI 06.2003/03.2007 96KW 130CV 1798CC CFBA 8566AEF 8566539 - FORD MONDEO III (B5Y) 2.0 16V 10.2000/03.2007 107KW 146CV 1999CC CJBB CJBBA 8566AEI 8566412 - FORD MONDEO III ...</p> <p>371x11x10mm</p>		<p><b>F1444-I</b> NO. 6676136 - 92TT3A331</p> <p>FOLE DA TRANSMISSÃO JUNTO À RODA</p> <p>FORD MONDEO I 2.0 - 2.5 (APÓS 2003)</p> <p>d104x92mm 1f-d87mm 1f-d23mm</p>
	<p><b>F1618-I</b> NO. 157C3K661AB - 3904122 - 4119193 - 6772173 - F6RC.3K661.AA</p> <p>FOLE DA DIRECÇÃO ASSISTIDA LADO DIREITO E ESQUERDO</p> <p>FORD MONDEO I (1993 A 1996 1.6i - 1.6i 16V - 1.8 TD - 1.8i - 1.8i 16V - 2.0i - 2.0i 16V - 2.0i 16V 4X4 - 2.5i 24V - 2.5i ST200 - MONDEO II (1996 A 2000 1.6i - 1.8i - 1.8 TD - 2.0i - 2.5i</p> <p>d58x215mm 1f-d55mm 1f-d15mm</p>		<p><b>F1659E-I</b> NO. 1016769 - 6757643 - 6757645 - 93BG3L537AB - 93BG3L537CB</p> <p>FOLE DA TRANSMISSÃO JUNTO À CAIXA</p> <p>FORD MONDEO 1.6i 16V - 1.8i 16V - 1.8i 16V 4X4 - 2.0i 16V - 2.0i 16V 4X4 - 2.5i 24V (93 A 96)</p> <p>d96x126mm 1f-d85mm 1f-d25mm</p>
	<p><b>F1705-I</b> NO. 1446290 - 1446293</p> <p>FOLE DA TRANSMISSÃO JUNTO À CAIXA</p> <p>FORD MONDEO IV (BA7) 2.5 03.2007/01.2015 162KW 220CV 2521CC HUBA 8566ALG - FORD MONDEO IV três volumes (BA7) 2.5 03.2007/01.2015 162KW 220CV 2521CC HUBA 8566AMC - FORD MONDEO IV Turnier (BA7) 2.5 03.2007 - 12.2012 162 220 2521 HUBA 8566AMD</p> <p>d107x110mm 1f-d97mm 1f-d29mm</p>		<p><b>F1834-T</b> NO. 1016768 - 6757646</p> <p>FOLE DA TRANSMISSÃO JUNTO À CAIXA</p> <p>FORD MONDEO I 1.6i 16V - 1.8i 16V - 1.8i 16V 4X4 - 1.8TD - 2.0i 16V - 2.0i 16V 4X4 - 2.5i 24V (1993 A 1996)</p> <p>d100x128mm 1f-d96mm 1f-d27mm</p>
	<p><b>F1835-T</b> NO. 1073937 - 3940332 - F8RZ3A331C</p> <p>FOLE DA TRANSMISSÃO JUNTO À RODA</p> <p>FORD MONDEO I 1.6i 16V - 1.8i 16V - 2.0i 16V - 2.0i 16V 4X4 - 2.5i 24V (1993 A 1996)</p> <p>d96x135mm 1f-d89mm 1f-d25mm</p>		<p><b>F1843-I</b> NO. 1361247 - 1363787 - 1S714A084BC - 1S714A084DB - 1S714A084EB - 1S7W3L537AA - 1S7W3L537AB - 4106...</p> <p>FOLE DA TRANSMISSÃO JUNTO À CAIXA</p> <p>FORD MONDEO III (APÓS 2000) 1.8i 16V - 2.0i16V - 2.5i V6 24V</p> <p>d94x100mm 1f-d83mm 1f-d28mm</p>

















	<p><b>F4021</b> NO. 3904122 - F33.3K661.AA - F6RC3K661AA</p> <p>FOLE DIREÇÃO ASSISTIDA ( GASTA 2 UNIDADES )</p> <p>FORD MONDEO 1.6i - 1.8i - 1.8TD - 2.0i - 2.5i (1993 A 2000)</p> <p>d62x210mm d58mm d51mm 1f-d53mm 1f-d16mm</p>		<p><b>F9011H-I</b> NO. 1061867 - 1119226 - 1119227 - 1306052 - 1349165 - 1355188 - 1360390 - 1363787 - 1447559 - 1447560 - ...</p> <p>FOLE DA TRANSMISSÃO JUNTO À RODA</p> <p>FORD MONDEO III (B5Y) 1.8 16V (De 10-2000 Até 03-2007) 92kW 125CV 1798cc Hatchback FORD MONDEO III (B5Y) 1.8 SCi (De 06-2003 Até 03-2007) 96kW 130CV 1798cc Hatchback FORD MONDEO III (B5Y) 2.0 16V (De 10-2000 Até 03-2007) 107kW 146CV 1999cc Hatchback FORD MONDEO III três volumes (B4Y) 1.8 16V (De 10-2000 Até 03-2007) 81kW 110CV 1798cc três volumes FORD MONDEO III três volumes (B4Y) 1.8 16V (De ...</p> <p>d95x109mm 1f-d31mm 1f-d79mm</p>
	<p><b>F9039H-I</b> NO. 1446300</p> <p>FOLE DO CARDAN LADO DA RODA</p> <p>FORD MONDEO IV 1.8 TDCi (FFBA) 100CV (APÓS 03-2007) - 1.8 TDCi (KHBA - QYBA) 125CV (APÓS 06-2007) - 2.0 (AOBA - AOBC - TBBA) 145CV (APÓS 03-2007) - 2.0 TDCi (AZBA) 130CV (APÓS 03-2007) - 2.0 TDCi (KLBA - LPBA - TYBA) 115CV (APÓS 11-2007) - 2.0 TDCi 8QXBA - QXBB - UFBA)</p> <p>d96x130mm 1f-d29mm 1f-d94mm</p>		<p><b>KF1705I</b> NO. 1446290 - 1446293</p> <p>KIT FOLE DA TRANSMISSÃO JUNTO À CAIXA</p> <p>FORD MONDEO IV (BA7) 2.5 03.2007/01.2015 162KW 220CV 2521CC HUBA 8566ALG - FORD MONDEO IV três volumes (BA7) 2.5 03.2007/01.2015 162KW 220CV 2521CC HUBA 8566AMC - FORD MONDEO IV Turnier (BA7) 2.5 03.2007/12.2012 162KW 220CV 2521CC HUBA 8566AMD</p> <p>d107x110mm 1f-d97mm 1f-d29mm</p>
	<p><b>KF1974-I</b> NO. 1446291 - 1446298 - 1459738 - 1459764 - 1459773 - 1460786</p> <p>KIT DE FOLE DO CARDAN JUNTO À CAIXA</p> <p>FORD MONDEO IV (BA7): 1.6 Ti 03.2007/01.2015 81KW 110CV 1596CC - FORD MONDEO IV (BA7): 1.6 Ti 07.2010/01.2015 88KW 120CV 1596CC - FORD MONDEO IV (BA7): 1.6 Ti 03.2007/01.2015 92KW 125CV 1596CC - FORD MONDEO IV (BA7): 1.6 EcoBoost 02.2011/01.2015 118KW 160CV 1596CC - FORD MONDEO IV (BA7): 1.8 TDCi 03.2007/01.2015 74KW 100CV 1753CC - FORD MONDEO IV (BA7): 1.8 TDCi 06.2007/01.2015 92KW 125CV 1753CC - ...</p> <p>d97x91mm 1f-d88mm 1f-d33mm</p>		<p><b>KF9000</b> NO. 1073937 - 3940332 - F8RZ3A331C</p> <p>KIT DE FOLE LADO DA RODA</p> <p>FORD MONDEO 1.6i - 1.8i - 2.0i - 2.5i (1993 A 1996)</p> <p>d95x135mm 1f-d92mm 1f-d25mm</p>
	<p><b>KF9001</b> NO. 1073933 - 6757617 - 6757618 - 93BG3A331CA - 98BX.4A084.AA</p> <p>KIT DO FOLE DO LADO DA RODA</p> <p>FORD MONDEO 1.6i - 1.8i - 1.8TD - 2.0i - 2.5i - (1993 A 1996)</p> <p>d103x140mm 1f-d87mm 1f-d17mm</p>		<p><b>KF9022</b> NO. 1023221 - 1061867 - 1073947 - 96BG3A331AA - 98BX4A084EA</p> <p>KIT DE FOLE DO LADO DA RODA</p> <p>FORD MONDEO II (BAP) 1.6i Hatchback (08-1996 A 09-2000) 90CV 1597CC - FORD MONDEO II (BAP) 1.6 i 16V Hatchback (05-1998 A 09-2000) 95CV 1597CC - FORD MONDEO II (BAP) 1.8i (08-1996 A 09-2000) 115CV 1796CC - FORD MONDEO II (BAP) 2.0i (08-1996 A 09-2000) 131</p> <p>d100x130mm 1f-d28mm 1f-d85mm</p>
	<p><b>L3042</b> NO. 6915411 - 6915411 - 93BB.5C493.AC</p> <p>CASQUILHO DA BARRA ESTABILIZADORA DE TRÁS (PONTAS)</p> <p>FORD MONDEO (1996 A 1998)</p> <p>d24x26mm 1f-d12mm</p>		<p><b>M6057</b> NO. 6692784 - 6797187 - 6993854</p> <p>JUNTA DE ESCAPE</p> <p>FORD MONDEO (1993 A 1996)</p> <p>132x75mm 1f-d61.3mm</p>
	<p><b>M6078</b> NO. 0004920081 - 0004920581 - 171228 - 179818 - 6827023 - 91516522 - 91537797 - 96033780 - 96038954 - 96...</p> <p>JUNTA DE ESCAPE</p> <p>FORD MONDEO TD (06-1993 A 08-1996)</p> <p>d81x14mm 1f-d65mm</p>		<p><b>P1026</b> NO. 6168375 - 89FB.2457.AA</p> <p>CAPA DE PEDAL TRAVÃO E EMBRAIAGEM</p> <p>FORD MONDEO I (GBP): 1.8 i 16V 07.1994/08.1996 82KW 112CV 1796CC - FORD MONDEO I (GBP): 1.8 i 16V 02.1993/08.1996 85KW 115CV 1796CC - FORD MONDEO I (GBP): 2.0 i 16V 02.1993/08.1996 100KW 136CV 1988CC - FORD MONDEO I (GBP): 1.8 TD 06.1993/08.1996 65KW 88CV 1753CC - FORD MONDEO I (GBP): 1.8 TD 10.1995/08.1996 66KW 90CV 1753CC - FORD MONDEO I três volumes (GBP): 1.8 i 16V 01.1994/08.1996 82KW 112CV 1...</p> <p>68x54x14mm</p>
	<p><b>P1048</b> NO. 1029040 - 1076899 - 6789917 - 94BB.7A624.AA - 94BB7A642AA - 97KB.2457.AB - 98AB.7A624.AA</p> <p>CAPA DE PEDAL DO TRAVÃO E EMBRAIAGEM</p> <p>FORD MONDEO I (GBP): 1.6 i 16V 07.1994/08.1996 65KW 88CV 1597CC - FORD MONDEO I (GBP): 1.6 i 16V 02.1993/08.1996 66KW 90CV 1597CC - FORD MONDEO I (GBP): 1.8 i 16V 07.1994/08.1996 82KW 112CV 1796CC - FORD MONDEO I (GBP): 1.8 i 16V 02.1993/08.1996 85KW 115CV 1796CC - FORD MONDEO I (GBP): 1.8 i 16V 4x4 02.1993/08.1996 85KW 115CV 1796CC - FORD MONDEO I (GBP): 2.0 i 16V 4x4 12.1994/08.1996 97KW 132CV 1...</p> <p>75x55x8mm</p>		<p><b>Q2013</b> NO. 1048510 - 1475481 - 1754892 - 6171239</p> <p>UNIÃO DO ESCAPE 60x64,5x90mm</p> <p>FORD MONDEO</p> <p>90x70x92mm 1f-d60mm</p>
	<p><b>R222452</b> NO. 1353884 - 1359243 - 1386843 - 1520173 - 3M5H9Y438AA - 3M5H9Y438AB - 3M5H9Y438AC - 3M5H9Y438AD</p> <p>TUBO DO RADIADOR LADO DA ADMISSÃO</p> <p>FORD MONDEO IV (BA7) 1.8 TDCi (03.2007 - 01.2015) 74kw 100cv 1753cm3 Hatchback FORD MONDEO IV (BA7) 1.8 TDCi (06.2007 - 01.2015) 92kw 125cv 1753cm3 Hatchback</p> <p>B350-15/18mm 41-17-52-180-77-48mm</p>		<p><b>R222452</b> NO. 1353884 - 1359243 - 1386843 - 1520173 - 3M5H9Y438AA - 3M5H9Y438AB - 3M5H9Y438AC - 3M5H9Y438AD</p> <p>TUBO DO RADIADOR LADO DA ADMISSÃO</p> <p>FORD MONDEO IV Turnier (BA7) 1.8 TDCi (03.2007 - 12.2012) 74kw 100cv 1753cm3 Combi FORD MONDEO IV Turnier (BA7) 1.8 TDCi (06.2007 - 12.2012) 92kw 125cv 1753cm3 Combi</p> <p>B350-15/18mm 41-17-52-180-77-48mm</p>

	<p><b>R222452</b> NO. 1353884 - 1359243 - 1386843 - 1520173 - 3M5H9Y438AA - 3M5H9Y438AB - 3M5H9Y438AC - 3M5H9Y438AD</p> <p>TUBO DO RADIADOR LADO DA ADMISSÃO</p> <p>FORD MONDEO IV três volumes (BA7) 1.8 TDCi (03.2007 - 01.2015) 74kw 100cv 1753cm3 três volumes FORD MONDEO IV três volumes (BA7) 1.8 TDCi (06.2007 - 01.2015) 92kw 125cv 1753cm3 três volumes</p> <p>B350-15/18mm 41-17-52-180-77-48mm</p>		<p><b>R224141</b> NO. 1222831 - 2S7Q6N696AA</p> <p>TUBO ADMISSÃO FILTRO DE AR</p> <p>FORD MONDEO III (B5Y) 2.0 TDCi (10.01 A 03.07) 130cv 1998cc Hatchback - FORD MONDEO III três volumes (B4Y) 2.0 TDCi (10.01 A 03.07) 130cv 1998cc três volumes - FORD MONDEO III Turnier (BWY) 2.0 TDCi (10.01 A 03.07) 130cv 1998cc Combi</p> <p>B340-38/50mm 70-60-140-90mm</p>
	<p><b>R225074</b> NO. 1697700 - AV616C700AD</p> <p>TUBO DO AR SOBREALIMENTAÇÃO</p> <p>FORD MONDEO IV (BA7) 2.0 TDCi (De 11.2007 Até 01.2015) 85kW 115cv 1997cm3 Hatchback - FORD MONDEO IV (BA7) 2.0 TDCi (De 03.2007 Até 01.2015) 96kW 130cv 1997cm3 Hatchback - FORD MONDEO IV (BA7) 2.0 TDCi (De 03.2007 Até 12.2014) 100kW 136cv 1997cm3 Hatchback - FORD MONDEO IV (BA7) 2.0 TDCi (De 03.2007 Até 01.2015) 103kW 140cv 1997cm3 Hatchback - FORD MONDEO IV (BA7) 2.0 TDCi (De 03.2010 Até 01.2015) 103kW 140cv 1997cm3 Hatchback - FORD MONDEO IV (BA7) 2.0 TDCi (De 03.2010 Até 01.2015)...</p> <p>B73-42/47mm 73mm</p>		<p><b>R225079</b> NO. 1697700 - AV616C700AD</p> <p>TUBO DO AR SOBREALIMENTAÇÃO</p> <p>FORD MONDEO IV (BA7) 2.0 TDCi (De 11.2007 Até 01.2015) 85kW 115cv 1997cm3 Hatchback - FORD MONDEO IV (BA7) 2.0 TDCi (De 03.2007 Até 01.2015) 96kW 130cv 1997cm3 Hatchback - FORD MONDEO IV (BA7) 2.0 TDCi (De 03.2007 Até 12.2014) 100kW 136cv 1997cm3 Hatchback - FORD MONDEO IV (BA7) 2.0 TDCi (De 03.2007 Até 01.2015) 103kW 140cv 1997cm3 Hatchback - FORD MONDEO IV (BA7) 2.0 TDCi (De 03.2010 Até 01.2015) 103kW 140cv 1997cm3 Hatchback - FORD MONDEO IV (BA7) 2.0 TDCi (De 03.2010 Até 01.2015)...</p> <p>B136-48/49mm 73x58mm</p>
	<p><b>R225462</b> NO. 1303478 - 3M5Q6A646AA</p> <p>TUBO DO RADIADOR DO ÓLEO COM JUNTAS</p> <p>FORD MONDEO IV (BA7) 2.0 TDCi 03.2007/12.2014 100kW 136CV 1997CC AZBC UKBB UKBA 8566APX - FORD MONDEO IV (BA7) 2.0 TDCi 03.2007/01.2015 103kW 140CV 1997CC UFBB QXBB QXBA UFBA 8566ALH - FORD MONDEO IV (BA7) 2.0 TDCi 11.2007/01.2015 85KW 115CV 1997CC KLBA LPBA TYBA 8566AMN - FORD MONDEO IV (BA7) 2.0 TDCi 03.2010/01.2015 120KW 163CV 1997CC TXBB TXBA 8566ATC - FORD MONDEO IV três volumes (BA7) 2.0 TDCi...</p> <p>d81x4mm d27x3mm d72x4mm d22x9mm d11mm 1f-d19mm 1f-d14mm</p>		<p><b>R8200</b> NO. 1251783 - 1366216 - 1430644 - 4M5G-6758-FA - 4M5G-6758-HA - 6G9G-6758-AA</p> <p>TUBO DO RESPIRO DO CARTER DA CAMBOTA</p> <p>FORD MONDEO IV (BA7) 2.0 03.2007/01.2015 107KW 145CV 1999CC TBBA AOBBA AOBCC TBBA 8566ALI - FORD MONDEO IV (BA7) 2.0 EcoBoost 07.2010/01.2015 176KW 240CV 1999CC TPBA 8566AVE - FORD MONDEO IV (BA7) 2.0 Flexifuel 03.2009/01.2015 107KW 145CV 1999CC TBBA TBBA 8566AQZ - FORD MONDEO IV (BA7) 2.0 LPG 07.2009/01.2015 107KW 145CV 1999CC TBBA TBBA 8566AQS - FORD MONDEO IV (BA7) 2.0 SCTi 03.2010/01.2015 149KW ...</p> <p>B117-14/14mm 37-62-38mm</p>
	<p><b>RT08648</b> NO. 1025018 - 1071639</p> <p>TUBO DE TRAVÃO TRÁS LH-RH</p> <p>FORD GALAXI 1.8 TDCi (APÓS 05-2006) - GALAXI 2.0 (APÓS 05-2006) - GALAXI 2.0 TDCi (APÓS 05-2006) - GALAXY 2.2 TDCi (APÓS 03-2008) - GALAXI 2.3 (APÓS 07-2007)</p> <p>ponteira-1MC11ponteira-2M045580mm</p>		<p><b>RT08648</b> NO. 1025018 - 1071639</p> <p>TUBO DE TRAVÃO TRÁS LH-RH</p> <p>FORD MONDEO II 1.6i (09-1996 A 11-2000) - MONDEO II 1.6 i 16V (05-1998 A 11-2000) - MONDEO II 1.8 i (09-1996 A 11-2000) - MONDEO II 1.8 TD (09-1996 A 11-2000) - MONDEO II 2.0 i (09-1996 A 11-2000) - MONDEO II 2.5 24V (09-1996 A 11-2000)</p> <p>ponteira-1MC11ponteira-2M045580mm</p>
	<p><b>RT08648</b> NO. 1025018 - 1071639</p> <p>TUBO DE TRAVÃO TRÁS LH-RH</p> <p>FORD MONDEO II TRE VOLUMI 1.8i (09-1996 A 11-2000) - MONDEO II TRE VOLUMI 2.0i (09-1996 A 11-2000) - MONDEO II TRE VOLUMI 2.5 24V (09-1996 A 11-2000) - MONDEO II TRE VOLUMI 2.5 ST 200 (05-1999 A 11-2000)</p> <p>ponteira-1MC11ponteira-2M045580mm</p>		<p><b>RT08649</b> NO. 6922621 - 93BB2282DD</p> <p>TUBO DE TRAVÃO TRÁS LH-RH</p> <p>FORD MONDEO I 1.8i 16V (02-1993 A 08-1996) - MONDEO I 1.8i 16V 4X4 (02-1993 A 08-1996) - MONDEO I 1.8 TD (06-1993 A 08-1996) - MONDEO I 2.5i 24V (07-1994 A 08-1996) - MONDEO I TRE VOLUMI 2.0i 16V (02-1993 A 08-1996) - MONDEO I TRE VOLUMI 2.0i 16V 4X4 (12-</p> <p>325mm FB42 - OR20</p>
	<p><b>RT08649</b> NO. 6922621 - 93BB2282DD</p> <p>TUBO DE TRAVÃO TRÁS LH-RH</p> <p>FORD MONDEO I STATION WAGON 2.0i 16V (01-1993 A 08-1996) - MONDEO I STATION WAGON 2.0i 16V 4X4 (04-1993 A 08-1996) - MONDEO I STATION WAGON 2.5i 24V (07-1994 A 08-1996)</p> <p>325mm FB42 - OR20</p>		<p><b>RT08649</b> NO. 6922621 - 93BB2282DD</p> <p>TUBO DE TRAVÃO TRÁS LH-RH</p> <p>FORD MONDEO II STATION WAGON 1.6i (09-1996 A 11-2000) - MONDEO II STATION WAGON 1.6i 16V (05-1998 A 11-2000) - MONDEO II STATION WAGON 1.8i (09-1996 A 11-2000) - MONDEO II STATION WAGON 1.8 TD (09-1996 A 11-2000)</p> <p>325mm FB42 - OR20</p>
	<p><b>RT08649</b> NO. 6922621 - 93BB2282DD</p> <p>TUBO DE TRAVÃO TRÁS LH-RH</p> <p>FORD MONDEO II STATION WAGON 2.0i (09-1996 A 11-2000) - MONDEO II STATION WAGON 2.5 24V (09-1996 A 11-2000) - MONDEO II STATION WAGON 2.5 ST 200 (05-1999 A 11-2000)</p> <p>325mm FB42 - OR20</p>		<p><b>RT08686</b> NO. 6758587 - 93BB2282CA</p> <p>TUBO DE TRAVÃO TRÁS LH-RH</p> <p>FORD MONDEO I STATION WAGON 1.6i 16V (04-1993 A 08-1996) - MONDEO I STATION WAGON 1.8i 16V (04-1993 A 08-1996) - MONDEO I STATION WAGON 1.8i 16V 4X4 (04-1993 A 08-1996) - MONDEO I STATION WAGON 1.8 TD (06-1993 A 08-1996) - MONDEO I STATION WAGON 2.0i 16V</p> <p>345mm FB42 - MCL</p>
	<p><b>RT08686</b> NO. 6758587 - 93BB2282CA</p> <p>TUBO DE TRAVÃO TRÁS LH-RH</p> <p>FORD MONDEO I STATION WAGON 1.6i 16V (04-1993 A 08-1996) - MONDEO I STATION WAGON 1.8i 16V (04-1993 A 08-1996) - MONDEO I STATION WAGON 1.8i 16V 4X4 (04-1993 A 08-1996) - MONDEO I STATION WAGON 1.8 TD (06-1993 A 08-1996)</p> <p>345mm FB42 - MCL</p>		<p><b>RT08686</b> NO. 6758587 - 93BB2282CA</p> <p>TUBO DE TRAVÃO TRÁS LH-RH</p> <p>FORD MONDEO II STATION WAGON 1.6i (09-1996 A 11-2000) - MONDEO II STATION WAGON 1.6i 16V (05-1998 A 11-2000) - MONDEO II STATION WAGON 1.8i (09-1996 A 11-2000) - MONDEO II STATION WAGON 1.8TD (09-1996 A 11-2000) - MONDEO II STATION WAGON 2.0i (09-1996 A 11-2000)</p> <p>345mm FB42 - MCL</p>

 <p>FB42 MCL Component / Componente</p>	<p><b>RT08686</b> NO. 6758587 - 93BB2282CA</p> <p>TUBO DE TRAVÃO TRÁS LH-RH</p> <p>FORD MONDEO II STATION WAGON 1.6i (09-1996 A 11-2000) - MONDEO II STATION WAGON 1.6i 16V (05-1998 A 11-2000) - MONDEO II STATION WAGON 1.8i (09-1996 A 11-2000) - MONDEO II STATION WAGON 1.8 TD (09-1996 A 11-2000) - MONDEO II STATION WAGON 2.0i (09-1996 A 11-2000)</p> <p>345mm FB42 - MCL</p>	 <p>FB42 MC53 Component / Componente</p>	<p><b>RT08999</b> NO. 1114758 - 1117107 - 1121635 - 1444731</p> <p>TUBO DE TRAVÃO TRÁS LH-RH</p> <p>FORD MONDEO II STATION WAGON 2.5 24V (09-1996 A 11-2000) - MONDEO II STATION WAGON 2.5 ST 200 (05-1999 A 11-2000)</p> <p>310mm FB42 - MC53</p>
 <p>FB42 MC53 Component / Componente</p>	<p><b>RT08999</b> NO. 1114758 - 1117107 - 1121635 - 1444731</p> <p>TUBO DE TRAVÃO TRÁS LH-RH</p> <p>FORD MONDEO III 1.8 16V (11-2000 A 08-2007) - MONDEO III 1.8 SCi (06-2003 A 08-2007) - MONDEO III 2.0 16V (11-2000 A 08-2007) - MONDEO III 2.0 16V Di - TDDi - TDCi (11-2000 A 08-2007) - MONDEO III 2.0 16V TDDi - TDCi (11-2000 A 08-2007) - MONDEO III 2.0 T</p> <p>310mm FB42 - MC53</p>	 <p>FB42 MC53 Component / Componente</p>	<p><b>RT08999</b> NO. 1114758 - 1117107 - 1121635 - 1444731</p> <p>TUBO DE TRAVÃO TRÁS LH-RH</p> <p>FORD MONDEO III 2.2 TDCi (09-2004 A 08-2007) - MONDEO III 2.5 V6 24V (11-2000 A 08-2007) - MONDEO III 3.0 V6 24V (09-2004 A 08-2007) - MONDEO III ST220 (04-2002 A 08-2007) - MONDEO III STATION WAGON 1.8 16V (11-2000 A 08-2007) - MONDEO III STATION WAGON 1</p> <p>310mm FB42 - MC53</p>
 <p>FB42 MC53 Component / Componente</p>	<p><b>RT08999</b> NO. 1114758 - 1117107 - 1121635 - 1444731</p> <p>TUBO DE TRAVÃO TRÁS LH-RH</p> <p>FORD MONDEO III STATION WAGON 2.0 16V (11-2000 A 08-2007) - MONDEO III STATION WAGON 2.0 16V Di - TDDi - TDCi (11-2000 A 08-2007) - MONDEO III STATION WAGON 2.0 16V TDDi - TDCi (11-2000 A 08-2007) - MONDEO III STATION WAGON 2.0 TDCi (10-2001 A 08-2007)</p> <p>310mm FB42 - MC53</p>	 <p>FB42 MC53 Component / Componente</p>	<p><b>RT08999</b> NO. 1114758 - 1117107 - 1121635 - 1444731</p> <p>TUBO DE TRAVÃO TRÁS LH-RH</p> <p>FORD MONDEO III STATION WAGON 2.2 TDCi (09-2004 A 08-2007) - MONDEO III STATION WAGON 2.5 V6 24V (11-2000 A 08-2007) - MONDEO III STATION WAGON 3.0 V6 24V (09-2004 A 08-2007) - MONDEO III STATION WAGON ST220 (04-2002 A 08-2007)</p> <p>310mm FB42 - MC53</p>
 <p>FB42 MC53 Component / Componente</p>	<p><b>RT08999</b> NO. 1114758 - 1117107 - 1121635 - 1444731</p> <p>TUBO DE TRAVÃO TRÁS LH-RH</p> <p>FORD MONDEO III TRE VOLUMI 1.8 16V (11-2000 A 08-2007) - MONDEO III TRE VOLUMI 1.8 SCi (06-2003 A 08-2007) - MONDEO III TRE VOLUMI 2.0 16V (11-2000 A 08-2007) - MONDEO III TRE VOLUMI 2.0 16V Di - TDDi - TDCi (11-2000 A 08-2007) - MONDEO III TRE VOLUMI 2.</p> <p>310mm FB42 - MC53</p>	 <p>FB42 MC53 Component / Componente</p>	<p><b>RT08999</b> NO. 1114758 - 1117107 - 1121635 - 1444731</p> <p>TUBO DE TRAVÃO TRÁS LH-RH</p> <p>FORD MONDEO III TRE VOLUMI 2.0 TDCi (10-2001 A 08-2007) - MONDEO III TRE VOLUMI 2.2 TDCi (09-2004 A 08-2007) - MONDEO III TRE VOLUMI 2.5 V6 24V (11-2000 A 08-2007) - MONDEO III TRE VOLUMI 3.0 V6 24V (09-2004 A 08-2007) - MONDEO III TRE VOLUMI ST220 (04-2002 A 08-2007)</p> <p>310mm FB42 - MC53</p>
 <p>FB61 OR20 Component / Componente</p>	<p><b>RT80234</b> NO. 1051093 - 1071941</p> <p>TUBO DE TRAVÃO TRÁS LH-RH</p> <p>FORD MONDEO II 1.6i (09-1996 A 11-2000) - MONDEO II 1.6i 16V (05-1998 A 11-2000) - MONDEO II 1.8i (09-1996 A 11-2000) - MONDEO II 1.8 TD (09-1996 A 11-2000) - MONDEO II 2.0i (09-1996 A 11-2000) - MONDEO II 2.5 24V (09-1996 A 11-2000) - MONDEO II 2.5 ST 20</p> <p>340mm FB61 - OR20</p>	 <p>FB42 MC54 Component / Componente</p>	<p><b>RT80263</b> NO. 4510813</p> <p>TUBO DE TRAVÃO TRÁS LH-RH</p> <p>FORD TOURNEO CONNECT 1.8 16V (APÓS 06-2002) - TOURNEO CONNECT 1.8 Di (APÓS 06-2002) - TOURNEO CONNECT 1.8 TURBO Di (APÓS 06-2002)</p> <p>345mm FB42 - MC54</p>
 <p>MC45 MC55 Component / Componente</p>	<p><b>RT80307</b> NO. 1071939 - 91071939</p> <p>TUBO DE TRAVÃO TRÁS LH-RH</p> <p>FORD MONDEO I STATION WAGON 2.0i 16V 4X4 (04-1993 A 08-1996) - MONDEO I STATION WAGON 2.5i 24V (07-1994 A 08-1996)</p> <p>575mm MC45 - MC55</p>	 <p>MC45 MC55 Component / Componente</p>	<p><b>RT80307</b> NO. 1071939 - 91071939</p> <p>TUBO DE TRAVÃO TRÁS LH-RH</p> <p>FORD MONDEO II STATION WAGON 2.5 24V (10-1999 A 11-2000)</p> <p>575mm MC45 - MC55</p>
 <p>FB76 MC64 Component / Componente</p>	<p><b>RT80450</b> NO. 1379911 - 1671020</p> <p>TUBO DE TRAVÃO FRENTE LH-RH</p> <p>FORD MONDEO IV 1.6 Ti (APÓS 03-2007) - MONDEO IV 1.8 TDCi (APÓS 03-2007) - MONDEO IV 2.0 (APÓS 03-2007) - MONDEO IV 2.0 TDCi (APÓS 03-2007) - MONDEO IV 2.3 (APÓS 07-2007) - MONDEO IV 2.5 (APÓS 03-2007)</p> <p>420mm FB76 - MC64</p>		<p><b>S1131</b> NO. 6870549 - 93BB.3A262.BA</p> <p>SILENT-BLOC DA SUSPENSÃO DA FRENTE PARTE DE TRÁS</p> <p>FORD MONDEO 1.6 - 1.6i 16V - 1.8TD - 1.8i - 1.8i 16V - 2.0i - 2.0i 16V (1993 A 2000)</p> <p>d46x46mm c25mm 1f-d12mm</p>
	<p><b>S1178</b> NO. 6790115 - 93BB.3063.AA</p> <p>SILENT-BLOC DA SUSPENSÃO DA FRENTE PARTE DA FRENTE</p> <p>FORD MONDEO 1.6i - 1.6i 16V - 1.8TD - 1.8i - 1.8i 16V - 2.0i - 16V (1993 A 2000)</p> <p>d47x45.5mm c28mm 1f-d12mm</p>		<p><b>S1257</b> NO. 1023058 - 1074282 - 95BG.3A262.BA - 95BG3A262AA</p> <p>SILENT-BLOC DO BRAÇO DA SUSPENSÃO FRENTE PARTE DE TRÁS</p> <p>FORD MONDEO (APÓS 1996)</p> <p>d60x46mm c25mm 1f-d12mm</p>







	<p><b>T0640-I</b> NO. 1116577 - 1118919 - 1123541 - 1S713025AB - 1S713025AC - 1S713025AD - 1S7W3025AD - 2T143025AD - 44593</p> <p><b>BATENTE SUSPENSÃO DA FRENTE</b></p> <p>FORD MONDEO III (B5Y) 1.8 16V (10.00 A 03.07) 110cv 1798cc Hatchback - FORD MONDEO III (B5Y) 1.8 16V (10.00 A 03.07) 125cv 1798cc Hatchback - FORD MONDEO III (B5Y) 1.8 SCi (06.03 A 03.07) 130cv 1798cc Hatchback - FORD MONDEO III (B5Y) 2.0 16V (10.00 A 03.07) 146cv 1999cc Hatchback - FORD MONDEO III (B5Y) 2.5 V6 24V (10.00 A 03.07) 170cv 2495cc Hatchback - FORD MONDEO III (B5Y) 3.0 V6 24V (09....</p> <p>d69x69mm 1f-d28mm 1f-d28mm</p>		<p><b>T1044</b> NO. 1128725 - 6714195 - 93 5484AB - 93BB5484AB</p> <p><b>BATENTE DA BARRA ESTABILIZADORA CENTRO FRENTE</b></p> <p>FORD MONDEO (APÓS 1993)</p> <p>43x42x30mm 1f-d20mm</p>
	<p><b>T1051</b> NO. 6714195</p> <p><b>BATENTE DO CENTRO DA BARRA ESTABILIZADORA (FURO DIÂMETRO 20mm)</b></p> <p>FORD MONDEO 1.6i - 1.6i 16V - 1.8TD - 1.8i - 1.8i 16V - 2.0i - 16V - 2.5TD - 2.5 ST200 (1993 A 2000)</p> <p>43x39x30mm 1f-d20mm</p>		<p><b>T1090</b> NO. 1124418 - 1S71.4A037.DC</p> <p><b>BATENTE DA BARRA ESTABILIZADORA DE TRÁS</b></p> <p>FORD MONDEO III COMBI (BWY) 2.0 16V TDDi - 2.0 16V TDCi APÓS 11-2000 - MONDEO III TRÊS VOLUMES (B4Y) 1.8 16V - 2.0 16V - 2.0 16V Di - 2.0 16V TDDi - 2.0 16V TDCi - 2.5 V6 24V APÓS 11-2000 - 1.8 SCi APÓS 06-03 - 2.0 TDCi APÓS 10-2001 - ST 220 APÓS 04-02</p> <p>45x43x40mm 1f-d19mm</p>
	<p><b>T1091</b> NO. 1116602 - 1118695 - 1307891 - 1S71.5484.AD - 1S715484AC</p> <p><b>BATENTE DA BARRA ESTABILIZADORA DA FRENTE</b></p> <p>FORD MONDEO III(B5Y) 1.8 16V - 2.0 16V - 2.0 16V Di-TDDi-TDCi 2.5 V6 24V - APÓS 11-2000 - 1.8 SCi APÓS 06-03 - ST 220 APÓS 04-02 MONDEO III COMBI (BWY) 1.8 16V - 2.0 16V - 2.0 16V Di-TDDi-TDCi - 2.5 V6 24V APÓS 11-2000 - 1.8 SCi APÓS 06-03 - ST 220 APÓS 4</p> <p>46x47x40mm</p>		<p><b>T1264</b> NO. 1405532 - 1453257 - 1469020 - 1478582 - 6G9N5484GA - 6G9N5484GB - 6G9N5484UA - 6G9N5484UB</p> <p><b>BATENTE DA BARRA ESTABILIZADORA DA FRENTE</b></p> <p>FORD MONDEO I (GBP) 1.6 i 16V 02.1993/08.1996 66KW 90CV 1597CC L1F 0928831 - FORD MONDEO I (GBP) 1.6 i 16V 07.1994/08.1996 65KW 88CV 1597CC L1J 0928884 - FORD MONDEO I três volumes (GBP) 1.6 i 16V 02.1993/08.1996 66KW 90CV 1597CC L1F 0928832 1.6 i 16V 07.1994/08.1996 65KW 88CV 1597CC L1J 0928885 - FORD MONDEO II (BAP) 1.6 i 08.1996/09.2000 66KW 90CV 1597CC L1J 8566305 - FORD MONDEO II (BAP) 1.6 i ...</p> <p>52x46x47mm 1f-d22mm</p>
	<p><b>T1264</b> NO. 1405532 - 1453257 - 1469020 - 1478582 - 6G9N5484GA - 6G9N5484GB - 6G9N5484UA - 6G9N5484UB</p> <p><b>BATENTE DA BARRA ESTABILIZADORA DA FRENTE</b></p> <p>FORD MONDEO IV (BA7) 1.6 EcoBoost 02.2011/01.2015 118KW 160CV 1596CC JTBB JTBA 8566AWY - FORD MONDEO IV (BA7) 1.6 TDCi 02.2011/01.2015 85KW 115CV 1560CC T1BC T1BB T1BA 8566AXJ - FORD MONDEO IV (BA7) 1.6 Ti 03.2007/01.2015 81KW 110CV 1596CC RHBA 8566ALE - FORD MONDEO IV (BA7) 1.6 Ti 03.2007/01.2015 92KW 125CV 1596CC PNBA 8566ALK - FORD MONDEO IV (BA7) 1.6 Ti 07.2010/01.2015 88KW 120CV 1596CC KGBA 8...</p> <p>52x46x47mm 1f-d22mm</p>		<p><b>T1264</b> NO. 1405532 - 1453257 - 1469020 - 1478582 - 6G9N5484GA - 6G9N5484GB - 6G9N5484UA - 6G9N5484UB</p> <p><b>BATENTE DA BARRA ESTABILIZADORA DA FRENTE</b></p> <p>FORD MONDEO V três volumes (CD) 2.0 EcoBoost desde 05.2015 176KW 240CV 1999CC R9CH R9CF R9CB 8566BIW</p> <p>52x46x47mm 1f-d22mm</p>
	<p><b>U7033K</b> NO. 1212679 - 1212679 - 1332662 - 1474287 - 1S7C-3334-AA - 3M51-3334-AA</p> <p><b>ORINGS BOMBA DIREÇÃO ASSITIDA</b></p> <p>FORD MONDEO III (B5Y) 1.8 16V (10.2000 -03.2007) 81kw 110cv 1798cm3 Hatchback FORD MONDEO III (B5Y) 1.8 16V (10.2000 -03.2007) 92kw 125cv 1798cm3 Hatchback FORD MONDEO III (B5Y) 1.8 SCi (06.2003 -03.2007) 96kw 130cv 1798cm3 Hatchback FORD MONDEO III (B5Y) 2.0 16V (10.2000 -03.2007) 107kw 146cv 1999cm3 Hatchback FORD MONDEO III (B5Y) 2.0 16V Di / TDDi / TDCi (10.2000 -03.2007) 66kw 90cv 1998cm3 Ha...</p> <p>d11x2mm d10x2mm 1f-d7mm 1f-d6mm</p>		<p><b>U7033K</b> NO. 1212679 - 1212679 - 1332662 - 1474287 - 1S7C-3334-AA - 3M51-3334-AA</p> <p><b>ORINGS BOMBA DIREÇÃO ASSITIDA</b></p> <p>FORD MONDEO III Turnier (BWY) 1.8 16V (10.2000 -03.2007) 81kw 110cv 1798cm3 Combi FORD MONDEO III Turnier (BWY) 1.8 16V (10.2000 -03.2007) 92kw 125cv 1798cm3 Combi FORD MONDEO III Turnier (BWY) 1.8 SCi (06.2003 -03.2007) 96kw 130cv 1798cm3 Combi FORD MONDEO III Turnier (BWY) 2.0 16V (10.2000 -03.2007) 107kw 146cv 1999cm3 Combi FORD MONDEO III Turnier (BWY) 2.0 16V Di / TDDi / TDCi (10.2000 -03.20...</p> <p>d11x2mm d10x2mm 1f-d7mm 1f-d6mm</p>
	<p><b>U7033K</b> NO. 1212679 - 1212679 - 1332662 - 1474287 - 1S7C-3334-AA - 3M51-3334-AA</p> <p><b>ORINGS BOMBA DIREÇÃO ASSITIDA</b></p> <p>FORD MONDEO III três volumes (B4Y) 1.8 16V (10.2000 -03.2007) 81kw 110cv 1798cm3 três volumes FORD MONDEO III três volumes (B4Y) 1.8 16V (10.2000 -03.2007) 92kw 125cv 1798cm3 três volumes FORD MONDEO III três volumes (B4Y) 1.8 SCi (06.2003 -03.2007) 96kw 130cv 1798cm3 três volumes FORD MONDEO III três volumes (B4Y) 2.0 16V (10.2000 -03.2007) 107kw 146cv 1999cm3 três volumes FORD MONDEO III três v...</p> <p>d11x2mm d10x2mm 1f-d7mm 1f-d6mm</p>		<p><b>U7033K</b> NO. 1212679 - 1212679 - 1332662 - 1474287 - 1S7C-3334-AA - 3M51-3334-AA</p> <p><b>ORINGS BOMBA DIREÇÃO ASSITIDA</b></p> <p>FORD MONDEO IV (BA7) 1.6 EcoBoost (02.2011 -01.2015) 118kw 160cv 1596cm3 Hatchback FORD MONDEO IV (BA7) 1.6 TDCi (02.2011 -01.2015) 85kw 115cv 1560cm3 Hatchback FORD MONDEO IV (BA7) 1.6 Ti (03.2007 -01.2015) 81kw 110cv 1596cm3 Hatchback FORD MONDEO IV (BA7) 1.6 Ti (07.2010 -01.2015) 88kw 120cv 1596cm3 Hatchback FORD MONDEO IV (BA7) 1.6 Ti (03.2007 -01.2015) 92kw 125cv 1596cm3 Hatchback FORD MONDEO...</p> <p>d11x2mm d10x2mm 1f-d7mm 1f-d6mm</p>
	<p><b>U7033K</b> NO. 1212679 - 1212679 - 1332662 - 1474287 - 1S7C-3334-AA - 3M51-3334-AA</p> <p><b>ORINGS BOMBA DIREÇÃO ASSITIDA</b></p> <p>FORD MONDEO IV Turnier (BA7) 1.6 EcoBoost (02.2011 -01.2015) 118kw 160cv 1596cm3 Combi FORD MONDEO IV Turnier (BA7) 1.6 TDCi (02.2011 -01.2015) 85kw 115cv 1560cm3 Combi FORD MONDEO IV Turnier (BA7) 1.6 Ti (03.2007 -12.2012) 81kw 110cv 1596cm3 Combi FORD MONDEO IV Turnier (BA7) 1.6 Ti (07.2010 -01.2015) 88kw 120cv 1596cm3 Combi FORD MONDEO IV Turnier (BA7) 1.6 Ti (03.2007 -12.2010) 92kw 125cv 1596...</p> <p>d11x2mm d10x2mm 1f-d7mm 1f-d6mm</p>		<p><b>U7033K</b> NO. 1212679 - 1212679 - 1332662 - 1474287 - 1S7C-3334-AA - 3M51-3334-AA</p> <p><b>ORINGS BOMBA DIREÇÃO ASSITIDA</b></p> <p>FORD MONDEO IV três volumes (BA7) 1.6 EcoBoost (11.2010 -01.2015) 118kw 160cv 1596cm3 três volumes FORD MONDEO IV três volumes (BA7) 1.6 TDCi (12.2010 -01.2015) 85kw 115cv 1560cm3 três volumes FORD MONDEO IV três volumes (BA7) 1.6 Ti (03.2007 -01.2015) 81kw 110cv 1596cm3 três volumes FORD MONDEO IV três volumes (BA7) 1.6 Ti (03.2010 -01.2015) 88kw 120cv 1596cm3 três volumes FORD MONDEO IV três vo...</p> <p>d11x2mm d10x2mm 1f-d7mm 1f-d6mm</p>
	<p><b>UAP81292</b> NO. 1748294 - BG9Q9E568AA</p> <p><b>ANILHA PROTEÇÃO TÉRMICA INJECTORES</b></p> <p>FORD MONDEO IV (BA7) 2.2 TDCi (De 03-2008 Até 10-2010) 129kW 175CV 2179cc Hatchback FORD MONDEO IV (BA7) 2.2 TDCi (De 07-2010 Até 01-2015) 147kW 200CV 2179cc Hatchback FORD MONDEO IV três volumes (BA7) 2.2 TDCi (De 03-2008 Até 10-2010) 129kW 175CV 2179cc três volumes FORD MONDEO IV Turnier (BA7) 2.2 TDCi (De 03-2008 Até 10-2010) 129kW 175CV 2179cc Combi FORD MONDEO IV Turnier (BA7) 2.2 TDCi (D...</p> <p>d16x1mm 1f-d7mm</p>		<p><b>UAP81292</b> NO. 1748294 - BG9Q9E568AA</p> <p><b>ANILHA PROTEÇÃO TÉRMICA INJECTORES</b></p> <p>FORD MONDEO IV (BA7) 2.2 TDCi (De 03-2008 Até 10-2010) 129kW 175CV 2179cc Hatchback FORD MONDEO IV (BA7) 2.2 TDCi (De 07-2010 Até 01-2015) 147kW 200CV 2179cc Hatchback FORD MONDEO IV três volumes (BA7) 2.2 TDCi (De 03-2008 Até 10-2010) 129kW 175CV 2179cc três volumes FORD MONDEO IV Turnier (BA7) 2.2 TDCi (De 03-2008 Até 10-2010) 129kW 175CV 2179cc Combi FORD MONDEO IV Turnier (BA7) 2.2 TDCi (D...</p> <p>d16x1mm 1f-d7mm</p>

	<p><b>UAP81312</b> NO. 1715204 - 9M5Q9E568BA</p> <p>ANILHA DE PROTEÇÃO TÉRMICA INJECTORES</p> <p>FORD MONDEO IV (BA7) 2.0 TDCi (De 11.2007 Até 01.2015) 85kW 115cv 1997cm3 Hatchback - FORD MONDEO IV (BA7) 2.0 TDCi (De 03.2007 Até 01.2015) 96kW 130cv 1997cm3 Hatchback - FORD MONDEO IV (BA7) 2.0 TDCi (De 03.2007 Até 12.2014) 100kW 136cv 1997cm3 Hatchback - FORD MONDEO IV (BA7) 2.0 TDCi (De 03.2007 Até 01.2015) 103kW 140cv 1997cm3 Hatchback - FORD MONDEO IV (BA7) 2.0 TDCi (De 03.2010 Até 01.2015)...</p> <p>d14x1.5mm 1f-d7mm</p>		<p><b>UAP81313</b> NO. 1364301 - 4M5Q9M577AA</p> <p>ANILHA PROTEÇÃO TÉRMICA INJECTORES</p> <p>FORD MONDEO IV (BA7) 1.8 TDCi 03.2007/01.2015 74KW 100CV 1753CC FFBA 8566ALJ - FORD MONDEO IV (BA7) 1.8 TDCi 06.2007/01.2015 92KW 125CV 1753CC KHBA QYBA 8566ALL</p> <p>d13x2mm 1f-d7mm</p>
	<p><b>UAP83244</b> NO. 1230952 - 1432205 - 3M5QE568AA - M5Q9E568CA</p> <p>ANILHA PROTEÇÃO TÉRMICA INJECTORES</p> <p>FORD MONDEO V Hatchback (CE) 1.5 TDCi (De 03-2015 Até .1-20 -) 88kW 120CV 1499cc Hatchback FORD MONDEO V Hatchback (CE) 1.6 TDCi (De 09-2014 Até .1-20 -) 85kW 115CV 1560cc Hatchback FORD MONDEO V Turnier (CF) 1.5 TDCi (De 03-2015 Até .1-20 -) 88kW 120CV 1499cc Combi FORD MONDEO V Turnier (CF) 1.6 TDCi (De 09-2014 Até .1-20 -) 85kW 115CV 1560cc Combi</p> <p>d15x2mm 1f-d7mm</p>		<p><b>UAP83252</b> NO. 1700379 - AV6Q9E568AA</p> <p>ANILHA PROTEÇÃO TÉRMICA INJECTORES</p> <p>FORD MONDEO IV (BA7) 1.6 TDCi (02.2011 -01.2015) 85kw 115cv 1560cm3 Hatchback FORD MONDEO IV Turnier (BA7) 1.6 TDCi (02.2011 -01.2015) 85kw 115cv 1560cm3 Combi FORD MONDEO IV três volumes (BA7) 1.6 TDCi (12.2010 -01.2015) 85kw 115cv 1560cm3 três volumes</p> <p>d15x2mm 1f-d6mm</p>
	<p><b>UCRZ1080</b> NO. 1746601 - 1805656 - 97FG-3W007-AA</p> <p>CRUZETA VEIO TRANSMISSÃO TRIPOIDE D32MM/22 DENTES</p> <p>FORD MONDEO IV (BA7) 1.6 EcoBoost (De 02.2011 Até 01.2015) 118kW 160cv 1596cm3 Hatchback - FORD MONDEO IV (BA7) 1.6 Ti (De 03.2007 Até 01.2015) 81kW 110cv 1596cm3 Hatchback - FORD MONDEO IV (BA7) 1.6 Ti (De 07.2010 Até 01.2015) 88kW 120cv 1596cm3 Hatchback - FORD MONDEO IV (BA7) 1.6 Ti (De 03.2007 Até 01.2015) 92kW 125cv 1596cm3 Hatchback - FORD MONDEO IV Turnier (BA7) 1.6 EcoBoost (De 02.2011 Até...</p> <p>d30mm (22 dentes)</p>		<p><b>UCRZ1087</b> NO. 1046892 - 1214378 - 1214381 - 1236787 - 1355195 - 1355198 - 1358229 - 1365235</p> <p>CRUZETA VEIO TRANSMISSÃO TRIPOIDE D38,50MM/33 DENTES</p> <p>FORD MONDEO II (BAP) 2.5 24V (De 08.1996 Até 09.2000) 5819kW 125cv 170cm3 2544 - FORD MONDEO II (BAP) 2.5 ST 200 (De 05.1999 Até 09.2000) 11765kW 151cv 205cm3 2495 - FORD MONDEO II Turnier (BNP) 2.5 24V (De 10.1999 Até 09.2000) 15440kW 125cv 170cm3 2495 - FORD MONDEO II Turnier (BNP) 2.5 24V (De 08.1996 Até 09.2000) 5829kW 125cv 170cm3 2544 - FORD MONDEO II Turnier (BNP) 2.5 ST 200 (De 05.1999 Até...</p> <p>d38.5mm (33 dentes)</p>
	<p><b>UCRZ1087</b> NO. 1046892 - 1214378 - 1214381 - 1236787 - 1355195 - 1355198 - 1358229 - 1365235</p> <p>CRUZETA VEIO TRANSMISSÃO TRIPOIDE D38,50MM/33 DENTES</p> <p>FORD MONDEO III (B5Y) 1.8 16V (De 10.2000 Até 03.2007) 15482kW 81cv 110cm3 1798 - FORD MONDEO III (B5Y) 1.8 16V (De 10.2000 Até 03.2007) 15484kW 92cv 125cm3 1798 - FORD MONDEO III (B5Y) 1.8 SCl (De 06.2003 Até 03.2007) 17612kW 96cv 130cm3 1798 - FORD MONDEO III (B5Y) 2.0 16V (De 10.2000 Até 03.2007) 15486kW 107cv 146cm3 1999 - FORD MONDEO III (B5Y) 2.0 16V DI / TDi / TDCi (De 10.2000 Até 03.2007)...</p> <p>d38.5mm (33 dentes)</p>		<p><b>UCRZ1103</b> NO. 1504137 - 1504139 - 1505652 - 1505654 - 1600370 - 1600374 - 1727233 - 1727237 - 1757879 - 1774665 - ...</p> <p>CRUZETA TRANSMISSÃO TRIPOIDE D45MM/26 DENTES</p> <p>FORD MONDEO IV (BA7) 2.0 03.2007/01.2015 107KW 145CV 1999CC TBBA AOA AOB TBBA 8566ALJ - FORD MONDEO IV (BA7) 2.0 EcoBoost 07.2010/01.2015 176KW 240CV 1999CC TPBA 8566AVE - FORD MONDEO IV (BA7) 2.0 Flexifuel 03.2009/01.2015 107KW 145CV 1999CC TBBA TBBA 8566AQZ - FORD MONDEO IV (BA7) 2.0 LPG 07.2009/01.2015 107KW 145CV 1999CC TBBA TBBA 8566AQS - FORD MONDEO IV (BA7) 2.0 SCTi 03.2010/01.2015 149KW ...</p> <p>45mm 26 DENTES</p>
	<p><b>UMV25325</b> NO. 1580939 - AM8A6J-7J132-ABT</p> <p>MANETE PUNHO TOPO ALAVANCA MUDANÇAS 5 VELOCIDADES F14MM</p> <p>FORD MONDEO IV (BA7) 1.6 EcoBoost (De 02.2011 Até 01.2015) 118kW 160cv 1596cm3 Hatchback - FORD MONDEO IV (BA7) 1.6 TDCi (De 02.2011 Até 01.2015) 85kW 115cv 1560cm3 Hatchback - FORD MONDEO IV (BA7) 1.6 Ti (De 03.2007 Até 01.2015) 81kW 110cv 1596cm3 Hatchback - FORD MONDEO IV (BA7) 1.6 Ti (De 07.2010 Até 01.2015) 88kW 120cv 1596cm3 Hatchback - FORD MONDEO IV (BA7) 1.6 Ti (De 03.2007 Até 01.2015) 92kW 125cv 1596cm3 Hatchback - FORD MONDEO IV (BA7) 1.6 Ti (De 03.2007 Até 01.2015) 92...</p> <p>d46x90mm 1f-d14mm</p>		<p><b>UMV26813</b> NO. 1798600 - 7G9R7217CKD</p> <p>MANETE PUNHO TOPO ALAVANCA MUDANÇAS 6 VELOCIDADES F11/30MM</p> <p>FORD MONDEO IV (BA7): 1.6 Ti 03.2007/01.2015 81KW 110CV 1596CC - FORD MONDEO IV (BA7): 1.6 Ti 07.2010/01.2015 88KW 120CV 1596CC - FORD MONDEO IV (BA7): 1.6 Ti 03.2007/01.2015 92KW 125CV 1596CC - FORD MONDEO IV (BA7): 1.6 EcoBoost 02.2011/01.2015 118KW 160CV 1596CC - FORD MONDEO IV (BA7): 2.0 SCTi 03.2010/01.2015 149KW 203CV 1999CC - FORD MONDEO IV (BA7): 2.0 03.2007/01.2015 107KW 145CV 1999CC - FO...</p> <p>53x47x54mm 1f-d11/30mm</p>
	<p><b>UPCR5004</b> NO. 1454051 - 1567143 - 1678260</p> <p>PORCA DA RODA CHAVE 19 M12X1,50X30MM ( BASE CONICA )</p> <p>FORD MONDEO I (GBP) 1.6 i 16V (07.1994 -08.1996) 65kw 88cv 1597cm3 Hatchback FORD MONDEO I (GBP) 1.6 i 16V (02.1993 -08.1996) 66kw 90cv 1597cm3 Hatchback FORD MONDEO I (GBP) 1.8 TD (06.1993 -08.1996) 65kw 88cv 1753cm3 Hatchback FORD MONDEO I (GBP) 1.8 TD (10.1995 -08.1996) 66kw 90cv 1753cm3 Hatchback FORD MONDEO I (GBP) 1.8 i 16V (07.1994 -08.1996) 82kw 112cv 1796cm3 Hatchback FORD MONDEO I (GBP) ...</p> <p>d26x32mm M12x1,5mm</p>		<p><b>UPCR5004</b> NO. 1454051 - 1567143 - 1678260</p> <p>PORCA DA RODA CHAVE 19 M12X1,50X30MM ( BASE CONICA )</p> <p>FORD MONDEO I Turnier (BNP) 1.6 i 16V (07.1994 -08.1996) 65kw 88cv 1597cm3 Combi FORD MONDEO I Turnier (BNP) 1.6 i 16V (04.1993 -08.1996) 66kw 90cv 1597cm3 Combi FORD MONDEO I Turnier (BNP) 1.8 TD (06.1993 -08.1996) 65kw 88cv 1753cm3 Combi FORD MONDEO I Turnier (BNP) 1.8 TD (11.1995 -08.1996) 66kw 90cv 1753cm3 Combi FORD MONDEO I Turnier (BNP) 1.8 i 16V (07.1994 -08.1996) 82kw 112cv 1796cm3 Combi ...</p> <p>d26x32mm M12x1,5mm</p>
	<p><b>UPCR5004</b> NO. 1454051 - 1567143 - 1678260</p> <p>PORCA DA RODA CHAVE 19 M12X1,50X30MM ( BASE CONICA )</p> <p>FORD MONDEO I três volumes (GBP) 1.6 i 16V (07.1994 -08.1996) 65kw 88cv 1597cm3 três volumes FORD MONDEO I três volumes (GBP) 1.6 i 16V (02.1993 -08.1996) 66kw 90cv 1597cm3 três volumes FORD MONDEO I três volumes (GBP) 1.8 TD (06.1993 -08.1996) 65kw 88cv 1753cm3 três volumes FORD MONDEO I três volumes (GBP) 1.8 TD (10.1995 -08.1996) 66kw 90cv 1753cm3 três volumes FORD MONDEO I três volumes (GBP) 1...</p> <p>d26x32mm M12x1,5mm</p>		<p><b>UPCR5004</b> NO. 1454051 - 1567143 - 1678260</p> <p>PORCA DA RODA CHAVE 19 M12X1,50X30MM ( BASE CONICA )</p> <p>FORD MONDEO II (BAP) 1.6 i (08.1996 -09.2000) 66kw 90cv 1597cm3 Hatchback FORD MONDEO II (BAP) 1.6 i 16V (05.1998 -09.2000) 70kw 95cv 1597cm3 Hatchback FORD MONDEO II (BAP) 1.8 TD (08.1996 -09.2000) 66kw 90cv 1753cm3 Hatchback FORD MONDEO II (BAP) 1.8 i (08.1996 -09.2000) 85kw 115cv 1796cm3 Hatchback FORD MONDEO II (BAP) 2.0 i (08.1996 -09.2000) 96kw 131cv 1988cm3 Hatchback FORD MONDEO II (BAP) 2....</p> <p>d26x32mm M12x1,5mm</p>
	<p><b>UPCR5004</b> NO. 1454051 - 1567143 - 1678260</p> <p>PORCA DA RODA CHAVE 19 M12X1,50X30MM ( BASE CONICA )</p> <p>FORD MONDEO II Turnier (BNP) 1.6 i (08.1996 -09.2000) 66kw 90cv 1597cm3 Combi FORD MONDEO II Turnier (BNP) 1.6 i 16V (05.1998 -09.2000) 70kw 95cv 1597cm3 Combi FORD MONDEO II Turnier (BNP) 1.8 TD (08.1996 -09.2000) 66kw 90cv 1753cm3 Combi FORD MONDEO II Turnier (BNP) 1.8 i (08.1996 -09.2000) 85kw 115cv 1796cm3 Combi FORD MONDEO II Turnier (BNP) 2.0 i (08.1996 -09.2000) 96kw 131cv 1988cm3 Combi FOR...</p> <p>d26x32mm M12x1,5mm</p>		<p><b>UPCR5004</b> NO. 1454051 - 1567143 - 1678260</p> <p>PORCA DA RODA CHAVE 19 M12X1,50X30MM ( BASE CONICA )</p> <p>FORD MONDEO II três volumes (BFP) 1.6 i (08.1996 -09.2000) 66kw 90cv 1597cm3 três volumes FORD MONDEO II três volumes (BFP) 1.6 i 16V (05.1998 -09.2000) 70kw 95cv 1597cm3 três volumes FORD MONDEO II três volumes (BFP) 1.8 TD (08.1996 -09.2000) 66kw 90cv 1753cm3 três volumes FORD MONDEO II três volumes (BFP) 1.8 i (08.1996 -09.2000) 85kw 115cv 1796cm3 três volumes FORD MONDEO II três volumes (BFP) ...</p> <p>d26x32mm M12x1,5mm</p>



	<p><b>UPCR5019</b> NO. 1366029 - 1366432 - 1678260 - 2179620 - 5114407 - 6111766</p> <p><i>PORCA DA RODA CHAVE 19 M12X1,50X31MM ( BASE CONICA )</i></p> <p>FORD MONDEO III (B5Y) 1.8 16V (10.2000 -03.2007) 81kw 110cv 1798cm3 Hatchback FORD MONDEO III (B5Y) 1.8 16V (10.2000 -03.2007) 92kw 125cv 1798cm3 Hatchback FORD MONDEO III (B5Y) 1.8 SCi (06.2003 -03.2007) 96kw 130cv 1798cm3 Hatchback FORD MONDEO III (B5Y) 2.0 16V (10.2000 -03.2007) 107kw 146cv 1999cm3 Hatchback FORD MONDEO III (B5Y) 2.0 16V DI / TDDI / TDCi (10.2000 -03.2007) 66kw 90cv 1998cm3 Hat...</p> <p>d26x31mm M12x28mm</p>		<p><b>UPCR5019</b> NO. 1366029 - 1366432 - 1678260 - 2179620 - 5114407 - 6111766</p> <p><i>PORCA DA RODA CHAVE 19 M12X1,50X31MM ( BASE CONICA )</i></p> <p>FORD MONDEO IV (BA7) 1.6 EcoBoost (02.2011 -01.2015) 118kw 160cv 1596cm3 Hatchback FORD MONDEO IV (BA7) 1.6 TDCi (02.2011 -01.2015) 85kw 115cv 1560cm3 Hatchback FORD MONDEO IV (BA7) 1.6 Ti (03.2007 -01.2015) 81kw 110cv 1596cm3 Hatchback FORD MONDEO IV (BA7) 1.6 Ti (07.2010 -01.2015) 88kw 120cv 1596cm3 Hatchback FORD MONDEO IV (BA7) 1.6 Ti (03.2007 -01.2015) 92kw 125cv 1596cm3 Hatchback FORD MONDEO...</p> <p>d26x31mm M12x28mm</p>
	<p><b>UPCR5019</b> NO. 1366029 - 1366432 - 1678260 - 2179620 - 5114407 - 6111766</p> <p><i>PORCA DA RODA CHAVE 19 M12X1,50X31MM ( BASE CONICA )</i></p> <p>FORD MONDEO V Hatchback (CE) 1.0 EcoBoost (02.2015 -) 92kw 125cv 998cm3 Hatchback FORD MONDEO V Hatchback (CE) 1.5 TDCi (03.2015 -) 88kw 120cv 1499cm3 Hatchback FORD MONDEO V Hatchback (CE) 2.0 EcoBlue (01.2019 -) 88kw 120cv 1995cm3 Hatchback FORD MONDEO V Hatchback (CE) 2.0 EcoBlue (01.2019 -) 110kw 150cv 1995cm3 Hatchback FORD MONDEO V Hatchback (CE) 2.0 EcoBlue (01.2019 -) 140kw 190cv 1995cm3 H...</p> <p>d26x31mm M12x28mm</p>		<p><b>UTR0819</b> NO. 1000249 - 1025558 - 1049625 - 1078160 - 1230968 - 97888K218DA - 97888K218DB - 97888K218DC - 988881100</p> <p><i>TAMPÃO RESERVATÓRIO LIQUIDO REFRIGERAÇÃO</i></p> <p>FORD MONDEO I (GBP) 2.5 i 24V (07.94 A 08.96) 170cv 2544cc Hatchback - FORD MONDEO I três volumes (GBP) 2.5 i 24V (07.94 A 08.96) 170cv 2544cc três volumes - FORD MONDEO II (BAP) 1.6 i (08.96 A 09.00) 90cv 1597cc Hatchback - FORD MONDEO II (BAP) 1.6 i 16V (05.98 A 09.00) 95cv 1597cc Hatchback - FORD MONDEO II (BAP) 1.8 i (08.96 A 09.00) 115cv 1796cc Hatchback - FORD MONDEO II (BAP) 2.0 i ...</p> <p>62x37mm 1f-d52x12mm</p>
	<p><b>UTR0820</b> NO. 90352470 - 90409256 - 90409257 - 9041032690497472 - 90467473</p> <p><i>TAMPÃO RESERVATÓRIO LIQUIDO REFRIGERAÇÃO</i></p> <p>FORD MONDEO I (GBP) 1.6 i 16V (07.94 A 08.96) 88cv 1597cc Hatchback - FORD MONDEO I (GBP) 1.6 i 16V (02.93 A 08.96) 90cv 1597cc Hatchback - FORD MONDEO I (GBP) 1.8 i 16V (07.94 A 08.96) 112cv 1796cc Hatchback - FORD MONDEO I (GBP) 1.8 i 16V (02.93 A 08.96) 115cv 1796cc Hatchback - FORD MONDEO I (GBP) 1.8 i 16V 4x4 (02.93 A 08.96) 115cv 1796cc Hatchback - FORD MONDEO I (GBP) 2.0 i 16V 4x4...</p> <p>d62x23mm 1f-d53x12mm</p>		<p><b>UTR0847</b> NO. 1224233 - 1301104 - 3M5H8100AC</p> <p><i>TAMPÃO RESERVATÓRIO LIQUIDO REFRIGERAÇÃO</i></p> <p>FORD MONDEO IV (BA7) 1.6 Ti (03.07 A 01.15) 110cv 1596cc Hatchback - FORD MONDEO IV (BA7) 1.6 Ti (07.10 A 01.15) 120cv 1596cc Hatchback - FORD MONDEO IV (BA7) 1.6 Ti (03.07 A 01.15) 125cv 1596cc Hatchback - FORD MONDEO IV (BA7) 1.6 EcoBoost (02.11 A 01.15) 160cv 1596cc Hatchback - FORD MONDEO IV (BA7) 2.0 SCTi (03.10 A 01.15) 203cv 1999cc Hatchback - FORD MONDEO IV (BA7) 2.0 (03.07 A 01.15)...</p> <p>d62x35mm 1f-d50x16mm</p>
	<p><b>UTR0859</b> NO. 1650630 - 94539597 - 96293957 - 96312510 - 96351578 - 96420303 - 96536649</p> <p><i>TAMPÃO RESERVATÓRIO LIQUIDO REFRIGERAÇÃO</i></p> <p>FORD MONDEO I (GBP) 1.6 i 16V (07.94 A 08.96) 88cv 1597cc Hatchback - FORD MONDEO I (GBP) 1.6 i 16V (02.93 A 08.96) 90cv 1597cc Hatchback - FORD MONDEO I (GBP) 1.8 i 16V (07.94 A 08.96) 112cv 1796cc Hatchback - FORD MONDEO I (GBP) 1.8 i 16V (02.93 A 08.96) 115cv 1796cc Hatchback - FORD MONDEO I (GBP) 1.8 i 16V 4x4 (02.93 A 08.96) 115cv 1796cc Hatchback - FORD MONDEO I (GBP) 2.0 i 16V 4x4...</p> <p>d63x23mm 1f-d53x11mm</p>		<p><b>UTV83002</b> NO. 2S6Q6730AA</p> <p><i>TAMPÃO VEDAÇÃO BUJÃO</i></p> <p>FORD MONDEO IV (BA7) 1.6 TDCi (De 02-2011 Até 01-2015) 85kW 115CV 1560cc Hatchback FORD MONDEO IV três volumes (BA7) 1.6 TDCi (De 12-2010 Até 01-2015) 85kW 115CV 1560cc três volumes FORD MONDEO IV Turnier (BA7) 1.6 TDCi (De 02-2011 Até 01-2015) 85kW 115CV 1560cc Combi</p> <p>20x18mm c13mm d10mm</p>
	<p><b>UTV83010</b> NO. 1013938 - 97JM6730BA</p> <p><i>TAMPÃO VEDAÇÃO BUJÃO</i></p> <p>FORD MONDEO II (BAP) 1.6 i (De 08-1996 Até 09-2000) 66kW 90CV 1597cc Hatchback FORD MONDEO II (BAP) 1.6 i 16V (De 05-1998 Até 09-2000) 70kW 95CV 1597cc Hatchback FORD MONDEO II (BAP) 1.8 i (De 08-1996 Até 09-2000) 85kW 115CV 1796cc Hatchback FORD MONDEO II (BAP) 2.0 i (De 08-1996 Até 09-2000) 96kW 131CV 1988cc Hatchback FORD MONDEO II (BAP) 1.8 TD (De 08-1996 Até 09-2000) 66kW 90CV 1753cc Hatchbac...</p> <p>d28x35mm c19mm d13mm</p>		<p><b>UTV83010</b> NO. 1013938 - 97JM6730BA</p> <p><i>TAMPÃO VEDAÇÃO BUJÃO</i></p> <p>FORD MONDEO III (B5Y) 1.8 16V (De 10-2000 Até 03-2007) 81kW 110CV 1798cc Hatchback FORD MONDEO III (B5Y) 1.8 16V (De 10-2000 Até 03-2007) 92kW 125CV 1798cc Hatchback FORD MONDEO III (B5Y) 1.8 SCi (De 06-2003 Até 03-2007) 96kW 130CV 1798cc Hatchback FORD MONDEO III (B5Y) 2.0 16V (De 10-2000 Até 03-2007) 107kW 146CV 1999cc Hatchback FORD MONDEO III (B5Y) 2.0 16V DI / TDDI / TDCi (De 10-2000 Até ...</p> <p>d28x35mm c19mm d13mm</p>
	<p><b>UTV83010</b> NO. 1013938 - 97JM6730BA</p> <p><i>TAMPÃO VEDAÇÃO BUJÃO</i></p> <p>FORD MONDEO IV (BA7) 1.6 Ti (De 03-2007 Até 01-2015) 81kW 110CV 1596cc Hatchback FORD MONDEO IV (BA7) 1.6 Ti (De 03-2007 Até 01-2015) 92kW 125CV 1596cc Hatchback FORD MONDEO IV (BA7) 2.0 SCTi (De 03-2010 Até 01-2015) 149kW 203CV 1999cc Hatchback FORD MONDEO IV (BA7) 2.0 (De 03-2007 Até 01-2015) 107kW 145CV 1999cc Hatchback FORD MONDEO IV (BA7) 2.0 Flexifuel (De 03-2009 Até 01-2015) 107kW 145CV...</p> <p>d28x35mm c19mm d13mm</p>		<p><b>UTV83012</b> NO. 1457117 - 1657022 - 1663906 - 6093527 - 6186775 - 6732529 - 70TM6730AA - 89FF6730AA</p> <p><i>TAMPÃO VEDAÇÃO BUJÃO</i></p> <p>FORD MONDEO I (GBP) 1.8 TD (De 06-1993 Até 08-1996) 65kW 88CV 1753cc Hatchback FORD MONDEO I três volumes (GBP) 1.8 TD (De 06-1993 Até 08-1996) 65kW 88CV 1753cc três volumes FORD MONDEO I três volumes (GBP) 1.8 TD (De 10-1995 Até 08-1996) 66kW 90CV 1753cc três volumes FORD MONDEO I Turnier (BNP) 1.8 TD (De 06-1993 Até 08-1996) 65kW 88CV 1753cc Combi FORD MONDEO I Turnier (BNP) 1.8 TD (De 11-19...</p> <p>d23x26mm c15mm d13mm</p>
	<p><b>W5016</b> NO. 1231959 - 1490842 - 1520590 - 1683820 - 1837783 - 3MSQ-6B319-AA - 7MSQ-6B319-AA - 7MSQ-6B319-AB - 9M...</p> <p><i>POLIE DA CAMBOTA (6 pistas)</i></p> <p>FORD MONDEO IV (BA7) 2.0 TDCi 03.2007/01.2015 96KW 130CV 1997CC AZBA 8566ALF - FORD MONDEO IV (BA7) 2.0 TDCi 03.2007/12.2014 100KW 136CV 1997CC AZCB UKBB UKBA 8566APX - FORD MONDEO IV (BA7) 2.0 TDCi 03.2007/01.2015 103KW 140CV 1997CC UFBB QXBB QXBA UFBA 8566ALH - FORD MONDEO IV (BA7) 2.0 TDCi 11.2007/01.2015 85KW 115CV 1997CC KLBA LPBA TYBA 8566AMN - FORD MONDEO IV (BA7) 2.0 TDCi 03.2010/01.2015 1...</p> <p>d152.5mm d16mm</p>		<p><b>W5026</b> NO. 1038330 - 1135052 - 1250444 - 2610525 - 6599021 - 928M6B320DB - 928M6B320DD - 928M6B320DE - 928M6B3...</p> <p><i>POLIE CAMBOTA (6 PISTAS)</i></p> <p>FORD MONDEO I (GBP): 1.6 i 16V 07.1994/08.1996 65KW 88CV 1597CC - FORD MONDEO I (GBP): 1.6 i 16V 02.1993/08.1996 66KW 90CV 1597CC - FORD MONDEO I (GBP): 1.8 i 16V 07.1994/08.1996 82KW 112CV 1796CC - FORD MONDEO I (GBP): 1.8 i 16V 02.1993/08.1996 85KW 115CV 1796CC - FORD MONDEO I (GBP): 2.0 i 16V 4x4 12.1994/08.1996 97KW 132CV 1988CC - FORD MONDEO I (GBP): 2.0 i 16V 02.1993/08.1996 100KW 136CV 1988...</p> <p>d131.3mm d28mm</p>
	<p><b>W5035</b> NO. 1135052</p> <p><i>POLIE DA CAMBOTA (6 PISTAS)</i></p> <p>FORD MONDEO 1.6i - 1.8i - 2.0i (APÓS 2000)</p> <p>d132mm d28mm</p>		<p><b>W5081</b> NO. 1079166 - 1104415 - 1139286 - 1143413 - 1151392 - 1S4Q6A345AA - 1S4Q6B318AE - 1S4Q6B319AE - 1S4Q6B31...</p> <p><i>POLIE DA CAMBOTA (6 PISTAS)</i></p> <p>FORD MONDEO IV (BA7) 1.8 TDCi 03.2007/01.2015 74KW 100CV 1753CC FFBA 8566ALJ - FORD MONDEO IV (BA7) 1.8 TDCi 06.2007/01.2015 92KW 125CV 1753CC KHBA QYBA 8566ALL - FORD MONDEO IV Turnier (BA7) 1.8 TDCi 03.2007 - 12.2012 74 100 1753 FFBA 8566ALP</p> <p>d140/153mm d14.6mm</p>

	<p><b>W5090</b> NO. 1124891 - 1151394 - 1226637 - 1226638 - 1315530 - 1329203 - 1329205 - 1349993 - 1351731 - 1...</p> <p>POLIE DA CAMBOTA (6 PISTAS)</p> <p>FORD MONDEO III 2.0 TDCI MOTOR D5BA 90CV (APÓS 11-2000) - 2.0 TDCI MOTOR D6BA 115CV (APÓS 11-2000)</p> <p>d160mm d5mm</p>	<p><b>W5090</b> NO. 1124891 - 1151394 - 1226637 - 1226638 - 1315530 - 1329203 - 1329205 - 1349993 - 1351731 - 1...</p> <p>POLIE DA CAMBOTA (6 PISTAS)</p> <p>FORD MONDEO III APÓS 11-2000 MOTOR (D5BA) 2.0 TDCI (90CV) - MOTOR (D6BA) APÓS 11-2000 2.0 TDCI (115CV) - TRANSIT MODELO 2000 MOTOR (ABFA - D3FA) 2.0 DI</p> <p>d160mm d5mm</p>
	<p><b>W5165</b> NO. 1539704 - 1752282 - 8A6G6B321AB - 8A6G6B321AC</p> <p>POLIE DA CAMBOTA (6 PISTAS)</p> <p>FORD MONDEO IV (BA7) 1.6 Ti (De 03-2007 Até 01-2015) 81kW 110CV 1596cc Hatchback FORD MONDEO IV (BA7) 1.6 Ti (De 07-2010 Até 01-2015) 88kW 120CV 1596cc Hatchback FORD MONDEO IV (BA7) 1.6 Ti (De 03-2007 Até 01-2015) 92kW 125CV 1596cc Hatchback FORD MONDEO IV três volumes (BA7) 1.6 Ti (De 03-2010 Até 01-2015) 88kW 120CV 1596cc três volumes FORD MONDEO IV três volumes (BA7) 1.6 Ti (De 03-2007 Até...</p> <p>d138mm d25mm</p>	<p><b>W5177</b> NO. 1305988 - 1490906 - 1753154 - 4M5G-6B32-1ZA - 4M5G-6B32-1ZB - 4M5G-6B321-ZC</p> <p>POLIE DA CAMBOTA (5 + 6 PISTAS)</p> <p>FORD MONDEO IV (BA7): 1.6 Ti 03.2007/01.2015 81KW 110CV 1596CC - FORD MONDEO IV (BA7): 1.6 Ti 07.2010 - 01.2015 88KW 120CV 1596CC - FORD MONDEO IV (BA7): 1.6 Ti 03.2007/01.2015 92KW 125CV 1596CC - FORD MONDEO IV três volumes (BA7): 1.6 Ti 03.2007/01.2015 81KW 110CV 1596CC - FORD MONDEO IV três volumes (BA7): 1.6 Ti 03.2010/01.2015 88KW 120CV 1596CC - FORD MONDEO IV três volumes (BA7): 1.6 Ti 03.20...</p> <p>d138mm d24mm</p>
	<p><b>W5180</b> NO. 1682158 - 31460551 - 5087792 - 5348415 - AG9E6B319AA - AG9E6B319AB - AG9E6B319AC - AG9E6B319AD</p> <p>POLIE DA CAMBOTA (6 PISTAS)</p> <p>FORD MONDEO IV (BA7): 2.0 SCTi 03.2010/01.2015 149KW 203CV 1999CC - FORD MONDEO IV (BA7): 2.0 EcoBoost 07.2010/01.2015 176KW 240CV 1999CC - FORD MONDEO IV Turnier (BA7): 2.0 SCTi 03.2010/01.2015 149KW 203CV 1999CC - FORD MONDEO IV Turnier (BA7): 2.0 EcoBoost 07.2010/01.2015 176KW 240CV 1999CC</p> <p>d162/153mm d46mm</p>	<p><b>W5206</b> NO. 6767897 - 93FF6B319AB</p> <p>POLIE DA CAMBOTA (5+5 PISTAS)</p> <p>FORD MONDEO I (GBP): 1.8 TD 06.1993/08.1996 65KW 88CV 1753CC - FORD MONDEO I (GBP): 1.8 TD 10.1995/08.1996 66KW 90CV 1753CC - FORD MONDEO I três volumes (GBP): 1.8 TD 06.1993/08.1996 65KW 88CV 1753CC - FORD MONDEO I três volumes (GBP): 1.8 TD 10.1995/08.1996 66KW 90CV 1753CC - FORD MONDEO I Turnier (BNP): 1.8 TD 06.1993/08.1996 65KW 88CV 1753CC - FORD MONDEO I Turnier (BNP): 1.8 TD 11.1995/08.1996...</p> <p>d136mm d41/91,5mm 4f-d9mm 4f-d11mm</p>
	<p><b>W5206</b> NO. 6767897 - 93FF6B319AB</p> <p>POLIE DA CAMBOTA (5+5 PISTAS)</p> <p>FORD MONDEO II (BAP): 1.8 TD 08.1996/09.2000 66KW 90CV 1753CC - FORD MONDEO II três volumes (BFP): 1.8 TD 08.1996/09.2000 66KW 90CV 1753CC - FORD MONDEO II Turnier (BNP): 1.8 TD 08.1996/09.2000 66KW 90CV 1753CC</p> <p>d136mm d41/91,5mm 4f-d9mm 4f-d11mm</p>	<p><b>Y3233</b> NO. 1473166 - 1481984 - 3395499 - 4432023 - 6586309 - 6789185</p> <p>PARAFUSO DA RODA CAVILHA M12X1,50X48MM</p> <p>FORD MONDEO II (BAP) 1.6 i (08.1996 - 09.2000) 66kw 90cv 1597cm3 Hatchback FORD MONDEO II (BAP) 1.6 i 16V (05.1998 - 09.2000) 70kw 95cv 1597cm3 Hatchback FORD MONDEO II (BAP) 1.8 TD (08.1996 - 09.2000) 66kw 90cv 1753cm3 Hatchback FORD MONDEO II (BAP) 1.8 i (08.1996 - 09.2000) 85kw 115cv 1796cm3 Hatchback FORD MONDEO II (BAP) 2.0 i (08.1996 - 09.2000) 96kw 131cv 1988cm3 Hatchback FORD MONDEO II (BA...</p> <p>c48mm M12x1,5mm</p>
	<p><b>Y3233</b> NO. 1473166 - 1481984 - 3395499 - 4432023 - 6586309 - 6789185</p> <p>PARAFUSO DA RODA CAVILHA M12X1,50X48MM</p> <p>FORD MONDEO III (B5Y) 1.8 16V (10.2000 - 03.2007) 81kw 110cv 1798cm3 Hatchback FORD MONDEO III (B5Y) 1.8 16V (10.2000 - 03.2007) 92kw 125cv 1798cm3 Hatchback FORD MONDEO III (B5Y) 1.8 SCI (06.2003 - 03.2007) 96kw 130cv 1798cm3 Hatchback FORD MONDEO III (B5Y) 2.0 16V (10.2000 - 03.2007) 107kw 146cv 1999cm3 Hatchback FORD MONDEO III (B5Y) 2.0 16V DI / TDDi / TDCi (10.2000 - 03.2007) 66kw 90cv 1998cm...</p> <p>c48mm M12x1,5mm</p>	<p><b>Z41158</b> NO. 1656747 - 1825595 - 1752024 - 6740771 - 4852244</p> <p>MOLA DE FIXAÇÃO TIPO PORCA</p> <p>FORD MONDEO I (GBP) 1.6 i 16V (07.1994 - 08.1996) 65kw 88cv 1597cm3 Hatchback FORD MONDEO I (GBP) 1.6 i 16V (02.1993 - 08.1996) 66kw 90cv 1597cm3 Hatchback FORD MONDEO I (GBP) 1.8 TD (06.1993 - 08.1996) 65kw 88cv 1753cm3 Hatchback FORD MONDEO I (GBP) 1.8 TD (10.1995 - 08.1996) 66kw 90cv 1753cm3 Hatchback FORD MONDEO I (GBP) 1.8 i 16V (07.1994 - 08.1996) 82kw 112cv 1796cm3 Hatchback FORD MONDEO I (GBP) ...</p> <p>d12x 11mm f-d24mm</p>
	<p><b>Z41158</b> NO. 1656747 - 1825595 - 1752024 - 6740771 - 4852244</p> <p>MOLA DE FIXAÇÃO TIPO PORCA</p> <p>FORD MONDEO I Turnier (BNP) 1.6 i 16V (07.1994 - 08.1996) 65kw 88cv 1597cm3 Combi FORD MONDEO I Turnier (BNP) 1.6 i 16V (04.1993 - 08.1996) 66kw 90cv 1597cm3 Combi FORD MONDEO I Turnier (BNP) 1.8 TD (06.1993 - 08.1996) 65kw 88cv 1753cm3 Combi FORD MONDEO I Turnier (BNP) 1.8 TD (11.1995 - 08.1996) 66kw 90cv 1753cm3 Combi FORD MONDEO I Turnier (BNP) 1.8 i 16V (04.1993 - 08.1996) 85kw 115cv 1796cm3 Combi ...</p> <p>d12x 11mm f-d24mm</p>	<p><b>Z41158</b> NO. 1656747 - 1825595 - 1752024 - 6740771 - 4852244</p> <p>MOLA DE FIXAÇÃO TIPO PORCA</p> <p>FORD MONDEO I três volumes (GBP) 1.6 i 16V (07.1994 - 08.1996) 65kw 88cv 1597cm3 três volumes FORD MONDEO I três volumes (GBP) 1.6 i 16V (02.1993 - 08.1996) 66kw 90cv 1597cm3 três volumes FORD MONDEO I três volumes (GBP) 1.8 TD (06.1993 - 08.1996) 65kw 88cv 1753cm3 três volumes FORD MONDEO I três volumes (GBP) 1.8 TD (10.1995 - 08.1996) 66kw 90cv 1753cm3 três volumes FORD MONDEO I três volumes (GBP) 1... </p> <p>d12x 11mm f-d24mm</p>
	<p><b>Z41158</b> NO. 1656747 - 1825595 - 1752024 - 6740771 - 4852244</p> <p>MOLA DE FIXAÇÃO TIPO PORCA</p> <p>FORD MONDEO II (BAP) 1.6 i (08.1996 - 09.2000) 66kw 90cv 1597cm3 Hatchback FORD MONDEO II (BAP) 1.6 i 16V (05.1998 - 09.2000) 70kw 95cv 1597cm3 Hatchback FORD MONDEO II (BAP) 1.8 TD (08.1996 - 09.2000) 66kw 90cv 1753cm3 Hatchback FORD MONDEO II (BAP) 1.8 i (08.1996 - 09.2000) 85kw 115cv 1796cm3 Hatchback FORD MONDEO II (BAP) 2.0 i (08.1996 - 09.2000) 96kw 131cv 1988cm3 Hatchback FORD MONDEO II (BAP) 2...</p> <p>d12x 11mm f-d24mm</p>	<p><b>Z41158</b> NO. 1656747 - 1825595 - 1752024 - 6740771 - 4852244</p> <p>MOLA DE FIXAÇÃO TIPO PORCA</p> <p>FORD MONDEO II Turnier (BNP) 1.6 i (08.1996 - 09.2000) 66kw 90cv 1597cm3 Combi FORD MONDEO II Turnier (BNP) 1.6 i 16V (05.1998 - 09.2000) 70kw 95cv 1597cm3 Combi FORD MONDEO II Turnier (BNP) 1.8 TD (08.1996 - 09.2000) 66kw 90cv 1753cm3 Combi FORD MONDEO II Turnier (BNP) 1.8 i (08.1996 - 09.2000) 85kw 115cv 1796cm3 Combi FORD MONDEO II Turnier (BNP) 2.0 i (08.1996 - 09.2000) 96kw 131cv 1988cm3 Combi FOR...</p> <p>d12x 11mm f-d24mm</p>
	<p><b>Z41158</b> NO. 1656747 - 1825595 - 1752024 - 6740771 - 4852244</p> <p>MOLA DE FIXAÇÃO TIPO PORCA</p> <p>FORD MONDEO II três volumes (BFP) 1.6 i (08.1996 - 09.2000) 66kw 90cv 1597cm3 três volumes FORD MONDEO II três volumes (BFP) 1.6 i 16V (05.1998 - 09.2000) 70kw 95cv 1597cm3 três volumes FORD MONDEO II três volumes (BFP) 1.8 TD (08.1996 - 09.2000) 66kw 90cv 1753cm3 três volumes FORD MONDEO II três volumes (BFP) 1.8 i (08.1996 - 09.2000) 85kw 115cv 1796cm3 três volumes FORD MONDEO II três volumes (BFP) ...</p> <p>d12x 11mm f-d24mm</p>	<p><b>Z41158</b> NO. 1656747 - 1825595 - 1752024 - 6740771 - 4852244</p> <p>MOLA DE FIXAÇÃO TIPO PORCA</p> <p>FORD MONDEO III (B5Y) 1.8 16V (10.2000 - 03.2007) 81kw 110cv 1798cm3 Hatchback FORD MONDEO III (B5Y) 1.8 16V (10.2000 - 03.2007) 92kw 125cv 1798cm3 Hatchback FORD MONDEO III (B5Y) 1.8 SCI (06.2003 - 03.2007) 96kw 130cv 1798cm3 Hatchback FORD MONDEO III (B5Y) 2.0 16V (10.2000 - 03.2007) 107kw 146cv 1999cm3 Hatchback FORD MONDEO III (B5Y) 2.0 16V DI / TDDi / TDCi (10.2000 - 03.2007) 66kw 90cv 1998cm3 Hat...</p> <p>d12x 11mm f-d24mm</p>

	<p><b>Z41158</b> NO. 1656747 - 1825595 - 1752024 - 6740771 - 4852244</p> <p><b>MOLA DE FIXAÇÃO TIPO PORCA</b></p> <p>FORD MONDEO III Turnier (BWY) 1.8 16V (10.2000 -03.2007) 81kw 110cv 1798cm3 Combi FORD MONDEO III Turnier (BWY) 1.8 16V (10.2000 -03.2007) 92kw 125cv 1798cm3 Combi FORD MONDEO III Turnier (BWY) 1.8 SCi (06.2003 -03.2007) 96kw 130cv 1798cm3 Combi FORD MONDEO III Turnier (BWY) 2.0 16V (10.2000 -03.2007) 107kw 146cv 1999cm3 Combi FORD MONDEO III Turnier (BWY) 2.0 16V DI / TDDi / TDCi (10.2000 -03.200...</p> <p>d12x 11mm f-d24mm</p>		<p><b>Z41158</b> NO. 1656747 - 1825595 - 1752024 - 6740771 - 4852244</p> <p><b>MOLA DE FIXAÇÃO TIPO PORCA</b></p> <p>FORD MONDEO III três volumes (B4Y) 1.8 16V (10.2000 -03.2007) 81kw 110cv 1798cm3 três volumes FORD MONDEO III três volumes (B4Y) 1.8 16V (10.2000 -03.2007) 92kw 125cv 1798cm3 três volumes FORD MONDEO III três volumes (B4Y) 1.8 SCi (06.2003 -03.2007) 96kw 130cv 1798cm3 três volumes FORD MONDEO III três volumes (B4Y) 2.0 16V (10.2000 -03.2007) 107kw 146cv 1999cm3 três volumes FORD MONDEO III três vo...</p> <p>d12x 11mm f-d24mm</p>
	<p><b>Z50130</b> NO. 11589289</p> <p><b>MOLA REBITE FIXAÇÃO</b></p> <p>FORD MONDEO IV (BA7) 1.6 EcoBoost (02.2011 -01.2015) 118kw 160cv 1596cm3 Hatchback FORD MONDEO IV (BA7) 1.6 TDCi (02.2011 -01.2015) 85kw 115cv 1560cm3 Hatchback FORD MONDEO IV (BA7) 1.6 Ti (03.2007 -01.2015) 81kw 110cv 1596cm3 Hatchback FORD MONDEO IV (BA7) 1.6 Ti (07.2010 -01.2015) 88kw 120cv 1596cm3 Hatchback FORD MONDEO IV (BA7) 1.6 Ti (03.2007 -01.2015) 92kw 125cv 1596cm3 Hatchback FORD MONDEO...</p> <p>d6x 18mm f-d17mm</p>		<p><b>Z50130</b> NO. 11589289</p> <p><b>MOLA REBITE FIXAÇÃO</b></p> <p>FORD MONDEO IV Turnier (BA7) 1.6 EcoBoost (02.2011 -01.2015) 118kw 160cv 1596cm3 Combi FORD MONDEO IV Turnier (BA7) 1.6 TDCi (02.2011 -01.2015) 85kw 115cv 1560cm3 Combi FORD MONDEO IV Turnier (BA7) 1.6 Ti (03.2007 -12.2012) 81kw 110cv 1596cm3 Combi FORD MONDEO IV Turnier (BA7) 1.6 Ti (07.2010 -01.2015) 88kw 120cv 1596cm3 Combi FORD MONDEO IV Turnier (BA7) 1.6 Ti (03.2007 -12.2010) 92kw 125cv 1596c...</p> <p>d6x 18mm f-d17mm</p>
	<p><b>Z50130</b> NO. 11589289</p> <p><b>MOLA REBITE FIXAÇÃO</b></p> <p>FORD MONDEO IV três volumes (BA7) 1.6 EcoBoost (11.2010 -01.2015) 118kw 160cv 1596cm3 três volumes FORD MONDEO IV três volumes (BA7) 1.6 TDCi (12.2010 -01.2015) 85kw 115cv 1560cm3 três volumes FORD MONDEO IV três volumes (BA7) 1.6 Ti (03.2007 -01.2015) 81kw 110cv 1596cm3 três volumes FORD MONDEO IV três volumes (BA7) 1.6 Ti (03.2010 -01.2015) 88kw 120cv 1596cm3 três volumes FORD MONDEO IV três vol...</p> <p>d6x 18mm f-d17mm</p>		<p><b>Z50130</b> NO. 11589289</p> <p><b>MOLA REBITE FIXAÇÃO</b></p> <p>FORD MONDEO V Hatchback (CE) 1.0 EcoBoost (02.2015 -) 92kw 125cv 998cm3 Hatchback FORD MONDEO V Hatchback (CE) 1.5 EcoBoost (09.2014 -) 118kw 160cv 1499cm3 Hatchback FORD MONDEO V Hatchback (CE) 1.5 EcoBoost (05.2018 -) 121kw 165cv 1499cm3 Hatchback FORD MONDEO V Hatchback (CE) 1.5 TDCi (03.2015 -) 88kw 120cv 1499cm3 Hatchback FORD MONDEO V Hatchback (CE) 1.6 TDCi (09.2014 -) 85kw 115cv 1560cm3 Ha...</p> <p>d6x 18mm f-d17mm</p>
	<p><b>Z50130</b> NO. 11589289</p> <p><b>MOLA REBITE FIXAÇÃO</b></p> <p>FORD MONDEO V Turnier (CF) 1.0 EcoBoost (02.2015 -) 92kw 125cv 998cm3 Combi FORD MONDEO V Turnier (CF) 1.5 EcoBoost (09.2014 -) 118kw 160cv 1499cm3 Combi FORD MONDEO V Turnier (CF) 1.5 EcoBoost (05.2018 -) 121kw 165cv 1499cm3 Combi FORD MONDEO V Turnier (CF) 1.5 TDCi (03.2015 -) 88kw 120cv 1499cm3 Combi FORD MONDEO V Turnier (CF) 1.6 TDCi (09.2014 -) 85kw 115cv 1560cm3 Combi FORD MONDEO V Turnier ...</p> <p>d6x 18mm f-d17mm</p>		<p><b>Z50130</b> NO. 11589289</p> <p><b>MOLA REBITE FIXAÇÃO</b></p> <p>FORD MONDEO V três volumes (CD) 1.0 EcoBoost (02.2015 -) 92kw 125cv 998cm3 três volumes FORD MONDEO V três volumes (CD) 1.5 EcoBoost (09.2014 -) 118kw 160cv 1499cm3 três volumes FORD MONDEO V três volumes (CD) 1.5 EcoBoost (01.2019 -) 121kw 165cv 1499cm3 três volumes FORD MONDEO V três volumes (CD) 1.5 TDCi (03.2015 -) 88kw 120cv 1499cm3 três volumes FORD MONDEO V três volumes (CD) 2.0 EcoBlue (01...</p> <p>d6x 18mm f-d17mm</p>
	<p><b>Z55254</b> NO. 1009164</p> <p><b>MOLA REBITE FIXAÇÃO</b></p> <p>FORD MONDEO (2000-2007)</p> <p>d5.5x 16mm f-d11mm</p>		<p><b>Z57104</b> NO. 4831516</p> <p><b>MOLA DO PAINEL DA PORTA</b></p> <p>FORD MONDEO (A partir de 2014)</p> <p>F12mm T21mm L18mm H28mm S1-12mm</p>
	<p><b>Z80717</b> NO. 6150260</p> <p><i>Mola de fixação</i></p> <p>FORD MONDEO</p> <p>d20x12.5mm 1p-8x11-10mm 1f-d5.5mm</p>		<p><b>Z80750</b> NO. 1079129 - 6678518 - 6998849</p> <p><i>Mola de painel</i></p> <p>FORD MONDEO</p> <p>d20x23mm 1p-d9-20mm</p>
	<p><b>Z80787</b> NO. 1039463 - 8E0825267</p> <p><i>Mola de fixação</i></p> <p>FORD MONDEO</p> <p>d20x34mm 1p-d8.5-21mm</p>		

	<p><b>A0725</b> NO. 508E6038</p> <p>APOIO SUPORTE DO MOTOR</p> <p>FORD TRADLER 1500</p> <p>91x72x105mm 1f-d13mm</p>		<p><b>A1386</b> NO. 1576279 - 1613023 - 480890 - 71BG.4826.DB</p> <p>APOIO TRANSMISSÃO (FURO 30MM)</p> <p>FORD P 100 II: 2.0 10.1987/12.1992 57KW 78CV 1993CC - FORD P 100 II: 1.8 TD 10.1987/12.1992 55KW 75CV 1753CC</p> <p>175x93x73mm 1f-d32mm</p>
	<p><b>F0463-I</b> NO. 1568355</p> <p>FOLE DA DIREÇÃO ESQUERDO</p> <p>FORD P100 PICK UP</p> <p>d62x205mm 1f-d26mm 1f-d10mm</p>		<p><b>F0538-I</b> NO. 1073846 - 6043191 - 77TTA331FA - 98AX.4A084.BA</p> <p>FOLE DO SEM-EIXO JUNTO À RODA OU CAIXA DE VELOCIDADES</p> <p>FORD P100 1.6 (1982 A 1987)</p> <p>d92x100mm 1f-d75mm 1f-d20mm</p>
	<p><b>F1081-I</b> NO. 1610365 - 617346 - 617347 - 84AB.3K661.AA</p> <p>FOLE DA DIREÇÃO</p> <p>FORD P100 1.8TD - 2.0 (1987 A 1992)</p> <p>d60x230mm 1f-d48mm 1f-d10mm</p>		<p><b>F1081-I</b> NO. 1610365 - 617346 - 617347 - 84AB.3K661.AA</p> <p>FOLE DA DIREÇÃO</p> <p>FORD P100 1.8TD - 2.0 (1987 A 1992)</p> <p>d60x230mm 1f-d48mm 1f-d10mm</p>
	<p><b>F1668-I</b> NO. 1619061 - 83BB.3K661.BD</p> <p>FOLE DA DIREÇÃO DIREITO E ESQUERDO</p> <p>FORD P100 1.8TD - 2.0 (1987 A 1992)</p> <p>d62x200mm 1f-d37mm 1f-d10mm</p>		<p><b>F4022</b> NO. 1568353</p> <p>FOLE DIREÇÃO ESQUERDO</p> <p>FORD P100</p> <p>d65x140mm 1f-d48mm 1f-d10mm</p>
	<p><b>F4023</b> NO. 1568355</p> <p>FOLE DIREÇÃO DIREITO</p> <p>FORD P100</p> <p>d62x210mm d44mm 1f-d27mm 1f-d10mm</p>		<p><b>KF1810</b> NO. 1016760 - 1073805 - 1073846 - 1638320 - 6043191 - 6053206 - 77TTA331FA - 95SX4K258DA - 98AX.4A08...</p> <p>FOLE DO LADO DA RODA (DIAM. 78mm)</p> <p>FORD P100 PICK-UP</p> <p>d93x103mm 1f-d20mm 1f-d78mm</p>
	<p><b>L3032</b> NO. 92PT5718</p> <p>CASQUILHO MOLAS TRÁS OLHAL TRÁS (PEQUENO)</p> <p>FORD P 100 II: 2.0 10.1987/12.1992 57KW 78CV 1993CC - FORD P 100 II: 1.8 TD 10.1987/12.1992 55KW 75CV 1753CC</p> <p>d37x26mm c14mm 1f-d11.5mm</p>		<p><b>L3033</b> NO. 92PT5719</p> <p>CASQUILHO MOLAS TRÁS OLHAL TRÁS (GRANDE)</p> <p>FORD P 100 II: 2.0 10.1987/12.1992 57KW 78CV 1993CC - FORD P 100 II: 1.8 TD 10.1987/12.1992 55KW 75CV 1753CC</p> <p>d38x54mm d29.5mm 1f-d12mm</p>
	<p><b>L3043</b> NO. 1481463 - 1481464 - 71BB.5K498.BB - LEM1700</p> <p>CASQUILHO DAS PONTAS DA BARRA ESTABILIZADORA</p> <p>FORD P 100 I 1.6 04.1982/09.1987 54KW 73CV 1598CC LCR - FORD P 100 II 2.0 10.1987/12.1992 57KW 78CV 1993CC NAE</p> <p>d28x42mm 1f-d10mm</p>		<p><b>RT08600</b> NO. 1638393 - 1666247 - 1666460 - 6125634</p> <p>TUBO DE TRAVÃO TRÁS LH-RH</p> <p>FORD P100 TT (01-1998 A 1994)</p> <p>355mm MC11 - MC40</p>
	<p><b>RT08691</b> NO. 6149181 - 6577425 - 92VB2282AA</p> <p>TUBO DE TRAVÃO TRÁS LH-RH</p> <p>FORD P100 TT (01-1998 A 1994)</p> <p>420mm EF297 - FC3</p>		<p><b>S1197</b> NO. 1656752 - 5021729 - 6122507 - 6129161 - 6144628 - 85GB.5493.AB - 85GB.5493.BA - 88GB.5493.AA - 88GB...</p> <p>SILENT-BLOC CENTRAL DO BRAÇO DA SUSPENSÃO DIANTEIRO</p> <p>FORD P 100 II: 2.0 10.1987/12.1992 57KW 78CV 1993CC - FORD P 100 II: 1.8 TD 10.1987/12.1992 55KW 75CV 1753CC</p> <p>d65x23mm c8mm d48mm 1f-d16mm</p>



	<b>S1239</b>	NO. 1646319 - 88PB.5781.AA - 92PT5719AA		<b>S1240</b>	NO. 1646309 - 88PB5719AA - 90PT5K570AA
	SILENT-BLOC DAS MOLAS DE TRÁS (PARTE DA FRENTE) FORD P100			SILENT-BLOC DAS MOLAS DE TRÁS (PARTE DA FRENTE) FORD P 100 II: 2.0 10.1987/12.1992 57KW 78CV 1993CC - FORD P 100 II: 1.8 TD 10.1987/12.1992 55KW 75CV 1753CC	
d38x73mm		c60mm 1f-d12mm	d30x72mm		c57mm 1f-d12mm
	<b>S1241</b>	NO. 1626132 - 90PT5L021AA		<b>S1242</b>	NO. 1610788 - 90PT5A103AA
	SILENT-BLOC DO MOTOR PARTE SUPERIOR FORD P100			SILENT-BLOC DO MOTOR PARTE INFERIOR FORD P100	
d70x74mm		1f-d12mm	d65x67mm		1f-d12mm
	<b>S1384</b>	NO. 1520587 - 72GB3068AC		<b>S1417</b>	NO. 6009976 - 74BB.3069.AB
	SILENT-BLOC DO BRAÇO DA SUSPENSÃO DA FRENTE PARTE SUPERIOR FORD P100			SILENT BLOC DO BRAÇO DA SUSPENSÃO DA FRENTE PARTE INFERIOR FORD P 100 I: 1.6 04.1982/09.1987 54KW 73CV 1598CC	
d45x42mm		d32mm 1f-d14mm	d32x69mm		d30 - 5mm 1f-d12mm
	<b>UTR0820</b>	NO. 90352470 - 90409256 - 90409257 - 9041032690497472 - 90467473		<b>UTR0829</b>	NO. 1647750 - 1650630 - 1659287 - 1659288 - 6157002 - 7267969
	TAMPÃO RESERVATÓRIO LIQUIDO REFRIGERAÇÃO FORD P100 II 2.0 (10.87 A 12.92) 78cv 1993cc Pick-up - FORD P 100 II 1.8 TD (10.87 A 12.92) 75cv 1753cc Pick-up			TAMPÃO RESERVATÓRIO LIQUIDO REFRIGERAÇÃO FORD P100 I 1.6 (04.82 A 09.87) 73cv 1598cc Pick-up - FORD P 100 II 2.0 (10.87 A 12.92) 78cv 1993cc Pick-up - FORD P 100 II 1.8 TD (10.87 A 12.92) 75cv 1753cc Pick-up	
d62x23mm		1f-d53x12mm	d62x25mm		1f-d52x14mm

FORD PROBE

	<b>M6047</b>	NO. 0K2K140305 - 0K52Y40305 - 0K95A40306A - 1003522 - 1009008 - 1011011 - 1073466 - 1105584 - 1953211 - ...		<b>M6088</b>	NO. 3728332
	JUNTA DE ESCAPE FORD PROBE (APÓS 1993)			JUNTA DE ESCAPE FORD PROBE (APÓS 1993)	
118x80mm		1f-d67mm	d68x15mm		1f-d54mm
	<b>M6089</b>	NO. 3250969 - 3846629		<b>UTR0864</b>	NO. 39172-31G25 - 39712-31G25 - 39741-0F000 - 39741-0F00A - 39741-41W03 - 39741-41W25 - 39741-41W26
	JUNTA DE ESCAPE FORD PROBE (APÓS 1993)			TAMPÃO RESERVATÓRIO LIQUIDO REFRIGERAÇÃO FORD PROBE	
108x68x1.5mm		1f-d58mm	d65x30mm		d48x14mm 1p-d40x32mm

	<p><b>A1497</b> NO.</p> <p>APOIO DO VEIO DA TRANSMISSÃO</p> <p>FORD RANGER</p> <p>190x115x65mm 1f-d30mm</p>		<p><b>A1663</b> NO. 1454977 - 5031505</p> <p>APOIO DO MOTOR PARTE DE TRÁS</p> <p>FORD RANGER (ER, EQ, R_) 2.5 TD 4x4 10.1999/06.2006 80KW 109CV 2500CC WL-T 8566006</p> <p>47x39x32mm 2p-d10-24mm</p>
	<p><b>A1664</b> NO. 1454977 - 5031505</p> <p>APOIO DO MOTOR</p> <p>FORD RANGER (ER, EQ, R_) 2.5 TD 4x4 10.1999/06.2006 80KW 109CV 2500CC WL-T 8566006</p> <p>111x66x44mm 2p-d10-22mm</p>		<p><b>A1674</b> NO. 3M346038AA</p> <p>APOIO DO MOTOR PARTE DA FRENTE</p> <p>FORD RANGER (ER, EQ, R_): 2.5 D 10.1999/04.2002 57KW 78CV 2499CC - FORD RANGER (ER, EQ, R_): 2.5 D 4x4 10.1999/04.2002 57KW 78CV 2499CC - FORD RANGER (ER, EQ, R_): 2.5 TD 04.2002/06.2006 62KW 84CV 2500CC - FORD RANGER (ER, EQ, R_): 2.5 TD 4x4 10.1999/06.2006 80KW 109CV 2500CC</p> <p>110x55x43mm 2p-d10-22mm</p>
	<p><b>A1742</b> NO. UH74-34-110</p> <p>APOIO BATENTE BRAÇO DE SUSPENSÃO FRENTE INFERIOR (GASTA 2 UNIDADES)</p> <p>FORD RANGER 4WD</p> <p>67x63x36mm 1p-d10-27mm</p>		<p><b>A1895</b> NO. 5031497</p> <p>APOIO DA TRANSMISSÃO</p> <p>FORD RANGER (ER - EQ) 2.5 TD Pick-up (04-2002 A 06-2006) 84CV 2500CC - FORD RANGER (ER - EQ) 2.5 TD 4x4 Pick-up (04-2002 A 06-2006) 84CV 2500CC - FORD RANGER (ER - EQ) 2.5 TD 4x4 Pick-up (10-1999 A 06-2006) 109CV 2500CC</p> <p>210x135x57mm 1f-d35mm</p>
	<p><b>A1976</b> NO. UC9M-39-040D - UC9P-39-040D - UD0F-39-040 - UD0F-39-040A - UF9S-39-040 - UF9S-39-040A</p> <p>APOIO MOTOR FRENTE DIREITO</p> <p>FORD RANGER KD ENG: 2.2L T22DD0P (120PS) 01.2011/»»» - FORD RANGER KD ENG: 2.2L T22DD0P (150PS) 01.2011/»»» - FORD RANGER KD ENG: 2.2L GBVAJPF 04.2011/»»» - FORD RANGER 3.2 (4X2) - (4X4) 01.2011/»»»</p> <p>185x75x80mm 1p-d14x40mm 1f-d14mm 1f-d20mm</p>		<p><b>A1977</b> NO. UC9M-39-05XD - UC9P-39-05XD - UD0F-39-05X - UD0F-39-05XA - UF9S-39-05X - UF9S-39-05XA</p> <p>APOIO MOTOR FRENTE ESQUERDO</p> <p>FORD RANGER KD ENG: 2.2L T22DD0P (120PS) 01.2011/»»» - FORD RANGER KD ENG: 2.2L T22DD0P (150PS) 01.2011/»»» - FORD RANGER KD ENG: 2.2L GBVAJPF 04.2011/»»» - FORD RANGER 3.2 (4X2) - (4X4) 01.2011/»»»</p> <p>185x75x80mm 1p-d14x40mm 1f-d14mm 1f-d20mm</p>
	<p><b>A1988</b> NO. UH72-39-340B</p> <p>APOIO CAIXA VELOCIDADES</p> <p>FORD RANGER (ET): 2.5 TDdi 05.2006/07.2012 105KW 143CV 2499CC</p> <p>110x70x50mm 2p-d10x16mm 2f-d8mm</p>		<p><b>A1989</b> NO. 1454977 - 5031505</p> <p>APOIO CAIXA VELOCIDADES</p> <p>FORD RANGER (ET) 2.5 TDI (4X4)</p> <p>110x60x45mm 2p-d10x20mm 2f-d12mm</p>
	<p><b>A1990</b> NO. 2p-d12x30mm 1f-d9mm 1f-d11mm 1f-13</p> <p>APOIO CAIXA VELOCIDADES</p> <p>FORD RANGER (4X2)</p> <p>130x105x80mm 2p-d12x30mm 1f-d9mm 1f-d11mm 1f-13x</p>		<p><b>A1999</b> NO. SA12-25-300</p> <p>APOIO TRANSMISSÃO</p> <p>FORD RANGER (ET) 2.5 TDdi (De 05-2006 Até 07-2012) 105KW 143CV 2499cc Pick-up</p> <p>205x115x60mm 1f-d35mm 2f-30x13mm</p>
	<p><b>A2000</b> NO. SA02-25-100</p> <p>APOIO TRANSMISSÃO</p> <p>FORD RANGER FIGHTER (4X2) (62/28) 28MM</p> <p>210x115x60mm 1f-d28mm 2f-30x13mm</p>		<p><b>A2001</b> NO. SA54-25-100</p> <p>APOIO TRANSMISSÃO</p> <p>FORD RANGER (ER, EQ, R_): 2.5 D 10.1999/04.2002 57KW 78CV 2499CC - FORD RANGER (ER, EQ, R_): 2.5 TD 04.2002/06.2006 62KW 84CV 2500CC - FORD RANGER (4X4) TURBO (62/28) 28MM</p> <p>225x135x60mm 1f-d28mm 2f-30x14mm</p>
	<p><b>A2128</b> NO. 1454605 - 1512772 - 5031497 - AB394W602AA</p> <p>APOIO DA TRANSMISSÃO</p> <p>FORD RANGER (ER, EQ, R_): 2.5 D 4x4 10.1999/04.2002 57KW 78CV 2499CC - FORD RANGER (ER, EQ, R_): 2.5 TD 04.2002/06.2006 62KW 84CV 2500CC - FORD RANGER (ER, EQ, R_): 2.5 TD 4x4 10.1999/06.2006 80KW 109CV 2500CC - FORD RANGER (ER, EQ, R_): 2.5 TD 04.2002/06.2006 62KW 84CV 2500CC - FORD RANGER (ER, EQ, R_): 2.5 TD 4x4 10.1999/06.2006 80KW 109CV 2500CC - FORD RANGER (ET): 2.5 TDdi 05.2006/07.2012 105KW 143CV 2499CC - FORD RANGER (ET): 2.5 TDCi 4x405.2006/07.2012 105K...</p> <p>224x140x60mm 1f-d35mm</p>		<p><b>A2240</b> NO. 1454977 - 5031505</p> <p>APOIO DO MOTOR PARTE DE TRÁS CAIXA VELOCIDADES</p> <p>FORD RANGER (ER, EQ, R_) 2.5 TD 4x4 10.1999/06.2006 80KW 109CV 2500CC WL-T 8566006</p> <p>290x83x109mm 2f-d12mm 2f-27x23mm 3p-d9x21mm</p>

	<p><b>E289</b> NO. 11516078 - 3 252 473 - 3 252 478 - 3 665 949 - 3 665 965 - 3 665 965 S1 - 3 754 149 - 3 951 303 - 37...</p> <p><b>ESTICADOR BARRA ESTABILIZADORA FRENTE ( GASTA 2 UNIDADES )</b></p> <p>FORD RANGER (ER, EQ, R_) 2.5 D 10.1999/04.2002 57KW 78CV 2499CC WL 8566004 - FORD RANGER (ER, EQ, R_) 2.5 D 4x4 10.1999/04.2002 57KW 78CV 2499CC WL 8566005 - FORD RANGER (ER, EQ, R_) 2.5 TD 04.2002/06.2006 62KW 84CV 2500CC WL-T 8566086 - FORD RANGER (ER, EQ, R_) 2.5 TD 4x4 10.1999/06.2006 80KW 109CV 2500CC WL-T 8566006 - FORD RANGER (ER, EQ, R_) 2.5 TD 4x4 04.2002/06.2006 62KW 84CV 2500CC WL-T - F...</p> <p>145x32mm 1p-d10x39mm</p>		<p><b>KF2362-T</b> NO. 1603232 - 1603278 - 2T144A084AA - 4119973 - 4371800 - 4410860</p> <p><b>KIT DE FOLE DO CARDAN JUNTO Á RODA</b></p> <p>FORD RANGER (APÓS 1999) 2.5D</p> <p>d104x130mm 1f-d91mm 1f-d27mm</p>
	<p><b>KF4168</b> NO. 3665759 - 3669093 - 3950873 - 8AU1-32-280 - UH74-32-280</p> <p><b>KIT FOLE RESGUARDO ROTULAS DA DIRECÇÃO</b></p> <p>FORD RANGER (ER, EQ, R_) 2.5 D (De 1999.10 Até 2002.04) 57KW 78cv 2499cm3 Pick-up - FORD RANGER (ER, EQ, R_) 2.5 D 4x4 (De 1999.10 Até 2002.04) 57KW 78cv 2499cm3 Pick-up - FORD RANGER (ER, EQ, R_) 2.5 TD (De 2002.04 Até 2006.06) 62kW 84cv 2500cm3 Pick-up - FORD RANGER (ER, EQ, R_) 2.5 TD 4x4 (De 2002.04 Até 2006.06) 62kW 84cv 2500cm3 Pick-up - FORD RANGER (ER, EQ, R_) 2.5 TD 4x4 (De 2002.04 Até 2006.06) 80kW 109cv 2500cm3 Pick-up - F...</p> <p>d56x39mm 1f-d39mm 1f-d19mm</p>		<p><b>KF4169</b> NO.</p> <p><b>KIT FOLE RESGUARDO RÓTULAS DA SUSPENSÃO</b></p> <p>FORD RANGER (ET): 2.5 TDCi 4x4 05.2006/07.2012 105KW 143CV 2499CC - FORD RANGER (ET): 3.0 TDCi 4x4 05.2006/07.2012 115KW 156CV 2953CC</p> <p>d56x39mm 1f-d39mm 1f-d19mm</p>
	<p><b>KF9050</b> NO. 3735783 - XM34-1244-AA</p> <p><b>KIT DE FOLE TRANSMISSÃO JUNTO Á CAIXA DE VELOCIDADES</b></p> <p>FORD RANGER (ER, EQ, R_) 2.5 D (10.1999 - 04.2002) 57kw 78cv 2499cm3 Pick-up FORD RANGER (ER, EQ, R_) 2.5 D 4x4 (10.1999 - 04.2002) 57kw 78cv 2499cm3 Pick-up FORD RANGER (ER, EQ, R_) 2.5 TD (04.2002 - 06.2006) 62kw 84cv 2500cm3 Pick-up FORD RANGER (ER, EQ, R_) 2.5 TD 4x4 (04.2002 - 06.2006) 62kw 84cv 2500cm3 Pick-up FORD RANGER (ER, EQ, R_) 2.5 TD 4x4 (10.1999 - 06.2006) 80kw 109cv 2500cm3 Pick-up...</p> <p>d87x91mm d85x160mm 1f-d25mm 1f-d88mm (32 dentes)</p>		<p><b>KL3097</b> NO. 5243843 - XM343C078AA - XM343C078CA</p> <p><b>KIT DE CASQUILHOS DO ESTICADOR DA SUSPENSÃO</b></p> <p>FORD RANGER EQ 2002-2011 - FORD RANGER ER 1998/2003 - FORD RANGER ES 2009/2012 - FORD RANGER ET 2006/2009</p> <p>d47x27mm d60x7mm d22x60mm 1f-18mm 1f-d18mm</p>
	<p><b>KUBT3006</b> NO. 1f-d32mm 1f-d43mm 1f-d11/12mm 1f-d</p> <p><b>KIT BORRACHAS TRAVAO PINÇA FRENTE NISS/TOKICO 43MM</b></p> <p>FORD RANGER (ER, EQ, R_) : 2.5 TD 04.2002/06.2006 62KW 84CV 2500CC - FORD RANGER (ER, EQ, R_) : 2.5 TD 4x4 04.2002/06.2006 62KW 84CV 2500CC - FORD RANGER (ER, EQ, R_) : 2.5 TD 4x4 10.1999/06.2006 80KW 109CV 2500CC</p> <p>d54x11mm(2UN) d47x3mm(4UN) d43x3mm(4UN) d11x12mm(2UN) 1f-d11mm(2UN) 1f-d12mm(2UN)</p>		<p><b>KUBT3008</b> NO. 1 454 526 - 1 454 527 - 1454552 - 2M34-2B11-8BB - 2M34-2B11-9BB</p> <p><b>KIT BORRACHAS TRAVAO PINÇA FRENTE TOKICO 43MM</b></p> <p>FORD RANGER (ER, EQ, R_) : 2.5 TD 04.2002/06.2006 62KW 84CV 2500CC - FORD RANGER (ER, EQ, R_) : 2.5 TD 4x4 04.2002/06.2006 62KW 84CV 2500CC - FORD RANGER (ER, EQ, R_) : 2.5 TD 4x4 10.1999/06.2006 80KW 109CV 2500CC</p> <p>d54x11mm(4UN) d48x3mm(4UN) d43x3mm(4UN) d11x12mm(4UN) 1f-d11mm(4UN) 1f-d12mm(4UN)</p>
	<p><b>KUBT3054</b> NO. 1732971 - AB31-2L484-AA</p> <p><b>KIT BORRACHAS TRAVÃO FRENTE PINÇA PISTÕES</b></p> <p>FORD RANGER (TKE) 2.0 EcoBlue 4x4 (03.2019 - ) 96kw 130cv 1996cm3 Pick-up FORD RANGER (TKE) 2.0 EcoBlue 4x4 (03.2019 - ) 125kw 170cv 1996cm3 Pick-up FORD RANGER (TKE) 2.0 EcoBlue 4x4 (09.2018 - ) 157kw 213cv 1996cm3 Pick-up FORD RANGER (TKE) 2.2 TDCi (04.2011 - ) 88kw 120cv 2198cm3 Pick-up FORD RANGER (TKE) 2.2 TDCi (04.2011 - ) 92kw 125cv 2198cm3 Pick-up FORD RANGER (TKE) 2.2 TDCi (05.2015 - ) 96kw 131...</p> <p>d58x8mm d49x3mm 1f-d34mm 1f-d43mm</p>		<p><b>KURL2000</b> NO. 1f-d40mm 1f-d36mm 1f-d46mm 1f-d43mm</p> <p><b>KIT ROLAMENTO VEIO PRIMARIO</b></p> <p>FORD RANGER (ER, EQ, R_) 2.5 D 10.1999/04.2002 57KW 78CV 2499CC WL 8566004 - FORD RANGER (ER, EQ, R_) 2.5 D 4x4 10.1999/04.2002 57KW 78CV 2499CC WL 8566005 - FORD RANGER (ER, EQ, R_) 2.5 TD 04.2002/06.2006 62KW 84CV 2500CC WL-T 8566086 - FORD RANGER (ER, EQ, R_) 2.5 TD 4x4 10.1999/06.2006 80KW 109CV 2500CC WL-T 8566006 - FORD RANGER (ER, EQ, R_) 2.5 TD 4x4 04.2002/06.2006 62KW 84CV 2500CC WL-T - F...</p> <p>d80x20mm d56x46mm d70x40mm d36x40mm d46x40mm d43x40mm 1f-d36mm 1f-d40mm 1f-d43mm 1f-d46mm</p>
	<p><b>L3029</b> NO. 3645501</p> <p><b>CASQUILHO DAS MOLAS DE TRÁS (OLHAL FRENTE)</b></p> <p>FORD RANGER (ER, EQ, R_) : 2.5 D 10.1999/04.2002 57KW 78CV 2499CC - FORD RANGER (ER, EQ, R_) : 2.5 D 4x4 10.1999/04.2002 57KW 78CV 2499CC - FORD RANGER (ER, EQ, R_) : 2.5 TD 04.2002/06.2006 62KW 84CV 2500CC - FORD RANGER (ER, EQ, R_) : 2.5 TD 4x4 04.2002/06.2006 62KW 84CV 2500CC - FORD RANGER (ER, EQ, R_) : 2.5 TD 4x4 10.1999/06.2006 80KW 109CV 2500CC</p> <p>d37x38mm d32mm 1f-d17mm</p>		<p><b>L3092</b> NO. 1454584 - 1454900 - 3669886</p> <p><b>CASQUILHO PENDURAL DIRECÇÃO ( GASTA 2 UNIDADES )</b></p> <p>FORD RANGER (ER, EQ, R_) : 2.5 D 10.1999/04.2002 57KW 78CV 2499CC - FORD RANGER (ER, EQ, R_) : 2.5 D 4x4 10.1999/04.2002 57KW 78CV 2499CC - FORD RANGER (ER, EQ, R_) : 2.5 TD 04.2002/06.2006 62KW 84CV 2500CC - FORD RANGER (ER, EQ, R_) : 2.5 TD 4x4 04.2002/06.2006 62KW 84CV 2500CC - FORD RANGER (ER, EQ, R_) : 2.5 TD 4x4 10.1999/06.2006 80K2 109CV 2500CC - FORD RANGER (ET): 2.5 TDCi 05.2006/07.2012 105KW ...</p> <p>d39x29mm d30mm 1f-d23mm</p>
	<p><b>L3147</b> NO. 1729345</p> <p><b>CASQUILHO SUPERIOR MOLA LAMINA TRÁS</b></p> <p>FORD RANGER (TKE) 2.2 TDCi (A Partir de 04.11) 120cv 2198cc Pick-up - FORD RANGER (TKE) 2.2 TDCi (A Partir de 04.11) 125cv 2198cc Pick-up - FORD RANGER (TKE) 2.2 TDCi 4x4 (A Partir de 04.11) 125cv 2198cc Pick-up - FORD RANGER (TKE) 2.2 TDCi (A Partir de 05.15) 131cv 2198cc Pick-up - FORD RANGER (TKE) 2.2 TDCi 4x4 (A Partir de 05.15) 131cv 2198cc Pick-up - FORD RANGER (TKE) 2.2 TDCi 4x4 (...)</p> <p>d41x53mm d31mm 1f-d20mm</p>		<p><b>L3148</b> NO. 1729347</p> <p><b>CASQUILHO INFERIOR MOLA LAMINA TRÁS</b></p> <p>FORD RANGER (TKE) 2.2 TDCi (A Partir de 04.11) 120cv 2198cc Pick-up - FORD RANGER (TKE) 2.2 TDCi (A Partir de 04.11) 125cv 2198cc Pick-up - FORD RANGER (TKE) 2.2 TDCi 4x4 (A Partir de 04.11) 125cv 2198cc Pick-up - FORD RANGER (TKE) 2.2 TDCi (A Partir de 05.15) 131cv 2198cc Pick-up - FORD RANGER (TKE) 2.2 TDCi 4x4 (A Partir de 05.15) 131cv 2198cc Pick-up - FORD RANGER (TKE) 2.2 TDCi 4x4 (...)</p> <p>d41x34mm d31mm 1f-d20mm</p>
	<p><b>M6007</b> NO. 3670557 - XM34-SE241-BA</p> <p><b>JUNTA DO COLECTOR DE ESCAPE</b></p> <p>FORD RANGER</p> <p>d67x5mm 1f-d56mm</p>		<p><b>M6014</b> NO. 3670556</p> <p><b>JUNTA DE ESCAPE</b></p> <p>FORD RANGER (ER, EQ, R_) 2.5 D 4x4 10.1999/04.2002 57KW 78CV 2499CC WL 8566005 - FORD RANGER (ER, EQ, R_) 2.5 TD 04.2002/06.2006 62KW 84CV 2500CC WL-T 8566086 - FORD RANGER (ER, EQ, R_) 2.5 TD 4x4 10.1999/06.2006 80KW 109CV 2500CC WL-T 8566006 - FORD RANGER (ER, EQ, R_) 2.5 TD 4x4 04.2002/06.2006 62KW 84CV 2500CC WL-T</p> <p>d77x5mm 1f-d58.5mm</p>

	<p><b>R222452</b> NO. 1353884 - 1359243 - 1386843 - 1520173 - 3M5H9Y438AA - 3M5H9Y438AB - 3M5H9Y438AC - 3M5H9Y438AD</p> <p>TUBO DO RADIADOR LADO DA ADMISSÃO</p> <p>FORD S-MAX (WA6) 1.8 TDCi (05.2006 - 12.2014) 92kw 125cv 1753cm3 Veículo multiuso</p>		<p><b>R8162</b> NO. 3600580 - XM349N610AA</p> <p>TUBO DO FILTRO DE AR</p> <p>FORD RANGER (ER, EQ, R_) 2.5 D 10.1999/04.2002 57KW 78CV 2499CC WL 8566004 - FORD RANGER (ER, EQ, R_) 2.5 D 4x4 10.1999/04.2002 57KW 78CV 2499CC WL 8566005 - FORD RANGER (ER, EQ, R_) 2.5 TD 04.2002/06.2006 62KW 84CV 2500CC WL-T 8566086 - FORD RANGER (ER, EQ, R_) 2.5 TD 4x4 10.1999/06.2006 80KW 109CV 2500CC WL-T 8566006 - FORD RANGER (ER, EQ, R_) 2.5 TD 4x4 04.2002/06.2006 62KW 84CV 2500CC WL-T</p>
	<p><b>S1373</b> NO. 3665627 - 4521290 - UH74-34-450 - UH75-34-450 - UH75-34-450A - UM51-34-450 - XM343A493AA</p> <p>SILENT-BLOC DO BRAÇO DA SUSPENSÃO DA FRENTE PARTE INFERIOR</p> <p>FORD RANGER APÓS 1998</p>		<p><b>S1419</b> NO. 3665695 - UH71-34-470 - XM34.3069.BA</p> <p>SILENT-BLOC DO BRAÇO DA SUSPENSÃO DA FRENTE PARTE SUPERIOR</p> <p>FORD RANGER (ER, EQ, R_) 2.5 D 4x4 10.1999/04.2002 57KW 78CV 2499CC - FORD RANGER (ER, EQ, R_) 2.5 TD 4x4 04.2002/06.2006 62KW 84CV 2500CC - FORD RANGER (ER, EQ, R_) 2.5 TD 4x4 10.1999/06.2006 80KW 109CV 2500CC - FORD RANGER (ET): 2.5 TDCi 4x4 05.2006/07.2012 105KW 143CV 2499CC - FORD RANGER (ET): 3.0 TDCi 4x4 05.2006/07.2012 115KW 156CV 2953CC</p>
	<p><b>S1422</b> NO. 1451499 - 3871868 - 4441372 - 4521291</p> <p>SILENT-BLOC DO BRAÇO DA SUSPENSÃO DA FRENTE PARTE INFERIOR</p> <p>FORD RANGER (ER, EQ, R_) 2.5 D 10.1999/04.2002 57KW 78CV 2499CC - FORD RANGER (ER, EQ, R_) 2.5 D 4x4 10.1999/04.2002 57KW 78CV 2499CC - FORD RANGER (ER, EQ, R_) 2.5 TD 04.2002/06.2006 62KW 84CV 2500CC - FORD RANGER (ER, EQ, R_) 2.5 TD 4x4 04.2002/06.2006 62KW 84CV 2500CC - FORD RANGER (ER, EQ, R_) 2.5 TD 4x4 10.1999/06.2006 80KW 109CV 2500CC - FORD RANGER (ET): 2.5 TDci 05.2006/07.2012 10...</p>		<p><b>S1543</b> NO. 1456059 - 6M343069BA</p> <p>SILENT-BLOC DO BRAÇO SUPERIOR DA SUSPENSÃO DA FRENTE</p> <p>FORD RANGER (ET) 2.5 TDCi 4x4 05.2006/07.2012 105KW 143CV 2499CC WLAA 8566AJT 8566ATU 8566AXG - FORD RANGER (ET) 2.5 TDci 05.2006/07.2012 105KW 143CV 2499CC WLAA 8566AJT 8566AXE - FORD RANGER (ET) 3.0 TDCi 05.2006/07.2012 115KW 156CV 2953CC MD30DITC - FORD RANGER (ET) 3.0 TDCi 4x4 05.2006/07.2012 115KW 156CV 2953CC WEC MD30DITC 8566AMI 8566ATV 8566AXH - FORD RANGER (TKE) 2.2 TDCi desde 04.2011 88K...</p>
	<p><b>S1554</b> NO. 1454931</p> <p>SILENTBLOC DAS MOLAS DE LÂMINA OLHAL FRENTE</p> <p>FORD RANGER (ES - ET) 2.5 TDCi 4x4 Pick-up (05.06 A 07.12) 143CV 2499CC - FORD RANGER (ES - ET) 3.0 TDCi 4x4 Pick-up (05.06 A 07.12) 156CV 2953CC</p>		<p><b>S1716</b> NO. 1727223 - 1731075 - AB313069AB - UC3C 34 460 A</p> <p>SILENT-BLOC BRAÇO INFERIOR SUSPENSÃO DA FRENTE</p> <p>FORD RANGER (TKE) 2.2 TDCi (De 2011.04 -) 88kW 120cv 2198cm3 Pick-up - FORD RANGER (TKE) 2.2 TDCi (De 2011.04 -) 92kW 125cv 2198cm3 Pick-up - FORD RANGER (TKE) 2.2 TDCi 4x4 (De 2011.04 -) 92kW 125cv 2198cm3 Pick-up - FORD RANGER (TKE) 2.2 TDCi (De 2015.05 -) 96kW 131cv 2198cm3 Pick-up - FORD RANGER (TKE) 2.2 TDCi (De 2015.05 -) 96kW 131cv 2198cm3 Pick-up - FORD RANGER (TKE) 2.2 TDCi (De 2015.05 -) 96kW 131cv 2198cm3 Pick-up</p>
	<p><b>S1984</b> NO. 1727222 - 5232166 - 5232167 - AB31-3068-BB</p> <p>SILENT-BLOC DO BRAÇO SUPERIOR DA SUSPENSÃO DA FRENTE PARTE TRÁS E FRENTE</p> <p>FORD RANGER (TKE) 2.2 TDCi desde 04.2011 88KW 120CV 2198CC GBVAJPF ENPF - FORD RANGER (TKE) 2.2 TDCi desde 04.2011 92KW 125CV 2198CC GBVAJQW ENQW 1566AAD - FORD RANGER (TKE) 2.2 TDCi desde 11.2011 110KW 150CV 2198CC GBVAJQJ ENQJ 1566AAA - FORD RANGER (TKE) 2.2 TDCi desde 05.2015 96KW 131CV 2198CC T22DD0P 1566AAH - FORD RANGER (TKE) 2.2 TDCi desde 05.2015 118KW 160CV 2198CC T22DD0P GBVAJQJ 1566AAF ...</p>		<p><b>S1199</b> NO. 3665958 - 4524361</p> <p>BATENTE DA BARRA ESTABILIZADORA DA FRENTE</p> <p>FORD RANGER (ER, EQ, R_) 2.5 D (De 1999.10 Até 2002.04) 57kW 78cv 2499cm3 Pick-up - FORD RANGER (ER, EQ, R_) 2.5 D 4x4 (De 1999.10 Até 2002.04) 57kW 78cv 2499cm3 Pick-up - FORD RANGER (ER, EQ, R_) 2.5 TD (De 2002.04 Até 2006.06) 62kW 84cv 2500cm3 Pick-up - FORD RANGER (ER, EQ, R_) 2.5 TD 4x4 (De 2002.04 Até 2006.06) 62kW 84cv 2500cm3 Pick-up - FORD RANGER (ER, EQ, R_) 2.5 TD 4x4 (De 2002.04 Até 2006.06) 62kW 84cv 2500cm3 Pick-up - FORD RANGER (ER, EQ, R_) 2.5 TD 4x4 (De 2002.04 Até 2006.06) 62kW 84cv 2500cm3 Pick-up - FORD RANGER (ER, EQ, R_) 2.5 TD 4x4 (De 2002.04 Até 2006.06) 62kW 84cv 2500cm3 Pick-up</p>
	<p><b>T1199</b> NO. 3665958 - 4524361</p> <p>BATENTE DA BARRA ESTABILIZADORA DA FRENTE</p> <p>FORD RANGER (ER, EQ, R_) 2.5 D (De 1999.10 Até 2002.04) 57kW 78cv 2499cm3 Pick-up - FORD RANGER (ER, EQ, R_) 2.5 D 4x4 (De 1999.10 Até 2002.04) 57kW 78cv 2499cm3 Pick-up - FORD RANGER (ER, EQ, R_) 2.5 TD (De 2002.04 Até 2006.06) 62kW 84cv 2500cm3 Pick-up - FORD RANGER (ER, EQ, R_) 2.5 TD 4x4 (De 2002.04 Até 2006.06) 62kW 84cv 2500cm3 Pick-up - FORD RANGER (ER, EQ, R_) 2.5 TD 4x4 (De 2002.04 Até 2006.06) 62kW 84cv 2500cm3 Pick-up - FORD RANGER (ER, EQ, R_) 2.5 TD 4x4 (De 2002.04 Até 2006.06) 62kW 84cv 2500cm3 Pick-up - FORD RANGER (ER, EQ, R_) 2.5 TD 4x4 (De 2002.04 Até 2006.06) 62kW 84cv 2500cm3 Pick-up</p>		<p><b>UCRZ1046</b> NO. 1422934 - 3636482</p> <p>CRUZETA TRANSMISSÃO VEIO LONGITUDINAL D27X71MM</p> <p>FORD RANGER (ER, EQ, R_) 2.5 D 4x4 10.1999/04.2002 57KW 78CV 2499CC WL 8566005 - FORD RANGER (ER, EQ, R_) 2.5 TD 4x4 10.1999/06.2006 80KW 109CV 2500CC WL-T 8566006 - FORD RANGER (ER, EQ, R_) 2.5 TD 4x4 04.2002/06.2006 62KW 84CV 2500CC WL-T - FORD RANGER (ET) 2.5 TDCi 4x4 05.2006/07.2012 105KW 143CV 2499CC WLAA 8566AJT 8566ATU 8566AXG - FORD RANGER (ET) 2.5 TDci 05.2006/07.2012 105KW 143CV 2499CC W...</p>
	<p><b>UCRZ1102</b> NO. 1454601 - 1772723 - 6L2Z-4635-A - F2AZ4635A</p> <p>CRUZETA VEIO TRANSMISSÃO LONGITUDINAL D27X82MM</p> <p>FORD RANGER (ER, EQ, R_) 2.5 TD 4x4 10.1999/06.2006 80KW 109CV 2500CC WL-T 8566006 - FORD RANGER (ER, EQ, R_) 2.5 TD 4x4 04.2002/06.2006 62KW 84CV 2500CC WL-T - FORD RANGER (ET) 2.5 TDCi 4x4 05.2006/07.2012 105KW 143CV 2499CC WLAA 8566AJT 8566ATU 8566AXG</p>		<p><b>UPCR5019</b> NO. 1366029 - 1366432 - 1678260 - 2179620 - 5114407 - 6111766</p> <p>PORCA DA RODA CHAVE 19 M12X1,50X31MM ( BASE CONICA )</p> <p>FORD RANGER (TKE) 2.0 EcoBlue 4x4 (03.2019 -) 96kw 130cv 1996cm3 Pick-up FORD RANGER (TKE) 2.0 EcoBlue 4x4 (03.2019 -) 125kw 170cv 1996cm3 Pick-up FORD RANGER (TKE) 2.0 EcoBlue 4x4 (09.2018 -) 157kw 213cv 1996cm3 Pick-up FORD RANGER (TKE) 2.2 TDCi (04.2011 -) 88kw 120cv 2198cm3 Pick-up FORD RANGER (TKE) 2.2 TDCi (04.2011 -) 92kw 125cv 2198cm3 Pick-up FORD RANGER (TKE) 2.2 TDCi (05.2015 -) 96kw 131...</p>
	<p><b>URTE6013</b> NO. 3647540</p> <p>RETENTOR VEIO DIFERENCIAL TRANSMISSÃO D35X56X9MM</p> <p>FORD RANGER (ER, EQ, R_) 2.5 D 10.1999/04.2002 57KW 78CV 2499CC WL 8566004 - FORD RANGER (ER, EQ, R_) 2.5 D 4x4 10.1999/04.2002 57KW 78CV 2499CC WL 8566005 - FORD RANGER (ER, EQ, R_) 2.5 TD 04.2002/06.2006 62KW 84CV 2500CC WL-T 8566086 - FORD RANGER (ER, EQ, R_) 2.5 TD 4x4 10.1999/06.2006 80KW 109CV 2500CC WL-T 8566006 - FORD RANGER (ER, EQ, R_) 2.5 TD 4x4 04.2002/06.2006 62KW 84CV 2500CC WL-T - F...</p>		<p><b>URTE6013</b> NO. 3647540</p> <p>RETENTOR VEIO DIFERENCIAL TRANSMISSÃO D35X56X9MM</p> <p>FORD RANGER (ER, EQ, R_) 2.5 D 10.1999/04.2002 57KW 78CV 2499CC WL 8566004 - FORD RANGER (ER, EQ, R_) 2.5 D 4x4 10.1999/04.2002 57KW 78CV 2499CC WL 8566005 - FORD RANGER (ER, EQ, R_) 2.5 TD 04.2002/06.2006 62KW 84CV 2500CC WL-T 8566086 - FORD RANGER (ER, EQ, R_) 2.5 TD 4x4 10.1999/06.2006 80KW 109CV 2500CC WL-T 8566006 - FORD RANGER (ER, EQ, R_) 2.5 TD 4x4 04.2002/06.2006 62KW 84CV 2500CC WL-T - F...</p>







	<p><b>UTR0630</b> NO. 6045648</p> <p>TAMPÃO RADIADOR</p> <p>FORD RANGER (ER, EQ, R_) 2.5 D (De 1999.10 Até 2002.04) 57kW 78cv 2499cm3 Pick-up -          FORD RANGER (ER, EQ, R_) 2.5 D 4x4 (De 1999.10 Até 2002.04) 57kW 78cv 2499cm3 Pick-up -          FORD RANGER (ER, EQ, R_) 2.5 TD (De 2002.04 Até 2006.06) 62kW 84cv 2500cm3 Pick-up -          FORD RANGER (ER, EQ, R_) 2.5 TD 4x4 (De 2002.04 Até 2006.06) 62kW 84cv 2500cm3 Pick-up -          FORD RANGER (ER, EQ, R_) 2.5 TD 4x4 (De 2002.04 Até 2006.06) 62kW 84cv 2500cm3 Pick-up -          FORD RANGER (ER, EQ, R_) 2.5 TD 4x4 (De 2002.04 Até 2006.06) 62kW 84cv 2500cm3 Pick-up -</p>		<p><b>UTR0847</b> NO. 1224233 - 1301104 - 3M5H8100AC</p> <p>TAMPÃO RESERVATÓRIO LIQUIDO REFRIGERAÇÃO</p> <p>FORD RANGER (TKE) 2.2 TDCi (A Partir de 04.11) 120cv 2198cc Pick-up - FORD RANGER (TKE) 2.2 TDCi (A Partir de 04.11) 125cv 2198cc Pick-up - FORD RANGER (TKE) 2.2 TDCi 4x4 (A Partir de 04.11) 125cv 2198cc Pick-up - FORD RANGER (TKE) 2.2 TDCi 4x4 (A Partir de 04.11) 150cv 2198cc Pick-up - FORD RANGER (TKE) 3.2 TDCi 4x4 (A Partir de 04.11) 200cv 3198cc Pick-up</p>
	<p><b>UTR0957</b> NO. XM348100AB - 1351958 - 1455876 - 4026783 - 4137897 - F87H8100AA - XM348100EB - YL848100HAA</p> <p>TAMPÃO DO RADIADOR</p> <p>FORD RANGER (ER, EQ, R_) 2.5 D (De 10.1999 Até 04.2002) 57kW 78cv 2499cm3 Pick-up - FORD RANGER (ER, EQ, R_) 2.5 D 4x4 (De 10.1999 Até 04.2002) 57kW 78cv 2499cm3 Pick-up - FORD RANGER (ER, EQ, R_) 2.5 TD (De 04.2002 Até 06.2006) 62kW 84cv 2500cm3 Pick-up - FORD RANGER (ER, EQ, R_) 2.5 TD 4x4 (De 04.2002 Até 06.2006) 62kW 84cv 2500cm3 Pick-up - FORD RANGER (ER, EQ, R_) 2.5 TD 4x4 (De 10.1999 Até 06...)</p>		<p><b>UTR0958</b> NO. XM348100AB - 1351958 - 1455876 - 4026783 - 4137897 - F87H8100AA - XM348100EB - YL848100HAA</p> <p>TAMPÃO RADIADOR</p> <p>FORD RANGER (ER, EQ, R_) 2.5 D (De 10.1999 Até 04.2002) 57kW 78cv 2499cm3 Pick-up - FORD RANGER (ER, EQ, R_) 2.5 D 4x4 (De 10.1999 Até 04.2002) 57kW 78cv 2499cm3 Pick-up - FORD RANGER (ER, EQ, R_) 2.5 TD (De 04.2002 Até 06.2006) 62kW 84cv 2500cm3 Pick-up - FORD RANGER (ER, EQ, R_) 2.5 TD 4x4 (De 04.2002 Até 06.2006) 62kW 84cv 2500cm3 Pick-up - FORD RANGER (ER, EQ, R_) 2.5 TD 4x4 (De 10.1999 Até 06...)</p>
	<p><b>UVT10000</b> NO. 145893 - 6M34-3219-AA</p> <p>VEIO DA TRANSMISSÃO DA FRENTE LADO ESQUERDO</p> <p>FORD RANGER (ET) 2.5 TDCi 4x4 05.2006/07.2012 105KW 143CV 2499CC WLAA 8566AJT 8566ATU 8566AXG - FORD RANGER (ET) 3.0 TDCi 4x4 05.2006/07.2012 115KW 156CV 2953CC WEC MD30DITC 8566AMI 8566ATV 8566AXH</p>		<p><b>W5040</b> NO. EER2219A</p> <p>POLIE DA CAMBOTA (4+7 PISTAS)</p> <p>FORD RANGER (ER, EQ, R_): 2.5 D 10.1999/04.2002 57KW 78CV 2499CC - FORD RANGER (ER, EQ, R_): 2.5 D 4x4 10.1999/04.2002 57KW 78CV 2499CC - FORD RANGER (ER, EQ, R_): 2.5 TD 04.2002/06.2006 62KW 84CV 2500CC - FORD RANGER (ER, EQ, R_): 2.5 TD 4x4 04.2002/06.2006 62KW 84CV 2500CC - FORD RANGER (ER, EQ, R_): 2.5 TD 4x4 10.1999/06.2006 80KW 109CV 2500CC</p>
	<p><b>W5116</b> NO. 1088891 - 1226639 - 1329202 - 1377588 - 1675115 - 1708966 - 4C106B319AA - 4C106B319BA - 9C106...</p> <p>POLIE DA CAMBOTA (7 PISTAS)</p> <p>FORD RANGER (TKE) 2.2 TDCi (APÓS 04-2011) 120CV 2198CC - FORD RANGER (TKE) 2.2 TDCi (APÓS 04-2011) 125CV 2198CC - FORD RANGER (TKE) 2.2 TDCi 4X4 (APÓS 04-2011) 125CV 2198CC - FORD RANGER (TKE) 2.2 TDCi 4X4 (APÓS 04-2011) 150CV 2198CC</p>		<p><b>Y3233</b> NO. 1473166 - 1481984 - 3395499 - 4432023 - 6586309 - 6789185</p> <p>PARAFUSO DA RODA CAVILHA M12X1,50X48MM</p> <p>FORD RANGER (ER, EQ, R_) 2.5 TD 4x4 (04.2002 - 06.2006) 62kw 84cv 2500cm3 Pick-up FORD RANGER (ER, EQ, R_) 2.5 TD 4x4 (10.1999 - 06.2006) 80kw 109cv 2500cm3 Pick-up FORD RANGER (ET) 2.5 TDCi 4x4 (05.2006 - 07.2012) 105kw 143cv 2499cm3 Pick-up FORD RANGER (ET) 3.0 TDCi 4x4 (05.2006 - 07.2012) 115kw 156cv 2953cm3 Pick-up</p>
	<p><b>Z41158</b> NO. 1656747 - 1825595 - 1752024 - 6740771 - 4852244</p> <p>MOLA DE FIXAÇÃO TIPO PORCA</p> <p>FORD RANGER (TKE) 2.0 EcoBlue 4x4 (03.2019 -) 96kw 130cv 1996cm3 Pick-up FORD RANGER (TKE) 2.0 EcoBlue 4x4 (03.2019 -) 125kw 170cv 1996cm3 Pick-up FORD RANGER (TKE) 2.0 EcoBlue 4x4 (09.2018 -) 157kw 213cv 1996cm3 Pick-up FORD RANGER (TKE) 2.2 TDCi (04.2011 -) 88kw 120cv 2198cm3 Pick-up FORD RANGER (TKE) 2.2 TDCi (04.2011 -) 92kw 125cv 2198cm3 Pick-up FORD RANGER (TKE) 2.2 TDCi (05.2015 -) 96kw 131...</p>		<p><b>Z57104</b> NO. 4831516</p> <p>MOLA DO PAINEL DA PORTA</p> <p>FORD RANGER (A partir de 2012)</p>

FORD S-MAX

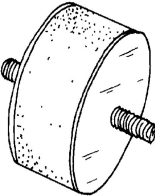







	<p><b>A2323</b> NO. 1417257 - 1453047 - 6G916F012DB - 6G916F012DC - 6G916F012DD</p> <p>APOIO DO MOTOR FRENTE LADO DIREITO</p> <p>FORD S-MAX (WA6): 1.8 TDCi 05.2006/12.2014 92KW 125CV 1753CC</p>		<p><b>A2460</b> NO. 1377259 - 1381836 - 1406414 - 1441597 - 1734710 - 1761001 - 5183155 - AG913K155BAB</p> <p>APOIO SUPORTE AMORTECEDOR FRENTE ( GASTA 2 UNIDADES )</p> <p>FORD S-MAX (CJ, WA6) 1.5 EcoBoost 01.2015/06.2018 118KW 160CV 1499CC UNCK UNCL UNCI 8566BKJ - FORD S-MAX (CJ, WA6) 1.5 EcoBoost desde 07.2018 121KW 165CV 1499CC C15HDTX UNCP 8566BRD - FORD S-MAX (CJ, WA6) 2.0 EcoBlue desde 07.2018 88KW 120CV 1995CC YNCA 8566BKL - FORD S-MAX (CJ, WA6) 2.0 EcoBlue desde 07.2018 110KW 150CV 1995CC YMBC 8566BKM - FORD S-MAX (CJ, WA6) 2.0 EcoBlue desde 07.2018 140KW 19...</p>
	<p><b>A2546</b> NO. 1376871 - 1417258 - 1453215 - 1453239 - 6G91 6F012 EB - 6G91 6F012 EC - 6G91 6F012 ED - 6G91 6F012 E...</p> <p>APOIO DO MOTOR PARTE DA FRENTE LADO DIREITO</p> <p>FORD S-MAX (WA6) 2.0 TDCi (De 11.2007 Até 12.2014) 85kW 115cv 1997cm3 Veículo multiuso - FORD S-MAX (WA6) 2.0 TDCi (De 05.2006 Até 12.2014) 96kW 130cv 1997cm3 Veículo multiuso - FORD S-MAX (WA6) 2.0 TDCi (De 05.2006 Até 12.2014) 100kW 136cv 1997cm3 Veículo multiuso - FORD S-MAX (WA6) 2.0 TDCi (De 05.2006 Até 12.2014) 103kW 140cv 1997cm3 Veículo multiuso - FORD S-MAX (WA6) 2.0 TDCi (De 03.2010 Até ...)</p>		<p><b>F1705-I</b> NO. 1446290 - 1446293</p> <p>FOLE DA TRANSMISSÃO JUNTO À CAIXA</p> <p>FORD S-MAX (WA6) 2.5 ST 05.2006/12.2014 162KW 220CV 2521CC HUWA 8566AEW</p>

	<p><b>KF1705I</b> NO. 1446290 - 1446293</p> <p><b>KIT FOLE DA TRANSMISSÃO JUNTO À CAIXA</b></p> <p>FORD S-MAX (WA6) 2.5 ST 05.2006/12.2014 162KW 220CV 2521CC HUWA 8566AEW</p> <p>d107x110mm 1f-d97mm 1f-d29mm</p>		<p><b>KF1974-I</b> NO. 1446291 - 1446298 - 1459738 - 1459764 - 1459773 - 1460786</p> <p><b>KIT DE FOLE DO CARDAN JUNTO À CAIXA</b></p> <p>FORD S-MAX (WA6): 1.6 EcoBoost 02.2011/12.2014 118KW 160CV 1596CC - FORD S-MAX (WA6): 1.8 TDCi 05.2006/12.2014 92KW 125CV 1753CC - FORD S-MAX (WA6): 2.0 TDCi 11.2007/12.2014 85KW 115CV 1997CC - FORD S-MAX (WA6): 2.0 TDCi 05.2006/12.2014 96KW 130CV 1997CC - FORD S-MAX (WA6): 2.0 TDCi 05.2006/12.2014 100KW 136CV 1997CC - FORD S-MAX (WA6): 2.0 TDCi 05.2006/12.2014 103KW 140CV 1997CC - FORD S-MAX (WA6)...</p> <p>d97x91mm 1f-d88mm 1f-d33mm</p>
	<p><b>KUBT3027</b> NO. 1223615 - 1223616 - 1583139 - 1583140 - 3M5Z-2221-BB - 6G91-2B294-AC - CV6Z-2B121-A</p> <p><b>KIT BORRACHAS TRAVAIO PINÇA FRENTE ATE/TEVES 57MM</b></p> <p>FORD S-MAX (CJ, WA6) 2.0 EcoBoost desde 01.2015 176KW 240CV 1999CC R9Ci R9CD 8566BKK - FORD S-MAX (WA6) 1.6 EcoBoost 02.2011/12.2014 118KW 160CV 1596CC JTWA JTWB 8566AWW - FORD S-MAX (WA6) 1.6 TDCi 02.2011/12.2014 85KW 115CV 1560CC T1WB T1WA 8566AXF - FORD S-MAX (WA6) 2.0 05.2006/12.2014 107KW 145CV 1999CC AOWA AOWB TBWB TBWA 8566AER - FORD S-MAX (WA6) 2.0 EcoBoost 03.2010/12.2014 149KW 203CV 1999...</p> <p>d70x13mm d66x3mm d14x9mm d43mm 1f59mm 1f-d5mm</p>		<p><b>Q2013</b> NO. 1048510 - 1475481 - 1754892 - 6171239</p> <p><b>UNIÃO DO ESCAPE 60x64,5x90mm</b></p> <p>FORD S-MAX</p> <p>90x70x92mm 1f-d60mm</p>
	<p><b>R225074</b> NO. 1697700 - AV616C700AD</p> <p><b>TUBO DO AR SOBREALIMENTAÇÃO</b></p> <p>FORD S-MAX (WA6) 2.0 TDCi (De 11.2007 Até 12.2014) 85kW 115cv 1997cm3 Veículo multiuso - FORD S-MAX (WA6) 2.0 TDCi (De 05.2006 Até 12.2014) 103kW 140cv 1997cm3 Veículo multiuso - FORD S-MAX (WA6) 2.0 TDCi (De 03.2010 Até 12.2014) 120kW 163cv 1997cm3 Veículo multiuso -</p> <p>B73-42/47mm 73mm</p>		<p><b>R225079</b> NO. 1697700 - AV616C700AD</p> <p><b>TUBO DO AR SOBREALIMENTAÇÃO</b></p> <p>FORD S-MAX (WA6) 2.0 TDCi (De 11.2007 Até 12.2014) 85kW 115cv 1997cm3 Veículo multiuso - FORD S-MAX (WA6) 2.0 TDCi (De 05.2006 Até 12.2014) 103kW 140cv 1997cm3 Veículo multiuso - FORD S-MAX (WA6) 2.0 TDCi (De 03.2010 Até 12.2014) 120kW 163cv 1997cm3 Veículo multiuso -</p> <p>B136-48/49mm 73x58mm</p>
	<p><b>R225462</b> NO. 1303478 - 3M5Q6A646AA</p> <p><b>TUBO DO RADIADOR DO ÓLEO COM JUNTAS</b></p> <p>FORD S-MAX (WA6) 2.0 TDCi 05.2006/12.2014 100KW 136CV 1997CC AZWC UKWA 8566APW - FORD S-MAX (WA6) 2.0 TDCi 05.2006/12.2014 103KW 140CV 1997CC UFWA QXWC QXWB QXWA 8566AES - FORD S-MAX (WA6) 2.0 TDCi 11.2007/12.2014 85KW 115CV 1997CC KLWA TYWA 8566AML - FORD S-MAX (WA6) 2.0 TDCi 03.2010/12.2014 120KW 163CV 1997CC TXWA 8566ATH</p> <p>d81x4mm d27x3mm d72x4mm d22x3mm 1f-d19mm 1f-d14mm</p>		<p><b>R8200</b> NO. 1251783 - 1366216 - 1430644 - 4M5G-6758-FA - 4M5G-6758-HA - 6G9G-6758-AA</p> <p><b>TUBO DO RESPIRO DO CARTER DA CABBOTA</b></p> <p>FORD S-MAX (CJ, WA6) 2.0 EcoBoost desde 01.2015 176KW 240CV 1999CC R9Ci R9CD 8566BKK - FORD S-MAX (WA6) 2.0 05.2006/12.2014 107KW 145CV 1999CC AOWA AOWB TBWB TBWA 8566AER - FORD S-MAX (WA6) 2.0 EcoBoost 03.2010/12.2014 149KW 203CV 1999CC TNWA 8566ATI - FORD S-MAX (WA6) 2.0 EcoBoost 07.2010/12.2014 146KW 199CV 1999CC TNWB 8566AUV - FORD S-MAX (WA6) 2.0 EcoBoost 07.2010/12.2014 176KW 240CV 1999CC TP...</p> <p>B117-14/14mm 37-62-38mm</p>
	<p><b>S1780</b> NO. 1376888 - 1420692 - 1441363 - 30680715</p> <p><b>SILENT-BLOC DO APOIO BRAÇO TRANSVERSAL</b></p> <p>FORD S-MAX (WA6) 1.6 EcoBoost (De 2011.02 Até 2014.12) 118kW 160cv 1596cm3 Veículo multiuso - FORD S-MAX (WA6) 2.0 (De 2006.05 Até 2014.12) 107kW 145cv 1999cm3 Veículo multiuso - FORD S-MAX (WA6) 2.0 Flexifuel (De 2006.05 Até 2014.12) 107kW 145cv 1999cm3 Veículo multiuso - FORD S-MAX (WA6) 2.0 EcoBoost (De 2010.07 Até 2014.12) 146kW 199cv 1999cm3 Veículo multiuso -</p> <p>B96-42mm c29mm 1f-d12mm</p>		<p><b>S1844</b> NO. 1507181 - 1507182SR - 1883048 - 7G9N3A052BB</p> <p><b>SILENT-BLOC BRAÇO SUSPENSÃO LADO DIREITO</b></p> <p>FORD S-MAX (WA6) 1.6 EcoBoost (De 2011.02 Até 2014.12) 118kW 160cv 1596cm3 Veículo multiuso - FORD S-MAX (WA6) 1.6 TDCi (De 2011.02 Até 2014.12) 85kW 115cv 1560cm3 Veículo multiuso - FORD S-MAX (WA6) 1.8 TDCi (De 2006.05 Até 2014.12) 92kW 125cv 1753cm3 Veículo multiuso - FORD S-MAX (WA6) 2.0 (De 2006.05 Até 2014.12) 107kW 145cv 1999cm3 Veículo multiuso -</p> <p>FORD S-MAX (WA6) 2... 1f-d22mm 2f-15x21mm 2f-15x18mm</p>
	<p><b>S1845</b> NO. 1507182 - 1507182SL - 1888630 - 7G9N3A053BB</p> <p><b>SILENT-BLOC BRAÇO SUSPENSÃO LADO ESQUERDO</b></p> <p>FORD S-MAX (WA6) 1.6 EcoBoost (De 2011.02 Até 2014.12) 118kW 160cv 1596cm3 Veículo multiuso - FORD S-MAX (WA6) 1.6 TDCi (De 2011.02 Até 2014.12) 85kW 115cv 1560cm3 Veículo multiuso - FORD S-MAX (WA6) 1.8 TDCi (De 2006.05 Até 2014.12) 92kW 125cv 1753cm3 Veículo multiuso - FORD S-MAX (WA6) 2.0 (De 2006.05 Até 2014.12) 107kW 145cv 1999cm3 Veículo multiuso -</p> <p>FORD S-MAX (WA6) 2... 1f-d22mm 2f-15x21mm 2f-15x18mm</p>		<p><b>S2157</b> NO. 2051600 - E1GC-5K067-AD</p> <p><b>SILENT-BLOC DO EIXO DA SUSPENSÃO TRÁS PARTE DA FRENTE</b></p> <p>FORD S-MAX (CJ, WA6) 1.5 EcoBoost (01.2015 - 06.2018) 118kW 160cv 1499cm3 Veículo multiuso FORD S-MAX (CJ, WA6) 2.0 EcoBoost (01.2015 -) 176kW 240cv 1999cm3 Veículo multiuso FORD S-MAX (CJ, WA6) 2.0 TDCi (01.2015 - 06.2018) 88kW 120cv 1997cm3 Veículo multiuso FORD S-MAX (CJ, WA6) 2.0 TDCi (01.2015 - 06.2018) 110kW 150cv 1997cm3 Veículo multiuso FORD S-MAX (CJ, WA6) 2.0 TDCi (01.2015 - 06.2018) 132...</p> <p>d68x74mm c-48mm-dc-60mm-1f-d26mm</p>
	<p><b>S2158</b> NO. 2051600 - E1GC-5K067-AD</p> <p><b>SILENT-BLOC DO EIXO DA SUSPENSÃO TRÁS PARTE DE TRÁS</b></p> <p>FORD S-MAX (CJ, WA6) 1.5 EcoBoost (01.2015 - 06.2018) 118kW 160cv 1499cm3 Veículo multiuso FORD S-MAX (CJ, WA6) 2.0 EcoBoost (01.2015 -) 176kW 240cv 1999cm3 Veículo multiuso FORD S-MAX (CJ, WA6) 2.0 TDCi (01.2015 - 06.2018) 88kW 120cv 1997cm3 Veículo multiuso FORD S-MAX (CJ, WA6) 2.0 TDCi (01.2015 - 06.2018) 110kW 150cv 1997cm3 Veículo multiuso FORD S-MAX (CJ, WA6) 2.0 TDCi (01.2015 - 06.2018) 132...</p> <p>d70x78mm c-48mm-dc-60mm-1f-d26mm</p>		<p><b>T1264</b> NO. 1469020 - 1478582 - 30748427 - 6G9N5484UA - 6G9N5484UB</p> <p><b>BATENTE DA BARRA ESTABILIZADORA DA FRENTE</b></p> <p>FORD S-MAX (WA6) 1.6 EcoBoost 02.2011/12.2014 118KW 160CV 1596CC JTWA JTWB 8566AWW - FORD S-MAX (WA6) 1.6 TDCi 02.2011/12.2014 85KW 115CV 1560CC T1WB T1WA 8566AXF - FORD S-MAX (WA6) 1.8 TDCi 05.2006/12.2014 92KW 125CV 1753CC QYWA 8566AEU - FORD S-MAX (WA6) 2.0 05.2006/12.2014 107KW 145CV 1999CC AOWA AOWB TBWB TBWA 8566AER - FORD S-MAX (WA6) 2.0 EcoBoost 03.2010/12.2014 149KW 203CV 1999CC TNWA 8566...</p> <p>52x46x47mm 1f-d22mm</p>
	<p><b>U7033K</b> NO. 1212679 - 1212679 - 1332662 - 1474287 - 157C-3334-AA - 3M51-3334-AA</p> <p><b>ORINGS BOMBA DIREÇÃO ASSITIDA</b></p> <p>FORD S-MAX (CJ, WA6) 2.0 EcoBoost (01.2015 -) 176kW 240cv 1999cm3 Veículo multiuso FORD S-MAX (CJ, WA6) 2.0 TDCi (01.2015 - 06.2018) 88kW 120cv 1997cm3 Veículo multiuso FORD S-MAX (CJ, WA6) 2.0 TDCi (01.2015 - 06.2018) 110kW 150cv 1997cm3 Veículo multiuso FORD S-MAX (CJ, WA6) 2.0 TDCi (01.2015 - 06.2018) 132kW 180cv 1997cm3 Veículo multiuso FORD S-MAX (CJ, WA6) 2.0 TDCi Bi-Turbo (01.2015 - 06.2018) 1...</p> <p>d11x2mm d10x2mm 1f-d7mm 1f-d6mm</p>		<p><b>UAP81292</b> NO. 1748294 - BG9Q9E568AA</p> <p><b>ANILHA PROTEÇÃO TÉRMICA INJECTORES</b></p> <p>FORD S-MAX (WS) 2.2 TDCi (De 03-2008 Até 12-2012) 129KW 175CV 2179cc Veículo multiuso FORD S-MAX (WS) 2.2 TDCi (De 07-2010 Até 12-2014) 147kW 200CV 2179cc Veículo multiuso</p> <p>d16x1mm 1f-d7mm</p>

	<p><b>UAP81292</b> NO. 1748294 - BG9Q9E568AA</p> <p>ANILHA PROTEÇÃO TÉRMICA INJECTORES</p> <p>FORD S-MAX (WS) 2.2 TDCi (De 03-2008 Até 12-2012) 129kW 175CV 2179cc Veículo multiuso FORD S-MAX (WS) 2.2 TDCi (De 07-2010 Até 12-2014) 147kW 200CV 2179cc Veículo multiuso</p> <p>d16x1mm 1f-d7mm</p>		<p><b>UAP81312</b> NO. 1715204 - 9M5Q9E568BA</p> <p>ANILHA DE PROTEÇÃO TÉRMICA INJECTORES</p> <p>FORD S-MAX (WA6) 2.0 TDCi (De 11.2007 Até 12.2014) 85kW 115cv 1997cm3 Veículo multiuso - FORD S-MAX (WA6) 2.0 TDCi (De 05.2006 Até 12.2014) 100kW 136cv 1997cm3 Veículo multiuso - FORD S-MAX (WA6) 2.0 TDCi (De 05.2006 Até 12.2014) 103kW 140cv 1997cm3 Veículo multiuso - FORD S-MAX (WA6) 2.0 TDCi (De 03.2010 Até 12.2014) 120kW 163cv 1997cm3 Veículo multiuso -</p> <p>d14x1.5mm 1f-d7mm</p>
	<p><b>UAP81313</b> NO. 1364301 - 4M5Q9M577AA</p> <p>ANILHA PROTEÇÃO TÉRMICA INJECTORES</p> <p>FORD S-MAX (WA6) 1.8 TDCi 05.2006/12.2014 92KW 125CV 1753CC QYWA 8566AEU</p> <p>d13x2mm 1f-d7mm</p>		<p><b>UCRZ1103</b> NO. 1504137 - 1504139 - 1505652 - 1505654 - 1600370 - 1600374 - 1727233 - 1727237 - 1757879 - 1774665 - ...</p> <p>CRUZETA TRANSMISSÃO TRIPOIDE D45MM/26 DENTES</p> <p>FORD S-MAX (CJ, WA6) 2.0 EcoBoost desde 01.2015 176KW 240CV 1999CC R9CI R9CD 8566BKK - FORD S-MAX (CJ, WA6) 2.0 TDCi 01.2015/06.2018 88KW 120CV 1997CC UFCA UFCD 8566BKL - FORD S-MAX (CJ, WA6) 2.0 TDCi 01.2015/06.2018 110KW 150CV 1997CC T7CK T7CL T7CJ T7CI 8566BKM - FORD S-MAX (CJ, WA6) 2.0 TDCi 01.2015/06.2018 132KW 180CV 1997CC T8CG T8CI T8CJ T8CH 8566BKN - FORD S-MAX (CJ, WA6) 2.0 TDCi BI-T...</p> <p>45mm 26 DENTES</p>
	<p><b>UMV25325</b> NO. 1580939 - AM8A6J-7J132-ABT</p> <p>MANETE PUNHO TOPO ALAVANCA MUDANÇAS 5 VELOCIDADES F14MM</p> <p>FORD S-MAX (WA6) 1.6 EcoBoost (De 02.2011 Até 12.2014) 118KW 160cv 1596cm3 Veículo multiuso - FORD S-MAX (WA6) 1.6 TDCi (De 02.2011 Até 12.2014) 85KW 115cv 1560cm3 Veículo multiuso - FORD S-MAX (WA6) 1.8 TDCi (De 05.2006 Até 12.2014) 92KW 125cv 1753cm3 Veículo multiuso - FORD S-MAX (WA6) 2.0 (De 05.2006 Até 12.2014) 107kW 145cv 1999cm3 Veículo multiuso - FORD S-MAX (WA6) 2.0 EcoBoost (De 07.2010 A...</p> <p>d46x90mm 1f-d14mm</p>		<p><b>UMV26813</b> NO. 1798600 - 7G9R7217CKD</p> <p>MANETE PUNHO TOPO ALAVANCA MUDANÇAS 6 VELOCIDADES F11/30MM</p> <p>FORD S-MAX (WA6): 1.6 EcoBoost 02.2011/12.2014 118KW 160CV 1596CC - FORD S-MAX (WA6): 2.0 05.2006/12.2014 107KW 145CV 1999CC - FORD S-MAX (WA6): 2.0 EcoBoost 07.2010/12.2014 146KW 199CV 1999CC - FORD S-MAX (WA6): 2.0 EcoBoost 03.2010/12.2014 149KW 203CV 1999CC - FORD S-MAX (WA6): 2.0 EcoBoost 07.2010/12.2014 176KW 240CV 1999CC - FORD S-MAX (WA6): 2.3 07.2007/12.2014 118KW 160CV 2261CC - FORD S-MAX...</p> <p>53x47x54mm 1f-d11/30mm</p>
	<p><b>UPCR5020</b> NO. 1377747 - 1382841 - 1428137 - 1676176 - 5196786 - 5275544</p> <p>PORCA DA RODA CHAVE 21 M14X1,5X34MM ( BASE CONICA )</p> <p>FORD S-MAX (CJ, WA6) 2.0 EcoBlue (07.2018 -) 88kw 120cv 1995cm3 Veículo multiuso FORD S-MAX (CJ, WA6) 2.0 EcoBlue (07.2018 -) 110kw 150cv 1995cm3 Veículo multiuso FORD S-MAX (CJ, WA6) 2.0 EcoBlue (07.2018 -) 140kw 190cv 1995cm3 Veículo multiuso FORD S-MAX (CJ, WA6) 2.0 EcoBlue 4x4 (07.2018 -) 110kw 150cv 1995cm3 Veículo multiuso FORD S-MAX (CJ, WA6) 2.0 EcoBlue 4x4 (07.2018 -) 140kw 190cv 1995cm3 ...</p> <p>d28x34mm M14x32mm</p>		<p><b>UTR0847</b> NO. 1224233 - 1301104 - 3M5H8100AC</p> <p>TAMPÃO RESERVATÓRIO LIQUIDO REFRIGERAÇÃO</p> <p>FORD S-MAX (WA6) 1.6 EcoBoost (02.11 a 12.14) 160cv 1596cc Veículo multiuso - FORD S-MAX (WA6) 2.0 (05.06 A 12.14) 145cv 1999cc Veículo multiuso - FORD S-MAX (WA6) 2.0 Flexifuel (05.06 A 12.14) 145cv 1999cc Veículo multiuso - FORD S-MAX (WA6) 2.0 EcoBoost (07.10 A 12.14) 199cv 1999cc Veículo multiuso - FORD S-MAX (WA6) 2.0 EcoBoost (03.10 A 12.14) 203cv 1999cc Veículo multiuso - FORD S-M...</p> <p>d62x35mm 1f-d50x16mm</p>
	<p><b>UTV83002</b> NO. 2S6Q6730AA</p> <p>TAMPÃO VEDAÇÃO BUJÃO</p> <p>FORD S-MAX (WS) 1.6 TDCi (De 02-2011 Até 12-2014) 85kW 115CV 1560cc Veículo multiuso</p> <p>20x18mm c13mm d10mm</p>		<p><b>UTV83010</b> NO. 1013938 - 97JM6730BA</p> <p>TAMPÃO VEDAÇÃO BUJÃO</p> <p>FORD S-MAX (WS) 2.0 (De 05-2006 Até 12-2014) 107kW 145CV 1999cc Veículo multiuso FORD S-MAX (WS) 2.0 EcoBoost (De 07-2010 Até 12-2014) 146kW 199CV 1999cc Veículo multiuso FORD S-MAX (WS) 2.0 EcoBoost (De 03-2010 Até 12-2014) 149kW 203CV 1999cc Veículo multiuso FORD S-MAX (WS) 2.0 EcoBoost (De 07-2010 Até 12-2014) 176kW 240CV 1999cc Veículo multiuso FORD S-MAX (WS) 1.8 TDCi (De 05-2006 Até 12-2...</p> <p>d28x35mm c19mm d13mm</p>
	<p><b>W5016</b> NO. 1231959 - 1490842 - 1520590 - 1683820 - 1837783 - 3MSQ-6B319-AA - 7MSQ-6B319-AA - 7MSQ-6B319-AB - 9M...</p> <p>POLIE DA CAMBOTA (6 pistas)</p> <p>FORD S-MAX (WA6) 2.0 TDCi 05.2006/12.2014 96KW 130CV 1997CC AZWA 8566AET - FORD S-MAX (WA6) 2.0 TDCi 05.2006/12.2014 103KW 140CV 1997CC UFWA QXWC QXWB QXWA 8566AES</p> <p>d152.5mm d16mm</p>		<p><b>W5081</b> NO. 1079166 - 1104415 - 1139286 - 1143413 - 1151392 - 1S4Q6A345AA - 1S4Q6B318AE - 1S4Q6B319AE - 1S4Q6B31...</p> <p>POLIE DA CAMBOTA (6 PISTAS)</p> <p>FORD S-MAX (WA6) 1.8 TDCi 05.2006/12.2014 92KW 125CV 1753CC QYWA 8566AEU</p> <p>d140/153mm d14.6mm</p>
	<p><b>W5180</b> NO. 1682158 - 31460551 - 5087792 - 5348415 - AG9E6B319AA - AG9E6B319AB - AG9E6B319AC - AG9E6B319AD</p> <p>POLIE DA CAMBOTA (6 PISTAS)</p> <p>FORD S-MAX (WA6): 2.0 EcoBoost 03.2010/12.2014 149KW 203CV 1999CC - FORD S-MAX (WA6): 2.0 EcoBoost 07.2010/12.2014 176KW 240CV 1999CC</p> <p>d162/153mm d46mm</p>		<p><b>Z50130</b> NO. 11589289</p> <p>MOLA REBITE FIXAÇÃO</p> <p>FORD S-MAX (CJ, WA6) 1.5 EcoBoost (01.2015 -06.2018) 118kw 160cv 1499cm3 Veículo multiuso FORD S-MAX (CJ, WA6) 1.5 EcoBoost (07.2018 -) 121kw 165cv 1499cm3 Veículo multiuso FORD S-MAX (CJ, WA6) 2.0 EcoBlue (07.2018 -) 88kw 120cv 1995cm3 Veículo multiuso FORD S-MAX (CJ, WA6) 2.0 EcoBlue (07.2018 -) 110kw 150cv 1995cm3 Veículo multiuso FORD S-MAX (CJ, WA6) 2.0 EcoBlue (07.2018 -) 140kw 190cv 1995cm3...</p> <p>d6x 18mm f-d17mm</p>
	<p><b>Z71162</b> NO. 5270438</p> <p>MOLA DO PAINEL EXTERIOR MOLDURAS</p> <p>FORD S-MAX (A partir de 2015)</p> <p>F13mm T20mm L15mm H20mm S1-7mm</p>		

	<p><b>A0405</b> NO. 11550756 - 1454274 - 1470480 - 6005152 - 711F.6038.AA</p> <p><b>APOIO SUPORTE DO MOTOR</b></p> <p>FORD TAUNUS (GBFK): 1300 08.1970/02.1976 40KW 54CV 1297CC - FORD TAUNUS (GBFK): 1600 08.1970/02.1976 53KW 72CV 1593CC - FORD TAUNUS (GBFK): 1600 08.1970/02.1976 65KW 88CV 1593CC - FORD TAUNUS (GBFK): 2000 V6 08.1970/02.1976 66KW 90CV 1998CC - FORD TAUNUS (GBFK): 2300 GT.GXL 08.1970/02.1976 79KW 107CV 2294CC - FORD TAUNUS (GBTK): 1300 01.1970/05.1975 40KW 55CV 1297CC - FORD TAUNUS (GBTK): 1600 01.1... d75x38mm 1p-d10-23mm 1p-d10-23mm</p>		<p><b>A0960</b> NO. 1454275 - 1515124 - 711F6068AB - 72HF.6068.AB - 72HF6068AA</p> <p><b>APOIO SUPORTE TRÁS DO MOTOR</b></p> <p>FORD TAUNUS 12M: 1.2 12.1951/02.1963 28KW 38CV 1164CC - FORD TAUNUS 12M: 1.5 07.1959/02.1963 40KW 54CV 1487CC - FORD TAUNUS 12M Turnier: 1.2 05.1953/02.1963 28KW 38CV 1164CC - FORD TAUNUS 12M (P4): 1.2 07.1962/04.1967 29KW 39CV 1168CC - FORD TAUNUS 12M (P4): 1.5 07.1962/04.1967 37KW 50CV 1487CC - FORD TAUNUS 12M (P4): 1.5 TS 12.1962/04.1967 40KW 54CV 1487CC - FORD TAUNUS 12M (P4): 1.5 TS 12.1962/... 166x97x55mm 1f-d13mm</p>
	<p><b>A1381</b> NO. 6094239 - 6120493 - 6122229 - 6141919 - 83BB.5K817.BA</p> <p><b>APOIO AS SUSPENSÃO DE TRÁS</b></p> <p>FORD SIERRA I Hatchback (GBC) 1.3 08.1982/12.1986 44KW 60CV 1294CC JCT 0928559 - FORD SIERRA I Hatchback (GBC) 1.6 08.1982/12.1986 55KW 75CV 1593CC LSD LCT LCS 0928560 - FORD SIERRA I Hatchback (GBC) 1.6 08.1984/12.1986 58KW 79CV 1597CC LSD - FORD SIERRA I Hatchback (GBC) 1.8 10.1984/12.1986 66KW 90CV 1796CC REB 0928595 - FORD SIERRA I Hatchback (GBC) 2.0 08.1982/10.1984 66KW 90CV 1993CC NYT 09285... d100x85mm 1f-d13mm</p>		<p><b>A1381</b> NO. 6094239 - 6120493 - 6122229 - 6141919 - 83BB.5K817.BA</p> <p><b>APOIO AS SUSPENSÃO DE TRÁS</b></p> <p>FORD SCORPIO I (GAE, GGE) 1.8 04.1985/02.1992 66KW 90CV 1796CC REC 0928598 - FORD SCORPIO I (GAE, GGE) 2.0 04.1985/08.1989 77KW 105CV 1993CC NEL N8D 0928599 - FORD SCORPIO I (GAE, GGE) 2.0 i 04.1985/02.1992 85KW 115CV 1993CC NRI NRA 0928600 - FORD SCORPIO I (GAE, GGE) 2.0 i 10.1985/12.1990 74KW 100CV 1993CC NRC NER 0928613 - FORD SCORPIO I (GAE, GGE) 2.0 i 05.1989/09.1994 88KW 120CV 1998CC N9D 092... d100x85mm 1f-d13mm</p>
	<p><b>A1389</b> NO. 6155997 - 6165106 - 87GB6068AA</p> <p><b>APOIO DA CAIXA DE VELOCIDADES</b></p> <p>FORD SIERRA I Hatchback (GBC): 2.0 10.1985/12.1986 74KW 100CV 1993CC - FORD SIERRA I Hatchback (GBC): 2.0 i 03.1985/12.1986 85KW 115CV 1993CC - FORD SIERRA I Hatchback (GBC): 2.8 XR4i 08.1982/12.1986 110KW 150CV 2792CC - FORD SIERRA I Hatchback (GBC): 2.8 XR 4x4 02.1985/12.1986 110KW 150CV 2792CC - FORD SIERRA I Hatchback (GBC): 2.3 D 08.1982/12.1986 49KW 67CV 2304CC - FORD SIERRA Turnier (BNC): 2... 167x110x56mm 2f-d8mm 1f-d13x18mm</p>		<p><b>A1389</b> NO. 6155997 - 6165106 - 85GB 6068AA - 85GB.6068.AA - 87GB6068AA</p> <p><b>APOIO DA CAIXA DE VELOCIDADES</b></p> <p>FORD SCORPIO I (GAE, GGE): 1.8 04.1985/02.1992 66KW 90CV 1796CC - FORD SCORPIO I (GAE, GGE): 2.0 i 10.1985/12.1990 74KW 100CV 1993CC - FORD SCORPIO I (GAE, GGE): 2.0 i 04.1985/08.1989 77KW 105CV 1993CC - FORD SCORPIO I (GAE, GGE): 2.0 i 04.1985/02.1992 85KW 115CV 1993CC - FORD SCORPIO I (GAE, GGE): 2.8 i 04.1985/11.1986 110KW 150CV 2792CC 167x110x56mm 2f-d8mm 1f-d13x18mm</p>
	<p><b>A1395</b> NO. 6156316 - 6172298 - 83EF6038EA - 1630999</p> <p><b>APOIO SUPORTE DE MOTOR DIREITO</b></p> <p>FORD SIERRA I Hatchback (GBC) 2.3 D 08.1982/12.1986 49KW 67CV 2304CC YTT 0928564 - FORD SIERRA II (GBG, GB4) 2.3 D 01.1987/09.1989 49KW 67CV 2304CC YTR YTT 0928737 0928670 - FORD SIERRA II Hatchback (GBC, GBG) 2.3 D 01.1987/09.1989 49KW 67CV 2304CC YTR 0928736 0928657 - FORD SIERRA II Turnier (BNG) 2.3 D 01.1987/02.1993 49KW 67CV 2304CC YTR 0928742 0928663 - FORD SIERRA Turnier (BNC) 2.3 D 08.1982... 150x107x79mm 1p-d12-50mm</p>		<p><b>A1396</b> NO. 6137369 - 6185650 - 6532935 - 6532939 - 82AB6B032BC - 85HF6038EB - 88TF6038AB</p> <p><b>APOIO SUPORTE DO MOTOR DIREITO E ESQUERDO</b></p> <p>FORD SIERRA II (GBG, GB4) 1.6 01.1987/02.1993 55KW 75CV 1597CC LSE 0928665 - FORD SIERRA II (GBG, GB4) 1.6 01.1988/02.1993 53KW 72CV 1597CC LSF 0928687 - FORD SIERRA II (GBG, GB4) 1.6 i 10.1989/02.1993 59KW 80CV 1597CC L6B 0928741 - FORD SIERRA II (GBG, GB4) 1.8 01.1987/05.1988 66KW 90CV 1796CC REDR2A 0928666 - FORD SIERRA II (GBG, GB4) 1.8 10.1987/09.1989 59KW 80CV 1796CC REFRED 0928681 - FORD SI... d108x89mm 1p-d10-27mm 1p-d10-57mm</p>
	<p><b>A1396</b> NO. 6137369 - 6185650 - 6532935 - 6532939 - 82AB6B032BC - 85HF6038EB - 88TF6038AB</p> <p><b>APOIO SUPORTE DO MOTOR DIREITO E ESQUERDO</b></p> <p>FORD SCORPIO I (GAE, GGE) 1.8 04.1985/02.1992 66KW 90CV 1796CC REC 0928598 - FORD SCORPIO I (GAE, GGE) 2.0 04.1985/08.1989 77KW 105CV 1993CC NELN8D 0928599 - FORD SCORPIO I (GAE, GGE) 2.0 i 04.1985/02.1992 85KW 115CV 1993CC NRINRA 0928600 - FORD SCORPIO I (GAE, GGE) 2.0 i 10.1985/12.1990 74KW 100CV 1993CC NRC 0928613 - FORD SCORPIO I (GAE, GGE) 2.0 i 05.1989/09.1994 88KW 120CV 1998CC N9D 092875309... d108x89mm 1p-d10-27mm 1p-d10-57mm</p>		<p><b>D0012</b> NO. 72GG4684BA</p> <p><b>CARDAN TRANSMISSÃO D146X46MM 6 FUROS 12MM</b></p> <p>FORD SIERRA 2.0 (1987 A 1993) - 2.0 16V COSWORTH 4x4 CAT (1990 A 1993) 146x146x46mm 6f-12mm</p>
	<p><b>D0036</b> NO. 1563500 - 76BG4684AA</p> <p><b>CARDAN TRANSMISSÃO</b></p> <p>FORD SIERRA I Hatchback (GBC) 1.3 08.1982/12.1986 44KW 60CV 1294CC JCT 0928559 110x110x35x43mm 6f-12x12mm</p>		<p><b>D0036</b> NO. 1563500 - 76BG4684AA</p> <p><b>CARDAN TRANSMISSÃO</b></p> <p>FORD TAUNUS 12M II (11G) 1.3 08.1966/06.1971 37KW 50CV 1305CC TV 13 L 1005355 - FORD TAUNUS 12M II Coupé (13G) 1.3 08.1966/06.1971 37KW 50CV 1305CC TV 13 L 1005359 - FORD TAUNUS 12M II Turnier (15G) 1.3 09.1966/06.1971 37KW 50CV 1305CC TV 13 L 1005402 110x110x35x43mm 6f-12x12mm</p>
	<p><b>D0037</b> NO. 1515117 - 1638947 - 6518778 - 83BG4684BA - 83GB4684BA - 88GG4684BA - GAF41</p> <p><b>CARDAN TRANSMISSÃO</b></p> <p>FORD SCORPIO I (GAE, GGE) 2.0 Ano fabric. até: 05.89, (04.85 A 08.89) 105cv 1993cc Hatchback - FORD SCORPIO I (GAE, GGE) 2.0 i (02.92 A 09.94) 115cv 1993cc Hatchback - FORD SCORPIO I (GAE, GGE) 2.0 i Ano fabric. até: 05.89, (05.89 A 09.94) 120cv 1998cc Hatchback - FORD SCORPIO I (GAE, GGE) 2.4 i (10.88 A 02.92) 125cv 2394cc Hatchback - FORD SCORPIO I (GAE, GGE) 2.4 i Ano fabric. até: 06.88... 120x135x40x46mm 6f-12x12mm</p>		<p><b>D0037</b> NO. 1515117 - 1638947 - 6518778 - 83BG4684BA - 83GB4684BA - 88GG4684BA - GAF41</p> <p><b>CARDAN TRANSMISSÃO</b></p> <p>FORD SIERRA Hatchback (GBC, GBG) 2.0 Ano fabric. a part ir de: 08.90, CÃ³digo do mot or: 2.0 HC, Tipo t rans.: TracçÃ£o integral (01.87 A 02.93) 105cv 1993cc Hatchback - FORD SIERRA Hatchback (GBC, GBG) 2.0 i DOHC Ano fabric. a part ir de: 06.92, (12.91 A 02.93) 115cv 1998cc Hatchback - FORD SIERRA Hatchback (GBC, GBG) 2.0 i Ano fabric. a part ir de: 08.90, (06.89 A 02.93) 120cv 1998cc Hatchb... 120x135x40x46mm 6f-12x12mm</p>
	<p><b>D1092</b> NO. 0598480 - 83BG4684AA</p> <p><b>CARDAN DA TRANSMISSÃO</b></p> <p>FORD TAUNUS 129x114x43mm 1p-d35x106mm</p>		<p><b>D1092</b> NO. 0598480 - 83BG4684AA</p> <p><b>CARDAN DA TRANSMISSÃO</b></p> <p>FORD SIERRA 129x114x43mm 1p-d35x106mm</p>



	<b>E0008</b> NO. 0801909 - 1591419 - 6030483 - 70GB5281AA - 801909 ESTICADOR DE ESCAPE FORD TAUNUS d44x40mm		<b>E0008</b> NO. 0801909 - 1591419 - 6030483 - 70GB5281AA - 801909 ESTICADOR DE ESCAPE FORD SCORPIO d44x40mm
	<b>E0008</b> NO. 0801909 - 1591419 - 6030483 - 70GB5281AA - 801909 ESTICADOR DE ESCAPE FORD SIERRA d44x40mm		<b>E0010</b> NO. 6048886 - 6053849 - 6111692 - 77FB5A262BD - 77FB5A262CA ESTICADOR DE ESCAPE FORD SIERRA (1.3-1.6-2.0) - SIERRA DIESEL - SIERRA (APÓS 82) - SCORPIO (APÓS 85) 73x47x38mm
	<b>E0012</b> NO. 553769 - 6030483 - 69AB5281BA ESTICADOR DE ESCAPE FORD SIERRA (1.3-1.6-2.0) - SIERRA DIESEL (1987 A 1993) - FORD SCORPIO (1985 A 1994) d47x42mm		<b>E0012</b> NO. 553769 - 6030483 - 69AB5281BA ESTICADOR DE ESCAPE FORD TAUNUS (70-83) d47x42mm
	<b>E0023</b> NO. 6111691 - 6120254 - 6122002 - 6136012 - 6162002 - 81AB5A262AC - 93BB5A262HA ESTICADOR DE ESCAPE FORD SIERRA (1.3-1.6-2.0) - SIERRA DIESEL (2.3) - SCORPIO (APÓS 89) 92x58x38mm		<b>E1018</b> NO. 1027374 - 6831302 - 6866417 - 93B85A262F - 93B85A262G - 93BB5A262GA ESTICADOR DE ESCAPE FORD SCORPIO 66x54x19mm
	<b>E80344BC</b> NO. 6567507 - 924F9740AA ESTICADOR BOMBA DE COMBUSTIVEL FORD SCORPIO I (GAE, GGE) 1.8 (04.1985 -02.1992) 66kw 90cv 1796cm3 Hatchback FORD SCORPIO I (GAE, GGE) 2.0 (04.1985 -08.1989) 77kw 105cv 1993cm3 Hatchback FORD SCORPIO I (GAE, GGE) 2.0 i (10.1985 -12.1990) 74kw 100cv 1993cm3 Hatchback FORD SCORPIO I (GAE, GGE) 2.0 i (04.1985 -02.1992) 85kw 115cv 1993cm3 Hatchback FORD SCORPIO I (GAE, GGE) 2.0 i (02.1992 -09.1994) 85kw 115cv 1998cm3 Hatchback FORD ... 371x11x10mm		<b>E80344BC</b> NO. 6567507 - 924F9740AA ESTICADOR BOMBA DE COMBUSTIVEL FORD SIERRA I Hatchback (GBC) 1.3 (08.1982 -12.1986) 44kw 60cv 1294cm3 Hatchback FORD SIERRA I Hatchback (GBC) 1.6 (10.1982 -02.1987) 51kw 69cv 1597cm3 Hatchback FORD SIERRA I Hatchback (GBC) 1.6 (08.1982 -12.1986) 55kw 75cv 1593cm3 Hatchback FORD SIERRA I Hatchback (GBC) 1.6 (08.1984 -12.1986) 58kw 79cv 1597cm3 Hatchback FORD SIERRA I Hatchback (GBC) 1.8 (10.1984 -12.1986) 66kw 90cv 1796cm3 Hatch... 371x11x10mm
	<b>E80344BC</b> NO. 6567507 - 924F9740AA ESTICADOR BOMBA DE COMBUSTIVEL FORD SIERRA II (GBG, GB4) 1.6 (01.1988 -02.1993) 53kw 72cv 1597cm3 três volumes FORD SIERRA II (GBG, GB4) 1.6 (01.1987 -02.1993) 55kw 75cv 1597cm3 três volumes FORD SIERRA II (GBG, GB4) 1.6 i (10.1989 -02.1993) 59kw 80cv 1597cm3 três volumes FORD SIERRA II (GBG, GB4) 1.8 (05.1988 -02.1993) 64kw 87cv 1769cm3 três volumes FORD SIERRA II (GBG, GB4) 1.8 (10.1987 -09.1989) 59kw 80cv 1796cm3 três volume... 371x11x10mm		<b>F0469-I</b> NO. 1016761 - 1495776 - 1579855 FOLE DA TRANSMISSÃO LADO DA CAIXA FORD SCORPIO I (GAE, GGE): 2.8 i 4x4 10.1985/11.1986 110KW 150CV 2792CC - FORD SCORPIO I (GAE, GGE): 2.9 i 4x4 05.1988/02.1993 107KW 145CV 2933CC - FORD SCORPIO I Turnier (GGE): 2.9 i 4x4 05.1988/02.1993 107KW 145CV 2933CC d85x80mm 1f-d61mm 1f-d23mm
	<b>F0469-I</b> NO. 1016761 - 1495776 - 1579855 FOLE DA TRANSMISSÃO LADO DA CAIXA FORD SIERRA Hatchback (GBC): 2.8 i XR 4x4 09.1983/12.1986 107KW 146CV 2792CC - FORD SIERRA Hatchback (GBC): 2.8 XR 4x4 02.1985/12.1986 110KW 150CV 2792CC - FORD SIERRA Turnier (BNC): 2.8 i 4x4 08.1982/12.1986 105KW 143CV 2792CC - FORD SIERRA Turnier (BNC): 2.8 i 4x4 08.1982/12.1986 107KW 146CV 2792CC - FORD SIERRA Hatchback (GBC, GBG): 2.8 i XR 4x4 01.1987/08.1988 110KW 150CV 2792CC - FORD SIERRA ... d85x80mm 1f-d61mm 1f-d23mm		<b>F0687-I</b> NO. 1160365 - 1610365 - 6060788 - 83BB3K661AA FOLE DA DIRECÇÃO FORD SIERRA MANUAL (1982 A 1986) - SCORPIO (APÓS 1985) d60x230mm 1f-d48mm 1f-d10mm
	<b>F0687-I</b> NO. 1160365 - 1610365 - 6060788 - 83BB3K661AA FOLE DA DIRECÇÃO FORD SIERRA MANUAL (1982 A 1986) - SCORPIO (APÓS 1985) d60x230mm 1f-d48mm 1f-d10mm		<b>F1081-I</b> NO. 1610365 - 617346 - 617347 - 84AB.3K661.AA FOLE DA DIRECÇÃO FORD SIERRA (1982 A 1986) d60x230mm 1f-d48mm 1f-d10mm

	<p><b>F1081-I</b> NO. 1610365 - 617346 - 617347 - 84AB.3K661.AA</p> <p>FOLE DA DIRECÇÃO</p> <p>FORD SIERRA (1982 A 1986)</p> <p>d60x230mm 1f-d48mm 1f-d10mm</p>		<p><b>F1087-I</b> NO. 1627950 - V85BB4K258BA</p> <p>FOLE DA TRANSMISSÃO LADO DA CAIXA</p> <p>FORD SCORPIO 2.8 4WD (1985 A 1998) - SIERRA 4WD 2.0i - 2.8i - 2.9i - (1982 A 1993)</p> <p>d82x116 1f-d64mm 1f-d18mm</p>
	<p><b>F1668-I</b> NO. 1619061 - 83BB.3K661.BD</p> <p>FOLE DA DIRECÇÃO DIREITO E ESQUERDO</p> <p>FORD SIERRA 1.3 - 1.6 - 1.8 - 1.8TD (1982 A 1993) - FORD SCORPIO 1.8 - 2.0 - 2.0i - 2.4i - 2.5D - 2.5TD - 2.8i - 2.9i (1985 A 1994)</p> <p>d62x200mm 1f-d37mm 1f-d10mm</p>		<p><b>F1855-I</b> NO. 2T143K661AA - 4381841 - 6177346 - 6182218 - 6935233 - 86AB3K661A1A - 92AB3K661AA - 98AG3K661AA</p> <p>FOLE DA DIRECÇÃO LADO DIREITO E ESQUERDO</p> <p>FORD SIERRA Hatchback (GBC, GBG): 1.6 01.1988/02.1993 53KW 72CV 1597CC - FORD SIERRA Hatchback (GBC, GBG): 1.6 01.1987/02.1993 55KW 75CV 1597CC - FORD SIERRA Hatchback (GBC, GBG): 1.6 i 10.1989/02.1993 59KW 80CV 1598CC - FORD SIERRA Hatchback (GBC, GBG): 1.8 10.1987/05.1988 59KW 80CV 1796CC - FORD SIERRA Hatchback (GBC, GBG): 1.8 05.1988/02.1993 64KW 87CV 1769CC - FORD SIERRA Hatchback (GBC, GBG):...</p> <p>d60x220mm 1f-d37mm 1f-d13mm</p>
	<p><b>F4023</b> NO. 1568355</p> <p>FOLE DIRECÇÃO DIREITO</p> <p>FORD TAUNUS 12M 1.3 (1966 A 1971)</p> <p>d62x210mm d44mm 1f-d27mm 1f-d10mm</p>		<p><b>F4037</b> NO. YC153K661BA - 4059922 - 4602027 - YC153K661BB</p> <p>FOLE DIRECÇÃO ( GASTA 2 UNIDADES )</p> <p>FORD SIERRA 1.6 82-86</p> <p>d72/54x240mm 1f-d68mm 1f-d10mm</p>
	<p><b>KF1810</b> NO. 1016760 - 1058372 - 1073805 - 1073846 - 1638320 - 6043191 - 6053206 - 77TT3A331FA - 95SX4K258DA -...</p> <p>FOLE DO LADO DA RODA (DIAM. 78mm)</p> <p>FORD SCORPIO - SIERRA - SAPHIRE 4x4</p> <p>d93x103mm 1f-d20mm 1f-d78mm</p>		<p><b>L3041</b> NO. 6005983 - 74BB.3B197.AA</p> <p>CASQUILHO DA BARRA ESTABILIZADORA</p> <p>FORD TAUNUS (1976 A 1992)</p> <p>d50x17mm 1f-d20mm</p>
	<p><b>L3043</b> NO. 1481463 - 1481464 - 71BB.5K498.BB - LEM1700</p> <p>CASQUILHO DAS PONTAS DA BARRA ESTABILIZADORA</p> <p>FORD TAUNUS (GBFK) 1300 08.1970/02.1976 40KW 54CV 1297CC JA 0928346 1005533 - FORD TAUNUS (GBFK) 1600 08.1970/02.1976 53KW 72CV 1593CC LCJ 0928348 1005535 - FORD TAUNUS (GBFK) 1600 08.1970/02.1976 65KW 88CV 1593CC LE 0928349 1005536 - FORD TAUNUS (GBFK) 1600 01.1974/05.1975 50KW 68CV 1593CC LAD 0928395 - FORD TAUNUS (GBFK) 2000 V6 08.1970/02.1976 66KW 90CV 1998CC NY 0928350 1005537 - FORD TAUNUS (...)</p> <p>d28x42mm 1f-d10mm</p>		<p><b>M6031</b> NO. 6157398 - 6158920 - 6159188 - 6160937 - 6172323 - 6172323 - 6615274 - 6642509 - 6692742</p> <p>JUNTA DE ESCAPE</p> <p>FORD SCORPIO I (GAE, GGE) 2.4 i 09.1986/09.1988 96KW 130CV 2394CC ARC 0928648 - FORD SCORPIO I (GAE, GGE) 2.4 i 10.1988/02.1992 92KW 125CV 2394CC ARD 0928755 - 0928706 - FORD SCORPIO I (GAE, GGE) 2.4 i Cat 10.1988/09.1994 92KW 125CV 2394CC ARD 0928755 - FORD SCORPIO I (GAE, GGE) 2.9 i 09.1986/09.1994 107KW 145CV 2933CC BRD BRE BRF 0928651 - FORD SCORPIO I (GAE, GGE) 2.9 i 09.1986/09.1994 110KW 150...</p> <p>106x68mm 1f-d51mm</p>
	<p><b>M6031</b> NO. 6157398 - 6158920 - 6159188 - 6160937 - 6172323 - 6615274 - 6642509 - 6692742</p> <p>JUNTA DE ESCAPE</p> <p>FORD SIERRA II (GBG, GB4) 2.9 i 08.1988/02.1993 107KW 145CV 2935CC B4C B4B 0928739 0928694 - FORD SIERRA II Hatchback (GBC, GBG) 2.9 i 08.1988/02.1993 107KW 145CV 2936CC B4C B4B 0928738 0928693 - FORD SIERRA II Hatchback (GBC, GBG) 2.9 i XR 4x4 08.1988/02.1993 107KW 145CV 2936CC B4C B4B 0928691 - FORD SIERRA II Turnier (BNG) 2.9 4x4 08.1988/02.1993 107KW 145CV 2936CC B4C B4B 0928745 0928689</p> <p>106x68mm 1f-d51mm</p>		<p><b>M6037</b> NO. 1565558 - 6065962 - 6115136 - 6134622 - 6134623 - 6615275 - 81AB9451AA</p> <p>JUNTA DE ESCAPE</p> <p>FORD SCORPIO (1985 A 1989) - SIERRA (1982 A 1992)</p> <p>107x80mm 2f-d42mm</p>
	<p><b>M6043</b> NO. 1630835 - 6120644 - 6120664 - 6134624 - 6163389</p> <p>JUNTA DE ESCAPE</p> <p>FORD SIERRA (1986 A 1994)</p> <p>120x80mm 2f-d42mm</p>		<p><b>M6055</b> NO. 6172323</p> <p>JUNTA DE ESCAPE</p> <p>FORD SCORPIO (1985 A 1994) - SIERRA (1984 A 1994)</p> <p>110x71mm 1f-d52mm</p>
	<p><b>M6069</b> NO. 6645622</p> <p>JUNTA DE ESCAPE</p> <p>FORD SIERRA (1987 A 1989)</p> <p>120x65mm 2f-d42mm</p>		<p><b>M6079</b> NO. 1709852 - 6027648 - 749451BA</p> <p>JUNTA DE ESCAPE</p> <p>FORD TAUNUS (1976 A 1985)</p> <p>54x13mm 1f-d41mm</p>

	<p><b>M6101</b> NO. 0043181200 - 11621317264 - 2465391 - 2875126300 - 4624383 - 60510306 - 6158920 - 6159188 - 6172323 - ...</p> <p><b>JUNTA DE ESCAPE</b></p> <p>FORD SIERRA DIESEL (1982 A 1993) - SCORPIO DIESEL (1985 A 1992)</p> <p>103x72x2mm 1f-d49mm</p>		<p><b>M6102</b> NO. 6159982 - 6162279 - 6642511 - 6692744</p> <p><b>JUNTA DE ESCAPE</b></p> <p>FORD SCORPIO (1986 A 1994) - SIERRA (1988 A 1994)</p> <p>127x70x2mm 1f-d56mm</p>
	<p><b>P1026</b> NO. 6168375 - 89FB.2457.AA</p> <p><b>CAPA DE PEDAL TRAVÃO E EMBRAIAGEM</b></p> <p>FORD SCORPIO II (GFR, GGR): 2.0 i 10.1994/08.1998 85KW 115CV 1998CC - FORD SCORPIO II (GFR, GGR): 2.0 i 16V 10.1994/08.1998 100KW 136CV 1998CC - FORD SCORPIO II (GFR, GGR): 2.3 i 16V 06.1996/08.1998 108KW 147CV 2295CC - FORD SCORPIO II (GFR, GGR): 2.9 i 02.1995/08.1998 110KW 150CV 2933CC - FORD SCORPIO II (GFR, GGR): 2.9 i 24V 10.1994/08.1998 152KW 207CV 2933CC - FORD SCORPIO II (GFR, GGR): 2.5 TD...</p> <p>68x54x14mm</p>		<p><b>R220075</b> NO. 1438576 - 71BB8260DA</p> <p><b>TUBO INFERIOR DO RADIADOR</b></p> <p>FORD TAUNUS (GBTK) 2000 08.1973/02.1976 72KW 98CV 1993CC NEG - FORD TAUNUS (GBTS, GBFS, CBTS) 2.0 05.1975/07.1979 66KW 90CV 1993CC NYR 0928457 0928465 - FORD TAUNUS (GBTS, GBFS, CBTS) 2.3 05.1975/07.1979 79KW 107CV 2294CC YF 0928459 0928467 - FORD TAUNUS III Turnier (GBNS) 2.0 07.1979/07.1982 66KW 90CV 1993CC NWR - FORD TAUNUS III Turnier (GBNS) 2.0 07.1979/07.1982 74KW 100CV 1993CC NER 0928526 - ...</p> <p>B225-d35/35mm 60-95-80-45mm</p>
	<p><b>R220442</b> NO. 105E8260A - 1465390 - 1546886 - 691F8260AA - 691G8260AA - 72AB8260AA</p> <p><b>TUBO DE RADIADOR SUPERIOR</b></p> <p>FORD TAUNUS (GBFK): 1600 08.1970/02.1976 53KW 72CV 1593CC - FORD TAUNUS (GBTK): 1600 01.1970/05.1975 53KW 72CV 1593CC - FORD TAUNUS Coupé (GBCK): 1600 08.1970/02.1976 65KW 88CV 1593CC - FORD TAUNUS Turnier (GBNK): 1600 08.1970/02.1976 53KW 72CV 1593CC - FORD TAUNUS (GBTS, GBFS, CBTS): 1.3 05.1975/07.1979 40KW 55CV 1297CC - FORD TAUNUS Turnier (GBNS): 1.3 12.1975/07.1979 40KW 54CV 1297CC - FORD TAU...</p> <p>B190-d31/38mm 40-150-150mm</p>		<p><b>R220478</b> NO. 6098166 - 83BB8286CA</p> <p><b>TUBO DE RADIADOR INFERIOR</b></p> <p>FORD SIERRA Hatchback (GBC): 2.0 08.1982/10.1984 66KW 90CV 1999CC - FORD SIERRA Hatchback (GBC): 2.0 10.1985/12.1986 74KW 100CV 1993CC - FORD SIERRA Hatchback (GBC): 2.0 08.1982/12.1986 77KW 105CV 1993CC - FORD SIERRA Turnier (BNC): 2.0 08.1982/10.1984 66KW 90CV 1999CC - FORD SIERRA Turnier (BNC): 2.0 10.1985/12.1986 74KW 100CV 1993CC - FORD SIERRA Turnier (BNC): 2.0 08.1982/12.1986 77KW 105CV 199...</p> <p>B215-d30/30mm 100-140-120mm</p>
	<p><b>R220522</b> NO. 6112785</p> <p><b>TUBO DE RADIADOR SUPERIOR</b></p> <p>FORD SIERRA I Hatchback (GBC) 2.0 08.1982/10.1984 66KW 90CV 1999CC NYT 0928562 - FORD SIERRA I Hatchback (GBC) 2.0 08.1982/12.1986 77KW 105CV 1993CC NET 0928561 - FORD SIERRA I Hatchback (GBC) 2.0 10.1985/12.1986 74KW 100CV 1993CC NRD 0928610 - FORD SIERRA II (GBG, GB4)   SAPPHIRE 2.0 01.1987/02.1993 77KW 105CV 1993CC NES N8C 0928667 - FORD SIERRA II Hatchback (GBC, GBG) 2.0 01.1987/02.1993 77KW 1...</p> <p>B385-d31/31mm 60-55-150-105-85mm</p>		<p><b>R220523</b> NO. 6098166 - 83BB8286CA</p> <p><b>TUBO DE RADIADOR INFERIOR</b></p> <p>FORD SIERRA Hatchback (GBC): 2.0 08.1982/10.1984 66KW 90CV 1999CC - FORD SIERRA Hatchback (GBC): 2.0 10.1985/12.1986 74KW 100CV 1993CC - FORD SIERRA Hatchback (GBC): 2.0 08.1982/12.1986 77KW 105CV 1993CC - FORD SIERRA Turnier (BNC): 2.0 08.1982/10.1984 66KW 90CV 1999CC - FORD SIERRA Turnier (BNC): 2.0 10.1985/12.1986 74KW 100CV 1993CC - FORD SIERRA Turnier (BNC): 2.0 08.1982/12.1986 77KW 105CV 199...</p> <p>B250-d33/33mm 160-95-90mm</p>
	<p><b>R2472</b> NO. 6123124 - 6123800 - M-220520</p> <p><b>TUBO SUPERIOR DO RADIADOR</b></p> <p>FORD SIERRA-1300-1600</p> <p>B400-d31/31mm 225-120-140-70mm</p>		<p><b>R8152</b> NO. 6167460 - 88BB8260BA</p> <p><b>TUBO SUPERIOR DO RADIADOR</b></p> <p>FORD SCORPIO I (GAE, GGE) 2.0 i (05.89 A 09.94) 120cv 1998cc Hatchback - FORD SCORPIO I três volumes (GGE) 1.9 (11.92 A 09.93) 115cv 1993cc três volumes - FORD SCORPIO I três volumes (GGE) 2.0 i (02.92 A 09.94) 115cv 1998cc três volumes - FORD SCORPIO I três volumes (GGE) 2.0 i (05.89 A 09.94) 120cv 1998cc três volumes - FORD SCORPIO I Turnier (GGE) 2.0 i (09.91 A 09.94) 115cv 1998cc Combi - ...</p> <p>B260-33/33mm 155-155mm</p>
	<p><b>R8152</b> NO. 6167460 - 88BB8260BA</p> <p><b>TUBO SUPERIOR DO RADIADOR</b></p> <p>FORD SIERRA Hatchback (GBC, GBG) 2.0 i DOHC (12.91 A 02.93) 115cv 1998cc Hatchback - FORD SIERRA Hatchback (GBC, GBG) 2.0 i (06.89 A 02.93) 120cv 1998cc Hatchback - FORD SIERRA Hatchback (GBC, GBG) 2.0 i (06.89 A 02.93) 125cv 1998cc Hatchback - FORD SIERRA (GBG, GB4) 2.0 i DOHC (12.91 A 02.93) 115cv 1998cc três volumes - FORD SIERRA (GBG, GB4) 2.0 i (01.90 A 02.93) 120cv 1998cc três volumes - ...</p> <p>B260-33/33mm 155-155mm</p>		<p><b>R8153</b> NO. 6167460 - 88BB8260BA</p> <p><b>TUBO SUPERIOR DO RADIADOR</b></p> <p>FORD SCORPIO I (GAE, GGE) 2.0 i (05.89 A 09.94) 120cv 1998cc Hatchback - FORD SCORPIO I três volumes (GGE) 1.9 (11.92 A 09.93) 115cv 1993cc três volumes - FORD SCORPIO I três volumes (GGE) 2.0 i (02.92 A 09.94) 115cv 1998cc três volumes - FORD SCORPIO I três volumes (GGE) 2.0 i (05.89 A 09.94) 120cv 1998cc três volumes - FORD SCORPIO I Turnier (GGE) 2.0 i (09.91 A 09.94) 115cv 1998cc Combi - ...</p> <p>B190-32/32mm 155-157mm</p>
	<p><b>R8153</b> NO. 6167460 - 88BB8260BA</p> <p><b>TUBO SUPERIOR DO RADIADOR</b></p> <p>FORD SIERRA Hatchback (GBC, GBG) 2.0 i DOHC (12.91 A 02.93) 115cv 1998cc Hatchback - FORD SIERRA Hatchback (GBC, GBG) 2.0 i (06.89 A 02.93) 120cv 1998cc Hatchback - FORD SIERRA Hatchback (GBC, GBG) 2.0 i (06.89 A 02.93) 125cv 1998cc Hatchback - FORD SIERRA (GBG, GB4) 2.0 i DOHC (12.91 A 02.93) 115cv 1998cc três volumes - FORD SIERRA (GBG, GB4) 2.0 i (01.90 A 02.93) 120cv 1998cc três volumes - ...</p> <p>B190-32/32mm 155-157mm</p>		<p><b>RT08565</b> NO. 1027745 - 6132910 - 6179304 - 6714710 - 91FB2282AA</p> <p><b>TUBO DE TRAVÃO TRÁS LH-RH</b></p> <p>FORD SIERRA TT (07-1982 A 02-1993)</p> <p>340mm MC40 - MC40</p>
	<p><b>RT08600</b> NO. 1638393 - 1666247 - 1666460 - 6125634</p> <p><b>TUBO DE TRAVÃO TRÁS LH-RH</b></p> <p>FORD SIERRA TT (08-1985 a 02-1993)</p> <p>355mm MC11 - MC40</p>		<p><b>S1039</b> NO. 1505928 - 6099528 - 81BB.5K789.AA</p> <p><b>SILENT-BLOC DE VAUS DE SUSPENSÃO (FURO 13mm)</b></p> <p>FORD TAUNUS (GBFK): 1600 01.1974/05.1975 50KW 68CV 1593CC - FORD TAUNUS (GBFK): 1600 08.1970/02.1976 53KW 72CV 1593CC - FORD TAUNUS (GBFK): 1600 08.1970/02.1976 65KW 88CV 1593CC - FORD TAUNUS (GBFK): 2000 V6 08.1970/02.1976 66KW 90CV 1998CC - FORD TAUNUS (GBTK): 1300 01.1970/05.1975 40KW 55CV 1297CC - FORD TAUNUS (GBTK): 1600 01.1974/05.1975 50KW 68CV 1593CC - FORD TAUNUS (GBTK): 1600 01.1970/05.1...</p> <p>d39x46mm c32mm 1fd13mm</p>

	<p><b>S1047</b> NO. 1517555 - 1551776 - 6099529 - 81BB.5K790.AA</p> <p><b>SILENT-BLOC DO TRIANGULO DA SUSPENSÃO</b></p> <p>FORD TAUNUS (GBFK): 1600 01.1974/05.1975 50KW 68CV 1593CC - FORD TAUNUS (GBFK): 1600 08.1970/02.1976 53KW 72CV 1593CC - FORD TAUNUS (GBFK): 1600 08.1970/02.1976 65KW 88CV 1593CC - FORD TAUNUS (GBFK): 2000 V6 08.1970/02.1976 66KW 90CV 1998CC - FORD TAUNUS (GBTK): 1300 01.1970/05.1975 40KW 55CV 1297CC - FORD TAUNUS (GBTK): 1600 01.1974/05.1975 50KW 68CV 1593CC - FORD TAUNUS (GBTK): 1600 01.1970/05.1...</p> <p>d43x65mm c52mm 1f-d12mm</p>		<p><b>S1197</b> NO. 1656752 - 5021729 - 6122507 - 6129161 - 6144628 - 85GB.5493.AB - 85GB.5493.BA - 88GB.5493.AA ...</p> <p><b>SILENT-BLOC CENTRAL DO BRAÇO DA SUSPENSÃO DIANTEIRO</b></p> <p>FORD SIERRA I Hatchback (GBC): 1.3 08.1982/12.1986 44KW 60CV 1294CC - FORD SIERRA I Hatchback (GBC): 1.6 08.1982/12.1986 55KW 75CV 1593CC - FORD SIERRA I Hatchback (GBC): 1.8 10.1984/12.1986 66KW 90CV 1796CC - FORD SIERRA I Hatchback (GBC): 2.0 08.1982/10.1984 66KW 90CV 1999CC - FORD SIERRA I Hatchback (GBC): 2.0 10.1985/12.1986 74KW 100CV 1993CC - FORD SIERRA I Hatchback (GBC): 2.0 08.1982/12.198...</p> <p>d65x23mm c8mm d48mm 1f-d16mm</p>
	<p><b>S1197</b> NO. 1656752 - 5021729 - 6122507 - 6129161 - 6144628 - 85GB.5493.AB - 85GB.5493.BA - 88GB.5493.AA - 88GB....</p> <p><b>SILENT-BLOC CENTRAL DO BRAÇO DA SUSPENSÃO DIANTEIRO</b></p> <p>FORD SCORPIO I (GAE, GGE): 1.8 04.1985/02.1992 66KW 90CV 1796CC - FORD SCORPIO I (GAE, GGE): 2.0 10.1985/12.1990 74KW 100CV 1993CC - FORD SCORPIO I (GAE, GGE): 2.0 04.1985/08.1989 77KW 105CV 1993CC - FORD SCORPIO I (GAE, GGE): 2.0 i 04.1985/02.1992 85KW 115CV 1993CC - FORD SCORPIO I (GAE, GGE): 2.0 i 02.1992/09.1994 85KW 115CV 1993CC - FORD SCORPIO I (GAE, GGE): 2.0 i 05.1989/09.1994 88KW 120CV ...</p> <p>d65x23mm c8mm d48mm 1f-d16mm</p>		<p><b>S1417</b> NO. 6009976 - 74BB.3069.AB</p> <p><b>SILENT BLOC DO BRAÇO DA SUSPENSÃO DA FRENTE PARTE INFERIOR</b></p> <p>FORD TAUNUS V (GBS, GBNS): 1.3 07.1979/07.1982 43KW 58CV 1294CC - FORD TAUNUS V (GBS, GBNS): 1.6 07.1979/07.1982 51KW 69CV 1593CC - FORD TAUNUS V (GBS, GBNS): 1.6 07.1979/07.1982 54KW 73CV 1593CC - FORD TAUNUS V (GBS, GBNS): 1.6 07.1979/07.1982 65KW 88CV 1593CC - FORD TAUNUS V (GBS, GBNS): 2.0 07.1979/07.1982 74KW 100CV 1993CC - FORD TAUNUS V (GBS, GBNS): 2.0 07.1979/07.1982 66KW 90CV 1999CC - FOR...</p> <p>d32x69mm d30 - 5mm 1f-d12mm</p>
	<p><b>S1865</b> NO. 6028454 - 76BB5K792AA</p> <p><b>SILENT-BLOC DO BRAÇO DA SUSPENSÃO TRÁS PARTE INFERIOR</b></p> <p>FORD TAUNUS (GBFK): 1600 01.1974/05.1975 50KW 68CV 1593CC - FORD TAUNUS (GBFK): 1600 08.1970/02.1976 53KW 72CV 1593CC - FORD TAUNUS (GBFK): 1600 08.1970/02.1976 65KW 88CV 1593CC - FORD TAUNUS (GBFK): 2000 V6 08.1970/02.1976 66KW 90CV 1998CC - FORD TAUNUS (GBTK): 1300 01.1970/05.1975 40KW 55CV 1297CC - FORD TAUNUS (GBTK): 1600 01.1974/05.1975 50KW 68CV 1593CC ? FORD TAUNUS (GBTK): 16... ..</p> <p>d51x44mm c36mm 1f-d12mm</p>		<p><b>S2129</b> NO. 6782218 - 85352 - 93BB-5A103-AA - 93BB5A103AA - F5RZ-5A103-B - F5RZ5A103B</p> <p><b>SILENT-BLOC DA SUSPENSÃO FRENTE PARTE FRENTE</b></p> <p>FORD SCORPIO II (GFR, GGR) 2.0 i 10.1994/08.1998 85KW 115CV 1998CC NSD 0928888 0928892 - FORD SCORPIO II (GFR, GGR) 2.0 i 16V 10.1994/08.1998 100KW 136CV 1998CC N3A 0928889 0928894 - FORD SCORPIO II (GFR, GGR) 2.3 i 16V 06.1996/08.1998 108KW 147CV 2295CC Y5A 0928957 0928959 - FORD SCORPIO II (GFR, GGR) 2.5 TD 10.1994/08.1998 85KW 115CV 2500CC SCC 0928891 0928898 - FORD SCORPIO II (GFR, GGR) 2.5 TD... ..</p> <p>d54x40mm c27mm d44mm 1f-d14mm</p>
	<p><b>T0003</b> NO. 0204460 - 204460</p> <p><b>BATENTE DA BARRA ESTABILIZADORA</b></p> <p>FORD TAUNUS</p> <p>41x39x36mm 1f-d18mm</p>		<p><b>T1051</b> NO. 6714195</p> <p><b>BATENTE DO CENTRO DA BARRA ESTABILIZADORA (FURO DIÂMETRO 20mm)</b></p> <p>FORD SCORPIO 2.0i 16V - 2.0i - 2.5TD - 2.9i 24V - 2.9i (1994 A 1998)</p> <p>43x39x30mm 1f-d20mm</p>
	<p><b>UMB84040</b> NO. 05073860AA</p> <p><b>TAMPÃO BLOCO MOTOR</b></p> <p>FORD TAUNUS 12M (11G) 1.5 (De 08-1966 Até 06-1971) 40kW 54CV 1498cc três volumes FORD TAUNUS 12M (12G) 1.3 (De 08-1966 Até 06-1971) 37kW 50CV 1298cc três volumes FORD TAUNUS 12M Turnier (15G) 1.3 (De 09-1966 Até 06-1971) 37kW 50CV 1305cc Combi FORD TAUNUS 12M Coupé (13G) 1.3 (De 08-1966 Até 06-1971) 37kW 50CV 1305cc Coupé FORD TAUNUS 15M 1.5 (De 12-1954 Até 09-1958) 40kW 54CV 1487cc três volumes...</p> <p>d-47x9,1mm di-44,2mm</p>		<p><b>UMB84057</b> NO. 05073837AA - 5073837AA</p> <p><b>TAMPÃO BLOCO MOTOR</b></p> <p>FORD TAUNUS 12M (11G) 1.5 (De 08-1966 Até 06-1971) 40kW 54CV 1498cc três volumes FORD TAUNUS 12M (12G) 1.3 (De 08-1966 Até 06-1971) 37kW 50CV 1298cc três volumes FORD TAUNUS 12M Turnier (15G) 1.3 (De 09-1966 Até 06-1971) 37kW 50CV 1305cc Combi FORD TAUNUS 12M Coupé (13G) 1.3 (De 08-1966 Até 06-1971) 37kW 50CV 1305cc Coupé FORD TAUNUS 15M 1.5 (De 12-1954 Até 09-1958) 40kW 54CV 1487cc três volumes...</p> <p>d-46x13mm d-38x1,5mm</p>
	<p><b>UPCR5004</b> NO. 1454051 - 1567143 - 1678260</p> <p><b>PORCA DA RODA CHAVE 19 M12X1,50X30MM ( BASE CONICA )</b></p> <p>FORD SCORPIO I (GAE, GGE) 1.8 (04.1985 -02.1992) 66kw 90cv 1796cm3 Hatchback FORD SCORPIO I (GAE, GGE) 2.0 (04.1985 -08.1989) 77kw 105cv 1993cm3 Hatchback FORD SCORPIO I (GAE, GGE) 2.0 i (10.1985 -12.1990) 74kw 100cv 1993cm Hatchback FORD SCORPIO I (GAE, GGE) 2.0 i (04.1985 -02.1992) 85kw 115cv 1993cm3 Hatchback FORD SCORPIO I (GAE, GGE) 2.4 i (09.1986 -09.1988) 96kw 130cv 2394cm3 Hatchback FORD S...</p> <p>d26x32mm M12x1,5mm</p>		<p><b>UPCR5004</b> NO. 1454051 - 1567143 - 1678260</p> <p><b>PORCA DA RODA CHAVE 19 M12X1,50X30MM ( BASE CONICA )</b></p> <p>FORD SCORPIO II (GFR, GGR) 2.0 i 10.1994 -08.1998) 85kw 115cv 1998cm3 três volumes FORD SCORPIO II (GFR, GGR) 2.0 i 16V 10.1994 -08.1998) 100kw 136cv 1998cm3 três volumes FORD SCORPIO II (GFR, GGR) 2.3 i 16V 06.1996 -08.1998) 108kw 147cv 2295cm3 três volumes FORD SCORPIO II (GFR, GGR) 2.5 TD 10.1994 -08.1998) 85kw 115cv 2500cm3 três volumes FORD SCORPIO II (GFR, GGR) 2.5 TD 09.1996 -08.1998) 92kw ...</p> <p>d26x32mm M12x1,5mm</p>
	<p><b>UPCR5004</b> NO. 1454051 - 1567143 - 1678260</p> <p><b>PORCA DA RODA CHAVE 19 M12X1,50X30MM ( BASE CONICA )</b></p> <p>FORD SCORPIO II Turnier (GFR, GGR) 2.0 i (10.1994 -08.1998) 85kw 115cv 1998cm3 Combi FORD SCORPIO II Turnier (GFR, GGR) 2.0 i 16V (10.1994 -08.1998) 100kw 136cv 1998cm3 Combi FORD SCORPIO II Turnier (GFR, GGR) 2.3 i 16V (06.1996 -08.1998) 108kw 147cv 2295cm3 Combi FORD SCORPIO II Turnier (GFR, GGR) 2.5 TD (10.1994 -08.1998) 85kw 115cv 2500cm3 Combi FORD SCORPIO II Turnier (GFR, GGR) 2.5 TD (09.199...</p> <p>d26x32mm M12x1,5mm</p>		<p><b>UPCR5004</b> NO. 1454051 - 1567143 - 1678260</p> <p><b>PORCA DA RODA CHAVE 19 M12X1,50X30MM ( BASE CONICA )</b></p> <p>FORD SIERRA I Hatchback (GBC) 1.3 (08.1982 -12.1986) 44kw 60cv 1294cm3 Hatchback FORD SIERRA I Hatchback (GBC) 1.6 (08.1982 -12.1986) 55kw 75cv 1593cm3 Hatchback FORD SIERRA I Hatchback (GBC) 1.6 (08.1984 -12.1986) 58kw 79cv 1597cm3 Hatchback FORD SIERRA I Hatchback (GBC) 1.8 (10.1984 -12.1986) 66kw 90cv 1796cm3 Hatchback FORD SIERRA I Hatchback (GBC) 2.0 (08.1982 -10.1984) 66kw 90cv 1999cm3 Hatch...</p> <p>d26x32mm M12x1,5mm</p>
	<p><b>UPCR5004</b> NO. 1454051 - 1567143 - 1678260</p> <p><b>PORCA DA RODA CHAVE 19 M12X1,50X30MM ( BASE CONICA )</b></p> <p>FORD SIERRA Turnier (BNC) 1.6 (08.1982 -12.1986) 55kw 75cv 1593cm3 Combi FORD SIERRA Turnier (BNC) 1.8 (10.1984 -12.1986) 66kw 90cv 1796cm3 Combi FORD SIERRA Turnier (BNC) 2.0 (08.1982 -10.1984) 66kw 90cv 1999cm3 Combi FORD SIERRA Turnier (BNC) 2.0 (10.1985 -12.1986) 74kw 100cv 1993cm3 Combi FORD SIERRA Turnier (BNC) 2.0 (08.1982 -12.1986) 77kw 105cv 1993cm3 Combi FORD SIERRA Turnier (BNC) 2.0 (03...</p> <p>d26x32mm M12x1,5mm</p>		<p><b>UPCR5004</b> NO. 1454051 - 1567143 - 1678260</p> <p><b>PORCA DA RODA CHAVE 19 M12X1,50X30MM ( BASE CONICA )</b></p> <p>FORD TAUNUS III Turnier (GBNS) 1.6 (07.1979 -07.1982) 51kw 69cv 1593cm3 Combi FORD TAUNUS III Turnier (GBNS) 1.6 (07.1979 -07.1982) 54kw 73cv 1593cm3 Combi FORD TAUNUS III Turnier (GBNS) 2.0 (07.1979 -07.1982) 74kw 100cv 1993cm3 Combi FORD TAUNUS III Turnier (GBNS) 2.0 (07.1979 -07.1982) 66kw 90cv 1999cm3 Combi FORD TAUNUS III Turnier (GBNS) 2.3 (07.1979 -07.1982) 84kw 114cv 2294cm3 Combi</p> <p>d26x32mm M12x1,5mm</p>

	<p><b>UPCR5004</b> NO. 1454051 - 1567143 - 1678260</p> <p>PORCA DA RODA CHAVE 19 M12X1,50X30MM ( BASE CONICA )</p> <p>FORD TAUNUS V (GBS, GBNS) 1.3 (07.1979 -07.1982) 43kw 58cv 1294cm3 três volumes FORD TAUNUS V (GBS, GBNS) 1.6 (07.1979 -07.1982) 51kw 69cv 1593cm3 três volumes FORD TAUNUS V (GBS, GBNS) 1.6 (07.1979 -07.1982) 54kw 73cv 1593cm3 três volumes FORD TAUNUS V (GBS, GBNS) 1.6 (07.1979 -07.1982) 65kw 88cv 1593cm3 três volumes FORD TAUNUS V (GBS, GBNS) 2.0 (07.1979 -07.1982) 74kw 100cv 1993cm3 três volumes...</p> <p>d26x32mm M12x1,5mm</p>		<p><b>UPCR5018</b> NO. 1007487 - 1447852 - 1470843</p> <p>PORCA DA RODA CHAVE 19 M12X1,50X16MM ( BASE CONICA PARA JANTE DE AÇO )</p> <p>FORD SCORPIO II (GFR, GGR) 2.0 i (10.1994 - 08.1998) 85kw 115cv 1998cm3 três volumes FORD SCORPIO II (GFR, GGR) 2.0 i 16V (10.1994 - 08.1998) 100kw 136cv 1998cm3 três volumes FORD SCORPIO II (GFR, GGR) 2.3 i 16V (06.1996 - 08.1998) 108kw 147cv 2295cm3 três volumes FORD SCORPIO II (GFR, GGR) 2.5 TD (10.1994 - 08.1998) 85kw 115cv 2500cm3 três volumes FORD SCORPIO II (GFR, GGR) 2.5 TD (09.1996 - 08.1998) ...</p> <p>d19x15mm M12x15mm</p>
	<p><b>UPCR5018</b> NO. 1007487 - 1447852 - 1470843</p> <p>PORCA DA RODA CHAVE 19 M12X1,50X16MM ( BASE CONICA PARA JANTE DE AÇO )</p> <p>FORD SCORPIO II Turnier (GNR, GGR) 2.0 i (10.1994 - 08.1998) 85kw 115cv 1998cm3 Combi FORD SCORPIO II Turnier (GNR, GGR) 2.0 i 16V (10.1994 - 08.1998) 100kw 136cv 1998cm3 Combi FORD SCORPIO II Turnier (GNR, GGR) 2.3 i 16V (06.1996 - 08.1998) 108kw 147cv 2295cm3 Combi FORD SCORPIO II Turnier (GNR, GGR) 2.5 TD (10.1994 - 08.1998) 85kw 115cv 2500cm3 Combi FORD SCORPIO II Turnier (GNR, GGR) 2.5 TD (09...</p> <p>d19x15mm M12x15mm</p>		<p><b>UPCR5019</b> NO. 1366029 - 1366432 - 1678260 - 2179620 - 5114407 - 6111766</p> <p>PORCA DA RODA CHAVE 19 M12X1,50X31MM ( BASE CONICA )</p> <p>FORD SCORPIO II (GFR, GGR) 2.0 i (10.1994 -08.1998) 85kw 115cv 1998cm3 três volumes FORD SCORPIO II (GFR, GGR) 2.0 i 16V (10.1994 -08.1998) 100kw 136cv 1998cm3 três volumes FORD SCORPIO II (GFR, GGR) 2.3 i 16V (06.1996 -08.1998) 108kw 147cv 2295cm3 três volumes FORD SCORPIO II (GFR, GGR) 2.5 TD (10.1994 -08.1998) 85kw 115cv 2500cm3 três volumes FORD SCORPIO II (GFR, GGR) 2.5 TD (09.1996 -08.1998) ...</p> <p>d26x31mm M12x28mm</p>
	<p><b>UTR0630</b> NO. 6045648</p> <p>TAMPÃO RADIADOR</p> <p>FORD TAUNUS 20M (42F) 2.3 (De 1967.07 Até 1974.04) 79kW 107cv 2294cm3 três volumes -          FORD TAUNUS 20M Turnier (46F) 2.0 (De 1967.09 Até 1974.04) 63kW 86cv 1998cm3 Combi -          FORD TAUNUS 20M Turnier (46F) 2.0 (De 1967.07 Até 1974.04) 66kW 90cv 1998cm3 Combi -          FORD TAUNUS 20M Turnier (46F) 2.3 (De 1968.01 Até 1974.04) 79kW 107cv 2294cm3 Combi -</p> <p>d59x79mm d38x25mm</p>		<p><b>UTR0630</b> NO. 6045648</p> <p>TAMPÃO RADIADOR</p> <p>FORD SCORPIO I (GAE, GGE) 2.4 i (De 1988.10 Até 1992.02) 92kW 125cv 2394cm3 Hatchback -          FORD SCORPIO I (GAE, GGE) 2.4 i Cat (De 1988.10 Até 1994.09) 92kW 125cv 2394cm3 Hatchback -          FORD SCORPIO I (GAE, GGE) 2.4 i (De 1986.09 Até 1988.09) 96kW 130cv 2394cm3 Hatchback -          FORD SCORPIO I (GAE, GGE) 2.8 i (De 1985.04 Até 1986.11) 110kW 150cv 2792cm3 Hatchback -</p> <p>d59x79mm d38x25mm</p>
	<p><b>UTR0630</b> NO. 6045648</p> <p>TAMPÃO RADIADOR</p> <p>FORD SIERRA Hatchback (GBC) 1.3 (De 1982.08 Até 1986.12) 44kW 60cv 1294cm3 Hatchback -          FORD SIERRA Hatchback (GBC) 1.6 (De 1982.08 Até 1986.12) 55kW 75cv 1593cm3 Hatchback -          FORD SIERRA Hatchback (GBC) 1.8 (De 1984.10 Até 1986.12) 66kW 90cv 1796cm3 Hatchback -          FORD SIERRA Hatchback (GBC) 2.0 (De 1982.08 Até 1984.10) 66kW 90cv 1999cm3 Hatchback -</p> <p>d59x79mm d38x25mm</p>		<p><b>UTR0630</b> NO. 6045648</p> <p>TAMPÃO RADIADOR</p> <p>FORD TAUNUS 17M (31F) 2.0 (De 1967.12 Até 1974.04) 66kW 90cv 1498cm3 três volumes -          FORD TAUNUS 17M (32F) 1.5 (De 1967.07 Até 1974.04) 44kW 60cv 1498cm3 três volumes -          FORD TAUNUS 17M (32F) 1.7 (De 1967.07 Até 1974.04) 48kW 65cv 1699cm3 três volumes -          FORD TAUNUS 17M (32F) 1.7 (De 1967.07 Até 1974.04) 51kW 69cv 1699cm3 três volumes -</p> <p>d59x79mm d38x25mm</p>
	<p><b>UTR0631</b> NO. 1508310 - 1613291 - 623086 - 78GB8100AC - ERS34</p> <p>TAMPÃO RADIADOR</p> <p>FORD SCORPIO I três volumes (GGE) 2.4 i (De 1988.10 Até 1994.10) 92kW 125cv 2394cm3 três volumes -          FORD SCORPIO I Turnier (GGE) 2.4 i (De 1991.09 Até 1994.09) 92kW 125cv 2394cm3 Combi -</p> <p>d59x79mm d38x26mm</p>		<p><b>UTR0631</b> NO. 1508310 - 1613291 - 623086 - 78GB8100AC - ERS34</p> <p>TAMPÃO RADIADOR</p> <p>FORD SIERRA Hatchback (GBC) 1.3 (De 1982.08 Até 1986.12) 44kW 60cv 1294cm3 Hatchback -          FORD SIERRA Hatchback (GBC) 1.6 (De 1982.10 Até 1987.02) 51kW 69cv 1597cm3 Hatchback -          FORD SIERRA Hatchback (GBC) 1.6 (De 1982.08 Até 1986.12) 55kW 75cv 1593cm3 Hatchback -          FORD SIERRA Hatchback (GBC) 1.8 (De 1984.10 Até 1986.12) 66kW 90cv 1796cm3 Hatchback -</p> <p>d59x79mm d38x26mm</p>
	<p><b>UTR0631</b> NO. 1508310 - 1613291 - 623086 - 78GB8100AC - ERS34</p> <p>TAMPÃO RADIADOR</p> <p>FORD SCORPIO I (GAE, GGE) 2.4 (De 1988.10 Até 1992.02) 92kW 125cv 2394cm3 Pick-up -          FORD SCORPIO I (GAE, GGE) 2.4 i Cat (De 1988.10 Até 1994.09) 92kW 125cv 2394cm3 Hatchback -          FORD SCORPIO I (GAE, GGE) 2.4 i (De 1986.09 Até 1988.09) 96kW 130cv 2394cm3 Hatchback -          FORD SCORPIO I (GAE, GGE) 2.8 i (De 1985.04 Até 1986.11) 110kW 150cv 2792cm3 Hatchback -</p> <p>d59x79mm d38x26mm</p>		<p><b>UTR0800</b> NO. 1647750 - 1647751 - 1650630 - 1659287 - 1659288 - 6157002 - 6160686 - 6854060 - 6893213 - 7267962 - ...</p> <p>TAMPÃO RESERVATÓRIO LIQUIDO REFRIGERAÇÃO</p> <p>FORD SCORPIO I (10.85 A 12.90) 100cv 1993cc Hatchback - FORD SCORPIO I 2.0 (04.85 A 08.89) 105cv 1993cc Hatchback - FORD SCORPIO I 2.0 i (04.85 A 02.92) 115cv 1993cc Hatchback - FORD SCORPIO I 2.4 i (10.88 A 02.92) 125cv 2394cc Hatchback 3/3 - FORD SCORPIO I 2.4 i (10.88 A 02.92) 125cv 2394cc Hatchback - FORD SCORPIO I 2.4 i (09.86 A 09.88) 130cv 2394cc Hatchback - FORD SCORPIO I 2.9 i...</p> <p>d62x25mm 1f-d53x14mm</p>
	<p><b>UTR0816</b> NO. 46402983 - 46556738 - 60807748</p> <p>TAMPÃO RESERVATÓRIO LIQUIDO REFRIGERAÇÃO</p> <p>FORD SIERRA Turnier (BNG) 1.9 (10.88 A 09.91) 108cv 1998cc Combi</p> <p>d52x27mm 1f-d45x13mm 1-ponteira-d7x30mm</p>		<p><b>UTR0820</b> NO. 90352470 - 90409256 - 90409257 - 9041032690497472 - 90467473</p> <p>TAMPÃO RESERVATÓRIO LIQUIDO REFRIGERAÇÃO</p> <p>FORD SCORPIO I (GAE, GGE) 1.8 (04.85 A 02.92) 90cv 1796cc Hatchback - FORD SCORPIO I (GAE, GGE) 2.0 i (10.85 A 12.90) 100cv 1993cc Hatchback - FORD SCORPIO I (GAE, GGE) 2.0 (04.85 A 08.89) 105cv 1993cc Hatchback - FORD SCORPIO I (GAE, GGE) 2.0 i (04.85 A 02.92) 115cv 1993cc Hatchback - FORD SCORPIO I (GAE, GGE) 2.0 i (02.92 A 09.94) 115cv 1993cc Hatchback - FORD SCORPIO I (GAE, GGE) 2.0 ...</p> <p>d62x23mm 1f-d53x12mm</p>
	<p><b>UTR0820</b> NO. 90352470 - 90409256 - 90409257 - 9041032690497472 - 90467473</p> <p>TAMPÃO RESERVATÓRIO LIQUIDO REFRIGERAÇÃO</p> <p>FORD SIERRA Hatchback (GBC) 1.6 (08.82 A 12.86) 75cv 1593cc Hatchback - FORD SIERRA Hatchback (GBC) 1.8 (10.84 A 12.86) 90cv 1796cc Hatchback - FORD SIERRA Hatchback (GBC) 2.0 (08.82 A 10.84) 90cv 1999cc Hatchback - FORD SIERRA Hatchback (GBC) 2.0 (10.85 A 12.86) 100cv 1993cc Hatchback - FORD SIERRA Hatchback (GBC) 2.0 (08.82 A 12.86) 105cv 1993cc Hatchback - FORD SIERRA Hatchback (GBC) ...</p> <p>d62x23mm 1f-d53x12mm</p>		<p><b>UTR0829</b> NO. 1647750 - 1650630 - 1659287 - 1659288 - 6157002 - 7267969</p> <p>TAMPÃO RESERVATÓRIO LIQUIDO REFRIGERAÇÃO</p> <p>FORD SCORPIO I (GAE, GGE) 1.8 Ano fabric. a part ir de: 05.85 (04.85 A 02.92) 90cv 1796 Hatchback - FORD SCORPIO I (GAE, GGE) 2.0 Ano fabric. a part ir de: 05.85 (04.85 A 08.89) 105cv 1993cc Hatchback - FORD SCORPIO I (GAE, GGE) 2.0 i Ano fabric. a part ir de: 05.85 (04.85 A 02.92) 115cv 1993cc Hatchback - FORD SCORPIO I (GAE, GGE) 2.5 D Ano fabric. a part ir de: 01.86 (12.85 A 02.92) 69cv ...</p> <p>d62x25mm 1f-d52x14mm</p>

	<p><b>UTR0829</b> NO. 1647750 - 1650630 - 1659287 - 1659288 - 6157002 - 7267969</p> <p><b>TAMPÃO RESERVATÓRIO LIQUIDO REFRIGERAÇÃO</b></p> <p>FORD SIERRA Hatchback (GBC) 1.3 (08.82 A 12.86) 60cv 1294cc Hatchback - FORD SIERRA Hatchback (GBC) 1.6 (10.82 A 02.87) 69cv 1597cc Hatchback - FORD SIERRA Hatchback (GBC) 1.6 (08.82 A 12.86) 75cv 1593cc Hatchback - FORD SIERRA Hatchback (GBC) 1.8 (10.84 A 12.86) 90cv 1796cc Hatchback - FORD SIERRA Hatchback (GBC) 2.0 Ano fabric. a part ir de: 11.85 (10.85 A 12.86) 100cv 1993cc Hatchback ...</p> <p>d62x25mm 1f-d52x14mm</p>		<p><b>UTR0846</b> NO. 1029727 - 7166662 - 95VB8100AD - 95VB8100AE</p> <p><b>TAMPÃO RESERVATÓRIO LIQUIDO REFRIGERAÇÃO</b></p> <p>FORD SCORPIO II (GFR, GGR) 2.0 i 16V (10.94 A 08.98) 136cv 1998cc três volumes - FORD SCORPIO II (GFR, GGR) 2.3 i 16V (06.96 A 08.98) 147cv 2295cc três volumes - FORD SCORPIO II (GFR, GGR) 2.9 i (02.95 A 08.98) 150cv 2933cc três volumes - FORD SCORPIO II Turnier (GFR, GGR) 2.0 i 16V (10.94 A 08.98) 136cv 1998cc Combi - FORD SCORPIO II Turnier (GFR, GGR) 2.3 i 16V (06.96 A 08.98) 147cv 229...</p> <p>62x37mm 1f-d52x12mm</p>
	<p><b>UTR0859</b> NO. 1650630 - 94539597 - 96293957 - 96312510 - 96351578 - 96420303 - 96536649</p> <p><b>TAMPÃO RESERVATÓRIO LIQUIDO REFRIGERAÇÃO</b></p> <p>FORD SCORPIO I ( G A E , G G E ) 1.8 (04.85 A 02.92) 90cv 1796cc Hatchback - FORD SCORPIO I ( G A E , G G E ) 2.0 i (10.85 A 12.90) 100cv 1993cc Hatchback - FORD SCORPIO I ( G A E , G G E ) 2.0 (04.85 A 08.89) 105cv 1993cc Hatchback - FORD SCORPIO I ( G A E , G G E ) 2.0 i (04.85 A 02.92) 115cv 1993cc Hatchback - FORD SCORPIO I ( G A E , G G E ) 2.0 i (02.92 A 09.94) 115cv 1993cc Hatchback - ...</p> <p>d63x23mm 1f-d53x11mm</p>		<p><b>UTR0859</b> NO. 1650630 - 94539597 - 96293957 - 96312510 - 96351578 - 96420303 - 96536649</p> <p><b>TAMPÃO RESERVATÓRIO LIQUIDO REFRIGERAÇÃO</b></p> <p>FORD SIERRA Hatchback (GBC) 2.0 (08.82 A 10.84) 90cv 1999cc Hatchback - FORD SIERRA Hatchback (GBC) 2.3 (08.82 A 12.86) 114cv 2294cc Hatchback - FORD SIERRA Hatchback (GBC) 2.8 XR4i (08.82 A 12.86) 143cv 2792cc Hatchback - FORD SIERRA Hatchback (GBC) 2.8 XR4i (08.82 A 12.86) 146cv 2792cc Hatchback - FORD SIERRA Hatchback (GBC) 2.8 i XR 4x4 (09.83 A 12.86) 146cv 2792cc Hatchback - FORD SI...</p> <p>d63x23mm 1f-d53x11mm</p>
	<p><b>UTR0957</b> NO. XM348100AB - 1351958 - 1455876 - 4026783 - 4137897 - F87H8100AA - XM348100EB - YL848100HAA</p> <p><b>TAMPÃO DO RADIADOR</b></p> <p>FORD TAUNUS (GBTS, GBFS, CBTS) 1.6 (De 08.1976 Até 07.1979) 65kW 88cv 1593cm3 três volumes -</p> <p>d45x25mm d28x22mm</p>		<p><b>UTR0958</b> NO. XM348100AB - 1351958 - 1455876 - 4026783 - 4137897 - F87H8100AA - XM348100EB - YL848100HAA</p> <p><b>TAMPÃO RADIADOR</b></p> <p>FORD TAUNUS (GBTS, GBFS, CBTS) 1.6 (De 08.1976 Até 07.1979) 65kW 88cv 1593cm3 três volumes -</p> <p>d45x29mm d28x21mm</p>
	<p><b>UTR1210</b> NO. 1K0955455 - 8D0955455</p> <p><b>TAMPÃO DO RESERVATÓRIO LAVA-VIDROS</b></p> <p>FORD TAUNUS 20M II Turnier (46F) 2.3 (De 01.1968 Até 04.1974) 79kW 107cv 2294cm3 Combi -</p> <p>93x58x10mm 1f-d53x7mm</p>		<p><b>UTV83012</b> NO. 1457117 - 1657022 - 1663906 - 6093527 - 6186775 - 6732529 - 70TM6730AA - 89FF6730AA</p> <p><b>TAMPÃO VEDAÇÃO BUJÃO</b></p> <p>FORD SCORPIO I (GAE - GGE) 1.8 (De 04-1985 Até 02-1992) 66kW 90CV 1796cc Hatchback FORD SCORPIO I (GAE - GGE) 2.0 i (De 10-1985 Até 12-1990) 74kW 100CV 1993cc Hatchback FORD SCORPIO I (GAE - GGE) 2.0 (De 04-1985 Até 08-1989) 77kW 105CV 1993cc Hatchback FORD SCORPIO I (GAE - GGE) 2.0 i (De 04-1985 Até 02-1992) 85kW 115CV 1993cc Hatchback FORD SCORPIO I (GAE - GGE) 2.0 i (De 05-1989 Até 09-1994) 88k...</p> <p>d23x26mm c15mm d13mm</p>
	<p><b>UTV83012</b> NO. 1457117 - 1657022 - 1663906 - 6093527 - 6186775 - 6732529 - 70TM6730AA - 89FF6730AA</p> <p><b>TAMPÃO VEDAÇÃO BUJÃO</b></p> <p>FORD SCORPIO II (GFR - GGR) 2.9 i (De 02-1995 Até 08-1998) 110kW 150CV 2933cc três volumes FORD SCORPIO II (GFR - GGR) 2.9 i 24V (De 10-1994 Até 08-1998) 152kW 207CV 2933cc três volumes FORD SCORPIO II Turnier (GFR - GGR) 2.9 i (De 02-1995 Até 08-1998) 110kW 150CV 2933cc Combi FORD SCORPIO II Turnier (GFR - GGR) 2.9 i 24V (De 10-1994 Até 08-1998) 152kW 207CV 2933cc Combi</p> <p>d23x26mm c15mm d13mm</p>		<p><b>UTV83012</b> NO. 1457117 - 1657022 - 1663906 - 6093527 - 6186775 - 6732529 - 70TM6730AA - 89FF6730AA</p> <p><b>TAMPÃO VEDAÇÃO BUJÃO</b></p> <p>FORD SIERRA Hatchback (GBC) 1.3 (De 08-1982 Até 12-1986) 44kW 60CV 1294cc Hatchback FORD SIERRA Hatchback (GBC) 1.6 (De 08-1982 Até 12-1986) 55kW 75CV 1593cc Hatchback FORD SIERRA Hatchback (GBC) 1.8 (De 10-1984 Até 12-1986) 66kW 90CV 1796cc Hatchback FORD SIERRA Hatchback (GBC) 2.0 (De 08-1982 Até 10-1984) 66kW 90CV 1999cc Hatchback FORD SIERRA Hatchback (GBC) 2.0 (De 10-1985 Até 12-1986) 74kW 10...</p> <p>d23x26mm c15mm d13mm</p>
	<p><b>W5135</b> NO. 6186295</p> <p><b>POLIE DA CAMBOTA 3 PISTAS</b></p> <p>FORD SIERRA Hatchback (GBC - GBG) 1.8 TD (08.88 A 02.93) 75cv 1753cc Hatchback - FORD SIERRA (GBG - GB4) 1.8 TD (08.88 A 02.93) 75cv 1753cc três volumes - FORD SIERRA Combi (BNG) 1.8 TD (08.88 A 02.93) 75cv 1753cc Combi</p> <p>d120/130mm d20,6mm</p>		<p><b>Y3233</b> NO. 1473166 - 1481984 - 3395499 - 4432023 - 6586309 - 6789185</p> <p><b>PARAFUSO DA RODA CAVILHA M12X1,50X48MM</b></p> <p>FORD SCORPIO II (GFR, GGR) 2.0 i (10.1994 - 08.1998) 85kW 115cv 1998cm3 três volumes FORD SCORPIO II (GFR, GGR) 2.0 i 16V (10.1994 - 08.1998) 100kW 136cv 1998cm3 três volumes FORD SCORPIO II (GFR, GGR) 2.3 i 16V (06.1996 - 08.1998) 108kW 147cv 2295cm3 três volumes FORD SCORPIO II (GFR, GGR) 2.5 TD (10.1994 - 08.1998) 85kW 115cv 2500cm3 três volumes FORD SCORPIO II (GFR, GGR) 2.5 TD (09.1996 - 08.1...</p> <p>c48mm M12x1,5mm</p>

## FORD TOURNEO TOURNEO CONNECT TOURNEO COURIER

	<p><b>A1387</b> NO. 1061194 - 1070136 - 98AB8125EC</p> <p><b>APOIO SUPORTE RADIADOR INFERIOR/SUPERIOR</b></p> <p>FORD TOURNEO CONNECT 1.8 TDCi 06.2002/12.2013 66KW 90CV 1753CC HCPD HCPD RWP/RWPE R3PA P9PD P9PC P9PB P9PA HCPB HCPA 8566524 8566AJK 8566AJM 8566AJU 8566526 - FORD TOURNEO CONNECT 1.8 TDCi 08.2006/12.2013 81KW 110CV 1753CC RWPB RWPB RWPB RWPB 8566AJL 8566AJN 8566AJV - FORD TOURNEO CONNECT 1.8 TDCi /TDDi /DI 06.2002/12.2013 55KW 75CV 1753CC P7PA R2PA P7PB BHPA 8566AJJ</p> <p>d54x40mm d41mm d38mm 1f-d25mm 1f-d13mm</p>		<p><b>A1680</b> NO. 1000941 - 1100941 - 1104173 - 1142702 - 1332880 - 1M51.6F012.BB - 1M51.6F012AD - 1M51.6F012BA - 522461...</p> <p><b>APOIO DO MOTOR LADO DIREITO</b></p> <p>FORD TOURNEO CONNECT: 1.8 16V 06.2002/12.2013 85KW 116CV 1796CC - FORD TOURNEO CONNECT: 1.8 TDCi /TDDi /DI 06.2002/12.2013 55KW 75CV 1753CC - FORD TOURNEO CONNECT: 1.8 TDCi 06.2002/12.2013 66KW 90CV 1753CC - FORD TOURNEO CONNECT: 1.8 TDCi 08.2006/12.2013 81KW 110CV 1753CC</p> <p>235x130x120mm</p>
--	--	--	--

	<p><b>A1690</b> NO. 1000941 - 1100941 - 1104173 - 1142702 - 1332880 - 1M51.6F012.AD - 1M51.6F012.BA - 1M51.6F012.BB - 52...</p> <p><b>APOIO DO MOTOR PARTE DA FRENTE</b></p> <p>FORD TOURNEO CONNECT: 1.8 16V 06.2002/12.2013 85KW 116CV 1796CC - FORD TOURNEO CONNECT: 1.8 TDCi /TDDi /DI 06.2002/12.2013 55KW 75CV 1753CC - FORD TOURNEO CONNECT: 1.8 TDCi 06.2002/12.2013 66KW 90CV 1753CC - FORD TOURNEO CONNECT: 1.8 TDCi 08.2006/12.2013 81KW 110CV 1753CC</p> <p>145x120x77mm 1f-d10mm</p>		<p><b>A1784</b> NO. 1224049 - 1250824 - 1355357 - 1370874 - 1404996 - 1420044 - 1522138 - 1533046 - 1751001 - 3M516P082A...</p> <p><b>APOIO DA CAIXA VELOCIDADES</b></p> <p>FORD TOURNEO CONNECT / GRAND TOURNEO CONNECT V408 Veículo multius: 1.6 EcoBoost 11.2013/»» 110KW 150CV 1596CC - FORD TOURNEO CONNECT / GRAND TOURNEO CONNECT V408 Veículo multius: 1.6 TDCi 09.2013/»» 55KW 75CV 1560CC - FORD TOURNEO CONNECT / GRAND TOURNEO CONNECT V408 Veículo multius: 1.6 TDCi 09.2013/»» 70KW 95CV 1560CC - FORD TOURNEO CONNECT / GRAND TOURNEO CONNECT V408 Veículo multius: 1.6 TD...</p> <p>160x1005x45mm 2f-d12mm 1f-M12</p>
	<p><b>A1830</b> NO. 1201167 - 1351703 - 2T1Q.9A393.AA - 2T1Q9A393AB - 2T1Q9A393AA</p> <p><b>APOIO SUPORTE RADIADOR</b></p> <p>FORD TOURNEO CONNECT: 1.8 TDCi /TDDi /DI 06.2002/12.2013 55KW 75CV 1753CC - FORD TOURNEO CONNECT: 1.8 TDCi 06.2002/12.2013 66KW 90CV 1753CC - FORD TOURNEO CONNECT: 1.8 TDCi 08.2006/12.2013 81KW 110CV 1753CC</p> <p>d20x14mm 2p-d6x10mm</p>		<p><b>A1926</b> NO. 1072572 - 1102456 - 11102572 - 1112025 - 1S416038BA - 98AB6038DG - 98AB6038DH - YS416038BA</p> <p><b>APOIO MOTOR LADO DIREITO</b></p> <p>FORD TOURNEO CONNECT 1.8 16V (06.02 A 12.13) 116cv 1796cc Veículo multiuso</p> <p>120x120x100mm 1p-d12x38mm</p>
	<p><b>A2302</b> NO. 1224049 - 1355357 - 1404996 - 1420044</p> <p><b>APOIO CAIXA VELOCIDADES</b></p> <p>FORD TOURNEO CONNECT / GRAND TOURNEO CONNECT V408 Kombi: 1.6 EcoBoost 11.2013/»» 110KW 150CV 1596CC - FORD TOURNEO CONNECT / GRAND TOURNEO CONNECT V408 Kombi: 1.5 TDCi 05.2015/»» 55KW 75CV 1499CC - FORD TOURNEO CONNECT / GRAND TOURNEO CONNECT V408 Kombi: 1.5 TDCi 05.2015/»» 74KW 101CV 1499CC - FORD TOURNEO CONNECT / GRAND TOURNEO CONNECT V408 Kombi: 1.5 TDCi 05.2015/»» 88KW 120CV 1499CC - FORD...</p> <p>175x108x43mm 1f-d12mm 1f-d14mm 1r-d11mm</p>		<p><b>A2345</b> NO. 1f-d11mm 1f-d12mm 1f-13x12mm 2f-d1</p> <p><b>APOIO DO MOTOR PARTE DA FRENTE</b></p> <p>FORD TOURNEO COURIER B460 Kombi 1.5 TDCi (De 02.2014 -) 55kW 75cv 1499cm3 Kombi - FORD TOURNEO COURIER B460 Kombi 1.6 TDCi (De 02.2014 -) 70kW 95cv 1560cm3 Kombi - FORD TRANSIT COURIER B460 Caixa 1.5 TDCi (De 02.2014 -) 55kW 75cv 1499cm3 Caixa - FORD TRANSIT COURIER B460 Caixa 1.6 TDCi (De 02.2014 -) 70kW 95cv 1560cm3 Caixa - FORD TRANSIT COURIER B460 Kombi 1.5 TDCi (De 02.2014 -) 55kW 75cv 1499c...</p> <p>168x172x116mm 1f-d11mm 1f-d12mm 1f-13x12mm 2f-d18mm...</p>
	<p><b>A2471</b> NO. 1684926 - 3M516P093DC - AV616P093NA</p> <p><b>APOIO DO MOTOR LADO CAIXA VELOCIDADES</b></p> <p>FORD TOURNEO CONNECT / GRAND TOURNEO CONNECT V408 Veículo multius: 1.5 TDCi 05.2015/»» 55KW 75CV 1499CC - FORD TOURNEO CONNECT / GRAND TOURNEO CONNECT V408 Veículo multius: 1.5 TDCi 05.2015/»» 74KW 101CV 1499CC - FORD TOURNEO CONNECT / GRAND TOURNEO CONNECT V408 Veículo multius: 1.5 TDCi 05.2015/»» 88KW 120CV 1499CC</p> <p>170x110x98mm 1f-d11mm 1f-d12mm 1f-d13mm 1f-d14mm</p>		<p><b>A2497</b> NO. 1686911 - 1701509 - 1742411 - 1753974</p> <p><b>APOIO DO MOTOR PARTE DA FRENTE LADO DIREITO</b></p> <p>FORD TOURNEO CONNECT / GRAND TOURNEO CONNECT V408 Veículo multius 1.6 EcoBoost (De 11.2013 -) 110kW 150cv 1596cm3 Veículo multiuso -</p> <p>254x140x102mm 3f-d12mm 2f-20x22mm</p>
	<p><b>B404</b> NO. 1388244 - 2193360 - 6C11-5705-DA - 6C1Z-5705-A - CK4Z-5705-A</p> <p><b>ABRAÇADEIRA DE MOLA TRÁS ( GASTA 2 UNIDADES )</b></p> <p>FORD TOURNEO CONNECT / GRAND TOURNEO CONNECT V408 Veículo multius 1.0 EcoBoost desde 11.2013 74KW 100CV 998CC B3GA M2GA M2GB 8566BME 8566BHF</p> <p>158x106x13mm 2p-d14x58mm</p>		<p><b>B404</b> NO. 1388244 - 2193360 - 6C11-5705-DA - 6C1Z-5705-A - CK4Z-5705-A</p> <p><b>ABRAÇADEIRA DE MOLA TRÁS ( GASTA 2 UNIDADES )</b></p> <p>FORD TOURNEO COURIER B460 Veículo multiuso 1.0 EcoBoost desde 02.2014 74KW 100CV 998CC SFCE SFCD SFCC SFCB SFCA 8566BIL</p> <p>158x106x13mm 2p-d14x58mm</p>
	<p><b>E0624-M</b> NO. 1835635 - 1833752 - ET766P082AA - ET766P082AB</p> <p><b>ESTICADOR SUPORTE APOIO MOTOR TRAS</b></p> <p>FORD TOURNEO COURIER B460 Veículo multiuso 1.5 EcoBlue 04.2018/12.2023 74KW 100CV 1499CC XXCC XXCA XXCB XVCF XVCE 8566BQC - FORD TOURNEO COURIER B460 Veículo multiuso 1.5 TDCi 02.2014/12.2023 55KW 75CV 1499CC XUCC UGCA UGCB XWCA XUCD XWCB XUCC XUCF XUCG 8566BIN - FORD TOURNEO COURIER B460 Veículo multiuso 1.5 TDCi 05.2015/12.2023 70KW 95CV 1499CC XVCD XVCC XVCB XVCA 8566BLL - FORD TOURNEO COURIER ...</p> <p>153x94x82mm 1f-d10mm 3f-d11mm</p>		<p><b>E1018</b> NO. 1027374 - 6831302 - 6866417 - 93B85A262F - 93B85A262G - 93B85A262GA</p> <p><b>ESTICADOR DE ESCAPE</b></p> <p>FORD TOURNEO</p> <p>66x54x19mm</p>
	<p><b>E1028</b> NO. 1307877 - 7092700 - 95VB.5A262.BA</p> <p><b>ESTICADOR SUPORTE DE ESCAPE</b></p> <p>FORD TRANSIT TOURNEO Autocarro 2.0 11.1994/12.2000 84KW 114CV 1998CC NSG NSF NSH 0928874 - FORD TRANSIT TOURNEO Autocarro 2.5 DI 11.1994/12.2000 51KW 69CV 2496CC 4FD 4FC 4FA 4FB 0928875 - FORD TRANSIT TOURNEO Autocarro 2.5 TD 11.1994/12.2000 63KW 85CV 2496CC 4GC 4GA 4GB 4GD 0928876 - FORD TRANSIT TOURNEO Autocarro 2.5 TD 04.1998/12.2000 74KW 100CV 2496CC 4EC 4EB 0928290</p> <p>82x75x25mm 3f-d10mm</p>		<p><b>E1070</b> NO. 1003890 - 1016405 - 1099277 - 1118218</p> <p><b>ESTICADOR DE ESCAPE</b></p> <p>FORD TOURNEO</p> <p>70x50x27mm</p>
	<p><b>F4157</b> NO. 1440749 - 2T14-V045B78-AFN2E6</p> <p><b>FOLE ALAVANCA VELOCIDADES C/ ARO PRETO</b></p> <p>Ford Transit Connect 2002/06-2013/12 P65_ P70_ P80_ 1.8 16V 1796CC 85KW 116CV - Ford Transit Connect 2002/06-2013/12 P65_ P70_ P80_ 1.8 16V LPG 1796CC 85KW 116CV - Ford Transit Connect 2002/06-2013/12 P65_ P70_ P80_ 1.8 Di 1753CC 55KW 75CV - Ford Transit Connect 2002/06-2013/12 P65_ P70_ P80_ 1.8 TDCi 1753CC 66KW 90CV - Ford Transit Connect 2006/08-2013/12 P65_ P70_ P80_ 1.8 TDCi 1753CC ...</p> <p>270x181x212mm 1f-d15mm 1f-133x105mm</p>		<p><b>F4236</b> NO. 1223834 - 1305329</p> <p><b>FOLE CAPA PROTEÇÃO AMORTECEDOR FRENTE ( GASTA 2 UNIDADES )</b></p> <p>FORD TRANSIT CONNECT Veículo multiuso: 1.5 TDCi 08.2015/»» 55KW 75CV 1499CC - FORD TRANSIT CONNECT Veículo multiuso: 1.5 TDCi 05.2015/»» 74KW 101CV 1499CC - FORD TRANSIT CONNECT Veículo multiuso: 1.5 EcoBlue 05.2018/»» 74KW 101CV 1499CC - FORD TRANSIT CONNECT Veículo multiuso: 1.5 TDCi 05.2015/»» 88KW 120CV 1499CC - FORD TRANSIT CONNECT Veículo multiuso: 1.5 EcoBlue 05.2015/»» 88KW 120CV 1499...</p> <p>d79x241mm 1f-d61mm 1f-d64mm</p>

	<p><b>F4236</b> NO. 1223834 - 1305329</p> <p>FOLE CAPA PROTEÇÃO AMORTECEDOR FRENTE ( GASTA 2 UNIDADES )</p> <p>FORD TOURNEO CONNECT / GRAND TOURNEO CONNECT V408 Veículo multius: 1.0 EcoBoost 11.2013/&gt;&gt;&gt; 74KW 100CV 998CC - FORD TOURNEO CONNECT / GRAND TOURNEO CONNECT V408 Veículo multius: 1.6 EcoBoost 11.2013/&gt;&gt;&gt; 110KW 150CV 1596CC - FORD TOURNEO CONNECT / GRAND TOURNEO CONNECT V408 Veículo multius: 1.5 TDCi 05.2015/&gt;&gt;&gt; 55KW 75CV 1499CC - FORD TOURNEO CONNECT / GRAND TOURNEO CONNECT V408 Veículo multius: 1....</p> <p>d79x241mm 1f-d61mm 1f-d64mm</p>		<p><b>H773</b> NO. 2T1428344AA</p> <p>PALAS GUARDA-LAMAS TRÁS</p> <p>FORD TOURNEO CONNECT 1.8 16V (De 2002.06 Até 2013.12) 85KW 116cv 1796cm3 Veículo multiuso - FORD TOURNEO CONNECT 1.8 TDCi /TDDi /DI (De 2002.06 Até 2013.12) 55KW 75cv 1753cm3 Veículo multiuso - FORD TOURNEO CONNECT 1.8 TDCi (De 2002.06 Até 2013.12) 66KW 90cv 1753cm3 Veículo multiuso -</p> <p>295x188x42mm 1f-d13mm</p>
	<p><b>H775</b> NO. 2T1416A562AA</p> <p>PALAS GUARDA-LAMAS DA FRENTE</p> <p>FORD TOURNEO CONNECT 1.8 16V (De 2002.06 Até 2013.12) 85KW 116cv 1796cm3 Veículo multiuso - FORD TOURNEO CONNECT 1.8 TDCi /TDDi /DI (De 2002.06 Até 2013.12) 55KW 75cv 1753cm3 Veículo multiuso - FORD TOURNEO CONNECT 1.8 TDCi (De 2002.06 Até 2013.12) 66KW 90cv 1753cm3 Veículo multiuso -</p> <p>290x185x46mm 1f-d12mm</p>		<p><b>KF1686-T</b> NO. 1603232 - 1603278 - 2T144A084AA - 4371800 - 4410860 - PP0122530</p> <p>KIT DE FOLE DO CARDAN JUNTO À RODA</p> <p>FORD TOURNEO CONNECT 1.8 Di (APÓS 2002)</p> <p>d105x130mm 1f-d90mm 1f-d27mm</p>
	<p><b>KF9011</b> NO. 1603232 - 1603278 - 2T144A084AA - 4371800 - 4410860</p> <p>KIT DE FOLE DO CARDAN JUNTO À RODA E CAIXA</p> <p>FORD TOURNEO CONNECT   TRANSIT CONNECT 1.8 16V 06.2002/12.2013 85KW 116CV 1796CC EYPD EYPC EYPA EYPB 8566523 8566525 - FORD TOURNEO CONNECT   TRANSIT CONNECT 1.8 TDCi 06.2002/12.2013 66KW 90CV 1753CC HCPD HCPC RWPF RWPE R3PA P9PD P9PC P9PB P9PA HCPB HCPA 8566524 8566AJK 8566AJM 8566AJU 8566526 - FORD TOURNEO CONNECT   TRANSIT CONNECT 1.8 TDCi 08.2006/12.2013 81KW 110CV 1753CC RWPB RWPC RWPD RWPA 8...</p> <p>d102x125mm d92x85mm 1f-d92mm 1f-d25mm 1fd82mm 1f-d25mm</p>		<p><b>KF9012</b> NO. 2T14.4A084.AA - 2T144A084DA - 4371804</p> <p>KIT DE FOLE DO CARDAN JUNTO À CAIXA</p> <p>FORD TOURNEO CONNECT 1.8Di (APÓS 2002)</p> <p>d93x85mm 1f-d86mm 1f-d21mm</p>
	<p><b>KF9024</b> NO. 2T144A084AA - 4371803 - 4371804</p> <p>KIT DE FOLE TRANSMISSÃO JUNTO CAIXA</p> <p>FORD TOURNEO CONNECT 1.8 TDCi /TDDi /DI (06.02 - 12.13) 75cv 1753cc Veículo multiuso</p> <p>d90x90mm 1f-d22mm 1f-d80mm</p>		<p><b>KF9037</b> NO. 1514345 - 1426856 - 1534276 - 1595106 - 1727141 - 1727147 - 1774394 - 1787355 - 1794505 - CC11-4C06...</p> <p>KIT DE FOLE TRANSMISSÃO LADO DA RODA</p> <p>FORD TOURNEO CONNECT / GRAND TOURNEO CONNECT V408 Veículo multius 1.0 EcoBoost (De 11.2013 -) 74kW 100cv 998cm3 Veículo multiuso - FORD TOURNEO COURIER B460 Veículo multiuso 1.0 EcoBoost (De 02.2014 -) 74kW 100cv 998cm3 Veículo multiuso -</p> <p>d118x136mm 1f-d109mm 1f-d29mm</p>
	<p><b>KF9039</b> NO. 1774393 - 1787348 - 1787353 - BK21-4A084-AB - BK21-4C062-AB</p> <p>KIT DE FOLE TRANSMISSÃO JUNTO À CAIXA</p> <p>FORD TOURNEO CONNECT / GRAND TOURNEO CONNECT V408 Veículo multius 1.0 EcoBoost (De 11.2013 -) 74kW 100cv 998cm3 Veículo multiuso -</p> <p>d102x107mm 1f-d91mm 1f-d32mm</p>		<p><b>KF9039</b> NO. 1774393 - 1787348 - 1787353 - BK21-4A084-AB - BK21-4C062-AB</p> <p>KIT DE FOLE TRANSMISSÃO JUNTO À CAIXA</p> <p>FORD TOURNEO COURIER B460 Veículo multiuso 1.0 EcoBoost (De 02.2014 -) 74kW 100cv 998cm3 Veículo multiuso -</p> <p>d102x107mm 1f-d91mm 1f-d32mm</p>
	<p><b>M6057</b> NO. 6692784 - 6797187 - 6993854</p> <p>JUNTA DE ESCAPE</p> <p>FORD TOURNEO D (1994 A 1996)</p> <p>132x75mm 1f-d61.3mm</p>		<p><b>R220517</b> NO. 5050742 - 5050744 - 5050745 - 7T169F796AE - 7T169F796CE - 8T166N650AB</p> <p>TUBO AR SOBREALIMENTAÇÃO</p> <p>FORD TOURNEO CONNECT   TRANSIT CONNECT 1.8 TDCi 06.2002/12.2013 66KW 90CV 1753CC HCPD HCPC RWPF RWPE R3PA P9PD P9PC P9PB P9PA HCPB HCPA 8566524 8566AJK 8566AJM 8566AJU 8566526 - FORD TOURNEO CONNECT   TRANSIT CONNECT 1.8 TDCi 08.2006/12.2013 81KW 110CV 1753CC RWPB RWPC RWPD RWPA 8566AJL 8566AJN 8566AJV - FORD TOURNEO CONNECT   TRANSIT CONNECT 1.8 TDCi /TDDi /DI 06.2002/12.2013 55KW 75CV 1753CC P7P... boca a boca285mmd1-39mm/285mm-56-59-73</p> <p>B540-d28/d30mm 78-142-300-90-67mm</p>
	<p><b>R221378</b> NO. 1514152 - 1704985 - 1827185 - 8V218B273BB - 8V218B273BC</p> <p>TUBO INFERIOR DO RADIADOR</p> <p>FORD TOURNEO COURIER B460 Veículo multiuso 1.5 TDCi 02.2014/12.2023 55KW 75CV 1499CC XUCC UGCA UGCB XWCA XUCD XWCB XUCE XUCF XUCG 8566BIN - FORD TOURNEO COURIER B460 Veículo multiuso 1.5 TDCi 05.2015/12.2023 70KW 95CV 1499CC XVCD XVCC XVCB XVCA 8566BLL - FORD TOURNEO COURIER B460 Veículo multiuso 1.6 TDCi 02.2014/12.2023 70KW 95CV 1560CC T3CC T3CB T3CA 8566BIM</p> <p>B540-d28/d30mm 78-142-300-90-67mm</p>		<p><b>R221378</b> NO. 1514152 - 1704985 - 1827185 - 8V218B273BB - 8V218B273BC</p> <p>TUBO INFERIOR DO RADIADOR</p> <p>FORD TRANSIT COURIER B460 Caixa/monovolume 1.5 TDCi 02.2014/12.2023 55KW 75CV 1499CC XUCC UGCA UGCB XWCA XWCB XUCE XUCG XUCF 8566BIK - FORD TRANSIT COURIER B460 Caixa/monovolume 1.5 TDCi 05.2015/12.2023 70KW 95CV 1499CC XVCD XVCC XVCB XVCA 8566BLM - FORD TRANSIT COURIER B460 Caixa/monovolume 1.6 TDCi 02.2014/12.2023 70KW 95CV 1560CC T3CC T3CB T3CA 8566BIJ</p> <p>B540-d28/d30mm 78-142-300-90-67mm</p>
	<p><b>R222435</b> NO. 1144890</p> <p>TUBO DE LIGAÇÃO AO DEPOSITO EXPANSÃO</p> <p>FORD TOURNEO CONNECT 1.8 TDCi /TDDi /DI 06.2002/12.2013 55KW 75CV 1753CC P7PA R2PA P7PB BHPA 8566AJJ</p> <p>B390-d15/d17mm 96-68-79-74-148-67mm</p>		<p><b>R225775</b> NO. 1710178 - 1710179 - AV216C646AD - AV216K863AE</p> <p>TUBO DO AR SOBREALIMENTAÇÃO</p> <p>FORD TOURNEO COURIER B460 Veículo multiuso 1.5 EcoBlue desde 04.2018 74 100 1499 XXCC XXCA XXCB 8566BQC - FORD TOURNEO COURIER B460 Veículo multiuso 1.5 TDCi desde 02.2014 55KW 75CV 1499CC XUCE XWCB XWCA XUCD XUCC UGCB UGCA 8566BIN - FORD TOURNEO COURIER B460 Veículo multiuso 1.5 TDCi desde 05.2015 70KW 95CV 1499CC XVCD XVCC XVCB XVCA 8566BLL - FORD TOURNEO COURIER B460 Veículo multiuso 1.6 TDCi d...</p> <p>B174-d47/d47mm 174mm</p>



	<p><b>R230483</b> NO. 2584513 - KV616K863BA</p> <p>TUBO DO AR SOBRELIMENTAÇÃO</p> <p>FORD TOURNEO CONNECT / GRAND TOURNEO CONNECT V408 Veículo multius 1.5 EcoBlue 05.2018/12.2022 55KW 75CV 1499CC BEGA 8566BLI - FORD TOURNEO CONNECT / GRAND TOURNEO CONNECT V408 Veículo multius 1.5 EcoBlue 05.2018/12.2022 74KW 101CV 1499CC Z2GA 8566BLJ 8566BUT - FORD TOURNEO CONNECT / GRAND TOURNEO CONNECT V408 Veículo multius 1.5 EcoBlue 05.2018/12.2022 88KW 120CV 1499CC ZTGA 8566BLK - FORD TOURNEO...</p> <p>B105-d46/d47mm 47-57mm</p>		<p><b>RT80261</b> NO. 4370933 - 4447742</p> <p>TUBO DE TRAVÃO TRÁS LH-RH (SEM ABS)</p> <p>FORD TOURNEO CONNECT TT (APÓS 06-2002)</p> <p>385mm FB42 - MC54</p>
	<p><b>RT80354</b> NO. 4447381</p> <p>TUBO DE TRAVÃO FRENTE LH-RH</p> <p>FORD TOURNEO CONNECT 1.8 16V (APÓS 06-2002) - TOURNEO CONNECT 1.8 Di (APÓS 06-2002) - TOURNEO CONNECT 1.8 TURBO Di (APÓS 06-2002)</p> <p>370mm FB69 - MG7</p>		<p><b>S1385</b> NO. 2T1418016AA - 4410223</p> <p>SILENT-BLOCO CASQUILHO AMORTECEDOR TRÁS ( GASTA 4 UNIDADES )</p> <p>FORD TOURNEO CONNECT: 1.8 16V 06.2002/12.2013 85KW 116CV 1796CC - FORD TOURNEO CONNECT: 1.8 TDCi /TDDi /DI 06.2002/12.2013 55KW 75CV 1753CC - FORD TOURNEO CONNECT: 1.8 TDCi 06.2002/12.2013 66KW 90CV 1753CC - FORD TOURNEO CONNECT: 1.8 TDCi 08.2006/12.2013 81KW 110CV 1753CC</p> <p>d37x40mm d34mm 1f-d12mm</p>
	<p><b>S1386</b> NO. 2T145791AA - 4408458</p> <p>SILENT-BLOC DAS MOLAS DE TRÁS OLHAL DE TRÁS</p> <p>FORD TOURNEO CONNECT 1.8 16V 06.2002/12.2013 85KW 116CV 1796CC EYPD EYPC EYPA EYPB 8566523 8566525 - FORD TOURNEO CONNECT 1.8 TDCi 06.2002/12.2013 66KW 90CV 1753CC HCPD HCPC RWPB RWPE R3PA P9PD P9PC P9PB P9PA HCPB HCPA 8566524 8566AJK 8566AJM 8566AJU 8566526 - FORD TOURNEO CONNECT 1.8 TDCi 08.2006/12.2013 81KW 110CV 1753CC RWPB RWPC RWPD RWPA 8566AJL 8566AJN 8566AJV - FORD TOURNEO CONNECT 1.8 TDCi...</p> <p>d37x80mm d29mm 1f-d14mm</p>		<p><b>S1387</b> NO. 2T145781AA - 4367046</p> <p>SILENT-BLOC DAS MOLAS DE TRÁS OLHAL FRENTE</p> <p>FORD TOURNEO CONNECT 1.8 16V 06.2002/12.2013 85KW 116CV 1796CC EYPD EYPC EYPA EYPB 8566523 8566525 - FORD TOURNEO CONNECT 1.8 TDCi 06.2002/12.2013 66KW 90CV 1753CC HCPD HCPC RWPB RWPE R3PA P9PD P9PC P9PB P9PA HCPB HCPA 8566524 8566AJK 8566AJM 8566AJU 8566526 - FORD TOURNEO CONNECT 1.8 TDCi 08.2006/12.2013 81KW 110CV 1753CC RWPB RWPC RWPD RWPA 8566AJL 8566AJN 8566AJV - FORD TOURNEO CONNECT 1.8 TDCi...</p> <p>d60x74mm d54mm 1f-d14mm</p>
	<p><b>S1388</b> NO. 2T145719BA - 4367044 - 4401266 - 4418511</p> <p>SILENT-BLOC DAS MOLAS TRÁS OLHAL DE TRÁS</p> <p>FORD TOURNEO CONNECT 1.8 16V 06.2002/12.2013 85KW 116CV 1796CC EYPD EYPC EYPA EYPB 8566523 8566525 - FORD TOURNEO CONNECT 1.8 TDCi 06.2002/12.2013 66KW 90CV 1753CC HCPD HCPC RWPB RWPE R3PA P9PD P9PC P9PB P9PA HCPB HCPA 8566524 8566AJK 8566AJM 8566AJU 8566526 - FORD TOURNEO CONNECT 1.8 TDCi 08.2006/12.2013 81KW 110CV 1753CC RWPB RWPC RWPD RWPA 8566AJL 8566AJN 8566AJV - FORD TOURNEO CONNECT 1.8 TDCi...</p> <p>d61x74mm d50mm 1f-d14mm</p>		<p><b>S1389</b> NO. 2T143063AA - 4366976</p> <p>SILENT-BLOC DO BRAÇO DA SUSPENSÃO DA FRENTE PARTE INFERIOR</p> <p>FORD TOURNEO CONNECT</p> <p>d50x65mm d43mm 1f-d14mm</p>
	<p><b>S1510</b> NO. 1431018 - 1453842 - 1453844 - 1720477 - 6C115719AA - 6C115719AB - 6C165719AA - 6C165781BA</p> <p>SILENTBLOC DA MOLA DE TRÁS</p> <p>FORD TOURNEO CONNECT / GRAND TOURNEO CONNECT V408 Veículo multius 1.0 EcoBoost desde 11.2013 74KW 100CV 998CC B3GA M2GA M2GB 8566BME 8566BHF - FORD TOURNEO COURIER B460 Veículo multiuso 1.0 EcoBoost desde 02.2014 74KW 100CV 998CC SFCE SFCE SFCD SFCE SFCE SFCA 8566BIL - FORD TOURNEO CUSTOM V362 Autocarro (F3) 1.0 EcoBoost PHEV desde 04.2020 92KW 125CV 996CC M1FA 8566BTV - FORD TOURNEO CUSTOM V362 A...</p> <p>d66x72mm c49mm d56mm 1f-d14mm</p>		<p><b>S1678</b> NO. 1067918 - 1149932 - 1149933 - 1209076 - 1209077 - 1212807 - 1212808 - 1332454 - 1332455 - 1355048 - ...</p> <p>SILENT-BLOC DO BRAÇO SUSPENSÃO FRENTE (SUPLENTE DO S1262)</p> <p>FORD TOURNEO CONNECT 1.8 16V (06.02 A 12.13) 116cv 1796cc Veículo multiuso - FORD TOURNEO CONNECT 1.8 TDCi /TDDi /DI (06.02 A 12.13) 75cv 1753cc Veículo multiuso - FORD TOURNEO CONNECT 1.8 TDCi (06.02 A 12.13) 90cv 1753cc Veículo multiuso - FORD TOURNEO CONNECT 1.8 TDCi (08.06 A 12.13) 110cv 1753cc Veículo multiuso</p> <p>d57x65mm c55mm 1f-d22mm</p>
	<p><b>S1928</b> NO. 1517518 - 1605790 - 1606826 - 4098237</p> <p>SILENT-BLOCO CASQUILHO AMORTECEDOR TRÁS ( GASTA 4 UNIDADES )</p> <p>FORD TOURNEO CONNECT / GRAND TOURNEO CONNECT V408 Veículo multius 1.0 EcoBoost (De 11.2013 -) 74kW 100cv 998cm3 Veículo multiuso - FORD TOURNEO COURIER B460 Veículo multiuso 1.0 EcoBoost (De 02.2014 -) 74kW 100cv 998cm3 Veículo multiuso -</p> <p>d31x40mm d30mm c18mm 1f-d12mm</p>		<p><b>S2057</b> NO. 1806880 - 2246227 - DV613A262AB - DV613A26AC</p> <p>SILENT-BLOC DO BRAÇO SUSPENSÃO DA FRENTE LADO ESQUERDO</p> <p>FORD TOURNEO CONNECT / GRAND TOURNEO CONNECT V408 (De 11.2013 -) 74kW 100cv 998cm3 Veículo multiuso - FORD TOURNEO CONNECT / GRAND TOURNEO CONNECT V408 (De 05.2015 -) 55kW 75cv 1499cm3 Veículo multiuso - FORD TOURNEO CONNECT / GRAND TOURNEO CONNECT V408 (De 08.2016 -) 70kW 95cv 1499cm3 Veículo multiuso - FORD TOURNEO CONNECT / GRAND TOURNEO CONNECT V408 (De 05.2015 -) 74kW 101cv 1499cm3 Veículo multiuso...</p> <p>160x133x65mm 1f-d22mm</p>
	<p><b>S2083</b> NO. 2T14-5791-BA - 4408459</p> <p>SILENT-BLOC DO BRINCO DAS MOLAS TRÁS PARTE INFERIOR</p> <p>FORD TOURNEO CONNECT 1.8 16V (06.2002 - 12.2013) 85kw 116cv 1796cm3 Veículo multiuso FORD TOURNEO CONNECT 1.8 TDCi (06.2002 - 12.2013) 66kw 90cv 1753cm3 Veículo multiuso FORD TOURNEO CONNECT 1.8 TDCi (08.2006 - 12.2013) 81kw 110cv 1753cm3 Veículo multiuso FORD TOURNEO CONNECT 1.8 TDCi /TDDi /DI (06.2002 - 12.2013) 55kw 75cv 1753cm3 Veículo multiuso</p> <p>d36x 54mm d31mm 1f-d14mm</p>		<p><b>T0609-I</b> NO. 1344760 - 1438211 - 2T145K570B - 2T145K570BA - 2T145K570BB - 2T145K570BC - 4367050 - 4379171 - 4379...</p> <p>BATENTE DA SUSPENSÃO DE TRÁS</p> <p>FORD TOURNEO CONNECT 1.8 16V 06.2002/12.2013 85KW 116CV 1796CC EYPD EYPC EYPA EYPB 8566523 8566525 - FORD TOURNEO CONNECT 1.8 TDCi 06.2002/12.2013 66KW 90CV 1753CC HCPD HCPC RWPB RWPE R3PA P9PD P9PC P9PB P9PA HCPB HCPA 8566524 8566AJK 8566AJM 8566AJU 8566526 - FORD TOURNEO CONNECT 1.8 TDCi 08.2006/12.2013 81KW 110CV 1753CC RWPB RWPC RWPD RWPA 8566AJL 8566AJN 8566AJV - FORD TOURNEO CONNECT 1.8 TDCi...</p> <p>d75x80mm 1f-d14mm 1f-d28mm</p>
	<p><b>T1097</b> NO. 2T144037AC - 2T144A037AC - 4379900 - 4419557</p> <p>BATENTE DA BARRA ESTABILIZADORA DE TRÁS</p> <p>FORD TOURNEO CONNECT (APÓS 2002)</p> <p>49x46x42mm 1f-d22mm</p>		<p><b>T1098</b> NO. 2T14.5484.CA - 2T145484BD - 4385316 - 4419559 - 4964972</p> <p>BATENTE DA BARRA ESTABILIZADORA DA FRENTE</p> <p>FORD TOURNEO CONNECT (APÓS 2002)</p> <p>49x46x42mm 1f-26x21mm</p>

	<p><b>T1137</b> NO. 1892603 - BK215484AC</p> <p><b>BATENTE BARRA ESTABILIZADORA FRENTE</b></p> <p>FORD TOURNEO CUSTOM Autocarro 2.0 TDCi (A Partir de 12.15) 105cv 1995cc Autocarro - FORD TOURNEO CUSTOM Autocarro 2.0 TDCi (A Partir de 12.15) 130cv 1995cc Autocarro - FORD TOURNEO CUSTOM Autocarro 2.0 TDCi (A Partir de 12.15) 170cv 1995cc Autocarro - FORD TOURNEO CUSTOM Autocarro 2.2 TDCi (A Partir de 04.12) 100cv 2198cc Autocarro - FORD TOURNEO CUSTOM Autocarro 2.2 TDCi (A Partir de 04.1...</p> <p>59x54x47mm 40x47x44mm 1f-d20mm</p>		<p><b>T1186</b> NO. 2T144A037DC - 4367068 - 4382950 - 4419558</p> <p><b>BATENTE DA BARRA ESTABILIZADORA DE TRÁS</b></p> <p>FORD TOURNEO CONNECT 1.8 16V (De 06-2002 Até 12-2013) 85kW 116CV 1796cc Veículo multiuso FORD TOURNEO CONNECT 1.8 TDCi /TDDi /DI (De 06-2002 Até 12-2013) 55kW 75CV 1753cc Veículo multiuso FORD TOURNEO CONNECT 1.8 TDCi (De 06-2002 Até 12-2013) 66kW 90CV 1753cc Veículo multiuso FORD TOURNEO CONNECT 1.8 TDCi (De 08-2006 Até 12-2013) 81kW 110CV 1753cc Veículo multiuso</p> <p>45x44x51mm 1f-d22mm</p>
	<p><b>T1221</b> NO. 1810326</p> <p><b>BATENTE DA BARRA ESTABILIZADORA DA FRENTE</b></p> <p>FORD TOURNEO CONNECT / GRAND TOURNEO CONNECT V408 Kombi 1.0 EcoBoost (De 11.2013 -) 74kW 100cv 998cm3 Combi - FORD TOURNEO CONNECT / GRAND TOURNEO CONNECT V408 Kombi 1.5 TDCi (De 05.2015 -) 55kW 75cv 1499cm3 Combi - FORD TOURNEO CONNECT / GRAND TOURNEO CONNECT V408 Kombi 1.5 TDCi (De 05.2015 -) 74kW 101cv 1499cm3 Combi - FORD TOURNEO CONNECT / GRAND TOURNEO CONNECT V408 Kombi 1.5 TDCi (De 05.2015 -) 74kW 101cv 1499cm3 Combi - FORD TOURNEO CONNECT / GRAND TOURNEO CONNECT V408 Kombi 1.5 TDCi (De 05.2015 ...</p> <p>44x47x52mm 1f-d33mm</p>		<p><b>U7033K</b> NO. 1212679 - 1212679 - 1332662 - 1474287 - 1S7C-3334-AA - 3M51-3334-AA</p> <p><b>ORINGS BOMBA DIREÇÃO ASSITIDA</b></p> <p>FORD TRANSIT TOURNEO Autocarro 2.2 (10.2011 -08.2014) 92kw 125cv 2198cm3 Autocarro FORD TRANSIT TOURNEO Autocarro 2.2 TDCi (07.2006 -08.2014) 81kw 110cv 2198cm3 Autocarro FORD TRANSIT TOURNEO Autocarro 2.2 TDCi (10.2008 -08.2014) 85kw 115cv 2198cm3 Autocarro FORD TRANSIT TOURNEO Autocarro 2.2 TDCi (07.2006 -08.2014) 96kw 131cv 2198cm3 Autocarro FORD TRANSIT TOURNEO Autocarro 2.2 TDCi (10.2007 -08...</p> <p>d11x2mm d10x2mm 1f-d7mm 1f-d6mm</p>
	<p><b>UAP83244</b> NO. 1230952 - 1432205 - 3M5QE568AA - M5Q9E568CA</p> <p><b>ANILHA PROTEÇÃO TÉRMICA INJECTORES</b></p> <p>FORD TOURNEO CONNECT / GRAND TOURNEO CONNECT Kombi 1.5 TDCi (De 05-2015 Até 1-20 -) 55kW 75CV 1499cc Combi FORD TOURNEO CONNECT / GRAND TOURNEO CONNECT V408 Kombi 1.5 TDCi (De 05-2015 Até 1-20 -) 74kW 101CV 1499cc Combi FORD TOURNEO CONNECT / GRAND TOURNEO CONNECT Kombi 1.5 TDCi (De 05-2015 Até 1-20 -) 88kW 120CV 1499cc Combi FORD TOURNEO COURIER Kombi 1.5 TDCi (De 02-2014 Até 1-20 -) 55kW 75CV 149...</p> <p>d15x2mm 1f-d7mm</p>		<p><b>UAP83252</b> NO. 1700379 - AV6Q9E568AA</p> <p><b>ANILHA PROTEÇÃO TÉRMICA INJECTORES</b></p> <p>FORD TOURNEO CONNECT / GRAND TOURNEO CONNECT V408 Veículo multius 1.6 TDCi (09.2013 -) 55kw 75cv 1560cm3 Veículo multiuso FORD TOURNEO CONNECT / GRAND TOURNEO CONNECT V408 Veículo multius 1.6 TDCi (09.2013 -) 85kw 115cv 1560cm3 Veículo multiuso</p> <p>d15x2mm 1f-d6mm</p>
	<p><b>UAP83252</b> NO. 1700379 - AV6Q9E568AA</p> <p><b>ANILHA PROTEÇÃO TÉRMICA INJECTORES</b></p> <p>FORD TOURNEO COURIER B460 Veículo multiuso 1.6 TDCi (02.2014 -) 70kw 95cv 1560cm3 Veículo multiuso</p> <p>d15x2mm 1f-d6mm</p>		<p><b>UAP83255</b> NO. 1118410 - YS4Q9E568AA</p> <p><b>ANILHA PROTEÇÃO TÉRMICA INJECTORES</b></p> <p>FORD TOURNEO CONNECT   TRANSIT CONNECT 1.8 TDCi 06.2002/12.2013 66kW 90CV 1753CC HCPD HCPD RWPF RWPE R3PA P9PD P9PC P9PB P9PA HCPB HCPA 8566524 8566AJK 8566AJM 8566AJU 8566526</p> <p>d16x1mm 1f-d7mm</p>
	<p><b>UCRZ1083</b> NO. 1328363 - 1451463 - 1451464 - 1477841 - 1477842 - 2T14-3B436-CE - 4371796 - 4N51-3B436-XK</p> <p><b>CRUZETA VEIO TRANSMISSÃO TRIPODE D43,20MM/26 DENTES</b></p> <p>FORD TOURNEO CONNECT 1.8 16V (De 06.2002 Até 12.2013) 85kW 116cv 1796cm3 Veículo multiuso - FORD TOURNEO CONNECT 1.8 TDCi (De 06.2002 Até 12.2013) 66kW 90cv 1753cm3 Veículo multiuso - FORD TOURNEO CONNECT 1.8 TDCi (De 08.2006 Até 12.2013) 81kW 110cv 1753cm3 Veículo multiuso - FORD TOURNEO CONNECT 1.8 TDCi /TDDi /DI (De 06.2002 Até 12.2013) 55kW 75cv 1753cm3 Veículo multiuso -</p> <p>d43.2mm 26 dentes</p>		<p><b>UMV25307</b> NO. 1151765 - 2S6R7217AA - 2S6R7217AC</p> <p><b>MANETE PUNHO TOPO ALAVANCA MUDANÇAS 5 VELOCIDADES F28MM</b></p> <p>FORD TOURNEO CONNECT   TRANSIT CONNECT 1.8 16V 06.2002/12.2013 85kW 116CV 1796CC EYPD EYPB EYPA EYPB 8566523 8566525 - FORD TOURNEO CONNECT   TRANSIT CONNECT 1.8 TDCi 06.2002/12.2013 66kW 90CV 1753CC HCPD HCPD RWPF RWPE R3PA P9PD P9PC P9PB P9PA HCPB HCPA 8566524 8566AJK 8566AJM 8566AJU 8566526 - FORD TOURNEO CONNECT   TRANSIT CONNECT 1.8 TDCi 08.2006/12.2013 81kW 110CV 1753CC RWPB RWPC RWPD RWPA 8...</p> <p>46x52x105mm 1f-d28mm</p>
	<p><b>UMV25329</b> NO. 1417447 - 6C1R7217KA</p> <p><b>MANETE PUNHO TOPO ALAVANCA MUDANÇAS 6 VELOCIDADES F28MM</b></p> <p>FORD TRANSIT TOURNEO Autocarro 2.2 10.2011/08.2014 92KW 125CV 2198CC CYFB CYFA CYFC CYFD - FORD TRANSIT TOURNEO Autocarro 2.2 TDCi 07.2006/08.2014 81KW 110CV 2198CC QVFA 8566AFB - FORD TRANSIT TOURNEO Autocarro 2.2 TDCi 07.2006/08.2014 96KW 131CV 2198CC QWFA 8566AFC - FORD TRANSIT TOURNEO Autocarro 2.2 TDCi 10.2007/08.2014 103KW 140CV 2198CC UHFC PGFB UHFA PGFA 8566AMJ - FORD TRANSIT TOURNEO ...</p> <p>d50x52mm 1f-d28mm</p>		<p><b>UPCR5019</b> NO. 1366029 - 1366432 - 1678260 - 2179620 - 5114407 - 6111766</p> <p><b>PORCA DA RODA CHAVE 19 M12X1,50X31MM ( BASE CONICA )</b></p> <p>FORD TOURNEO CONNECT / GRAND TOURNEO CONNECT V408 Veículo (11.2013 -) 74kw 100cv 998cm3 Veículo multiuso FORD TOURNEO CONNECT / GRAND TOURNEO CONNECT V408 Veículo multius 1.5 EcoBlue (05.2018 -) 55kw 75cv 1499cm3 Veículo multiuso FORD TOURNEO CONNECT / GRAND TOURNEO CONNECT V408 Veículo multius 1.5 EcoBlue (05.2018 -) 74kw 101cv 1499cm3 Veículo multiuso FORD TOURNEO CONNECT / GRAND TOURNEO CONNECT...</p> <p>d26x31mm M12x28mm</p>
	<p><b>UPCR5019</b> NO. 1366029 - 1366432 - 1678260 - 2179620 - 5114407 - 6111766</p> <p><b>PORCA DA RODA CHAVE 19 M12X1,50X31MM ( BASE CONICA )</b></p> <p>FORD TOURNEO COURIER B460 Veículo multiuso 1.0 EcoBoost (02.2014 -) 74kw 100cv 998cm3 Veículo multiuso FORD TOURNEO COURIER B460 Veículo multiuso 1.5 EcoBlue (04.2018 -) 74kw 100cv 1499cm3 Veículo multiuso FORD TOURNEO COURIER B460 Veículo multiuso 1.5 TDCi (05.2015 -) 70kw 95cv 1499cm3 Veículo multiuso FORD TOURNEO COURIER B460 Veículo multiuso 1.5 TDCi (02.2014 -) 55kw 75cv 1499cm3 Veículo multi...</p> <p>d26x31mm M12x28mm</p>		<p><b>UPCR5020</b> NO. 1377747 - 1382841 - 1428137 - 1676176 - 5196786 - 5275544</p> <p><b>PORCA DA RODA CHAVE 21 M14X1,5X34MM ( BASE CONICA )</b></p> <p>FORD TOURNEO CONNECT / GRAND TOURNEO CONNECT V408 Veículo multius 1.0 EcoBoost (11.2013 -) 74kw 100cv 998cm3 Veículo multiuso FORD TOURNEO CONNECT / GRAND TOURNEO CONNECT V408 Veículo multius 1.5 EcoBlue (05.2018 -) 55kw 75cv 1499cm3 Veículo multiuso FORD TOURNEO CONNECT / GRAND TOURNEO CONNECT V408 Veículo multius 1.5 EcoBlue (05.2018 -) 74kw 101cv 1499cm3 Veículo multiuso FORD TOURNEO CONNECT / ...</p> <p>d28x34mm M14x32mm</p>
	<p><b>UPCR5020</b> NO. 1377747 - 1382841 - 1428137 - 1676176 - 5196786 - 5275544</p> <p><b>PORCA DA RODA CHAVE 21 M14X1,5X34MM ( BASE CONICA )</b></p> <p>FORD TOURNEO COURIER B460 Veículo multiuso 1.0 EcoBoost (02.2014 -) 74kw 100cv 998cm3 Veículo multiuso FORD TOURNEO COURIER B460 Veículo multiuso 1.5 EcoBlue (04.2018 -) 74kw 100cv 1499cm3 Veículo multiuso FORD TOURNEO COURIER B460 Veículo multiuso 1.5 TDCi (02.2014 -) 55kw 75cv 1499cm3 Veículo multiuso FORD TOURNEO COURIER B460 Veículo multiuso 1.5 TDCi (05.2015 -) 70kw 95cv 1499cm3 Veículo multi...</p> <p>d28x34mm M14x32mm</p>		<p><b>URTE6021</b> NO. 1490305 - 8C1R-3K169-AA</p> <p><b>RETENTOR VEIO DIFERENCIAL TRANSMISSÃO D44X60/67,2X13MM</b></p> <p>FORD TOURNEO CONNECT / GRAND TOURNEO CONNECT V408 Veículo multius 1.0 EcoBoost desde 11.2013 74 100 998 B3GA M2GA M2GB 8566BME 8566BHF</p> <p>d67x13mm 1f-d42mm</p>

	<p><b>URTE6021</b> NO. 1490305 - 8C1R-3K169-AA</p> <p>RETENTOR VEIO DIFERENCIAL TRANSMISSÃO D44X60/67,2X13MM</p> <p>FORD TOURNEO CONNECT / GRAND TOURNEO CONNECT V408 Veículo multius 1.0 EcoBoost desde 11.2013 74 100 998 B3GA M2GA M2GB 8566BME 8566BHF</p> <p>d67x13mm 1f-d42mm</p>		<p><b>URTE6021</b> NO. 1490305 - 8C1R-3K169-AA</p> <p>RETENTOR VEIO DIFERENCIAL TRANSMISSÃO D44X60/67,2X13MM</p> <p>FORD TOURNEO COURIER B460 Veículo multiuso 1.0 EcoBoost desde 02.2014 74KW 100CV 998CC SFCE SFCE SFCD SFCC SFCB SFCA 8566BIL</p> <p>d67x13mm 1f-d42mm</p>
	<p><b>URTE6021</b> NO. 1490305 - 8C1R-3K169-AA</p> <p>RETENTOR VEIO DIFERENCIAL TRANSMISSÃO D44X60/67,2X13MM</p> <p>FORD TOURNEO COURIER B460 Veículo multiuso 1.0 EcoBoost desde 02.2014 74KW 100CV 998CC SFCE SFCE SFCD SFCC SFCB SFCA 8566BIL</p> <p>d67x13mm 1f-d42mm</p>		<p><b>UTR0820</b> NO. 90352470 - 90409256 - 90409257 - 9041032690497472 - 90467473</p> <p>TAMPÃO RESERVATÓRIO LIQUIDO REFRIGERAÇÃO</p> <p>FORD TOURNEO CONNECT 1.8 16V (06.02 A 12.13) 116cv 1796cc Veículo multiuso - FORD TOURNEO CONNECT 1.8 TDCi /TDDi /DI (06.02 A 12.13) 75cv 1753cc Veículo multiuso - FORD TOURNEO CONNECT 1.8 TDCi (06.02 A 12.13) 90cv 1753cc Veículo multiuso - FORD TOURNEO CONNECT 1.8 TDCi (08.06 A 12.13) 110cv 1753cc Veículo multiuso</p> <p>d62x23mm 1f-d53x12mm</p>
	<p><b>UTR0847</b> NO. 1224233 - 1301104 - 3M5H8100AC</p> <p>TAMPÃO RESERVATÓRIO LIQUIDO REFRIGERAÇÃO</p> <p>FORD TOURNEO CONNECT / GRAND TOURNEO CONNECT Kombi 1.0 EcoBoost (A Partir de 11.13) 100cv 998cc Combi - FORD TOURNEO CONNECT / GRAND TOURNEO CONNECT Kombi 1.6 EcoBoost (A Partir de 11.13) 150cv 1596cc Combi - FORD TOURNEO CONNECT / GRAND TOURNEO CONNECT Kombi 1.5 TDCi (A Partir de 05.15) 75cv 1499cc Combi - FORD TOURNEO CONNECT / GRAND TOURNEO CONNECT Kombi 1.5 TDCi (A Partir de 05.15) 101c...</p> <p>d62x35mm 1f-d50x16mm</p>		<p><b>UTR0847</b> NO. 1224233 - 1301104 - 3M5H8100AC</p> <p>TAMPÃO RESERVATÓRIO LIQUIDO REFRIGERAÇÃO</p> <p>FORD TOURNEO COURIER Kombi 1.0 EcoBoost (A Partir de 02.14) 100cv 998cc Combi - FORD TOURNEO COURIER Kombi 1.5 TDCi (A Partir de 02.14) 75cv 1499cc Combi - FORD TOURNEO COURIER Kombi 1.5 TDCi (A Partir de 05.15) 95cv 1499cc Combi - FORD TOURNEO COURIER Kombi 1.6 TDCi (A Partir de 02.14) 95cv 1560cc Combi</p> <p>d62x35mm 1f-d50x16mm</p>
	<p><b>UTR0859</b> NO. 1650630 - 94539597 - 96293957 - 96312510 - 96351578 - 96420303 - 96536649</p> <p>TAMPÃO RESERVATÓRIO LIQUIDO REFRIGERAÇÃO</p> <p>FORD TOURNEO CONNECT 1.8 16V (06.02 A 12.13) 116cv 1796cc Veículo multiuso - FORD TOURNEO CONNECT 1.8 TDCi /TDDi /DI (06.02 A 12.13) 75cv 1753cc Veículo multiuso - FORD TOURNEO CONNECT 1.8 TDCi (06.02 A 12.13) 90cv 1753cc Veículo multiuso</p> <p>d63x23mm 1f-d53x11mm</p>		<p><b>W5026</b> NO. 1038330 - 1135052 - 1250444 - 26105255 - 6599021 - 928M6B320DB - 928M6B320DD - 928M6B320DE - 928M6B3...</p> <p>POLIE CAMBOTA ( 6 PISTAS )</p> <p>FORD TOURNEO CONNECT: 1.8 16V 06.2002/12.2013 85KW 116CV 1796CC</p> <p>d131.3mm d28mm</p>
	<p><b>W5035</b> NO. 1135052</p> <p>POLIE DA CABBOTA (6 PISTAS)</p> <p>FORD TOURNEO CONNECT 1.8 16V (APÓS 06-2002)</p> <p>d132mm d28mm</p>		<p><b>W5113</b> NO. 1386188 - 1425511 - 1434432 - 1539837 - 1697695 - 1723700 - 6C1Q6B319AD - 6C1Q6B319AE - 6C1Q6B319AF</p> <p>POLIE DA CABBOTÁ (6+4 PISTAS)</p> <p>FORD TOURNEO CUSTOM Autocarro - 2.2 TDCi 100CV 2198cc (APÓS 12-2012) - 125CV 2198cc (APÓS 12-2012) - 155CV 2198cc (APÓS 12-2012) - 100CV 2198cc (APÓS 12-2012) - 125CV 2198cc (APÓS 12-2012) - 155CV 2198cc (APÓS 12-2012)</p> <p>d167mm 3f-d13mm</p>
	<p><b>Y3233</b> NO. 1473166 - 1481984 - 3395499 - 4432023 - 6586309 - 6789185</p> <p>PARAFUSO DA RODA CAVILHA M12X1,50X48MM</p> <p>FORD TOURNEO CONNECT 1.8 16V (06.2002 - 12.2013) 85kw 116cv 1796cm3 Veículo multiuso FORD TOURNEO CONNECT 1.8 TDCi (06.2002 - 12.2013) 66kw 90cv 1753cm3 Veículo multiuso FORD TOURNEO CONNECT 1.8 TDCi (08.2006 - 12.2013) 81kw 110cv 1753cm3 Veículo multiuso FORD TOURNEO CONNECT 1.8 TDCi /TDDi /DI (06.2002 - 12.2013) 55kw 75cv 1753cm3 Veículo multiuso</p> <p>c48mm M12x1,5mm</p>		<p><b>Y3235</b> NO. 1370439 - 4038464 - 4048803 - 4395255 - 4424984</p> <p>PARAFUSO DA RODA CAVILHA M14X1,50X35MM</p> <p>FORD TRANSIT TOURNEO Autocarro 2.2 (10.2011 -08.2014) 92kw 125cv 2198cm3 Autocarro FORD TRANSIT TOURNEO Autocarro 2.2 TDCi (07.2006 -08.2014) 81kw 110cv 2198cm3 Autocarro FORD TRANSIT TOURNEO Autocarro 2.2 TDCi (10.2008 -08.2014) 85kw 115cv 2198cm3 Autocarro FORD TRANSIT TOURNEO Autocarro 2.2 TDCi (07.2006 -08.2014) 96kw 131cv 2198cm3 Autocarro FORD TRANSIT TOURNEO Autocarro 2.2 TDCi (10.2007 -08....</p> <p>c48mm M12x1,25mm</p>
	<p><b>Z41158</b> NO. 1656747 - 1825595 - 1752024 - 6740771 - 4852244</p> <p>MOLA DE FIXAÇÃO TIPO PORCA</p> <p>FORD TOURNEO CUSTOM V362 Autocarro (F3) 1.0 EcoBoost PHEV (04.2020 -12.2023) 92kw 125cv 996cm3 Autocarro FORD TOURNEO CUSTOM V362 Autocarro (F3) 2.0 EcoBlue (12.2015 -12.2023) 77kw 105cv 1995cm3 Autocarro FORD TOURNEO CUSTOM V362 Autocarro (F3) 2.0 EcoBlue (12.2015 -12.2023) 96kw 130cv 1995cm3 Autocarro FORD TOURNEO CUSTOM V362 Autocarro (F3) 2.0 EcoBlue (12.2015 -12.2023) 125kw 170cv 1995cm3 Auto...</p> <p>d12x 11mm f-d24mm</p>		<p><b>Z50130</b> NO. 11589289</p> <p>MOLA REBITE FIXAÇÃO</p> <p>FORD TOURNEO CONNECT / GRAND TOURNEO CONNECT V408 Veículo multius 1.0 EcoBoost (11.2013 - 12.2022) 74kw 100cv 998cm3 Veículo multiuso FORD TOURNEO CONNECT / GRAND TOURNEO CONNECT V408 Veículo multius 1.5 EcoBlue (05.2018 -12.2022) 55kw 75cv 1499cm3 Veículo multiuso FORD TOURNEO CONNECT / GRAND TOURNEO CONNECT V408 Veículo multius 1.5 EcoBlue (05.2018 - 12.2022) 74kw 101cv 1499cm3 Veículo multiuso ...</p> <p>d6x 18mm f-d17mm</p>
	<p><b>Z50130</b> NO. 11589289</p> <p>MOLA REBITE FIXAÇÃO</p> <p>FORD TOURNEO COURIER B460 Veículo multiuso 1.0 EcoBoost (02.2014 -12.2023) 74kw 100cv 998cm3 Veículo multiuso FORD TOURNEO COURIER B460 Veículo multiuso 1.5 EcoBlue (04.2018 -12.2023) 74kw 100cv 1499cm3 Veículo multiuso FORD TOURNEO COURIER B460 Veículo multiuso 1.5 TDCi (02.2014 -12.2023) 55kw 75cv 1499cm3 Veículo multiuso FORD TOURNEO COURIER B460 Veículo multiuso 1.5 TDCi (05.2015 -12.2023) 70k...</p> <p>d6x 18mm f-d17mm</p>		

	<p><b>A0125</b> NO. 1045715 - 6177036 - 88VB6068AB</p> <p><b>APOIO DA CAIXA</b></p> <p>FORD TRANSIT Autocarro (E_) 2.0 09.1991/09.1994 66KW 90CV 1993CC NBA - FORD TRANSIT Autocarro (E_) 2.0 i (EBL, EDL, EGL, ESS, EUS) 09.1991/07.1994 72KW 98CV 1994CC NCA 0928793 0928796 0928800 0928789 2028346 0928846 0928200 - FORD TRANSIT Autocarro (E_) 2.5 DI (EBS, EDS, EDL, ESS, EUS) 08.1991/07.1994 51KW 70CV 2496CC 4BC 4FA 4CC 0928794 0928797 0928801 0928790 2028347 0928847 - FORD TRANSIT...</p> <p>130x90x70mm 2p-d10-25mm 2p-d10-25mm</p>		<p><b>A0139</b> NO. 1519545 - 72GB8125AA</p> <p><b>APOIO DO RADIADOR</b></p> <p>FORD TRANSIT Autocarro (E_) 2.0 i (EBL, EDL, EGL, ESS, EUS) 09.1991/07.1994 72KW 98CV 1994CC NCA 0928793 0928796 0928800 0928789 2028346 0928846 0928200 - FORD TRANSIT Autocarro (E_) 2.5 DI (EBS, EDS, EDL, ESS, EUS) 08.1991/07.1994 51KW 70CV 2496CC 4BC 4FA 4CC 0928794 0928797 0928801 0928790 2028347 0928847 - FORD TRANSIT Autocarro (E_) 2.5 DI (EBS, EDS, EGL, ESS, EUS) 09.1991/07.1994 59KW 8... </p> <p>d25x20mm 1p-d6-18mm 1p-d6-18mm</p>
	<p><b>A0405</b> NO. 11550756 - 1454274 - 1470480 - 6005152 - 711F.6038.AA</p> <p><b>APOIO SUPORTE DO MOTOR</b></p> <p>FORD TRANSIT Autocarro (V_) 1.6 (VAS, VLS, VZS) 12.1977/10.1986 48KW 65CV 1593CC - FORD TRANSIT Autocarro (V_) 2.0 (VAS, VBLVIL, VLS, VUL, VZS) 12.1977/07.1982 43KW 59CV 1993CC - FORD TRANSIT Autocarro (V_) 2.0 (VAS, VLS, VZS) 11.1977/10.1986 55KW 75CV 1993CC - FORD TRANSIT Autocarro (V_) 2.0 (VAS, VIL, VLS, VUL, VZS) 11.1977/10.1986 57KW 78CV 1993CC - FORD TRANSIT Caixa (V_) 1.6 (W... </p> <p>d75x38mm 1p-d10-23mm 1p-d10-23mm</p>		<p><b>A0532</b> NO.</p> <p><b>SUPORTE DO MOTOR</b></p> <p>FORD TRANSIT PERKINS</p> <p>102x52x44mm 1p-d9-16mm</p>
	<p><b>A0960</b> NO. 1454275 - 1515124 - 711F6068AB - 72HF.6068.AB - 72HF6068AA</p> <p><b>APOIO SUPORTE TRÁS DO MOTOR</b></p> <p>FORD TRANSIT Autocarro (72E, 73E) 1.5 900 (7200) 11.1965/08.1969 44KW 60CV 1498CC - FORD TRANSIT Autocarro (72E, 73E) 1.5 900 (7300) 11.1965/05.1973 44KW 60CV 1498CC - FORD TRANSIT Autocarro (72E, 73E) 1.5 1100 (72000) 11.1965/07.1971 44KW 60CV 1498CC - FORD TRANSIT Autocarro (V_) 1.6 (VAS, VLS, VZS) 12.1977/10.1986 48KW 65CV 1593CC - FORD TRANSIT Autocarro (V_) 2.0 (VAS, VBLVIL, VLS, VUL... </p> <p>166x97x55mm 1f-d13mm</p>		<p><b>A0988</b> NO.</p> <p><b>SUPORTE DA TRANSMISSÃO</b></p> <p>FORD TRANSIT F32 CAIXA ABERTA (1980 A 1986)</p> <p>117x112x47mm d64mm</p>
	<p><b>A0997</b> NO. 6152795 - 7055286 - 86VB.6038.BB</p> <p><b>APOIO SUPORTE FRENTE DO MOTOR</b></p> <p>FORD TRANSIT Autocarro (T_) 1.6 (TBL, TES) 12.1985/01.1989 46KW 63CV 1593CC - FORD TRANSIT Autocarro (T_) 2.0 (TBS, TCL, TCS, TEL, TES) 11.1985/09.1992 57KW 78KW 1994CC - FORD TRANSIT Autocarro (T_) 2.0 Cat (TBS, TCL, TCS) 12.1985/09.1992 57KW 78CV 1993CC - FORD TRANSIT Autocarro (T_) 2.5 D (TBS, TCL, TCS, TEL, TES) 12.1985/01.1989 50KW 68CV 2496CC - FORD TRANSIT Autocarro (T_) 2.5 ... </p> <p>d90x57mm 1p-d10-26mm 1p-d10-26mm</p>		<p><b>A1337D</b> NO. 7128520 - 7240354 - 7280607 - 7354179 - 95VB6038BC - 95VB6038BD - 95VB6038BE - 95VB6038BF</p> <p><b>APOIO DIREITO DO MOTOR</b></p> <p>FORD TRANSIT Autocarro (E_) 2.5 DI (EBS, EDS, EDL, ESS, EUS) 08.1991/07.1994 51KW 70CV 2496CC 4BC 4FA 4CC 0928794 0928797 0928801 0928790 2028347 0928847 - FORD TRANSIT Autocarro (E_) 2.5 DI (EBS, EDS, EGL, ESS, EUS) 09.1991/07.1994 59KW 80CV 2496CC 4DA 0928795 0928798 0928802 0928791 2028348 0928848 0928201 - FORD TRANSIT Autocarro (E_) 2.5 TD (EBS, EBL, ECL, EDS, EDL, ESS, EUS) 10.1992/0... </p> <p>d103x92mm 1p-d12-32mm 1p-d12-55mm</p>
	<p><b>A1338E</b> NO. 7240357 - 7280608 - 7354180 - 95VB6032BB - 95VB6032BC - 95VB6032BD</p> <p><b>APOIO ESQUERDO DO MOTOR</b></p> <p>FORD TRANSIT Autocarro (E_) 2.5 DI (EBS, EDS, EDL, ESS, EUS) 08.1991/07.1994 51KW 70CV 2496CC 4BC 4FA 4CC 0928794 0928797 0928801 0928790 2028347 0928847 - FORD TRANSIT Autocarro (E_) 2.5 DI (EBS, EDS, EGL, ESS, EUS) 09.1991/07.1994 59KW 80CV 2496CC 4DA 0928795 0928798 0928802 0928791 2028348 0928848 0928201 - FORD TRANSIT Autocarro (E_) 2.5 TD (EBS, EBL, ECL, EDS, EDL, ESS, EUS) 10.1992/07... </p> <p>d103x92mm 1p-d12-32mm 1p-d12-55mm</p>		<p><b>A1339</b> NO. 6675788 - 6763456 - 92VB.3K155.AD - 92VB3K155AA - 92VB5349-AB</p> <p><b>APOIO DO AMORTECEDOR DA FRENTE DIREITO E ESQUERDO</b></p> <p>FORD TRANSIT Autocarro (E_) 2.0 09.1991/09.1994 66KW 90CV 1993CC NBA - FORD TRANSIT Autocarro (E_) 2.0 i (EBL, EDL, EGL, ESS, EUS) 09.1991/07.1994 72KW 98CV 1994CC NCA 0928793 0928796 0928800 0928789 2028346 0928846 0928200 - FORD TRANSIT Autocarro (E_) 2.5 DI (EBS, EDS, EDL, ESS, EUS) 08.1991/07.1994 51KW 70CV 2496CC 4BC 4FA 4CC 0928794 0928797 0928801 0928790 2028347 0928847 - FORD TRANSIT... </p> <p>142x130x45mm 3p-d10-32mm 1f-d11.5mm</p>
	<p><b>A1340</b> NO. 4060617 - 4104708 - 6635542 - 7239265 - 88VB4826 - 8C11.4826.AB - 95VB.4826.AA - 99VB.4826.AB...</p> <p><b>APOIO DA TRANSMISSÃO</b></p> <p>FORD TRANSIT TOURNEO CUSTOM V362 Autocarro (F3) 2.2 TDCi 04.2012/12.2015 74KW 100CV 2198CV DRF FDR F4D RFG 8566BFQ - FORD TRANSIT TOURNEO CUSTOM V362 Autocarro (F3) 2.2 TDCi 04.2012/12.2015 92KW 125CV 2198CC CYF 4CY FF 8566BFR - FORD TRANSIT TOURNEO CUSTOM V362 Autocarro (F3) 2.2 TDCi 04.2012/12.2015 114KW 155CV 2198CC CVFF 8566BFS - FORD TRANSIT Autocarro (E_) 2.0 09.1991/09.1994 66KW 90CV 1993CC...</p> <p>175x120x50mm 1f-d30mm</p>		<p><b>A1341</b> NO. 1447370 - 6635542 - 6649122 - 664912252 - 924F4826 - 92VB.4826.BB - 95VB4826AA - 98VB.4826.A1B ...</p> <p><b>APOIO DA TRANSMISSÃO</b></p> <p>FORD TRANSIT Autocarro (E_) 2.0 09.1991/09.1994 66KW 90CV 1993CC NBA - FORD TRANSIT Autocarro (E_) 2.0 i (EBL, EDL, EGL, ESS, EUS) 09.1991/07.1994 72KW 98CV 1994CC NCA 0928793 0928796 0928800 0928789 2028346 0928846 0928200 - FORD TRANSIT Autocarro (E_) 2.5 DI (EBS, EDS, EDL, ESS, EUS) 08.1991/07.1994 51KW 70CV 2496CC 4BC 4FA 4CC 0928794 0928797 0928801 0928790 2028347 0928847 - FORD TRANSIT... </p> <p>180x125x49mm 1f-d45mm</p>
	<p><b>A1342</b> NO. 6111851 - 84VB.8124AA</p> <p><b>APOIO SUPORTE RADIADOR</b></p> <p>FORD TRANSIT Autocarro (E_) 2.0 09.1991/09.1994 66KW 90CV 1993CC NBA - FORD TRANSIT Autocarro (E_) 2.0 i (EBL, EDL, EGL, ESS, EUS) 09.1991/07.1994 72KW 98CV 1994CC NCA 0928793 0928796 0928800 0928789 2028346 0928846 0928200 - FORD TRANSIT Autocarro (E_) 2.5 DI (EBS, EDS, EDL, ESS, EUS) 08.1991/07.1994 51KW 70CV 2496CC 4BC 4FA 4CC 0928794 0928797 0928801 0928790 2028347 0928847 - FORD TRANSIT... </p> <p>d44x48mm d23.5mm d20mm 1f-d7mm</p>		<p><b>A1347</b> NO.</p> <p><b>SEPARADOR DAS MOLAS</b></p> <p>FORD TRANSIT (APÓS 1986)</p> <p>d41x100mm</p>
	<p><b>A1351</b> NO. 2400E-3020 - 2400E40444</p> <p><b>APOIO BATENTE DO CHASSIS</b></p> <p>FORD TRANSIT Autocarro (T_) 1.6 (TBL, TES) 12.1985/01.1989 46KW 63CV 1593CC LAT 0928607 0928616 - FORD TRANSIT Autocarro (T_) 2.0 (TBS, TCL, TCS, TEL, TES) 11.1985/09.1992 57KW 78CV 1994CC NAT NAV 0928639 0928608 0928617 0928776 0928164 0928166 - FORD TRANSIT Autocarro (T_) 2.0 Cat (TBS, TCL, TCS) 12.1985/09.1992 57KW 78CV 1993CC N6T 0928617 0928776 0928164 0928166 - FORD TRANSIT Autocarro (... </p> <p>105x80x45mm</p>		<p><b>A1379</b> NO. 0440558 - 0440890 - 1016190 - 1516282 - 1596242 - 1613022 - 1613023 - 1649554 - 440890 - 6163548 ...</p> <p><b>APOIO DE TRANSMISSÃO COM ROLAMENTO 30MM</b></p> <p>FORD TRANSIT Autocarro (V_) 1.6 (VAS, VLS, VZS) 12.1977/10.1986 48KW 65CV 1593CC - FORD TRANSIT Autocarro (V_) 2.0 (VAS, VBLVIL, VLS, VUL, VZS) 12.1977/07.1982 43KW 59CV 1993CC - FORD TRANSIT Autocarro (V_) 2.0 (VAS, VLS, VZS) 11.1977/10.1986 55KW 75CV 1993CC - FORD TRANSIT Autocarro (V_) 2.0 (VAS, VIL, VLS, VUL, VZS) 11.1977/10.1986 57KW 78CV 1993CC - FORD TRANSIT Autocarro (V_) 2... </p> <p>160x100x72mm 1f-d30mm</p>

	<p><b>A1515</b> NO. 1330122 - 3C166068AA - 4041541 - 4059109 - YC15.6068AA - YC1536068AF - YC156068AE - YC156068AF</p> <p><b>APOIO DO MOTOR</b></p> <p>FORD TRANSIT Autocarro (FD_., FB_., FS_., FZ_., FC_.) 2.3 16V RWD (F_B_., F_C_., F_A_) 08.2000/05.2006 107KW 146CV 2295CC E5FC E5FA 8566084 8566426 8566424 8566428 8566430 8566434 8566439 - FORD TRANSIT Autocarro (FD_., FB_., FS_., FZ_., FC_.) 2.4 DI (F_B_., F_C_., F_A_) 01.2000/05.2006 66KW 90CV 2402CC D2FB D2FA 8566082 8566094 8566431 8566436 8566385 8566388 8566379 8566382 - FORD TRANSIT ...</p> <p>d50x34mm 2p-d18-15mm</p>		<p><b>A1568</b> NO. 4041955 - 4053300 - 4070497 - 4094280 - 4360393 - 4706416 - 5C11.18183AA - YC11.18183AA - Y...</p> <p><b>APOIO AMORTECEDOR FRENTE ( GASTA 2 UNIDADES )</b></p> <p>FORD TRANSIT Autocarro (E_.) 2.5 DI (EBL, EDL, EDS, ESL, ESS) 08.1997/03.2000 85KW 116CV 2496CC 4ED 0928263 8566335 8566336 8566337 8566338 8566339 - FORD TRANSIT Autocarro (FD_., FB_., FS_., FZ_., FC_.) 2.0 DI (F_E_., F_F_., F_G_) 08.2000/05.2006 55KW 75CV 1998CC D3FA 8566442 8566444 8566446 8566448 8566450 8566452 8566454 - FORD TRANSIT Autocarro (FD_., FB_., FS_., FZ_., FC_.) 2.0 DI (F...</p> <p>d120x40mm 3p-d8-26mm</p>
	<p><b>A1595</b> NO. 6704254 - 7324691 - 948125 - 94BB.8125.BB</p> <p><b>APOIO SUPORTE RADIADOR INFERIOR</b></p> <p>FORD TRANSIT V184 (2000 A 2006)</p> <p>d41x38mm 1f-d18-14mm</p>		<p><b>A1596</b> NO. 1354636 - 7324692 - 94BB.8125.CA</p> <p><b>APOIO SUPORTE RADIADOR SUPERIOR</b></p> <p>FORD TRANSIT V184 (2000 A 2006)</p> <p>d53x50mm d29mm 1f-d14mm</p>
	<p><b>A1680</b> NO. 1000941 - 1100941 - 1104173 - 1142702 - 1332880 - 1M51.6F012.BB - 1M516F012AD - 1M516F012BA - 522461...</p> <p><b>APOIO DO MOTOR LADO DIREITO</b></p> <p>FORD TRANSIT CONNECT (P65_., P70_., P80_.): 1.8 Di 06.2002/12.2013 55KW 75CV 1753CC</p> <p>235x130x120mm</p>		<p><b>A1690</b> NO. 1000941 - 1100941 - 1104173 - 1142702 - 1332880 - 1M51.6F012.AD - 1M51.6F012.BA - 1M51.6F012.BB - 52...</p> <p><b>APOIO DO MOTOR PARTE DA FRENTE</b></p> <p>FORD TRANSIT CONNECT (P65_., P70_., P80_.): 1.8 Di 06.2002/12.2013 55KW 75CV 1753CC - FORD TRANSIT CONNECT (P65_., P70_., P80_.): 1.8 TDCi 06.2002/12.2013 66KW 90CV 1753CC - FORD TRANSIT CONNECT (P65_., P70_., P80_.): 1.8 TDCi 08.2006/12.2013 81KW 110CV 1753CC</p> <p>145x120x77mm 1f-d10mm</p>
	<p><b>A1784</b> NO. 1224049 - 1250824 - 1355357 - 1370874 - 1404996 - 1420044 - 1522138 - 1533046 - 1751001 - 3M516P082A...</p> <p><b>APOIO DA CAIXA VELOCIDADES</b></p> <p>FORD TRANSIT CONNECT Veículo multiuso: 1.6 TDCi 02.2013/»» 55KW 75CV 1560CC - FORD TRANSIT CONNECT Veículo multiuso: 1.6 TDCi 02.2013/»» 70KW 95CV 1560CC - FORD TRANSIT CONNECT Veículo multiuso: 1.6 TDCi 02.2013/»» 85KW 115CV 1560CC - FORD TRANSIT CONNECT V408 Caixa/monovolume: 1.6 EcoBoost 11.2013/»» 110KW 150CV 1596CC - FORD TRANSIT CONNECT V408 Caixa/monovolume: 1.6 TDCi 02.2013/»» 55KW 75...</p> <p>160x1005x45mm 2f-d12mm 1f-M12</p>		<p><b>A1820</b> NO. 1510905 - 1824066 - 8C114826AA - YCIW-4826-BC</p> <p><b>APOIO DA TRANSMISSÃO</b></p> <p>FORD TRANSIT Autocarro (FD_., FB_., FS_., FZ_., FC_.): 2.2 TDCi 04.2006/08.2014 63KW 85CV 2198CC - FORD TRANSIT Autocarro (FD_., FB_., FS_., FZ_., FC_.): 2.2 TDCi 04.2006/08.2014 81KW 110CV 2198CC - FORD TRANSIT Autocarro (FD_., FB_., FS_., FZ_., FC_.): 2.2 TDCi 10.2008/08.2014 85KW 115CV 2198CC - FORD TRANSIT Autocarro (FD_., FB_., FS_., FZ_., FC_.): 2.2 TDCi 04.2006/08.2014 9...</p> <p>175x120x50mm 1f-d35mm</p>
	<p><b>A1821</b> NO. 3C166F014BA - 4055199 - 4058084 - 4077637 - 4164666 - 4409223 - 4638390 - YC156038AA - YC156014AE - ...</p> <p><b>APOIO MOTOR DIREITO</b></p> <p>FORD TRANSIT V184 (2001 A 2006)</p> <p>95x90x72mm 2p-d12x30mm</p>		<p><b>A1826</b> NO. 1377973 - 1488960 - 6C1118183AB - 6C1118183AC - BK2118183AA</p> <p><b>APOIO DO AMORTECEDOR DA FRENTE DIREITO E ESQUERDO</b></p> <p>FORD TRANSIT Autocarro 2.2 TDCi (04.06 - 08.14) 85cv 2198cc - FORD TRANSIT Autocarro 2.2 TDCi (10.11 - 08.14) 100cv 2198cc - FORD TRANSIT Autocarro 2.2 TDCi [RWD] (10.11 - 08.14) 100cv 2198cc - FORD TRANSIT Autocarro 2.2 TDCi (04.06 - 08.14) 110cv 2198cc</p> <p>120x33mm 1f-d12mm 3p-d8x27mm</p>
	<p><b>A1897</b> NO. 1443802 - 1461881 - 1547946 - 1564470 - 3047E-6038A - 78VB6038AA</p> <p><b>APOIO DO MOTOR</b></p> <p>FORD TRANSIT Autocarro (V_.): 2.4 D (VAS, VBL, VIL, VUL, VZS) 12.1977/10.1986 46KW 63CV 2358CC - FORD TRANSIT Caixa (V_.): 2.4 D (VVS) 11.1977/10.1986 46KW 63CV 2358CC - FORD TRANSIT Camião de plataforma/chassis (V_.): 2.4 D (VGL, VSL, VTL, VCS, VDS) 11.1977/09.1985 46KW 62CV 2358CC</p> <p>d75x46mm 1p-d10x23mm 1p-d10x23mm</p>		<p><b>A1923</b> NO. 1371180 - 1494924 - 6C116068CB</p> <p><b>APOIO CAIXA VELOCIDADES C/ PINO GUIA</b></p> <p>FORD TRANSIT Autocarro (FD_., FB_., FS_., FZ_., FC_.) 2.4 DI [RWD] (F_B_., F_C_.) (01.00 - 05.06) 75cv 2402cc Autocarro - FORD TRANSIT Autocarro (FD_., FB_., FS_., FZ_., FC_.) 2.4 DI (F_B_., F_C_., F_A_) (01.00 - 05.06) 90cv 2402cc Autocarro - FORD TRANSIT Autocarro (FD_., FB_., FS_., FZ_., FC_.) 2.4 TDE (03.04 - 05.06) 115cv 2402cc Autocarro - FORD TRANSIT Autocarro (FD_., FB_., FS_., FZ_., FC_.) 2.4 DI [RWD] (F_B_., F_C_., F_A_) (01.00 - 05...</p> <p>170x80x65mm 2r-M10 1f-d10mm</p>
	<p><b>A1926</b> NO. 1072572 - 1102456 - 11102572 - 1112025 - 1S416038BA - 98AB6038DG - 98AB6038DH - YS416038BA</p> <p><b>APOIO MOTOR LADO DIREITO</b></p> <p>FORD TRANSIT CONNECT (P65_ P70_ P80_) 1.8 16V (06.02 A 12.13) 116cv 1796cc Caixa</p> <p>120x120x100mm 1p-d12x38mm</p>		<p><b>A2199</b> NO. 2f-10x28mm 1f-8x12mm 1f-d8mm 1p-d1</p> <p><b>APOIO DO MOTOR LADO DIREITO E ESQUERDO</b></p> <p>FORD TRANSIT Autocarro (FD_., FB_., FS_., FZ_., FC_.) 2.4 TDCi 03.2004/05.2006 101KW 137CV 2402CC H9FA 8566121 8566556 8566558 8566560 8566562 8566564 8566566 8566569 - FORD TRANSIT Caixa (FA_) 2.4 TDCi 03.2004/05.2006 101KW 137CV 2402CC H9FA 8566109 8566113 8566111 8566115 - FORD TRANSIT Caixa (FA_) 2.3 16V RWD 04.2006/08.2014 107KW 145CV 2261CC GZFB GZFC GZFA 8566AGQ 8566AHA 8566AHX - F...</p> <p>183x125x137mm 2f-10x28mm 1f-8x12mm 1f-d8mm 1p-d11</p>
	<p><b>A2200</b> NO. 1494926 - 3C117M124AB - 3C117M124AC - 3C117M124AD - 4519496 - 4721591</p> <p><b>APOIO DO MOTOR LADO ESQUERDO</b></p> <p>FORD TRANSIT Autocarro (De 2000.08 Até 2006.05) 55kW 75cv 1998cm3 Autocarro - FORD TRANSIT Autocarro (De 2000.08 Até 2006.05) 63kW 86cv 1998cm3 Autocarro - FORD TRANSIT Autocarro (De 2000.08 Até 2006.05) 74kW 100cv 1998cm3 Autocarro - FORD TRANSIT Autocarro 2.0 TDCi (De 2002.08 Até 2006.05) 92kW 125cv 1998cm3 Autocarro - FORD TRANSIT Autocarro (De 2002.08 Até 2006.05) 92kW 125cv 1998cm3 Caixa (FA_) 1f-d12mm 1f-d11mm</p>		<p><b>A2204</b> NO. 1C15-4002-AD - 4041466 - 4409292</p> <p><b>APOIO BATENTE DE MOLA TRÁS ( GASTA 2 UNIDADES )</b></p> <p>FORD TRANSIT Autocarro 2.0 DI (De 2000.08 Até 2006.05) 55kW 75cv 1998cm3 Autocarro - FORD TRANSIT Autocarro 2.0 DI (De 2000.08 Até 2006.05) 63kW 86cv 1998cm3 Autocarro - FORD TRANSIT Autocarro 2.0 DI (De 2000.08 Até 2006.05) 74kW 100cv 1998cm3 Autocarro - FORD TRANSIT Autocarro 2.0 TDCi (De 2002.08 Até 2006.05) 92kW 125cv 1998cm3 Autocarro - FORD TRANSIT Autocarro 2.0 TDCi (De 2002.08 Até 2006.05) 92kW 125cv 1998cm3 Caixa (FA_) 2f-d8mm</p>

	<p><b>A2268</b> NO. 1C156P082AC - 1C156P082AD - 1C156P082AE - 4112626 - 4375186 - 4433028</p> <p><b>APOIO DO MOTOR LADO DIREITO</b></p> <p>FORD TRANSIT Autocarro 00.08 - 06.05 55 75 1998 Autocarro          FORD TRANSIT Autocarro 00.08 - 06.05 63 86 1998 Autocarro          FORD TRANSIT Autocarro 00.08 - 06.05 74 100 1998 Autocarro          FORD TRANSIT Autocarro 2.0 TDCi 02.08 - 06.05 92 125 1998 Autocarro          FORD TRANSIT Caixa (FA_) 2.0 DI 00.08 - 06.05 55 75 1998 Caixa          FORD TRANSIT Caixa (FA_) 2.0 DI 00.08 - 06.05 63 86 1998 Caixa          FORD TRANSIT Caixa...</p> <p>320x156x69mm 4f-d10mm 1f-d14</p>		<p><b>A2302</b> NO. 1224049 - 1355357 - 1404996 - 1420044</p> <p><b>APOIO CAIXA VELOCIDADES</b></p> <p>FORD TRANSIT CONNECT Combi: 1.5 TDCi 05.2015/»» 74KW 101CV 1499CC - FORD TRANSIT CONNECT Combi: 1.5 TDCi 05.2015/»» 88KW 120CV 1499CC - FORD TRANSIT CONNECT Combi: 1.6 TDCi 02.2013/»» 55KW 75CV 1560CC - FORD TRANSIT CONNECT Combi: 1.6 TDCi 02.2013/»» 70KW 95CV 1560CC - FORD TRANSIT CONNECT Combi: 1.6 TDCi 02.2013/»» 85KW 115CV 1560CC - FORD TRANSIT CONNECT V408 Caixa: 1.6 EcoBoost 11.2013/»»...</p> <p>175x108x43mm 1f-d12mm 1f-d14mm 1r-d11mm</p>
	<p><b>A2344</b> NO. 1p-d11x41mm 1f-d8mm 2f-11x28mm 1f-</p> <p><b>APOIO DO MOTOR LADO DIREITO E ESQUERDO</b></p> <p>FORD TRANSIT Autocarro (FD_, FB_, FS_, FZ_, FC_) 2.4 TDCi (De 03.2004 Até 05.2006) 101kW 137cv 2402cm3 Autocarro - FORD TRANSIT Autocarro (FD_, FB_, FS_, FZ_, FC_) 2.4 TDCi (De 04.2006 Até 08.2014) 74kW 100cv 2402cm3 Autocarro - FORD TRANSIT Autocarro (FD_, FB_, FS_, FZ_, FC_) 2.4 TDCi (De 04.2006 Até 08.2014) 85kW 115cv 2402cm3 Autocarro - FORD TRANSIT Autocarro (FD_...)</p> <p>149x134x145mm 1p-d11x41mm 1f-d8mm 2f-11x28mm 1f-9</p>		<p><b>A2346</b> NO. 1p-d12x66mm 1f-d8mm 2f-10x27mm 1f-</p> <p><b>APOIO DO MOTOR LADO DIREITO E ESQUERDO</b></p> <p>FORD TRANSIT V363 Autocarro (FAD, FBD) 2.2 TDCi 4x4 (De 08.2013 -) 92kW 125cv 2198cm3 Autocarro - FORD TRANSIT V363 Autocarro (FAD, FBD) 2.2 TDCi RWD (De 08.2013 -) 74kW 100cv 2198cm3 Autocarro - FORD TRANSIT V363 Autocarro (FAD, FBD) 2.2 TDCi RWD (De 08.2013 -) 92kW 125cv 2198cm3 Autocarro - FORD TRANSIT V363 Autocarro (FAD, FBD) 2.2 TDCi RWD (De 08.2013 -) 114kW 155cv 2198cm3 Autocarro - FORD TR...</p> <p>146x135x126mm 1p-d12x66mm 1f-d8mm 2f-10x27mm 1f-8x12mm ...</p>
	<p><b>A2347</b> NO. 1839188</p> <p><b>APOIO DO MOTOR LADO CAIXA VELOCIDADES</b></p> <p>FORD TRANSIT COURIER (2014 A 2016)</p> <p>167x159x68mm 3p-d6x14mm 4f-12x20mm</p>		<p><b>A2380</b> NO. 1872079 - 2111961 - F1F16F012AA - F1F16F012BB</p> <p><b>APOIO DO MOTOR LADO DIREITO</b></p> <p>FORD TRANSIT CONNECT Combi 1.5 TDCi (De 05.2015 -) 74kW 101cv 1499cm3 Combi - FORD TRANSIT CONNECT Combi 1.5 TDCi (De 05.2015 -) 88kW 120cv 1499cm3 Combi - FORD TRANSIT CONNECT V408 Caixa 1.5 TDCi (De 08.2015 -) 55kW 75cv 1499cm3 Caixa - FORD TRANSIT CONNECT V408 Caixa 1.5 TDCi (De 05.2015 -) 74kW 101cv 1499cm3 Caixa - FORD TRANSIT CONNECT V408 Caixa 1.5 TDCi (De 05.2015 -) 88kW 120cv 1499cm3 Caixa...</p> <p>259x158x152mm 3f-d14mm 1f-d10mm 2f-19x21mm</p>
	<p><b>A2471</b> NO. 1684926 - 3M516P093DC - AV616P093NA</p> <p><b>APOIO DO MOTOR LADO CAIXA VELOCIDADES</b></p> <p>FORD TRANSIT CONNECT Veículo multiuso: 1.5 TDCi 05.2015/»» 74KW 101CV 1499CC - FORD TRANSIT CONNECT Veículo multiuso: 1.5 TDCi 05.2015/»» 88KW 120CV 1499CC - FORD TRANSIT CONNECT V408 Caixa/monovolume: 1.5 TDCi 05.2015/»» 74KW 101CV 1499CC - FORD TRANSIT CONNECT V408 Caixa/monovolume: 1.5 TDCi 05.2015/»» 88KW 120CV 1499CC</p> <p>170x110x98mm 1f-d11mm 1f-d12mm 1f-d13mm 1f-d14mm</p>		<p><b>A2497</b> NO. 1686911 - 1701509 - 1742411 - 1753974</p> <p><b>APOIO DO MOTOR PARTE DA FRENTE LADO DIREITO</b></p> <p>FORD TRANSIT CONNECT V408 Caixa/monovolume 1.6 EcoBoost (De 11.2013 -) 110kW 150cv 1596cm3 Caixa/monovolume -</p> <p>254x140x102mm 3f-d12mm 2f-20x22mm</p>
	<p><b>A2535</b> NO. 1802976 - YC155586AB - YC155586AC</p> <p><b>APOIO BATENTE DE MOLA TRÁS LÂMINAS 50MM ( GASTA 4 UNIDADES )</b></p> <p>FORD TRANSIT Autocarro (FD_, FB_, FS_, FZ_, FC_) 2.2 TDCi (De 04.2006 Até 08.2014) 81kW 110cv 2198cm3 Autocarro - FORD TRANSIT Autocarro (FD_, FB_, FS_, FZ_, FC_) 2.2 TDCi (De 10.2011 Até 08.2014) 92kW 125cv 2198cm3 Autocarro - FORD TRANSIT Caixa (FA_) 2.2 TDCi (De 04.2006 Até 08.2014) 81kW 110cv 2198cm3 Caixa - FORD TRANSIT Caixa (FA_) 2.2 TDCi (De 10.2011 Até 08.2014) 92kW...</p> <p>74x80x35mm 1f-49x6mm 1f-39x8mm</p>		<p><b>B404</b> NO. 1388244 - 2193360 - 6C11-5705-DA - 6C1Z-5705-A - CK4Z-5705-A</p> <p><b>ABRAÇADEIRA DE MOLA TRÁS ( GASTA 2 UNIDADES )</b></p> <p>FORD TRANSIT CONNECT V408 Caixa/monovolume 1.0 EcoBoost desde 02.2013 74KW 100CV 998CC M2GA M2GB B3GA 8566BHA</p> <p>158x106x13mm 2p-d14x58mm</p>
	<p><b>B404</b> NO. 1388244 - 2193360 - 6C11-5705-DA - 6C1Z-5705-A - CK4Z-5705-A</p> <p><b>ABRAÇADEIRA DE MOLA TRÁS ( GASTA 2 UNIDADES )</b></p> <p>FORD TRANSIT COURIER B460 Caixa/monovolume 1.0 EcoBoost desde 02.2014 74KW 100CV 998CC SFCE SFCD SFCC SFCB SFCA SFCF 8566BII - FORD TRANSIT COURIER B460 Veículo multiuso 1.0 EcoBoost desde 02.2014 74KW 100CV 998CC SFCF SFCE SFCD SFCC SFCB SFCA 8566BIL</p> <p>158x106x13mm 2p-d14x58mm</p>		<p><b>B404</b> NO. 1388244 - 2193360 - 6C11-5705-DA - 6C1Z-5705-A - CK4Z-5705-A</p> <p><b>ABRAÇADEIRA DE MOLA TRÁS ( GASTA 2 UNIDADES )</b></p> <p>FORD TRANSIT Caixa (FA_) 2.2 TDCi 04.2006/08.2014 81KW 110CV 2198CC QVFA 8566AGV 8566AHF 8566AHQ 8566AGF 8566AGI 8566AGL - FORD TRANSIT Caixa (FA_) 2.2 TDCi 10.2011/08.2014 92KW 125CV 2198CC CYFC CYFD CYFB CYFA 8566BAM 8566BAO 8566BAS 8566AZQ 8566AZS 8566BDY 8566BEE 8566BEK</p> <p>158x106x13mm 2p-d14x58mm</p>
	<p><b>B404</b> NO. 1388244 - 2193360 - 6C11-5705-DA - 6C1Z-5705-A - CK4Z-5705-A</p> <p><b>ABRAÇADEIRA DE MOLA TRÁS ( GASTA 2 UNIDADES )</b></p> <p>FORD TRANSIT V363 Autocarro (FAD, FBD) 2.2 TDCi 08.2013/12.2018 92kW 125CV 2198CC CY14 CYFG CYF5 USF6 8566BHK - FORD TRANSIT V363 Autocarro (FAD, FBD) 2.2 TDCi 12.2014/12.2018 114KW 155CV 2198CC CVF5 8566BHL - FORD TRANSIT V363 Caixa (FCD, FDD) 2.2 TDCi 08.2013/12.2018 92kW 125CV 2198CC USF6 CY14 CYFG CYF5 8566BHQ 8566BHV - FORD TRANSIT V363 Caixa (FCD, FDD) 2.2 TDCi 08.2013/12.2018 114KW 155CV 2198CC USF6...</p> <p>158x106x13mm 2p-d14x58mm</p>		<p><b>B404</b> NO. 1388244 - 2193360 - 6C11-5705-DA - 6C1Z-5705-A - CK4Z-5705-A</p> <p><b>ABRAÇADEIRA DE MOLA TRÁS ( GASTA 2 UNIDADES )</b></p> <p>FORD TRANSIT V363 Camião de plataforma/chassis (FED, FFD) 2.2 TDCi 08.2013/12.2018 92KW 125CV 2198CC CYF5 USF6 CY14 CYFG 8566BIF - FORD TRANSIT Camião de plataforma/chassis (FM_, FN_, FF_) 2.2 TDCi 04.2006/08.2014 81KW 110CV 2198CC QVFA 8566AGY 8566AHL 8566AHN 8566AHT 8566AHH - FORD TRANSIT Camião de plataforma/chassis (FM_, FN_, FF_) 2.2 TDCi 10.2008/08.2014 85KW 115CV 2198CC SRFD SRF...</p> <p>158x106x13mm 2p-d14x58mm</p>
	<p><b>C0231</b> NO. 6483712 - 91AB.16C618.AA</p> <p><b>BOTÃO DE AFINAÇÃO DE CAPOT</b></p> <p>FORD TRANSIT (APÓS 1992) - FORD TRANSIT CONNECT (APÓS 2002)</p> <p>d27x44mm</p>		<p><b>C1003</b> NO. 1478341 - 70AB.T302K41.AB - 96VTT032K419AA - 96VTT302K41AA</p> <p><b>BOTÃO DE CAPOT</b></p> <p>FORD TRANSIT T12 - T15</p> <p>36x17x17mm</p>

	<p><b>C1004</b> NO. 1583675 - 81AB16C618AA</p> <p>BOTÃO DE CAPÔT</p> <p>FORD TRANSIT T12 - T15 (APÓS 1991)</p> <p>d30x18mm</p>		<p><b>D0021</b> NO. 4393343 - YC1W4684AA</p> <p>CARDAN TRANSMISSÃO D141X30MM 6 FUROS 12MM ENTRE FUROS 105MM</p> <p>FORD TRANSIT Autocarro (FD_, FB_, FS_, FZ_, FC_) INFORMAÇÕES TIPO ANO DE CONSTRUÇÃO KW HP</p> <p>63x35x30mm 6f-d12mm</p>
	<p><b>D0037</b> NO. 1515117 - 1638947 - 6518778 - 83BG4684BA - 83GB4684BA - 88GG4684BA - GAF41</p> <p>CARDAN TRANSMISSÃO</p> <p>FORD TRANSIT Autocarro (T_) 2.0 Cat (TBS, TCL, TCS) Ano fabric. até: 10.88, (12.85 A 09.92) 78cv 1993cc Autocarro - FORD TRANSIT Caixa (T_) 2.0 (TAL, TAS, TGL, TWS) Ano fabric. até: 10.88, (09.85 A 09.92) 78cv 1994cc Caixa - FORD TRANSIT Caixa (T_) 2.5 D (TAL, TAS, TGL, TWS) (01.86 A 09.91) 68cv 2496cc Caixa - FORD TRANSIT Caixa (T_) 2.5 D (TAL, TAS, TGL, TWS) (10.88 A 09.91) 71cv 2...</p> <p>120x135x40x46mm 6f-12x12mm</p>		<p><b>E0010</b> NO. 6048886 - 6053849 - 6111692 - 6162002 - 81AB5A262CA - 93BB5A262CA</p> <p>ESTICADOR DE ESCAPE</p> <p>FORD TRANSIT (1.6-2.0) 1998-2000 - 65.2006 55-75 1998</p> <p>8566442 8566444 8566446 8566448 8566450 8566452 8566454 8566456 8566458 8566460 8566462 8566464 8566466 8566468 8566470 8566472 8566474 8566476 8566478 8566480 8566482 8566484 8566486 8566488 8566490 8566492 8566494 8566496 8566498 8566500</p> <p>73x47x38mm</p>
	<p><b>E0012</b> NO. 553769 - 6030483 - 69AB5281BA</p> <p>ESTICADOR DE ESCAPE</p> <p>FORD TRANSIT (APÓS 84)</p> <p>d47x42mm</p>		<p><b>E0023</b> NO. 6111691 - 6120254 - 6122002 - 6136012 - 6162002 - 81AB5A262CA - 93BB5A262HA</p> <p>ESTICADOR DE ESCAPE</p> <p>FORD TRANSIT (APÓS 88)</p> <p>92x58x38mm</p>
	<p><b>E0084</b> NO. 1099259 - 1099260 - 1099261 - 3736028 - 3933468 - 4041494 - 4755562 - 6L345495AA - 98VB.5K483.AA...</p> <p>ESTICADOR BARRA ESTABILIZADORA FRENTE ( GASTA 2 UNIDADES )</p> <p>FORD TRANSIT Autocarro (E_) 2.0 (EBL, EBS, ECL, EDS, EDL, EGL, ESS, ESL, EUS) 08.1994/03.2000 84KW 114CV 1998CC NSH NSG NSF 0928288 0928245 0928252 2028375 2028366 0928872 0928878 0928880 0928913 0928924 0928952 0928936 0928940 - FORD TRANSIT Autocarro (E_) 2.0 CNG 06.1994/03.2000 84KW 114CV 1998CC NSH - FORD TRANSIT Autocarro (E_) 2.5 DI (EBL, ECL, EDS, EDL) 07.1994/03.2000 56KW 76CV 2496CC...</p> <p>d31x200mm</p>		<p><b>E0153</b> NO. 4346344 - 4440885 - 4531299 - 4709303 - YC15.5C486.AF - YC155C486AE</p> <p>ESTICADOR DA BARRA ESTABILIZADORA DE TRÁS</p> <p>FORD TRANSIT V184 (APÓS 2001)</p> <p>385x40x42mm 1p-d12-30mm 1f-d12mm</p>
	<p><b>E0156</b> NO. 1669212 - V92VB5C486AA</p> <p>ESTICADOR DA BARRA ESTABILIZADORA DE TRÁS</p> <p>FORD TRANSIT (1998 A 2000)</p> <p>250x42x40mm 2p-d12-33mm</p>		<p><b>E0258</b> NO. 1513343 - 1745924 - 1790310 - 1905043 - 8V51.3B438.BA - 8V51.3B438.BB - 8V51.3B438.AB - D65134170</p> <p>ESTICADOR BARRA ESTABILIZADORA FRENTE ( GASTA 2 UNIDADES )</p> <p>FORD TRANSIT COURIER B460 Kombi: 1.0 EcoBoost 02.2014/»» 74KW 100CV 998CC - FORD TRANSIT COURIER B460 Kombi: 1.5 TDCi 02.2014/»» 55KW 75CV 1499CC - FORD TRANSIT COURIER B460 Kombi: 1.5 TDCi 05.2015/»» 70KW 95CV 1499CC - FORD TRANSIT COURIER B460 Kombi: 1.6 TDCi 02.2014/»» 70KW 95CV 1560CC - FORD TRANSIT COURIER B460 Caixa: 1.0 EcoBoost 02.2014/»» 74KW 100CV 998CC - FORD TRANSIT COURIER B460 C...</p> <p>290x36x35mm 2p-d10x25mm</p>
	<p><b>E0261</b> NO. 1495685 - 1763714 - 2033148 - 3C113B438AC - 3C113B438AD - 4519467 - BK21.3B438.AA - BK21.3B438.AB</p> <p>ESTICADOR BARRA ESTABILIZADORA FRENTE ( GASTA 2 UNIDADES )</p> <p>FORD TRANSIT Autocarro (FD_, FB_, FS_, FZ_, FC_) 2.0 DI (F_E_, F_F_, F_G_) 08.2000/05.2006 55KW 75CV 1998CC D3FA 8566442 8566444 8566446 8566448 8566450 8566452 8566454 - FORD TRANSIT Autocarro (FD_, FB_, FS_, FZ_, FC_) 2.0 DI (F_E_, F_F_, F_G_) 08.2000/05.2006 63KW 86CV 1998CC F3FA 8566465 8566466 8566467 8566468 8566472 8566474 8566473 8566476 - FORD TRANSIT Autocarro (FD_ ...)</p> <p>330x40x42mm 2p-d12x30mm</p>		<p><b>E0624-M</b> NO. 1835635</p> <p>ESTICADOR SUPORTE APOIO MOTOR TRAS</p> <p>FORD TRANSIT COURIER B460 Caixa/monovolume 1.5 EcoBlue 04.2018/12.2023 74KW 100CV 1499CC XXCC XXCA XXCB XVCE XVCF 8566BQD - FORD TRANSIT COURIER B460 Caixa/monovolume 1.5 TDCi 02.2014/12.2023 55KW 75CV 1499CC XUCC XUCD UGCA UGCB XWCA XWCB XUCC XUCG XUCF 8566BIK - FORD TRANSIT COURIER B460 Caixa/monovolume 1.5 TDCi 05.2015/12.2023 70KW 95CV 1499CC XVCD XVCC XVCB XVCA 8566BLM - FORD TRANSIT COURIER ...</p> <p>153x94x82mm 1f-d10mm 3f-d11mm</p>
	<p><b>E0625-M</b> NO. 1771506 - 1786184 - 2015369 - BK216P082AC - BK216P082AD - BK216P082AE</p> <p>ESTICADOR SUPORTE APOIO MOTOR TRAS</p> <p>FORD TRANSIT V363 Autocarro (FAD, FBD): 2.2 TDCi 08.2013/03.2016 74KW 100CV 2198CC - FORD TRANSIT V363 Autocarro (FAD, FBD): 2.2 TDCi 08.2013/03.2016 92KW 125CV - 2198CC - FORD TRANSIT V363 Autocarro (FAD, FBD): 2.2 TDCi 12.2014/03.2016 114KW 155CV 2198CC - FORD TRANSIT V363 Caixa (FCD, FDD): 2.2 TDCi 08.2013/03.2016 74KW 100CV 2198CC - FORD TRANSIT V363 Caixa (FCD, FDD): 2.2 TDCi 08.2013/03.2016 ...</p> <p>390x132x42mm 1f-d14mm 1f-d14mm</p>		<p><b>E1028</b> NO. 1307877 - 7092700 - 95VB.5A262.BA</p> <p>ESTICADOR SUPORTE DE ESCAPE</p> <p>FORD TRANSIT Autocarro (E_) 2.0 (EBL, EBS, ECL, EDS, EDL, EGL, ESS, ESL, EUS) 08.1994/03.2000 84KW 114CV 1998CC NSH NSG NSF 0928288 0928245 0928252 2028375 2028366 0928872 0928878 0928880 0928913 0928924 0928952 0928936 0928940 - FORD TRANSIT Autocarro (E_) 2.0 CNG 06.1994/03.2000 84KW 114CV 1998CC NSH - FORD TRANSIT Autocarro (E_) 2.5 DI (EBL, ECL, EDS, EDL) 07.1994/03.2000 56KW 76CV 2496CC...</p> <p>82x75x25mm 3f-d10mm</p>
	<p><b>E1063</b> NO. 6866412 - 7127234 - 95VB5A262CA</p> <p>ESTICADOR DE ESCAPE DO MEIO</p> <p>FORD TRANSIT M12 - M15 TUO - T12 TURBO - T15 TURBO</p> <p>77x62x24mm 2f-d10mm</p>		<p><b>E1087</b> NO. 1022729</p> <p>ESTICADOR DO ESCAPE</p> <p>FORD TRANSIT (APÓS 2002)</p> <p>70x50x25mm</p>

	<p><b>F0885-I</b> NO. 6156467 - 6160070 - 86VB.3K661.A1C - 86VB.3K661.AC</p> <p>FOLE DA DIRECÇÃO DIREITO E ESQUERDO</p> <p>FORD TRANSIT 2.4D - 2.5D - 2.5Di - 2.5 TD (1976 A 200)</p> <p>d63x190mm 1f-d50mm 1f-d15mm</p>		<p><b>F0885-T</b> NO. 6156467 - 6160070 - 86VB.3K661.A1C - 86VB.3K661.AC</p> <p>FOLE DA DIRECÇÃO DIREITO E ESQUERDO (TERMOPLÁSTICO)</p> <p>FORD TRANSIT 2.4D - 2.5D - 2.5Di - 2.5 TD (1976 A 200)</p> <p>d66x195mm d56mm 1f-d50mm 1f-d16mm</p>
	<p><b>F1027</b> NO. 0440888 - 1649554 - 83BG.4846.AA</p> <p>FOLE APOIO SUPORTE REPARAÇÃO TRANSMISSÃO</p> <p>FORD TRANSIT Autocarro (T_) 1.6 (TBL, TES) 12.1985/01.1989 46KW 63CV 1593CC - FORD TRANSIT Autocarro (T_) 2.0 (TBS, TCL, TCS, TEL, TES) 11.1985/09.1992 57KW 78CV 1994CC - FORD TRANSIT Autocarro (T_) 2.0 Cat (TBS, TCL, TCS) 12.1985/09.1992 57KW 78CV 1993CC - FORD TRANSIT Autocarro (T_) 2.5 D (TBS, TCL, TCS, TEL, TES) 12.1985/01.1989 50KW 68CV 2496CC - FORD TRANSIT Autocarro (T_) 2.5 ...</p> <p>d94x62mm 1f-d54mm</p>		<p><b>F1033</b> NO. 78VB7277</p> <p>FOLE ALAVANCA VELOCIDADES</p> <p>FORD TRANSIT</p> <p>205x140x40 1f-d14mm</p>
	<p><b>F1649-I</b> NO. 1012814 - 3043575 - 7138554 - 94FB3K661AC</p> <p>FOLE DA DIRECÇÃO ASSISTIDA LADO DIREITO E ESQUERDO</p> <p>FORD TRANSIT Autocarro (FD_, FB_, FS_, FZ_, FC_) 2.0 DI (F_E_, F_F_, F_G_) 08.2000/05.2006 55KW 75CV 1998CC - FORD TRANSIT Autocarro (FD_, FB_, FS_, FZ_, FC_) 2.0 DI (F_E_, F_F_, F_G_) 08.2000/05.2006 63KW 86CV 1998CC - FORD TRANSIT Autocarro (FD_, FB_, FS_, FZ_, FC_) 2.0 DI (F_E_, F_F_, F_G_) 08.2000/05.2006 74KW 100CV 1998CC - FORD TRANSIT Autocarro (FD_, FB_...</p> <p>d70x190mm 1f-d55mm 1f-d12mm</p>		<p><b>F1652-T</b> NO. 1763990</p> <p>FOLE DA DIRECÇÃO LADO DIREITO E ESQUERDO</p> <p>FORD TRANSIT V363 Autocarro (FAD, FBD) 2.0 EcoBlue (De 03.2016 -) 77kW 105cv 1995cm3 Autocarro - FORD TRANSIT V363 Autocarro (FAD, FBD) 2.0 EcoBlue (De 03.2016 -) 96kW 130cv 1995cm3 Autocarro - FORD TRANSIT V363 Autocarro (FAD, FBD) 2.0 EcoBlue (De 03.2016 -) 125kW 170cv 1995cm3 Autocarro - FORD TRANSIT V363 Autocarro (FAD, FBD) 2.2 TDCi (De 08.2013 -) 74kW 100cv 2198cm3 Autocarro - FORD TRANSIT V...</p> <p>d58x180mm 1f-d16mm 1f-d50mm</p>
	<p><b>F1854-I</b> NO. 36020096A - 4059922 - 4568245 - X1248A01 - YC153K661BA</p> <p>FOLE DA DIRECÇÃO LADO DIREITO E ESQUERDO</p> <p>FORD TRANSIT 2.0 Di - 2.0 TDCi - 2.0i - 2.5 Di - 2.5 TD - 2.5 TDi (1991 A 2000)</p> <p>d80x280mm 1f-d55mm 1f-d15mm</p>		<p><b>F1904H-I</b> NO. 1871102</p> <p>FOLE DA DIRECÇÃO LADO DIREITO E ESQUERDO</p> <p>FORD TRANSIT COURIER B460 Caixa 1.0 EcoBoost (De 02.2014 -) 74kW 100cv 998cm3 Caixa - FORD TRANSIT COURIER B460 Caixa 1.5 TDCi (De 02.2014 -) 55kW 75cv 1499cm3 Caixa - FORD TRANSIT COURIER B460 Caixa 1.5 TDCi (De 05.2015 -) 70kW 95cv 1499cm3 Caixa - FORD TRANSIT COURIER B460 Caixa 1.6 TDCi (De 02.2014 -) 70kW 95cv 1560cm3 Caixa - FORD TRANSIT COURIER B460 Kombi 1.0 EcoBoost (De 02.2014 -) 74kW 10...</p> <p>d63x186mm 1f-d12mm 1f-d55mm</p>
	<p><b>F4014</b> NO. 6172863 - 88VB7277BA - 88VB7277VA - CN1C157277AA</p> <p>FOLE ALAVANCA VELOCIDADES</p> <p>FORD TRANSIT Autocarro (T_) 1.6 (TBL, TES) 12.1985/01.1989 46KW 63CV 1593CC LAT 0928607, 0928616 - FORD TRANSIT Autocarro (T_) 2.0 (TBS, TCL, TCS, TEL, TES) 11.1985/09.1992 57KW 78CV 1994CC NAT NAV 0928639, 0928608, 0928617, 0928776, 0928164, 0928166 - FORD TRANSIT Autocarro (T_) 2.0 Cat (TBS, TCL, TCS) 12.1985/09.1992 57KW 78CV 1993CC N6T 0928617, 0928776, 0928164, 0928166 - FORD TRANSIT Au...</p> <p>180X150X140mm 1f-d18mm</p>		<p><b>F4015</b> NO. 1078279 - 95VB7F179AB</p> <p>FOLE ALAVANCA TRAVÃO DE MÃO</p> <p>FORD TRANSIT Autocarro (T_) 1.6 (TBL, TES) 12.1985/01.1989 46KW 63CV 1593CC LAT 0928607, 0928616 - FORD TRANSIT Autocarro (T_) 2.0 (TBS, TCL, TCS, TEL, TES) 11.1985/09.1992 57KW 78CV 1994CC NAT NAV 0928639, 0928608, 0928617, 0928776, 0928164, 0928166 - FORD TRANSIT Autocarro (T_) 2.0 Cat (TBS, TCL, TCS) 12.1985/09.1992 57KW 78CV 1993CC N6T 0928617, 0928776, 0928164, 0928166 - FORD TRANSIT Au...</p> <p>185x85x65mm 1f-d15mm</p>
	<p><b>F4016</b> NO. 0620799 - 11620799 - 1646081 - 70VB-7K148 - 70VB-7K148.AA</p> <p>FOLE ALAVANCA VELOCIDADES ( PARTE DE BAIXO DO SECTOR VELOCIDADES )</p> <p>FORD TRANSIT Autocarro (T_) 1.6 (TBL, TES) 12.1985/01.1989 46KW 63CV 1593CC LAT 0928607, 0928616 - FORD TRANSIT Autocarro (T_) 2.0 (TBS, TCL, TCS, TEL, TES) 11.1985/09.1992 57KW 78CV 1994CC NAT NAV 0928639, 0928608, 0928617, 0928776, 0928164, 0928166 - FORD TRANSIT Autocarro (T_) 2.0 Cat (TBS, TCL, TCS) 12.1985/09.1992 57KW 78CV 1993CC N6T 0928617, 0928776, 0928164, 0928166 - FORD TRANSIT Au...</p> <p>d82x55mm 1f-d70mm 1f-d14mm</p>		<p><b>F4020</b> NO. 6203262 - 6869950 - 92VB.3K661.BA - 92VB3K661AA</p> <p>FOLE DIRECÇÃO ( GASTA 2 UNIDADES )</p> <p>FORD TRANSIT Autocarro (V_) 1.6 (VAS, VLS, VZS) 12.1977/10.1986 48KW 65CV 1593CC - FORD TRANSIT Autocarro (V_) 2.0 (VAS, VBLVIL, VLS, VUL, VZS) 12.1977/07.1982 43KW 59CV 1993CC - FORD TRANSIT Autocarro (V_) 2.0 (VAS, VLS, VZS) 11.1977/10.1986 55KW 75CV 1993CC - FORD TRANSIT Autocarro (V_) 2.0 (VAS, VIL, VLS, VUL, VZS) 11.1977/10.1986 57KW 78CV 1993CC - FORD TRANSIT Autocarro (V_) 2....</p> <p>d66x210mm d56mm 1f-d60mm 1f-d15mm</p>
	<p><b>F4020-T</b> NO. 6203262 - 6869950 - 92VB.3K661.AA - 92VB3K661BA</p> <p>FOLE DIRECÇÃO TERMOPLÁSTICO ( GASTA 2 UNIDADES )</p> <p>FORD TRANSIT Autocarro (V_) 1.6 (VAS, VLS, VZS) 12.1977/10.1986 48KW 65CV 1593CC - FORD TRANSIT Autocarro (V_) 2.0 (VAS, VBLVIL, VLS, VUL, VZS) 12.1977/07.1982 43KW 59CV 1993CC - FORD TRANSIT Autocarro (V_) 2.0 (VAS, VLS, VZS) 11.1977/10.1986 55KW 75CV 1993CC - FORD TRANSIT Autocarro (V_) 2.0 (VAS, VIL, VLS, VUL, VZS) 11.1977/10.1986 57KW 78CV 1993CC - FORD TRANSIT Autocarro (V_) 2....</p> <p>d66x210mm d56mm 1f-d60mm 1f-d15mm</p>		<p><b>F4037</b> NO. YC153K661BA - 4059922 - 4602027 - YC153K661BB</p> <p>FOLE DIRECÇÃO ( GASTA 2 UNIDADES )</p> <p>FORD TRANSIT 2.0 TDCi - 2.0 Di (APÓS 2000)</p> <p>d72/54x240mm 1f-d68mm 1f-d10mm</p>
	<p><b>F4039</b> NO. 4059921 - 4602026 - YC153K661AA - YC153K661AB</p> <p>FOLE DIRECÇÃO ( GASTA 2 UNIDADES )</p> <p>FORD TRÁNSIT 2.0i (1991 A 1994) - 2.0i - 2.5 Tdi - 2.5 Di - 2.5 TD (1994 A 2000) - 2.0 Di - 2.0 TDCi (APÓS 2000)+F254</p> <p>d65/54x180mm 1f-d67mm 1f-d15mm</p>		<p><b>F4078</b> NO. 1786355 - 211E7277</p> <p>FOLE ALAVANCA VELOCIDADES</p> <p>FORD TRANSIT Autocarro (E_) 2.5 Di (EBS, EDS, EDL, ESS, EUS) 08.1991/07.1994 51KW 70CV 2496CC 4BC 4FA 4CC 0928794 0928797 0928801 0928790 2028347 0928847 - FORD TRANSIT Autocarro (E_) 2.5 Di (EBS, EDS, EGL, ESS, EUS) 09.1991/07.1994 59KW 80CV 2496CC 4DA 0928795 0928798 0928802 0928791 2028348 0928848 0928201 - FORD TRANSIT Autocarro (E_) 2.5 TD (EBS, EBL, ECL, EDS, EDL, ESS, EUS) 10.1992/07....</p> <p>130x50mm 1f-d10mm</p>











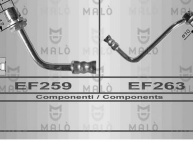
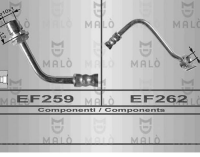
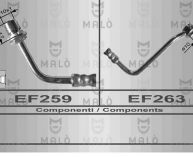

	<p><b>F4157</b> NO. 1440749 - 2T14-V045B78-AFN2E6 - 5121644</p> <p><b>FOLE ALAVANCA VELOCIDADES C/ ARO PRETO</b></p> <p>Ford Transit Connect 2013 Diesel Van 1.8 Di FWD P65_ P70_ P80_ 1753CC 55KW 75HP BHPA;P7PA;P7PB;R2PA - Ford Transit Connect 2013 Diesel Van 1.8 TDCi FWD P65_ P70_ P80_ 1753CC 66KW 90HP HCPA;HCPB;HCPD;HCPD;P9PA;P9PB;P9PC;P9PD;R3PA;RWPE;RWP F - Ford Transit Connect 2013 Diesel Van 1.8 TDCi FWD P65_ P70_ P80_ 1753CC 81KW 110HP RWPA;RWPB;RWPC;RWPD - Ford Transit Connect 2013 Petrol/Liquified Petroleum G...</p> <p>270x181x212mm 1f-d15mm 1f-133x105mm</p>		<p><b>F4236</b> NO. 1223834 - 1305329</p> <p><b>FOLE CAPA PROTEÇÃO AMORTECEDOR FRENTE ( GASTA 2 UNIDADES )</b></p> <p>FORD TRANSIT CONNECT V408 Caixa/monovolume: 1.0 EcoBoost 02.2013/&gt;&gt;&gt; 74KW 100CV 998CC - FORD TRANSIT CONNECT V408 Caixa/monovolume: 1.6 EcoBoost 11.2013/&gt;&gt;&gt; 110KW 150CV 1596CC - FORD TRANSIT CONNECT V408 Caixa/monovolume: 1.5 TDCi 08.2015/&gt;&gt;&gt; 55KW 75CV 1499CC - FORD TRANSIT CONNECT V408 Caixa/monovolume: 1.5 EcoBlue 05.2018/&gt;&gt;&gt; 55KW 75CV 1499CC - FORD TRANSIT CONNECT V408 Caixa/monovolume: 1.5 TDC...</p> <p>d79x241mm 1f-d61mm 1f-d64mm</p>
	<p><b>F4236</b> NO. 1223834 - 1305329</p> <p><b>FOLE CAPA PROTEÇÃO AMORTECEDOR FRENTE ( GASTA 2 UNIDADES )</b></p> <p>FORD TRANSIT COURIER B460 Veículo multiuso: 1.0 EcoBoost 02.2014/&gt;&gt;&gt; 74KW 100CV 998CC - FORD TRANSIT COURIER B460 Veículo multiuso: 1.5 TDCi 02.2014/&gt;&gt;&gt; 55KW 75CV 1499CC - FORD TRANSIT COURIER B460 Veículo multiuso: 1.5 TDCi 05.2015/&gt;&gt;&gt; 70KW 95CV 1499CC - FORD TRANSIT COURIER B460 Veículo multiuso: 1.5 EcoBlue 04.2018/&gt;&gt;&gt; 74KW 100CV 1499CC - FORD TRANSIT COURIER B460 Veículo multiuso: 1.6 TDCi 02....</p> <p>d79x241mm 1f-d61mm 1f-d64mm</p>		<p><b>F4266</b> NO. 1729479</p> <p><b>FOLE ALAVANCA VELOCIDADES</b></p> <p>FORD TRANSIT Autocarro (FD_ _ FB_ _ FS_ _ FZ_ _ FC_ _ ) 2.2 TDCi (De 04.2006 Até 08.2014) 63kW 85cv 2198cm3 Autocarro - FORD TRANSIT Autocarro (FD_ _ FB_ _ FS_ _ FZ_ _ FC_ _ ) 2.2 TDCi (De 10.2011 Até 08.2014) 74kW 100cv 2198cm3 Autocarro - FORD TRANSIT Autocarro (FD_ _ FB_ _ FS_ _ FZ_ _ FC_ _ ) 2.2 TDCi (De 04.2006 Até 08.2014) 81kW 110cv 2198cm3 Autocarro - FORD TRANSIT Autocarro (FD_ _ ...</p> <p>151x141x138mm 1f-117x118mm</p>
	<p><b>F4372</b> NO. 6C1R7C453ND - 1778122 - 1417417 - 1417410 - 1417449</p> <p><b>FOLE DA ALAVANCA VELOCIDADES C/MANETE PUNHO TOPO COMPLETO 6 VELOCIDADES</b></p> <p>FORD TRANSIT Autocarro (FD_ _ FB_ _ FS_ _ FZ_ _ FC_ _ ) 2.2 TDCi (04.2006 - 08.2014) 63kw 85cv 2198cm3 Autocarro FORD TRANSIT Autocarro (FD_ _ FB_ _ FS_ _ FZ_ _ FC_ _ ) 2.2 TDCi (10.2011 - 08.2014) 74kw 100cv 2198cm3 Autocarro FORD TRANSIT Autocarro (FD_ _ FB_ _ FS_ _ FZ_ _ FC_ _ ) 2.2 TDCi (04.2006 - 08.2014) 81kw 110cv 2198cm3 Autocarro FORD TRANSIT Autocarro (FD_ _ FB_ _ FS_ _ FZ_ _ ...</p> <p>445x155x150mm xxx</p>		<p><b>F4372</b> NO. 6C1R7C453ND - 1778122 - 1417417 - 1417410 - 1417449</p> <p><b>FOLE DA ALAVANCA VELOCIDADES C/MANETE PUNHO TOPO COMPLETO 6 VELOCIDADES</b></p> <p>FORD TRANSIT CONNECT V408 Caixa/monovolume 1.0 EcoBoost (02.2013 - ) 74kw 100cv 998cm3 Caixa/monovolume FORD TRANSIT CONNECT V408 Caixa/monovolume 1.6 EcoBoost (11.2013 - ) 110kw 150cv 1596cm3 Caixa/monovolume FORD TRANSIT CONNECT V408 Caixa/monovolume 1.6 TDCi (02.2013 - ) 55kw 75cv 1560cm3 Caixa/monovolume FORD TRANSIT CONNECT V408 Caixa/monovolume 1.6 TDCi (02.2013 - ) 70kw 95cv 1560cm3 Caixa/monov...</p> <p>445x155x150mm xxx</p>
	<p><b>F4372</b> NO. 6C1R7C453ND - 1778122 - 1417417 - 1417410 - 1417449</p> <p><b>FOLE DA ALAVANCA VELOCIDADES C/MANETE PUNHO TOPO COMPLETO 6 VELOCIDADES</b></p> <p>FORD TRANSIT COURIER B460 Caixa/monovolume 1.0 EcoBoost (02.2014 -12.2023) 74kw 100cv 998cm3 Caixa/monovolume FORD TRANSIT COURIER B460 Caixa/monovolume 1.5 EcoBlue (04.2018 -12.2023) 74kw 100cv 1499cm3 Caixa/monovolume FORD TRANSIT COURIER B460 Caixa/monovolume 1.5 TDCi (02.2014 -12.2023) 55kw 75cv 1499cm3 Caixa/monovolume FORD TRANSIT COURIER B460 Caixa/monovolume 1.5 TDCi (05.2015 -12.2023) 70k...</p> <p>445x155x150mm xxx</p>		<p><b>H118</b> NO.</p> <p><b>PALA ORIGINAL FRENTE</b></p> <p>FORD TRANSIT</p> <p>450x430mm</p>
	<p><b>H119</b> NO.</p> <p><b>PALA ORIGINAL TRÁS</b></p> <p>FORD TRANSIT</p> <p>500x250mm</p>		<p><b>H773</b> NO. 2T1428344AA</p> <p><b>PALAS GUARDA-LAMAS TRÁS</b></p> <p>FORD TRANSIT CONNECT (P65_ P70_ P80_ ) 1.8 16V (De 2002.06 Até 2013.12) 85kW 116cv 1796cm3 Caixa - FORD TRANSIT CONNECT (P65_ P70_ P80_ ) 1.8 Di (De 2002.06 Até 2013.12) 55kW 75cv 1753cm3 Caixa - FORD TRANSIT CONNECT (P65_ P70_ P80_ ) 1.8 TDCi (De 2002.06 Até 2013.12) 66kW 90cv 1753cm3 Caixa -</p> <p>295x188x42mm 1f-d13mm</p>
	<p><b>H775</b> NO. 2T1416A562AA</p> <p><b>PALAS GUARDA-LAMAS DA FRENTE</b></p> <p>FORD TRANSIT CONNECT (P65_ P70_ P80_ ) 1.8 16V (De 2002.06 Até 2013.12) 85kW 116cv 1796cm3 Caixa - FORD TRANSIT CONNECT (P65_ P70_ P80_ ) 1.8 Di (De 2002.06 Até 2013.12) 55kW 75cv 1753cm3 Caixa - FORD TRANSIT CONNECT (P65_ P70_ P80_ ) 1.8 TDCi (De 2002.06 Até 2013.12) 66kW 90cv 1753cm3 Caixa -</p> <p>290x185x46mm 1f-d12mm</p>		<p><b>KF9011</b> NO. 1603232 - 1603278 - 2T144A084AA - 2T144A084BA - 4371800 - 4371801 - 4410860</p> <p><b>KIT DE FOLE DO CARDAN JUNTO À RODA E CAIXA</b></p> <p>FORD TRANSIT CONNECT (P65_ P70_ P80_ ) 1.8 16V 06.2002/12.2013 85KW 116CV 1796CC EYPD EYPC EYPA 8566098 8566101 8566AEA 8566AED - FORD TRANSIT CONNECT (P65_ P70_ P80_ ) 1.8 Di 06.2002/12.2013 55KW 75CV 1753CC R2PA P7PB P7PA BHPA 8566099 8566102 8566ADZ 8566AEC 8566ASI 8566ASO - FORD TRANSIT CONNECT (P65_ P70_ P80_ ) 1.8 TDCi 06.2002/12.2013 66KW 90CV 1753CC HCPD HCPD RWPF RWPE P9PD R3PA P9PC P9...</p> <p>d102x125mm d92x85mm 1f-d92mm 1f-d25mm 1fd82mm 1f-d25mm</p>
	<p><b>KF9012</b> NO. 2T14.4A084.AA - 2T144A084DA - 4371804</p> <p><b>KIT DE FOLE DO CARDAN JUNTO À CAIXA</b></p> <p>FORD TRANSIT CONNECT 1.8Di (APÓS 2002)</p> <p>d93x85mm 1f-d86mm 1f-d21mm</p>		<p><b>KF9024</b> NO. 2T144A084AA - 4371803 - 4371804</p> <p><b>KIT DE FOLE TRANSMISSÃO JUNTO CAIXA</b></p> <p>FORD TRANSIT CONNECT (P65_ P70_ P80_ ) 1.8 Di (06.02 - 12.13) 75cv 1753cc Caixa - FORD TRANSIT CONNECT (P65_ P70_ P80_ ) 1.8 TDCi (06.02 - 12.13) 90cv 1753cc Caixa</p> <p>d90x90mm 1f-d22mm 1f-d80mm</p>
	<p><b>KF9037</b> NO. 1514345 - 1426856 - 1534276 - 1595106 - 1727141 - 1727147 - 1774394 - 1787355 - 1794505 - CC11-4C06...</p> <p><b>KIT DE FOLE TRANSMISSÃO LADO DA RODA</b></p> <p>FORD TRANSIT CONNECT V408 Caixa/monovolume 1.0 EcoBoost (De 02.2013 - ) 74kW 100cv 998cm3 Caixa/monovolume -</p> <p>d118x136mm 1f-d109mm 1f-d29mm</p>		<p><b>KF9037</b> NO. 1514345 - 1426856 - 1534276 - 1595106 - 1727141 - 1727147 - 1774394 - 1787355 - 1794505 - CC11-4C06...</p> <p><b>KIT DE FOLE TRANSMISSÃO LADO DA RODA</b></p> <p>FORD TRANSIT COURIER B460 Caixa/monovolume 1.0 EcoBoost (De 02.2014 - ) 74kW 100cv 998cm3 Caixa/monovolume - FORD TRANSIT COURIER B460 Veículo multiuso 1.0 EcoBoost (De 02.2014 - ) 74kW 100cv 998cm3 Veículo multiuso -</p> <p>d118x136mm 1f-d109mm 1f-d29mm</p>

	<p><b>KF9037</b> NO. 1514345 - 1426856 - 1534276 - 1595106 - 1727141 - 1727147 - 1774394 - 1787355 - 1794505 - CC11-4C06...</p> <p><b>KIT DE FOLE TRANSMISSÃO LADO DA RODA</b></p> <p>FORD TRANSIT Caixa (FA_) 2.2 TDCi (De 04.2006 Até 08.2014) 81kW 110cv 2198cm3 Caixa - FORD TRANSIT Caixa (FA_) 2.2 TDCi (De 10.2011 Até 08.2014) 92kW 125cv 2198cm3 Caixa - FORD TRANSIT Camião de plataforma/chassis (FM_, FN_, FF_) 2.2 TDCi (De 04.2006 Até 08.2014) 81kW 110cv 2198cm3 Camião de plataforma/chassis - FORD TRANSIT Camião de plataforma/chassis (FM_, FN_, FF_) 2.2 TDCi (D...</p> <p>d118x136mm 1f-d109mm 1f-d29mm</p>		<p><b>KF9039</b> NO. 1774393 - 1787348 - 1787353 - BK21-4A084-AB - BK21-4C062-AB</p> <p><b>KIT DE FOLE TRANSMISSÃO JUNTO À CAIXA</b></p> <p>FORD TRANSIT CONNECT V408 Caixa/monovolume 1.0 EcoBoost (De 02.2013 -) 74kW 100cv 998cm3 Caixa/monovolume -</p> <p>d102x107mm 1f-d91mm 1f-d32mm</p>
	<p><b>KF9039</b> NO. 1774393 - 1787348 - 1787353 - BK21-4A084-AB - BK21-4C062-AB</p> <p><b>KIT DE FOLE TRANSMISSÃO JUNTO À CAIXA</b></p> <p>FORD TRANSIT COURIER B460 Caixa/monovolume 1.0 EcoBoost (De 02.2014 -) 74kW 100cv 998cm3 Caixa/monovolume - FORD TRANSIT COURIER B460 Veículo multiuso 1.0 EcoBoost (De 02.2014 -) 74kW 100cv 998cm3 Veículo multiuso -</p> <p>d102x107mm 1f-d91mm 1f-d32mm</p>		<p><b>KF9078H-I</b> NO. 1514345 - 1514347</p> <p><b>KIT FOLE TRANSMISSÃO JUNTO À CAIXA</b></p> <p>FORD TRANSIT Autocarro 2.2 TDCi (De 2006.04 Até 2014.08) 63kW 85cv 2198cm3 Autocarro - FORD TRANSIT Autocarro 2.2 TDCi (De 2006.04 Até 2014.08) 81kW 110cv 2198cm3 Autocarro - FORD TRANSIT Autocarro 2.2 TDCi (De 2008.10 Até 2014.08) 85kW 115cv 2198cm3 Autocarro - FORD TRANSIT Autocarro 2.2 TDCi (De 2006.04 Até 2014.08) 96kW 130cv 2198cm3 Autocarro - FORD TRANSIT Autocarro 2.2 TD...</p> <p>d104x95mm 1f-d92mm 1f-d28mm</p>
	<p><b>KF9078H-I</b> NO. 1514345 - 1514347</p> <p><b>KIT FOLE TRANSMISSÃO JUNTO À CAIXA</b></p> <p>FORD TRANSIT Autocarro 2.2 TDCi (De 2006.04 Até 2014.08) 63kW 85cv 2198cm3 Autocarro - FORD TRANSIT Autocarro 2.2 TDCi (De 2006.04 Até 2014.08) 81kW 110cv 2198cm3 Autocarro - FORD TRANSIT Autocarro 2.2 TDCi (De 2008.10 Até 2014.08) 85kW 115cv 2198cm3 Autocarro - FORD TRANSIT Autocarro 2.2 TDCi (De 2006.04 Até 2014.08) 96kW 130cv 2198cm3 Autocarro - FORD TRANSIT Autocarro 2.2 TD...</p> <p>d104x95mm 1f-d92mm 1f-d28mm</p>		<p><b>KL1094-I</b> NO. 6108031 - 6183028 - 6183031 - 88VB7L609AA</p> <p><b>KIT DO PEDAL DA EMBRAIAGEM</b></p> <p>FORD TRANSIT 2.4D (1977 A 1986) - 2.5D (1983 A 1992) - 2.5TD (1992 A 1944) - 2.5 Di (1991 A 2000)</p> <p>119x70x17mm</p>
	<p><b>KL1097-I</b> NO. 1030879 - 95VB7L583AB</p> <p><b>CATRACA DA EMBRAIAGEM</b></p> <p>FORD TRANSIT Autocarro (V_) 1.6 (VAS, VLS, VZS) (12.77 A 10.86) 65cv 1593cc Autocarro - FORD TRANSIT Autocarro (V_) 2.0 (VAS, VBLVIL, VLS, VUL, VZS) (12.77 A 07.82) 59cv 1993cc Autocarro - FORD TRANSIT Autocarro (V_) 2.0 (VAS, VLS, VZS) (11.77 A 10.86) 75cv 1993cc Autocarro - FORD TRANSIT Autocarro (V_) 2.0 (VAS, VIL, VLS, VUL, VZS) (11.77 A 10.86) 78cv 1993cc Autocarro - FORD TRANSIT Auto...</p> <p>120x85x46mm 1f-d27mm</p>		<p><b>L0016</b> NO. 1499259 - 70VB18174DA - 9-51631-014-0</p> <p><b>CASQUILHO AMORTECEDOR CONICO</b></p> <p>FORD TRANSIT Autocarro (T_) 1.6 (TBL, TES) 12.1985/01.1989 46KW 63CV 1593CC LAT 0928607 0928616 - FORD TRANSIT Autocarro (T_) 2.0 (TBS, TCL, TCS, TEL, TES) 11.1985/09.1992 57KW 78CV 1994CC NAT NAV 0928639 0928608 0928617 0928776 0928164 0928166 - FORD TRANSIT Autocarro (T_) 2.0 Cat (TBS, TCL, TCS) 12.1985/09.1992 57KW 78CV 1993CC N6T 0928617 0928776 0928164 0928166 - FORD TRANSIT Autocarro (...)</p> <p>d36x22mm d32mm 1f-d20mm</p>
	<p><b>L0246</b> NO. 1521097 - 84VB5719AA</p> <p><b>CASQUILHO DE MOLA</b></p> <p>FORD TRANSIT (ATÉ 1982)</p> <p>d33x43mm d27mm 1f-d16mm</p>		<p><b>L1019</b> NO. 1499260 - 70VB.18174.CA - 70VB18174DA</p> <p><b>CASQUILHO AMORTECEDOR DUPLO CONICO ( GASTA 8 UNIDADES )</b></p> <p>FORD TRANSIT Autocarro (T_) 1.6 (TBL, TES) 12.1985/01.1989 46KW 63CV 1593CC LAT 0928607 0928616 - FORD TRANSIT Autocarro (T_) 2.5 D 12.1985/01.1989 60KW 82CV 2496CC 4AE - FORD TRANSIT Autocarro (T_) 2.5 D (TBS, TCL, TCS, TEL, TES) 12.1985/01.1989 50KW 68CV 2496CC 4AB 0928640 0928609 0928618 0928165 0928167 - FORD TRANSIT Camião de plataforma/chassis (T_) 2.5 D (TTL, TTS, TUL, TUS, TTE) 01....</p> <p>d37x31mm 1f-D 16mm</p>
	<p><b>L1045</b> NO. 1631072 - 1631788 - 84VB.5719.AA</p> <p><b>CASQUILHO DE MOLAS</b></p> <p>FORD TRANSIT (APÓS 1982)</p> <p>d35x41mm d27mm 1f-d12mm</p>		<p><b>L3023</b> NO. 1575214 - 78VB5A546 - 78VB5A546AA</p> <p><b>CASQUILHO DAS MOLAS DE TRÁS PARTE DE TRÁS SUPERIOR</b></p> <p>FORD TRANSIT Autocarro (E_) 2.0 09.1991/09.1994 66KW 90CV 1993CC NBA - FORD TRANSIT Autocarro (E_) 2.0 i (EBL, EDL, EGL, ESS, EUS) 09.1991/07.1994 72KW 98CV 1994CC NCA 0928793 0928796 0928800 0928789 2028346 0928846 0928200 - FORD TRANSIT Autocarro (E_) 2.5 DI (EBS, EDS, EDL, ESS, EUS) 08.1991/07.1994 51KW 70CV 2496CC 4BC 4FA 4CC 0928794 0928797 0928801 0928790 2028347 0928847 - FORD TRANSIT...</p> <p>d45x43mm d42/37mm 1f-d16mm</p>
	<p><b>L3081</b> NO. 1631619 - 86VB5K498AA</p> <p><b>CASQUILHO DA BARRA ESTABILIZADORA</b></p> <p>FORD TRANSIT TURBO APÓS 1998</p> <p>d27x31mm d17mm 1f-d10mm</p>		<p><b>M6037</b> NO. 1565558 - 6065962 - 6115136 - 6134622 - 6134623 - 6615275 - 81AB9451AA</p> <p><b>JUNTA DE ESCAPE</b></p> <p>FORD TRANSIT (1991 A 1994)</p> <p>107x80mm 2f-d42mm</p>
	<p><b>M6057</b> NO. 6692784 - 6797187 - 6993854</p> <p><b>JUNTA DE ESCAPE</b></p> <p>FORD TRANSIT (1994 - 1996)</p> <p>132x75mm 1f-d61.3mm</p>		<p><b>M6096</b> NO. 6504754 - 6616185 - 6688869 - 6745091</p> <p><b>JUNTA DE ESCAPE</b></p> <p>FORD TRANSIT (1991 A 1994)</p> <p>d70x13mm 1f-d55mm</p>

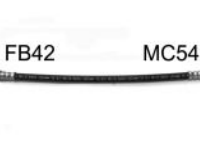
	<p><b>M6101</b> NO. 0043181200 - 11621317264 - 2465391 - 2875126300 - 4624383 - 60510306 - 6158920 - 6159188 - 6172323 - ...</p> <p>JUNTA DE ESCAPE</p> <p>FORD TRANSIT 91-94</p> <p>103x72x2mm 1f-d49mm</p>		<p><b>M6108</b> NO. 6026339</p> <p>JUNTA DE ESCAPE</p> <p>FORD TRANSIT (78-86)</p> <p>57x14mm 1f-d43mm</p>
	<p><b>P0041</b> NO. 2400E2445</p> <p>CAPA DE PEDAL</p> <p>TRANSIT Autocarro (72E, 73E): 1.5 900 (7200) 11.1965 - 08.1969 44 KW / 60 CV 1498 CC TRANSIT Autocarro (72E, 73E): 1.5 900 (7300) 11.1965 - 05.1973 44 KW / 60 CV 1498 CC TRANSIT Autocarro (72E, 73E): 1.5 1100 (72000) 11.1965 - 07.1971 44 KW / 60 CV 1498 CC TRANSIT Autocarro (72E, 73E): 1.5 1000 (72E2A) 12.1968 - 05.1973 44 KW / 60 CV 1498 CC TRANSIT Autocarro (72E, 73E): 1.7 900 (7300) 02.1971 - 0...</p> <p>72x50x10mm</p>		<p><b>P1028</b> NO. 1631037 - 86VB.2454.AA - 86VB245AA</p> <p>CAPA DE PEDAL TRAVÃO E EMBRAIAGEM</p> <p>FORD TRANSIT Autocarro (72E, 73E) 1.5 1000 (72E2A) 12.1968/05.1973 44KW 60CV 1498CC EX 0928324 1005292 - FORD TRANSIT Autocarro (72E, 73E) 1.5 1100 (72000) 11.1965/07.1971 44KW 60CV 1498CC EX 1005349 - FORD TRANSIT Autocarro (72E, 73E) 1.5 900 (7200) 11.1965/08.1969 44KW 60CV 1498CC EX 1005348 - FORD TRANSIT Autocarro (72E, 73E) 1.5 900 (7300) 11.1965/05.1973 44KW 60CV 1498CC EX 1005350 - FORD TRA...</p> <p>70x45x9mm</p>
	<p><b>P1029</b> NO. 2400E-2454C - 2400E2445</p> <p>CAPA DE PEDAL TRAVÃO E EMBRAIAGEM</p> <p>TRANSIT Autocarro (72E, 73E): 1.5 900 (7200) 11.1965 - 08.1969 44 KW / 60 CV 1498 CC TRANSIT Autocarro (72E, 73E): 1.5 900 (7300) 11.1965 - 05.1973 44 KW / 60 CV 1498 CC</p> <p>78x50x10mm</p>		<p><b>R021834</b> NO. 1592022 - 6047098</p> <p>TUBO INFERIOR DO RADIADOR</p> <p>FORD TRANSIT Autocarro (V_): 2.4 D (VAS, VBL, VIL, VUL, VZS) 12.1977/10.1986 46KW 63CV 2358CC - FORD TRANSIT Caixa (V_): 2.4 D (VVS) 11.1977/10.1986 46KW 63CV 2358CC - FORD TRANSIT Camião de plataforma/chassis (V_): 2.4 D (VGL, VSL, VTL, VCS, VDS) 11.1977/09.1985 46KW 62CV 2358CC</p> <p>B195-29/32mm 58x77x45mm</p>
	<p><b>R0498</b> NO.</p> <p>TUBO INFERIOR DO RADIADOR</p> <p>TRANSIT Autocarro (72E, 73E): 1.5 1000 (72E2A) 12.1968 - 05.1973 44 KW / 60 CV 1498 CC FORD TRANSIT MOTOR PERKINS TRANSIT Autocarro (72E, 73E): 1.7 900 (...)</p> <p>B220-d30/41mm 125-135-90mm</p>		<p><b>R0685</b> NO.</p> <p>TUBO DA CHUFAGE</p> <p>FORD TRANSIT</p> <p>B570-d13/11mm 40-265-500-80mm</p>
	<p><b>R220156</b> NO. 1590405 - 6056449 - 6152859 - 6777718 - 86VB-8260AB - 86VB8260CA</p> <p>TUBO SUPERIOR DO RADIADOR</p> <p>FORD TRANSIT Autocarro (V_): 2.4 D (VAS, VBL, VIL, VUL, VZS) 12.1977/10.1986 46KW 63CV 2358CC - FORD TRANSIT Autocarro (V_): 2.5 D (VAS, VBL, VIL, VUL, VZS) 10.1983/10.1986 50KW 68CV 2496CC - FORD TRANSIT Caixa (V_): 2.4 D (VVS) 11.1977/10.1986 46KW 63CV 2358CC - FORD TRANSIT Caixa (V_): 2.5 D (VVL) 10.1983/10.1986 50KW 68CV 2496CC - FORD TRANSIT Camião de plataforma/chassis (V_): 2.4 D ...</p> <p>B250-d37/42mm 75-105-165mm</p>		<p><b>R220157</b> NO. 1631363 - 86VB8286AA</p> <p>TUBO INFERIOR DO RADIADOR</p> <p>FORD TRANSIT Autocarro (E_) 2.5 DI (EBS, EDS, EDL, ESS, EUS) 08.1991/07.1994 51KW 70CV 2496CC 4BC, 4FA, 4CC 0928794, 0928797, 0928801, 09287902, 028347, 0928847 - FORD TRANSIT Autocarro (E_) 2.5 DI (EBS, EDS, EGL, ESS, EUS) 09.1991/07.1994 59KW 80CV 2496CC 4DA 09287950, 928798, 0928802, 09287912, 0283480928848, 0928201 - FORD TRANSIT Autocarro (E_) 2.5 TD (EBS, EBL, ECL, EDS, EDL, ESS, EUS) ...</p> <p>B290-d36/36mm 100-70-95-95mm</p>
	<p><b>R220160</b> NO. 1590405 - 6056449</p> <p>TUBO DE RADIADOR SUPERIOR</p> <p>FORD TRANSIT Autocarro (V_): 2.4 D (VAS, VBL, VIL, VUL, VZS) 12.1977/10.1986 46KW 63CV 2358CC - FORD TRANSIT Caixa (V_): 2.4 D (VVS) 11.1977/10.1986 46KW 63CV 2358CC - FORD TRANSIT Camião de plataforma/chassis (V_): 2.4 D (VGL, VSL, VTL, VCS, VDS) 11.1977/09.1985 46KW 62CV 2358CC</p> <p>B320-d42/38mm 115-160-150-70mm</p>		<p><b>R220162</b> NO. 1575162 - 6000308 - 71VB8286AD - 78VB8286GA - 78VB8286GB</p> <p>TUBO INFERIOR DO RADIADOR (LADO DO MOTOR)</p> <p>FORD TRANSIT Autocarro (V_) 2.4 D (VAS, VBL, VIL, VUL, VZS) 12.1977/10.1986 46KW 63CV 2358CC 4AA 0928499, 0928504, 0928507, 0928126, 0928131, 0928134 - FORD TRANSIT Caixa (V_) 2.4 D (VVS) 11.1977/10.1986 46KW 63CV 2358CC 4AA 9628033, 0928112 - FORD TRANSIT Camião de plataforma/chassis (V_) 2.4 D (VGL, VSL, VTL, VCS, VDS) 11.1977/09.1985 46KW 62CV 2358CC 4AA 0928115, 0928118, 0928123, 0928139...</p> <p>B225-d38/36mm 110-75-60mm</p>
	<p><b>R220163</b> NO. 6065514</p> <p>TUBO DE LIGAÇÃO DO DEPÓSITO AO RADIADOR</p> <p>FORD TRANSIT Autocarro (V_) 2.4 D (VAS, VBL, VIL, VUL, VZS) 12.1977/10.1986 46KW 63CV 2358CC 4AA 0928499, 0928504, 0928507, 0928126, 0928131, 0928134 - FORD TRANSIT Caixa (V_) 2.4 D (VVS) 11.1977/10.1986 46KW 63CV 2358CC 4AA 9628033, 0928112 - FORD TRANSIT Camião de plataforma/chassis (V_) 2.4 D (VGL, VSL, VTL, VCS, VDS) 11.1977/09.1985 46KW 62CV 2358CC 4AA 0928115, 0928118, 0928123, 0928139...</p> <p>B335-d32-32mm 105-210-55-40mm</p>		<p><b>R220164</b> NO. 1510935</p> <p>TUBO DE RADIADOR SUPERIOR</p> <p>FORD TRANSIT Autocarro (E_) 2.5 DI (EBS, EDS, EDL, ESS, EUS) 08.1991/07.1994 51KW 70CV 2496CC 4BC 4FA 4CC 0928794 0928797 0928801 0928790 2028347 0928847 - FORD TRANSIT Autocarro (E_) 2.5 DI (EBS, EDS, EGL, ESS, EUS) 09.1991/07.1994 59KW 80CV 2496CC 4DA 0928795 0928798 0928802 0928791 2028348 0928848 0928201 - FORD TRANSIT Autocarro (E_) 2.5 TD (EBS, EBL, ECL, EDS, EDL, ESS, EUS) 10.1992/07...</p> <p>B250-d40/43mm 105-210mm</p>
	<p><b>R221378</b> NO. 1514152 - 1704985 - 1827185 - 8V218B273BB - 8V218B273BC</p> <p>TUBO INFERIOR DO RADIADOR</p> <p>FORD TRANSIT COURIER B460 Veículo multiuso 1.6 TDCi 02.2014/12.2023 70KW 95CV 1560CC T3CB T3CA T3CC</p> <p>B540-d28/d30mm 78-142-300-90-67mm</p>		<p><b>R221380</b> NO. 6777718 - 92VB.8260.BA</p> <p>TUBO INFERIOR E SUPERIOR DO RADIADOR</p> <p>FORD TRANSIT 2.5D (1983 A 1992) - 2.5Di (1991 A 2000) - 2.5TD (1992 A 1994)</p> <p>B255-d42/35mm 85-115-90-80mm</p>

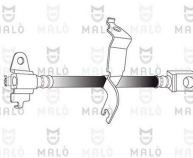
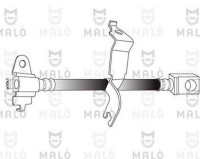
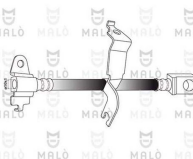
	<p><b>R221381</b> NO. 6777407 - 92VB.8286.AB</p> <p>TUBO INFERIOR DA SAÍDA DE ÁGUA DO RADIADOR</p> <p>FORD TRANSIT Camião de plataforma/chassis (V...): 2.5 D (VGL, VSL, VTL, VCS, VDS) 10.1983/10.1986 50KW 68CV 2496CC - FORD TRANSIT Autocarro (T...): 2.5 D (TBS, TCL, TCS, TEL, TES) 12.1985/01.1989 50KW 68CV 2496CC - FORD TRANSIT Autocarro (E...): 2.5 TD (ECL, EDS, EDL, EGL, ESS, EUS) 09.1991/07.1994 74KW 100CV 2496CC - FORD TRANSIT Caixa (E...): 2.5 TD (EAS, EAL) 05.1991/06.1994 74KW 101CV 2496CC - ...</p> <p>B300-d33/36mm 95-90-90-75mm</p>		<p><b>R221782</b> NO. 2T1V8A507AA - 4397248</p> <p>TUBO DO PERMUTADOR DO AQUECIMENTO</p> <p>FORD TRANSIT CONNECT (P65_, P70_, P80_) 1.8 TDCi (De 06.2002 Até 12.2013) 66kW 90cv 1753cm3 Caixa/monovolume - FORD TRANSIT CONNECT (P65_, P70_, P80_) 1.8 TDCi (De 08.2006 Até 12.2013) 81kW 110cv 1753cm3 Caixa/monovolume -</p> <p>B88-d19/d19mm 40-101-76-50mm</p>
	<p><b>R222435</b> NO. 1144890</p> <p>TUBO DE LIGAÇÃO AO DEPOSITO EXPANSÃO</p> <p>FORD TRANSIT CONNECT (P65_, P70_, P80_) 1.8 Di (De 06.2002/12.2013) 55KW 75CV 1753CC R2PA P7PB P7PA BHPA 8566099 8566102 8566ADZ 8566AEC 8566ASI 8566ASO</p> <p>B390-d15/d17mm 96-68-79-74-148-67mm</p>		<p><b>R222489</b> NO. 1507243 - 1C156C646AJ - 4714482 - 4C116C646AE</p> <p>TUBO DO AR SOBREALIMENTAÇÃO</p> <p>FORD TRANSIT Autocarro (FD..., FB..., FS..., FZ..., FC...) 2.3 16V RWD (F_B_, F_C_, F_A_) (De 2000.08 Até 2006.05) 107kW 146cv 2295cm3 Autocarro - FORD TRANSIT Autocarro (FD..., FB..., FS..., FZ..., FC_) 2.4 TDE (De 2004.03 Até 2006.05) 85kW 115cv 2402cm3 Autocarro - FORD TRANSIT Autocarro (FD..., FB..., FS..., FZ..., FC_) 2.4 TDE (F_C_, F_B_, F_A_) (De 2001.07 Até 2006.05) 92kW ...</p> <p>B610-42/51mm 73x91x39x148x375x80mm</p>
	<p><b>R222491</b> NO. 7221012 - 95VB8K289CE</p> <p>TUBO DE LIGAÇÃO DO RADIADOR AO DEPOSITO COMPENSAÇÃO</p> <p>FORD TRANSIT Caixa (E...) 2.5 DI (EAL, EAS) 05.1991/06.1994 51KW 70CV 2496CC 4BC 4CC 4FA 2028501 0928193 0928197 - FORD TRANSIT Caixa (E...) 2.5 DI (EAL, EAS) 10.1992/06.1994 63KW 85CV 2496CC 4GA 0928224 0928225 2028504 - FORD TRANSIT Caixa (E...) 2.5 DI (EAS, EAL) 05.1991/06.1994 59KW 80CV 2496CC 4DA 2028502 0928194 0928198 - FORD TRANSIT Caixa (E...) 2.5 TD (EAS, EAL) 05.1991/06.1994 74KW 101CV ...</p> <p>B315-20/20mm 108-30-49-105-45mm ch-d66-87-15mm</p>		<p><b>R222493</b> NO. 1440539 - 6C119C623BC</p> <p>TUBO ADMISSÃO FILTRO DE AR</p> <p>FORD TRANSIT Autocarro (FD..., FB..., FS..., FZ..., FC_) 2.2 TDCi (De 2006.04 Até 2014.08) 63kW 85cv 2198cm3 Autocarro - FORD TRANSIT Autocarro (FD..., FB..., FS..., FZ..., FC_) 2.2 TDCi (De 2007.10 Até 2014.08) 103kW 140cv 2198cm3 Autocarro - FORD TRANSIT Autocarro (FD..., FB..., FS..., FZ..., FC_) 2.4 TDCi (De 2006.04 Até 2014.08) 74kW 100cv 2402cm3 Autocarro - FORD TRANS...</p> <p>B350-53/67mm 123-150-94mm ch-d19x56mm</p>
	<p><b>R222495</b> NO. 6C116C646BE</p> <p>TUBO DO AR SOBREALIMENTAÇÃO</p> <p>FORD TRANSIT Autocarro (FD..., FB..., FS..., FZ..., FC_) 2.2 TDCi (De 04.2006 Até 08.2014) 63kW 85cv 2198cm3 Autocarro - FORD TRANSIT Autocarro (FD..., FB..., FS..., FZ..., FC_) 2.2 TDCi (De 10.2007 Até 08.2014) 103kW 140cv 2198cm3 Autocarro - FORD TRANSIT Autocarro (FD..., FB..., FS..., FZ..., FC_) 2.4 TDCi (De 04.2006 Até 08.2014) 74kW 100cv 2402cm3 Autocarro - FORD TRANSIT Autocarro (FD...</p> <p>B590-d47/d56mm mm</p>		<p><b>R224115</b> NO. 4447827</p> <p>TUBO DE LIGAÇÃO AO DEPÓSITO EXPANSÃO</p> <p>FORD TRANSIT CONNECT (P65_, P70_, P80_) 1.8 Di (De 06.2002 Até 12.2013) 55kW 75cv 1753cm3 Caixa/monovolume - FORD TRANSIT CONNECT (P65_, P70_, P80_) 1.8 TDCi (De 06.2002 Até 12.2013) 66kW 90cv 1753cm3 Caixa/monovolume -</p> <p>B405-15/20mm 195x40x48x48x177x42mm</p>
	<p><b>R224116</b> NO. 4371775 - 4378820</p> <p>TUBO DE LIGAÇÃO AO DEPOSITO EXPANSÃO</p> <p>FORD TRANSIT CONNECT (P65_, P70_, P80_) 1.8 Di (De 06.2002 Até 12.2013) 55kW 75cv 1753cm3 Caixa/monovolume - FORD TRANSIT CONNECT (P65_, P70_, P80_) 1.8 TDCi (De 06.2002 Até 12.2013) 66kW 90cv 1753cm3 Caixa/monovolume -</p> <p>B310-9/9mm 45x45x71x200x63x81mm</p>		<p><b>R224122</b> NO. 1349832 - 2T1Q6K683CE</p> <p>TUBO ADMISSÃO FILTRO DE AR</p> <p>FORD TRANSIT CONNECT (P65_, P70_, P80_) 1.8 Di (06.02 A 12.13) 75cv 1753cc Caixa - FORD TRANSIT CONNECT (P65_, P70_, P80_) 1.8 TDCi (06.02 A 12.13) 90cv 1753cc Caixa</p> <p>B130-d49/49mm 80-90mm</p>
	<p><b>R224124</b> NO. 1133898 - 1M519R504AB</p> <p>TUBO DE ADMISSÃO FILTRO DE AR</p> <p>FORD TRANSIT CONNECT (P65_, P70_, P80_) 1.8 16V (De 2002.06 Até 2013.12) 85kW 116cv 1796cm3 Caixa - FORD TRANSIT CONNECT (P65_, P70_, P80_) 1.8 Di (De 2002.06 Até 2013.12) 55kW 75cv 1753cm3 Caixa - FORD TRANSIT CONNECT (P65_, P70_, P80_) 1.8 TDCi (De 2002.06 Até 2013.12) 66kW 90cv 1753cm3 Caixa - FORD TRANSIT CONNECT (P65_, P70_, P80_) 1.8 TDCi (De 2006.08 Até 2013.12) 81kW 11...</p> <p>B325-46/75mm 53x170x70x85mm ch-d28x40mm</p>		<p><b>R224127</b> NO. 7T169R504AD</p> <p>TUBO ADMISSÃO FILTRO DE AR</p> <p>FORD TRANSIT CONNECT (P65_, P70_, P80_) 1.8 TDCi (08.06 A 12.13) 110cv 1753cc Caixa</p> <p>B310-d71/55mm</p>
	<p><b>R224129</b> NO. 1438136 - 7T1618K582BC</p> <p>TUBO PERMUTADOR AQUECIMENTO</p> <p>FORD TRANSIT CONNECT (P65_, P70_, P80_) 1.8 TDCi (De 2002.06 Até 2013.12) 66kW 90cv 1753cm3 Caixa - FORD TRANSIT CONNECT (P65_, P70_, P80_) 1.8 TDCi (De 2006.08 Até 2013.12) 81kW 110cv 1753cm3 Caixa -</p> <p>B240-14/17mm 54x59x96x79mm</p>		<p><b>R224163</b> NO. 4042233 - YC158B273AA</p> <p>TUBO INFERIOR DO RADIADOR</p> <p>FORD TRANSIT Caixa (FA...) 2.4 DI (FAA_, FAB_, FAC_, FAD_) 01.2000/05.2006 66KW 90CV 2402CC D2FB D2FA 8566043 8566048 8566008 8566011 - FORD TRANSIT Caixa (FA...) 2.4 TD 08.2000/08.2003 55KW 75CV 2402CC F4FA - FORD TRANSIT Caixa (FA_) 2.4 TDCi 03.2004/05.2006 101KW 137CV 2402CC H9FA 8566109 8566113 8566111 8566115 - FORD TRANSIT Caixa (FA_) 2.4 TDE 07.2001/05.2006 92KW 125CV 2402CC DOFA 856604...</p> <p>B405-30/31mm 95-68-114-83-111mm</p>
	<p><b>R225775</b> NO. 1710178 - 1710179 - AV216C646AD - AV216K863AE</p> <p>TUBO DO AR SOBREALIMENTAÇÃO</p> <p>FORD TRANSIT COURIER B460 Caixa/monovolume 1.5 EcoBlue desde 04.2018 74KW 100CV 1499CC XXCA XXCB XXCC 8566BQD - FORD TRANSIT COURIER B460 Caixa/monovolume 1.5 TDCi desde 02.2014 55KW 75CV 1499CC XUCE XWCB XWCA XUCD XUCC UGCB UGCA 8566BIK - FORD TRANSIT COURIER B460 Caixa/monovolume 1.5 TDCi desde 05.2015 70KW 95CV 1499CC XVCD XVCC XVCB XVCA 8566BLM - FORD TRANSIT COURIER B460 Caixa/monovolume 1.6 ...</p> <p>B174-d47/d47mm 174mm</p>		<p><b>R225776</b> NO. 1349868</p> <p>TUBO DE RADIADOR</p> <p>FORD TRANSIT CONNECT (P65_, P70_, P80_) 1.8 16V (06.2002 - 12.2013) 85kW 116cv 1796cm3 Caixa/monovolume FORD TRANSIT CONNECT (P65_, P70_, P80_) 1.8 Di (06.2002 - 12.2013) 55kW 75cv 1753cm3 Caixa/monovolume FORD TRANSIT CONNECT (P65_, P70_, P80_) 1.8 TDCi (06.2002 - 12.2013) 66kW 90cv 1753cm3 Caixa/monovolume FORD TRANSIT CONNECT (P65_, P70_, P80_) 1.8 TDCi (08.2006 - 12.2013) 81kW 110cv 1753cm3 C...</p> <p>B151-d9/d9mm 25-56-25-22-15mm</p>

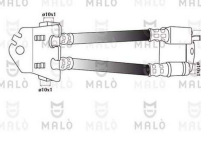
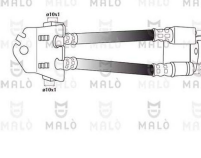
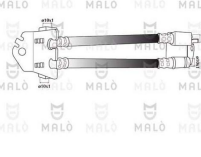
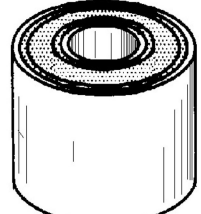
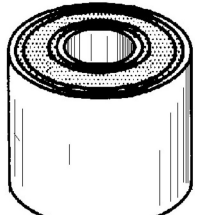
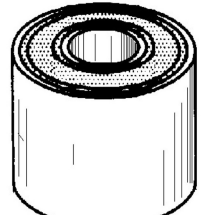
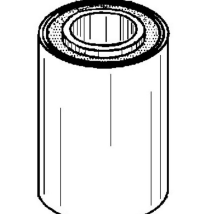
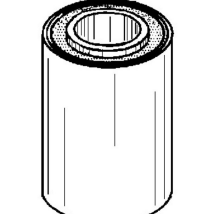
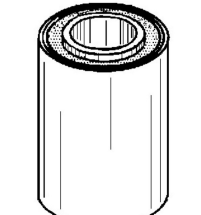

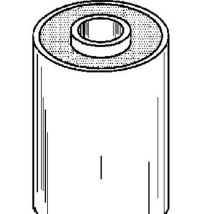
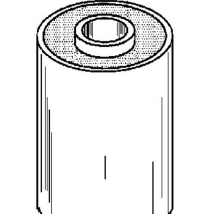
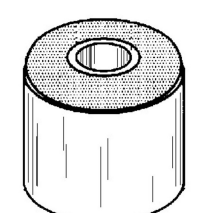
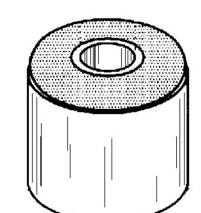
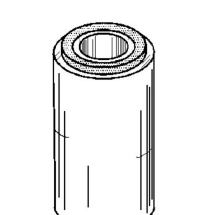
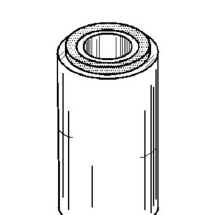













	<p><b>R230483</b> NO. 2584513 - KV616K863BA</p> <p>TUBO DO AR SOBRELIMENTAÇÃO</p> <p>FORD TRANSIT CONNECT V408 Caixa/monovolume 1.5 EcoBlue desde 05.2018 55KW 75CV 1499CC BEGA 8566BML - FORD TRANSIT CONNECT V408 Caixa/monovolume 1.5 EcoBlue desde 05.2018 74KW 101CV 1499CC Z2GA 8566BUU 8566BMM - FORD TRANSIT CONNECT V408 Caixa/monovolume 1.5 EcoBlue desde 05.2018 88KW 120CV 1499CC ZTGA 8566BMN - FORD TRANSIT CONNECT V408 Caixa/monovolume 1.5 TDCi desde 05.2015 74KW 101CV 1499CC XYG...</p> <p>B105-d46/d47mm 47-57mm</p>		<p><b>R8076</b> NO. 84VB18472CA</p> <p>TUBO DE CHAFAGEM</p> <p>FORD TRANSIT Autocarro (E_) 2.5 Di (EBS, EDS, EDL, ESS, EUS) 08.1991/07.1994 51KW 70CV 2496CC 4BC 4FA 4CC 0928794 0928797 0928801 0928790 2028347 0928847 - FORD TRANSIT Autocarro (E_) 2.5 Di (EBS, EDS, EGL, ESS, EUS) 09.1991/07.1994 59KW 80CV 2496CC 4DA 0928795 0928798 0928802 0928791 2028348 0928848 0928201 - FORD TRANSIT Autocarro (T_) 2.5 D (TBS, TCL, TCS, TEL, TES) 12.1985/01.1989 50KW 6...</p> <p>B440-d17/17mm 165-65-335-590-140mm</p>
	<p><b>R8077</b> NO. 2C118W005BB - 2C118W005BC - 4514617</p> <p>TUBO DE CHAFAGEM</p> <p>FORD TRANSIT Autocarro (FD_, FB_, FS_, FZ_, FC_) 2.4 TDCi 03.2004/05.2006 101KW 137CV 2402CC H9FA 8566121 8566556 8566558 8566560 8566562 8566564 8566566 8566569 - FORD TRANSIT Autocarro (FD_, FB_, FS_, FZ_, FC_) 2.4 TDE 03.2004/05.2006 85KW 115CV 2402CC FXFA 8566120 8566555 8566557 8566559 8566561 8566563 8566565 8566568 - FORD TRANSIT Autocarro (FD_, FB_, FS_, FZ_, FC_)...</p> <p>B500-d9/d9mm 110-500-220-120-250mmmm</p>		<p><b>R8138</b> NO. 6726178</p> <p>TUBO PERMUTADOR AQUECIMENTO</p> <p>FORD TRANSIT Caixa (T_) 2.5 D (TAL, TAS, TGL, TWS) (01.86 A 09.91) 68cv 2496cc Caixa - FORD TRANSIT Caixa (T_) 2.5 D (TAL, TAS, TGL, TWS) (10.88 A 09.91) 71cv 2496cc Caixa - FORD TRANSIT Caixa (E_) 2.5 Di (EAL, EAS) (05.91 A 06.94) 70cv 2496cc Caixa</p> <p>B440-15/15mm 70-70-130-80-80-70-70-90mm</p>
	<p><b>RF80419</b> NO. 1104177 - 1139037 - 1461332 - XS4Q8K579CE - XS4Q8K579CF - XS4Q9N271CC</p> <p>TUBO DE FERRO REFRIGERAÇÃO</p> <p>FORD TRANSIT CONNECT (P65_, P70_, P80_) 1.8 Di (De 06.2002 Até 12.2013) 55kW 75cv 1753cm3 Caixa/monovolume - FORD TRANSIT CONNECT (P65_, P70_, P80_) 1.8 TDCi (De 06.2002 Até 12.2013) 66kW 90cv 1753cm3 Caixa/monovolume -</p> <p>B345-28/31mm 89x56x109x51x52mm ch-d21x25x109mm</p>		<p><b>RT08398</b> NO. 1631046</p> <p>TUBO DE TRAVÃO FRENTE LH</p> <p>FORD TRANSIT AUTOBUS 2.0 (11-1977 A 10-1986) - AUTOBUS 2.3 D FT 100 (11-1971 A 09-1978) - AUTOBUS 2.4 D (12-1977 A 10-1986) - FURGONATO 2.0 (11-1977 A 10-1986) - FURGONATO 2.4 D (11-1977 A 10-1986) - PIANALE PIATTO-TELAIO 2.0 (11-1977 A 10-1986) - PIANALE</p> <p>278mm EF259 - EF263</p>
	<p><b>RT08466</b> NO. 1655850 - 6142527</p> <p>TUBO DE TRAVÃO FRENTE RH</p> <p>FORD TRANSIT 100L (03-1986 A 1991) - 130L (03-1986 A 1991)</p> <p>275mm EF259 - EF262</p>		<p><b>RT08467</b> NO. 1655851 - 6142528</p> <p>TUBO DE TRAVÃO FRENTE LH</p> <p>FORD TRANSIT 100L (03-1986 A 1991) - 130L (03-1986 A 1991)</p> <p>275mm EF259 - EF263</p>
	<p><b>RT08691</b> NO. 6149181 - 6577425 - 92VB2282AA</p> <p>TUBO DE TRAVÃO TRÁS LH-RH</p> <p>FORD TRANSIT 130L (03-1986 A 1991) (PINÇA (2 PISTÕES) 130 - 160 - 190 (2.0 - 2.5D - 2.5TD) (03-1986 A 1991) (PINÇA (4 PISTÕES) - TT (APÓS 91) (TUBOS SEPARADOS VERTICALMENTE)</p> <p>420mm EF297 - FC3</p>		<p><b>RT08699</b> NO. 1089437 - 1655854 - 6149182 - 6577426</p> <p>TUBO DE TRAVÃO TRÁS LH-RH (TUBOS SEPARADOS DIAGONALMENTE)</p> <p>FORD TRANSIT TT (APÓS 1991)</p> <p>440mm EF297/298 - ST10</p>
	<p><b>RT80261</b> NO. 4370933 - 4447742</p> <p>TUBO DE TRAVÃO TRÁS LH-RH (SEM ABS)</p> <p>FORD TRANSIT CONNECT TT (APÓS 06-2002)</p> <p>385mm FB42 - MC54</p>		<p><b>RT80263</b> NO. 4510813</p> <p>TUBO DE TRAVÃO TRÁS LH-RH</p> <p>FORD TRANSIT CONNECT 1.8 16V (APÓS 06-2002) - TRANSIT CONNECT 1.8 Di (APÓS 06-2002) - TRANSIT CONNECT 1.8 TDCi (APÓS 06-2002)</p> <p>345mm FB42 - MC54</p>
	<p><b>RT80354</b> NO. 4447381</p> <p>TUBO DE TRAVÃO FRENTE LH-RH</p> <p>FORD TRANSIT CONNECT 1.8 16V (APÓS 06-2002) - TRANSIT CONNECT 1.8 Di (APÓS 06-2002) - TRANSIT CONNECT 1.8 TDCi (APÓS 06-2002)</p> <p>370mm FB69 - MG7</p>		<p><b>RT80452</b> NO. 4447739</p> <p>TUBO DE TRAVÃO FRENTE LH</p> <p>FORD TRANSIT AUTOBUS 2.0 Di (08-2000 A 05-2006) - TRANSIT AUTOBUS 2.3 16V (08-2000 A 05-2006) - TRANSIT AUTOBUS 2.4 Di (01-2000 A 05-2006) - TRANSIT AUTOBUS 2.4 TDE (07-2001 A 05-2006)</p> <p>465mm</p>
	<p><b>RT80452</b> NO. 4447739</p> <p>TUBO DE TRAVÃO FRENTE LH</p> <p>FORD TRANSIT FURGONATO 2.0 Di (08-2000 A 05-2006) - TRANSIT FURGONATO 2.0 TDCi (08-2002 A 05-2006) - TRANSIT FURGONATO 2.3 16V (04-2001 A 05-2006) - TRANSIT FURGONATO 2.4 Di (01-2000 A 05-2006) - TRANSIT FURGONATO 2.4 TDE (07-2001 A 05-2006)</p> <p>465mm</p>		<p><b>RT80452</b> NO. 4447739</p> <p>TUBO DE TRAVÃO FRENTE LH</p> <p>FORD TRANSIT PIANALE PIATTO-TELAIO 2.0 Di (08-2000 A 05-2006) - TRANSIT PIANALE PIATTO-TELAIO 2.0 TDCi (08-2002 A 05-2006) - TRANSIT PIANALE PIATTO-TELAIO 2.3 16V (04-2001 A 05-2006) - TRANSIT PIANALE PIATTO-TELAIO 2.4 Di (01-2000 A 05-2006) - TRANSIT PIA</p> <p>465mm</p>

	<p><b>RT80453</b> NO. 4409343</p> <p>TUBO DE TRAVÃO TRÁS LH-RH</p> <p>FORD TRANSIT AUTOBUS 2.0 Di (08-2000 A 05-2006) - TRANSIT AUTOBUS 2.0 TDCi (08-2002 A 05-2006) - TRANSIT AUTOBUS 2.3 16V (08-2000 A 05-2006) - TRANSIT AUTOBUS 2.4 Di (01-2000 A 05-2006) - TRANSIT AUTOBUS 2.4 TDE (07-2001 A 05-2006)</p> <p>365mm</p>		<p><b>RT80453</b> NO. 4409343</p> <p>TUBO DE TRAVÃO TRÁS LH-RH</p> <p>FORD TRANSIT FURGONATO 2.0 Di (08-2000 A 05-2006) - TRANSIT FURGONATO 2.0 TDCi (08-2002 A 05-2006) - TRANSIT FURGONATO 2.3 16V (04-2001 A 05-2006) - TRANSIT FURGONATO 2.4 Di (01-2000 A 05-2006) - TRANSIT FURGONATO 2.4 TDE (07-2001 A 05-2006)</p> <p>365mm</p>
	<p><b>RT80454</b> NO. 4409342</p> <p>TUBO DE TRAVÃO TRÁS LH-RH</p> <p>FORD TRANSIT PIANALE PIATTO /TELAIO 2.0 Di (08-2000 A 05-2006) - TRANSIT PIANALE PIATTO /TELAIO 2.0 TDCi (08-2002 A 05-2006) - TRANSIT PIANALE PIATTO/TELAIO 2.3 16V (04-2001 A 05-2006) - TRANSIT PIANALE PIATTO/TELAIO 2.4 Di (01-2000 A 05-2006) - TRANSIT P</p> <p>415mm</p>		<p><b>S1006</b> NO. 6152113 - 78VB.5781.AA - 86VB5781AA</p> <p>SILENT-BLOC DE MOLAS TRÁS</p> <p>FORD TRANSIT Autocarro (T_) 1.6 (TBL, TES) 12.1985/01.1989 46KW 63CV 1593CC - FORD TRANSIT Autocarro (T_) 2.0 (TBS, TCL, TCS, TEL, TES) 11.1985/09.1992 57KW 78CV 1994CC - FORD TRANSIT Autocarro (T_) 2.0 Cat (TBS, TCL, TCS) 12.1985/09.1992 57KW 78CV 1993CC - FORD TRANSIT Autocarro (T_) 2.5 D (TBS, TCL, TCS, TEL, TES) 12.1985/01.1989 50KW 68CV 2496CC - FORD TRANSIT Caixa (T_) 1.6 (TAS...)</p> <p>d46.5x68mm c60mm 1f-d18mm</p>
	<p><b>S1006-A</b> NO. 6152113 - 78VB.5781.AA - 86VB5781AA</p> <p>SILENT-BLOC DE MOLAS TRÁS</p> <p>FORD TRANSIT Autocarro (T_) 1.6 (TBL, TES) 12.1985/01.1989 46KW 63CV 1593CC - FORD TRANSIT Autocarro (T_) 2.0 (TBS, TCL, TCS, TEL, TES) 11.1985/09.1992 57KW 78CV 1994CC - FORD TRANSIT Autocarro (T_) 2.0 Cat (TBS, TCL, TCS) 12.1985/09.1992 57KW 78CV 1993CC - FORD TRANSIT Autocarro (T_) 2.5 D (TBS, TCL, TCS, TEL, TES) 12.1985/01.1989 50KW 68CV 2496CC - FORD TRANSIT Caixa (T_) 1.6 (TAS...)</p> <p>d46.5x68mm c60mm 1f-d18mm</p>		<p><b>S1006-B</b> NO. 6152113 - 78VB.5781.AA - 86VB5781AA</p> <p>SILENT-BLOC DE MOLAS TRÁS</p> <p>FORD TRANSIT Autocarro (T_) 1.6 (TBL, TES) 12.1985/01.1989 46KW 63CV 1593CC - FORD TRANSIT Autocarro (T_) 2.0 (TBS, TCL, TCS, TEL, TES) 11.1985/09.1992 57KW 78CV 1994CC - FORD TRANSIT Autocarro (T_) 2.0 Cat (TBS, TCL, TCS) 12.1985/09.1992 57KW 78CV 1993CC - FORD TRANSIT Autocarro (T_) 2.5 D (TBS, TCL, TCS, TEL, TES) 12.1985/01.1989 50KW 68CV 2496CC - FORD TRANSIT Caixa (T_) 1.6 (TAS...)</p> <p>d46.5x68mm c60mm 1f-d18mm</p>
	<p><b>S1007</b> NO. 1476728 - 6052013 - 78VB5781CB - 78VB5781DA</p> <p>SILENT-BLOC DE MOLAS TRÁS</p> <p>FORD TRANSIT Autocarro (T_) 1.6 (TBL, TES) 12.1985/01.1989 46KW 63CV 1593CC - FORD TRANSIT Autocarro (T_) 2.0 (TBS, TCL, TCS, TEL, TES) 11.1985/09.1992 57KW 78CV 1994CC - FORD TRANSIT Autocarro (T_) 2.0 Cat (TBS, TCL, TCS) 12.1985/09.1992 57KW 78CV 1993CC - FORD TRANSIT Autocarro (T_) 2.5 D (TBS, TCL, TCS, TEL, TES) 12.1985/01.1989 50KW 68CC 2496CC - FORD TRANSIT Autocarro (T_) 2.5 ...</p> <p>d46.5x67mm c61mm 1f-d20mm</p>		<p><b>S1007-A</b> NO. 1476728 - 6052013 - 78VB5781CB - 78VB5781DA</p> <p>SILENT-BLOC DE MOLAS TRÁS</p> <p>FORD TRANSIT Autocarro (T_) 1.6 (TBL, TES) 12.1985/01.1989 46KW 63CV 1593CC - FORD TRANSIT Autocarro (T_) 2.0 (TBS, TCL, TCS, TEL, TES) 11.1985/09.1992 57KW 78CV 1994CC - FORD TRANSIT Autocarro (T_) 2.0 Cat (TBS, TCL, TCS) 12.1985/09.1992 57KW 78CV 1993CC - FORD TRANSIT Autocarro (T_) 2.5 D (TBS, TCL, TCS, TEL, TES) 12.1985/01.1989 50KW 68CC 2496CC - FORD TRANSIT Autocarro (T_) 2.5 ...</p> <p>d46.5x67mm c61mm 1f-d20mm</p>
	<p><b>S1007-B</b> NO. 1476728 - 6052013 - 78VB5781CB - 78VB5781DA</p> <p>SILENT-BLOC DE MOLAS TRÁS</p> <p>FORD TRANSIT Autocarro (T_) 1.6 (TBL, TES) 12.1985/01.1989 46KW 63CV 1593CC - FORD TRANSIT Autocarro (T_) 2.0 (TBS, TCL, TCS, TEL, TES) 11.1985/09.1992 57KW 78CV 1994CC - FORD TRANSIT Autocarro (T_) 2.0 Cat (TBS, TCL, TCS) 12.1985/09.1992 57KW 78CV 1993CC - FORD TRANSIT Autocarro (T_) 2.5 D (TBS, TCL, TCS, TEL, TES) 12.1985/01.1989 50KW 68CC 2496CC - FORD TRANSIT Autocarro (T_) 2.5 ...</p> <p>d46.5x67mm c61mm 1f-d20mm</p>		<p><b>S1009</b> NO. RVT5781AA</p> <p>SILENT-BLOC DE MOLAS FRENTE (FURO 19mm)</p> <p>FORD TRANSIT FORGÃO (ATÉ 1982) - CAIXA ABERTA RODADO DUPL0 (1982 A 1989)</p> <p>d38x69mm c62mm 1f-d19mm</p>
	<p><b>S1019</b> NO. 1575045 - 78VB5719BA</p> <p>SILENT-BLOC DE MOLAS TRÁS</p> <p>FORD TRANSIT Autocarro (T_) 1.6 (TBL, TES) 12.1985/01.1989 46KW 63CV 1593CC - FORD TRANSIT Autocarro (T_) 2.0 (TBS, TCL, TCS, TEL, TES) 11.1985/09.1992 57KW 78CV 1994CC - FORD TRANSIT Autocarro (T_) 2.0 Cat (TBS, TCL, TCS) 12.1985/09.1992 57KW 78CV 1993CC - FORD TRANSIT Autocarro (T_) 2.5 D (TBS, TCL, TCS, TEL, TES) 12.1985/01.1989 50KW 68 2496CC - FORD TRANSIT Autocarro (T_) 2.5 D ...</p> <p>d46.5x67mm c61mm 1f-d16mm</p>		<p><b>S1019-A</b> NO. 1575045 - 78VB5719BA</p> <p>SILENT-BLOC DE MOLAS TRÁS</p> <p>FORD TRANSIT Autocarro (T_) 1.6 (TBL, TES) 12.1985/01.1989 46KW 63CV 1593CC - FORD TRANSIT Autocarro (T_) 2.0 (TBS, TCL, TCS, TEL, TES) 11.1985/09.1992 57KW 78CV 1994CC - FORD TRANSIT Autocarro (T_) 2.0 Cat (TBS, TCL, TCS) 12.1985/09.1992 57KW 78CV 1993CC - FORD TRANSIT Autocarro (T_) 2.5 D (TBS, TCL, TCS, TEL, TES) 12.1985/01.1989 50KW 68 2496CC - FORD TRANSIT Autocarro (T_) 2.5 D ...</p> <p>d46.5x67mm c61mm 1f-d16mm</p>
	<p><b>S1038</b> NO. 6052013 - 6054238 - 78VB.5781.CB - 78VB5719CB - 78VB5781DA</p> <p>SILENT-BLOC DE MOLAS TRÁS RODADO SIMPLES (FURO 16mm)</p> <p>FORD TRANSIT Autocarro (T_) 1.6 (TBL, TES) 12.1985/01.1989 46KW 63CV 1593CC LAT 0928607 0928616 - FORD TRANSIT Autocarro (T_) 2.0 (TBS, TCL, TCS, TEL, TES) 11.1985/09.1992 57KW 78CV 1994CC NAT NAV 0928639 0928608 0928617 0928776 0928164 0928166 - FORD TRANSIT Autocarro (T_) 2.0 Cat (TBS, TCL, TCS) 12.1985/09.1992 57KW 78CV 1993CC N6T 0928617 0928776 0928164 0928166 - FORD TRANSIT Autocarro (...)</p> <p>d47.5x83mm c64mm 1f-d16mm</p>		<p><b>S1038-B</b> NO. 6052013 - 6054238 - 78VB.5781.CB - 78VB5719CB - 78VB5781DA</p> <p>SILENT-BLOC DE MOLAS TRÁS RODADO SIMPLES (FURO 16mm)</p> <p>FORD TRANSIT Autocarro (T_) 1.6 (TBL, TES) 12.1985/01.1989 46KW 63CV 1593CC LAT 0928607 0928616 - FORD TRANSIT Autocarro (T_) 2.0 (TBS, TCL, TCS, TEL, TES) 11.1985/09.1992 57KW 78CV 1994CC NAT NAV 0928639 0928608 0928617 0928776 0928164 0928166 - FORD TRANSIT Autocarro (T_) 2.0 Cat (TBS, TCL, TCS) 12.1985/09.1992 57KW 78CV 1993CC N6T 0928617 0928776 0928164 0928166 - FORD TRANSIT Autocarro (...)</p> <p>d47.5x83mm c64mm 1f-d16mm</p>
	<p><b>S1054</b> NO. 1575577 - 76VB5781AA</p> <p>SILENT-BLOC DE MOLAS FRENTE FURO 18 mm</p> <p>FORD TRANSIT Autocarro (T_) 1.6 (TBL, TES) 12.1985/01.1989 46KW 63CV 1593CC LAT 0928607 0928616 - FORD TRANSIT Autocarro (T_) 2.0 (TBS, TCL, TCS, TEL, TES) 11.1985/09.1992 57KW 78CV 1994CC NAT NAV 0928639 0928608 0928617 0928776 0928164 0928166 - FORD TRANSIT Autocarro (T_) 2.0 Cat (TBS, TCL, TCS) 12.1985/09.1992 57KW 78CV 1993CC N6T 0928617 0928776 0928164 0928166 - FORD TRANSIT Autocarro (...)</p> <p>d37x66.5mm c60mm 1f-d18mm</p>		<p><b>S1054-B</b> NO. 1575577 - 76VB5781AA</p> <p>SILENT-BLOC DE MOLAS FRENTE FURO 18 mm</p> <p>FORD TRANSIT Autocarro (T_) 1.6 (TBL, TES) 12.1985/01.1989 46KW 63CV 1593CC LAT 0928607 0928616 - FORD TRANSIT Autocarro (T_) 2.0 (TBS, TCL, TCS, TEL, TES) 11.1985/09.1992 57KW 78CV 1994CC NAT NAV 0928639 0928608 0928617 0928776 0928164 0928166 - FORD TRANSIT Autocarro (T_) 2.0 Cat (TBS, TCL, TCS) 12.1985/09.1992 57KW 78CV 1993CC N6T 0928617 0928776 0928164 0928166 - FORD TRANSIT Autocarro (...)</p> <p>d37x66.5mm c60mm 1f-d18mm</p>

	<p><b>S1083</b> NO. 56VB5781AA - 6152113</p> <p>SILENT-BLOC DE MOLA DE TRÁS</p> <p>FORD TRANSIT Caixa (T_): 1.6 (TAS) 09.1985/09.1992 46KW 63CV 1593CC - FORD TRANSIT Caixa (T_): 1.6 10.1985/07.1987 62KW 84CV 1598CC - FORD TRANSIT Caixa (T_): 2.0 10.1985/03.1991 56KW 76CV 1993CC - FORD TRANSIT Caixa (T_): 2.0 (TAL, TAS, TGL, TWS) 09.1985/09.1992 57KW 78CV 1994CC - FORD TRANSIT Caixa (T_): 2.5 D (TAL, TAS, TGL, TWS) 01.1986/09.1991 50KW 68CV 2496CC - FORD TRANSIT Caixa (...)</p> <p>d46.5x72mm c61mm 1f-d18mm</p>		<p><b>S1083-B</b> NO. 56VB5781AA - 6152113</p> <p>SILENT-BLOC DE MOLA DE TRÁS</p> <p>FORD TRANSIT Caixa (T_): 1.6 (TAS) 09.1985/09.1992 46KW 63CV 1593CC - FORD TRANSIT Caixa (T_): 1.6 10.1985/07.1987 62KW 84CV 1598CC - FORD TRANSIT Caixa (T_): 2.0 10.1985/03.1991 56KW 76CV 1993CC - FORD TRANSIT Caixa (T_): 2.0 (TAL, TAS, TGL, TWS) 09.1985/09.1992 57KW 78CV 1994CC - FORD TRANSIT Caixa (T_): 2.5 D (TAL, TAS, TGL, TWS) 01.1986/09.1991 50KW 68CV 2496CC - FORD TRANSIT Caixa (...)</p> <p>d46.5x72mm c61mm 1f-d18mm</p>
	<p><b>S1134</b> NO. 1823769 - 6197149 - 7328510 - 92VB5781AA - 95VB5781AA</p> <p>SILENT-BLOC DAS MOLAS TRASEIRAS (OLHAL DA FRENTE)</p> <p>FORD TRANSIT Autocarro (E_): 2.5 Di (EBS, EDS, EDL, ESS, EUS) 08.1991/07.1994 51KW 70CV 2496CC 4BC 4FA 4CC 0928794 0928797 0928801 0928790 2028347 0928847 - FORD TRANSIT Autocarro (E_): 2.5 Di (EBS, EDS, EGL, ESS, EUS) 09.1991/07.1994 59KW 80CV 2496CC 4DA 0928795 0928798 0928802 0928791 2028348 0928848 0928201 - FORD TRANSIT Autocarro (E_): 2.5 TD (EBS, EBL, ECL, EDS, EDL, ESS, EUS) 10.1992/07....</p> <p>d57x72mm c60mm 1f-d18mm</p>		<p><b>S1134-B</b> NO. 1823769 - 6197149 - 7328510 - 92VB5781AA - 95VB5781AA</p> <p>SILENT-BLOC DAS MOLAS TRASEIRAS (OLHAL DA FRENTE)</p> <p>FORD TRANSIT Autocarro (E_): 2.5 Di (EBS, EDS, EDL, ESS, EUS) 08.1991/07.1994 51KW 70CV 2496CC 4BC 4FA 4CC 0928794 0928797 0928801 0928790 2028347 0928847 - FORD TRANSIT Autocarro (E_): 2.5 Di (EBS, EDS, EGL, ESS, EUS) 09.1991/07.1994 59KW 80CV 2496CC 4DA 0928795 0928798 0928802 0928791 2028348 0928848 0928201 - FORD TRANSIT Autocarro (E_): 2.5 TD (EBS, EBL, ECL, EDS, EDL, ESS, EUS) 10.1992/07....</p> <p>d57x72mm c60mm 1f-d18mm</p>
	<p><b>S1135</b> NO. 1812966 - 6197146 - 92VB5719AA - 6191746</p> <p>SILENT-BLOC DAS MOLAS TRASEIRAS (OLHAL DE TRÁS)</p> <p>FORD TRANSIT Autocarro (E_): 2.5 Di (EBS, EDS, EDL, ESS, EUS) 08.1991/07.1994 51KW 70CV 2496CC 4BC 4FA 4CC 0928794 0928797 0928801 0928790 2028347 0928847 - FORD TRANSIT Autocarro (E_): 2.5 Di (EBS, EDS, EGL, ESS, EUS) 09.1991/07.1994 59KW 80CV 2496CC 4DA 0928795 0928798 0928802 0928791 2028348 0928848 0928201 - FORD TRANSIT Autocarro (E_): 2.5 TD (EBS, EBL, ECL, EDS, EDL, ESS, EUS) 10.1992/07....</p> <p>d50x82mm c61mm 1f-d16mm</p>		<p><b>S1135-B</b> NO. 6197146 - 92VB5719AA - 1812966 - 6191746</p> <p>SILENT-BLOC DAS MOLAS TRASEIRAS (OLHAL DE TRÁS)</p> <p>FORD TRANSIT Autocarro (E_): 2.5 Di (EBS, EDS, EDL, ESS, EUS) 08.1991/07.1994 51KW 70CV 2496CC 4BC 4FA 4CC 0928794 0928797 0928801 0928790 2028347 0928847 - FORD TRANSIT Autocarro (E_): 2.5 Di (EBS, EDS, EGL, ESS, EUS) 09.1991/07.1994 59KW 80CV 2496CC 4DA 0928795 0928798 0928802 0928791 2028348 0928848 0928201 - FORD TRANSIT Autocarro (E_): 2.5 TD (EBS, EBL, ECL, EDS, EDL, ESS, EUS) 10.1992/07....</p> <p>d50x82mm c61mm 1f-d16mm</p>
	<p><b>S1231</b> NO. 1076408 - 1754172 - 6562752 - 92VB-18016AB - 92VB.18016.AB - 97VB1801622 - 97VB18016AA</p> <p>SILENT-BLOCO AMORTECEDOR TRAS ( GASTA 2 UNIDADES )</p> <p>FORD TRANSIT Autocarro (E_): 2.0 09.1991/09.1994 66KW 90CV 1993CC - FORD TRANSIT Autocarro (E_): 2.0 i (EBL, EDL, EGL, ESS, EUS) 09.1991/07.1994 72KW 98CV 1994CC - FORD TRANSIT Autocarro (E_): 2.9 i 01.1991/09.1994 107KW 145CV 2935CC - FORD TRANSIT Autocarro (E_): 2.5 Di (EBS, EDS, EDL, ESS, EUS) 08.1991/07.1994 51KW 70CV 2496CC - FORD TRANSIT Autocarro (E_): 2.5 Di (EBS, EDS, EGL, ESS, ...)</p> <p>d45x40mm c28mm 1f-d12mm</p>		<p><b>S1232</b> NO. 6608818 - 92VB3432AA</p> <p>SILENT-BLOC DO BRAÇO DA SUSPENSÃO FRENTE</p> <p>FORD TRANSIT 2.5D (1983 A 1992) - 2.5Di (1991 A 2000) - 2.5TD (1992 A 1994)</p> <p>d61x52mm d52mm 1f-d16mm</p>
	<p><b>S1233</b> NO. 6517356 - 92VB3069AA</p> <p>SILENT-BLOC DO BRAÇO DA SUSPENSÃO FRENTE</p> <p>FORD TRANSIT 2.5D (1983 A 1992) - 2.5Di (1991 A 2000) - 2.5TD (1992 A 1994)</p> <p>d46x92mm d41mm 1f-d16mm</p>		<p><b>S1258</b> NO. 6154667 - 86VB3069AA - 86VB3069AB</p> <p>SILENT-BLOC DO BRAÇO DA SUSPENSÃO FRENTE INFERIOR</p> <p>FORD TRANSIT Autocarro (T_): 1.6 (TBL, TES) 12.1985/01.1989 46KW 63CV 1593CC LAT 0928607, 0928616 - FORD TRANSIT Autocarro (T_): 2.0 (TBS, TCL, TCS, TEL, TES) 11.1985/09.1992 57KW 78CV 1994CC NAT NAV 0928639, 0928608, 0928617, 0928776, 0928164, 0928166 - FORD TRANSIT Autocarro (T_): 2.5 D (TBS, TCL, TCS, TEL, TES) 12.1985/01.1989 50KW 68CV 2496CC 4AB 0928640, 0928609, 0928618, 0928165, 0928167 ...</p> <p>d41x83mm d37mm 1f-d14mm</p>
	<p><b>S1260</b> NO. 6149013 - 86VB3C716AA</p> <p>SILENT-BLOC DA DIRECÇÃO</p> <p>FORD TRANSIT M12 - M15 - T12 - T15 (APÓS 1991)</p> <p>d29x63mm d25mm 1f-d11mm</p>		<p><b>S1293</b> NO. 1743102 - 4041521 - YC15.5719.AA</p> <p>SILENT-BLOCO MOLA DE TRAS PARTE DE TRAS ( GASTA 2 UNIDADES )</p> <p>FORD TRANSIT Autocarro (FD_ , FB_ , FS_ , FZ_ , FC_ ): 2.0 Di (F_ E_ , F_ F_ , F_ G_ ) 08.2000/05.2006 55KW 75CV 1998CC - FORD TRANSIT Autocarro (FD_ , FB_ , FS_ , FZ_ , FC_ ): 2.0 Di (F_ E_ , F_ F_ , F_ G_ ) 08.2000/05.2006 63KW 86CV 1998CC - FORD TRANSIT Autocarro (FD_ , FB_ , FS_ , FZ_ , FC_ ): 2.0 Di (F_ E_ , F_ F_ , F_ G_ ) 08.2000/05.2006 74KW 100CV 1998CC - FORD TRANSIT Autocarro (FD_ , FB_ )...</p> <p>d51x68mm c61mm 1f-d14mm</p>
	<p><b>S1294</b> NO. 1749786 - 4041523 - 4041524 - 4055743 - YC15.5781.AC - YC15.5781.BB - YC1J-5781-AC</p> <p>SILENT-BLOC DAS MOLAS TRÁS OLHAL TRÁS</p> <p>FORD TRANSIT Autocarro (FD_ , FB_ , FS_ , FZ_ , FC_ ): 2.0 Di (F_ E_ , F_ F_ , F_ G_ ) 08.2000/05.2006 55KW 75CV 1998CC - FORD TRANSIT Autocarro (FD_ , FB_ , FS_ , FZ_ , FC_ ): 2.0 Di (F_ E_ , F_ F_ , F_ G_ ) 08.2000/05.2006 63KW 86CV 1998CC - FORD TRANSIT Autocarro (FD_ , FB_ , FS_ , FZ_ , FC_ ): 2.0 Di (F_ E_ , F_ F_ , F_ G_ ) 08.2000/05.2006 74KW 100CV 1998CC - FORD TRANSIT Autocarro (FD_ , FB_ )...</p> <p>d57x72mm c60mm 1f-d16mm</p>		<p><b>S1349</b> NO. 1495717 - 4042024 - 4372132 - 4540787 - 6C163A262AA - YC153A262AD - YC153A262AE - YC153A262AF</p> <p>SILENT-BLOC DO BRAÇO DA SUSPENSÃO FRENTE</p> <p>FORD TRANSIT 2.0Di (APÓS 08-2000) - 2.0 TDCi (APÓS 08-2002) - 2.4 Di (APÓS 2000) - 2.4 TDE (APÓS 07-2000) - 2.4 TDCi (APÓS 03-2004) - 2.5 Di (1997 A 2000)</p> <p>d66x72mm c40mm 1f-d16mm</p>
	<p><b>S1350</b> NO. 1495713 - 4041450 - 4131788 - 6C163069AA - YC153069AF - YC153069AG</p> <p>SILENT-BLOC</p> <p>FORD TRANSIT 2.0Di (APÓS 08-2000) - 2.0 TDCi (APÓS 08-2002) - 2.4 Di (APÓS 2000) - 2.4 TDE (APÓS 07-2000) - 2.4 TDCi (APÓS 03-2004) - 2.5 Di (1997 A 2000)+F147</p> <p>d44x68mm d38mm 1f-d14mm</p>		<p><b>S1374</b> NO. 1076408 - 97VB18016AA</p> <p>SILENT-BLOC DA SUSPENSÃO DE TRÁS</p> <p>FORD TRANSIT Autocarro (T_): 1.6 (TBL, TES) 12.1985/01.1989 46KW 63CV 1593CC LAT 0928607, 0928616 - FORD TRANSIT Autocarro (T_): 2.0 (TBS, TCL, TCS, TEL, TES) 11.1985/09.1992 57KW 78CV 1994CC NAT NAV 0928639 0928608 0928617 0928776 0928164 0928166 - FORD TRANSIT Autocarro (T_): 2.0 Cat (TBS, TCL, TCS) 12.1985/09.1992 57KW 78CV 1993CC N6T 0928617 0928776 0928164 0928166 - FORD TRANSIT Autocarro (...)</p> <p>d48x40mm d43mm 1f-d12mm</p>

	<b>S1383</b> NO. 1000574 - 6102898 - 6197148 - 80VB5A546AA <b>SILENT-BLOC DO CHASSI</b> FORD TRANSIT Autocarro (E... ) 2.0 (EBL, EBS, ECL, EDS, EDL, EGL, ESS, ESL, EUS) 08.1994/03.2000 84KW 114CV 1998CC NSH NSG NSF 0928288 0928245 0928252 2028375 2028366 0928872 0928878 0928880 0928913 0928924 0928952 0928936 0928940 - FORD TRANSIT Autocarro (E... ) 2.0 CNG 06.1994/03.2000 84KW 114CV 1998CC NSH - FORD TRANSIT Autocarro (E... ) 2.5 DI (EBL, ECL, EDS, EDL) 07.1994/03.2000 56KW 76CV 2496CC...		<b>S1385</b> NO. 2T1418016AA - 4410223 <b>SILENT-BLOCO CASQUILHO AMORTECEDOR TRÁS ( GASTA 4 UNIDADES )</b> FORD TRANSIT CONNECT (P65_ P70_ P80_): 1.8 16V 06.2002/12.2013 85KW 116CV 1796CC - FORD TRANSIT CONNECT (P65_ P70_ P80_): 1.8 Di 06.2002/12.2013 55KW 75CV 1753CC - FORD TRANSIT CONNECT (P65_ P70_ P80_): 1.8 TDCi 06.2002/12.2013 66KW 90CV 1753CC - FORD TRANSIT CONNECT (P65_ P70_ P80_): 1.8 TDCi 08.2006/12.2013 81KW 110CV 1753CC
d47x75mm	c65mm 1f-d16mm	d37x40mm	d34mm 1f-d12mm
	<b>S1386</b> NO. 2T145791AA - 4408458 <b>SILENT-BLOC DAS MOLAS DE TRÁS OLHAL DE TRÁS</b> FORD TRANSIT CONNECT (P65_ P70_ P80_ ) 1.8 16V 06.2002/12.2013 85KW 116CV 1796CC EYPD EYPC EYPA 8566098 8566101 8566AEA 8566AED - FORD TRANSIT CONNECT (P65_ P70_ P80_ ) 1.8 Di 06.2002/12.2013 55KW 75CV 1753CC R2PA P7PB P7PA BHPA 8566099 8566102 8566ADZ 8566AEC 8566ASI 8566ASO - FORD TRANSIT CONNECT (P65_ P70_ P80_ ) 1.8 TDCi 06.2002/12.2013 66KW 90CV 1753CC HCPC HCPD RWPW RWPE P9PD R3PA P9PC P9...		<b>S1387</b> NO. 2T145781AA - 4367046 <b>SILENT-BLOC DAS MOLAS DE TRÁS OLHAL FRENTE</b> FORD TRANSIT CONNECT (P65_ P70_ P80_ ) 1.8 16V 06.2002/12.2013 85KW 116CV 1796CC EYPD EYPC EYPA 8566098 8566101 8566AEA 8566AED - FORD TRANSIT CONNECT (P65_ P70_ P80_ ) 1.8 Di 06.2002/12.2013 55KW 75CV 1753CC R2PA P7PB P7PA BHPA 8566099 8566102 8566ADZ 8566AEC 8566ASI 8566ASO - FORD TRANSIT CONNECT (P65_ P70_ P80_ ) 1.8 TDCi 06.2002/12.2013 66KW 90CV 1753CC HCPC HCPD RWPW RWPE P9PD R3PA P9PC P9...
d37x80mm	d29mm 1f-d14mm	d60x74mm	d54mm 1f-d14mm
	<b>S1388</b> NO. 2T145719BA - 4367044 - 4401266 - 4418511 <b>SILENT-BLOC DAS MOLAS TRÁS OLHAL DE TRÁS</b> FORD TRANSIT CONNECT (P65_ P70_ P80_ ) 1.8 16V 06.2002/12.2013 85KW 116CV 1796CC EYPD EYPC EYPA 8566098 8566101 8566AEA 8566AED - FORD TRANSIT CONNECT (P65_ P70_ P80_ ) 1.8 Di 06.2002/12.2013 55KW 75CV 1753CC R2PA P7PB P7PA BHPA 8566099 8566102 8566ADZ 8566AEC 8566ASI 8566ASO - FORD TRANSIT CONNECT (P65_ P70_ P80_ ) 1.8 TDCi 06.2002/12.2013 66KW 90CV 1753CC HCPC HCPD RWPW RWPE P9PD R3PA P9PC P9...		<b>S1389</b> NO. 2T143063AA - 4366976 <b>SILENT-BLOC DO BRAÇO DA SUSPENSÃO DA FRENTE PARTE INFERIOR</b> FORD TRANSIT CONNECT
d61x74mm	d50mm 1f-d14mm	d50x65mm	d43mm 1f-d14mm
	<b>S1451</b> NO. 1133969 - 1151207 - 1423796 - 154Q10C382AC - 1S4Q.10C382.AB <b>SILENT-BLOC DO ALTERNADOR</b> FORD TRANSIT CONNECT (APÓS 2005)		<b>S1510</b> NO. 1431018 - 1453842 - 1453844 - 1720477 - 6C115719AA - 6C115719AB - 6C115719AA - 6C165781BA <b>SILENTBLOC DA MOLA DE TRÁS</b> FORD TRANSIT Autocarro (FD_ _ FB_ _ FS_ _ FZ_ _ FC_ _ ) 2.2 TDCi 04.2006/08.2014 81KW 110CV 2198CC QVFA 8566AGO 8566AFN 8566AFQ 8566AFT - FORD TRANSIT Autocarro (FD_ _ FB_ _ FS_ _ FZ_ _ FC_ _ ) 2.2 TDCi 10.2011/08.2014 92KW 125CV 2198CC CYFC CYFD CYFB CYFA 8566BDI 8566BDQ 8566BDS 8566BEA 8566BEG 8566BEH - FORD TRANSIT Caixa (FA_ _ ) 2.2 TDCi 04.2006/08.2014 81KW 110CV 2198CC QVFA 8566AGV 8566...
d87x49mm	c30mm 1f-d16,8mm	d66x72mm	c49mm d56mm 1f-d14mm
	<b>S1534</b> NO. 1431019 - 1431020 - 1431075 - 1453842 - 1453843 - 1453844 - 1720481 - 1720483 - 1720485 - 6C115578... <b>SILENTE BLOC DAS MOLAS DE TRÁS</b> FORD TRANSIT Autocarro (FD_ _ FB_ _ FS_ _ FZ_ _ FC_ _ ) 2.2 TDCi 04.2006/08.2014 81KW 110CV 2198CC QVFA 8566AGO 8566AFN 8566AFQ 8566AFT - FORD TRANSIT Autocarro (FD_ _ FB_ _ FS_ _ FZ_ _ FC_ _ ) 2.2 TDCi 10.2011/08.2014 92KW 125CV 2198CC CYFC CYFD CYFB CYFA 8566BDI 8566BDQ 8566BDS 8566BEA 8566BEG 8566BEH - FORD TRANSIT Caixa (FA_ _ ) 2.2 TDCi 04.2006/08.2014 81KW 110CV 2198CC QVFA 8566AGV 8566...		<b>S1623</b> NO. 1420171 - 1526483 - 1526559 - 4855617 - 6C11-5A546-AB - 6C115A546AC - 7250293 - 8C11-5776-AA <b>SILENT-BLOC DAS MOLAS TRÁS BRINCO PARTE SUPERIOR</b> FORD TRANSIT Autocarro (FD_ _ FB_ _ FS_ _ FZ_ _ FC_ _ ): 2.2 TDCi 04.2006/08.2014 63KW 85CV 2198CC - FORD TRANSIT Autocarro (FD_ _ FB_ _ FS_ _ FZ_ _ FC_ _ ): 2.2 TDCi 10.2011/08.2014 74KW 100CV 2198CC - FORD TRANSIT Autocarro (FD_ _ FB_ _ FS_ _ FZ_ _ FC_ _ ): 2.2 TDCi RWD 10.2011/08.2014 74KW 100CV 2198CC - FORD TRANSIT Autocarro (FD_ _ FB_ _ FS_ _ FZ_ _ FC_ _ ): 2.2 TDCi 04.2006/08.2014...
d84x36mm	c29mm d60,5mm 1f-d15,8mm	d46x107mm	d23mm 1f-d14mm
	<b>S1623</b> NO. 1420171 - 1526483 - 1526559 - 4855617 - 6C11-5A546-AB - 6C115A546AC - 7250293 - 8C11-5776-AA <b>SILENT-BLOC DAS MOLAS TRÁS BRINCO PARTE SUPERIOR</b> FORD TRANSIT TOURNEO Autocarro: 2.2 TDCi 07.2006/08.2014 81KW 110CV 2198CC - FORD TRANSIT TOURNEO Autocarro: 2.2 TDCi 10.2008/08.2014 85KW 115CV 2198CC - FORD TRANSIT TOURNEO Autocarro: 2.2 10.2011/08.2014 92KW 125CV 2198CC - FORD TRANSIT TOURNEO Autocarro: 2.2 TDCi 07.2006/08.2014 96KW 131CV 2198CC - FORD TRANSIT TOURNEO Autocarro: 2.2 TDCi 10.2007/08.2014 103KW 140CV 2198CC		<b>S1623</b> NO. 1420171 - 1526483 - 1526559 - 4855617 - 6C11-5A546-AB - 6C115A546AC - 7250293 - 8C11-5776-AA <b>SILENT-BLOC DAS MOLAS TRÁS BRINCO PARTE SUPERIOR</b> FORD TRANSIT V363 Autocarro (FAD, FBD): 2.0 EcoBlue 03.2016/»» 77KW 105CV 1995CC - FORD TRANSIT V363 Autocarro (FAD, FBD): 2.0 EcoBlue 03.2016/»» 96KW 130CV 1995CC - FORD TRANSIT V363 Autocarro (FAD, FBD): 2.0 EcoBlue 03.2016/»» 125KW 170CV 1995CC - FORD TRANSIT V363 Autocarro (FAD, FBD): 2.2 TDCi RWD 08.2013/12.2018 74KW 100CV 2198CC - FORD TRANSIT V363 Autocarro (FAD, FBD): 2.2 TDCi 08.2013/1...
d46x107mm	d23mm 1f-d14mm	d46x107mm	d23mm 1f-d14mm
	<b>S1928</b> NO. 1517518 - 1605790 - 1606826 - 4098237 <b>SILENT-BLOCO CASQUILHO AMORTECEDOR TRÁS ( GASTA 4 UNIDADES )</b> FORD TRANSIT CONNECT V408 Caixa/monovolume 1.0 EcoBoost (De 02.2013 -) 74KW 100cv 998cm3 Caixa/monovolume -		<b>S2057</b> NO. 1806880 - 2246227 - DV613A262AB - DV613A26AC <b>SILENT-BLOC DO BRAÇO SUSPENSÃO DA FRENTE LADO ESQUERDO</b> FORD TRANSIT CONNECT V408 Caixa/monovolume 1.0 EcoBoost (De 02.2013 -) 74KW 100cv 998cm3 Caixa/monovolume - FORD TRANSIT CONNECT V408 Caixa/monovolume 1.5 EcoBlue (De 05.2018 -) 55KW 75cv 1499cm3 Caixa/monovolume - FORD TRANSIT CONNECT V408 Caixa/monovolume 1.5 EcoBlue (De 05.2018 -) 74KW 101cv 1499cm3 Caixa/monovolume - FORD TRANSIT CONNECT V408 Caixa/monovolume 1.5 EcoBlue (De 05.2018 -) 88KW 12...
d31x40mm	d30mm c18mm 1f-d12mm	160x133x65mm	1f-d22mm
	<b>T0033</b> NO. 6150977 - 86VB5484AB <b>BATENTE DA BARRA ESTABILIZADORA</b> FORD TRANSIT MODERNO (APÓS 86)		<b>T0604-I</b> NO. 6142480 - 86VB3020AA <b>BATENTE DA SUSPENSÃO FRENTE</b> FORD TRANSIT M12 - M15 -T12-T15 (APÓS 1991)
40x40x36mm	1f-d16mm	d59x67mm	1f-d30mm 1f-d17mm

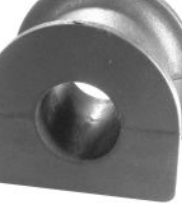

	<p><b>T0609-I</b> NO. 1344760 - 1438211 - 2T145K570B - 2T145K570BA - 2T145K570BB - 2T145K570BC - 4367050 - 4379171 - 4379...</p> <p><b>BATENTE DA SUSPENSÃO DE TRÁS</b></p> <p>FORD TRANSIT CONNECT (P65_ P70_ P80_) 1.8 16V 06.2002/12.2013 85KW 116CV 1796CC EYPD EYPC EYPA 8566098 8566101 8566AEA 8566AED - FORD TRANSIT CONNECT (P65_ P70_ P80_) 1.8 Di 06.2002/12.2013 55KW 75CV 1753CC R2PA P7PB P7PA BHPA 8566099 8566102 8566ADZ 8566AEC 8566ASI 8566ASO - FORD TRANSIT CONNECT (P65_ P70_ P80_) 1.8 TDCi 06.2002/12.2013 66KW 90CV 1753CC HCPC HCPD RWPF RWPE P9PD R3PA P9PC P9...</p> <p>d75x80mm 1f-d14mm 1f-d28mm</p>		<p><b>T0639-I</b> NO. 1C154002BA - 2C114002AA - 3C114002AA - 3C114002BA - 4346508 - 4355664 - 4531298</p> <p><b>BATENTE SUSPENSÃO DE TRÁS</b></p> <p>FORD TRANSIT Autocarro (FD_ FB_ FS_ FZ_ FC_) 2.0 DI (F_E_ F_F_ F_G_) 08.2000/05.2006 55KW 75CV 1998CC D3FA 8566442, 8566444, 8566446, 8566448, 8566450, 8566452, 8566454 - FORD TRANSIT Autocarro (FD_ FB_ FS_ FZ_ FC_) 2.0 DI (F_E_ F_F_ F_G_) 08.2000/05.2006 63KW 86CV 1998CC F3FA 8566465, 8566466, 8566467, 8566468, 8566472, 8566474, 8566473, 8566476 - FORD TRANSIT Auto...</p> <p>d85x96mm 1f-d20mm 1p-d10x17mm</p>
	<p><b>T0640-I</b> NO. 1116577 - 1118919 - 1123541 - 1S713025AB - 1S713025AC - 1S713025AD - 1S7W3025AD - 2T143025AD - 44593</p> <p><b>BATENTE SUSPENSÃO DA FRENTE</b></p> <p>FORD TRANSIT CONNECT (P65_ P70_ P80_) 1.8 16V (06.02 A 12.13) 116cv 1796cc Caixa - FORD TRANSIT CONNECT (P65_ P70_ P80_) 1.8 Di (06.02 A 12.13) 75cv 1753cc Caixa - FORD TRANSIT CONNECT (P65_ P70_ P80_) 1.8 TDCi (06.02 A 12.13) 90cv 1753cc Caixa - FORD TRANSIT CONNECT (P65_ P70_ P80_) 1.8 TDCi (08.06 A 12.13) 110cv 1753cc Caixa</p> <p>d69x69mm 1f-d28mm 1f-d28mm</p>		<p><b>T0670-I</b> NO. 1383523 - 4041449 - 6C113025AB - YC153025AC</p> <p><b>BATENTE SUSPENSÃO DA FRENTE</b></p> <p>FORD TRANSIT Autocarro 2.2 TDCi (04.06 - 08.14) 85cv 2198cc Autocarro - FORD TRANSIT Autocarro 2.2 TDCi (10.11 - 08.14) 100cv 2198cc Autocarro - FORD TRANSIT Autocarro 2.2 TDCi (04.06 - 08.14) 110cv 2198cc Autocarro - FORD TRANSIT Autocarro 2.2 TDCi (10.08 - 08.14) 115cv 2198cc Autocarro - FORD TRANSIT Autocarro 2.2 TDCi (10.11 - 08.14) 125cv 2198cc Autocarro - FORD TRANSIT Autocarro 2.2 TDCi (04....</p> <p>d65x105mm 1f-d30mm 1f-d22mm</p>
	<p><b>T0671-I</b> NO. 1388271 - 1434150 - 1466436 - 6C11-18045-YF - 6C113025BC</p> <p><b>BATENTE SUSPENSÃO DA FRENTE</b></p> <p>FORD TRANSIT Autocarro 2.2 TDCi (04.06 - 08.14) 85cv 2198cc Autocarro - FORD TRANSIT Autocarro 2.2 TDCi (10.11 - 08.14) 100cv 2198cc Autocarro - FORD TRANSIT Autocarro 2.2 TDCi (04.06 - 08.14) 110cv 2198cc Autocarro - FORD TRANSIT Autocarro 2.2 TDCi (10.08 - 08.14) 115cv 2198cc Autocarro - FORD TRANSIT Autocarro 2.2 TDCi (10.11 - 08.14) 125cv 2198cc Autocarro - FORD TRANSIT Autocarro 2.2 TDCi (04....</p> <p>d65x105mm 1f-d30mm 1f-d27mm</p>		<p><b>T0672-I</b> NO. BK213025AA</p> <p><b>BATENTE SUSPENSÃO DA FRENTE</b></p> <p>FORD TRANSIT</p> <p>d64x85mm 1f-d31mm 1f-d31mm</p>
	<p><b>T0673-I</b> NO. 1804552 - BK213025BA - BK213025BB</p> <p><b>BATENTE SUSPENSÃO DA FRENTE</b></p> <p>FORD TRANSIT 2 TON</p> <p>d65x80mm 1f-d31mm 1f-d32mm</p>		<p><b>T0676-I</b> NO. 040605027 - 1327526 - 1330184 - 1349805 - 1923654 - 2154867 - 40605027 - 493770050 - 49377005...</p> <p><b>BATENTE APOIO DE SUSPENSÃO FRENTE ( GASTA 2 UNIDADES )</b></p> <p>FORD TRANSIT Autocarro 2.4 TDCi (03.04 A 05.06) 137cv 2402cc Autocarro - FORD TRANSIT Caixa 2.4 TDCi (03.04 A 05.06) 137cv 2402cc Caixa - FORD TRANSIT Camião de plataforma/chassis 2.4 TDCi (03.04 A 05.06) 137cv 2402cc Camião de plataforma/chassis</p> <p>d55x47mm 1f-d26mm 1p-d8x18mm</p>
	<p><b>T0747-I</b> NO. 1818479 - BK314002AC - 1763818 - 1789643 - 1809792 - 1817421 - 1817422 - 1866686 - 1866886 - 2038129...</p> <p><b>BATENTE DA SUSPENSÃO DE TRÁS</b></p> <p>FORD TRANSIT CUSTOM V362 Autocarro (F3) 2.0 EcoBlue 12.2015/12.2023 77KW 105CV 1995CC BJFA YLFB YLFA BJFB YLFB YLFS 8566BRW 8566BMW - FORD TRANSIT CUSTOM V362 Autocarro (F3) 2.0 EcoBlue 12.2015/12.2023 96KW 130CV 1995CC BKFA YMFA YMF6 BKFB YMF6 YMF5 8566BMX - FORD TRANSIT CUSTOM V362 Autocarro (F3) 2.0 EcoBlue 12.2015/12.2023 125KW 170CV 1995CC YNFA BLFB YNFB YNF6 BLFA YNFS 8566BMY - FORD TRANSIT ...</p> <p>d100x105mm 1f-d12mm 1f-d26mm</p>		<p><b>T1041</b> NO. 6521812 - 92VB5484BA</p> <p><b>BATENTE DA BARRA ESTABILIZADORA (FRENTE CENTRO)</b></p> <p>FORD TRANSIT Autocarro (E_) 2.0 09.1991/09.1994 66KW 90CV 1993CC NBA - FORD TRANSIT Autocarro (E_) 2.0 (EBL, EDL, EGL, ESS, EUS) 09.1991/07.1994 72KW 98CV 1994CC NCA 0928793 0928796 0928800 0928789 2028346 0928846 0928200 - FORD TRANSIT Autocarro (E_) 2.5 DI (EBS, EDS, EDL, ESS, EUS) 08.1991/07.1994 51KW 70CV 2496CC 4BC 4FA 4CC 0928794 0928797 0928801 0928790 2028347 0928847 - FORD TRANSIT...</p> <p>39x39x36mm 1f-d20mm</p>
	<p><b>T1043</b> NO. 6521811 - 92VB5484AA</p> <p><b>BATENTE DA BARRA ESTABILIZADORA (CENTRO FRENTE)</b></p> <p>FORD TRANSIT M12 - T12</p> <p>39x39x36mm 1f-d18mm</p>		<p><b>T1046</b> NO. 6141942 - 86VB.5484.BA</p> <p><b>BATENTE DA BARRA ESTABILIZADORA TRÁS</b></p> <p>FORD TRANSIT M15 2.5TD</p> <p>70x50x58mm 1f-d30mm</p>
	<p><b>T1046-C</b> NO. 4041491 - 6141942 - 86VB.5484.BA - YC15.5486.AA</p> <p><b>BATENTE DA BARRA ESTABILIZADORA TRÁS(COMPLETO)</b></p> <p>FORD TRANSIT M12 - M15 (APÓS 1986) - V184 (2001)</p> <p>142x64x61mm 1f-d31mm</p>		<p><b>T1074</b> NO. 3C11.5484.CB - 4041489 - YC15.5484AC</p> <p><b>BATENTE DA BARRA ESTABILIZADORA DA FRENTE</b></p> <p>FORD TRANSIT Autocarro (FD_ FB_ FS_ FZ_ FC_) 2.0 DI (F_E_ F_F_ F_G_) 08.2000/05.2006 55KW 75CV 1998CC D3FA 8566442 8566444 8566446 8566448 8566450 8566452 8566454 - FORD TRANSIT Autocarro (FD_ FB_ FS_ FZ_ FC_) 2.0 DI (F_E_ F_F_ F_G_) 08.2000/05.2006 63KW 86CV 1998CC F3FA 8566465 8566466 8566467 8566468 8566472 8566474 8566473 8566476 - FORD TRANSIT Autocarro (FD_.....</p> <p>52x50x36mm 1f-d24mm</p>
	<p><b>T1089</b> NO. 4041490 - YC155484BD</p> <p><b>BATENTE DA BARRA ESTABILIZADORA DE TRÁS</b></p> <p>FORD TRANSIT Autocarro (FD_ FB_ FS_ FZ_ FC_) 2.3 16V RWD (F_B_ F_C_ F_A_) 08.2000/05.2006 107KW 146CV 2295CC E5FC E5FA 8566084 8566426 8566424 8566428 8566430 8566434 8566439 - FORD TRANSIT Autocarro (FD_ FB_ FS_ FZ_ FC_) 2.4 TDE 03.2004/05.2006 85KW 115CV 2402CC CXFA 8566120 8566555 8566557 8566559 8566561 8566563 8566565 8566568 - FORD TRANSIT Autocarro (FD_ FB_ ...</p> <p>70x62x50mm 1f-d29mm</p>		<p><b>T1097</b> NO. 2T144037AC - 2T144A037AC - 4379900 - 4419557</p> <p><b>BATENTE DA BARRA ESTABILIZADORA DE TRÁS</b></p> <p>FORD TRANSIT CONNECT (APÓS 2002)</p> <p>49x46x42mm 1f-d22mm</p>

	<p><b>T1098</b> NO. 2T14.5484.CA - 2T145484BD - 4385316 - 4419559 - 4964972</p> <p>BATENTE DA BARRA ESTABILIZADORA DA FRENTE</p> <p>FORD TRANSIT CONNECT</p> <p>49x46x42mm 1f-26x21mm</p>		<p><b>T1186</b> NO. 2T144A037DC - 4367068 - 4382950 - 4419558</p> <p>BATENTE DA BARRA ESTABILIZADORA DE TRÁS</p> <p>FORD TRANSIT CONNECT (P65_ - P70_ - P80_) 1.8 16V (De 06-2002 Até 12-2013) 85kW 116CV 1796cc Caixa FORD TRANSIT CONNECT (P65_ - P70_ - P80_) 1.8 Di (De 06-2002 Até 12-2013) 55kW 75CV 1753cc Caixa FORD TRANSIT CONNECT (P65_ - P70_ - P80_) 1.8 TDCi (De 06-2002 Até 12-2013) 66kW 90CV 1753cc Caixa FORD TRANSIT CONNECT (P65_ - P70_ - P80_) 1.8 TDCi (De 08-2006 Até 12-2013) 81kW 110CV 1753cc Caixa FORD ...</p> <p>45x44x51mm 1f-d22mm</p>
	<p><b>T1221</b> NO. 1810326</p> <p>BATENTE DA BARRA ESTABILIZADORA DA FRENTE</p> <p>FORD TRANSIT CONNECT Combi 1.5 TDCi (De 05.2015 -) 74kW 101cv 1499cm3 Combi - FORD TRANSIT CONNECT Combi 1.5 TDCi (De 05.2015 -) 88kW 120cv 1499cm3 Combi - FORD TRANSIT CONNECT Combi 1.6 TDCi (De 02.2013 -) 55kW 75cv 1560cm3 Combi - FORD TRANSIT CONNECT Combi 1.6 TDCi (De 02.2013 -) 70kW 95cv 1560cm3 Combi - FORD TRANSIT CONNECT Combi 1.6 TDCi (De 02.2013 -) 85kW 115cv 1560cm3 Combi - FORD TRANSIT...</p> <p>44x47x52mm 1f-d23mm</p>		<p><b>T1222</b> NO. 1892600</p> <p>BATENTE DA BARRA ESTABILIZADORA DE TRÁS</p> <p>FORD TRANSIT V363 Caixa (FCD, FDD) 2.2 TDCi (De 08.2013 -) 74kW 100cv 2198cm3 Caixa FORD TRANSIT V363 Caixa (FCD, FDD) 2.2 TDCi (De 08.2013 -) 92kW 125cv 2198cm3 Caixa - FORD TRANSIT V363 Caixa (FCD, FDD) 2.2 TDCi (De 08.2013 -) 114kW 155cv 2198cm3 Caixa - FORD TRANSIT V363 Caixa (FCD, FDD) 2.2 TDCi 4x4 (De 08.2013 -) 92kW 125cv 2198cm3 Caixa - FORD TRANSIT V363 Caixa (FCD, FDD) 2.2 TDCi 4x4 (De 08...</p> <p>53x53x56mm 1f-d30mm</p>
	<p><b>T1223</b> NO. 1892602</p> <p>BATENTE DA BARRA ESTABILIZADORA DE TRÁS</p> <p>FORD TRANSIT V363 Autocarro (FAD, FBD) 2.2 TDCi (De 08.2013 -) 74kW 100cv 2198cm3 Autocarro - FORD TRANSIT V363 Autocarro (FAD, FBD) 2.2 TDCi (De 08.2013 -) 92kW 125cv 2198cm3 Autocarro - FORD TRANSIT V363 Autocarro (FAD, FBD) 2.2 TDCi (De 12.2014 -) 114kW 155cv 2198cm3 Autocarro - FORD TRANSIT V363 Autocarro (FAD, FBD) 2.2 TDCi 4x4 (De 08.2013 -) 92kW 125cv 2198cm3 Autocarro - FORD TRANSIT V363 A...</p> <p>53x51x55mm 1f-d23mm</p>		<p><b>U0304</b> NO. 6609198 - 92VB5349AB</p> <p>ANILHA SUSPENSÃO</p> <p>FORD TRANSIT T12 - T15 (APÓS 1991)</p> <p>d160x37mm 1f-d87mm</p>
	<p><b>U7001</b> NO. 71VB-7K520</p> <p>TAPA FURO</p> <p>FORD TRANSIT DZ</p> <p>126x92x12mm</p>		<p><b>U7005</b> NO. 6191553 - 88VB7W262AB</p> <p>SUPORTE DO FOLE ALAVANCA VELOCIDADES</p> <p>FORD TRANSIT M15 - T12 - T15 (APÓS 1991)</p> <p>175x172x53mm</p>
	<p><b>U7033K</b> NO. 1212679 - 1212679 - 1332662 - 1474287 - 1S7C-3334-AA - 3M51-3334-AA</p> <p>ORINGS BOMBA DIREÇÃO ASSITIDA</p> <p>FORD TRANSIT Autocarro (FD_ _ FB_ _ FS_ _ FZ_ _ FC_ _ ) 2.2 TDCi (04.2006 -08.2014) 96kw 130cv 2198cm3 Autocarro FORD TRANSIT Autocarro (FD_ _ FB_ _ FS_ _ FZ_ _ FC_ _ ) 2.2 TDCi (10.2007 -08.2014) 103kw 140cv 2198cm3 Autocarro FORD TRANSIT Autocarro (FD_ _ FB_ _ FS_ _ FZ_ _ FC_ _ ) 2.2 TDCi (04.2006 -08.2014) 63kw 85cv 2198cm3 Autocarro FORD TRANSIT Autocarro (FD_ _ FB_ _ FS_ _ FZ_ _ FC_ _ ) 2.2 TDCi (04.2006 -08.2014) 92kw 125cv 2198cm3 Caixa ...</p> <p>d11x2mm d10x2mm 1f-d7mm 1f-d6mm</p>		<p><b>U7033K</b> NO. 1212679 - 1212679 - 1332662 - 1474287 - 1S7C-3334-AA - 3M51-3334-AA</p> <p>ORINGS BOMBA DIREÇÃO ASSITIDA</p> <p>FORD TRANSIT Caixa (FA_ _ ) 2.2 TDCi (04.2006 -08.2014) 63kw 85cv 2198cm3 Caixa FORD TRANSIT Caixa (FA_ _ ) 2.2 TDCi (10.2011 -08.2014) 74kw 100cv 2198cm3 Caixa FORD TRANSIT Caixa (FA_ _ ) 2.2 TDCi (04.2006 -08.2014) 81kw 110cv 2198cm3 Caixa FORD TRANSIT Caixa (FA_ _ ) 2.2 TDCi (10.2008 -08.2014) 85kw 115cv 2198cm3 Caixa FORD TRANSIT Caixa (FA_ _ ) 2.2 TDCi (10.2011 -08.2014) 92kw 125cv 2198cm3 Caixa ...</p> <p>d11x2mm d10x2mm 1f-d7mm 1f-d6mm</p>
	<p><b>U7033K</b> NO. 1212679 - 1212679 - 1332662 - 1474287 - 1S7C-3334-AA - 3M51-3334-AA</p> <p>ORINGS BOMBA DIREÇÃO ASSITIDA</p> <p>FORD TRANSIT Camião de plataforma/chassis (FM_ _ FN_ _ FF_ _ ) 2.2 TDCi (04.2006 -08.2014) 63kw 85cv 2198cm3 Camião de plataforma/chassis FORD TRANSIT Camião de plataforma/chassis (FM_ _ FN_ _ FF_ _ ) 2.2 TDCi (10.2011 -08.2014) 74kw 100cv 2198cm3 Camião de plataforma/chassis FORD TRANSIT Camião de plataforma/chassis (FM_ _ FN_ _ FF_ _ ) 2.2 TDCi (04.2006 -08.2014) 81kw 110cv 2198cm3 Camião de...</p> <p>d11x2mm d10x2mm 1f-d7mm 1f-d6mm</p>		<p><b>UAP81313</b> NO. 1364301 - 4M5Q9M577AA</p> <p>ANILHA PROTEÇÃO TÉRMICA INJECTORES</p> <p>FORD TRANSIT CONNECT (P65_ P70_ P80_) 1.8 TDCi 08.2006/12.2013 81KW 110CV 1753CC RWPB RWPC RWPD RWPA 8566AJQ 8566AJR 8566ASK 8566ASQ</p> <p>d13x2mm 1f-d7mm</p>
	<p><b>UAP83244</b> NO. 1230952 - 1432205 - 3M5QE568AA - M5Q9E568CA</p> <p>ANILHA PROTEÇÃO TÉRMICA INJECTORES</p> <p>FORD TRANSIT CONNECT Combi 1.5 TDCi (De 05-2015 Até 1-20 -) 74kW 101CV 1499cc Combi FORD TRANSIT CONNECT Combi 1.5 TDCi (De 05-2015 Até 1-20 -) 88kW 120CV 1499cc Combi FORD TRANSIT CONNECT Caixa 1.5 TDCi (De 08-2015 Até 1-20 -) 55kW 75CV 1499cc Caixa FORD TRANSIT CONNECT Caixa 1.5 TDCi (De 05-2015 Até 1-20 -) 74kW 101CV 1499cc Caixa FORD TRANSIT CONNECT Caixa 1.5 TDCi (De 05-2015 Até 1-20 -) ...</p> <p>d15x2mm 1f-d7mm</p>		<p><b>UAP83252</b> NO. 1700379 - AV6Q9E568AA</p> <p>ANILHA PROTEÇÃO TÉRMICA INJECTORES</p> <p>FORD TRANSIT CONNECT V408 Caixa/monovolume 1.6 TDCi (02.2013 -) 55kw 75cv 1560cm3 Caixa/monovolume FORD TRANSIT CONNECT V408 Caixa/monovolume 1.6 TDCi (02.2013 -) 85kw 115cv 1560cm3 Caixa/monovolume FORD TRANSIT CONNECT Veiculo multiuso 1.6 TDCi (02.2013 -) 55kw 75cv 1560cm3 Veiculo multiuso FORD TRANSIT CONNECT Veiculo multiuso 1.6 TDCi (02.2013 -) 85kw 115cv 1560cm3 Veiculo multiuso</p> <p>d15x2mm 1f-d6mm</p>
	<p><b>UAP83252</b> NO. 1700379 - AV6Q9E568AA</p> <p>ANILHA PROTEÇÃO TÉRMICA INJECTORES</p> <p>FORD TRANSIT COURIER B460 Caixa/monovolume 1.6 TDCi (02.2014 -) 70kw 95cv 1560cm3 Caixa/monovolume FORD TRANSIT COURIER B460 Veiculo multiuso 1.6 TDCi (02.2014 -) 70kw 95cv 1560cm3 Veiculo multiuso</p> <p>d15x2mm 1f-d6mm</p>		<p><b>UAP83252</b> NO. 1118410 - YS4Q9E568AA</p> <p>ANILHA PROTEÇÃO TÉRMICA INJECTORES</p> <p>FORD TRANSIT CONNECT (P65_ P70_ P80_) 1.8 TDCi 06.2002/12.2013 66KW 90CV 1753CC HCPD HCPD RWPF RWPE P9PD R3PA P9PC P9PB P9PA HCPB HCPA 8566100 8566103 8566AEB 8566AEE 8566ASJ 8566ASP</p> <p>d16x1mm 1f-d7mm</p>



	<p><b>URTE6021</b> NO. 1490305 - 8C1R-3K169-AA</p> <p>RETENTOR VEIO DIFERENCIAL TRANSMISSÃO D44X60/67,2X13MM</p> <p>FORD TRANSIT CONNECT V408 Caixa/monovolume 1.0 EcoBoost desde 02.2013 74KW 100CV 998CC M2GA M2GB B3GA 8566BHA</p>		<p><b>URTE6021</b> NO. 1490305 - 8C1R-3K169-AA</p> <p>RETENTOR VEIO DIFERENCIAL TRANSMISSÃO D44X60/67,2X13MM</p> <p>FORD TRANSIT CONNECT V408 Caixa/monovolume 1.0 EcoBoost desde 02.2013 74KW 100CV 998CC M2GA M2GB B3GA 8566BHA</p>
	<p><b>URTE6021</b> NO. 1490305 - 8C1R-3K169-AA</p> <p>RETENTOR VEIO DIFERENCIAL TRANSMISSÃO D44X60/67,2X13MM</p> <p>FORD TRANSIT COURIER B460 Caixa/monovolume 1.0 EcoBoost desde 02.2014 74KW 100CV 998CC SFCE SFCD SFCC SFCB SFCA SFCF 8566BII - FORD TRANSIT COURIER B460 Veiculo multiuso 1.0 EcoBoost desde 02.2014 74KW 100CV 998CC SFCE SFCD SFCC SFCB SFCA 8566BII</p>		<p><b>URTE6021</b> NO. 1490305 - 8C1R-3K169-AA</p> <p>RETENTOR VEIO DIFERENCIAL TRANSMISSÃO D44X60/67,2X13MM</p> <p>FORD TRANSIT COURIER B460 Caixa/monovolume 1.0 EcoBoost desde 02.2014 74KW 100CV 998CC SFCE SFCD SFCC SFCB SFCA SFCF 8566BII - FORD TRANSIT COURIER B460 Veiculo multiuso 1.0 EcoBoost desde 02.2014 74KW 100CV 998CC SFCE SFCD SFCC SFCB SFCA 8566BII</p>
	<p><b>UTR0630</b> NO. 6045648</p> <p>TAMPÃO RADIADOR</p> <p>FORD TRANSIT Caixa (V_) 2.5 D (VVL) (De 1983.10 Até 1986.10) 50kW 68cv 2496cm3 Caixa - FORD TRANSIT Camião de plataforma/chassis (V_) 2.5 D (VGL, VSL, VTL, VCS, VDS) (De 1983.10 Até 1986.10) 50kW 68cv 2496cm3 Camião de plataforma/chassis - FORD TRANSIT Autocarro (T_) 1.6 (TBL, TES) (De 1985.12 Até 1989.01) 46kW 63cv 1593cm3 Autocarro - FORD TRANSIT Autocarro (T_) 2.0 (T...) d59/78x29mm d38x25mm</p>		<p><b>UTR0631</b> NO. 1508310 - 1613291 - 623086 - 78GB8100AC - ERS34</p> <p>TAMPÃO RADIADOR</p> <p>FORD TRANSIT Autocarro (V_) D (De 1983.10 Até 1986.10) 50kW 68cv 2496cm3 Autocarro - FORD TRANSIT Caixa (V_) 1.6 (WS) (De 1977.11 Até 1986.10) 48kW 65cv 1593cm3 Caixa - FORD TRANSIT Caixa (V_) 2.5 D (VVL) (De 1983.10 Até 1986.10) 50kW 68cv 2496cm3 Caixa - FORD TRANSIT Camião de plataforma/chassis (V_) 2.5 D (VGL, VSL, VTL, VCS, VDS) (De 1983.10 Até 1986.10) 50kW 68cv ... d59/79x29mm d38x26mm</p>
	<p><b>UTR0819</b> NO. 1000249 - 1025558 - 1049625 - 1078160 - 1230968 - 97BB8K218DA - 97BB8K218DB - 97BB8K218DC - 98BB8190...</p> <p>TAMPÃO RESERVATÓRIO LÍQUIDO REFRIGERAÇÃO</p> <p>FORD TRANSIT Autocarro (FD_) (FB_) (FS_) (FZ_) (FC_) 2.0 DI (F_E_) (F_F_) (F_G_) (08.00 A 05.06) 75cv 1998cc Autocarro - FORD TRANSIT Autocarro (FD_) (FB_) (FS_) (FZ_) (FC_) 2.0 DI (F_E_) (F_F_) (F_G_) (08.00 A 05.06) 86cv 1998cc Autocarro - FORD TRANSIT Autocarro (FD_) (FB_) (FS_) (FZ_) (FC_) 2.0 DI (F_E_) (F_F_) (F_G_) (08.00 A 05.06) 100cv 1998cc Autocarro - FORD TRANSIT Autoc...</p>		<p><b>UTR0820</b> NO. 90352470 - 90409256 - 90409257 - 9041032690497472 - 90467473</p> <p>TAMPÃO RESERVATÓRIO LÍQUIDO REFRIGERAÇÃO</p> <p>FORD TRANSIT Autocarro (E_) 2.5 TD (EBS, EBL, ECL, EDS, EDL, ESS, EUS) (10.92 A 07.94) 85cv 2496cc Autocarro - FORD TRANSIT Caixa (E_) 2.5 DI (EAL, EAS) (10.92 A 06.94) 85cv 2496cc Caixa - FORD TRANSIT Camião de plataforma/chassis (E_) 2.5 TD (EME/L/S, ENE/L/S) (11.92 A 08.94) 85cv 2496cc Camião de plataforma/chassis - FORD TRANSIT Autocarro (E_) 2.0 (EBL, EBS, ECL, EDS, EDL, EGL, ES...</p>
	<p><b>UTR0846</b> NO. 1029727 - 7166662 - 95VB8100AD - 95VB8100AE</p> <p>TAMPÃO RESERVATÓRIO LÍQUIDO REFRIGERAÇÃO</p> <p>FORD TRANSIT Autocarro (08.02 A 05.06) 125cv 1998cc Autocarro - FORD TRANSIT Autocarro (E_) 2.5 TD (10.92 A 07.94) 85cv 2496cc Autocarro - FORD TRANSIT Autocarro (E_) 2.5 DI (08.94 A 03.00) 69cv 2496cc Autocarro - FORD TRANSIT Autocarro (E_) 2.5 TD (08.94 A 06.00) 75cv 2496cc Autocarro - FORD TRANSIT Autocarro (E_) 2.5 DI (07.94 A 03.00) 76cv 2496cc Autocarro - FORD TRANSIT Autoc...</p>		<p><b>UTR0847</b> NO. 1224233 - 1301104 - 3M5H8100AC</p> <p>TAMPÃO RESERVATÓRIO LÍQUIDO REFRIGERAÇÃO</p> <p>FORD TRANSIT Autocarro 2.0 TDCi (A Partir de 03.16) 105cv 1995cc Autocarro - FORD TRANSIT Autocarro 2.0 TDCi (A Partir de 03.16) 130cv 1995cc Autocarro - FORD TRANSIT Autocarro 2.0 TDCi (A Partir de 03.16) 170cv 1995cc Autocarro - FORD TRANSIT Autocarro 2.2 TDCi [RWD] (A Partir de 08.13) 100cv 2198cc Autocarro - FORD TRANSIT Autocarro 2.2 TDCi (A Partir de 08.13) 100cv 2198cc Autocarro - ...</p>
	<p><b>UTR0859</b> NO. 1650630 - 94539597 - 96293957 - 96312510 - 96351578 - 96420303 - 96536649</p> <p>TAMPÃO RESERVATÓRIO LÍQUIDO REFRIGERAÇÃO</p> <p>FORD TRANSIT CONNECT (P65_) (P70_) (P80_) 1.8 16V (06.02 A 12.13) 116cv 1796cc Caixa - FORD TRANSIT CONNECT (P65_) (P70_) (P80_) 1.8 DI (06.02 A 12.13) 75cv 1753cc Caixa - FORD TRANSIT CONNECT (P65_) (P70_) (P80_) 1.8 TDCi (06.02 A 12.13) 90cv 1753cc Caixa</p>		<p><b>UTR1402</b> NO. 3966745 - YU5A9K163EA</p> <p>TAMPÃO DEPÓSITO COMBUSTÍVEL</p> <p>FORD TRANSIT Caixa (E_) 2.5 TD (EAS) 06.1994/03.2000 55KW 75CV 2496CC 4HD 4HA 0928274 0928278 0928279</p>
	<p><b>UTV83010</b> NO. 1013938 - 97JM6730BA</p> <p>TAMPÃO VEDAÇÃO BUJÃO</p> <p>FORD TRANSIT Autocarro (FD_) (FB_) (FS_) (FZ_) (FC_) 2.0 DI (F_E_) (F_F_) (F_G_) (De 08-2000 Até 05-2006) 55kW 75CV 1998cc Autocarro FORD TRANSIT Autocarro (FD_) (FB_) (FS_) (FZ_) (FC_) 2.0 DI (F_E_) (F_F_) (F_G_) (De 08-2000 Até 05-2006) 63kW 86CV 1998cc Autocarro FORD TRANSIT Autocarro (FD_) (FB_) (FS_) (FZ_) (FC_) 2.0 DI (F_E_) (F_F_) (F_G_) (De 08-2000 Até 05-20...</p>		<p><b>UTV83012</b> NO. 1457117 - 1657022 - 1663906 - 6093527 - 6186775 - 6732529 - 70TM6730AA - 89FF6730AA</p> <p>TAMPÃO VEDAÇÃO BUJÃO</p> <p>FORD TRANSIT Camião de plataforma/chassis (V_) 1.6 (VCS - VDS) (De 11-1977 Até 10-1986) 48kW 65CV 1593cc Camião de plataforma/chassis FORD TRANSIT Autocarro (T_) 1.6 (TBL - TES) (De 12-1985 Até 01-1989) 46kW 63CV 1593cc Autocarro FORD TRANSIT Autocarro (T_) 2.0 (TBS - TCL - TCS - TEL - TES) (De 11-1985 Até 09-1992) 57kW 78CV 1994cc Autocarro FORD TRANSIT Autocarro (T_) 2.0 Cat (TBS - ...</p>
	<p><b>W5035</b> NO. 1135052</p> <p>POLIE DA CAMBOTA (6 PISTAS)</p> <p>FORD TRANSIT CONNECT 1.8 16V (APÓS 06-2002)</p>		<p><b>W5081</b> NO. 1079166 - 1104415 - 1139286 - 1143413 - 1151392 - 1S4Q6A345AA - 1S4Q6B318AE - 1S4Q6B319AE - 1S4...</p> <p>POLIE DA CAMBOTA (6 PISTAS)</p> <p>FORD TOURNEO CONNECT 1.8 TDCi /TDDi /DI 06.2002/12.2013 55KW 75CV 1753CC P7PA R2PA P7PB BHPA 8566AJJ</p>

	<p><b>W5090</b> NO. 1124891 - 1151394 - 1226637 - 1226638 - 1315530 - 1329203 - 1329205 - 1349993 - 1351731 - 1...</p> <p>POLIE DA CAMBOTA (6 PISTAS)</p> <p>FORD TRANSIT 2.0 TDCi (APÓS 08-2002)</p> <p>d160mm d5mm</p>		<p><b>W5100</b> NO. 1372756 - 1376475 - 1386188 - 1387095 - 1425511 - 1434432 - 1539837 - 1697695 - 1723700 - 1731716 - ...</p> <p>POLIE DA CAMBOTA</p> <p>FORD TRANSIT 2.2 TDCi</p> <p>d159.8-139.8mm d59mm</p>
	<p><b>W5112</b> NO. 0516.K2 - 1379766 - 1425511 - 1697695 - 1727140 - 1748942 - 6C1Q6B319EA - BK2Q6A345AA - BK3Q6B319...</p> <p>POLIE DA CAMBOTA (7 PISTAS)</p> <p>FORD TRANSIT Autocarro - 2.4 TDCi, 100CV 2402cc (APÓS 04-2006) - 115CV 2402cc (APÓS 04-2006) - 140CV 2402cc (APÓS 04-2006) - 2.4 TDCi 4X4 140CV 2402cc (APÓS 11-2006)</p> <p>d167mm 3f-d13mm</p>		<p><b>W5112</b> NO. 0516.K2 - 1379766 - 1425511 - 1697695 - 1727140 - 1748942 - 6C1Q6B319EA - BK2Q6A345AA - BK3Q6B319...</p> <p>POLIE DA CAMBOTA (7 PISTAS)</p> <p>FORD TRANSIT Caixa 2.4 TDCi 100CV 2402cc (APÓS 04-2006) - 115CV 2402cc (APÓS 04-2006) - 140CV 2402cc (APÓS 04-2006) - 2.4 TDCi 4X4 140CV 2402cc (APÓS 11-2006)</p> <p>d167mm 3f-d13mm</p>
	<p><b>W5112</b> NO. 0516.K2 - 13779766 - 1379766 - 1425511 - 1697695 - 1727140 - 1748942 - 6C1Q6B319EA - BK2Q6A345AA ...</p> <p>POLIE DA CAMBOTA (7 PISTAS)</p> <p>FORD TRANSIT Camião de plataforma - chassis - 2.4 TDCi 100CV 2402cc (APÓS 04-2006) - 115CV 2402cc (APÓS 04-2006) - 140CV 2402cc (APÓS 04-2006)</p> <p>d167mm 3f-d13mm</p>		<p><b>W5112</b> NO. 1386188 - 1425511 - 1434432 - 1539837 - 1697695 - 1723700 - 6C1Q6B319AD - 6C1Q6B319AE - 6C1Q6B319AF</p> <p>POLIE DA CAMBOTA (6+4 PISTAS)</p> <p>FORD TRANSIT Autocarro 2.2 TDCi 85CV 2198cc (APÓS 04-2006) 100CV 2198cc (APÓS 10-2011) - FORD TRANSIT Autocarro - 2.2 TDCi (RWD) 100CV 2198cc (APÓS 10-2011) - 2.2 TDCi 110CV 2198cc (APÓS 04-2006) - 115CV 2198cc (APÓS 10-2008) - 125CV 2198cc (APÓS 10-2011)</p> <p>d167mm 3f-d13mm</p>
	<p><b>W5113</b> NO. 1386188 - 1425511 - 1434432 - 1539837 - 1697695 - 1723700 - 6C1Q6B319AD - 6C1Q6B319AE - 6C1Q6B319AF</p> <p>POLIE DA CAMBOTA (6+4 PISTAS)</p> <p>FORD TRANSIT TOURNEO - 2.2 TDCi Autocarro 110CV 2198cc (APÓS 07-2006) - 115CV 2198cc (APÓS 10-2008) - 131CV 2198cc (APÓS 07-2006) - 140CV 2198cc (APÓS 10-2007)</p> <p>d167mm 3f-d13mm</p>		<p><b>W5113</b> NO. 1386188 - 1425511 - 1434432 - 1539837 - 1697695 - 1723700 - 6C1Q6B319AD - 6C1Q6B319AE - 6C1Q6B319AF</p> <p>POLIE DA CAMBOTA (6+4 PISTAS)</p> <p>FORD TRANSIT CAIXA 2.2 TDCi 85CV 2198cc (APÓS 04-2006) - 100CV 2198cc (APÓS 10-2011) - FORD TRANSIT Caixa 2.2 TDCi (RWD) 100CV 2198cc (APÓS 10-2011) - 110CV 2198cc (APÓS 04-2006) - 115CV 2198cc (APÓS 10-2008) - 125CV 2198cc (APÓS 10-2011) - 125CV 2198cc</p> <p>d167mm 3f-d13mm</p>
	<p><b>W5113</b> NO. 1386188 - 1425511 - 1434432 - 1539837 - 1697695 - 1723700 - 6C1Q6B319AD - 6C1Q6B319AE - 6C1Q6B319AF</p> <p>POLIE DA CAMBOTA (6+4 PISTAS)</p> <p>FORD TRANSIT Camião de plataforma - chassis 2.2 TDCi 85CV 2198cc (APÓS 04-2006) - 100CV 2198cc (APÓS 10-2011) - 2.2 TDCi (RWD) 100CV 2198cc (APÓS 10-2011) - 110CV 2198cc (APÓS 04-2006) - 115CV 2198cc (APÓS 10-2008) - 125CV 2198cc (APÓS 10-2011) - 2.2 TDCi</p> <p>d167mm 3f-d13mm</p>		<p><b>W5113</b> NO. 1386188 - 1425511 - 1434432 - 1539837 - 1697695 - 1723700 - 6C1Q6B319AD - 6C1Q6B319AE - 6C1Q6B319AF</p> <p>POLIE DA CAMBOTA (6+4 PISTAS)</p> <p>FORD TRANSIT CUSTOM Caixa 2.2 TDCi 100CV 2198cc (APÓS 12-2012) - 125CV 2198cc (APÓS 12-2012) - 155CV 2198cc (APÓS 12-2012)</p> <p>d167mm 3f-d13mm</p>
	<p><b>W5116</b> NO. 1088891 - 1226639 - 1329202 - 1377588 - 1675115 - 1708966 - 4C106B319AA - 4C1Q6B319BA - 9C1Q6...</p> <p>POLIE DA CAMBOTA (7 PISTAS)</p> <p>FORD TRANSIT AUTOCARRO (E) 2.5 TD (10-1992 A 07-1994) 85CV 2496CC - FORD TRANSIT CAIXA (E) 2.5 DI (10-1992 A 06-1994) 85CV 2496CC - FORD TRANSIT AUTOCARRO (FD FB FS FZ FC) 2.4 DI (01-2000 A 05-2006) 75CV 2402CC - FORD TRANSIT AUTOCARRO (FD FB FS FZ FC)</p> <p>d167mm 3f-d13mm</p>		<p><b>W5116</b> NO. 1088891 - 1226639 - 1329202 - 1377588 - 1675115 - 1708966 - 4C106B319AA - 4C1Q6B319BA - 9C1Q6...</p> <p>POLIE DA CAMBOTA (7 PISTAS)</p> <p>FORD TRANSIT CAIXA (FA) 2.4 DI (RWD) (01-2000 A 05-2006) 75CV 2402CC - FORD TRANSIT CAIXA (FA) 2.4 DI (01-2000 A 05-2006) 90CV 2402CC - FORD TRANSIT CAIXA (FA) 2.4 TDE (03-2004 A 05-2006) 115CV 2402CC - FORD TRANSIT CAIXA (FA) 2.4 DI (RWD) (01-2000 A 05-</p> <p>d167mm 3f-d13mm</p>
	<p><b>W5116</b> NO. 1088891 - 1226639 - 1329202 - 1377588 - 1675115 - 1708966 - 4C106B319AA - 4C1Q6B319BA - 9C1Q6...</p> <p>POLIE DA CAMBOTA (7 PISTAS)</p> <p>FORD TRANSIT CAMIAO PLATAFORMA (FM FN) 2.4 DI (01-2000 A 05-2006) 75CV 2402CC - FORD TRANSIT CAMIAO PLATAFORMA (FM FN) 2.4 DI (01-2000 A 05-2006) 90CV 2402CC - FORD TRANSIT CAMIAO PLATAFORMA (FM FN) 2.4 TDE (03-2004 A 05-2006) 115CV 2402CC - FORD TRANSIT</p> <p>d167mm 3f-d13mm</p>		<p><b>W5139</b> NO. 0516.K2 - 1425511 - 1459430 - 1469722 - 1697695 - 1776624 - 7C166B319AB - 7C166B319AC - 7C166B319B...</p> <p>POLIE DA CAMBOTA 7 PISTAS</p> <p>FORD TRANSIT Autocarro 3.2 TDCi (02.08 A 08.14) 200cv 3199cc Autocarro</p> <p>d161mm d13mm</p>
	<p><b>W5156</b> NO. 1042771 - 1050619 - 1050620 - 954F6B319AB - 974F6B319AB</p> <p>POLIE DA CAMBOTA (1+4 PISTAS)</p> <p>FORD TRANSIT Autocarro (E_) 2.5 DI (EBS, EDS, EDL, ESS, EUS) 08.1991/07.1994 51KW 70CV 2496CC 4BC 4FA 4CC 0928794 0928797 0928801 0928790 2028347 0928847 - FORD TRANSIT Autocarro (E_) 2.5 TD (EBS, EBL, ECL, EDS, EDL, ESS, EUS) 10.1992/07.1994 63KW 85CV 2496CC 4GA 0928227 2028350 0928863 0928828 0928829 0928830 0928827 - FORD TRANSIT Autocarro (E_) 2.5 TD (ECL, EDS, EDL, EGL, ESS, EUS) 09.199...</p> <p>d152mm d50mm</p>		<p><b>W5189</b> NO. 1372740 - 6C1Q-3A733-AA - 9658102080</p> <p>POLIE DA BOMBA DIREÇÃO (4 PISTAS)</p> <p>FORD TRANSIT Autocarro (FD_) 2.2 TDCi 04.2006/08.2014 63KW 85CV 2198CC - FORD TRANSIT Autocarro (FD_) 2.2 TDCi 10.2011/08.2014 74KW 100CV 2198CC - FORD TRANSIT Autocarro (FD_) 2.2 TDCi 04.2006/08.2014 81KW 110CV 2198CC - FORD TRANSIT Autocarro (FD_) 2.2 TDCi 10.2008/08.2014 8...</p> <p>d132mm 1f-d25mm 1f-d30mm 3f-d8mm</p>

	<p><b>Y3235</b> NO. 1370439 - 4038464 - 4048803 - 4395255 - 4424984</p> <p>PARAFUSO DA RODA CAVILHA M14X1,50X35MM</p> <p>FORD TRANSIT Caixa (FA_...) 2.2 TDCi (04.2006 -08.2014) 81kw 110cv 2198cm3 Caixa FORD TRANSIT Caixa (FA_...) 2.2 TDCi (10.2011 -08.2014) 92kw 125cv 2198cm3 Caixa</p>		<p><b>Y3235</b> NO. 1370439 - 4038464 - 4048803 - 4395255 - 4424984</p> <p>PARAFUSO DA RODA CAVILHA M14X1,50X35MM</p> <p>FORD TRANSIT V363 Autocarro (FAD, FBD) 2.2 TDCi (08.2013 -12.2018) 92kw 125cv 2198cm3 Autocarro FORD TRANSIT V363 Autocarro (FAD, FBD) 2.2 TDCi (12.2014 -12.2018) 114kw 155cv 2198cm3 Autocarro FORD TRANSIT V363 Autocarro (FAD, FBD) 2.2 TDCi RWD (08.2013 -12.2018) 114kw 155cv 2198cm3 Autocarro FORD TRANSIT V363 Caixa (FCD, FDD) 2.2 TDCi (08.2013 -12.2018) 92kw 125cv 2198cm3 Caixa FORD TRANSIT V363 ...</p>
	<p><b>Z50130</b> NO. 11589289</p> <p>MOLA REBITE FIXAÇÃO</p> <p>FORD TRANSIT COURIER B460 Caixa/monovolume 1.0 EcoBoost (02.2014 -12.2023) 74kw 100cv 998cm3 Caixa/monovolume FORD TRANSIT COURIER B460 Caixa/monovolume 1.5 EcoBlue (04.2018 -12.2023) 74kw 100cv 1499cm3 Caixa/monovolume FORD TRANSIT COURIER B460 Caixa/monovolume 1.5 TDCi (02.2014 -12.2023) 55kw 75cv 1499cm3 Caixa/monovolume FORD TRANSIT COURIER B460 Caixa/monovolume 1.5 TDCi (05.2015 -12.2023) 70k...</p>		<p><b>Z50130</b> NO. 11589289</p> <p>MOLA REBITE FIXAÇÃO</p> <p>FORD TRANSIT CUSTOM V362 Autocarro (F3) 1.0 EcoBoost PHEV (04.2020 -12.2023) 92kw 125cv 996cm3 Autocarro FORD TRANSIT CUSTOM V362 Autocarro (F3) 2.0 EcoBlue (12.2015 -12.2023) 125kw 170cv 1995cm3 Autocarro FORD TRANSIT CUSTOM V362 Autocarro (F3) 2.0 EcoBlue (05.2019 -12.2023) 136kw 185cv 1995cm3 Autocarro FORD TRANSIT CUSTOM V362 Autocarro (F3) 2.0 EcoBlue (12.2015 -12.2023) 77kw 105cv 1995cm3 Aut...</p>
	<p><b>Z80733</b> NO. 4069907</p> <p>Mola de fixação</p> <p>FORD TRANSIT</p>		<p><b>Z80734</b> NO. 4069906</p> <p>Mola de fixação</p> <p>FORD TRANSIT</p>
	<p><b>Z9005</b> NO. 1640227 - 6156718 - 6688870</p> <p>MOLA DE ESCAPE</p> <p>FORD TRANSIT (1991 A 1994)</p>		

## FORD TRANSIT TRANSIT TOURNEO TRANSIT CUSTOM TORNEO CUSTOM

	<p><b>A1381</b> NO. 6094239 - 6120493 - 6122229 - 6141919 - 83BB.5K817.BA</p> <p>APOIO AS SUSPENSÃO DE TRÁS</p> <p>FORD TRANSIT Autocarro (E_...) 2.9 i 01.1991/09.1994 107KW 145CV 2935CC BRT</p>		<p><b>A1387</b> NO. 1061194 - 1070136 - 98AB8125EC</p> <p>APOIO SUPORTE RADIADOR INFERIOR/SUPERIOR</p> <p>FORD TRANSIT CONNECT (P65_, P70_, P80_) 1.8 16V 06.2002/12.2013 85KW 116CV 1796CC EYPD EYPC EYPA 8566098 8566101 8566AEA 8566AED - FORD TRANSIT CONNECT (P65_, P70_, P80_) 1.8 Di 06.2002/12.2013 55KW 75CV 1753CC R2PA P7PB P7PA BHPA 8566099 8566102 8566ADZ 8566AEC 8566ASI 8566ASO - FORD TRANSIT CONNECT (P65_, P70_, P80_) 1.8 TDCi 06.2002/12.2013 66KW 90CV 1753CC HCPC HCPD RWPF RWPE P9PD R3PA P9PC P9...</p>
	<p><b>A1822</b> NO. 1454284 - 1690298 - 1801350 - 3M517M121JC - AV617M121CB - AV617M121CC</p> <p>APOIO DA CAIXA DE VELOCIDADES</p> <p>FORD TRANSIT</p>		<p><b>A1822</b> NO. 1454284 - 1690298 - 1801350 - 3M517M121JC - AV617M121CB - AV617M121CC</p> <p>APOIO DA CAIXA DE VELOCIDADES</p> <p>FORD TOURNEO</p>
	<p><b>A1830</b> NO. 1201167 - 1351703 - 2T1Q.9A393.AA - 2T1Q9A393AB - 2T1Q9A393AA</p> <p>APOIO SUPORTE RADIADOR</p> <p>FORD TRANSIT CONNECT (P65_, P70_, P80_) : 1.8 Di 06.2002/12.2013 55KW 75CV 1753CC - FORD TRANSIT CONNECT (P65_, P70_, P80_) : 1.8 TDCi 06.2002/12.2013 66KW 90CV 1753CC</p>		<p><b>A2348</b> NO. 1771505 - 1895282 - BK21-6F012-AD - BK21-6F012-AE</p> <p>APOIO MOTOR DIREITO HIDRAULICO</p> <p>FORD TRANSIT CUSTOM V362 Autocarro (F3) 2.0 EcoBlue 12.2015/12.2023 77KW 105CV 1995CC BJFA YLFB YLFA BJFB YLFB YLFS 8566BRW 8566BMW - FORD TRANSIT CUSTOM V362 Autocarro (F3) 2.0 EcoBlue 12.2015/12.2023 96KW 130CV 1995CC BKFA YMFA YMFB BKFB YMF6 YMFS 8566BMX - FORD TRANSIT CUSTOM V362 Autocarro (F3) 2.0 EcoBlue 12.2015/12.2023 125KW 170CV 1995CC YNFA BLFB YNFB YNF6 BLFA YNFS 8566BMY - FORD TRANSIT ...</p>

	<p><b>A2363</b> NO. 1485355 - 1494924 - 6C11-6068-BB - 6C11-6068-CB - 7C19-6068-CA</p> <p>APOIO CAIXA VELOCIDADES S/ PINO GUIA</p> <p>FORD TRANSIT Autocarro (FD_., FB_., FS_., FZ_., FC_.) 2.4 DI (F_B_., F_C_., F_A_) (De 01.2000 Até 05.2006) 66kW 90cv 2402cm3 Autocarro - FORD TRANSIT Autocarro (FD_., FB_., FS_., FZ_., FC_.) 2.4 DI RWD (F_B_., F_C_) (De 01.2000 Até 05.2006) 55kW 75cv 2402cm3 Autocarro - FORD TRANSIT Autocarro (FD_., FB_., FS_., FZ_., FC_.) 2.4 DI RWD (F_B_., F_C_., F_A_) (De 01.2000 Até 05.2006) 88kW 120...</p> <p>168x79x66mm 1f-d10mm 2r-d10mm</p>		<p><b>A2484</b> NO. 1437544 - 1437545 - 1798908</p> <p>APOIO DO MOTOR LADO ESQUERDO</p> <p>FORD TRANSIT</p> <p>228x157x62mm 1f-d14mm 4f-16x20mm</p>
	<p><b>A2484</b> NO. 1437544 - 1437545 - 1798908</p> <p>APOIO DO MOTOR LADO ESQUERDO</p> <p>FORD TOURNEO</p> <p>228x157x62mm 1f-d14mm 4f-16x20mm</p>		<p><b>A2489</b> NO. 1771507 - 1774601 - 1840043 - BK217M124AC - BK217M124AD - BK217M124BA</p> <p>APOIO DO MOTOR LADO ESQUERDO CAIXA VELOCIDADES</p> <p>FORD TOURNEO CUSTOM V362 Autocarro (F3): 2.2 TDCi 04.2012/12.2015 74KW 100CV 2198CC - FORD TOURNEO CUSTOM V362 Autocarro (F3): 2.2 TDCi 04.2012/12.2015 92KW 125CV 2198CC - FORD TOURNEO CUSTOM V362 Autocarro (F3): 2.2 TDCi 04.2012/12.2015 114KW 155CV 2198CC</p> <p>171x177x111mm 4f-d12mm 2r-d10mm 2f-17x22mm</p>
	<p><b>A2489</b> NO. 1840043 - BK217M124AD - BK217M124BA</p> <p>APOIO DO MOTOR LADO ESQUERDO CAIXA VELOCIDADES</p> <p>FORD TRANSIT CUSTOM V362 Autocarro (F3): 2.2 TDCi 04.2012/12.2015 74KW 100CV 2198CC - FORD TRANSIT CUSTOM V362 Autocarro (F3): 2.2 TDCi 04.2012/12.2015 92KW 125CV 2198CC - FORD TRANSIT CUSTOM V362 Autocarro (F3): 2.2 TDCi 04.2012/12.2015 114KW 155CV 2198CC - FORD TRANSIT CUSTOM V362 Caixa (FY, FZ): 2.0 EcoBlue 12.2015/»» 77KW 105CV 1995CC - FORD TRANSIT CUSTOM V362 Caixa (FY, FZ): 2.0 EcoBlue 12....</p> <p>171x177x111mm 4f-d12mm 2r-d10mm 2f-17x22mm</p>		<p><b>A2489</b> NO. 1840043 - BK217M124AD - BK217M124BA</p> <p>APOIO DO MOTOR LADO ESQUERDO CAIXA VELOCIDADES</p> <p>FORD TRANSIT V363 Caixa (FCD, FDD): 2.2 TDCi 08.2013/12.2018 74KW 100CV 2198CC - FORD TRANSIT V363 Caixa (FCD, FDD): 2.2 TDCi 08.2013/12.2018 92KW 125CV 2198CC - FORD TRANSIT V363 Caixa (FCD, FDD): 2.2 TDCi RWD 08.2013/12.2018 92KW 125CV 2198CC - FORD TRANSIT V363 Caixa (FCD, FDD): 2.2 TDCi 08.2013/12.2018 114KW 155CV 2198CC - FORD TRANSIT V363 Camião de plataforma/chassis (FED, FFD): 2.2 TDCi 08....</p> <p>171x177x111mm 4f-d12mm 2r-d10mm 2f-17x22mm</p>
	<p><b>B404</b> NO. 1388244 - 2193360 - 6C11-5705-DA - 6C1Z-5705-A - CK4Z-5705-A</p> <p>ABRAÇADEIRA DE MOLA TRÁS ( GASTA 2 UNIDADES )</p> <p>FORD TRANSIT Autocarro (FD_., FB_., FS_., FZ_., FC_.) 2.2 TDCi 04.2006/08.2014 81KW 110CV 2198CC QVFA 8566AGO 8566AFN 8566AFQ 8566AFT - FORD TRANSIT Autocarro (FD_., FB_., FS_., FZ_., FC_.) 2.2 TDCi 10.2011/08.2014 92KW 125CV 2198CC CYFC CYFD CYFB CYFA 8566BDI 8566BDQ 8566BDS 8566BEA 8566BEG 8566BEH</p> <p>158x106x13mm 2p-d14x58mm</p>		<p><b>B404</b> NO. 1388244 - 2193360 - 6C11-5705-DA - 6C1Z-5705-A - CK4Z-5705-A</p> <p>ABRAÇADEIRA DE MOLA TRÁS ( GASTA 2 UNIDADES )</p> <p>FORD TRANSIT TOURNEO Autocarro 2.2 10.2011/08.2014 92KW 125CV 2198CC CYFB CYFA CYFC CYFD - FORD TRANSIT TOURNEO Autocarro 2.2 TDCi 07.2006/08.2014 81KW 110CV 2198CC QVFA 8566AFB - FORD TRANSIT TOURNEO Autocarro 2.2 TDCi 07.2006/08.2014 96KW 131CV 2198CC QWFA 8566AFC - FORD TRANSIT TOURNEO Autocarro 2.2 TDCi 10.2007/08.2014 103KW 140CV 2198CC UHF PGFB UHFB UHFA PGFA 8566AMJ - FORD TRANSIT TOURNEO ...</p> <p>158x106x13mm 2p-d14x58mm</p>
	<p><b>D0055</b> NO. 2L1W4684AA - 4165078</p> <p>CARDAN TRANSMISSÃO</p> <p>FORD TRANSIT Autocarro (FD_., FB_., FS_., FZ_., FC_.) 2.0 DI (F_E_., F_F_., F_G_) (De 08-2000 Até 05-2006) 55kW 75CV 1998cc Autocarro FORD TRANSIT Autocarro (FD_., FB_., FS_., FZ_., FC_.) 2.0 DI (F_E_., F_F_., F_G_) (De 08-2000 Até 05-2006) 63kW 86CV 1998cc Autocarro FORD TRANSIT Autocarro (FD_., FB_., FS_., FZ_., FC_.) 2.0 DI (F_E_., F_F_., F_G_) (De 08-2000 Até 05-...</p> <p>160x152x43x25mm 6f-d14mm</p>		<p><b>E0008</b> NO. 0801909 - 1591419 - 6030483 - 70GB5281AA - 801909</p> <p>ESTICADOR DE ESCAPE</p> <p>FORD TRANSIT</p> <p>d44x40mm</p>
	<p><b>E0258</b> NO. 1513343 - 1745924 - 1790310 - 1905043 - 8V51.3B438.BA - 8V51.3B438.BB - 8V51.3B438AB - D65134170</p> <p>ESTICADOR BARRA ESTABILIZADORA FRENTE ( GASTA 2 UNIDADES )</p> <p>FORD TOURNEO COURIER B460 Kombi: 1.0 EcoBoost 02.2014/»» 74KW 100CV 998CC - FORD TOURNEO COURIER B460 Kombi: 1.5 TDCi 02.2014/»» 55KW 75CV 1499CC - FORD TOURNEO COURIER B460 Kombi: 1.5 TDCi 05.2015/»» 70KW 95CV 1499CC - FORD TOURNEO COURIER B460 Kombi: 1.5 EcoBlue 04.2018/»» 74KW 100CV 1499CC - FORD TOURNEO COURIER B460 Kombi: 1.6 TDCi 02.2014/»» 70KW 95CV 1560CC</p> <p>290x36x35mm 2p-d10x25mm</p>		<p><b>E0625-M</b> NO. 1771506 - 1786184 - 2015369 - BK216P082AC - BK216P082AD - BK216P082AE</p> <p>ESTICADOR SUPORTE APOIO MOTOR TRAS</p> <p>FORD TRANSIT CUSTOM V362 Autocarro (F3): 2.0 EcoBlue 12.2015/»» 77KW 105CV 1995CC - FORD TRANSIT CUSTOM V362 Autocarro (F3): 2.0 EcoBlue 12.2015/»» 96KW 130CV 1995CC - FORD TRANSIT CUSTOM V362 Autocarro (F3): 2.2 TDCi 04.2012/12.2015 74KW 100CV 2198CC - FORD TRANSIT CUSTOM V362 Autocarro (F3): 2.2 TDCi 04.2012/12.2015 92KW 125CV 2198CC - FORD TRANSIT CUSTOM V362 Autocarro (F3): 2.2 TDCi 04.2012/...</p> <p>390x132x42mm 1f-d14mm 1f-d14mm</p>
	<p><b>E0625-M</b> NO. 1771506 - 1786184 - 2015369 - BK216P082AC - BK216P082AD - BK216P082AE</p> <p>ESTICADOR SUPORTE APOIO MOTOR TRAS</p> <p>FORD TOURNEO CUSTOM V362 Autocarro (F3): 2.0 EcoBlue 12.2015/»» 77KW 105CV 1995CC - FORD TOURNEO CUSTOM V362 Autocarro (F3): 2.0 EcoBlue 12.2015/»» 96KW 130CV 1995CC - FORD TOURNEO CUSTOM V362 Autocarro (F3): 2.0 EcoBlue 12.2015/»» 125KW 170CV 1995CC - FORD TOURNEO CUSTOM V362 Autocarro (F3): 2.2 TDCi 04.2012/12.2015 74KW 100CV 2198CC - FORD TOURNEO CUSTOM V362 Autocarro (F3): 2.2 TDCi 04.2012/...</p> <p>390x132x42mm 1f-d14mm 1f-d14mm</p>		<p><b>E1018</b> NO. 1027374 - 6831302 - 6866417 - 93B85A262F - 93B85A262G - 93B85A262GA</p> <p>ESTICADOR DE ESCAPE</p> <p>FORD TRANSIT</p> <p>66x54x19mm</p>
	<p><b>E1070</b> NO. 1003890 - 1016405 - 1099277 - 1118218</p> <p>ESTICADOR DE ESCAPE</p> <p>FORD TRANSIT</p> <p>70x50x27mm</p>		<p><b>E80344BC</b> NO. 6567507 - 924F9740AA</p> <p>ESTICADOR BOMBA DE COMBUSTIVEL</p> <p>FORD TRANSIT Autocarro (E_.) 2.0 (EBL, EBS, ECL, EDS, EDL, EGL, ESS, ESL, EUS) (08.1994 -03.2000) 84kw 114cv 1998cm3 Autocarro FORD TRANSIT Autocarro (E_.) 2.0 CNG (06.1994 -03.2000) 84kw 114cv 1998cm3 Autocarro FORD TRANSIT Autocarro (E_.) 2.5 DI (EBL, ECL, EDS, EDL) (07.1994 -03.2005) 56kw 76cv 2496cm3 Autocarro FORD TRANSIT Autocarro (E_.) 2.5 DI (EBL, EDL, EDS, ESL, ESS) (08.1997 -03.2000) ...</p> <p>371x11x10mm</p>

	<p><b>E80344BC</b> NO. 6567507 - 924F9740AA</p> <p><b>ESTICADOR BOMBA DE COMBUSTIVEL</b></p> <p>FORD TRANSIT Caixa (E_) 2.0 (EAL, EAS) (06.1994 -03.2000) 84kw 114cv 1998cm3 Caixa FORD TRANSIT Caixa (E_) 2.5 DI (EAL, EAS) (06.1994 -03.2000) 51kw 69cv 2496cm3 Caixa FORD TRANSIT Caixa (E_) 2.5 DI (EAL, EAS) (06.1994 -03.2000) 56kw 76cv 2496cm3 Caixa FORD TRANSIT Caixa (E_) 2.5 DI (EAL, EAS) (05.1999 -03.2000) 85kw 116cv 2496cm3 Caixa FORD TRANSIT Caixa (E_) 2.5 TD (EAL, EAS) (06.1994 ...</p> <p>371x11x10mm</p>		<p><b>E80344BC</b> NO. 6567507 - 924F9740AA</p> <p><b>ESTICADOR BOMBA DE COMBUSTIVEL</b></p> <p>FORD TRANSIT Camião de plataforma/chassis (E_) 2.0 (EME/L/S,ENE/L/S) (08.1994 - 03.2000) 84kw 114cv 1998cm3 Camião de plataforma/chassis FORD TRANSIT Camião de plataforma/chassis (E_) 2.5 DI (EME/L/S,ENE/L/S) (08.1994 -03.2000) 56kw 76cv 2496cm3 Camião de plataforma/chassis FORD TRANSIT Camião de plataforma/chassis (E_) 2.5 DI (EML, ENE/L) (05.1999 -03.2000) 85kw 116cv 2496cm3 Camião de plat...</p> <p>371x11x10mm</p>
	<p><b>F1652-T</b> NO. 1763990</p> <p><b>FOLE DA DIREÇÃO LADO DIREITO E ESQUERDO</b></p> <p>FORD TOURNEO CUSTOM V362 Autocarro (F3) 2.0 EcoBlue (De 12.2015 -) 77kW 105cv 1995cm3 Autocarro - FORD TOURNEO CUSTOM V362 Autocarro (F3) 2.0 EcoBlue (De 12.2015 -) 96kW 130cv 1995cm3 Autocarro - FORD TOURNEO CUSTOM V362 Autocarro (F3) 2.0 EcoBlue (De 12.2015 -) 125kW 170cv 1995cm3 Autocarro - FORD TOURNEO CUSTOM V362 Autocarro (F3) 2.2 TDCi (De 04.2012 -) 74kW 100cv 2198cm3 Autocarro - FORD TOURNEO...</p> <p>d58x180mm 1f-d16mm 1f-d50mm</p>		<p><b>F1652-T</b> NO. 1763990</p> <p><b>FOLE DA DIREÇÃO LADO DIREITO E ESQUERDO</b></p> <p>FORD TRANSIT CUSTOM V362 Autocarro (F3) 2.0 EcoBlue (De 12.2015 -) 77kW 105cv 1995cm3 Autocarro - FORD TRANSIT CUSTOM V362 Autocarro (F3) 2.0 EcoBlue (De 12.2015 -) 96kW 130cv 1995cm3 Autocarro - FORD TRANSIT CUSTOM V362 Autocarro (F3) 2.0 EcoBlue (De 12.2015 -) 125kW 170cv 1995cm3 Autocarro - FORD TRANSIT CUSTOM V362 Autocarro (F3) 2.2 TDCi (De 04.2012 -) 74kW 100cv 2198cm3 Autocarro - FORD TRANSIT...</p> <p>d58x180mm 1f-d16mm 1f-d50mm</p>
	<p><b>F4239</b> NO. YC1R7277AD</p> <p><b>FOLE ALAVANCA VELOCIDADES</b></p> <p>FORD TRANSIT Autocarro (FD_) (FB_) (FS_) (FZ_) (FC_) 2.0 DI (F_E_) (F_F_) (F_G_) 55kW 75cv 1998cm3 Autocarro - FORD TRANSIT Autocarro (FD_) (FB_) (FS_) (FZ_) (FC_) 2.0 DI (F_E_) (F_F_) (F_G_) (De 08.2000 Até 05.2006) 63kW 86cv 1998cm3 Autocarro - FORD TRANSIT Autocarro (FD_) (FB_) (FS_) (FZ_) (FC_) 2.0 DI (F_E_) (F_F_) (F_G_) (De 08.2000 Até 05.2006) 74kW 100cv 1998cm3 Autocarro - FORD...</p> <p>236x196x101mm 1f-92x120mm</p>		<p><b>F4239</b> NO. YC1R7277AD</p> <p><b>FOLE ALAVANCA VELOCIDADES</b></p> <p>FORD TRANSIT Caixa (FA_) 2.0 DI (FAE_) (FAF_) (FAG_) (De 08.2000 Até 05.2006) 55kW 75cv 1998cm3 Caixa - FORD TRANSIT Caixa (FA_) 2.0 DI (FAE_) (FAF_) (FAG_) (De 08.2000 Até 05.2006) 63kW 86cv 1998cm3 Caixa - FORD TRANSIT Caixa (FA_) 2.0 DI (FAE_) (FAF_) (FAG_) (De 08.2000 Até 05.2006) 74kW 100cv 1998cm3 Caixa - FORD TRANSIT Caixa (FA_) 2.0 TDCi (De 08.2002 Até 05.2006) 92kW 125cv 1998cm3 Caixa - ...</p> <p>236x196x101mm 1f-92x120mm</p>
	<p><b>F4239</b> NO. YC1R7277AD</p> <p><b>FOLE ALAVANCA VELOCIDADES</b></p> <p>FORD TRANSIT Camião de plataforma/chassis (FM_) (FN_) 2.0 DI (F_E_) (F_F_) (De 08.2000 Até 05.2006) 55kW 75cv 1998cm3 Camião de plataforma/chassis - FORD TRANSIT Camião de plataforma/chassis (FM_) (FN_) 2.0 DI (F_E_) (F_F_) (De 08.2000 Até 05.2006) 63kW 86cv 1998cm3 Camião de plataforma/chassis - FORD TRANSIT Camião de plataforma/chassis (FM_) (FN_) 2.0 DI (F_E_) (F_F_) (De 08.2000 Até 05.2006) 74kW 100cv 1998cm3 Camião de plataforma/chassis - FORD...</p> <p>236x196x101mm 1f-92x120mm</p>		<p><b>F4242</b> NO. 1441578 - 1484968 - 6C11-7B118-AEYYJV</p> <p><b>FOLE ALAVANCA VELOCIDADES</b></p> <p>FORD TRANSIT Autocarro (FD_) (FB_) (FS_) (FZ_) (FC_) 2.2 TDCi (De 04.2006 Até 08.2014) 63kW 85cv 2198cm3 Autocarro - FORD TRANSIT Autocarro (FD_) (FB_) (FS_) (FZ_) (FC_) 2.2 TDCi (De 10.2011 Até 08.2014) 74kW 100cv 2198cm3 Autocarro - FORD TRANSIT Autocarro (FD_) (FB_) (FS_) (FZ_) (FC_) 2.2 TDCi (De 04.2006 Até 08.2014) 81kW 110cv 2198cm3 Autocarro - FORD TRANSIT Autocarro (FD_) (FB_) (FS_) (FZ_) (FC_) 2.2 TDCi (De 10.2011 Até 08.2014) 92kW 125cv 2198cm3 Caixa FORD TRANSIT CU...</p> <p>140x138x135mm 1f-119x118mm</p>
	<p><b>F4242</b> NO. 1441578 - 1484968 - 6C11-7B118-AEYYJV</p> <p><b>FOLE ALAVANCA VELOCIDADES</b></p> <p>FORD TRANSIT TOURNEO Autocarro 2.2 (De 10.2011 Até 08.2014) 92kW 125cv 2198cm3 Autocarro - FORD TRANSIT TOURNEO Autocarro 2.2 TDCi (De 07.2006 Até 08.2014) 81kW 110cv 2198cm3 Autocarro - FORD TRANSIT TOURNEO Autocarro 2.2 TDCi (De 10.2008 Até 08.2014) 85kW 115cv 2198cm3 Autocarro - FORD TRANSIT TOURNEO Autocarro 2.2 TDCi (De 07.2006 Até 08.2014) 96kW 131cv 2198cm3 Autocarro - FORD TRANSIT TOURNEO...</p> <p>140x138x135mm 1f-119x118mm</p>		<p><b>F4372</b> NO. 6C1R7C453ND - 1778122 - 1417417 - 1417410 - 1417449</p> <p><b>FOLE DA ALAVANCA VELOCIDADES C/MANETE PUNHO TOPO COMPLETO 6 VELOCIDADES</b></p> <p>FORD TRANSIT CUSTOM V362 Autocarro (F3) 2.2 TDCi (09.2012 -12.2015) 74kw 100cv 2198cm3 Autocarro FORD TRANSIT CUSTOM V362 Autocarro (F3) 2.2 TDCi (09.2012 -12.2015) 92kw 125cv 2198cm3 Autocarro FORD TRANSIT CUSTOM V362 Autocarro (F3) 2.2 TDCi (09.2012 -12.2015) 114kw 155cv 2198cm3 Autocarro FORD TRANSIT CUSTOM V362 Caixa (FY, FZ) 2.2 TDCi (09.2012 -12.2015) 74kw 100cv 2198cm3 Caixa FORD TRANSIT CU...</p> <p>445x155x150mm xxxx</p>
	<p><b>F4372</b> NO. 6C1R7C453ND - 1778122 - 1417417 - 1417410 - 1417449</p> <p><b>FOLE DA ALAVANCA VELOCIDADES C/MANETE PUNHO TOPO COMPLETO 6 VELOCIDADES</b></p> <p>FORD TRANSIT Caixa (FA_) 2.2 TDCi (10.2011 -08.2014) 74kw 100cv 2198cm3 Caixa FORD TRANSIT Caixa (FA_) 2.2 TDCi (04.2006 -08.2014) 81kw 110cv 2198cm3 Caixa FORD TRANSIT Caixa (FA_) 2.2 TDCi (10.2008 -08.2014) 85kw 115cv 2198cm3 Caixa FORD TRANSIT Caixa (FA_) 2.2 TDCi (10.2011 -08.2014) 92kw 125cv 2198cm3 Caixa FORD TRANSIT Caixa (FA_) 2.2 TDCi (04.2006 -08.2014) 96kw 130cv 2198cm3 Caixa ...</p> <p>445x155x150mm xxxx</p>		<p><b>F4372</b> NO. 6C1R7C453ND - 1778122 - 1417417 - 1417410 - 1417449</p> <p><b>FOLE DA ALAVANCA VELOCIDADES C/MANETE PUNHO TOPO COMPLETO 6 VELOCIDADES</b></p> <p>FORD TRANSIT Camião de plataforma/chassis (FM_) (FN_) (FF_) 2.2 TDCi (04.2006 -08.2014) 63kw 85cv 2198cm3 Camião de plataforma/chassis FORD TRANSIT Camião de plataforma/chassis (FM_) (FN_) (FF_) 2.2 TDCi (10.2011 -08.2014) 74kw 100cv 2198cm3 Camião de plataforma/chassis FORD TRANSIT Camião de plataforma/chassis (FM_) (FN_) (FF_) 2.2 TDCi (04.2006 -08.2014) 81kw 110cv 2198cm3 Camião de...</p> <p>445x155x150mm xxxx</p>
	<p><b>F4372</b> NO. 6C1R7C453ND - 1778122 - 1417417 - 1417410 - 1417449</p> <p><b>FOLE DA ALAVANCA VELOCIDADES C/MANETE PUNHO TOPO COMPLETO 6 VELOCIDADES</b></p> <p>FORD TRANSIT TOURNEO Autocarro 2.2 (10.2011 -08.2014) 92kw 125cv 2198cm3 Autocarro FORD TRANSIT TOURNEO Autocarro 2.2 TDCi (07.2006 -08.2014) 81kw 110cv 2198cm3 Autocarro FORD TRANSIT TOURNEO Autocarro 2.2 TDCi (10.2008 -08.2014) 85kw 115cv 2198cm3 Autocarro FORD TRANSIT TOURNEO Autocarro 2.2 TDCi (07.2006 -08.2014) 96kw 131cv 2198cm3 Autocarro FORD TRANSIT TOURNEO Autocarro 2.2 TDCi (10.2007 -08....</p> <p>445x155x150mm xxxx</p>		<p><b>F4372</b> NO. 6C1R7C453ND - 1778122 - 1417417 - 1417410 - 1417449</p> <p><b>FOLE DA ALAVANCA VELOCIDADES C/MANETE PUNHO TOPO COMPLETO 6 VELOCIDADES</b></p> <p>FORD TRANSIT V363 Autocarro (FAD, FBD) 2.2 TDCi (08.2013 -12.2018) 74kw 100cv 2198cm3 Autocarro FORD TRANSIT V363 Autocarro (FAD, FBD) 2.2 TDCi (08.2013 -12.2018) 92kw 125cv 2198cm3 Autocarro FORD TRANSIT V363 Autocarro (FAD, FBD) 2.2 TDCi (12.2014 -12.2018) 114kw 155cv 2198cm3 Autocarro FORD TRANSIT V363 Autocarro (FAD, FBD) 2.2 TDCi 4x4 (08.2013 -12.2018) 92kw 125cv 2198cm3 Autocarro FORD TRANSIT...</p> <p>445x155x150mm xxxx</p>
	<p><b>KF9037</b> NO. 1514345 - 1426856 - 1534276 - 1595106 - 1727141 - 1727147 - 1774394 - 1787355 - 1794505 - CC11-4C06...</p> <p><b>KIT DE FOLE TRANSMISSÃO LADO DA RODA</b></p> <p>FORD TRANSIT Autocarro (FD_) (FB_) (FS_) (FZ_) (FC_) 2.2 TDCi (De 04.2006 Até 08.2014) 81kW 110cv 2198cm3 Autocarro - FORD TRANSIT Autocarro (FD_) (FB_) (FS_) (FZ_) (FC_) 2.2 TDCi (De 10.2011 Até 08.2014) 92kW 125cv 2198cm3 Autocarro -</p> <p>d118x136mm 1f-d109mm 1f-d29mm</p>		<p><b>KF9037</b> NO. 1514345 - 1426856 - 1534276 - 1595106 - 1727141 - 1727147 - 1774394 - 1787355 - 1794505 - CC11-4C06...</p> <p><b>KIT DE FOLE TRANSMISSÃO LADO DA RODA</b></p> <p>FORD TRANSIT TOURNEO Autocarro 2.2 (De 10.2011 Até 08.2014) 92kW 125cv 2198cm3 Autocarro - FORD TRANSIT TOURNEO Autocarro 2.2 TDCi (De 07.2006 Até 08.2014) 81kW 110cv 2198cm3 Autocarro - FORD TRANSIT TOURNEO Autocarro 2.2 TDCi (De 10.2008 Até 08.2014) 85kW 115cv 2198cm3 Autocarro - FORD TRANSIT TOURNEO Autocarro 2.2 TDCi (De 07.2006 Até 08.2014) 96kW 131cv 2198cm3 Autocarro - FORD TRANSIT TOURNEO...</p> <p>d118x136mm 1f-d109mm 1f-d29mm</p>



	<p><b>KF9037</b> NO. 1514345 - 1426856 - 1534276 - 1595106 - 1727141 - 1727147 - 1774394 - 1787355 - 1794505 - CC11-4C06...</p> <p><b>KIT DE FOLE TRANSMISSÃO LADO DA RODA</b></p> <p>FORD TRANSIT V363 Autocarro (FAD, FBD) 2.2 TDCi (De 08.2013 Até 03.2016) 92kW 125cv 2198cm3 Autocarro - FORD TRANSIT V363 Autocarro (FAD, FBD) 2.2 TDCi (De 12.2014 Até 03.2016) 114kW 155cv 2198cm3 Autocarro - FORD TRANSIT V363 Caixa (FCD, FDD) 2.2 TDCi (De 08.2013 Até 03.2016) 92kW 125cv 2198cm3 Caixa - FORD TRANSIT V363 Caixa (FCD, FDD) 2.2 TDCi (De 08.2013 Até 03.2016) 114kW 155cv 2198cm3 Caixa...</p> <p>d118x136mm 1f-d109mm 1f-d29mm</p>		<p><b>KF9039</b> NO. 1774393 - 1787348 - 1787353 - BK21-4A084-AB - BK21-4C062-AB</p> <p><b>KIT DE FOLE TRANSMISSÃO JUNTO À CAIXA</b></p> <p>FORD TRANSIT TOURNEO Autocarro 2.2 (De 10.2011 Até 08.2014) 92kW 125cv 2198cm3 Autocarro - FORD TRANSIT TOURNEO Autocarro 2.2 TDCi (De 07.2006 Até 08.2014) 81kW 110cv 2198cm3 Autocarro - FORD TRANSIT TOURNEO Autocarro 2.2 TDCi (De 10.2008 Até 08.2014) 85kW 115cv 2198cm3 Autocarro - FORD TRANSIT TOURNEO Autocarro 2.2 TDCi (De 07.2006 Até 08.2014) 96kW 131cv 2198cm3 Autocarro - FORD TRANSIT TOURNEO ...</p> <p>d102x107mm 1f-d91mm 1f-d32mm</p>
	<p><b>L3192</b> NO. 6141550 - 6154614 - 86VB3K132AC - 86VB3K132BA</p> <p><b>CASQUILHO AMORTECEDOR FRENTE OLHAL DUPLA ABA (GASTA 2 UNIDADES)</b></p> <p>FORD TRANSIT Autocarro (T_ ) 1.6 (TBL, TES) (De 12.1985 Até 01.1989) 46kW 63cv 1593cm3 Autocarro - FORD TRANSIT Autocarro (T_ ) 2.0 (TBS, TCL, TCS, TEL, TES) (De 11.1985 Até 09.1992) 57kW 78cv 1994cm3 Autocarro - FORD TRANSIT Autocarro (T_ ) 2.0 Cat (TBS, TCL, TCS) (De 12.1985 Até 09.1992) 57kW 78cv 1993cm3 Autocarro - FORD TRANSIT Autocarro (T_ ) 2.5 D (TBS, TCL, TCS, TEL, TES) (De 12.1985 Até...</p> <p>d70x48mm 1f-d30mm</p>		<p><b>L3192</b> NO. 6141550 - 6154614 - 86VB3K132AC - 86VB3K132BA</p> <p><b>CASQUILHO AMORTECEDOR FRENTE OLHAL DUPLA ABA (GASTA 2 UNIDADES)</b></p> <p>FORD TRANSIT Caixa (T_ ) 1.6 (TAS) (De 09.1985 Até 09.1992) 46kW 63cv 1593cm3 Caixa - FORD TRANSIT Caixa (T_ ) 2.0 (TAL, TAS, TGL, TWS) (De 09.1985 Até 09.1992) 57kW 78cv 1994cm3 Caixa - FORD TRANSIT Caixa (T_ ) 2.5 D (De 10.1985 Até 03.1991) 60kW 82cv 2496cm3 Caixa - FORD TRANSIT Caixa (T_ ) 2.5 D (TAL, TAS, TGL, TWS) (De 01.1986 Até 09.1991) 50kW 68cv 2496cm3 Caixa - FORD TRANSIT Caixa (T_ )...</p> <p>d70x48mm 1f-d30mm</p>
	<p><b>L3192</b> NO. 6141550 - 6154614 - 86VB3K132AC - 86VB3K132BA</p> <p><b>CASQUILHO AMORTECEDOR FRENTE OLHAL DUPLA ABA (GASTA 2 UNIDADES)</b></p> <p>FORD TRANSIT Camião de plataforma/chassis (T_ ) 2.0 (TTE, TTL, TTS) (De 01.1986 Até 09.1992) 57kW 78cv 1994cm3 Camião de plataforma/chassis - FORD TRANSIT Camião de plataforma/chassis (T_ ) 2.0 Cat (TUL) (De 11.1985 Até 09.1992) 57kW 78cv 1993cm3 Camião de plataforma/chassis - FORD TRANSIT Camião de plataforma/chassis (T_ ) 2.5 D (TTL, TTS, TUL, TUS, TTE) (De 01.1986 Até 01.1989) 50kW 68cv 2496...</p> <p>d70x48mm 1f-d30mm</p>		<p><b>P1017</b> NO. 7213141</p> <p><b>CAPA DE PEDAL TRAVAO/EMBRAIAGEM (GASTA 2 UNIDADES)</b></p> <p>FORD TRANSIT Autocarro (FD_ , FB_ , FS_ , FZ_ , FC_ ) : 2.3 16V RWD (F_B_ , F_C_ , F_A_ ) 08.2000/05.2006 107KW 146CV 2295CC</p> <p>67x55x10mm</p>
	<p><b>Q2013</b> NO. 1048510 - 1475481 - 1754892 - 6171239</p> <p><b>UNIÃO DO ESCAPE 60x64,5x90mm</b></p> <p>FORD TRANSIT</p> <p>90x70x92mm 1f-d60mm</p>		<p><b>Q2013</b> NO. 1048510 - 1475481 - 1754892 - 6171239</p> <p><b>UNIÃO DO ESCAPE 60x64,5x90mm</b></p> <p>FORD TOURNEO</p> <p>90x70x92mm 1f-d60mm</p>
	<p><b>R222431</b> NO. 1054149</p> <p><b>TUBO INFERIOR DO RADIADOR</b></p> <p>FORD TRANSIT Autocarro (E_ ) 2.5 DI (EBL, ECL, EDS, EDL) (De 07.1994 Até 03.2000) 56kW 76cv 2496cm3 Autocarro - FORD TRANSIT Autocarro (E_ ) 2.5 DI (EBL, EDL, EDS, ESL, ESS) (De 08.1997 Até 03.2000) 85kW 116cv 2496cm3 Autocarro - FORD TRANSIT Autocarro (E_ ) 2.5 DI (EBL, EDS, ESL, ESS, EUS) (De 08.1994 Até 03.2000) 51kW 69cv 2496cm3 Autocarro - FORD TRANSIT Autocarro (E_ ) 2.5 DI (EBS, EDS, EDL, ESS, EUS) 12.1985/01.1989 50KW 6...</p> <p>B273-d33/d37mm 74-54-84-63mm</p>		<p><b>R222471</b> NO. 1631581 - 6777719 - 86VB18472BA - 92VB18D334CA</p> <p><b>TUBO AQUECIMENTO PERMUTADOR DE CALOR</b></p> <p>FORD TRANSIT Autocarro (E_ ) 2.5 DI (EBS, EDS, EDL, ESS, EUS) 08.1991/07.1994 51KW 70CV 2496CC 4BC 4FA 4CC 0928794 0928797 0928801 0928790 2028347 0928847 - FORD TRANSIT Autocarro (E_ ) 2.5 DI (EBS, EDS, EGL, ESS, EUS) 09.1991/07.1994 59KW 80CV 2496CC 4DA 0928795 0928798 0928802 0928791 2028348 0928848 0928201 - FORD TRANSIT Autocarro (T_ ) 2.5 D (TBS, TCL, TCS, TEL, TES) 12.1985/01.1989 50KW 6...</p> <p>boca a boca555mmd1-31mm2-34mm2-230-103-480-44</p>
	<p><b>R222471</b> NO. 1631581 - 6777719 - 86VB18472BA - 92VB18D334CA</p> <p><b>TUBO AQUECIMENTO PERMUTADOR DE CALOR</b></p> <p>FORD TRANSIT Caixa (E_ ) 2.5 DI (EAL, EAS) 05.1991/06.1994 51KW 70CV 2496CC 4BC 4CC 4FA 2028501 0928193 0928197 - FORD TRANSIT Caixa (E_ ) 2.5 DI (EAS, EAL) 05.1991/06.1994 59KW 80CV 2496CC 4DA 2028502 0928194 0928198 - FORD TRANSIT Caixa (T_ ) 2.5 D (TAL, TAS, TGL, TWS) 01.1986/09.1991 50KW 68CV 2496CC 4AB 0928679 0928155 0928157 0928163 - FORD TRANSIT Caixa (T_ ) 2.5 D (TAL, TAS, TGL, TWS) 1...</p> <p>boca a boca555mmd1-31mm2-34mm2-230-103-480-44</p>		<p><b>R222471</b> NO. 1631581 - 6777719 - 86VB18472BA - 92VB18D334CA</p> <p><b>TUBO AQUECIMENTO PERMUTADOR DE CALOR</b></p> <p>FORD TRANSIT Camião de plataforma/chassis (E_ ) 2.5 DI (EME/L/S,ENE/L/S) (09.1991 - 08.1994) 59kw 80cv 2496cm3 Camião de plataforma/chassis FORD TRANSIT Camião de plataforma/chassis (E_ ) 2.5 DI (EML/S,ENL/S) (09.1991 - 08.1994) 51kw 69cv 2496cm3 Camião de plataforma/chassis FORD TRANSIT Camião de plataforma/chassis (T_ ) 2.5 D (TTL, TTS,TUL, TUS, TTE) (01.1986 -01.1989) 50kw 68cv 2496cm3 Camiã...</p> <p>boca a boca555mmd1-31mm2-34mm2-230-103-480-44</p>
	<p><b>R222491</b> NO. 7221012 - 95VB8K289CE</p> <p><b>TUBO DE LIGAÇÃO DO RADIADOR AO DEPOSITO COMPENSAÇÃO</b></p> <p>FORD TRANSIT Autocarro (E_ ) 2.5 DI (EBS, EDS, EDL, ESS, EUS) 08.1991/07.1994 51KW 70CV 2496CC 4BC 4FA 4CC 0928794 0928797 0928801 0928790 2028347 0928847 - FORD TRANSIT Autocarro (E_ ) 2.5 DI (EBS, EDS, EGL, ESS, EUS) 09.1991/07.1994 59KW 80CV 2496CC 4DA 0928795 0928798 0928802 0928791 2028348 0928848 0928201 - FORD TRANSIT Autocarro (E_ ) 2.5 TD (EBS, EBL, ECL, EDS, EDL, E...</p> <p>B315-20/20mm 108-30-49-105-45mm ch-d66-87-15mm</p>		<p><b>R222491</b> NO. 7221012 - 95VB8K289CE</p> <p><b>TUBO DE LIGAÇÃO DO RADIADOR AO DEPOSITO COMPENSAÇÃO</b></p> <p>FORD TRANSIT Camião de plataforma/chassis (E_ ) 2.5 DI (EME/L/S, ENE/L/S) 09.1991/08.1994 59KW 80CV 2496CC 4DA 0928219 0928222 0928205 0928209 0928213 0928216 - FORD TRANSIT Camião de plataforma/chassis (E_ ) 2.5 DI (EML/S, ENL/S) 09.1991/08.1994 51KW 69CV 2496CC 4BC 4FA 4CC 0928208 0928208 0928212 0928215 - FORD TRANSIT Camião de plataforma/chassis (E_ ) 2.5 TD (EME/L/S, ENE/L) 09.1991/08.1994...</p> <p>B315-20/20mm 108-30-49-105-45mm ch-d66-87-15mm</p>
	<p><b>R224158</b> NO. 6592412 - 914F8K561AB</p> <p><b>TUBO DE LIGAÇÃO AO TERMOSTATO</b></p> <p>FORD TRANSIT Autocarro (E_ ) 2.5 DI (EBS, EDS, EDL, ESS, EUS) 08.1991/07.1994 51KW 70CV 2496CC 4BC 4FA 4CC 0928794 0928797 0928801 0928790 2028347 0928847 - FORD TRANSIT Autocarro (E_ ) 2.5 DI (EBS, EDS, EGL, ESS, EUS) 09.1991/07.1994 59KW 80CV 2496CC 4DA 0928795 0928798 0928802 0928791 2028348 0928848 0928201 - FORD TRANSIT Autocarro (E_ ) 2.5 TD (EBS, EBL, ECL, EDS, EDL, ESS, EUS) 10.1992/07....</p> <p>B260-21/22mm 42x38x39x49x73x46x55x50mm</p>		<p><b>R8194</b> NO. 4053002 - 4081185 - 4494051 - YC159Y438BD - YC159Y438BE - YC59Y14388DA</p> <p><b>TUBO DE LIGAÇÃO AO RADIADOR</b></p> <p>FORD TRANSIT Autocarro (FD_ , FB_ , FS_ , FZ_ , FC_ ) 2.0 DI (F_E_ , F_F_ , F_G_ ) 08.2000/05.2006 55KW 75CV 1998CC D3FA 8566442 8566444 8566446 8566448 8566450 8566452 8566454 - FORD TRANSIT Autocarro (FD_ , FB_ , FS_ , FZ_ , FC_ ) 2.0 DI (F_E_ , F_F_ , F_G_ ) 08.2000/05.2006 63KW 86CV 1998CC F3FA 8566465 8566466 8566467 8566468 8566472 8566474 8566473 8566476 - FORD TRANS...</p> <p>B500-d14/d20mm 105-57-70-103-220-128-57mm</p>



	<p><b>T1223</b> NO. 1892602</p> <p><b>BATENTE DA BARRA ESTABILIZADORA DE TRÁS</b></p> <p>FORD TOURNEO CUSTOM V362 Autocarro (F3) 2.2 TDCi (De 04.2012 -) 74kW 100cv 2198cm3 Autocarro - FORD TOURNEO CUSTOM V362 Autocarro (F3) 2.2 TDCi (De 04.2012 -) 92kW 125cv 2198cm3 Autocarro - FORD TOURNEO CUSTOM V362 Autocarro (F3) 2.2 TDCi (De 04.2012 -) 114kW 155cv 2198cm3 Autocarro -</p> <p>53x51x55mm 1f-d23mm</p>		<p><b>T1223</b> NO. 1892602</p> <p><b>BATENTE DA BARRA ESTABILIZADORA DE TRÁS</b></p> <p>FORD TRANSIT CUSTOM V362 Autocarro (F3) 2.2 TDCi (De 04.2012 -) 74kW 100cv 2198cm3 Autocarro - FORD TRANSIT CUSTOM V362 Autocarro (F3) 2.2 TDCi (De 04.2012 -) 92kW 125cv 2198cm3 Autocarro - FORD TRANSIT CUSTOM V362 Autocarro (F3) 2.2 TDCi (De 04.2012 -) 114kW 155cv 2198cm3 Autocarro - FORD TRANSIT CUSTOM V362 Caixa (FY, FZ) 2.2 TDCi (De 04.2012 -) 74kW 100cv 2198cm3 Caixa - FORD TRANSIT CUSTOM V362...</p> <p>53x51x55mm 1f-d23mm</p>
	<p><b>U7033K</b> NO. 1212679 - 1212679 - 1332662 - 1474287 - 1S7C-3334-AA - 3M51-3334-AA</p> <p><b>ORINGS BOMBA DIREÇÃO ASSITIDA</b></p> <p>FORD TRANSIT V363 Autocarro (FAD, FBD) 2.2 TDCi (08.2013 -12.2018) 74kw 100cv 2198cm3 Autocarro FORD TRANSIT V363 Autocarro (FAD, FBD) 2.2 TDCi (08.2013 -12.2018) 92kw 125cv 2198cm3 Autocarro FORD TRANSIT V363 Autocarro (FAD, FBD) 2.2 TDCi (12.2014 -12.2018) 114kw 155cv 2198cm3 Autocarro FORD TRANSIT V363 Autocarro (FAD, FBD) 2.2 TDCi 4x4 (08.2013 -12.2018) 92kw 125cv 2198cm3 Autocarro FORD TRANS...</p> <p>d11x2mm d10x2mm 1f-d7mm 1f-d6mm</p>		<p><b>U7033K</b> NO. 1212679 - 1212679 - 1332662 - 1474287 - 1S7C-3334-AA - 3M51-3334-AA</p> <p><b>ORINGS BOMBA DIREÇÃO ASSITIDA</b></p> <p>FORD TRANSIT V363 Caixa (FCD, FDD) 2.2 TDCi (08.2013 -12.2018) 74kw 100cv 2198cm3 Caixa FORD TRANSIT V363 Caixa (FCD, FDD) 2.2 TDCi (08.2013 -12.2018) 92kw 125cv 2198cm3 Caixa FORD TRANSIT V363 Caixa (FCD, FDD) 2.2 TDCi (08.2013 -12.2018) 114kw 155cv 2198cm3 Caixa FORD TRANSIT V363 Caixa (FCD, FDD) 2.2 TDCi 4x4 (08.2013 -12.2018) 92kw 125cv 2198cm3 Caixa FORD TRANSIT V363 Caixa (FCD, FDD) 2.2 TDCi...</p> <p>d11x2mm d10x2mm 1f-d7mm 1f-d6mm</p>
	<p><b>U7033K</b> NO. 1212679 - 1212679 - 1332662 - 1474287 - 1S7C-3334-AA - 3M51-3334-AA</p> <p><b>ORINGS BOMBA DIREÇÃO ASSITIDA</b></p> <p>FORD TRANSIT V363 Camião de plataforma/chassis (FED, FFD) 2.2 TDCi (08.2013 -12.2018) 74kw 100cv 2198cm3 Camião de plataforma/chassis FORD TRANSIT V363 Camião de plataforma/chassis (FED, FFD) 2.2 TDCi (08.2013 -12.2018) 92kw 125cv 2198cm3 Camião de plataforma/chassis FORD TRANSIT V363 Camião de plataforma/chassis (FED, FFD) 2.2 TDCi (08.2013 -12.2018) 114kw 155cv 2198cm3 Camião de plataforma/chas...</p> <p>d11x2mm d10x2mm 1f-d7mm 1f-d6mm</p>		<p><b>UCRZ1084</b> NO. 1522568 - 1522575</p> <p><b>CRUZETA VEIO DE TRANSMISSÃO TRIPOIDE D45MM/30 DENTES</b></p> <p>FORD TRANSIT Autocarro (FD_ , FB_ , FS_ , FZ_ , FC_ ) 2.2 TDCi (De 04.2006 Até 08.2014) 81kW 110cv 2198cm3 Autocarro - FORD TRANSIT Autocarro (FD_ , FB_ , FS_ , FZ_ , FC_ ) 2.2 TDCi (De 10.2011 Até 08.2014) 92kW 125cv 2198cm3 Autocarro -</p> <p>d45mm 30 dentes</p>
	<p><b>UCRZ1084</b> NO. 1522568 - 1522575</p> <p><b>CRUZETA VEIO DE TRANSMISSÃO TRIPOIDE D45MM/30 DENTES</b></p> <p>FORD TRANSIT TOURNEO Autocarro 2.2 (De 10.2011 Até 08.2014) 92kW 125cv 2198cm3 Autocarro - FORD TRANSIT TOURNEO Autocarro 2.2 TDCi (De 07.2006 Até 08.2014) 81kW 110cv 2198cm3 Autocarro - FORD TRANSIT TOURNEO Autocarro 2.2 TDCi (De 10.2008 Até 08.2014) 85kW 115cv 2198cm3 Autocarro - FORD TRANSIT TOURNEO Autocarro 2.2 TDCi (De 07.2006 Até 08.2014) 96kW 131cv 2198cm3 Autocarro - FORD TRANSIT TOURNEO...</p> <p>d45mm 30 dentes</p>		<p><b>UCRZ1084</b> NO. 1522568 - 1522575</p> <p><b>CRUZETA VEIO DE TRANSMISSÃO TRIPOIDE D45MM/30 DENTES</b></p> <p>FORD TRANSIT V363 Autocarro (FAD, FBD) 2.2 TDCi (De 08.2013 Até 12.2018) 92kW 125cv 2198cm3 Autocarro - FORD TRANSIT V363 Autocarro (FAD, FBD) 2.2 TDCi (De 12.2014 Até 12.2018) 114kW 155cv 2198cm3 Autocarro - FORD TRANSIT V363 Caixa (FCD, FDD) 2.2 TDCi (De 08.2013 Até 12.2018) 92kW 125cv 2198cm3 Caixa - FORD TRANSIT V363 Caixa (FCD, FDD) 2.2 TDCi (De 08.2013 Até 12.2018) 114kW 155cv 2198cm3 Caixa...</p> <p>d45mm 30 dentes</p>
	<p><b>UFQ30420</b> NO. 1023158 - 95VB7515DC</p> <p><b>FORQUILHA DA EMBRAIAGEM</b></p> <p>FORD TRANSIT Autocarro (E_ ) 2.0 (EBL, EBS, ECL, EDS, EDL, EGL, ESS, ESL, EUS) 08.1994/03.2000 84KW 114CV 1998CC NSH NSG NSF 0928288 0928245 0928252 2028375 2028366 0928872 0928878 0928880 0928913 0928924 0928952 0928936 0928940 - FORD TRANSIT Autocarro (E_ ) 2.0 CNG 06.1994/03.2000 84KW 114CV 1998CC NSH - FORD TRANSIT Autocarro (E_ ) 2.5 DI (EBL, ECL, EDS, EDL) 07.1994/03.2000 56KW 76CV 2496CC...</p> <p>380x86x64mm 1f-46x80mm</p>		<p><b>UFQ30420</b> NO. 1023158 - 95VB7515DC</p> <p><b>FORQUILHA DA EMBRAIAGEM</b></p> <p>FORD TRANSIT Caixa (E_ ) 2.0 (EAL, EAS) 06.1994/03.2000 84KW 114CV 1998CC NSG NSF NSH 0928233 0928235 2028505 - FORD TRANSIT Caixa (E_ ) 2.5 DI (EAL, EAS) 06.1994/03.2000 51KW 69CV 2496CC 4FD 4FC 4FB 4FA 2028501 0928193 0928197 - FORD TRANSIT Caixa (E_ ) 2.5 DI (EAL, EAS) 06.1994/03.2000 56KW 76CV 2496CC 4HC 4HB 0928234 0928236 2028506 2028510 - FORD TRANSIT Caixa (E_ ) 2.5 DI (EAL, EAS) 05.19...</p> <p>380x86x64mm 1f-46x80mm</p>
	<p><b>UFQ30420</b> NO. 1023158 - 95VB7515DC</p> <p><b>FORQUILHA DA EMBRAIAGEM</b></p> <p>FORD TRANSIT Camião de plataforma/chassis (E_ ) 2.0 (EME/L/S, ENE/L/S) 08.1994/03.2000 84KW 114CV 1998CC NSG NSF 0928237 0928239 0928241 0928243 0928247 0928249 0928256 - FORD TRANSIT Camião de plataforma/chassis (E_ ) 2.5 DI (EME/L/S, ENE/L/S) 08.1994/03.2000 56KW 76CV 2496CC 4HB 4HC 0928238 0928240 0928242 0928244 0928248 0928250 0928258 - FORD TRANSIT Camião de plataforma/chassis (E_ ) 2.5 D...</p> <p>380x86x64mm 1f-46x80mm</p>		<p><b>UFQ41225</b> NO. 3C117515AA - 4041551 - 4412069 - YC157515AA</p> <p><b>FORQUILHA DA EMBRAIAGEM</b></p> <p>FORD TRANSIT Autocarro (FD_ , FB_ , FS_ , FZ_ , FC_ ) 2.3 16V RWD (F_ B_ , F_ C_ , F_ A_ ) (08.2000 -05.2006) 107kw 146cv 2295cm3 Autocarro FORD TRANSIT Autocarro (FD_ , FB_ , FS_ , FZ_ , FC_ ) 2.4 DI (F_ B_ , F_ C_ , F_ A_ ) (01.2000 -05.2006) 66kw 90cv 2402cm3 Autocarro FORD TRANSIT Autocarro (FD_ , FB_ , FS_ , FZ_ , FC_ ) 2.4 DI RWD (F_ B_ , F_ C_ ) (01.2000 -05.2006) 55kw 75cv 2402cm3 Autocarro ...</p> <p>285x85x37mm 1f-46x70mm</p>
	<p><b>UFQ41225</b> NO. 3C117515AA - 4041551 - 4412069 - YC157515AA</p> <p><b>FORQUILHA DA EMBRAIAGEM</b></p> <p>FORD TRANSIT Caixa (FA_ ) 2.3 16V LPG RWD (04.2006 -08.2014) 107kw 145cv 2261cm3 Caixa FORD TRANSIT Caixa (FA_ ) 2.3 16V RWD (04.2006 -08.2014) 107kw 145cv 2261cm3 Caixa FORD TRANSIT Caixa (FA_ ) 2.3 16V RWD (FAA_ , FAB_ , FAC_ ) (04.2001 -05.2006) 107kw 146cv 2295cm3 Caixa FORD TRANSIT Caixa (FA_ ) 2.4 DI (FAA_ , FAB_ , FAC_ , FAD_ ) (01.2000 -05.2006) 66kw 90cv 2402cm3 Caixa FORD TRANSIT Caixa (FA_ )...</p> <p>285x85x37mm 1f-46x70mm</p>		<p><b>UFQ41225</b> NO. 3C117515AA - 4041551 - 4412069 - YC157515AA</p> <p><b>FORQUILHA DA EMBRAIAGEM</b></p> <p>FORD TRANSIT Camião de plataforma/chassis (FM_ , FN_ ) 2.3 16V (F_ A_ , F_ B_ , F_ C_ , F_ D_ ) (04.2001 -05.2006) 107kw 146cv 2295cm3 Camião de plataforma/chassis FORD TRANSIT Camião de plataforma/chassis (FM_ , FN_ ) 2.4 DI (F_ A_ , F_ B_ , F_ C_ , F_ D_ ) (01.2000 -05.2006) 55kw 75cv 2402cm3 Camião de plataforma/chassis FORD TRANSIT Camião de plataforma/chassis (FM_ , FN_ ) 2.4 DI (F_ A_ , F_ B_ , F_ C_ , F_ D_ ) (...)</p> <p>285x85x37mm 1f-46x70mm</p>
	<p><b>UMV25329</b> NO. 1417447 - 6C1R7217KA</p> <p><b>MANETE PUNHO TOPO ALAVANCA MUDANÇAS 6 VELOCIDADES F28MM</b></p> <p>FORD TRANSIT Autocarro (FD_ , FB_ , FS_ , FZ_ , FC_ ) 2.2 TDCi 04.2006/08.2014 63KW 85CV 2198CC P8FB P8FA 8566AFA 8566AFM 8566AFP 8566AFS 8566AVG 8566AGN - FORD TRANSIT Autocarro (FD_ , FB_ , FS_ , FZ_ , FC_ ) 2.2 TDCi 04.2006/08.2014 81KW 110CV 2198CC QVFA 8566AGO 8566AFN 8566AFQ 8566AFT - FORD TRANSIT Autocarro (FD_ , FB_ , FS_ , FZ_ , FC_ ) 2.2 TDCi 04.2006/08.2014 96KW 130CV 219...</p> <p>d50x52mm 1f-d28mm</p>		<p><b>UMV25329</b> NO. 1417447 - 6C1R7217KA</p> <p><b>MANETE PUNHO TOPO ALAVANCA MUDANÇAS 6 VELOCIDADES F28MM</b></p> <p>FORD TRANSIT Caixa (FA_ ) 2.2 TDCi 04.2006/08.2014 63KW 85CV 2198CC P8FB P8FA 8566AGU 8566AHE 8566AHP 8566AXT 8566AYT 8566AGH 8566AGH 8566AGK - FORD TRANSIT Caixa (FA_ ) 2.2 TDCi 04.2006/08.2014 81KW 110CV 2198CC QVFA 8566AGV 8566AHP 8566AHQ 8566AGF 8566AGL - FORD TRANSIT Caixa (FA_ ) 2.2 TDCi 04.2006/08.2014 96KW 130CV 2198CC QWFA 8566AGW 8566AHG 8566AHR 8566AGG 8566AGJ 8566AGM...</p> <p>d50x52mm 1f-d28mm</p>

	<p><b>UMV25329</b> NO. 1417447 - 6C1R7217KA</p> <p><b>MANETE PUNHO TOPO ALAVANCA MUDANÇAS 6 VELOCIDADES F28MM</b></p> <p>FORD TRANSIT Camião de plataforma/chassis (FM___, FN___, FF___) 2.2 TDCi 04.2006/08.2014 63KW 85CV 2198CC P8FB P8FA 8566AGX 8566AHK 8566AHS 8566AZF 8566AXV 8566AXZ - FORD TRANSIT Camião de plataforma/chassis (FM___, FN___, FF___) 2.2 TDCi 04.2006/08.2014 81KW 110CV 2198CC QVFA 8566AGY 8566AHL 8566AHN 8566AHT 8566AHV - FORD TRANSIT Camião de plataforma/chassis (FM___, FN___, FF___) 2.2 TDCi 04.2006...</p> <p>d50x52mm 1f-d28mm</p>		<p><b>UMV25330</b> NO. 1417448 - 6C1R7217LA</p> <p><b>MANETE PUNHO TOPO ALAVANCA MUDANÇAS 6 VELOCIDADES F28MM</b></p> <p>FORD TRANSIT Autocarro (FD___, FB___, FS___, FZ___, FC___) 2.2 TDCi 04.2006/08.2014 63KW 85CV 2198CC P8FB P8FA 8566AFA 8566AFM 8566AFP 8566AFV 8566AVG 8566AGN - FORD TRANSIT Autocarro (FD___, FB___, FS___, FZ___, FC___) 2.2 TDCi 04.2006/08.2014 81KW 110CV 2198CC QVFA 8566AGO 8566AFN 8566AFQ 8566AFT - FORD TRANSIT Autocarro (FD___, FB___, FS___, FZ___, FC___) 2.2 TDCi 04.2006/08.2014 96KW 130CV 219...</p> <p>d50x51mm 1f-d28mm</p>
	<p><b>UMV25330</b> NO. 1417448 - 6C1R7217LA</p> <p><b>MANETE PUNHO TOPO ALAVANCA MUDANÇAS 6 VELOCIDADES F28MM</b></p> <p>FORD TRANSIT TOURNEO Autocarro 2.2 10.2011/08.2014 92KW 125CV 2198CC CYFB CYFA CYFC CYFD - FORD TRANSIT TOURNEO Autocarro 2.2 TDCi 07.2006/08.2014 81KW 110CV 2198CC QVFA 8566AFB - FORD TRANSIT TOURNEO Autocarro 2.2 TDCi 07.2006/08.2014 96KW 131CV 2198CC QWFA 8566AFC - FORD TRANSIT TOURNEO Autocarro 2.2 TDCi 10.2007/08.2014 103KW 140CV 2198CC UHFC PGFB UHFB UHFA PGFA 8566AMJ - FORD TRANSIT TOURNEO ...</p> <p>d50x51mm 1f-d28mm</p>		<p><b>UPCR5004</b> NO. 1454051 - 1567143 - 1678260</p> <p><b>PORCA DA RODA CHAVE 19 M12X1,50X30MM ( BASE CONICA )</b></p> <p>FORD TRANSIT Caixa (E___) 2.0 (09.1991 -06.1994) 66kw 90cv 1993cm3 Caixa FORD TRANSIT Caixa (E___) 2.0 (EAL, EAS) (06.1994 -03.2000) 84kw 114cv 1998cm3 Caixa FORD TRANSIT Caixa (E___) 2.0 i (EAL, EAS) (09.1991 -06.1994) 72kw 98cv 1994cm3 Caixa FORD TRANSIT Caixa (E___) 2.5 DI (EAL, EAS) (05.1991 -06.1994) 51kw 70cv 2496cm3 Caixa FORD TRANSIT Caixa (E___) 2.5 DI (EAL, EAS) (10.1992 -06.1994) 63kw 8...</p> <p>d26x32mm M12x1,5mm</p>
	<p><b>UPCR5004</b> NO. 1454051 - 1567143 - 1678260</p> <p><b>PORCA DA RODA CHAVE 19 M12X1,50X30MM ( BASE CONICA )</b></p> <p>FORD TRANSIT Camião de plataforma/chassis (E___) 2.0 (EME/L/S,ENE/L/S) (09.1991 -08.1994) 72kw 98cv 1994cm3 Camião de plataforma/chassis FORD TRANSIT Camião de plataforma/chassis (E___) 2.0 (EME/L/S,ENE/L/S) (08.1994 - 03.2000) 84kw 114cv 1998cm3 Camião de plataforma/chassis FORD TRANSIT Camião de plataforma/chassis (E___) 2.5 DI (EME/L/S,ENE/L/S) (09.1991 - 08.1994) 59kw 80cv 2496cm3 Camião de pl...</p> <p>d26x32mm M12x1,5mm</p>		<p><b>UPCR5004</b> NO. 1454051 - 1567143 - 1678260</p> <p><b>PORCA DA RODA CHAVE 19 M12X1,50X30MM ( BASE CONICA )</b></p> <p>FORD TRANSIT TOURNEO Autocarro 2.0 (11.1994 -12.2000) 84kw 114cv 1998cm3 Autocarro FORD TRANSIT TOURNEO Autocarro 2.4 D (08.1994 -06.2000) 55kw 74cv 2496cm3 Autocarro FORD TRANSIT TOURNEO Autocarro 2.5 DI (11.1994 -12.2000) 51kw 69cv 2496cm3 Autocarro FORD TRANSIT TOURNEO Autocarro 2.5 DI (11.1994 -12.2000) 56kw 76cv 2496cm3 Autocarro FORD TRANSIT TOURNEO Autocarro 2.5 TD (11.1994 -12.2000) 63kw 8...</p> <p>d26x32mm M12x1,5mm</p>
	<p><b>UPCR5018</b> NO. 1007487 - 1447852 - 1470843</p> <p><b>PORCA DA RODA CHAVE 19 M12X1,50X16MM ( BASE CONICA PARA JANTE DE AÇO )</b></p> <p>FORD TRANSIT TOURNEO Autocarro 2.0 (11.1994 - 12.2000) 84kw 114cv 1998cm3 Autocarro FORD TRANSIT TOURNEO Autocarro 2.5 DI (11.1994 - 12.2000) 51kw 69cv 2496cm3 Autocarro FORD TRANSIT TOURNEO Autocarro 2.5 DI (11.1994 - 12.2000) 56kw 76cv 2496cm3 Autocarro FORD TRANSIT TOURNEO Autocarro 2.5 TD (11.1994 - 12.2000) 63kw 85cv 2496cm3 Autocarro</p> <p>d19x15mm M12x15mm</p>		<p><b>UPCR5020</b> NO. 1377747 - 1382841 - 1428137 - 1676176 - 5196786 - 5275544</p> <p><b>PORCA DA RODA CHAVE 21 M14X1,5X34MM ( BASE CONICA )</b></p> <p>FORD TRANSIT TOURNEO Autocarro 2.2 (10.2011 -08.2014) 92kw 125cv 2198cm3 Autocarro FORD TRANSIT TOURNEO Autocarro 2.2 TDCi (07.2006 -08.2014) 81kw 110cv 2198cm3 Autocarro FORD TRANSIT TOURNEO Autocarro 2.2 TDCi (10.2008 -08.2014) 85kw 115cv 2198cm3 Autocarro FORD TRANSIT TOURNEO Autocarro 2.2 TDCi (07.2006 -08.2014) 96kw 131cv 2198cm3 Autocarro FORD TRANSIT TOURNEO Autocarro 2.2 TDCi (10.2007 -08....</p> <p>d28x34mm M14x32mm</p>
	<p><b>URTE6021</b> NO. 1490305 - 8C1R-3K169-AA</p> <p><b>RETENTOR VEIO DIFERENCIAL TRANSMISSÃO D44X60/67,2X13MM</b></p> <p>FORD TRANSIT TOURNEO Autocarro 2.2 10.2011/08.2014 92KW 125CV 2198CC CYFB CYFA CYFC CYFD - FORD TRANSIT TOURNEO Autocarro 2.2 TDCi 07.2006/08.2014 81KW 110CV 2198CC QVFA 8566AFB - FORD TRANSIT TOURNEO Autocarro 2.2 TDCi 07.2006/08.2014 96KW 131CV 2198CC QWFA 8566AFC - FORD TRANSIT TOURNEO Autocarro 2.2 TDCi 10.2007/08.2014 103KW 140CV 2198CC UHFC PGFB UHFB UHFA PGFA 8566AMJ - FORD TRANSIT TOURNEO ...</p> <p>d67x13mm 1f-d42mm</p>		<p><b>URTE6021</b> NO. 1490305 - 8C1R-3K169-AA</p> <p><b>RETENTOR VEIO DIFERENCIAL TRANSMISSÃO D44X60/67,2X13MM</b></p> <p>FORD TRANSIT TOURNEO Autocarro 2.2 10.2011/08.2014 92KW 125CV 2198CC CYFB CYFA CYFC CYFD - FORD TRANSIT TOURNEO Autocarro 2.2 TDCi 07.2006/08.2014 81KW 110CV 2198CC QVFA 8566AFB - FORD TRANSIT TOURNEO Autocarro 2.2 TDCi 07.2006/08.2014 96KW 131CV 2198CC QWFA 8566AFC - FORD TRANSIT TOURNEO Autocarro 2.2 TDCi 10.2007/08.2014 103KW 140CV 2198CC UHFC PGFB UHFB UHFA PGFA 8566AMJ - FORD TRANSIT TOURNEO ...</p> <p>d67x13mm 1f-d42mm</p>
	<p><b>UTR0846</b> NO. 1029727 - 7166662 - 95VB8100AD - 95VB8100AE</p> <p><b>TAMPÃO RESERVATÓRIO LIQUIDO REFRIGERAÇÃO</b></p> <p>FORD TRANSIT TOURNEO 2.0 (11.94 A 12.00) 114cv 1998cc Autocarro - FORD TRANSIT TOURNEO 2.5 DI (11.94 A 12.00) 69cv 2496cc Autocarro - FORD TRANSIT TOURNEO 2.5 DI (11.94 A 12.00) 76cv 2496cc Autocarro - FORD TRANSIT TOURNEO 2.5 TD (11.94 A 12.00) 85cv 2496cc Autocarro - FORD TRANSIT TOURNEO 2.5 TD (04.98 A 12.00) 100cv 2496cc Autocarro</p> <p>62x37mm 1f-d52x12mm</p>		<p><b>UTR0847</b> NO. 1224233 - 1301104 - 3M5H8100AC</p> <p><b>TAMPÃO RESERVATÓRIO LIQUIDO REFRIGERAÇÃO</b></p> <p>FORD TOURNEO CUSTOM Autocarro 2.0 TDCi (A Partir de 12.15) 105cv 1995cc Autocarro - FORD TOURNEO CUSTOM Autocarro 2.0 TDCi (A Partir de 12.15) 130cv 1995cc Autocarro - FORD TOURNEO CUSTOM Autocarro 2.0 TDCi (A Partir de 12.15) 170cv 1995cc Autocarro - FORD TOURNEO CUSTOM Autocarro 2.2 TDCi (A partir de 04.12) 100cv 2198cc Autocarro - FORD TOURNEO CUSTOM Autocarro 2.2 TDCi (A Partir de 04.1...</p> <p>d62x35mm 1f-d50x16mm</p>
	<p><b>W5026</b> NO. 1038330 - 1135052 - 1250444 - 26105255 - 6599021 - 928M6B320DB - 928M6B320DD - 928M6B320DE - 928M6B320E</p> <p><b>POLIE CAMBOTA ( 6 PISTAS )</b></p> <p>FORD TRANSIT CONNECT (P65___, P70___, P80___): 1.8 16V 06.2002/12.2013 85KW 116CV 1796CC</p> <p>d131.3mm d28mm</p>		<p><b>Y3235</b> NO. 1370439 - 4038464 - 4048803 - 4395255 - 4424984</p> <p><b>PARAFUSO DA RODA CAVILHA M14X1,50X35MM</b></p> <p>FORD TRANSIT Autocarro (FD___, FB___, FS___, FZ___, FC___) 2.0 DI (F___, F___, F___, F___, F___) (08.2000 -05.2006) 55kw 75cv 1998cm3 Autocarro FORD TRANSIT Autocarro (FD___, FB___, FS___, FZ___, FC___) 2.0 DI (F___, F___, F___, F___, F___) (08.2000 -05.2006) 55kw 75cv 1998cm3 Autocarro FORD TRANSIT Autocarro (FD___, FB___, FS___, FZ___, FC___) 2.0 DI (F___, F___, F___, F___, F___) (08.2000 -05.2006) 63kw 86cv 1998cm3 Autocarro FORD TR...</p> <p>c48mm M12x1,25mm</p>
	<p><b>Y3235</b> NO. 1370439 - 4038464 - 4048803 - 4395255 - 4424984</p> <p><b>PARAFUSO DA RODA CAVILHA M14X1,50X35MM</b></p> <p>FORD TRANSIT Camião de plataforma/chassis (FM___, FN___, FF___) 2.2 TDCi (10.2008 - 08.2014) 85kw 115cv 2198cm3 Camião de plataforma/chassis FORD TRANSIT Camião de plataforma/chassis (FM___, FN___, FF___) 2.2 TDCi (10.2011 - 08.2014) 92kw 125cv 2198cm3 Camião de plataforma/chassis FORD TRANSIT Camião de plataforma/chassis (FM___, FN___, FF___) 2.2 TDCi (04.2006 - 08.2014) 81kw 110cv 2198cm3 Camião...</p> <p>c48mm M12x1,25mm</p>		<p><b>Z41158</b> NO. 1656747 - 1825595 - 1752024 - 6740771 - 4852244</p> <p><b>MOLA DE FIXAÇÃO TIPO PORCA</b></p> <p>FORD TRANSIT Autocarro (FD___, FB___, FS___, FZ___, FC___) 2.0 DI (F___, F___, F___, F___, F___) (08.2000 -05.2006) 55kw 75cv 1998cm3 Autocarro FORD TRANSIT Autocarro (FD___, FB___, FS___, FZ___, FC___) 2.0 DI (F___, F___, F___, F___, F___) (08.2000 -05.2006) 63kw 86cv 1998cm3 Autocarro FORD TRANSIT Autocarro (FD___, FB___, FS___, FZ___, FC___) 2.0 DI (F___, F___, F___, F___, F___) (08.2000 -05.2006) 74kw 100cv 1998cm3 Autocarro FORD T...</p> <p>d12x 11mm f-d24mm</p>

	<p><b>Z41158</b> NO. 1656747 - 1825595 - 1752024 - 6740771 - 4852244</p> <p><b>MOLA DE FIXAÇÃO TIPO PORCA</b></p> <p>FORD TRANSIT CUSTOM V362 Caixa (FY, FZ) 1.0 EcoBoost PHEV (04.2020 -12.2023) 92kw 125cv 996cm3 Caixa FORD TRANSIT CUSTOM V362 Caixa (FY, FZ) 2.0 EcoBlue (12.2015 -12.2023) 77kw 105cv 1995cm3 Caixa FORD TRANSIT CUSTOM V362 Caixa (FY, FZ) 2.0 EcoBlue (12.2015 -12.2023) 96kw 130cv 1995cm3 Caixa FORD TRANSIT CUSTOM V362 Caixa (FY, FZ) 2.0 EcoBlue (12.2015 -12.2023) 125kw 170cv 1995cm3 Caixa FORD TRANS...</p> <p>d12x 11mm f-d24mm</p>		<p><b>Z41158</b> NO. 1656747 - 1825595 - 1752024 - 6740771 - 4852244</p> <p><b>MOLA DE FIXAÇÃO TIPO PORCA</b></p> <p>FORD TRANSIT Caixa (FA_) 2.0 DI (FAE_, FAF_, FAG_) (08.2000 -05.2006) 63kw 86cv 1998cm3 Caixa FORD TRANSIT Caixa (FA_) 2.0 DI (FAE_, FAF_, FAG_) (08.2000 -05.2006) 74kw 100cv 1998cm3 Caixa FORD TRANSIT Caixa (FA_) 2.0 DI (FAE_, FAF_, FAG_) (08.2000 -05.2006) 55kw 75cv 1998cm3 Caixa FORD TRANSIT Caixa (FA_) 2.0 TDCi (08.2002 -05.2006) 92kw 125cv 1998cm3 Caixa FORD TRANSIT Caixa (FA_) 2.3 ...</p> <p>d12x 11mm f-d24mm</p>
	<p><b>Z41158</b> NO. 1656747 - 1825595 - 1752024 - 6740771 - 4852244</p> <p><b>MOLA DE FIXAÇÃO TIPO PORCA</b></p> <p>FORD TRANSIT Camião de plataforma/chassis (FM_, FN_) 2.0 DI (F_E_, F_F_) (08.2000 -05.2006) 55kw 75cv 1998cm3 Camião de plataforma/chassis FORD TRANSIT Camião de plataforma/chassis (FM_, FN_) 2.0 DI (F_E_, F_F_) (08.2000 -05.2006) 63kw 86cv 1998cm3 Camião de plataforma/chassis FORD TRANSIT Camião de plataforma/chassis (FM_, FN_) 2.0 DI (F_E_, F_F_) (08.2000 -05.2006) 74kw 100cv 1998cm3 Ca...</p> <p>d12x 11mm f-d24mm</p>		<p><b>Z41158</b> NO. 1656747 - 1825595 - 1752024 - 6740771 - 4852244</p> <p><b>MOLA DE FIXAÇÃO TIPO PORCA</b></p> <p>FORD TRANSIT TOURNEO Autocarro (FC_) 2.0 (06.2000 -08.2003) 55kw 75cv 1998cm3 Autocarro FORD TRANSIT TOURNEO Autocarro (FC_) 2.0 (06.2000 -03.2005) 74kw 101cv 1998cm3 Autocarro FORD TRANSIT TOURNEO Autocarro (FC_) 2.0 (03.2002 -03.2006) 92kw 125cv 1998cm3 Autocarro</p> <p>d12x 11mm f-d24mm</p>
	<p><b>Z50130</b> NO. 11589289</p> <p><b>MOLA REBITE FIXAÇÃO</b></p> <p>FORD TOURNEO CUSTOM V362 Autocarro (F3) 1.0 EcoBoost PHEV (04.2020 -12.2023) 92kw 125cv 996cm3 Autocarro FORD TOURNEO CUSTOM V362 Autocarro (F3) 2.0 EcoBlue (12.2015 -12.2023) 77kw 105cv 1995cm3 Autocarro FORD TOURNEO CUSTOM V362 Autocarro (F3) 2.0 EcoBlue (12.2015 -12.2023) 96kw 130cv 1995cm3 Autocarro FORD TOURNEO CUSTOM V362 Autocarro (F3) 2.0 EcoBlue (12.2015 -12.2023) 125kw 170cv 1995cm3 Auto...</p> <p>d6x 18mm f-d17mm</p>		<p><b>Z50130</b> NO. 11589289</p> <p><b>MOLA REBITE FIXAÇÃO</b></p> <p>FORD TRANSIT CONNECT V408 Caixa/monovolume 1.0 EcoBoost (09.2013 -) 74kw 100cv 998cm3 Caixa/monovolume FORD TRANSIT CONNECT V408 Caixa/monovolume 1.0 Flexifuel (05.2021 -) 74kw 100cv 998cm3 Caixa/monovolume FORD TRANSIT CONNECT V408 Caixa/monovolume 1.5 EcoBlue (05.2018 -) 55kw 75cv 1499cm3 Caixa/monovolume FORD TRANSIT CONNECT V408 Caixa/monovolume 1.5 EcoBlue (05.2018 -) 74kw 101cv 1499cm3 Caixa...</p> <p>d6x 18mm f-d17mm</p>
	<p><b>Z50130</b> NO. 11589289</p> <p><b>MOLA REBITE FIXAÇÃO</b></p> <p>FORD TRANSIT V363 Autocarro (FAD, FBD) 2.0 EcoBlue (03.2016 -) 77kw 105cv 1995cm3 Autocarro FORD TRANSIT V363 Autocarro (FAD, FBD) 2.0 EcoBlue (03.2016 -) 96kw 130cv 1995cm3 Autocarro FORD TRANSIT V363 Autocarro (FAD, FBD) 2.0 EcoBlue (03.2016 -06.2024) 125kw 170cv 1995cm3 Autocarro FORD TRANSIT V363 Autocarro (FAD, FBD) 2.0 EcoBlue RWD (05.2019 -) 96kw 130cv 1995cm3 Autocarro FORD TRANSIT V363 Au...</p> <p>d6x 18mm f-d17mm</p>		<p><b>Z50130</b> NO. 11589289</p> <p><b>MOLA REBITE FIXAÇÃO</b></p> <p>FORD TRANSIT V363 Caixa (FCD, FDD) 2.0 EcoBlue (03.2016 -) 77kw 105cv 1995cm3 Caixa FORD TRANSIT V363 Caixa (FCD, FDD) 2.0 EcoBlue (03.2016 -) 96kw 130cv 1995cm3 Caixa FORD TRANSIT V363 Caixa (FCD, FDD) 2.0 EcoBlue (03.2016 -06.2024) 125kw 170cv 1995cm3 Caixa FORD TRANSIT V363 Caixa (FCD, FDD) 2.0 EcoBlue (05.2019 -) 136kw 185cv 1995cm3 Caixa FORD TRANSIT V363 Caixa (FCD, FDD) 2.0 EcoBlue 4x4 (01....</p> <p>d6x 18mm f-d17mm</p>
	<p><b>Z50130</b> NO. 11589289</p> <p><b>MOLA REBITE FIXAÇÃO</b></p> <p>FORD TRANSIT V363 Camião de plataforma/chassis (FED, FFD) 2.0 EcoBlue (03.2016 -) 77kw 105cv 1995cm3 Camião de plataforma/chassis FORD TRANSIT V363 Camião de plataforma/chassis (FED, FFD) 2.0 EcoBlue (03.2016 -) 96kw 130cv 1995cm3 Camião de plataforma/chassis FORD TRANSIT V363 Camião de plataforma/chassis (FED, FFD) 2.0 EcoBlue (03.2016 -06.2024) 125kw 170cv 1995cm3 Camião de plataforma/chassis FO...</p> <p>d6x 18mm f-d17mm</p>		<p><b>Z57104</b> NO. 4831516</p> <p><b>MOLA DO PAINEL DA PORTA</b></p> <p>FORD TRANSIT (A partir de 2013)</p> <p>F12mm T21mm L18mm H28mm S1-12mm</p>