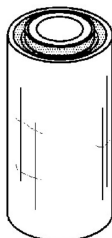

	<p>A2654 NO. 12361-87603</p> <p>APOIO DO MOTOR</p> <p>DAIHATSU WILDCAT/ROCKY (F70) 2.8 D 02.1985/03.1987 54KW 73CV 2765CC DL 7111311 - DAIHATSU WILDCAT/ROCKY (F70) 2.8 TD 09.1985/04.1987 65KW 88CV 2765CC DL-50 7111315 - DAIHATSU WILDCAT/ROCKY (F75) 2.8 D 02.1985/03.1987 54KW 73CV 2765CC DL 7111313 - DAIHATSU WILDCAT/ROCKY (F75) 2.8 TD 09.1985/04.1987 65KW 88CV 2765CC DL-50 7111314</p> <p>143x108x47mm 2f-d12mm 1p-d12x27mm</p>		<p>A2698 NO. 12306-87401-000 - 12306-87403 - 12306-87401</p> <p>APOIO DO MOTOR PARTE DE TRÁS</p> <p>DAIHATSU TERIOS (J1_) TARUNA 1.3 (J122) 07.2000/10.2006 63KW 86CV 1298CC K3-VE 7111376 - DAIHATSU TERIOS (J1_) TARUNA 1.3 4WD (J100) 10.1997/10.2000 61KW 83CV 1296CC HC-EJ 7111360 - DAIHATSU TERIOS (J1_) TARUNA 1.3 4WD (J102) 10.2000/10.2005 63KW 86CV 1298CC K3-VE 7111372</p> <p>164x137x96mm 2f-d10mm 1f-d12mm 1f-11x12mm</p>
	<p>S1062 NO. 90043-85046 - 90043-85046-000 - 9004385046000</p> <p>SILENT-BLOC DAS MOLAS DA FRENTE PARTE DA FRENTE (GASTA 2 UNIDADES)</p> <p>DAIHATSU DELTA V22</p> <p>d36x76mm c70mm 1f-d16mm</p>		

DAIHATSU APPLAUSE

	<p>E0018 NO. 17565-15010 - 17565-63030 - 17567-87101 - 17567-87210 - 17567-87703 - 17577-87704</p> <p>ESTICADOR DE ESCAPE</p> <p>DAIHATSU APPLAUSE I Hatchback (A101, A111) 1.6 16V (A101) 06.1989/07.1997 66KW 90CV 1590CC HD - DAIHATSU APPLAUSE I Hatchback (A101, A111) 1.6 16V (A101) 06.1989/07.1997 77KW 105CV 1590CC HD-E 7111339 - DAIHATSU APPLAUSE I Hatchback (A101, A111) 1.6 16V 4WD (A111) 06.1989/07.1997 77KW 105CV 1590CC HD-E 7111340</p> <p>68x54x25mm</p>		<p>F0512-I NO. 0K203-22-530 - 0K254-22-530</p> <p>FOLE DE TRANSMISSAO</p> <p>DAIHATSU APPLAUSE I Hatchback (A101, A111) 1.6 16V (A101) 06.1989/07.1997 66KW 90CV 1590CC HD - DAIHATSU APPLAUSE I Hatchback (A101, A111) 1.6 16V (A101) 06.1989/07.1997 77KW 105CV 1590CC HD-E 7111339 - DAIHATSU APPLAUSE II Hatchback (A101) 1.6 16V (A101) 07.1997/05.2000 73KW 99CV 1590CC HD-E 7111362</p> <p>d83x85mm 1f-d72mm 1f-d22mm</p>
	<p>F1273-I NO. 04438-87710</p> <p>FOLE DE TRANSMISSAO LADO DA CAIXA</p> <p>DAIHATSU APPLAUSE 1.6i 16V - 1.6i 16V 4WD (1989 A 1997)</p> <p>d82x82mm 1f-d62mm 1f-d20mm</p>		<p>F1275-I NO. 04438-87718-000 - 0443887718000 - 0443887719000 - 96245310 - 96273574</p> <p>FOLE DE TRANSMISSAO LADO DA CAIXA</p> <p>DAIHATSU APPLAUSE (1) 1.6 LX A101 (APÓS 1989)</p> <p>d67x85mm 1f-d58mm 1f-d18mm</p>
	<p>KF1259-I NO. 04438-87110 - 04438-87F10</p> <p>KIT DE FOLE DA TRANSMISSÃO LADO DA CAIXA</p> <p>DAIHATSU APPLAUSE I Hatchback (A101, A111) 1.6 16V (A101) (De 06.1989 Até 07.1997) 66kW 90cv 1590cm3 Hatchback -</p> <p>d86x80mm 1f-d19mm 1f-d69mm</p>		<p>M6005 NO. 90048-17006 - 90048-17007 - 90048-17019 - 90048-18015</p> <p>JUNTA DE ESCAPE</p> <p>DAIHATSU APPLAUSE I Hatchback (A101, A111): 1.6 16V (A101) 06.1989/07.1997 66KW 90CV 1590CC - DAIHATSU APPLAUSE I Hatchback (A101, A111): 1.6 16V (A101) 06.1989/07.1997 77KW 105CV 1590CC - DAIHATSU APPLAUSE I Hatchback (A101, A111): 1.6 16V 4WD (A111) 06.1989/07.1997 77KW 105CV 1590CC - DAIHATSU APPLAUSE II Hatchback (A101): 1.6 16V (A101) 07.1997/05.2000 73KW 99CV 1590CC</p> <p>d57x5mm 1f-d45mm</p>

DAIHATSU CHARADE-CUORE-MIRA-MOVE-SIRION

	<p>A2334 NO. 12305-97203 - 12305-97210 - 1230597203000 - 1230597210000 - 1230597211</p> <p>APOIO DO MOTOR PARTE DA FRENTE</p> <p>DAIHATSU CUORE V (L7_) 1.0 11.1998/12.2002 41KW 56CV 989CC EJ-VE EJ-DE 7111365 - DAIHATSU CUORE V (L7_) 1.0 DVVT 10.2000/02.2003 43KW 58CV 989CC EJ-VE</p> <p>148x73x112mm 2f-d10mm 1f-d12mm 1f-10x13mm</p>		<p>A2334 NO. 12305-97203 - 12305-97210 - 1230597203000 - 1230597210000 - 1230597211</p> <p>APOIO DO MOTOR PARTE DA FRENTE</p> <p>DAIHATSU SIRION (M1) 1.0 i (M100) 04.1998/09.2000 41KW 56CV 989CC EJ-DE 7111363 - DAIHATSU SIRION (M1) 1.0 i 4WD 04.1999/09.2000 41KW 56CV 989CC EJ-DE 7111367</p> <p>148x73x112mm 2f-d10mm 1f-d12mm 1f-10x13mm</p>
---	---	--	---

	<p>A2334 NO. 12305-97203 - 12305-97210 - 1230597203000 - 1230597210000 - 1230597211</p> <p>APOIO DO MOTOR PARTE DA FRENTE</p> <p>DAIHATSU MOVE (L9_) 1.0 i 10.1998/09.2002 41KW 55CV 989CC EJ-DE 7111366</p> <p>148x73x112mm 2f-d10mm 1f-d12mm 1f-10x13mm</p>		<p>A2577 NO. 1r-d12mm 1f-d10mm 1f-d13mm 1f-11x1</p> <p>APOIO DO MOTOR DA FRENTE LADO DIREITO</p> <p>DAIHATSU SIRION (M1) 1.3 Sport 08.2000/01.2005 75KW 102CV 1298CC K3-VE2 7111370 - DAIHATSU SIRION (M1) 1.3 Sport 4WD 08.2000/03.2005 75KW 102CV 1298CC K3-VE2 7111371 - DAIHATSU SIRION (M3_) 1.0 01.2005/06.2013 51KW 70CV 998CC 1KR-FE 7111381 7111AAF - DAIHATSU SIRION (M3_) 1.0 LPG 01.2005/06.2013 51KW 70CV 998CC 1KR-FE - DAIHATSU SIRION (M3_) 1.3 desde 03.2008 67KW 91CV 1298CC K3-VE 7111AAAN - DAIHA...</p> <p>115x160x85mm 1r-d12mm 1f-d10mm 1f-d13mm 1f-11x12mm...</p>
	<p>E0018 NO. 17565-15010 - 17565-63030 - 17567-87101 - 17567-87210 - 17567-87703 - 17571-87704</p> <p>ESTICADOR DE ESCAPE</p> <p>DAIHATSU CHARADE II (G11, G30) 1.0 (G11) 10.1983/03.1987 38KW 52CV 993CC CB 22 CB 20 CB 23 7111307 - DAIHATSU CHARADE II (G11, G30) 1.0 D (G30) 10.1983/03.1987 27KW 37CV 993CC CL 10 7111308 - DAIHATSU CHARADE II (G11, G30) 1.0 TD (G30) 02.1985/03.1987 34KW 46CV 993CC CL 60 7111312 - DAIHATSU CHARADE III (G100, G101, G102) 1.0 (G100) 03.1987/12.1992 38KW 52CV 993CC CB 23 7111320 - DAIHATSU CHARADE ...</p> <p>68x54x25mm</p>		<p>E0018 NO. 17565-15010 - 17565-63030 - 17567-87101 - 17567-87210 - 17567-87703 - 17571-87704</p> <p>ESTICADOR DE ESCAPE</p> <p>DAIHATSU CUORE (APÓS 90)</p> <p>68x54x25mm</p>
	<p>E0029 NO. 17553-87201 - 1755387202 - 17565-15050 - 17565-15070 - 17565-16230 - 17565-28020 - 17567-87208 - 87209</p> <p>ESTICADOR DE ESCAPE</p> <p>DAIHATSU CUORE III (L201) 0.8 10.1990/12.1994 30KW 41CV 847CC ED 10 K 7111341</p> <p>60x50x27mm</p>		<p>E0029 NO. 17553-87201 - 17553-87202 - 1755387202 - 17565-15050 - 17565-15070 - 17565-16230 - 17565-28020 - 87209</p> <p>ESTICADOR DE ESCAPE</p> <p>DAIHATSU MOVE</p> <p>60x50x27mm</p>
	<p>E0312 NO. 48831-B1010 - 48831-B1020 - 48831-B1021</p> <p>ESTICADOR BARRA ESTABILIZADORA FRENTE ESQUERDO</p> <p>DAIHATSU SIRION (M3_) 1.0 01.2005/06.2013 51KW 70CV 998CC 1KR-FE 7111381 7111AAF - DAIHATSU SIRION (M3_) 1.0 LPG 01.2005/06.2013 51KW 70CV 998CC 1KR-FE - DAIHATSU SIRION (M3_) 1.3 desde 03.2008 67KW 91CV 1298CC K3-VE 7111AAAN - DAIHATSU SIRION (M3_) 1.3 (M301) desde 01.2005 64KW 87CV 1298CC K3-VE 7111382 7111AAG - DAIHATSU SIRION (M3_) 1.3 4WD desde 04.2005 64KW 87CV 1298CC K3-VE 7111AAH - DAIHATSU...</p> <p>85x66x35mm 2p-d10x25mm</p>		<p>E0313 NO. 48821-B1010 - 48821-B1030 - 48821-B1031</p> <p>ESTICADOR BARRA ESTABILIZADORA FRENTE DIREITO</p> <p>DAIHATSU SIRION (M3_) 1.0 01.2005/06.2013 51KW 70CV 998CC 1KR-FE 7111381 7111AAF - DAIHATSU SIRION (M3_) 1.0 LPG 01.2005/06.2013 51KW 70CV 998CC 1KR-FE - DAIHATSU SIRION (M3_) 1.3 desde 03.2008 67KW 91CV 1298CC K3-VE 7111AAAN - DAIHATSU SIRION (M3_) 1.3 (M301) desde 01.2005 64KW 87CV 1298CC K3-VE 7111382 7111AAG - DAIHATSU SIRION (M3_) 1.3 4WD desde 04.2005 64KW 87CV 1298CC K3-VE 7111AAH - DAIHATSU...</p> <p>88x66x35mm 2p-d10x25mm</p>
	<p>E1012 NO. 17553 - 17567-87704 - 87603</p> <p>ESTICADOR DE ESCAPE</p> <p>DAIHATSU CUORE III (L201) 0.8 10.1990/12.1994 30KW 41CV 847CC ED 10 K 7111341 - DAIHATSU CUORE IV (L501) 0.8 01.1995/08.1998 32KW 43CV 847CC ED 20 7111350 7111348 - DAIHATSU CUORE IV (L501) 0.8 11.1996/10.1998 31KW 42CV 847CC ED 20 7111356</p> <p>68x42x15mm</p>		<p>F0512-I NO. 04438-87701-000 - 0443887701000 - 04438-87203-000 - 04438-87206-000 - 04438-87709-000 - 04438...</p> <p>FOLE DE TRANSMISSÃO</p> <p>DAIHATSU CHARADE III (G100, G101, G102) 1.0 GTi (G100) 03.1987/12.1992 74KW 101CV 993CC CB 80 T 7111322 - DAIHATSU CHARADE III (G100, G101, G102) 1.3 (G102) 06.1988/12.1992 66KW 90CV 1295CC HC-E 7111331 - DAIHATSU CHARADE III três volumes (G102) 1.3 11.1990/02.1993 66KW 90CV 1295CC HC-E - DAIHATSU CHARADE IV (G200, G202) 1.5 i 16V 01.1997/11.1999 66KW 90CV 1499CC HEE - DAIHATSU CHARADE IV (G200,...</p> <p>d83x85mm 1f-d72mm 1f-d22mm</p>
	<p>F1236-I NO. 04438-87505-000 - 04438-87705-000 - 0443887705000</p> <p>FOLE DE TRANSMISSÃO</p> <p>DAIHATSU CHARADE 1.0 DIESEL G101 (5-1987 A 10-1989) - 1.0 G11 (2-1983 A 5-1987) - MIR 660 (3-1990 A 3-1992) - MOVE 1.0 G11 (APÓS 9-1997)</p> <p>d80x77mm 1f-d67mm 1f-d19mm</p>		<p>F1273-I NO. 04438-87710</p> <p>FOLE DE TRANSMISSÃO LADO DA CAIXA</p> <p>DAIHATSU CHARADE III 1.0i GTi - 1.3 - 1.3i 16V - 1.5i 16V - 1.6i GTi (1987 A 1992)</p> <p>d82x82mm 1f-d62mm 1f-d20mm</p>
	<p>F1273-I NO. 04438-87710</p> <p>FOLE DE TRANSMISSÃO LADO DA CAIXA</p> <p>DAIHATSU GRAN MOVE 1.5i 16V - 1.6i 16V (APÓS 1996)</p> <p>d82x82mm 1f-d62mm 1f-d20mm</p>		<p>F1275-I NO. 0443887718000 - 0443887719000</p> <p>FOLE DE TRANSMISSÃO LADO DA CAIXA</p> <p>DAIHATSU CHARADE (3) 1.0 TD G101 - 1.0 TURBO OHC G100(1987 A 1993)</p> <p>d67x85mm 1f-d58mm 1f-d18mm</p>
	<p>F1623-I NO. 04438-87F35</p> <p>FOLE DA TRANSMISSÃO JUNTO À RODA</p> <p>DAIHATSU SIRION (M1): 1.3 Sport 4WD 08.2000/03.2005 75KW 102CV 1298CC</p> <p>d82x86mm 1f-d69mm 1f-d21mm</p>		<p>KF1259-I NO. 04438-87110 - 04438-87F10</p> <p>KIT DE FOLE DA TRANSMISSÃO LADO DA CAIXA</p> <p>DAIHATSU CHARADE III (G100, G101, G102) 1.0 TD (G101) (De 03.1987 Até 12.1992) 35KW 48cv 993cm3 Hatchback - DAIHATSU CHARADE III (G100, G101, G102) 1.3 i (G102) (De 06.1988 Até 12.1992) 66KW 90cv 1296cm3 Hatchback - DAIHATSU CHARADE III (G100, G101, G102) 1.3 i 4WD (G102) (De 06.1988 Até 01.1993) 66KW 90cv 1296cm3 Hatchback - DAIHATSU CHARADE III três volumes (G102) 1.3 (De 11.1990 Até 02.1993) 6...</p> <p>d86x80mm 1f-d19mm 1f-d69mm</p>

	<p>KF1530 NO. 04438-87706</p> <p>KIT DE FOLE TRANSMISSAO</p> <p>DAIHATSU CHARADE 1.0 - 1.0I GTI OHC 04-87 A 9-93 - 1.0D 04-87 A 10-89 - 1.0 TD 04-87 A 12-94</p> <p>d77x84mm 1f-d65mm 1f-d18mm</p>		<p>KUBT3040 NO. 04478-B1010 - 04478-B2080 - 04478-B2150 - 04478-B2151 - 04479-97401 - 04479-97401-000 - 04479-97402</p> <p>KIT BORRACHAS TRAVAO FRENTE</p> <p>DAIHATSU CUORE VI (L251, L250, L260) MIRA CHARADE 1.0 desde 05.2003 43KW 58CV 989CC EJ-VE 7111379 7111AAA</p> <p>d62x9mm(x2) d57x3mm(x2) d117x26mm(x4) d54mm 1f-d5mm</p>
	<p>KUBT3040 NO. 04478-B1010 - 04478-B2080 - 04479-97401-000</p> <p>KIT BORRACHAS TRAVAO FRENTE</p> <p>DAIHATSU SIRION (M3_) BOON 1.0 (M300) 01.2005/06.2013 51KW 70CV 998CC 1KR-FE 7111381 7111AAF - DAIHATSU SIRION (M3_) BOON 1.0 LPG 01.2005/06.2013 51KW 70CV 998CC 1KR-FE - DAIHATSU SIRION (M3_) BOON 1.3 (M301) desde 01.2005 64KW 87CV 1298CC K3-VE 7111382 7111AAG - DAIHATSU SIRION (M3_) BOON 1.3 (M301) desde 03.2008 67KW 91CV 1298CC K3-VE 7111AAN - DAIHATSU SIRION (M3_) BOON 1.3 4WD desde ...</p> <p>d62x9mm(x2) d57x3mm(x2) d117x26mm(x4) d54mm 1f-d5mm</p>		<p>M6005 NO. 90048-17006 - 90048-17007 - 90048-17019 - 90048-18015</p> <p>JUNTA DE ESCAPE</p> <p>DAIHATSU CHARADE III (G100, G101, G102): 1.3 i (G102) 06.1988/12.1992 66KW 90CV 1295CC - DAIHATSU CHARADE III (G100, G101, G102): 1.3 i 4WD (G102) 06.1988/01.1993 66KW 90CV 1295CC - DAIHATSU CHARADE III três volumes (G102): 1.3 11.1990/02.1993 66KW 90CV 1295CC - DAIHATSU CHARADE IV (G200, G202): 1.3 09.1996/11.1999 44KW 60CV 1295CC - DAIHATSU CHARADE IV (G200, G202): 1.3 16V 05.1996/11.1999 55KW 7...</p> <p>d57x5mm 1f-d45mm</p>
	<p>M6005 NO. 90048-17006 - 90048-17007 - 90048-17019 - 90048-18015</p> <p>JUNTA DE ESCAPE</p> <p>DAIHATSU SIRION</p> <p>d57x5mm 1f-d45mm</p>		<p>M6022 NO. 9091706001 - 9091706038</p> <p>JUNTA DE ESCAPE</p> <p>DAIHATSU CHARADE (APÓS 1993)</p> <p>d52x5mm 1f-d39.5mm</p>
	<p>M6023 NO. 17451-B2020 - 17451-B2020-000 - 9091706026 - 9091706060</p> <p>JUNTA DE ESCAPE</p> <p>DAIHATSU CUORE</p> <p>d55x5mm 1f-d39mm</p>		<p>N2335 NO. 90301-360001-000</p> <p>ANEL ESCAPE</p> <p>DAIHATSU CHARADE</p> <p>d65x15mm 1f-d36mm</p>
	<p>N2336 NO. 3100099 - 31000995 - 7700518505 - 7703065102 - 9030134172 - 9030134207</p> <p>ANEL ESCAPE</p> <p>DAIHATSU CHARADE (1978 A 1983) - CUORE (1981 A 1985)</p> <p>d62x14mm 1f-d36mm</p>		<p>S1046 NO. 90043-85048 - 90043-85048-000</p> <p>SILENT-BLOC DAS MOLAS DA FRENTE PARTE DA FRENTE (GASTA 4 UNIDADES)</p> <p>DAIHATSU CHARADE III (G100, G101, G102): 1.0 (G100) 03.1987/12.1992 38KW 52CV 993CC - DAIHATSU CHARADE III (G100, G101, G102): 1.0 (G100) 11.1990/12.1992 40KW 54CV 993CC - DAIHATSU CHARADE III (G100, G101, G102): 1.0 (G100) 04.1989/12.1992 41KW 56CV 993CC - DAIHATSU CHARADE III (G100, G101, G102): 1.0 Turbo (G100) 03.1987/10.1990 50KW 68CV 993CC - DAIHATSU CHARADE III (G100, G101, G102): 1.0 GTI (...)</p> <p>d54x43mm d45mm 1f-d18mm</p>
	<p>S1939 NO. 48725-0D011 - 48725-0D040 - 48725-52030 - 48725-52040 - 48725-B1040</p> <p>SILENT-BLOC DO EIXO SUSPENSÃO TRÁS</p> <p>DAIHATSU SIRION (M3_): 1.0 01.2005/06.2013 51KW 70CV 998CC - DAIHATSU SIRION (M3_): 1.0 LPG 01.2005/06.2013 51KW 70CV 998CC - DAIHATSU SIRION (M3_): 1.3 (M301) 01.2005/»»» 64KW 87CV 1298CC - DAIHATSU SIRION (M3_): 1.3 4WD 04.2005/»»» 64KW 87CV 1298CC - DAIHATSU SIRION (M3_): 1.3 03.2008/»»» 67KW 91CV 1298CC - DAIHATSU SIRION (M3_): 1.3 4WD 03.2008/»»» 67KW 91CV 1298CC - DAIHATSU SIRION (M3_): 1.5 ...</p> <p>d77x 80mm c-43mm dc-55mm1f-d12mm</p>		<p>UTR0600 NO. 16401-23070 - 16401-41020 - 16401-41021</p> <p>TAMPÃO RADIADOR MODELO GRANDE 0,9 BAR (JAPONES)</p> <p>DAIHATSU CUORE I (L55, L60) 0.5 (L55) (De 1980.10 Até 1985.09) 20kW 27cv 547cm3 Hatchback - DAIHATSU CUORE I (L55, L60) 0.6 (L60) (De 1982.08 Até 1985.09) 22kW 30cv 617cm3 Hatchback -</p> <p>d59/79x28mm d38x23mm</p>
	<p>UTR0603 NO. 16401-72090 - 16401-87208</p> <p>TAMPÃO RADIADOR</p> <p>DAIHATSU CHARADE IV (G200, G202) 1.3 (De 1996.09 Até 1999.11) 44kW 60cv 1296cm3 Hatchback - DAIHATSU CHARADE IV (G200, G202) 1.3 16V (De 1996.05 Até 1999.11) 55kW 75cv 1296cm3 Hatchback - DAIHATSU CHARADE IV (G200, G202) 1.3 i 16V (De 1993.01 Até 2000.09) 62kW 84cv 1296cm3 Hatchback - DAIHATSU CHARADE IV (G200, G202) 1.5 i 16V (De 1997.01 Até 1999.11) 66kW 90cv 1499cm3 Hatchb...</p> <p>d68/43x21mm d29x17mm</p>		<p>UTR0603 NO. 16401-72090 - 16401-87208</p> <p>TAMPÃO RADIADOR</p> <p>DAIHATSU CUORE III (L201) 0.8 (De 1990.10 Até 1994.12) 30kW 41cv 847cm3 Hatchback - DAIHATSU CUORE IV (L501) 0.8 (De 1996.11 Até 1998.10) 31kW 42cv 847cm3 Hatchback - DAIHATSU CUORE IV (L501) 0.8 (De 1995.01 Até 1998.08) 32kW 43cv 847cm3 Hatchback -</p> <p>d68/43x21mm d29x17mm</p>
	<p>UTR0603 NO. 16401-72090 - 16401-87208</p> <p>TAMPÃO RADIADOR</p> <p>DAIHATSU MOVE (L6_) 0.8 (L601) (De 1997.01 Até 1999.11) 31kW 42cv 847cm3 Veículo multiuso -</p> <p>d68/43x21mm d29x17mm</p>		<p>UTR0603 NO. 16401-72090</p> <p>TAMPÃO RADIADOR</p> <p>LEXUS GS (JZS147_) 300 (JZS147_) (De 1993.01 Até 1997.08) 156kW 212cv 2997cm3 três volumes -</p> <p>d68/43x21mm d29x17mm</p>

	<p>UTR0608 NO. 16401-87206 - 16401-87512 - 16401-87602 - 16401-87710 - 16401-87711 - 1640187710000 - 1640187712 -</p> <p>TAMPÃO RADIADOR</p> <p>DAIHATSU CUORE II (L80, L81) 0.8 4WD (L81) (De 1986.09 Até 1988.10) 32kW 44cv 847cm3 Hatchback - DAIHATSU CUORE I (L55, L60) 0.5 (L55) (De 1980.10 Até 1985.09) 20kW 27cv 547cm3 Hatchback - DAIHATSU CUORE I (L55, L60) 0.6 (L60) (De 1982.08 Até 1985.09) 22kW 30cv 617cm3 Hatchback - DAIHATSU CUORE II (L80, L81) 0.8 (L80) (De 1989.11 Até 1990.12) 29kW 39cv 847cm3 Hatchback -</p> <p>d59/78x24mm d28x21mm</p>		<p>UTR0608 NO. 16401-87206 - 16401-87512 - 16401-87602 - 16401-87710 - 16401-87711 - 1640187710000 - 1640187712 -</p> <p>TAMPÃO RADIADOR</p> <p>DAIHATSU CHARADE I (G10) 1.0 (De 1977.10 Até 1981.02) 37kW 50cv 993cm3 Hatchback - DAIHATSU CHARADE I (G10) 1.0 (De 1981.02 Até 1983.02) 38kW 52cv 993cm3 Hatchback - DAIHATSU CHARADE II (G11, G30) 1.0 (G11) (De 1983.10 Até 1987.03) 38kW 52cv 993cm3 Hatchback - DAIHATSU CHARADE II (G11, G30) 1.0 Turbo (G11) (De 1983.10 Até 1987.03) 50kW 68cv 993cm3 Hatchback -</p> <p>d59/78x29mm d38x24mm</p>
	<p>UTR0624 NO. MB007570</p> <p>TAMPÃO DO RADIADOR</p> <p>DAIHATSU CHARADE I (G10) 1.0 (De 1977.10 Até 1981.02) 37kW 50cv 993cm3 Hatchback - DAIHATSU CHARADE I (G10) 1.0 (De 1981.02 Até 1983.02) 38kW 52cv 993cm3 Hatchback -</p> <p>d59/78x29mm d38x24mm</p>		<p>UTR0624 NO. MB007570</p> <p>TAMPÃO DO RADIADOR</p> <p>DAIHATSU CUORE I (L55, L60) 0.5 (L55) (De 1980.10 Até 1985.09) 20kW 27cv 547cm3 Hatchback -</p> <p>d59/78x29mm d38x24mm</p>
	<p>UTR1207 NO. 16471-23030</p> <p>TAMPÃO DO RESERVATÓRIO LAVA-VIDROS</p> <p>DAIHATSU CHARADE VIII 1.33 16V desde 05.2011 73KW 99CV 1329CC 1NR-FE 5013AHD</p> <p>d42x11mm 1f-d37x5mm</p>		<p>Z9011 NO. 1715287201 - 1715287201000 - 1715287702 - 1715287702000 - 1715297201000</p> <p>MOLA DE ESCAPE</p> <p>DAIHATSU SIRION</p> <p>d23x42mm</p>

DAIHATSU CHARMANT

	<p>M6005 NO. 90048-17006 - 90048-17007 - 90048-17019 - 90048-18015</p> <p>JUNTA DE ESCAPE</p> <p>DAIHATSU CHARMANT (A): 1.6 (A45) 12.1981/09.1984 55KW 75CV 1588CC - DAIHATSU CHARMANT (A): 1.6 (A60) 08.1983/07.1987 61KW 83CV 1587CC</p> <p>d57x5mm 1f-d45mm</p>		<p>M6007 NO. 90917-06005</p> <p>JUNTA DO COLECTOR DE ESCAPE</p> <p>DAIHATSU CHARMANT</p> <p>d67x5mm 1f-d56mm</p>
	<p>M6022 NO. 9091706001 - 9091706038</p> <p>JUNTA DE ESCAPE</p> <p>DAIHATSU CHARMANT (1981 A 1988)</p> <p>d52x5mm 1f-d39.5mm</p>		<p>M6023 NO. 17451-B2020 - 17451-B2020-000 - 9091706026 - 9091706060</p> <p>JUNTA DE ESCAPE</p> <p>DAIHATSU CHARMANT (A) 1.6 (A60) 08.1983/07.1987 61KW 83CV 1587CC 4A 7111309 - DAIHATSU CHARMANT (A) 1.6 (A60) 09.1985/07.1987 57KW 78CV 1588CC 4A 7111317</p> <p>d55x5mm 1f-d39mm</p>
	<p>M6034 NO.</p> <p>JUNTA DE ESCAPE</p> <p>DAIHATSU CHARMANT (1981 A 1988)</p> <p>127x58mm 2f-d38mm</p>		<p>N2335 NO. 90301-360001-000</p> <p>ANEL ESCAPE</p> <p>DAIHATSU CHARMANT</p> <p>d65x15mm 1f-d36mm</p>
	<p>N2336 NO. 9030134172 - 9030134207</p> <p>ANEL ESCAPE</p> <p>DAIHATSU CHARMANT (1981 A 1988)</p> <p>d62x14mm 1f-d36mm</p>		<p>R0609 NO. 16572-13020</p> <p>TUBO SUPERIOR DO RADIADOR</p> <p>DAIHATSU CHARMANT (A) 1.3 (A35) 11.1981/07.1987 48KW 65CV 1290CC 4K 7111304</p> <p>B235-d34/34mm 180-145mm</p>







	R220284 NO. 16572-13020 TUBO DE RADIADOR SUPERIOR DAIHATSU CHARMANT (A): 1.3 (A35) 11.1981/07.1987 48KW 65CV 1290CC		S1187 NO. 48654-12010 SILENT-BLOC DO BRAÇO INFERIOR DA SUSPENSÃO DAIHATSU CHARMANT (A): 1.3 (A35) 11.1981/07.1987 48KW 65CV 1290CC - DAIHATSU CHARMANT (A): 1.6 (A45) 12.1981/09.1984 55KW 75CV 1588CC - DAIHATSU CHARMANT (A): 1.6 (A60) 09.1985/07.1987 57KW 78CV 1588CC - DAIHATSU CHARMANT (A): 1.6 (A60) 05.1986/07.1987 60KW 82CV 1587CC - DAIHATSU CHARMANT (A): 1.6 (A60) 08.1983/07.1987 61KW 83CV 1587CC
	T1039 NO. 48815-14020 - 48815-20050 - 48815-38010 BATENTE BARRA ESTABILIZADORA FRENTE DO CENTRO DIAMETRO 22MM (GASTA 2 UNIDADES) DAIHATSU CHARMANT (A): 1.3 (A35) 11.1981/07.1987 48KW 65CV 1290CC - DAIHATSU CHARMANT (A): 1.6 (A45) 12.1981/09.1984 55KW 75CV 1588CC - DAIHATSU CHARMANT (A): 1.6 (A60) 09.1985/07.1987 57KW 78CV 1588CC - DAIHATSU CHARMANT (A): 1.6 (A60) 05.1986/07.1987 60KW 82CV 1587CC - DAIHATSU CHARMANT (A): 1.6 (A60) 08.1983/07.1987 61KW 83CV 1587CC		UTR0600 NO. 16401-23070 - 16401-41020 - 16401-41021 TAMPÃO RADIADOR MODELO GRANDE 0,9 BAR (JAPONES) DAIHATSU CHARMANT (A) 1.3 (A35) (De 1981.11 Até 1987.07) 48KW 65CV 1290cm3 três volumes - DAIHATSU CHARMANT (A) 1.6 (A45) (De 1981.12 Até 1984.09) 55KW 75CV 1588cm3 três volumes - DAIHATSU CHARMANT (A) 1.6 (A60) (De 1985.09 Até 1987.07) 57KW 78CV 1588cm3 três volumes - DAIHATSU CHARMANT (A) 1.6 (A60) (De 1986.05 Até 1987.07) 60KW 82CV 1587cm3 três volumes - DAIHATSU CHARMANT (A) 1.6 (A60) (De 1983.07 Até 1987.07) 61KW 83CV 1587cm3 três volumes -
	UTR0608 NO. 16401-87206 - 16401-87512 - 16401-87602 - 16401-87710 - 16401-87711 - 1640187710000 - 1640187712 - TAMPÃO RADIADOR DAIHATSU CHARMANT (A) 1.3 (A35) (De 1981.11 Até 1987.07) 48KW 65CV 1290cm3 três volumes - DAIHATSU CHARMANT (A) 1.6 (A45) (De 1981.12 Até 1984.09) 55KW 75CV 1588cm3 três volumes - DAIHATSU CHARMANT (A) 1.6 (A60) (De 1985.09 Até 1987.07) 57KW 78CV 1588cm3 três volumes - DAIHATSU CHARMANT (A) 1.6 (A60) (De 1986.05 Até 1987.07) 60KW 82CV 1587cm3 três volumes -		UTR0624 NO. MB007570 TAMPÃO DO RADIADOR DAIHATSU CHARMANT (A) 1.3 (A35) (De 1981.11 Até 1987.07) 48KW 65CV 1290cm3 três volumes - DAIHATSU CHARMANT (A) 1.6 (A45) (De 1981.12 Até 1984.09) 55KW 75CV 1588cm3 três volumes - DAIHATSU CHARMANT (A) 1.6 (A60) (De 1985.09 Até 1987.07) 57KW 78CV 1588cm3 três volumes - DAIHATSU CHARMANT (A) 1.6 (A60) (De 1986.05 Até 1987.07) 60KW 82CV 1587cm3 três volumes -

DAIHATSU DELTA

	A1270 NO. 37208-87302 - 37208-87302-000 - 37208-87302-600 APOIO DE TRANSMISSÃO COM ROLAMENTO 35MM DAIHATSU DELTA DV57 DV58 - DAIHATSU DELTA DV26 3500KG - DAIHATSU DELTA V22 V201 - DAIHATSU DELTA V12, V22, V32 - DAIHATSU DELTA V118 V116 V10 - DAIHATSU DELTA (V12, V76 V11 #) - DAIHATSU DELTA Trucks - Série V 1977-2003 - DAIHATSU DELTA V67 V68 V69 9/84 LIGADO - DAIHATSU DELTA V30 V31 V32 V34 V35 V36 1978-84 - DAIHATSU DELTA V76 V78 V79 1977 LIGADO - DAIHATSU DELTA V57 V58 V59 9/84 LIGADO - DAIHATSU DELTA...		A1361 NO. 12361-87381-000 APOIO DE MOTOR (GASTA 2 UNIDADES) DAIHATSU DELTA V10 08.1977/08.1984 - DAIHATSU DELTA V10D 08.1977/08.1984 - DAIHATSU DELTA V11M 08.1977/08.1984 - DAIHATSU DELTA V12 08.1977/08.1984 - DAIHATSU DELTA V13 - DAIHATSU DELTA V15 08.1977/08.1984 - DAIHATSU DELTA V17 08.1977/08.1984 - DAIHATSU DELTA V17D 08.1977/08.1984 - DAIHATSU DELTA V17E 08.1977/08.1984 - DAIHATSU DELTA V18 08.1977/08.1984 - DAIHATSU DELTA V20 08.1977/08.1984 - DAIHATSU DELTA...
	L1034 NO. 90043-85049 - 90043-85049-000 CASQUILHO DE MOLAS DE TRÁS PARTE DE TRÁS (GASTA 8 UNIDADES) DAIHATSU FERROZA Hard Top (F300) SPORTRAK 1.6 16V 4x4 10.1988/12.1999 63KW 86CV 1590CC HD-C 7111334 - DAIHATSU FERROZA Hard Top (F300) SPORTRAK 1.6 i 16V 4x4 10.1988/12.1999 70KW 95CV 1590CC HD-E 7111336 - DAIHATSU FERROZA Soft Top (F300) SPORTRAK 1.6 16V 10.1988/12.1999 63KW 86CV 1590CC HD-C 7111333 - DAIHATSU FERROZA Soft Top (F300) SPORTRAK 1.6 i 16V 10.1988/12.1999 70KW 95CV 1590CC HD-E 71...		L3067 NO. 90043-85047 - 90043-85047-000 CASQUILHO DE MOLAS DE TRÁS PARTE DE TRÁS (GASTA 8 UNIDADES) DAIHATSU DELTA
	S1046 NO. 90043-85048 - 90043-85048-000 SILENT-BLOC DAS MOLAS DA FRENTE PARTE DA FRENTE (GASTA 4 UNIDADES) DAIHATSU DELTA V10 08.1977/08.1984 - DAIHATSU DELTA V10D 08.1977/08.1984 - DAIHATSU DELTA V11M 08.1977/08.1984 - DAIHATSU DELTA V12 08.1977/08.1984 - DAIHATSU DELTA V13 - DAIHATSU DELTA V15 08.1977/08.1984 - DAIHATSU DELTA V17 08.1977/08.1984 - DAIHATSU DELTA V17D 08.1977/08.1984 - DAIHATSU DELTA V17E 08.1977/08.1984 - DAIHATSU DELTA V18 08.1977/08.1984 - DAIHATSU DELTA V20 08.1977/08.1984 - DAIHATSU DELTA...		

	<p>A0980 NO. 12361-87306 - 12361-87603</p> <p>APOIO DO MOTOR</p> <p>DAIHATSU ROCKY Soft Top (F7, F8): 2.0 (F70, F75, F80, F85) 02.1985 - 04.1993 65KW 88CV 1998CC - DAHATSU ROCKY Soft Top (F7, F8): 2.8 TD 12.1987 - 04.1993 67KW 91CV 2765CC - DAHATSU ROCKY Soft Top (F7, F8): 2.8 D (F70, F75, F80, F85) FEV/85/DEZ98 54KW 73CV 2765CC - DAHATSU ROCKY Soft Top (F7, F8): 2.8 TD 09.1991 - 12.1998 75KW 102CV 2765CC - DAHATSU ROCKY Hard Top (F7, F8): 2.0 4x4 (F70, F75, F...)</p> <p>135x89x50mm 1p-d12-26mm</p>		<p>A1770 NO. 12371-87607 - 1237187607000 - 42236-81400</p> <p>APOIO CAIXA VELOCIDADES</p> <p>DAIHATSU ROCKY Hard Top (F7, F8) 2.0 4x4 (F70, F75, F80, F85) 02.1985/04.1993 65KW 88CV 1998CC 3Y 7111330 - DAHATSU ROCKY Hard Top (F7, F8) 2.8 D (F70, F75, F80, F85) 02.1985/12.1998 54KW 73CV 2765CC DL 7111326 - DAHATSU ROCKY Hard Top (F7, F8) 2.8 TD 05.1993/12.1998 72KW 98CV 2765CC DLT-C DL 52 7111349 7111359 - DAHATSU ROCKY Hard Top (F7, F8) 2.8 TD (F70, F75, F80, F85) 12.1987/04.1993 67KW 9...</p> <p>110x102x36mm 2p-d10-28mm 2f-d9mm</p>
	<p>A1770 NO. 12371-87607 - 1237187607000 - 42236-81400</p> <p>APOIO CAIXA VELOCIDADES</p> <p>DAIHATSU FEROZA Hard Top (F300) 1.6 16V 4x4 10.1988/12.1999 63KW 86CV 1590CC HD-C 7111334 - DAHATSU FEROZA Hard Top (F300) 1.6 i 16V 4x4 10.1988/12.1999 70KW 95CV 1590CC HD-E 7111336 - DAHATSU FEROZA Soft Top (F300) 1.6 16V 10.1988/12.1999 63KW 86CV 1590XX HD-C 7111333 - DAHATSU FEROZA Soft Top (F300) 1.6 i 16V 10.1988/12.1999 70KW 95CV 1590CC HD-E 7111335</p> <p>110x102x36mm 2p-d10-28mm 2f-d9mm</p>		<p>A2513 NO. 12362-87401 - 12362-87401-000 - 12362-87403 - 12362-87403-000</p> <p>APOIO DO MOTOR PARTE DA FRENTE LADO ESQUERDO</p> <p>DAIHATSU TERIOS (J1_) 1.3 07.2000/10.2006 63KW 86CV 1298CC K3-VE 7111376 - DAHATSU TERIOS (J1_) 1.3 4WD (J100) 10.1997/10.2000 61KW 83CV 1296CC HC-EJ 7111360 - DAHATSU TERIOS (J1_) 1.3 4WD (J102) 10.2000/10.2005 63KW 86CV 1298CC K3-VE 7111372</p> <p>147x100x92mm 1p-d12x22mm 2f-12x14mm</p>
	<p>A2619 NO. 37100-B4020 - 37100B4010</p> <p>APOIO DA TRANSMISSÃO</p> <p>DAIHATSU TERIOS (J2_) 1.3 VVT-i 4x4 desde 11.2005 63KW 86CV 1298CC K3-VE 7111AAE - DAHATSU TERIOS (J2_) 1.5 4x4 desde 05.2006 77KW 105CV 1495CC 3SZ-VE 7111AAC - DAHATSU TERIOS (J2_) 1.5 LPG 4x4 desde 06.2009 77KW 105CV 1495CC 3SZ-VE - DAHATSU TERIOS (J2_) 1.5 VVT-i 4x4 desde 09.2010 75KW 102CV 1495CC 3SZ-VE 7111AAQ - DAHATSU TERIOS (J2_) 1.5 VVT-i RWD desde 11.2005 77KW 105CV 1495CC 3SZ-VE 711...</p> <p>244x49x128mm 1f-d25mm 1f-10x20mm 1f-12x22mm</p>		<p>A2653 NO. 12361-87306 - 1236187607</p> <p>APOIO DO MOTOR</p> <p>DAIHATSU FEROZA Hard Top (F300) SPORTRAK 1.6 16V 4x4 10.1988/12.1999 63KW 86CV 1590CC HD-C 7111334 - DAHATSU FEROZA Hard Top (F300) SPORTRAK 1.6 i 16V 4x4 10.1988/12.1999 70KW 95CV 1590CC HD-E 7111336 - DAHATSU FEROZA Soft Top (F300) SPORTRAK 1.6 16V 10.1988/12.1999 63KW 86CV 1590CC HD-C 7111333 - DAHATSU FEROZA Soft Top (F300) SPORTRAK 1.6 i 16V 10.1988/12.1999 70KW 95CV 1590CC HD-E 71...</p> <p>132x95x45mm 2f-d12mm 1p-d12x22mm</p>
	<p>A2654 NO. 12361-87603</p> <p>APOIO DO MOTOR</p> <p>DAIHATSU ROCKY Hard Top (F7, F8) FOURTRAK 2.0 4x4 (F70, F75, F80, F85) 02.1985/04.1993 65KW 88CV 1998CC 3Y 7111330 - DAHATSU ROCKY Hard Top (F7, F8) FOURTRAK 2.8 D (F70, F75, F80, F85) 02.1985/12.1998 54KW 73CV 2765CC DL 7111326 - DAHATSU ROCKY Hard Top (F7, F8) FOURTRAK 2.8 TD 05.1993/12.1998 72KW 98CV 2765, G DL-TC DL-52 7111349 7111359 - DAHATSU ROCKY Hard Top (F7, F8) FOURTRAK 2.8 TD...</p> <p>143x108x47mm 2f-d12mm 1p-d12x27mm</p>		<p>A2654 NO. 12361-87603</p> <p>APOIO DO MOTOR</p> <p>DAIHATSU ROCKY Soft Top (F7, F8) FOURTRAK 2.0 (F70, F75, F80, F85) 02.1985/04.1993 65KW 88CV 1998CC 3Y 7111329 - DAHATSU ROCKY Soft Top (F7, F8) FOURTRAK 2.8 D (F70, F75, F80, F85) 02.1985/12.1998 54KW 73CV 2765CC DL 7111325 - DAHATSU ROCKY Soft Top (F7, F8) FOURTRAK 2.8 TD 12.1987/04.1993 67KW 91CV 2765CC DL-51 7111327 - DAHATSU ROCKY Soft Top (F7, F8) FOURTRAK 2.8 TD 09.1991/12.1998 7...</p> <p>143x108x47mm 2f-d12mm 1p-d12x27mm</p>
	<p>A2697 NO. 12361-87401-000 - 12361-87401 - 12361-87403</p> <p>APOIO DO MOTOR PARTE DA FRENTE LADO DIREITO</p> <p>DAIHATSU TERIOS (J1_) TARUNA 1.3 4WD (J100) 10.1997/10.2000 61KW 83CV 1296CC HC-EJ 7111360</p> <p>146x96x56mm 2p-12x14mm 1p-d12x18mm</p>		<p>A2733 NO. 37100-87402 - 37100-87405 - 37100-87401 - 37100-87403</p> <p>APOIO CENTRAL DA TRANSMISSÃO</p> <p>DAIHATSU TERIOS (J1_) TARUNA 1.3 (J122) 07.2000/10.2006 63KW 86CV 1298CC K3-VE 7111376 - DAHATSU TERIOS (J1_) TARUNA 1.3 4WD (J100) 10.1997/10.2000 61KW 83CV 1296CC HC-EJ 7111360 - DAHATSU TERIOS (J1_) TARUNA 1.3 4WD (J102) 10.2000/10.2005 63KW 86CV 1298CC K3-VE 7111372</p> <p>213x49x93mm 1f-d20mm 1f-11x16mm 1f-13x18mm</p>
	<p>E0018 NO. 17565-15010 - 17565-63030 - 17567-87101 - 17567-87210 - 17567-87703 - 17577-87704</p> <p>ESTICADOR DE ESCAPE</p> <p>DAIHATSU ROCKY Hard Top (F7, F8) 2.0 4x4 (F70, F75, F80, F85) 02.1985/04.1993 65KW 88CV 1998CC 3Y 7111330 - DAHATSU ROCKY Hard Top (F7, F8) 2.8 D (F70, F75, F80, F85) 02.1985/12.1998 54KW 73CV 2765CC DL 7111326 - DAHATSU ROCKY Hard Top (F7, F8) 2.8 TD (F70, F75, F80, F85) 12.1987/04.1993 67KW 91CV 2765CC DL 51 7111328 - DAHATSU ROCKY Soft Top (F7, F8) 2.0 (F70, F75, F80, F85) 02.1985/04.1993 65...</p> <p>68x54x25mm</p>		<p>E0029 NO. 17553-87201 - 17553-87202 - 1755387202 - 17565-15050 - 17565-15070 - 17565-16230 - 17565-28020 - 175...</p> <p>ESTICADOR DE ESCAPE</p> <p>DAIHATSU TERIOS</p> <p>60x50x27mm</p>
	<p>E0029 NO. 17553-87201 - 17553-87202 - 1755387202 - 17565-15050 - 17565-15070 - 17565-16230 - 17565-28020 - 175...</p> <p>ESTICADOR DE ESCAPE</p> <p>DAIHATSU FEROZA</p> <p>60x50x27mm</p>		<p>E1012 NO. 17553 - 17567-87704 - 87603</p> <p>ESTICADOR DE ESCAPE</p> <p>DAIHATSU FEROZA Hard Top (F300) 1.6 16V 4x4 10.1988/12.1999 63KW 86CV 1590CC HD-C 7111334 - DAHATSU FEROZA Hard Top (F300) 1.6 i 16V 4x4 10.1988/12.1999 70KW 95CV 1590CC HD-E 7111336 - DAHATSU FEROZA Soft Top (F300) 1.6 16V 10.1988/12.1999 63KW 86CV 1590CC HD-C 7111333 - DAHATSU FEROZA Soft Top (F300) 1.6 i 16V 10.1988/12.1999 70KW 95CV 1590CC HD-E 7111335</p> <p>68x42x15mm</p>
	<p>F1623-I NO. 04438-87F35</p> <p>FOLE DA TRANSMISSÃO JUNTO À RODA</p> <p>DAIHATSU TERIOS (J1_) : 1.3 4WD (J100) 10.1997/10.2000 61KW 83CV 1296CC - DAHATSU TERIOS (J1_) : 1.3 4WD (J102) 10.2000/10.2005 63KW 86CV 1298CC</p> <p>d82x86mm 1f-d69mm 1f-d21mm</p>		<p>L0230 NO. 48815-87602 - 90385-11021-000</p> <p>CASQUILHO BARRA ESTABILIZADORA DIAMETRO 10MM (GASTA 2 UNIDADES)</p> <p>DAIHATSU ROCKY Soft Top (F7, F8): 2.0 (F70, F75, F80, F85) 02.1985/04.1993 65KW 88CV 1998CC - DAHATSU ROCKY Soft Top (F7, F8): 2.8 TD 12.1987/04.1993 67KW 91CV 2765CC - DAHATSU ROCKY Soft Top (F7, F8): 2.8 D (F70, F75, F80, F85) 02.1985/12.1998 54KW 73CV 2765CC - DAHATSU ROCKY Soft Top (F7, F8): 2.8 TD 09.1991/12.1998 75KW 102CV 2765CC - DAHATSU ROCKY Hard Top (F7, F8): 2.0 4x4 (F70, F75, F80, F85)...</p> <p>d25x26mm d22mm 1f-d12mm</p>

	<p>L3181 NO. 41198-87403-000</p> <p>CASQUILHO DE APOIO DO DIFERENCIAL</p> <p>DAIHATSU TERIOS (J1_) 1.3 4WD (J100) (De 10.1997 Até 10.2000) 8786kW 61cv 83cm3 1296 -</p> <p>d44x28mm 1f-d16mm</p>		<p>L3204 NO. 41197-87402 - 41197-87402-000</p> <p>CASQUILHO DO SUPORTE DIFERENCIAL</p> <p>DAIHATSU TERIOS (J1_) TARUNA 1.3 (J122) 07.2000/10.2006 63KW 86CV 1298CC K3-VE 7111376 - DAIHATSU TERIOS (J1_) TARUNA 1.3 4WD (J100) 10.1997/10.2000 61KW 83CV 1296CC HC-EJ 7111360 - DAIHATSU TERIOS (J1_) TARUNA 1.3 4WD (J102) 10.2000/10.2005 63KW 86CV 1298CC K3-VE 7111372</p> <p>d45x17mm 1f-d17mm</p>
	<p>M6005 NO. 90048-17006 - 90048-17007 - 90048-17019 - 90048-18015</p> <p>JUNTA DE ESCAPE</p> <p>DAIHATSU FEROZA Soft Top (F300): 1.6 16V 10.1988/12.1999 63KW 86CV 1590CC - DAIHATSU FEROZA Soft Top (F300): 1.6 i 16V 10.1988/12.1999 70KW 95CV 1590CC - DAIHATSU FEROZA Hard Top (F300): 1.6 16V 4x4 10.1988/12.1999 63KW 86CV 1590CC - DAIHATSU FEROZA Hard Top (F300): 1.6 i 16V 4x4 10.1988/12.1999 70KW 95CV 1590CC</p> <p>d57x5mm 1f-d45mm</p>		<p>M6005 NO. 90048-17006 - 90048-17007 - 90048-17019 - 90048-18015</p> <p>JUNTA DE ESCAPE</p> <p>DAIHATSU TERIOS (J1_) : 1.3 4WD (J100) 10.1997/10.2000 61KW 83CV 1296CC</p> <p>d57x5mm 1f-d45mm</p>
	<p>M6005 NO. 90048-17006 - 90048-17007 - 90048-17019 - 90048-18015</p> <p>JUNTA DE ESCAPE</p> <p>DAIHATSU ROCKY</p> <p>d57x5mm 1f-d45mm</p>		<p>M6008 NO. 9004817011 - 9091706008 - 9091706012 - 9091706045 - 9091706047</p> <p>JUNTA DE ESCAPE</p> <p>DAIHATSU ROCKY Soft Top (F7, F8): 2.8 TD 12.1987/04.1993 67KW 91CV 2765CC - DAIHATSU ROCKY Soft Top (F7, F8): 2.8 D (F70, F75, F80, F85) 02.1985/12.1998 54KW 73CV 2765CC - DAIHATSU ROCKY Hard Top (F7, F8): 2.8 D (F70, F75, F80, F85) 02.1985/12.1998 54KW 73CV 2765CC - DAIHATSU ROCKY Hard Top (F7, F8): 2.8 TD (F70, F75, F80, F85) 12.1987/04.1993 67KW 91CV 2765CC - DAIHATSU WILDCAT/ROCKY (F70): 2.8 D...</p> <p>d65x5mm 1f-d50mm</p>
	<p>M6023 NO. 17451-B2020 - 17451-B2020-000 - 9091706026 - 9091706060</p> <p>JUNTA DE ESCAPE</p> <p>DAIHATSU ROCKY Hard Top (F7, F8) 2.0 4x4 (F70, F75, F80, F85) 02.1985/04.1993 65KW 88CV 1998CC 3Y 7111330 - DAIHATSU ROCKY Soft Top (F7, F8) 2.0 (F70, F75, F80, F85) 02.1985/04.1993 65KW 88CV 1998CC 3Y 7111329</p> <p>d55x5mm 1f-d39mm</p>		<p>R227046 NO. 16571-87623 - 90916-01156</p> <p>TUBO SUPERIOR DO RADIADOR</p> <p>DAIHATSU FEROZA Hard Top (F300) 1.6 16V 4x4 10.1988/12.1999 63KW 86CV 1590CC HD-C 7111334 - DAIHATSU FEROZA Hard Top (F300) 1.6 i 16V 4x4 10.1988/12.1999 70KW 95CV 1590CC HD-E 7111336 - DAIHATSU FEROZA Soft Top (F300) 1.6 16V 10.1988/12.1999 63KW 86CV 1590CC HD-C 7111333 - DAIHATSU FEROZA Soft Top (F300) 1.6 i 16V 10.1988/12.1999 70KW 95CV 1590CC HD-E 7111335</p> <p>B175-d30/d31mm 74-42-62mm</p>
	<p>S1062 NO. 90043-85046 - 90043-85046-000 - 9004385046000</p> <p>SILENT-BLOC DAS MOLAS DA FRENTE PARTE DA FRENTE (GASTA 2 UNIDADES)</p> <p>DAIHATSU FEROZA Hard Top (F300) 1.6 16V 4x4 10.1988/12.1999 63KW 86CV 1590CC HD-C 7111334 - DAIHATSU FEROZA Hard Top (F300) 1.6 i 16V 4x4 10.1988/12.1999 70KW 95CV 1590CC HD-E 7111336 - DAIHATSU FEROZA Soft Top (F300) 1.6 16V 10.1988/12.1999 63KW 86CV 1590CC HD-C 7111333 - DAIHATSU FEROZA Soft Top (F300) 1.6 i 16V 10.1988/12.1999 70KW 95CV 1590CC HD-E 7111335</p> <p>d36x76mm c70mm 1f-d16mm</p>		<p>S1062 NO. 90043-85046 - 90043-85046-000 - 9004385046000</p> <p>SILENT-BLOC DAS MOLAS DA FRENTE PARTE DA FRENTE (GASTA 2 UNIDADES)</p> <p>DAIHATSU ROCKY Hard Top (F7, F8) 2.0 4x4 (F70, F75, F80, F85) 02.1985/04.1993 65KW 88CV 1998CC 3Y 7111330 - DAIHATSU ROCKY Hard Top (F7, F8) 2.8 D (F70, F75, F80, F85) 02.1985/12.1998 54KW 73CV 2765CC DL 7111326 - DAIHATSU ROCKY Hard Top (F7, F8) 2.8 TD 05.1993/12.1998 72KW 98CV 2765CC DLT-C DL 52 7111349 7111359 - DAIHATSU ROCKY Hard Top (F7, F8) 2.8 TD (F70, F75, F80, F85) 12.1987/04.1993 67KW 9...</p> <p>d36x76mm c70mm 1f-d16mm</p>
	<p>S1062-B NO. 90043-85046</p> <p>SILENT-BLOC DE MOLAS DA FRENTE (OLHAL DA FRENTE)</p> <p>DAIHATSU FEROZA Hard Top (F300) 1.6 16V 4x4 10.1988/12.1999 63KW 86CV 1590CC HD-C 7111334 - DAIHATSU FEROZA Hard Top (F300) 1.6 i 16V 4x4 10.1988/12.1999 70KW 95CV 1590CC HD-E 7111336 - DAIHATSU FEROZA Soft Top (F300) 1.6 16V 10.1988/12.1999 63KW 86CV 1590CC HD-C 7111333 - DAIHATSU FEROZA Soft Top (F300) 1.6 i 16V 10.1988/12.1999 70KW 95CV 1590CC HD-E 7111335</p> <p>d36x76mm c70mm 1f-d16mm</p>		<p>S1062-B NO. 90043-85046</p> <p>SILENT-BLOC DE MOLAS DA FRENTE (OLHAL DA FRENTE)</p> <p>DAIHATSU ROCKY Hard Top (F7, F8) 2.0 4x4 (F70, F75, F80, F85) 02.1985/04.1993 65KW 88CV 1998CC 3Y 7111330 - DAIHATSU ROCKY Hard Top (F7, F8) 2.8 D (F70, F75, F80, F85) 02.1985/12.1998 54KW 73CV 2765CC DL 7111326 - DAIHATSU ROCKY Hard Top (F7, F8) 2.8 TD 05.1993/12.1998 72KW 98CV 2765CC DLT-C DL 52 7111349 7111359 - DAIHATSU ROCKY Hard Top (F7, F8) 2.8 TD (F70, F75, F80, F85) 12.1987/04.1993 67KW 9...</p> <p>d36x76mm c70mm 1f-d16mm</p>
	<p>S1724 NO. 41651-B4030 - 51205-B4010</p> <p>SILENT-BLOC DO APOIO DIFERENCIAL PARTE DE TRÁS E FRENTE ESQUERDO</p> <p>DAIHATSU TERIOS (J2_) : 1.5 4x4 05.2006/>>>> 77KW 105CV 1495CC</p> <p>d56x60mm c38mm 1f-d10mm</p>		<p>S2152 NO. 48530-59185 - 48530-59395 - 48706-52010 - 48706-B4010 - 48706-B2030 - 48530-59187 - 48706-B2041 - 48706-B2042</p> <p>SILENT-BLOC DO BRAÇO SUSPENSÃO TRÁS DIREITO</p> <p>DAIHATSU TERIOS (J2_, F7_) BEGO 1.3 VVT-i 4x4 desde 11.2005 63KW 86CV 1298CC K3-VE 7111AAE - DAIHATSU TERIOS (J2_, F7_) BEGO 1.5 4x4 desde 05.2006 77KW 105CV 1495CC 3SZ-VE 7111AAC - DAIHATSU TERIOS (J2_, F7_) BEGO 1.5 LPG 4x4 desde 06.2009 77KW 105CV 1495CC 3SZ-VE - DAIHATSU TERIOS (J2_, F7_) BEGO 1.5 VVT-i 4x4 desde 09.2010 75KW 102CV 1495CC 3SZ-VE 7111AAQ - DAIHATSU TERIOS (J2_, F7_)...</p> <p>d32x40mm d31mm-1f-d12mm</p>
	<p>T1039 NO. 48815-14020 - 48815-20050 - 48815-38010</p> <p>BATENTE BARRA ESTABILIZADORA FRENTE DO CENTRO DIAMETRO 22MM (GASTA 2 UNIDADES)</p> <p>DAIHATSU ROCKY Soft Top (F7, F8): 2.0 (F70, F75, F80, F85) 02.1985/04.1993 65KW 88CV 1998CC - TOYOTA ROCKY Soft Top (F7, F8): 2.8 TD 12.1987/04.1993 67KW 91CV 2765CC - DAIHATSU ROCKY Soft Top (F7, F8): 2.8 TD 09.1991/12.1998 75KW 102CV 2765CC - DAIHATSU ROCKY Hard Top (F7, F8): 2.0 4x4 (F70, F75, F80, F85) 02.1985/04.1993 65KW 88CV 1998CC - DAIHATSU ROCKY Hard Top (F7, F8): 2.8 TD (F70, F75, F80)...</p> <p>39x39x36mm 1f-d22mm</p>		<p>T1039 NO. 48815-14020 - 48815-20050 - 48815-38010</p> <p>BATENTE BARRA ESTABILIZADORA FRENTE DO CENTRO DIAMETRO 22MM (GASTA 2 UNIDADES)</p> <p>DAIHATSU TERIOS (J1_) : 1.3 4WD (J100) 10.1997/10.2000 61KW 83CV 1296CC - DAIHATSU TERIOS (J1_) : 1.3 4WD (J102) 10.2000/10.2005 63KW 86CV 1298CC</p> <p>39x39x36mm 1f-d22mm</p>

	<p>UCRZ1081 NO. 37100-87401 - 37100-87402 - 37100-87405</p> <p>CRUZETA TRANSMISSÃO VEIO LONGITUDINAL D22X35MM</p> <p>DAIHATSU TERIOS (J1_) 1.3 (De 07.2000 Até 10.2006) 63kW 86cv 1298cm3 Veículo todo-terreno fechado - DAIHATSU TERIOS (J1_) 1.3 4WD (J100) (De 10.1997 Até 10.2000) 61kW 83cv 1296cm3 Veículo todo-terreno fechado - DAIHATSU TERIOS (J1_) 1.3 4WD (J102) (De 10.2000 Até 10.2005) 63kW 86cv 1298cm3 Veículo todo-terreno fechado -</p> <p>d22x57x41mm</p>		<p>UCRZ1098 NO. 04371-B5030 - 37100-B4010 - 37100-B4020</p> <p>CRUZETA VEIO TRANSMISSÃO LONGITUDINAL D25X43MM</p> <p>DAIHATSU TERIOS (J2_) BEGO 1.3 VVT-i 4x4 desde 11.2005 63KW 86CV 1298CC K3-VE 7111AAE - DAIHATSU TERIOS (J2_) BEGO 1.5 4x4 desde 05.2006 77KW 105CV 1495CC 3SZ-VE 7111AAC - DAIHATSU TERIOS (J2_) BEGO 1.5 LPG 4x4 desde 06.2009 77KW 105CV 1495CC 3SZ-VE - DAIHATSU TERIOS (J2_) BEGO 1.5 VVT-i 4x4 desde 09.2010 75KW 102CV 1495CC 3SZ-VE 7111AAQ - DAIHATSU TERIOS (J2_) BEGO 1.5 VVT-i RWD desde 1...</p> <p>d25mm</p>
	<p>UTR0605 NO. 16401-87402 - 16401-87404</p> <p>TAMPÃO DO RADIADOR</p> <p>DAIHATSU TERIOS (J1_) 1.3 4WD (J102) (De 10.2000 Até 10.2005) 63kW 86cv 1298cm3 Veículo todo-terreno fechado -</p> <p>d64/45x24mm d28x21mm</p>		<p>UTR0957 NO. 16401-87402-000 - 16471-87402-000</p> <p>TAMPÃO DO RADIADOR</p> <p>DAIHATSU TERIOS (J1_) 1.3 (De 07.2000 Até 10.2006) 63kW 86cv 1298cm3 Veículo todo-terreno fechado - DAIHATSU TERIOS (J1_) 1.3 4WD (J102) (De 10.2000 Até 10.2005) 63kW 86cv 1298cm3 Veículo todo-terreno fechado -</p> <p>d45x25mm d28x22mm</p>
	<p>UTR0958 NO. 1640187402000</p> <p>TAMPÃO RADIADOR</p> <p>DAIHATSU TERIOS (J1_) 1.3 (De 07.2000 Até 10.2006) 63kW 86cv 1298cm3 Veículo todo-terreno fechado - DAIHATSU TERIOS (J1_) 1.3 4WD (J102) (De 10.2000 Até 10.2005) 63kW 86cv 1298cm3 Veículo todo-terreno fechado -</p> <p>d45x29mm d28x21mm</p>		<p>Z9011 NO. 1715287201 - 1715287201000 - 1715287702 - 1715287702000 - 1715297201000</p> <p>MOLA DE ESCAPE</p> <p>DAIHATSU TERIOS</p> <p>d23x42mm</p>

DAIHATSU GRAN MOVE

	<p>F0512-I NO. 0K203-22-530 - 0K254-22-530</p> <p>FOLE DE TRANSMISSÃO</p> <p>DAIHATSU GRAN MOVE (G3) 1.5 16V (G303) 10.1996/07.1998 66KW 90CV 1499CC HEEG 7111354 - DAIHATSU GRAN MOVE (G3) 1.5 GLX 10.1996/08.1998 71KW 97CV 1499CC HEEG - DAIHATSU GRAN MOVE (G3) 1.5 GX 10.1996/08.1998 55KW 75CV 1499CC HEEG HEE - DAIHATSU GRAN MOVE (G3) 1.6 16V (G301) desde 05.1998 67KW 91CV 1589CC HD-EP 7111364</p> <p>d83x85mm 1f-d72mm 1f-d22mm</p>		<p>KF1259-I NO. 04438-87110 - 04438-87F10</p> <p>KIT DE FOLE DA TRANSMISSÃO LADO DA CAIXA</p> <p>DAIHATSU GRAN MOVE (G3) 1.5 16V (G303) (De 10.1996 Até 07.1998) 66kW 90cv 1499cm3 Veículo multiuso - DAIHATSU GRAN MOVE (G3) 1.6 16V (G301) (De 05.1998 -) 67kW 91cv 1589cm3 Veículo multiuso -</p> <p>d86x80mm 1f-d19mm 1f-d69mm</p>
	<p>M6005 NO. 90048-17006 - 90048-17007 - 90048-17019 - 90048-18015</p> <p>JUNTA DE ESCAPE</p> <p>DAIHATSU GRAN MOVE (G3): 1.5 GX 10.1996/08.1998 55KW 75CV 1499CC - DAIHATSU GRAN MOVE (G3): 1.5 16V (G303) 10.1996/07.1998 66KW 90CV 1499CC - DAIHATSU GRAN MOVE (G3): 1.5 GLX 10.1996/08.1998 71KW 97CV 1499CC - DAIHATSU GRAN MOVE (G3): 1.6 16V (G301) 05.1998/»» 67KW 91CV 1589CC</p> <p>d57x5mm 1f-d45mm</p>		<p>M6023 NO. 17451-B2020 - 17451-B2020-000 - 9091706026 - 9091706060</p> <p>JUNTA DE ESCAPE</p> <p>DAIHATSU GRAN MOVE</p> <p>d55x5mm 1f-d39mm</p>
	<p>UTR0817 NO. 21430-AX300 - 21430-AX600 - 21430AX30A - 4408066 - 7700805131 - 8200048024 - 91166192</p> <p>TAMPÃO RESERVATÓRIO LÍQUIDO REFRIGERAÇÃO</p> <p>DAIHATSU GRAN MOVE (G3) 1.5 GLX (10.96 A 08.98) 97cv 1499cc Veículo multiuso</p> <p>53x36mm 1f-d46x18mm</p>		

	P0093	NO.
	CAPA DE PEDAL TRAVÃO E EMBRAIAGEM	
	DAIHATSU JEEP	
	73x52x13mm	