

	<p><b>A0705</b> NO.</p> <p>SUPOORTE DO FILTRO DE AR</p> <p>BMW</p> <p>d21x18mm 1p-d6-15mm 1p-d6-15mm</p>		<p><b>A0934</b> NO. 13728042132 - A13728042132</p> <p>APOIO SUPORTE DO FILTRO DE AR</p> <p>BMW 1500-2000 (115, 116, 118, 121): 1500 10.1962/07.1966 59KW 80CV 1499CC - BMW 1500-2000 (115, 116, 118, 121): 1600 04.1964/04.1968 61KW 83CV 1573CC - BMW 1500-2000 (115, 116, 118, 121): 1800 07.1969/09.1971 66KW 90CV 1766CC - BMW 1500-2000 (115, 116, 118, 121): 1800 08.1963/09.1969 66KW 90CV 1773CC - BMW 1500-2000 (115, 116, 118, 121): 2000 09.1968/07.1972 74KW 100CV 1990CC</p> <p>d21x15mm 1p-d6-14mm 1p-d6-14mm</p>
	<p><b>E0643-M</b> NO. 22116885788 - 6885788</p> <p>ESTICADOR SUPORTE APOIO MOTOR TRAS</p> <p>BMW 1 (F40) 118 d desde 07.2019 100KW 136CV 1995CC B47 C20 B 0005CXP - BMW 1 (F40) 118 d desde 07.2019 110KW 150CV 1995CC B47 C20 B 0005CWP - BMW 1 (F40) 120 d desde 03.2020 140KW 190CV 1995CC B47 C20 B 0005CQW - BMW 1 (F40) 120 i desde 11.2020 131KW 17CV8 1998CC B48 A20 A B48 A20 F 0005DCT - BMW 1 (F40) 128 ti desde 11.2020 180KW 245CV 1998CC B48 A20 B - BMW 1 (F40) 128 ti desde 11.2020 195KW 265...</p> <p>253x62x75mm 1f-d13mm 1f-d12mm</p>		<p><b>F0147</b> NO.</p> <p>FOLE DO FILTRO DE AR</p> <p>BMW</p> <p>d72x228mm 2f-d55mm</p>
	<p><b>L1000</b> NO.</p> <p>CASQUILHO DO BRAÇO DA SUSPENSÃO</p> <p>BMW</p> <p>d35x40mm d28mm 1f-d13mm</p>		<p><b>P1042</b> NO. 35211160422</p> <p>CAPA DE PEDAL</p> <p>BMW X3 (F25) sDrive 18 d 10.2012/03.2014 100KW 136CV 1995CC N47 D20 C 0005BNW 0005BGV - BMW X3 (F25) sDrive 18 d 10.2012/03.2014 105KW 143CV 1995CC N47 D20 C 0005BNX 0005BGU - BMW X3 (F25) xDrive 20 d 09.2010/08.2017 120KW 163CV 1995CC B47 D20 A N47 D20 C 0005AZV - BMW X3 (F25) xDrive 20 d 09.2010/03.2014 135KW 184CV 1995CC N47 D20 C 0005AZU 0005BHE 0005BHN</p> <p>75x65x40mm</p>
	<p><b>R021925</b> NO. 13311288284</p> <p>TUBO DE LIGAÇÃO DO CARBURADOR AO COLECTOR</p> <p>BMW 5 (E28): 518 i 05.1981/12.1987 77KW 105CV 1766CC - BMW 5 (E28): 518 i 05.1981/12.1987 75KW 102CV 1766CC - BMW 5 (E28): 520 i 06.1981/12.1987 92KW 125CV 1990CC - BMW 5 (E28): 520 i 08.1985/12.1987 95KW 129CV 1990CC - BMW 5 (E28): 520 i 12.1986/12.1987 110KW 150CV 1990CC - BMW 5 (E28): 525 e 09.1981/12.1987 90KW 122CV 2693CC - BMW 5 (E28): 525 e 03.1983/12.1987 92KW 125CV 2693CC - BMW 5 (E28): 5...</p> <p>B230-7/7mm 205x55mm</p>		<p><b>U0020</b> NO. 18214490157 - A18214490157</p> <p>TACO DE NYLON PARA ANEIS DE ESCAPE N0500</p> <p>BMW 1502-2002 (E10) 1502 01.1975/07.1977 55KW 75CV 1573CC M10 B16 (16A) 0005381 - BMW 1502-2002 (E10) 1600/2 12.1967/12.1971 63KW 85CV 1573CC M10 B16 AM10 B16 (16A) 0005324 - BMW 1502-2002 (E10) 1602 04.1971/07.1975 63KW 85CV 1573CC M10 B16 (16A)M10 B16 A 0005324, 0005372 - BMW 1502-2002 (E10) 1802 05.1971/07.1975 66KW 90CV 1766CC M10 B18 0005365 - BMW 1502-2002 (E10) 2002 02.1968/07.1975 74KW 100...</p> <p>34x25x18mm</p>
	<p><b>U7033K</b> NO. 61671378609 - 64500149356 - 64500301636 - 64501363572 - 64501466019 - 64501468463 - 64508390601</p> <p>ORINGS BOMBA DIREÇÃO ASSITIDA</p> <p>BMW 6 Cabriolet (F12) M6 (03.2012 - 06.2018) 412kw 560cv 4395cm3 Cabriolet BMW 6 Cabriolet (F12) M6 Competition (07.2013 - 02.2015) 423kw 575cv 4395cm3 Cabriolet BMW 6 Cabriolet (F12) M6 Competition (03.2015 - 06.2018) 441kw 600cv 4395cm3 Cabriolet</p> <p>d11x2mm d10x2mm 1f-d7mm 1f-d6mm</p>		<p><b>U7033K</b> NO. 61671378609 - 64500149356 - 64500301636 - 64501363572 - 64501466019 - 64501468463 - 64508390601</p> <p>ORINGS BOMBA DIREÇÃO ASSITIDA</p> <p>BMW 6 Coupé (F13) M6 (07.2012 - 10.2017) 412kw 560cv 4395cm3 Coupé BMW 6 Coupé (F13) M6 Competition (07.2013 - 02.2015) 423kw 575cv 4395cm3 Coupé BMW 6 Coupé (F13) M6 Competition (03.2015 - 10.2017) 441kw 600cv 4395cm3 Coupé</p> <p>d11x2mm d10x2mm 1f-d7mm 1f-d6mm</p>
	<p><b>UAP81292</b> NO. 13532247156 - 2247156</p> <p>ANILHA PROTEÇÃO TÉRMICA INJECTORES</p> <p>BMW 6 Cabriolet (F12) 640 d (De 09-2011 Até .1-20 -) 230kW 313CV 2993cc Cabriolet BMW 6 Cabriolet (F12) 640 d xDrive (De 09-2011 Até .1-20 -) 230kW 313CV 2993cc Cabriolet</p> <p>d16x1mm 1f-d7mm</p>		<p><b>UAP81292</b> NO. 13532247156 - 2247156</p> <p>ANILHA PROTEÇÃO TÉRMICA INJECTORES</p> <p>BMW 6 Coupé (F13) 640 d (De 11-2010 Até .1-20 -) 230kW 313CV 2993cc Coupé BMW 6 Coupé (F13) 640 d xDrive (De 09-2011 Até .1-20 -) 230kW 313CV 2993cc Coupé</p> <p>d16x1mm 1f-d7mm</p>
	<p><b>UAP81292</b> NO. 13532247156 - 2247156</p> <p>ANILHA PROTEÇÃO TÉRMICA INJECTORES</p> <p>BMW 6 Gran Coupe (F06) 640 d (De 09-2011 Até .1-20 -) 230kW 313CV 2993cc Coupé BMW 6 Gran Coupe (F06) 640 d xDrive (De 01-2013 Até .1-20 -) 230kW 313CV 2993cc Coupé</p> <p>d16x1mm 1f-d7mm</p>		<p><b>UAP81292</b> NO. 13532247156 - 2247156</p> <p>ANILHA PROTEÇÃO TÉRMICA INJECTORES</p> <p>BMW X3 (F25) sDrive 18 d (De 08-2011 Até .1-20 -) 100kW 136CV 1995cc Veiculo todo-terreno fechado BMW X3 (F25) sDrive 18 d (De 08-2011 Até .1-20 -) 105kW 143CV 1995cc Veiculo todo-terreno fechado BMW X3 (F25) sDrive 18 d (De 02-2014 Até .1-20 -) 110kW 150CV 1995cc Veiculo todo-terreno fechado BMW X3 (F25) xDrive 20 d (De 09-2010 Até .1-20 -) 120kW 163CV 1995cc Veiculo todo-terreno fechado ...</p> <p>d16x1mm 1f-d7mm</p>
	<p><b>UAP81292</b> NO. 13532247156 - 2247156</p> <p>ANILHA PROTEÇÃO TÉRMICA INJECTORES</p> <p>BMW X4 (F26) xDrive 30 d (De 04-2014 Até 03-2018) 190kW 258CV 2993cc Veiculo todo-terreno fechado BMW X4 (F26) xDrive 35 d (De 04-2014 Até 03-2018) 230kW 313CV 2993cc Veiculo todo-terreno fechado</p> <p>d16x1mm 1f-d7mm</p>		<p><b>UAP81292</b> NO. 13532247156 - 2247156</p> <p>ANILHA PROTEÇÃO TÉRMICA INJECTORES</p> <p>BMW X6 (F16 - F86) xDrive 40 d (De 12-2014 Até .1-20 -) 230kW 313CV 2993cc Veiculo todo-terreno fechado BMW X6 (F16 - F86) M 50 d (De 08-2014 Até .1-20 -) 280kW 381CV 2993cc Veiculo todo-terreno fechado</p> <p>d16x1mm 1f-d7mm</p>

	<p><b>UAP81905</b> NO. 13532247156 - 2247156</p> <p>ANILHA PROTEÇÃO TÉRMICA INJECTORES</p> <p>BMW X4 (F26) xDrive 30 d (De 04-2014 Até 03-2018) 190kW 258CV 2993cc Veículo todo-terreno fechado BMW X4 (F26) xDrive 35 d (De 04-2014 Até 03-2018) 230kW 313CV 2993cc Veículo todo-terreno fechado</p> <p>d14x1mm 1f-d7mm</p>		<p><b>UMB84029</b> NO. 07119937320 - 11111276472 - 11111717939 - 1717939 - 9937321</p> <p>TAMPÃO BLOCO MOTOR</p> <p>BMW 2500-3.3 (E3) 2500 (De 10-1968 Até 04-1977) 110kW 150CV 2494cc três volumes BMW 2500-3.3 (E3) 2800 (De 10-1968 Até 07-1975) 125kW 170CV 2788cc três volumes BMW 2500-3.3 (E3) 2.8 L (De 02-1975 Até 04-1977) 125kW 170CV 2788cc três volumes BMW 2500-3.3 (E3) 3.0 S (De 05-1971 Até 04-1977) 132kW 180CV 2985cc três volumes BMW 2500-3.3 (E3) 3.0 L (De 02-1975 Até 04-1977) 132kW 180CV 2985cc três v...</p> <p>d36x10mm di-32mm</p>
	<p><b>W5140</b> NO. 11237797996 - 11237800026 - 11238578993 - 11238585220 - 11238651643</p> <p>POLIE DA CAMBOTA 7 PISTAS</p> <p>BMW X6 (E71 - E72) xDrive 30 d (04.09 A 06.14) 245cv 2993cc Veículo todo-terreno fechado - BMW X6 (E71 - E72) xDrive 40 d (07.09 A 06.14) 306cv 2993cc Veículo todo-terreno fechado</p> <p>d190mm d10mm</p>		<p><b>Z00538</b> NO. 07129925720 - 7129925720</p> <p>Mola porca rápida</p> <p>BMW</p> <p>21x13x4mm 1f-d5.5mm</p>
	<p><b>Z55237</b> NO. 1916670</p> <p>MOLA DE FIXAÇÃO CAVA DE RODA</p> <p>BMW (VÁRIOS MODELOS)</p> <p>F8mm T16mm S1-2mm H11mm L8mm S1mm Z23mm</p>		<p><b>Z55266</b> NO. 07149136882</p> <p>MOLA DO PAINEL DAS PORTAS</p> <p>BMW SERIE 2 (A partir de 2013)</p> <p>F9mm T18mm L14mm H21mm S1-7mm</p>
	<p><b>Z55266</b> NO. 07149136882</p> <p>MOLA DO PAINEL DAS PORTAS</p> <p>BMW SERIE 4 (A partir de 2015)</p> <p>F9mm T18mm L14mm H21mm S1-7mm</p>		<p><b>Z80459</b> NO. 823867299</p> <p>Mola de painel</p> <p>BMW (TODOS)</p> <p>d18x21.2mm 1p-d7.6-14.2mm</p>
	<p><b>Z80470</b> NO. 164361 - 7703072177</p> <p>Mola de fixação</p> <p>BMW (TODOS)</p> <p>d5x45mm</p>		<p><b>Z80684</b> NO. 16131176747 - 1800940 - 90127883</p> <p>Mola de retenção</p> <p>BMW (TODOS)</p> <p>d16x10mm 1f-d6mm</p>
	<p><b>Z80739</b> NO. 1400806 - 51111964186</p> <p>Mola de fixação</p> <p>BMW (TODOS)</p> <p>d20x41mm 1p-d6.5-20.5mm</p>		<p><b>Z80750</b> NO. 51461805542 - 51471904317</p> <p>Mola de painel</p> <p>BMW (TODOS)</p> <p>d20x23mm 1p-d9-20mm</p>

## BMW 1500-1600-1800-2000

	<p><b>A0608</b> NO. 23711690110 - A23711690110</p> <p>APOIO SUPORTE DE CAIXA DE VELOCIDADES</p> <p>BMW 1500-2000 (115, 116, 118, 121): 1500 10.1962/07.1966 59KW 80CV 1499CC - BMW 1500-2000 (115, 116, 118, 121): 1600 04.1964/04.1968 61KW 83CV 1573CC - BMW 1500-2000 (115, 116, 118, 121): 1800 07.1969/09.1971 66KW 90CV 1766CC - BMW 1500-2000 (115, 116, 118, 121): 1800 08.1963/09.1969 66KW 90CV 1773CC - BMW 1500-2000 (115, 116, 118, 121): 2000 09.1968/07.1972 74KW 100CV 1990CC</p> <p>d30x32mm 1p-d10-27mm 1r-d8mm</p>		<p><b>A0803</b> NO. 31131108371 - 31131108373 - A31131108373</p> <p>APOIO SILENT-BLOC DO BRAÇO SUSPENSÃO DA FRENTE</p> <p>BMW 1600 - 1602</p> <p>d50x47mm d47x16mm 1f-d14mm</p>
---	---	---	---



	<p><b>A0948</b> NO. 26111206502 - 26121104355 - A26111206502</p> <p><b>APOIO SUPORTE CENTRAL DA TRANSMISSÃO COM ROLAMENTO</b></p> <p>BMW 2.5-3.2 Coupé (E9) 3.0 CS 05.1971/03.1976 132KW 180CV 2985CC M30 B30 0005363 - BMW 2.5-3.2 Coupé (E9) 3.0 CSL 01.1974/11.1975 152KW 206CV 3153CC M30 B32 (315/1A) - BMW 2500-3.3 (E3) 2.8 L 02.1975/04.1977 125KW 170CV 2788CC M30 B28 0005383 - BMW 2500-3.3 (E3) 2500 10.1968/04.1977 110KW 150CV 2494CC M30 B25 0005357 - BMW 2500-3.3 (E3) 2800 10.1968/07.1975 125KW 170CV 2788CC M30 B28 0005358 - BM...</p> <p>155x101x42mm d30mm</p>		<p><b>A1949</b> NO. 0019811225 - 0029812925 - 0039812325 - 0089814325 - 26121103728 - 26121209590 - 26121225071 - 261212...</p> <p><b>APOIO DA TRANSMISSÃO</b></p> <p>BMW 2000-3.2 Coupé (E9) 3.0 CS (05.71 A 03.76) 180cv 2985cc Coupé - BMW 2000-3.2 Coupé (E9) 3.0 CSL (01.74 A 11.75) 206cv 3153cc Coupé</p> <p>170x110x56mm 1f-d30mm</p>
	<p><b>A1949</b> NO. 0019811225 - 0029812925 - 0039812325 - 0089814325 - 26121103728 - 26121209590 - 26121225071 - 261212...</p> <p><b>APOIO DA TRANSMISSÃO</b></p> <p>BMW 2500-3.3 (E3) 2500 (10.68 A 04.77) 150cv 2494cc três volumes - BMW 2500-3.3 (E3) 2800 (10.68 A 07.75) 170cv 2788cc três volumes - BMW 2500-3.3 (E3) 2.8 L8 (02.75 A 04.77) 170cv 2788cc três volumes - BMW 2500-3.3 (E3) 3.0 S (05.71 A 04.77) 180cv 2985cc três volumes - BMW 2500-3.3 (E3) 3.0 L (02.75 A 04.77) 180cv 2985cc três volumes - BMW 2500-3.3 (E3) 3.2 Li (10.75 A 04.77) 200cv 321...</p> <p>170x110x56mm 1f-d30mm</p>		<p><b>F0469-I</b> NO. 33211104159 - 33211195463 - 33211208443 - 33219067909 - 33219067912</p> <p><b>FOLE DA TRANSMISSÃO LADO DA CAIXA E RODA</b></p> <p>BMW 1500-2000 (115, 116, 118, 121): 1800 07.1969/09.1971 66KW 90CV 1766CC - BMW 1500-2000 (115, 116, 118, 121): 2000 01.1970/11.1972 66KW 90CV 1766CC - BMW 1500-2000 (115, 116, 118, 121): 2000 09.1968/07.1972 74KW 100CV 1990CC - BMW 1500-2000 (115, 116, 118, 121): 2000 Ti / Tilux 01.1966/07.1972 88KW 120CV 1990CC - BMW 1500-2000 (115, 116, 118, 121): 2000 Tii 12.1969/07.1972 96KW 131CV 1990CC - BM...</p> <p>d85x80mm 1f-d61mm 1f-d23mm</p>
	<p><b>F0548-I</b> NO. 33211105446 - 3321110544603 - 33211205816</p> <p><b>FOLE DO SEMI-EIXO LADO CAIXA</b></p> <p>BMW 1500 - 1600 - 1800 - 2000 - (1962 A 1977)</p> <p>d85x80mm 1f-d51mm 1f-d23mm</p>		<p><b>R220032</b> NO. 17120788161</p> <p><b>TUBO INFERIOR DE SAÍDA DE ÁGUA DO RADIADOR</b></p> <p>BMW 1500-2000 (115, 116, 118, 121): 1500 10.1962/07.1966 59KW 80CV 1499CC - BMW 1500-2000 (115, 116, 118, 121): 1600 04.1964/04.1968 61KW 83CV 1573CC - BMW 1500-2000 (115, 116, 118, 121): 1800 07.1969/09.1971 66KW 90CV 1766CC - BMW 1500-2000 (115, 116, 118, 121): 1800 08.1963/09.1969 66KW 90CV 1773CC - BMW 1500-2000 (115, 116, 118, 121): 2000 09.1968/07.1972 74KW 100CV 1990CC</p> <p>B210-d31/31mm 85-165mm</p>
	<p><b>R220035</b> NO. 17120788162</p> <p><b>TUBO DE RADIADOR SUPERIOR</b></p> <p>BMW 1500-2000 (115, 116, 118, 121) 1500 10.1962/07.1966 59KW 80CV 1499CC M10 B15 0005317 - BMW 1500-2000 (115, 116, 118, 121) 1600 04.1964/04.1968 61KW 83CV 1573CC M10 B16 (16A) 0005322 - BMW 1500-2000 (115, 116, 118, 121) 1800 08.1963/09.1969 66KW 90CV 1773CC M118 0005318 - BMW 1500-2000 (115, 116, 118, 121) 1800 07.1969/09.1971 66KW 90CV 1766CC M10 B18 0005356 - BMW 1500-2000 (115, 116, 118, 121)...</p> <p>B200-d30/30mm 60-60-50-50mm</p>		<p><b>R220045</b> NO. 11530788175 - 11531266469</p> <p><b>TUBO DO TERMOSTASTO</b></p> <p>BMW 1500-2000 (115, 116, 118, 121) 1500 10.1962/07.1966 59KW 80CV 1499CC M10 B15 0005317 - BMW 1500-2000 (115, 116, 118, 121) 1500 09.1963/07.1966 59KW 80CV 1573CC M10 B16 (16A) 0005319 - BMW 1500-2000 (115, 116, 118, 121) 1600 04.1964/04.1968 61KW 83CV 1573CC M10 B16 (16A) 0005322 - BMW 1500-2000 (115, 116, 118, 121) 1800 08.1963/09.1969 66KW 90CV 1773CC M118 0005318 - BMW 1500-2000 (115, 116, 118, 121) 1800 07.1969/09.1971 66KW 90CV 1766CC M10 B18 0005356 - BMW 1500-2000 (115, 116, 118, 121)...</p> <p>B245-d30/30mm 85-190mm</p>
	<p><b>R220045</b> NO. 11530788175 - 11531266469</p> <p><b>TUBO DO TERMOSTASTO</b></p> <p>BMW 1600 GT Coupé 1.6 10.1967/05.1969 77KW 105CV 1573CC M10 B16 (16A) 0005326</p> <p>B245-d30/30mm 85-190mm</p>		<p><b>R220045</b> NO. 11530788175 - 11531266469</p> <p><b>TUBO DO TERMOSTASTO</b></p> <p>BMW 2000 Coupé (120) CS 10.1965/06.1970 88KW 120CV 1990CC M10 B20 0005315</p> <p>B245-d30/30mm 85-190mm</p>
	<p><b>UMB84029</b> NO. 07119937320 - 11111276472 - 11111717939 - 1717939 - 9937321</p> <p><b>TAMPÃO BLOCO MOTOR</b></p> <p>BMW 1500-2000 (115 - 116 - 118 - 121) 1600 (De 04-1964 Até 04-1968) 61KW 83CV 1573cc três volumes BMW 1500-2000 (115 - 116 - 118 - 121) 1800 (De 07-1969 Até 09-1971) 66KW 90CV 1766cc três volumes BMW 1500-2000 (115 - 116 - 118 - 121) 2000 (De 01-1970 Até 11-1972) 66KW 90CV 1766cc três volumes BMW 1500-2000 (115 - 116 - 118 - 121) 2000 (De 09-1968 Até 07-1972) 74KW 100CV 1990cc três volumes BMW...</p> <p>d36x10mm di-32mm</p>		<p><b>UMB84029</b> NO. 07119937320 - 11111276472 - 11111717939 - 1717939 - 9937321</p> <p><b>TAMPÃO BLOCO MOTOR</b></p> <p>BMW 1600 GT Coupé 1.6 (De 10-1967 Até 05-1969) 77KW 105CV 1573cc Coupé</p> <p>d36x10mm di-32mm</p>
	<p><b>UMB84029</b> NO. 07119937320 - 11111276472 - 11111717939 - 1717939 - 9937321</p> <p><b>TAMPÃO BLOCO MOTOR</b></p> <p>BMW 2000-3.2 Coupé (E9) 2000 CS (De 10-1965 Até 06-1970) 88KW 120CV 1990cc Coupé BMW 2000-3.2 Coupé (E9) 2.5 CS (De 09-1974 Até 03-1976) 110kW 150CV 2494cc Coupé BMW 2000-3.2 Coupé (E9) 2800 CS (De 01-1969 Até 04-1971) 125KW 170CV 2788cc Coupé BMW 2000-3.2 Coupé (E9) 3.0 CS (De 05-1971 Até 03-1976) 132kW 180CV 2985cc Coupé BMW 2000-3.2 Coupé (E9) 3.0 CSi (De 07-1971 Até 03-1976) 147kW 200CV 2985cc...</p> <p>d36x10mm di-32mm</p>		<p><b>UMB84029</b> NO. 07119937320 - 11111276472 - 11111717939 - 1717939 - 9937321</p> <p><b>TAMPÃO BLOCO MOTOR</b></p> <p>BMW 02 Cabriolet (E10) 1600-2 (De 12-1967 Até 10-1971) 63kW 86CV 1573cc Cabriolet BMW 02 Cabriolet (E10) 2002 (De 05-1971 Até 07-1975) 74kW 100CV 1990cc Cabriolet</p> <p>d36x10mm di-32mm</p>
	<p><b>UTR0631</b> NO. 17111100848 - 17111102672 - 17111120062</p> <p><b>TAMPÃO RADIADOR</b></p> <p>BMW 1500-2000 (115, 116, 118, 121): 1500 10.1962/07.1966 59KW 80CV 1499CC - BMW 1500-2000 (115, 116, 118, 121): 1500 09.1963/07.1966 59KW 80CV 1573CC - BMW 1500-2000 (115, 116, 118, 121): 1600 04.1964/04.1968 61KW 83CV 1573CC - BMW 1500-2000 (115, 116, 118, 121): 1800 07.1969/09.1971 66KW 90CV 1766CC - BMW 1500-2000 (115, 116, 118, 121): 1800 08.1963/09.1969 66KW 90CV 1773CC - BMW 1500-2000 (115, ...</p> <p>d59/79x29mm d38x26mm</p>		<p><b>UTR0631</b> NO. 17111100848 - 17111102672 - 17111120062</p> <p><b>TAMPÃO RADIADOR</b></p> <p>BMW 1600 GT Coupé 1.6 (De 1967.10 Até 1969.05) 77kW 105cv 1573cm3 Coupé -</p> <p>d59/79x29mm d38x26mm</p>





	<b>UTR0631</b>	NO. 17111100848 - 17111102672 - 17111120062		
	TAMPÃO RADIADOR			
BMW 2000-3.2 Coupé (E9) 2000 C/CA (De 1965.10 Até 1970.06) 74kW 101cv 1990cm3 Coupé - BMW 2000-3.2 Coupé (E9) 2000 CS (De 1965.10 Até 1970.06) 88kW 120cv 1990cm3 Coupé - BMW 2000-3.2 Coupé (E9) 2.5 CS (De 1974.09 Até 1976.03) 110kW 150cv 2494cm3 Coupé - BMW 2000-3.2 Coupé (E9) 2800 CS (De 1969.01 Até 1971.04) 125kW 170cv 2788cm3 Coupé - BMW 2000-3.2 Coupé (E9) 2800 CS (De 1969.01 Até 1971.04) 125kW 170cv 2788cm3 Coupé -				
BMW 2000-3.2 Coupé (E9) 2800 CS (De 1969.01 Até 1971.04) 125kW 170cv 2788cm3 Coupé -				

## BMW 1502-(E6)-(E10) 1602 1802 2002-(E6)-(E10)

	<b>A0803</b>	NO. 31131108371 - 31131108373 - A31131108373		<b>A0873</b>	NO. A11811109352	
	APOIO SILENT-BLOC DO BRAÇO SUSPENSÃO DA FRENTE			APOIO MOTOR LADO ESQUERDO		
BMW 1502 - 2002			BMW 1500-2000 (115, 116, 118, 121) 1500 10.1962/07.1966 59KW 80CV 1499CC M10 B15 0005317 - BMW 1500-2000 (115, 116, 118, 121) 1500 09.1963/07.1966 59KW 80CV 1573CC M10 B16 (16A) 0005319 - BMW 1500-2000 (115, 116, 118, 121) 1600 04.1964/04.1968 61KW 83CV 1573CC M10 B16 (16A) 0005322 - BMW 1500-2000 (115, 116, 118, 121) 1800 08.1963/09.1969 66KW 90CV 1773CC M18 0005318 - BMW 1500-2000 (115, 116, 11...)			
d50x47mm		d47x16mm 1f-d14mm	99x53x46mm		2p-d10-19mm	
	<b>A0873</b>	NO. A11811109352		<b>A0906</b>	NO. 11811104588 - 11819057213 - A11811104588	
	APOIO MOTOR LADO ESQUERDO			APOIO MOTOR LADO DIREITO		
BMW 2002			BMW 1500-2000 (115, 116, 118, 121) 2000 Tii 12.1969/07.1972 96KW 131CV 1990CC M10 B20 0005360			
99x53x46mm		2p-d10-19mm	122x52x47mm		1p-d8-17mm 2f-d9mm EF105mm	
	<b>A0906</b>	NO. 11811104588 - 11819057213 - A11811104588		<b>A0948</b>	NO. 26111206502 - 26121104355 - A26111206502	
	APOIO MOTOR LADO DIREITO			APOIO SUPORTE CENTRAL DA TRANSMISSÃO COM ROLAMENTO		
BMW 2002			BMW 1502-2002 (E10) 2002 02.1968/07.1975 74KW 100CV 1990CC M10 B20 A 0005354 - BMW 1502-2002 (E10) 2002 Ti 06.1968/04.1972 88KW 120CV 1990CC M10 B20 0005332 - BMW 1502-2002 (E10) 2002 Turbo 01.1974/07.1975 125KW 170CV 1990 M10 B20 (22T A) 0005377 - BMW 1502-2002 Cabriolet (E10) 2002 05.1971/07.1975 74KW 100CV 1990CC M10 B20 0005362 - BMW 1502-2002 Touring (E6) 2002 Tii 01.1971/07.1975 96KW 130CV 1...)			
122x52x47mm		1p-d8-17mm 2f-d9mm EF105mm	155x101x42mm		d30mm	
	<b>A1949</b>	NO. 0019811225 - 0029812925 - 0039812325 - 0069814325 - 26121103728 - 26121209590 - 26121225071 - 2612121...		<b>D0004</b>	NO. 1 106 113 - 26111106113	
	APOIO DA TRANSMISSÃO			CARDAN TRANSMISSÃO D107X38MM 8 FUIROS 10MM ENTRE FUIROS 76MM		
BMW 02 (E10) 2002 (02.68 A 07.75) 100cv 1990cc três volumes - BMW 02 (E10) 2002 Ti (06.68 A 04.72) 120cv 1990cc três volumes - BMW 02 (E10) 2002 Turbo (01.74 A 07.75) 170cv 1990cc três volumes - BMW 02 Touring (E6) 2002 Tii (01.71 A 07.75) 9 130cv 1990cc Combi - BMW 02 Cabriolet (E10) 2002 (05.71 A 07.75) 100cv 1990cc Cabriolet			BMW 1502 1969/»»» - BMW 1602 - BMW 1802 - BMW 2002 1969/»»»			
170x110x56mm		1f-d30mm	d110x39mm		8f-d9mm	
	<b>F0469-I</b>	NO. 3435052 - 414510		<b>F0469-I</b>	NO. 3435052 - 414510	
	FOLE DA TRANSMISSÃO LADO DA CAIXA			FOLE DA TRANSMISSÃO LADO DA CAIXA		
BMW 1502-2002 Touring (E6): 1600 05.1971/04.1973 63KW 85CV 1573CC - BMW 1502-2002 Touring (E6): 1802 05.1971/07.1975 66KW 90CV 1766CC - BMW 1502-2002 Touring (E6): 2002 05.1971/07.1975 74KW 100CV 1990CC - BMW 1502-2002 Touring (E6): 2002 Tii 01.1971/07.1975 96KW 130CV 1990CC			BMW 1502-2002 (E10): 1502 01.1975/07.1977 55KW 75CV 1573CC - BMW 1502-2002 (E10): 1602 04.1971/07.1975 63KW 85CV 1573CC - BMW 1502-2002 (E10): 1600/2 12.1967/12.1971 63KW 85CV 1573CC - BMW 1502-2002 (E10): 1600 Ti 09.1967/11.1969 77KW 105CV 1573CC - BMW 1502-2002 (E10): 2002 02.1968/07.1975 74KW 100CV 1990CC - BMW 1502-2002 (E10): 2002 02.1968/07.1975 74KW 100CV 1990CC - BMW 1502-2002 (E10): 2002 T...)			
d85x80mm		1f-d61mm 1f-d23mm	d85x80mm		1f-d61mm 1f-d23mm	
	<b>F1056</b>	NO. 25111200938 - 25111206289 - 25111206881 - A25111206881		<b>M6017</b>	NO. 18111175311 - 18111245489 - 18111245840 - 18111245960 - 18114690146	
	FOLE ALAVANCA VELOCIDADES			JUNTA DE ESCAPE		
BMW 1502/1602/1802/2002Ti/2002Tii 04.1967/07.1977 - BMW 02 1602 - BMW E10 2002 turbo 114 SEDAN 13.10.1976/»»» - BMW E10 2002 M05 2.0L - BMW E10 2002t M15 2.0L 114 SEDAN - BMW E21 318/320/323i - BMW E3 3.0S M30 3.0L SEDAN - BMW E3 3.0Si M30 3.0L SEDAN - BMW E3 Bavaria 3.0S SEDAN - BMW 1500/2002CS 09.1963/01.1972 - BMW 2500 3.3 LI 08.1968/02.1977 - BMW NK 2000 SEDAN - BMW 114 1502 Sedan, Europe - ...			BMW 1502-2002 (E10): 1502 01.1975/07.1977 55KW 75CV 1573CC - BMW 1502-2002 (E10): 1602 04.1971/07.1975 63KW 85CV 1573CC - BMW 1502-2002 (E10): 1600/2 12.1967/12.1971 63KW 85CV 1573CC - BMW 1502-2002 (E10): 1600 Ti 09.1967/11.1969 77KW 105CV 1573CC - BMW 1502-2002 (E10): 2002 02.1968/07.1975 74KW 100CV 1990CC - BMW 1502-2002 (E10): 2002 Tii 06.1968/04.1972 88KW 120CV 1990CC - BMW 1502-2002 (E10): 2002 T...			
119x104x72mm		1f-d14mm	d56.5x10mm		1f-d44mm	

	<p><b>N0500</b> NO. 18211105635 - 18211105638 - 18211105677 - 18211177708 - 18211728332 - 18214490159 - 1824490159</p> <p><b>ANEL DE SUPORTE DE ESCAPE</b></p> <p>BMW 1502-2002 (E10): 1502 01.1975/07.1977 55KW 75CV 1573CC - BMW 1502-2002 (E10): 1602 04.1971/07.1975 63KW 85CV 1573CC - BMW 1502-2002 (E10): 1600/2 12.1967/12.1971 63KW 85CV 1573CC - BMW 1502-2002 (E10): 1802 05.1971/07.1975 66KW 90CV 1766CC - BMW 1502-2002 (E10): 2002 02.1968/07.1975 74KW 100CV 1990CC - BMW 1502-2002 (E10): 2002 Ti 06.1968/04.1972 88KW 120CV 1990CC - BMW 1502-2002 (E10): 2002 T...</p> <p>65x18mm</p>		<p><b>R220032</b> NO. 17120788161</p> <p><b>TUBO INFERIOR DE SAÍDA DE ÁGUA DO RADIADOR</b></p> <p>BMW 1502-2002 (E10): 2002 02.1968/07.1975 74KW 100CV 1990CC - BMW 1502-2002 Touring (E6): 2002 05.1971/07.1975 74KW 100CV 1990CC - BMW 1502-2002 Cabriolet (E10): 2002 05.1971/07.1975 74KW 100CV 1990CC</p> <p>B210-d31/31mm 85-165mm</p>
	<p><b>R220035</b> NO. 17120788162</p> <p><b>TUBO DE RADIADOR SUPERIOR</b></p> <p>BMW 1502-2002 (E10) 1502 01.1975/07.1977 55KW 75CV 1573CC M10 B16 (16A) 0005381 - BMW 1502-2002 (E10) 1600 Ti 09.1967/11.1969 77KW 105CV 1573CC M10 B16 (16A) 0005338 - BMW 1502-2002 (E10) 1600/2 12.1967/12.1971 63KW 85CV 1573CC M10 B16 AM10 B16 (16A) 0005324 - BMW 1502-2002 (E10) 1602 04.1971/07.1975 63KW 85CV 1573CC - BMW 1502-2002 (E10) M10 B16 (16A)M10 B16 A 0005324 0005372 - BMW 1502-2002 (E10)...</p> <p>B200-d30/30mm 60-60-50-50mm</p>		<p><b>R220045</b> NO. 11530788175 - 11531266469</p> <p><b>TUBO DO TERMOSTASTO</b></p> <p>BMW 1502-2002 (E10) 1502 01.1975/07.1977 55KW 75CV 1573CC M10 B16 (16A) 0005381 - BMW 1502-2002 (E10) 1600 Ti 09.1967/11.1969 77KW 105CV 1573CC M10 B16 (16A) 0005338 - BMW 1502-2002 (E10) 1600/2 12.1967/12.1971 63KW 85CV 1573CC M10 B16 AM10 B16 (16A) 0005324 - BMW 1502-2002 (E10) 1602 04.1971/07.1975 63KW 85CV 1573CC M10 B16 (16A)M10 B16 A 0005324, 0005372 - BMW 1502-2002 (E10) 2002 02.1968/07...</p> <p>B245-d30/30mm 85-190mm</p>
	<p><b>UMB84029</b> NO. 07119937320 - 11111276472 - 11111717939 - 1717939 - 9937321</p> <p><b>TAMPÃO BLOCO MOTOR</b></p> <p>BMW 02 (E10) 1502 (De 01-1975 Até 07-1977) 55kW 75CV 1573cc três volumes BMW 02 (E10) 1602 (De 04-1971 Até 07-1975) 63kW 85CV 1573cc três volumes BMW 02 (E10) 1600/2 (De 12-1967 Até 12-1971) 63kW 85CV 1573cc três volumes BMW 02 (E10) 1600 Ti (De 09-1967 Até 11-1969) 77kW 105CV 1573cc três volumes BMW 02 (E10) 1802 (De 05-1971 Até 07-1975) 66kW 90CV 1766cc três volumes BMW 02 (E10) 2002 (De 02-1968...</p> <p>d36x10mm di-32mm</p>		<p><b>UMB84029</b> NO. 07119937320 - 11111276472 - 11111717939 - 1717939 - 9937321</p> <p><b>TAMPÃO BLOCO MOTOR</b></p> <p>BMW 02 Touring (E6) 1600 (De 05-1971 Até 04-1973) 63kW 85CV 1573cc Combi BMW 02 Touring (E6) 1802 (De 05-1971 Até 07-1975) 66kW 90CV 1766cc Combi BMW 02 Touring (E6) 2002 (De 05-1971 Até 07-1975) 74kW 100CV 1990cc Combi BMW 02 Touring (E6) 2002 Tii (De 01-1971 Até 07-1975) 96kW 130CV 1990cc Combi</p> <p>d36x10mm di-32mm</p>
	<p><b>Z80218</b> NO. 51131804205</p> <p><b>Mola de friso</b></p> <p>BMW 2002</p> <p>18x9x15.5mm 1p-d6.3-5.5mm</p>		<p><b>Z80218</b> NO. 51131804205</p> <p><b>Mola de friso</b></p> <p>BMW 1502</p> <p>18x9x15.5mm 1p-d6.3-5.5mm</p>

BMW SERIE 1(E81)

	<p><b>A1892</b> NO. 26127526632</p> <p><b>APOIO DA TRANSMISSÃO</b></p> <p>BMW 1 (E81) 123d Hatchback (03-2007 A 09-2012) 204CV 1995CC - BMW 1 Coupé (E82) 135i (10-2007 A 10-2013) 306CV 2979CC - BMW 1 Coupé (E82) 123d (10-2007 A 10-2013) 204CV 1995CC - BMW 1 Cabriolet (E88) 135i (03-2008 A 12-2013) 306CV 2979CC - BMW 1 Cabriolet</p> <p>182x105x35mm 1f-d35mm</p>		<p><b>A1893</b> NO. 26127526631 - 26128615621</p> <p><b>APOIO DA TRANSMISSÃO</b></p> <p>BMW 1 (E81) 116i Hatchback (03-2007 A 09-2012) 115CV 1596CC - BMW 1 (E81) 116i Hatchback (03.2007 A 09-2012) 122CV 1599CC - BMW1 (E81) 116i Hatchback (11-2008 A 09-2012) 122CV 1995CC - BMW1 (E81) 118i Hatchback (09-2006 A 09-2012) 143CV 1995CC - BMW 1 (E8</p> <p>182x105x30mm 1f-d30mm</p>
	<p><b>D0022</b> NO. 26111209168 - 26111227420 - 26111227717 - 26111229080 - 26111229360 - 26117511454</p> <p><b>CARDAN TRANSMISSÃO D135X30MM 6 FUROS 12MM ENTRE FUROS 96MM</b></p> <p>BMW 1 (E81) 116 d 11.2008/12.2011 85KW 116CV 1995CC N47 D20 C N47 D20 A 0005ARM 0005AOG - BMW 1 (E81) 116 i 03.2007/12.2011 90KW 122CV 1599CC N43 B16 AA 0005ARD 0005AJZ - BMW 1 (E81) 116 i 09.2007/12.2011 85KW 115CV 1596CC N45 B16 A 0005ARC 0005ACW - BMW 1 (E81) 116 i 11.2008/12.2011 90KW 122CV 1995CC N43 B20 A 0005ARE 0005ARF 0005AOH 0005AOR - BMW 1 (E81) 118 d 09.2006/12.2011 105KW 143CV 1995CC ...</p> <p>d132x123x30mm 6f-d12mm</p>		<p><b>D0026</b> NO. 26111204294 - 26111207785 - 26111225624</p> <p><b>CARDAN TRANSMISSÃO D110X28MM 6 FUROS 10MM ENTRE FUROS 78MM</b></p> <p>BMW 1 (E81) 116 i Tipo de caixa de velocidades: Caixa de velocidades manual (04.07 A 12.11) 115cv 1596cc Hatchback</p> <p>d110x28mm 1f-d40mm 6f-d10mm</p>
	<p><b>D0063</b> NO. 26117542238</p> <p><b>CARDAN DA TRANSMISSÃO</b></p> <p>BMW 1 (E81) 123 d (De 03-2007 Até 12-2011) 150kW 204CV 1995cc Hatchback BMW 1 Coupé (E82) 123 d (De 10-2007 Até 10-2013) 150kW 204CV 1995cc Coupé BMW 1 Cabriolet (E88) 123 d (De 09-2008 Até 12-2013) 150kW 204CV 1995cc Cabriolet</p> <p>163x155x42mm 6f-d12mm</p>		<p><b>E1111</b> NO. 18207534092 - 18207589931 - 18208511880</p> <p><b>ESTICADOR DO ESCAPE</b></p> <p>BMW 1 (E 81) 116 d N.º peças nec. : 3 (11.08 A 09.12) 116cv 1995cc Hatchback - BMW 1 (E 81) 118 d N.º peças nec. : 3 (09.06 A 09.12) 143cv 1995cc Hatchback - BMW 1 (E 81) 120 d (03.07 A 09.12) 163cv 1995cc Hatchback - BMW 1 (E 81) 120 d (09.06 A 09.12) 177cv 1995cc Hatchback - BMW 1 Coupé (E 82) 118 d N.º peças nec. : 3 (09.09 A 10.13) 136cv 1995cc Coupé - BMW 1 Coupé (E 82) 118 d N.º</p> <p>71x54x32mm 2f-d10mm</p>



	<b>F4206</b> NO. 2511795326 - 25118036624 - 25118037304 <b>FOLE ALAVANCA VELOCIDADES C/ MANETE PUNHO TOPO COMPLETO 5 VELOCIDADES</b> BMW 1 Series E81 3 portas 116i 118i 120i 125i 130i 116d 118d 120d 123d com transmissão manual e LHD ano de fabricação. 2007/2012		<b>F4207</b> NO. 25118036629 - 25118037309 <b>FOLE ALAVANCA VELOCIDADES C/ MANETE PUNHO TOPO COMPLETO 6 VELOCIDADES</b> BMW 1 2011/01-2011/12 E81 116d 1995CC 66KW 90CV - BMW 1 2008/11-2011/12 E81 116d 1995CC 85KW 116CV - BMW 1 2008/11-2011/12 E81 116i 1995CC 90KW 122CV - BMW 1 2007/09-2011/12 E81 116i 1596CC 85KW 115CV - BMW 1 2007/08-2011/11 E81 116i 1599CC 89KW 121CV - BMW 1 2007/03-2011/12 E81 116i 1599CC 90KW 122CV - BMW 1 2006/09-2011/12 E81 118d 1995CC 100KW 136CV - BMW 1 2006/09-2011/12 E81 118d 1995CC 105KW... 172x155x234mm      1f-135x146mm
	<b>KT0624-I</b> NO. 31330146239 - 31331094749 - 31336764085 <b>KIT BATENTE SUSPENSÃO DA FRENTE</b> BMW 1 (E81) 116 i (De 04-2007 Até 12-2011) 85kW 115CV 1596cc Hatchback BMW 1 (E81) 116 i (De 03-2007 Até 11-2011) 90kW 122CV 1599cc Hatchback BMW 1 (E81) 116 i (De 11-2008 Até 12-2011) 90kW 122CV 1995cc Hatchback BMW 1 (E81) 118 i (De 09-2006 Até 12-2011) 105kW 143CV 1995cc Hatchback BMW 1 (E81) 120 i (De 09-2006 Até 10-2011) 115kW 156CV 1995cc Hatchback BMW 1 (E81) 120 i (De 09-2006 Até 12-2011) ... d90x190mm      1f-d23mm 1f-d70mm		<b>KUR21999</b> NO. 1f-d24mm 1f-d10mm 1f-d10mm 1f-d19m <b>KIT DE REPARAÇÃO ALAVANCA DE VELOCIDADES</b> BMW 1 (E81) 116 d (De 11.2008 Até 12.2011) 85kW 116cv 1995cm3 Hatchback - BMW 1 (E81) 116 i (De 09.2007 Até 12.2011) 85kW 115cv 1596cm3 Hatchback - BMW 1 (E81) 116 i (De 03.2007 Até 12.2011) 90kW 122cv 1599cm3 Hatchback - BMW 1 (E81) 116 i (De 11.2008 Até 12.2011) 90kW 122cv 1995cm3 Hatchback - BMW 1 (E81) 118 d (De 09.2006 Até 12.2011) 100kW 136cv 1995cm3 Hatchback - BMW 1 (E81) 118 d (De 09.2006... d37x18mm d19x25mm d7x27mm d31x21mm d32x21mm d41x21mm d44x15mm
	<b>P1042</b> NO. 35211160422 <b>CAPA DE PEDAL</b> BMW 1 (E81): 116 i 09.2007/12.2011 85KW 115CV 1596CC - BMW 1 (E81): 130 i 09.2006/12.2011 195KW 265CV 2996CC - BMW 1 (E81): 120 d 03.2007/12.2011 120KW 163CV 1995CC		<b>P1055</b> NO. 35211160421 <b>CAPA DE PEDAL DO TRAVÃO (VEÍCULOS COM CAIXA AUTOMÁTICA)</b> BMW SERIE 1 (E81) 116 i Gasolina 85kW 115hp N45 B16 A 03.2007/09.2012 Hatchback - BMW SERIE 1 (E81) 120 d Diesel 120kW 163hp N47 D20 A 03.2007/09.2012 Hatchback - BMW SERIE 1 (E81) 120 d Diesel 120kW 163hp N47 D20 C 03.2007/09.2012 Hatchback - BMW SERIE 1 (E81) 130 i Gasolina 195kW 265hp N52 B30 A 09.2006/09.2012 Hatchback - BMW SERIE 1 (E81) 130 i Gasolina 195kW 265hp N52 B30 B 09.2006/09.2012 Ha... 75x65x40mm
	<b>P1059</b> NO. 1 108 634 - 35211108634 <b>CAPA DE PEDAL DO TRAVÃO</b> BMW SERIE 1 (E81): 116 i 09.2007/12.2011 85KW 115CV 1596CC - BMW SERIE 1 (E81): 130 i 09.2006/12.2011 195KW 265CV 2996CC - BMW SERIE 1 (E81): 120 d 03.2007/12.2011 120KW 163CV 1995CC		<b>R225915</b> NO. 11617797480 - 7797480 <b>TUBO DO AR SOBREALIMENTAÇÃO</b> BMW 1 (E81) 116 d 11.2008/12.2011 85KW 116CV 1995CC N47 D20 C N47 D20 A 0005ARM 0005AOG - BMW 1 (E81) 118 d 09.2006/12.2011 100KW 136CV 1995CC N47 D20 C N47 D20 A 0005ARP 0005AHX - BMW 1 (E81) 118 d 09.2006/12.2011 105KW 143CV 1995CC N47 D20 C N47 D20 A 0005ARO 0005AHW B210-45/46mm      72-141mm
	<b>R226122</b> NO. 17127521361 - 7521361 <b>TUBO SUPERIOR DO RADIADOR LADO ESQUERDO</b> BMW 1 (E81) 116 i (09.2007 - 12.2011) 85kW 115cv 1596cm3 Hatchback BMW 1 (E81) 116 i (06.2004 - 06.2011) 85kW 115cv 1596cm3 Hatchback		<b>RT80266</b> NO. 34306771720 <b>TUBO DE TRAVÃO FRENTE LH-RH</b> BMW SÉRIE 1 (E81) 116i (APÓS 09-2004) - SÉRIE 1 (E81) 118D (APÓS 09-2004) - SÉRIE 1 (E81) 118i (APÓS 09-2004) - SÉRIE 1 (E81) 120i (APÓS 09-2004) - SÉRIE 1 (E81) 130i (APÓS 09-2005) - SÉRIE 1 (E81) 120D (APÓS 09-2004) B350-38/39mm      108-143-59-61mm 553mm      F6 - MC11
	<b>RT80330</b> NO. 34306762837 - 34306768851 - 34306789431 - 34306792253 <b>TUBO DE TRAVÃO TRÁS EXTERNO</b> BMW SÉRIE 1 (E81) 116i (APÓS 09-2004) - SÉRIE 1 (E81) 118D (APÓS 09-2004) - SÉRIE 1 (E81) 118i (APÓS 09-2004) - SÉRIE 1 (E81) 120D (APÓS 09-2004) - SÉRIE 1 (E81) 120i (APÓS 09-2004) - SÉRIE 1 (E81) 130i (APÓS 09-2005)		<b>S1875</b> NO. 33176760288 - 33176770866 <b>SILENT-BLOC DA CAIXA VELOCIDADES AUTOMÁTICA</b> BMW 1 (E81) 116 i (De 09.2007 Até 12.2011) 85kW 115cv 1596cm3 Hatchback BMW 1 (E81) 116 i (De 03.2007 Até 12.2011) 90kW 122cv 1599cm3 Hatchback BMW 1 (E81) 118 i (De 09.2006 Até 12.2011) 105kW 143cv 1995cm3 Hatchback BMW 1 (E81) 120 d (De 03.2007 Até 12.2011) 120kW 163cv 1995cm3 Hatchback - BMW 1 (E81) 120 i (De 03.2007 Até 09.2012) 125kW 170cv 1995cm3 Hatchback - BMW 1 (E81) 123 d (De 03.2007 At... 265mm      F6 - MCL d69x57mm      1f-11x14mm
	<b>T0623-I</b> NO. 33504034410 - 33536767334 - 33536783482 <b>BATENTE SUSPENSÃO FRENTE</b> BMW 1 (E81) 116 d 11.2008/12.2011 85KW 116CV 1995CC N47 D20 C N47 D20 A 0005ARM 0005AOG - BMW 1 (E81) 116 i 03.2007/12.2011 90KW 122CV 1599CC N43 B16 AA 0005ARD 0005AJZ - BMW 1 (E81) 116 i 09.2007/12.2011 85KW 115CV 1596CC N45 B16 A 0005ARC 0005ACW - BMW 1 (E81) 116 i 11.2008/12.2011 90KW 122CV 1995CC N43 B20 A 0005ARE 0005ARF 0005AOH 0005AOR - BMW 1 (E81) 118 d 09.2006/12.2011 105KW 143CV 1995CC ... d57x89mm      1f-d20mm 1f-d16mm		<b>UAP81292</b> NO. 13532247156 - 2247156 <b>ANILHA PROTEÇÃO TÉRMICA INJECTORES</b> BMW 1 (E81) 116 d (De 11-2008 Até 12-2011) 85kW 116CV 1995cc Hatchback BMW 1 (E81) 118 d (De 09-2006 Até 12-2011) 105kW 143CV 1995cc Hatchback BMW 1 (E81) 120 d (De 03-2007 Até 12-2011) 130kW 177CV 1995cc Hatchback BMW 1 (E81) 123 d (De 03-2007 Até 12-2011) 150kW 204CV 1995cc Hatchback d16x1mm      4f-d7mm
	<b>UAP81905</b> NO. 13532247156 - 2247156 <b>ANILHA PROTEÇÃO TÉRMICA INJECTORES</b> BMW 1 (E81) 116 d (De 11-2008 Até 12-2011) 85kW 116CV 1995cc Hatchback BMW 1 (E81) 118 d (De 09-2006 Até 12-2011) 105kW 143CV 1995cc Hatchback BMW 1 (E81) 120 d (De 03-2007 Até 12-2011) 130kW 177CV 1995cc Hatchback BMW 1 (E81) 123 d (De 03-2007 Até 12-2011) 150kW 204CV 1995cc Hatchback d14x1mm      1f-d7mm		<b>UMV25112</b> NO. 25112229442 - 25117566267 - 25117833136 - 25118037305 <b>MANETE PUNHO TOPO ALAVANCA MUDANÇAS 5 VELOCIDADES F14MM</b> BMW 1 (E81) 116 d 11.2008/12.2011 85KW 116CV 1995CC N47 D20 C N47 D20 A 0005ARM 0005AOG - BMW 1 (E81) 116 i 03.2007/12.2011 90KW 122CV 1599CC N43 B16 AA 0005ARD 0005AJZ - BMW 1 (E81) 116 i 09.2007/12.2011 85KW 115CV 1596CC N45 B16 A 0005ARC 0005ACW - BMW 1 (E81) 116 i 11.2008/12.2011 90KW 122CV 1995CC N43 B20 A 0005ARE 0005ARF 0005AOH 0005AOR - BMW 1 (E81) 118 d 09.2006/12.2011 100KW 136CV 1995CC ... d46x96mm      1f-d14mm



	<p><b>UMV25113</b> NO. 25112229442 - 25117566267 - 25117833136 - 25118037305</p> <p><b>MANETE PUNHO TOPO ALAVANCA MUDANÇAS 6 VELOCIDADES F14MM</b></p> <p>BMW 1 (E81) 116 d 11.2008/12.2011 85KW 116CV 1995CC N47 D20 C N47 D20 A 0005ARM 0005AOG - BMW 1 (E81) 116 i 03.2007/12.2011 90KW 122CV 1599CC N43 B16 AA 0005ARD 0005AJZ - BMW 1 (E81) 116 i 09.2007/12.2011 85KW 115CV 1596CF N45 B16 A 0005ARC 0005ACW - BMW 1 (E81) 116 i 11.2008/12.2011 90KW 122CV 1995CC N43 B20 A 0005ARE 0005ARF 0005AOH 0005AOR - BMW 1 (E81) 118 d 09.2006/12.2011 100KW 136CV 1995CC ...</p> <p>95x54x45mm 1f-d14mm</p>		<p><b>UMV25129</b> NO. 25112229442 - 25117566267 - 25117833136 - 25118037305</p> <p><b>MANETE PUNHO TOPO ALAVANCA MUDANÇAS 5 VELOCIDADES F14MM</b></p> <p>BMW 1 (E81) 116 d 11.2008/12.2011 85KW 116CV 1995CC N47 D20 C N47 D20 A 0005ARM 0005AOG - BMW 1 (E81) 116 i 03.2007/12.2011 90KW 122CV 1599CC N43 B16 AA 0005ARD 0005AJZ - BMW 1 (E81) 116 i 09.2007/12.2011 85KW 115CV 1596CF N45 B16 A 0005ARC 0005ACW - BMW 1 (E81) 116 i 11.2008/12.2011 90KW 122CV 1995CC N43 B20 A 0005ARE 0005ARF 0005AOH 0005AOR - BMW 1 (E81) 118 d 09.2006/12.2011 100KW 136CV 1995CC ...</p> <p>80x55x47mm 1f-d14mm</p>
	<p><b>UMV25130</b> NO. 25112229442 - 25117566267 - 25117833136 - 25118037305</p> <p><b>MANETE PUNHO TOPO ALAVANCA MUDANÇAS 6 VELOCIDADES F14MM</b></p> <p>BMW 1 (E81) 116 d 11.2008/12.2011 85KW 116CV 1995CC N47 D20 C N47 D20 A 0005ARM 0005AOG - BMW 1 (E81) 116 i 03.2007/12.2011 90KW 122CV 1599CC N43 B16 AA 0005ARD 0005AJZ - BMW 1 (E81) 116 i 09.2007/12.2011 85KW 115CV 1596CF N45 B16 A 0005ARC 0005ACW - BMW 1 (E81) 116 i 11.2008/12.2011 90KW 122CV 1995CC N43 B20 A 0005ARE 0005ARF 0005AOH 0005AOR - BMW 1 (E81) 118 d 09.2006/12.2011 100KW 136CV 1995CC ...</p> <p>81x55x46mm 1f-d14mm</p>		<p><b>UMV26823</b> NO. 25117595326 - 25117896886 - 25118037304 - 25118037305</p> <p><b>MANETE PUNHO TOPO ALAVANCA MUDANÇAS 6 VELOCIDADES F14MM</b></p> <p>BMW 1 (E81) 116 d 11.2008/12.2011 85KW 116CV 1995CC N47 D20 C N47 D20 A 0005ARM 0005AOG - BMW 1 (E81) 116 i 03.2007/12.2011 90KW 122CV 1599CC N43 B16 AA 0005ARD 0005AJZ - BMW 1 (E81) 116 i 09.2007/12.2011 85KW 115CV 1596CF N45 B16 A 0005ARC 0005ACW - BMW 1 (E81) 116 i 11.2008/12.2011 90KW 122CV 1995CC N43 B20 A 0005ARE 0005ARF 0005AOH 0005AOR - BMW 1 (E81) 118 d 09.2006/12.2011 100KW 136CV 1995CC ...</p> <p>d47x75mm 1f-d14mm</p>
	<p><b>UMV26829</b> NO. 25119416257</p> <p><b>MANETE PUNHO TOPO ALAVANCA MUDANÇAS 6 VELOCIDADES F14MM</b></p> <p>BMW SERIE 1 (E81)</p> <p>55x47x97mm 1f-d14mm</p>		<p><b>W5109</b> NO. 11237797995 - 11237797996 - 11237799153 - 11237823191 - 11238578993 - 11238585220 - 11238651643</p> <p><b>POLIE DA CAMBOTA (6 PISTAS)</b></p> <p>BMW SÉRIE 1 (E81) 116 D 116CV (11-2008 A 09-2012) - 118 D 122CV (09-2006 A 09-2012) - 118 D 143CV (09-2006 A 09-2012) - 120 D 177CV (09-2006 A 09-2012)</p> <p>d190mm 4f-d10mm</p>
	<p><b>W5199</b> NO. 11234724814 - 11237803851 - 11237810458</p> <p><b>POLIE DA CAMBOTA (6 PISTAS)</b></p> <p>BMW 1 (E81): 123 d 03.2007/12.2011 150KW 204CV 1995CC</p> <p>d192/172mm d40mm</p>		<p><b>Y3239</b> NO. 36130141574 - 36130141576 - 36131095390 - 36131116717 - 36131117190 - 36131126191 - 36136781150</p> <p><b>PARAFUSO PERNO RODA CHAVE 17 M12X1,50X50MM (BASE CONICA)</b></p> <p>BMW 1 (E81) 118 d 09.2006/12.2011 105KW 143CV 1995CC N47 D20 C N47 D20 A 0005ARO 0005AHWX - BMW 1 (E81) 120 d 03.2007/12.2011 130KW 177CV 1995CC N47 D20 C N47 D20 A 0005ARQ 0005AHY - BMW 1 (E81) 120 i 03.2007/09.2012 125KW 170CV 1995CC N43 B20 A 0005ARI 0005AGJ - BMW 1 (E81) 123 d 03.2007/12.2011 150KW 204CV 1995CC N47 D20 B N47 D20 D 0005ARS 0005AKA - BMW 1 (E81) 130 i 09.2006/12.2011 195KW 265CV ...</p> <p>c51mm (ch-17mm) M12x1x24mm</p>
	<p><b>Z70107</b> NO. 61331459545 - 61332346555</p> <p><b>MOLA DE FIXAÇÃO TIPO PORCA</b></p> <p>BMW 1 (E81) 116 d (11.2008 - 12.2011) 85kw 116cv 1995cm3 Hatchback BMW 1 (E81) 116 i (09.2007 - 12.2011) 85kw 115cv 1596cm3 Hatchback BMW 1 (E81) 116 i (03.2007 - 12.2011) 90kw 122cv 1599cm3 Hatchback BMW 1 (E81) 116 i (11.2008 - 12.2011) 90kw 122cv 1995cm3 Hatchback BMW 1 (E81) 118 d (09.2006 - 12.2011) 100kw 136cv 1995cm3 Hatchback BMW 1 (E81) 118 d (09.2006 - 12.2011) 105kw 143cv 1995cm3 Hatchb...</p> <p>d14x 10mm f-d24mm</p>		<p><b>Z86003</b> NO. 51711932996 - 1932996 - 51711929329</p> <p><b>MOLAS FIXACAO MOLDURA PORTAS</b></p> <p>BMW 1 (E81) 116 d 03.2009/06.2011 85KW 116CV 1995CC N47 D20 C N47 D20 A 0005ASD 0005AOG - BMW 1 (E81) 116 d 01.2011/12.2011 66KW 90CV 1995CC N47 D20 C - BMW 1 (E81) 116 i 06.2004/06.2011 85KW 115CV 1596CF N45 B16 A 0005ART 0005163 0005AAM 0005ACW - BMW 1 (E81) 116 i 09.2007/06.2011 90KW 122CV 1599CC N43 B16 AA 0005ARU 0005AJZ - BMW 1 (E81) 116 i 01.2009/06.2011 90KW 122CV 1995CC N43 B20 A ...</p> <p>F-4G- mm T-12L-8H-7S-1mm</p>

BMW SERIE 1(E82)

	<p><b>D0022</b> NO. 26111209168 - 26111227420 - 26111227717 - 26111229080 - 26111229360 - 26117511454</p> <p><b>CARDAN TRANSMISSÃO D135X30MM 6 FUROS 12MM ENTRE FUROS 96MM</b></p> <p>BMW 1 Coupé (E82) 118 d 09.2009/10.2013 100KW 136CV 1995CC N47 D20 C 0005AQI - BMW 1 Coupé (E82) 118 d 09.2009/10.2013 105KW 143CV 1995CC N47 D20 C 0005AQH - BMW 1 Coupé (E82) 120 d 09.2007/10.2013 120KW 163CV 1995CC N47 D20 CN47 D20 A 0005ASV 0005AKD - BMW 1 Coupé (E82) 120 d 09.2007/10.2013 130KW 177CV 1995CC N47 D20 CN47 D20 A 0005AQX0005AKC 120 d 09.2007 - 10.2013 145 197 1995 N47 D20 CN47 D20...</p> <p>d132x123x30mm 6f-d12mm</p>		<p><b>E1122</b> NO. 18203404099 - 18207544809 - 18207568777 - 18207791570 - 18207798560</p> <p><b>ESTICADOR DO ESCAPE PANELA DE TRÁS</b></p> <p>BMW 1 Coupé (E82) M (De 03.2011 Até 06.2012) 250kW 340cv 2979cm3 Coupé -</p> <p>82x50x25mm 2f-d10mm</p>
	<p><b>F4206</b> NO. 25117595326 - 25118036624 - 25118037304</p> <p><b>FOLE ALAVANCA VELOCIDADES C/ MANETE PUNHO TOPO COMPLETO 5 VELOCIDADES</b></p> <p>BMW Série 1 E82 Coupé. 116i 118i 120i 125i 130i 116d 118d 120d 123d com transmissão manual e LHD 2007/2013</p> <p>172x155x234mm 1f-135x146mm</p>		<p><b>F4207</b> NO. 25118036629 - 25118037309</p> <p><b>FOLE ALAVANCA VELOCIDADES C/ MANETE PUNHO TOPO COMPLETO 6 VELOCIDADES</b></p> <p>BMW 1 Coupé 2009/09-2013/10 E82 120i 1995CC 115 KW 156CV - BMW 1 Coupé 2007/10 - 2013/10 E82 120i 1995CC 125KW 170CV - BMW 1 Coupé 2007/10-2013/10 E82 123d 1995CC 150KW 204CV - BMW 1 Coupé 2008/03-2013/10 E82 125i 2996CC 160KW 218CV - BMW 1 Coupé 2007/10-2013/10 E82 135i 2979CC 225KW 306CV - BMW 1 Coupé 2007/10-2013/10 E82 135i 2979CC 240KW 326CV - BMW 1 Coupé 2011/03-2012/06 E82 M 2979CC 250KW 34...</p> <p>172x153x212mm 135x145mm</p>

	<p><b>KT0624-I</b> NO. 31330146239 - 31331094749 - 31336764085</p> <p><b>KIT BATENTE SUSPENSÃO DA FRENTE</b></p> <p>BMW 1 Coupé (E82) 120 i (De 10-2007 Até 10-2013) 125kW 170CV 1995cc Coupé BMW 1 Coupé (E82) 135 i (De 10-2007 Até 10-2013) 225kW 306CV 2979cc Coupé BMW 1 Coupé (E82) 118 d (De 09-2009 Até 10-2013) 105kW 143CV 1995cc Coupé BMW 1 Coupé (E82) 120 d (De 10-2007 Até 10-2013) 130kW 177CV 1995cc Coupé BMW 1 Coupé (E82) 123 d (De 10-2007 Até 10-2013) 150kW 204CV 1995cc Coupé</p> <p>d90x190mm 1f-d23mm 1f-d70mm</p>		<p><b>KUR21999</b> NO. 1f-d24mm 1f-d10mm 1f-d10mm 1f-d19mm</p> <p><b>KIT DE REPARAÇÃO ALAVANCA DE VELOCIDADES</b></p> <p>BMW 1 Coupé (E82) 118 d (De 09.2009 Até 10.2013) 100kW 136cv 1995cm3 Coupé - BMW 1 Coupé (E82) 118 d (De 09.2009 Até 10.2013) 105kW 143cv 1995cm3 Coupé - BMW 1 Coupé (E82) 120 d (De 09.2007 Até 10.2013) 120kW 163cv 1995cm3 Coupé - BMW 1 Coupé (E82) 120 d (De 09.2007 Até 10.2013) 130kW 177cv 1995cm3 Coupé - BMW 1 Coupé (E82) 120 d (De 09.2007 Até 10.2013) 145kW 197cv 1995cm3 Coupé - BMW 1 Coupé (E82) 120 d (De 09.2007 Até 10.2013) 150kW 204CV 1995cc Coupé</p> <p>d37x18mm d19x25mm d17x22mm d31x21mm d31x20mm d12x19mm d14x19mm d14x15mm</p>
	<p><b>P1042</b> NO. 35211160422</p> <p><b>CAPA DE PEDAL DA EMBRAIAGEM</b></p> <p>BMW 1 Coupé (E82) 118 d 09.2009/10.2013 105KW 143CV 1995CC N47 D20 C 0005AQH - BMW 1 Coupé (E82) 120 d 09.2007/10.2013 130KW 177CV 1995CC N47 D20 C N47 D20 A 0005AQX 0005AKC - BMW 1 Coupé (E82) 120 i 10.2007/10.2013 125KW 170CV 1995CC N43 B20 A 0005AQF - BMW 1 Coupé (E82) 123 d 10.2007/10.2013 150KW 204CV 1995CC N47 D20 D N47 D20 B 0005AKE 0005ARA - BMW 1 Coupé (E82) 125 i 03.2008/10.2013 160KW 21...</p> <p>75x65x40mm</p>		<p><b>R225915</b> NO. 11617797480 - 7797480</p> <p><b>TUBO DO AR SOBREALIMENTAÇÃO</b></p> <p>BMW 1 Coupé (E82) 118 d 09.2009/10.2013 100KW 136CV 1995CC N47 D20 C 0005AQI - BMW 1 Coupé (E82) 118 d 09.2009/10.2013 105KW 143CV 1995CC N47 D20 C 0005AQH</p> <p>B210-45/46mm 72-141mm</p>
	<p><b>RT80330</b> NO. 34306762837 - 34306768851 - 34306789341 - 34306792253</p> <p><b>TUBO DE TRAVÃO TRÁS EXTERNO</b></p> <p>BMW SÉRIE 1 COUPÉ (E82) 118D (APÓS 09-2009) - SÉRIE 1 COUPÉ (E82) 120D (APÓS 10-2007) - SÉRIE 1 COUPÉ (E82) 120i (APÓS 09-2009) - SÉRIE 1 COUPÉ (E82) 123D (APÓS 10-2007) - SÉRIE 1 COUPÉ (E82) 125i (APÓS 10-2007) - SÉRIE 1 COUPÉ (E82) 135i (APÓS 10-2007)</p> <p>265mm F6 - MCL</p>		<p><b>S1618</b> NO. 33326792543 - 33326792544</p> <p><b>SILENT-BLOC BRAÇO SUPERIOR SUSPENSÃO TRÁS EXTERIOR</b></p> <p>BMW 1 Coupé (E82) M 03.2011/06.2012 250KW 340CV 2979CC N54 B30 A 7909AAU</p> <p>d46x49mm c32mm 1f-d12mm</p>
	<p><b>S1619</b> NO. 33326792544 - 33326792543</p> <p><b>SILENT-BLOC BRAÇO SUPERIOR SUSPENSÃO TRÁS INTERIOR</b></p> <p>BMW 1 Coupé (E82) M 03.2011/06.2012 250KW 340CV 2979CC N54 B30 A 7909AAU</p> <p>d40x48mm c38mm 1f-d12mm</p>		<p><b>S1875</b> NO. 33176760288 - 33176770866</p> <p><b>SILENT-BLOC DA CAIXA VELOCIDADES AUTOMÁTICA</b></p> <p>BMW 1 Coupé (E82) 120 d (De 09.2007 Até 10.2013) 130kW 177cv 1995cm3 Coupé - BMW 1 Coupé (E82) 123 d (De 10.2007 Até 10.2013) 150kW 204cv 1995cm3 Coupé - BMW 1 Coupé (E82) 125 i (De 03.2008 Até 10.2013) 160kW 218cv 2996cm3 Coupé - BMW 1 Coupé (E82) 135 i (De 10.2007 Até 10.2013) 225kW 306cv 2979cm3 Coupé -</p> <p>d69x57mm 1f-11x14mm</p>
	<p><b>UAP81292</b> NO. 13532247156 - 2247156</p> <p><b>ANILHA PROTEÇÃO TÉRMICA INJECTORES</b></p> <p>BMW 1 Coupé (E82) 118 d (De 09-2009 Até 10-2013) 100kW 136CV 1995cc Coupé BMW 1 Coupé (E82) 118 d (De 09-2009 Até 10-2013) 105kW 143CV 1995cc Coupé BMW 1 Coupé (E82) 120 d (De 09-2007 Até 10-2013) 130kW 177CV 1995cc Coupé BMW 1 Coupé (E82) 123 d (De 10-2007 Até 10-2013) 150kW 204CV 1995cc Coupé</p> <p>d16x1mm 1f-d7mm</p>		<p><b>UAP81905</b> NO. 13532247156 - 2247156</p> <p><b>ANILHA PROTEÇÃO TÉRMICA INJECTORES</b></p> <p>BMW 1 Coupé (E82) 118 d (De 09-2009 Até 10-2013) 100kW 136CV 1995cc Coupé BMW 1 Coupé (E82) 118 d (De 09-2009 Até 10-2013) 105kW 143CV 1995cc Coupé BMW 1 Coupé (E82) 120 d (De 09-2007 Até 10-2013) 130kW 177CV 1995cc Coupé BMW 1 Coupé (E82) 123 d (De 10-2007 Até 10-2013) 150kW 204CV 1995cc Coupé</p> <p>d14x1mm 1f-d7mm</p>
	<p><b>UMV25112</b> NO. 25112229442 - 25117566267 - 25117833136 - 25118037305</p> <p><b>MANETE PUNHO TOPO ALAVANCA MUDANÇAS 5 VELOCIDADES F14MM</b></p> <p>BMW 1 Coupé (E82) 118 d 09.2009/10.2013 100KW 136CV 1995CC N47 D20 C 0005AQI - BMW 1 Coupé (E82) 118 d 09.2009/10.2013 105KW 143CV 1995CC N47 D20 C 0005AQH - BMW 1 Coupé (E82) 120 d 09.2007/10.2013 120KW 163CV 1995CC N47 D20 C N47 D20 A 0005ASV 0005AKD - BMW 1 Coupé (E82) 120 d 09.2007/10.2013 130KW 177CV 1995CC N47 D20 C N47 D20 A 0005AQX 0005AKC - BMW 1 Coupé (E82) 120 d 09.2007/10.2013 145KW 19...</p> <p>d46x96mm 1f-d14mm</p>		<p><b>UMV25113</b> NO. 25112229442 - 25117566267 - 25117833136 - 25118037305</p> <p><b>MANETE PUNHO TOPO ALAVANCA MUDANÇAS 6 VELOCIDADES F14MM</b></p> <p>BMW 1 Coupé (E82) 118 d 09.2009/10.2013 100KW 136CV 1995CC N47 D20 C 0005AQI - BMW 1 Coupé (E82) 118 d 09.2009/10.2013 105KW 143CV 1995CC N47 D20 C 0005AQH - BMW 1 Coupé (E82) 120 d 09.2007/10.2013 120KW 163CV 1995CC N47 D20 C N47 D20 A 0005ASV 0005AKD - BMW 1 Coupé (E82) 120 d 09.2007/10.2013 130KW 177CV 1995CC N47 D20 C N47 D20 A 0005AQX 0005AKC - BMW 1 Coupé (E82) 120 d 09.2007/10.2013 145KW 19...</p> <p>95x54x45mm 1f-d14mm</p>
	<p><b>UMV25129</b> NO. 25112229442 - 25117566267 - 25117833136 - 25118037305</p> <p><b>MANETE PUNHO TOPO ALAVANCA MUDANÇAS 5 VELOCIDADES F14MM</b></p> <p>BMW 1 Coupé (E82) 118 d 09.2009/10.2013 100KW 136CV 1995CC N47 D20 C 0005AQI - BMW 1 Coupé (E82) 118 d 09.2009/10.2013 105KW 143CV 1995CC N47 D20 C 0005AQH - BMW 1 Coupé (E82) 120 d 09.2007/10.2013 120KW 163CV 1995CC N47 D20 C N47 D20 A 0005ASV 0005AKD - BMW 1 Coupé (E82) 120 d 09.2007/10.2013 130KW 177CV 1995CC N47 D20 C N47 D20 A 0005AQX 0005AKC - BMW 1 Coupé (E82) 120 d 09.2007/10.2013 145KW 19...</p> <p>80x55x47mm 1f-d14mm</p>		<p><b>UMV25130</b> NO. 25112229442 - 25117566267 - 25117833136 - 25118037305</p> <p><b>MANETE PUNHO TOPO ALAVANCA MUDANÇAS 6 VELOCIDADES F14MM</b></p> <p>BMW 1 Coupé (E82) 118 d 09.2009/10.2013 100KW 136CV 1995CC N47 D20 C 0005AQI - BMW 1 Coupé (E82) 118 d 09.2009/10.2013 105KW 143CV 1995CC N47 D20 C 0005AQH - BMW 1 Coupé (E82) 120 d 09.2007/10.2013 120KW 163CV 1995CC N47 D20 C N47 D20 A 0005ASV 0005AKD - BMW 1 Coupé (E82) 120 d 09.2007/10.2013 130KW 177CV 1995CC N47 D20 C N47 D20 A 0005AQX 0005AKC - BMW 1 Coupé (E82) 120 d 09.2007/10.2013 145KW 19...</p> <p>81x55x46mm 1f-d14mm</p>
	<p><b>UMV26823</b> NO. 25117595326 - 25117896886 - 25118037304 - 25118037305</p> <p><b>MANETE PUNHO TOPO ALAVANCA MUDANÇAS 6 VELOCIDADES F14MM</b></p> <p>BMW 1 Coupé (E82) 118 d 09.2009/10.2013 100KW 136CV 1995CC N47 D20 C 0005AQI - BMW 1 Coupé (E82) 118 d 09.2009/10.2013 105KW 143CV 1995CC N47 D20 C 0005AQH - BMW 1 Coupé (E82) 120 d 09.2007/10.2013 120KW 163CV 1995CC N47 D20 C N47 D20 A 0005ASV 0005AKD - BMW 1 Coupé (E82) 120 d 09.2007/10.2013 130KW 177CV 1995CC N47 D20 C N47 D20 A 0005AQX 0005AKC - BMW 1 Coupé (E82) 120 d 09.2007/10.2013 145KW 19...</p> <p>d47x75mm 1f-d14mm</p>		<p><b>W5109</b> NO. 11237797995 - 11237797996 - 11237799153 - 11237823191 - 11238578993 - 11238585220 - 11238651643</p> <p><b>POLIE DA CAMBOTA (6 PISTAS)</b></p> <p>BMW SÉRIE 1 COUPÉ (E82) 118 D 143CV (APÓS 09-2009) - 120 D 177CV (APÓS 10-2007)</p> <p>d190mm 4f-d10mm</p>

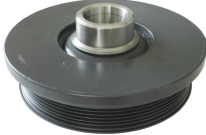
	<b>W5199</b>	NO. 11234724814 - 11237803851 - 11237810458		
	POLIE DA CAMBOTA (6 PISTAS)			
	BMW 1 Coupé (E82): 123 d 10.2007/10.2013 150KW 204CV 1995CC			
	d192/172mm	d40mm		

BMW SERIE 1(E87)

	<b>D0022</b>	NO. 26111209168 - 26111227420 - 26111227717 - 26111229080 - 26111229360 - 26117511454		<b>F1799-I</b>	NO. 33211229593 - 33217529916 - 33217547081
	CARDAN TRANSMISSÃO D135X30MM 6 FUROS 12MM ENTRE FUROS 96MM			FOLE TRANSMISSÃO JUNTO A CAIXA FALANGE D105MM	
	BMW 1 (E87) 116 d 03.2009/06.2011 85KW 116CV 1995CC N47 D20 C N47 D20 A 0005ASD 0005AOG - BMW 1 (E87) 116 i 06.2004/06.2011 85KW 115CV 1596CC N45 B16 A 0005ART 0005163 0005AAM 0005ACW - BMW 1 (E87) 116 i 09.2007/06.2011 90KW 122CV 1599CC N43 B16 AA 0005ARU 0005AJY 0005AJZ - BMW 1 (E87) 116 i 01.2009/06.2011 90KW 122CV 1995CC N43 B20 A 0005ARV 0005ARW 0005AOH 0005AOR - BMW 1 (E87) 118 d 06.2004/02....			BMW SÉRIE 1 (E87) (APÓS 2004) 2.0i 120i	
	d132x123x30mm	6f-d12mm		d102x100mm	1f-d100mm 1f-d23mm
	<b>F1846-I</b>	NO. 33211229594 - 33217527325 - 33217527326 - 33217529915 - 33217547080		<b>F4148</b>	NO. 33536764407 - 33536771381
	FOLE DA TRANSMISSÃO JUNTO Á RODA			FOLE CAPA PROTEÇÃO AMORTECEDOR FRENTE ( GASTA 2 UNIDADES )	
	BMW SÉRIE 1(E87) 2.0i 120i (APÓS 2004)			BMW 1 (E87) 116 d 03.2009/06.2011 85KW 116CV 1995CC N47 D20 C N47 D20 A 0005ASD 0005AOG - BMW 1 (E87) 116 d 01.2011/12.2011 66KW 90CV 1995CC N47 D20 C - BMW 1 (E87) 116 i 06.2004/06.2011 85KW 115CV 1596CC N45 B16 A 0005ART 0005163 0005AAM 0005ACW - BMW 1 (E87) 116 i 09.2007/06.2011 90KW 122CV 1599CC N43 B16 AA 0005ARU 0005AJY 0005AJZ - BMW 1 (E87) 116 i 01.2009/06.2011 90KW 122CV 1995CC N43 B20 A ...	
	d80x78mm	1f-d51mm 1f-d31mm		d64x190mm	1f-d12mm 1f-d54mm
	<b>F4206</b>	NO. 25117595326 - 25118036624 - 25118037304		<b>F4207</b>	NO. 25118036629 - 25118037309
	FOLE ALAVANCA VELOCIDADES C/ MANETE PUNHO TOPO COMPLETO 5 VELOCIDADES			FOLE ALAVANCA VELOCIDADES C/ MANETE PUNHO TOPO COMPLETO 6 VELOCIDADES	
	BMW Série 1 E87 5 portas 116i 118i 120i 125i 130i 116d 118d 120d 123d com transmissão manual e LHD Ano de fabricação 2004/2011			BMW 1 2009/03-2011/06 E87 116d 1995CC 85KW 116CV - BMW 1 2009/01-2011/06 E87 116i 1995CC 90KW 122CV - BMW 1 2007/03-2011/06 E87 116i 1599CC 89KW 121CV - BMW 1 2007/09-2011/06 E87 116i 1599CC 90KW 122CV - BMW 1 2004/06-2011/06 E87 116i 1596CC 85KW 115CV - BMW 1 2007/03-2011/06 E87 118d 1995CC 100KW 136CV - BMW 1 2007/03-2011/06 E87 118d 1995CC 105KW 143CV - BMW 1 2004/06-2007/02 E87 118d 1995CC 90K...	
	172x155x234mm	1f-135x146mm		172x153x212mm	135x145mm
	<b>KF1371</b>	NO. 33211229594 - 33217527325 - 33217527326 - 33217529915 - 33217547080		<b>KT0624-I</b>	NO. 31330146239 - 31331094749 - 31336764085
	KIT DE FOLE DO CARDAN JUNTO Á RODA			KIT BATENTE SUSPENSÃO DA FRENTE	
	BMW 1 SERIES E87 2.0i 120i (APÓS 2004) - BMW 3 SERIES E46 2.0 TD iD 320D - 2.0 TDCR 318D - 2.0 TDCR 320CD - 2.0 TDCR 320D - 2.0 TDCR 320 TD - 2.0i 320i - 2.5i 323Ci - 2.5i 323i - 2.5i - 3.0 TDCR (APÓS 1998) - BMW 5 SERIES E60 - E61 2.5i 525i - 3.0i 530i (			BMW 1 (E87) 116 i (De 11-2003 Até 06-2011) 85kW 115CV 1596cc Hatchback BMW 1 (E87) 116 i (De 03-2007 Até 06-2011) 90kW 122CV 1599cc Hatchback BMW 1 (E87) 116 i (De 01-2009 Até 06-2011) 90kW 122CV 1995cc Hatchback BMW 1 (E87) 118 i (De 07-2004 Até 02-2007) 95kW 129CV 1995cc Hatchback BMW 1 (E87) 118 i (De 09-2006 Até 06-2011) 105kW 143CV 1995cc Hatchback BMW 1 (E87) 120 i (De 11-2003 Até 06-2011) 1...	
	d85x80mm	1f-d50mm 1f-d30mm		d90x190mm	1f-d23mm 1f-d70mm
	<b>KUR21999</b>	NO. 1f-d24mm 1f-d10mm 1f-d10mm 1f-d19mm		<b>P1055</b>	NO. 35211160421
	KIT DE REPARAÇÃO ALAVANCA DE VELOCIDADES			CAPA DE PEDAL DO TRAVÃO(VEICULOS COM CAIXA AUTOMÁTICA)	
	BMW 1 (E87) 116 d (De 03.2009 Até 06.2011) 85kW 116cv 1995cm3 Hatchback - BMW 1 (E87) 116 i (De 06.2004 Até 06.2011) 85kW 115cv 1596cm3 Hatchback - BMW 1 (E87) 116 i (De 09.2007 Até 06.2011) 90kW 122cv 1599cm3 Hatchback - BMW 1 (E87) 116 i (De 01.2009 Até 06.2011) 90kW 122cv 1995cm3 Hatchback - BMW 1 (E87) 118 d (De 06.2004 Até 02.2007) 90kW 122cv 1995cm3 Hatchback - BMW 1 (E87) 118 d (De 03.2007 ...			BMW SÉRIE 1 (E87) 116i - 118i - 118D - 120i - 130i (APÓS 09-2004)	
	d37x18mm d19x25mm d17x22mm d31x21mm d31x21mm d31x21mm d31x21mm d31x21mm d31x21mm			.74x107x42mm	
	<b>P1059</b>	NO. 1 108 634 - 35211108634		<b>Q2010</b>	NO.
	CAPA DE PEDAL DO TRAVÃO			UNIÃO DE ESCAPE 48/52,5X125MM	
	BMW SÉRIE 1 (E87) 120D (APÓS 09-2004) - 130i (APÓS 09-2004)			BMW - 1 (E87) - 116 i (11.03 - 09.12) 115cv 1596cc - BMW - 1 (E87) - 116 i (11.03 - 09.12) 122cv 1599cc - BMW - 1 (E87) - 116 i (11.03 - 09.12) 122cv 1995cc - BMW - 1 (E87) - 118 i (07.04 - 09.12) 129cv 1995cc - BMW - 1 (E87) - 118 i (07.04 - 09.12) 143cv	
	75x62x12mm			125x57x80mm	1f-d48mm



	<p><b>R225915</b> NO. 11617797480 - 7797480</p> <p><b>TUBO DO AR SOBREALIMENTAÇÃO</b></p> <p>BMW 1 (E87) 116 d 03.2009/06.2011 85KW 116CV 1995CC N47 D20 C N47 D20 A 0005ASD 0005AOG - BMW 1 (E87) 116 d 01.2011/12.2011 66KW 90CV 1995CC N47 D20 C - BMW 1 (E87) 118 d 06.2004/02.2007 90KW 122CV 1995CC M47 D20 (204D4) 0005164 0005173 0005AAG 0005AAN 0005ACT 0005ACV - BMW 1 (E87) 118 d 03.2007/06.2011 100KW 136CV 1995CC N47 D20 C N47 D20 A 0005ASG 0005AHX - BMW 1 (E87) 118 d 03.2007/06.2011 105KW...</p> <p>B210-45/46mm 72-141mm</p>		<p><b>RT80266</b> NO. 34306771720</p> <p><b>TUBO DE TRAVÃO FRENTE LH-RH</b></p> <p>BMW SÉRIE 1 (E87) 116i (APÓS 09-2004) - SÉRIE 1 (E87) 118D (APÓS 09-2004) - SÉRIE 1 (E87) 118i (APÓS 09-2004) - SÉRIE 1 (E87) 120D (APÓS 09-2004) - SÉRIE 1 (E87) 120i (APÓS 09-2004) - SÉRIE 1 (E87) 130i (APÓS 09-2005)</p> <p>553mm F6 - MC11</p>
	<p><b>RT80330</b> NO. 34306762837 - 34306768851 - 34306789431 - 34306792253</p> <p><b>TUBO DE TRAVÃO TRÁS EXTERNO</b></p> <p>BMW SÉRIE 1 (E87) 116i (APÓS 09-2004) - SÉRIE 1 (E87) 118D (APÓS 09-2004) - SÉRIE 1 (E87) 120D (APÓS 09-2004) - SÉRIE 1 (E87) 120i (APÓS 09-2004) - SÉRIE 1 (E87) 130i (APÓS 09-2005)</p> <p>265mm F6 - MCL</p>		<p><b>T0627-I</b> NO. 31331094750 - 31336771380</p> <p><b>BATERIA SUSPENSÃO FRENTE</b></p> <p>BMW 1 (E87) 116 d 03.2009/06.2011 85KW 116CV 1995CC N47 D20 C N47 D20 A 0005ASD 0005AOG - BMW 1 (E87) 116 i 06.2004/06.2011 85KW 115CV 1596CC N45 B16 A 0005ART 0005163 0005AAM 0005ACW - BMW 1 (E87) 116 i 09.2007/06.2011 90KW 122CV 1599CC N43 B16 AA 0005ARU 0005AJY 0005AJZ - BMW 1 (E87) 116 i 01.2009/06.2011 90KW 122CV 1995CC N43 B20 A 0005ARV 0005ARW 0005AOH 0005AOR - BMW 1 (E87) 118 d 06.2004/02....</p> <p>d68x86mm 1f-d28mm 1f-d26mm</p>
	<p><b>UAP81292</b> NO. 13532247156 - 2247156</p> <p><b>ANILHA PROTEÇÃO TÉRMICA INJECTORES</b></p> <p>BMW 1 (E87) 116 d (De 12-2008 Até 09-2012) 85kW 116CV 1995cc Hatchback BMW 1 (E87) 118 d (De 11-2003 Até 02-2007) 90kW 122CV 1995cc Hatchback BMW 1 (E87) 120 d (De 03-2003 Até 06-2011) 120kW 163CV 1995cc Hatchback BMW 1 (E87) 123 d (De 03-2007 Até 09-2012) 150kW 204CV 1995cc Hatchback</p> <p>d16x1mm 1f-d7mm</p>		<p><b>UAP81905</b> NO. 13532247156 - 2247156</p> <p><b>ANILHA PROTEÇÃO TÉRMICA INJECTORES</b></p> <p>BMW 1 (E87) 116 d (De 12-2008 Até 09-2012) 85kW 116CV 1995cc Hatchback BMW 1 (E87) 118 d (De 11-2003 Até 02-2007) 90kW 122CV 1995cc Hatchback BMW 1 (E87) 120 d (De 03-2003 Até 06-2011) 120kW 163CV 1995cc Hatchback BMW 1 (E87) 123 d (De 03-2007 Até 09-2012) 150kW 204CV 1995cc Hatchback</p> <p>d14x1mm 1f-d7mm</p>
	<p><b>UMV25106</b> NO. 25117503100 - 25117566267</p> <p><b>MANETE PUNHO TOPO ALAVANCA MUDANÇAS 5 VELOCIDADES F14MM</b></p> <p>BMW 1 (E87) 116 i 06.2004/06.2011 85KW 115CV 1596CC N45 B16 A 0005ART 0005163 0005AAM 0005ACW - BMW 1 (E87) 118 d 06.2004/02.2007 90KW 122CV 1995CC M47 D20 (204D4) 0005164 0005173 0005AAG 0005AAN 0005ACT 0005ACV - BMW 1 (E87) 118 i 07.2004/02.2007 95KW 129CV 1995CC N46 B20 B 0005165 0005AAK 0005ACR - BMW 1 (E87) 120 d 06.2004/02.2007 110KW 150CV 1995CC M47 D20 (204D4) 0005833 0005AAI 0005ACQ - B...</p> <p>95x45x55mm 1f-d14mm</p>		<p><b>UMV25112</b> NO. 25112229442 - 25117566267 - 25117833136 - 25118037305</p> <p><b>MANETE PUNHO TOPO ALAVANCA MUDANÇAS 5 VELOCIDADES F14MM</b></p> <p>BMW 1 (E87) 116 d 03.2009/06.2011 85KW 116CV 1995CC N47 D20 C N47 D20 A 0005ASD 0005AOG - BMW 1 (E87) 116 d 01.2011/12.2011 66KW 90CV 1995CC N47 D20 C - BMW 1 (E87) 116 i 06.2004/06.2011 85KW 115CV 1596CC N45 B16 A 0005ART 0005163 0005AAM 0005ACW - BMW 1 (E87) 116 i 09.2007/06.2011 90KW 122CV 1599CC N43 B16 AA 0005ARU 0005AJY 0005AJZ - BMW 1 (E87) 116 i 01.2009/06.2011 90KW 122CV 1995CC N43 B20 ...</p> <p>d46x96mm 1f-d14mm</p>
	<p><b>UMV25113</b> NO. 25112229442 - 25117566267 - 25117833136 - 25118037305</p> <p><b>MANETE PUNHO TOPO ALAVANCA MUDANÇAS 6 VELOCIDADES F14MM</b></p> <p>BMW 1 (E87) 116 d 03.2009/06.2011 85KW 116CV 1995CC N47 D20 C N47 D20 A 0005ASD 0005AOG - BMW 1 (E87) 116 d 01.2011/12.2011 66KW 90CV 1995CC N47 D20 C - BMW 1 (E87) 116 i 06.2004/06.2011 85KW 115CV 1596CC N45 B16 A 0005ART 0005163 0005AAM 0005ACW - BMW 1 (E87) 116 i 09.2007/06.2011 90KW 122CV 1599CC N43 B16 AA 0005ARU 0005AJY 0005AJZ - BMW 1 (E87) 116 i 01.2009/06.2011 90KW 122CV 1995CC N43 B20 A ...</p> <p>95x54x45mm 1f-d14mm</p>		<p><b>UMV25127</b> NO. 25112229442 - 25117566267 - 25117833136 - 25118037305</p> <p><b>MANETE PUNHO TOPO ALAVANCA MUDANÇAS 5 VELOCIDADES F14MM</b></p> <p>BMW 1 (E87) 116 i (De 06.2004 Até 06.2011) 85KW 115cv 1596cm3 Hatchback - BMW 1 (E87) 118 d (De 06.2004 Até 02.2007) 90KW 122cv 1995cm3 Hatchback - BMW 1 (E87) 118 i (De 07.2004 Até 02.2007) 95kW 129cv 1995cm3 Hatchback - BMW 1 (E87) 120 d (De 06.2004 Até 06.2011) 120kW 163cv 1995cm3 Hatchback - BMW 1 (E87) 120 i (De 06.2004 Até 02.2007) 110kW 150cv 1995cm3 Hatchback - BMW 1 (E87) 120 i (De 03.200...)</p> <p>d46x94mm 1f-d14mm</p>
	<p><b>UMV25129</b> NO. 25112229442 - 25117566267 - 25117833136 - 25118037305</p> <p><b>MANETE PUNHO TOPO ALAVANCA MUDANÇAS 5 VELOCIDADES F14MM</b></p> <p>BMW 1 (E87) 116 d 03.2009/06.2011 85KW 116CV 1995CC N47 D20 C N47 D20 A 0005ASD 0005AOG - BMW 1 (E87) 116 d 01.2011/12.2011 66KW 90CV 1995CC N47 D20 C - BMW 1 (E87) 116 i 06.2004/06.2011 85KW 115CV 1596CC N45 B16 A 0005ART 0005163 0005AAM 0005ACW - BMW 1 (E87) 116 i 09.2007/06.2011 90KW 122CV 1599CC N43 B16 AA 0005ARU 0005AJY 0005AJZ - BMW 1 (E87) 116 i 01.2009/06.2011 90KW 122CV 1995CC N43 B20 A ...</p> <p>80x55x47mm 1f-d14mm</p>		<p><b>UMV25130</b> NO. 25112229442 - 25117566267 - 25117833136 - 25118037305</p> <p><b>MANETE PUNHO TOPO ALAVANCA MUDANÇAS 6 VELOCIDADES F14MM</b></p> <p>BMW 1 (E87) 116 d 03.2009/06.2011 85KW 116CV 1995CC N47 D20 C N47 D20 A 0005ASD 0005AOG - BMW 1 (E87) 116 d 01.2011/12.2011 66KW 90CV 1995CC N47 D20 C - BMW 1 (E87) 116 i 06.2004/06.2011 85KW 115CV 1596CC N45 B16 A 0005ART 0005163 0005AAM 0005ACW - BMW 1 (E87) 116 i 09.2007/06.2011 90KW 122CV 1599CC N43 B16 AA 0005ARU 0005AJY 0005AJZ - BMW 1 (E87) 116 i 01.2009/06.2011 90KW 122CV 1995CC N43 B20 A ...</p> <p>81x55x46mm 1f-d14mm</p>
	<p><b>UMV26823</b> NO. 25117595326 - 25117896886 - 25118037304 - 25118037305</p> <p><b>MANETE PUNHO TOPO ALAVANCA MUDANÇAS 6 VELOCIDADES F14MM</b></p> <p>BMW 1 (E87) 116 d 03.2009/06.2011 85KW 116CV 1995CC N47 D20 C N47 D20 A 0005ASD 0005AOG - BMW 1 (E87) 116 d 01.2011/12.2011 66KW 90CV 1995CC N47 D20 C - BMW 1 (E87) 116 i 06.2004/06.2011 85KW 115CV 1596CC N45 B16 A 0005ART 0005163 0005AAM 0005ACW - BMW 1 (E87) 116 i 09.2007/06.2011 90KW 122CV 1599CC N43 B16 AA 0005ARU 0005AJY 0005AJZ - BMW 1 (E87) 116 i 01.2009/06.2011 90KW 122CV 1995CC N43 B20 A ...</p> <p>d47x75mm 1f-d14mm</p>		<p><b>W5199</b> NO. 11234724814 - 11237803851 - 11237810458</p> <p><b>POLIE DA CAMBOTA (6 PISTAS)</b></p> <p>BMW 1 (E87): 123 d 03.2007/06.2011 150KW 204CV 1995CC</p> <p>d192/172mm d40mm</p>
	<p><b>Y3239</b> NO. 36130141574 - 36130141576 - 36131095390 - 36131116717 - 36131117190 - 36131126191</p> <p><b>PARAFUSO PERNO RODA CHAVE 17 M12X1,50X50MM ( BASE CONICA )</b></p> <p>BMW 1 (E87) 116 i 06.2004/06.2011 85KW 115CV 1596CC N45 B16 A 0005ART 0005163 0005AAM 0005ACW - BMW 1 (E87) 118 d 06.2004/02.2007 90KW 122CV 1995CC M47 D20 (204D4) 0005164 0005173 0005AAG 0005AAN 0005ACT 0005ACV - BMW 1 (E87) 118 d 03.2007/06.2011 105KW 143CV 1995CC N47 D20 C N47 D20 A 0005ASF 0005AHW - BMW 1 (E87) 118 i 07.2004/02.2007 95KW 129CV 1995CC N46 B20 B 0005165 0005AAK 0005ACR - BMW 1 (...)</p> <p>c51mm (ch-17mm) M12x1x24mm</p>		



	<p><b>D0022</b> NO. 26111209168 - 26111227420 - 26111227717 - 26111229080 - 26111229360 - 26117511454</p> <p><b>CARDAN TRANSMISSÃO D135X30MM 6 FUROS 12MM ENTRE FUROS 96MM</b></p> <p>BMW 1 Cabriolet (E88) 118 d 09.2008/12.2013 100KW 136CV 1995CC N47 D20 C N47 D20 A 0005ANC 0005AQV - BMW 1 Cabriolet (E88) 118 d 09.2008/12.2013 105KW 143CV 1995CC N47 D20 C N47 D20 A 0005ANB 0005AQW - BMW 1 Cabriolet (E88) 118 i 03.2008/12.2013 105KW 143CV 1995CC N43 B20 A 0005AQN 0005AMP - BMW 1 Cabriolet (E88) 120 d 03.2008/12.2013 130KW 177CV 1995CC N47 D20 C N47 D20 A 0005AQY 0005AMN - BMW 1 Cab...</p> <p>d132x123x30mm 6f-d12mm</p>		<p><b>F4206</b> NO. 25117595326 - 25118036624 - 25118037304</p> <p><b>FOLE ALAVANCA VELOCIDADES C/ MANETE PUNHO TOPO COMPLETO 5 VELOCIDADES</b></p> <p>BMW 1 Series E88 Cabrio. 116i 118i 120i 125i 130i 116d 118d 120d 123d com transmissão manual e LHD 2008/2013</p> <p>172x155x234mm 1f-135x146mm</p>
	<p><b>F4207</b> NO. 25118036629 - 25118037309</p> <p><b>FOLE ALAVANCA VELOCIDADES C/ MANETE PUNHO TOPO COMPLETO 6 VELOCIDADES</b></p> <p>BMW 1 Cabriolet 2008/09-2013/12 E88 118d 1995CC 100KW 136CV - BMW 1 Cabriolet 2008/09-2013/12 E88 118d 1995CC 105KW 143CV - BMW 1 Cabriolet 2008/09-2013/12 E88 118i 1995CC 100KW 136CV - BMW 1 Cabriolet 2008/03-2013/12 E88 118i 1995CC 105KW 143CV - BMW 1 Cabriolet 2008/03-2013/12 E88 120d 1995CC 120KW 163CV - BMW 1 Cabriolet 2008/03-2013/12 E88 120d 1995CC 130KW 177CV - BMW 1 Cabriolet 2008/03-201...</p> <p>172x153x212mm 135x145mm</p>		<p><b>KT0624-I</b> NO. 31330146239 - 31331094749 - 31336764085</p> <p><b>KIT BATENTE SUSPENSÃO DA FRENTE</b></p> <p>BMW 1 Cabriolet (E88) 118 i (De 03-2008 Até 12-2013) 105KW 143CV 1995cc Cabriolet BMW 1 Cabriolet (E88) 120 i (De 03-2008 Até 12-2013) 115KW 156CV 1995cc Cabriolet BMW 1 Cabriolet (E88) 120 i (De 03-2008 Até 12-2013) 125KW 170CV 1995cc Cabriolet BMW 1 Cabriolet (E88) 125 i (De 03-2008 Até 12-2013) 160KW 218CV 2996cc Cabriolet BMW 1 Cabriolet (E88) 135 i (De 03-2008 Até 12-2013) 225KW 306CV 2979cc ...</p> <p>d90x190mm 1f-d23mm 1f-d70mm</p>
	<p><b>KUR21999</b> NO. 1f-d24mm 1f-d10mm 1f-d10mm 1f-d19mm</p> <p><b>KIT DE REPARAÇÃO ALAVANCA DE VELOCIDADES</b></p> <p>BMW 1 Cabriolet (E88) 118 d (De 09.2008 Até 12.2013) 100KW 136cv 1995cm3 Cabriolet - BMW 1 Cabriolet (E88) 118 d (De 09.2008 Até 12.2013) 105KW 143cv 1995cm3 Cabriolet - BMW 1 Cabriolet (E88) 118 i (De 03.2008 Até 12.2013) 105KW 143cv 1995cm3 Cabriolet - BMW 1 Cabriolet (E88) 120 d (De 03.2008 Até 12.2013) 120KW 163cv 1995cm3 Cabriolet - BMW 1 Cabriolet (E88) 120 d (De 03.2008 Até 12.2013) 130KW 1...</p> <p>d37x18mm d19x25mm d17x22x4mm d31x210mm #3126120mm r12411962</p>		<p><b>P1042</b> NO. 35211160422</p> <p><b>CAPA DE PEDAL</b></p> <p>BMW 1 Cabriolet (E88) 118 d 09.2008/12.2013 105KW 143CV 1995CC N47 D20 C N47 D20 A 0005ANB 0005AQW - BMW 1 Cabriolet (E88) 118 i 03.2008/12.2013 105KW 143CV 1995CC N43 B20 A 0005AQN 0005AMP - BMW 1 Cabriolet (E88) 120 d 03.2008/12.2013 130KW 177CV 1995CC N47 D20 C N47 D20 A 0005AQY 0005AMN - BMW 1 Cabriolet (E88) 120 i 12.2007/10.2013 125KW 170CV 1995CC N43 B20 A 0005AQO 0005AMQ - BMW 1 Cabriolet ...</p> <p>.75x65x40mm</p>
	<p><b>R222288</b> NO. 11617797482 - 11617823887 - 7797482 - 7823887</p> <p><b>TUBO DO AR SOBREALIMENTAÇÃO</b></p> <p>BMW 1 Cabriolet (E88) 118 d 09.2008/12.2013 100KW 136CV 1995CC N47 D20 C N47 D20 A 0005ANC 0005AQV - BMW 1 Cabriolet (E88) 118 d 09.2008/12.2013 105KW 143CV 1995CC N47 D20 C N47 D20 A 0005ANB 0005AQW - BMW 1 Coupé (E82) 118 d 09.2009/10.2013 100KW 136CV 1995CC N47 D20 C 0005AQI - BMW 1 Coupé (E82) 118 d 09.2009/10.2013 105KW 143CV 1995CC N47 D20 C 0005AQH</p> <p>B335-46/46mm 71x89x68x95mm</p>		<p><b>RT80330</b> NO. 34306762837 - 34306768851 - 34306789431 - 34306792253</p> <p><b>TUBO DE TRAVÃO TRÁS EXTERNO</b></p> <p>BMW SÉRIE 1 CABRIOLET (E88) 118D (APÓS 09-2008) - SÉRIE 1 CABRIOLET (E88) 118i (APÓS 03-2008) - SÉRIE 1 CABRIOLET (E88) 120D (APÓS 03-2008) - SÉRIE 1 CABRIOLET (E88) 120i (APÓS 03-2008) - SÉRIE 1 CABRIOLET (E88) 125i (APÓS 03-2008) - SÉRIE 1 CABRIOLET</p> <p>265mm F6 - MCL</p>
	<p><b>S1875</b> NO. 33176760288 - 33176770866</p> <p><b>SILENT-BLOC DA CAIXA VELOCIDADES AUTOMÁTICA</b></p> <p>BMW 1 Cabriolet (E88) 118 d (De 09.2008 Até 12.2013) 105KW 143cv 1995cm3 Cabriolet - BMW 1 Cabriolet (E88) 118 i (De 03.2008 Até 12.2013) 105KW 143cv 1995cm3 Cabriolet - BMW 1 Cabriolet (E88) 120 d (De 03.2008 Até 12.2013) 130KW 177cv 1995cm3 Cabriolet BMW 1 Cabriolet (E88) 120 i (De 12.2007 Até 10.2013) 125KW 170cv 1995cm3 Cabriolet BMW 1 Cabriolet (E88) 123 d (De 09.2008 Até 12.2013) 150KW 204cv...</p> <p>d69x57mm 1f-11x14mm</p>		<p><b>UAP81292</b> NO. 13532247156 - 2247156</p> <p><b>ANILHA PROTEÇÃO TÉRMICA INJECTORES</b></p> <p>BMW 1 Cabriolet (E88) 118 d (De 09-2008 Até 12-2013) 105KW 143CV 1995cc Cabriolet BMW 1 Cabriolet (E88) 120 d (De 03-2008 Até 12-2013) 130KW 177CV 1995cc Cabriolet BMW 1 Cabriolet (E88) 123 d (De 09-2008 Até 12-2013) 150KW 204CV 1995cc Cabriolet</p> <p>d16x1mm 1f-d7mm</p>
	<p><b>UAP81905</b> NO. 13532247156 - 2247156</p> <p><b>ANILHA PROTEÇÃO TÉRMICA INJECTORES</b></p> <p>BMW 1 Cabriolet (E88) 118 d (De 09-2008 Até 12-2013) 105KW 143CV 1995cc Cabriolet BMW 1 Cabriolet (E88) 120 d (De 03-2008 Até 12-2013) 130KW 177CV 1995cc Cabriolet BMW 1 Cabriolet (E88) 123 d (De 09-2008 Até 12-2013) 150KW 204CV 1995cc Cabriolet</p> <p>d14x1mm 1f-d7mm</p>		<p><b>UMV25112</b> NO. 25112229442 - 25117566267 - 25117833136 - 25118037305</p> <p><b>MANETE PUNHO TOPO ALAVANCA MUDANÇAS 5 VELOCIDADES F14MM</b></p> <p>BMW 1 Cabriolet (E88) 118 d 09.2008/12.2013 100KW 136CV 1995CF N47 D20 C N47 D20 A 0005ANC 0005AQV - BMW 1 Cabriolet (E88) 118 d 09.2008/12.2013 105KW 143CV 1995CC N47 D20 C N47 D20 A 0005ANB 0005AQW - BMW 1 Cabriolet (E88) 118 i 03.2008/10.2013 105KW 143CV 1995CC N43 B20 A 0005AQN 0005AMP - BMW 1 Cabriolet (E88) 120 d 03.2008/12.2013 120KW 163CV 1995CC N47 D20 C N47 D20 A 0005AMM 0005AQZ - BMW 1 ...</p> <p>d46x96mm 1f-d14mm</p>
	<p><b>UMV25113</b> NO. 25112229442 - 25117566267 - 25117833136 - 25118037305</p> <p><b>MANETE PUNHO TOPO ALAVANCA MUDANÇAS 6 VELOCIDADES F14MM</b></p> <p>BMW 1 Cabriolet (E88) 118 d 09.2008/12.2013 100KW 136CV 1995CC N47 D20 C N47 D20 A 0005ANC 0005AQV - BMW 1 Cabriolet (E88) 118 d 09.2008/12.2013 105KW 143CV 1995CC N47 D20 C N47 D20 A 0005ANB 0005AQW - BMW 1 Cabriolet (E88) 118 i 03.2008/10.2013 105KW 143CV 1995CC N43 B20 A 0005AQN 0005AMP - BMW 1 Cabriolet (E88) 120 d 03.2008/12.2013 120KW 163CV 1995CC N47 D20 C N47 D20 A 0005AMM 0005AQZ - BMW 1 ...</p> <p>95x54x45mm 1f-d14mm</p>		<p><b>UMV25129</b> NO. 25112229442 - 25117566267 - 25117833136 - 25118037305</p> <p><b>MANETE PUNHO TOPO ALAVANCA MUDANÇAS 5 VELOCIDADES F14MM</b></p> <p>BMW 1 Cabriolet (E88) 118 d 09.2008/12.2013 100KW 136CV 1995CC N47 D20 C N47 D20 A 0005ANC 0005AQV - BMW 1 Cabriolet (E88) 118 d 09.2008/12.2013 105KW 143CV 1995CC N47 D20 C N47 D20 A 0005ANB 0005AQW - BMW 1 Cabriolet (E88) 118 i 03.2008/10.2013 105KW 143CV 1995CC N43 B20 A 0005AQN 0005AMP - BMW 1 Cabriolet (E88) 120 d 03.2008/12.2013 120KW 163CV 1995CC N47 D20 C N47 D20 A 0005AMM 0005AQZ - BMW 1 ...</p> <p>80x55x47mm 1f-d14mm</p>
	<p><b>UMV25130</b> NO. 25112229442 - 25117566267 - 25117833136 - 25118037305</p> <p><b>MANETE PUNHO TOPO ALAVANCA MUDANÇAS 6 VELOCIDADES F14MM</b></p> <p>BMW 1 Cabriolet (E88) 118 d 09.2008/12.2013 100KW 136CV 1995CC N47 D20 C N47 D20 A 0005ANC 0005AQV - BMW 1 Cabriolet (E88) 118 d 09.2008/12.2013 105KW 143CV 1995CC N47 D20 C N47 D20 A 0005ANB 0005AQW - BMW 1 Cabriolet (E88) 118 i 03.2008/10.2013 105KW 143CV 1995CC N43 B20 A 0005AQN 0005AMP - BMW 1 Cabriolet (E88) 120 d 03.2008/12.2013 120KW 163CV 1995CC N47 D20 C N47 D20 A 0005AMM 0005AQZ - BMW 1 ...</p> <p>81x55x46mm 1f-d14mm</p>		<p><b>UMV26823</b> NO. 25117595326 - 25117896886 - 25118037304 - 25118037305</p> <p><b>MANETE PUNHO TOPO ALAVANCA MUDANÇAS 6 VELOCIDADES F14MM</b></p> <p>BMW 1 Cabriolet (E88) 118 d 09.2008/12.2013 100KW 136CV 1995CC N47 D20 C N47 D20 A 0005ANC 0005AQV - BMW 1 Cabriolet (E88) 118 d 09.2008/12.2013 105KW 143CV 1995CC N47 D20 C N47 D20 A 0005ANB 0005AQW - BMW 1 Cabriolet (E88) 118 i 03.2008/10.2013 105KW 143CV 1995CC N43 B20 A 0005AQN 0005AMP - BMW 1 Cabriolet (E88) 120 d 03.2008/12.2013 120KW 163CV 1995CC N47 D20 C N47 D20 A 0005AMM 0005AQZ - BMW 1 ...</p> <p>d47x75mm 1f-d14mm</p>





	<p><b>W5125</b> NO. 11517545958 - 1151751012 - 11517619020 - 7545958 - 7571012 - 7619020</p> <p><b>POLIE DA BOMBA DE ÁGUA</b></p> <p>BMW SÉRIE 1 (F20) - 114 i (APÓS 11.11) 102cv 1598cc Hatchback - BMW SÉRIE 1 (F20) - 116 i (APÓS 12.10) 136cv 1598cc Hatchback - BMW SÉRIE 1 (F20) - 118 i (APÓS 11.10) 170cv 1598cc Hatchback - BMW SÉRIE 1 (F21) - 114 i (APÓS 12.11) 102cv 1598cc Hatchback -</p> <p>d123mm d20mm</p>		<p><b>W5141</b> NO. 11237797996 - 11238513539 - 11238578993 - 11238585220 - 11238651643</p> <p><b>POLIE DA CAMBOTA 7 PISTAS</b></p> <p>BMW SÉRIE 1 (F20) M 135 i (APÓS 11.11) 320cv 2979cc Hatchback - BMW 1 (F20) 125 d (APÓS 08.11) 218cv 1995cc Hatchback - BMW 1 (F21) M 135 i (APÓS 12.11) 320cv 2979cc Hatchback - BMW 1 (F21) 125 d (APÓS 12.11) 211cv 1995cc Hatchback</p> <p>d166,7mm d10mm</p>
	<p><b>W5142</b> NO. 11237797996 - 11238512072 - 11238578993 - 11238585220 - 11238651643</p> <p><b>POLIE DA CAMBOTA 6 PISTAS</b></p> <p>BMW SÉRIE 1 (F20) 114 i (APÓS 11.11) 102cv 1598cc Hatchback - BMW 1 (F20) 114 d (APÓS 10.12) 95cv 1598cc Hatchback - BMW 1 (F20) 116 d (APÓS 11.12) 116cv 1598cc Hatchback - BMW 1 (F20) 116 d (APÓS 12.10) 116cv 1995cc Hatchback - BMW 1 (F20) 118 d (APÓS 12.10) 136cv 1995cc Hatchback - BMW 1 (F20) 118 d (APÓS 12.10) 143cv 1995cc Hatchback - BMW 1 (F20) 120 d (APÓS 12.10) 163cv 1995cc Hatchback...</p> <p>d185mm d10mm</p>		<p><b>W5184</b> NO. 11237643074 - 11238584913 - 11232384185 - 11235A80209 - 11238579926 - 11239886682</p> <p><b>POLIE DA CAMBOTA (6 PISTAS)</b></p> <p>BMW 1 (F20): 114 d 07.2015/06.2019 70KW 95CV 1496CC - BMW 1 (F20): 116 d 03.2015/06.2019 85KW 116CV 1496CC - BMW 1 (F21): 114 d 06.2015/&gt;&gt;&gt; 70KW 95CV 1496CC - BMW 1 (F21): 116 d 03.2015/&gt;&gt;&gt; 85KW 116CV 1496CC</p> <p>d157/68mm d38mm</p>
	<p><b>W5192</b> NO. 11238602800</p> <p><b>POLIE DA CAMBOTA (6 PISTAS)</b></p> <p>BMW 1 (F20): 120 i 07.2016/06.2019 135KW 184CV 1998CC - BMW 1 (F20): 125 i 07.2016/06.2019 165KW 224CV 1998CC</p> <p>d158mm d59mm</p>		<p><b>W5210</b> NO. 11237619245 - 11237797996 - 11238518985 - 11238578993 - 11238585220 - 11238586724 - 11238651643</p> <p><b>POLIE DA CAMBOTA (6 PISTAS)</b></p> <p>BMW 1 (F20): 118 d 07.2011/06.2019 100KW 136CV 1995CC - BMW 1 (F20): 118 d 07.2011/02.2015 105KW 143CV 1995CC - BMW 1 (F20): 118 d xDrive 07.2013/02.2015 105KW 143CV 1995CC - BMW 1 (F20): 118 d 03.2015/06.2019 110KW 150CV 1995CC - BMW 1 (F20): 118 d xDrive 03.2015/06.2019 110KW 150CV 1995CC - BMW 1 (F20): 120 d 07.2011/06.2019 120KW 163CV 1995CC - BMW 1 (F20): 120 d 07.2011/02.2015 135KW 184CV ...</p> <p>d155mm d40/60mm 4f-d10mm</p>

BMW SERIE 1(F21)

	<p><b>A2569</b> NO. 22316796617</p> <p><b>APOIO DA CAIXA DE VELOCIDADES</b></p> <p>BMW 1 (F20) 114 d (De 07.2015 Até 06.2019) 70kW 95cv 1496cm3 Hatchback - BMW 1 (F20) 114 d (De 11.2012 Até 06.2015) 70kW 95cv 1598cm3 Hatchback - BMW 1 (F20) 114 i (De 07.2012 Até 02.2015) 75kW 102cv 1598cm3 Hatchback - BMW 1 (F20) 116 d (De 03.2015 Até 06.2019) 85kW 116cv 1496cm3 Hatchback - BMW 1 (F20) 116 d (De 03.2012 Até 02.2015) 85kW 116cv 1598cm3 Hatchback - BMW 1 (F20) 116 d (De 07.2011 A...</p> <p>74x46x40mm 1p-d7x16mm 1p-d8x31mm</p>		<p><b>A2569</b> NO. 22316796617</p> <p><b>APOIO DA CAIXA DE VELOCIDADES</b></p> <p>BMW 1 (F20) 114 d (De 07.2015 Até 06.2019) 70kW 95cv 1496cm3 Hatchback - BMW 1 (F20) 114 d (De 11.2012 Até 06.2015) 70kW 95cv 1598cm3 Hatchback - BMW 1 (F20) 114 i (De 07.2012 Até 02.2015) 75kW 102cv 1598cm3 Hatchback - BMW 1 (F20) 116 d (De 03.2015 Até 06.2019) 85kW 116cv 1496cm3 Hatchback - BMW 1 (F20) 116 d (De 03.2012 Até 02.2015) 85kW 116cv 1598cm3 Hatchback - BMW 1 (F20) 116 d (De 07.2011 A...</p> <p>74x46x40mm 1p-d7x16mm 1p-d8x31mm</p>
	<p><b>D0022</b> NO. 26111209168 - 26111227420 - 26111227717 - 26111229080 - 26111229360 - 26117511454</p> <p><b>CARDAN TRANSMISSÃO D135X30MM 6 FUROS 12MM ENTRE FUROS 96MM</b></p> <p>BMW 1 (F21) 114 d desde 07.2012 70KW 95CV 1598CC N47 D16 A 0005BMK - BMW 1 (F21) 114 d desde 06.2015 70KW 95CV 1496CC B37 D15 A 0005CAP - BMW 1 (F21) 116 d desde 12.2011 85KW 116CV 1598CC N47 D16 A 0005BLV - BMW 1 (F21) 116 d desde 01.2012 85KW 116CV 1995CC N47 D20 C 0005BLS - BMW 1 (F21) 116 d desde 03.2015 85KW 116CV 1496CC B37 D15 A 0005CAQ 0005CAR - BMW 1 (F21) 116 i desde 12.2011 100KW 136CV ...</p> <p>d132x123x30mm 6f-d12mm</p>		<p><b>F4363</b> NO. 25117596009</p> <p><b>FOLE ALAVANCA VELOCIDADES C/ MANETE PUNHO TOPO COMPLETO 6 VELOCIDADES</b></p> <p>BMW 1 (F21) 114 d 07.2012/05.2019 70KW 95CV 1598CC N47 D16 A 0005BMK - BMW 1 (F21) 116 d 12.2011/02.2015 85KW 116CV 1598CC N47 D16 A 0005BLV - BMW 1 (F21) 116 d 07.2012/02.2015 85KW 116CV 1995CC N47 D20 C 0005BLS - BMW 1 (F21) 118 d 12.2011/06.2019 100KW 136CV 1995CC N47 D20 C 0005BMT - BMW 1 (F21) 118 d 12.2011/02.2015 105KW 143CV 1995CC N47 D20 C 0005BLT - BMW 1 (F21) 118 d xDrive 05.2013/02.201...</p> <p>240x152x146mm 1f-134x141mm</p>
	<p><b>KUR21999</b> NO. 1f-d24mm 1f-d10mm 1f-d10mm 1f-d19mm</p> <p><b>KIT DE REPARAÇÃO ALAVANCA DE VELOCIDADES</b></p> <p>BMW 1 (F21) 114 d (De 06.2015 -) 70kW 95cv 1496cm3 Hatchback - BMW 1 (F21) 114 d (De 07.2012 -) 70kW 95cv 1598cm3 Hatchback - BMW 1 (F21) 114 i (De 12.2011 -) 75kW 102cv 1598cm3 Hatchback - BMW 1 (F21) 116 d (De 03.2015 -) 85kW 116cv 1496cm3 Hatchback - BMW 1 (F21) 116 d (De 12.2011 -) 85kW 116cv 1598cm3 Hatchback - BMW 1 (F21) 116 d (De 01.2012 -) 85kW 116cv 1995cm3 Hatchback - BMW 1 (F21) 116 i ...</p> <p>d37x18mm d19x25mm d7x24mm d10x31mm d10x31mm d10x31mm d19x25mm</p>		<p><b>R225332</b> NO. 13717597586 - 7597586</p> <p><b>TUBO DE ADMISSÃO FILTRO DE AR</b></p> <p>BMW 1 (F21) 114 i 07.2012/01.2015 75KW 102CV 1598CC N13 B16 A 0005BLY - BMW 1 (F21) 116 i desde 12.2011 100KW 136CV 1598CC N13 B16 A 0005BLV - BMW 1 (F21) 116 i desde 03.2015 80KW 109CV 1499CC B38 B15 A 0005CAJ - BMW 1 (F21) 118 i desde 07.2012 125KW 170CV 1598CC N13 B16 A 0005BML - BMW 1 (F21) 118 i desde 03.2015 100KW 136CV 1598CC N13 B16 A 0005CAK - BMW 1 (F21) 118 i desde 03.2015 100KW 136CV ...</p> <p>.B220-46/69mm 143-105mm</p>
	<p><b>S1618</b> NO. 33326792543</p> <p><b>SILENT-BLOC BRAÇO SUPERIOR SUSPENSÃO TRÁS EXTERIOR</b></p> <p>BMW 1 (F21) 114 d 07.2012/05.2019 70KW 95CV 1598CC N47 D16 A 0005BMK - BMW 1 (F21) 114 d 06.2015/05.2019 70KW 95CV 1496CC B37 D15 A 0005CAP - BMW 1 (F21) 114 i 07.2012/01.2015 75KW 102CV 1598CC N13 B16 A 0005BLY - BMW 1 (F21) 116 d 12.2011/02.2015 85KW 116CV 1598CC N47 D16 A 0005BLV - BMW 1 (F21) 116 d 07.2012/02.2015 85KW 116CV 1995CC N47 D20 C 0005BLS - BMW 1 (F21) 116 d 03.2015/05.2019 85KW 116...</p> <p>d46x49mm c32mm 1f-d12mm</p>		<p><b>S1619</b> NO. 33326792544</p> <p><b>SILENT-BLOC BRAÇO SUPERIOR SUSPENSÃO TRÁS INTERIOR</b></p> <p>BMW 1 (F21) 114 d 07.2012/05.2019 70KW 95CV 1598CC N47 D16 A 0005BMK - BMW 1 (F21) 114 d 06.2015/05.2019 70KW 95CV 1496CC B37 D15 A 0005CAP - BMW 1 (F21) 114 i 07.2012/01.2015 75KW 102CV 1598CC N13 B16 A 0005BLY - BMW 1 (F21) 116 d 12.2011/02.2015 85KW 116CV 1598CC N47 D16 A 0005BLV - BMW 1 (F21) 116 d 07.2012/02.2015 85KW 116CV 1995CC N47 D20 C 0005BLS - BMW 1 (F21) 116 d 03.2015/05.2019 85KW 116...</p> <p>d40x48mm c38mm 1f-d12mm</p>

## BMW SERIE 1(F21)

Rafri, Lda.

	<p><b>UAP81292</b> NO. 13532247156 - 2247156</p> <p><b>ANILHA PROTEÇÃO TÉRMICA INJECTORES</b></p> <p>BMW 1 (F21) 114 d (De 07-2012 Até .1-20 -) 70kW 95CV 1598cc Hatchback BMW 1 (F21) 116 d (De 03-2015 Até .1-20 -) 85kW 116CV 1496cc Hatchback BMW 1 (F21) 116 d (De 12-2011 Até .1-20 -) 85kW 116CV 1598cc Hatchback BMW 1 (F21) 116 d (De 01-2012 Até .1-20 -) 85kW 116CV 1995cc Hatchback BMW 1 (F21) 118 d (De 12-2011 Até .1-20 -) 100kW 136CV 1995cc Hatchback BMW 1 (F21) 118 d (De 12-2011 Até .1-20 -) 10...</p> <p>d16x1mm 1f-d7mm</p>		<p><b>UAP81905</b> NO. 13532247156 - 2247156</p> <p><b>ANILHA PROTEÇÃO TÉRMICA INJECTORES</b></p> <p>BMW 1 (F21) 114 d (De 07-2012 Até .1-20 -) 70kW 95CV 1598cc Hatchback BMW 1 (F21) 116 d (De 03-2015 Até .1-20 -) 85kW 116CV 1496cc Hatchback BMW 1 (F21) 116 d (De 12-2011 Até .1-20 -) 85kW 116CV 1598cc Hatchback BMW 1 (F21) 116 d (De 01-2012 Até .1-20 -) 85kW 116CV 1995cc Hatchback BMW 1 (F21) 118 d (De 12-2011 Até .1-20 -) 100kW 136CV 1995cc Hatchback BMW 1 (F21) 118 d (De 12-2011 Até .1-20 -) 10...</p> <p>d14x1mm 1f-d7mm</p>
	<p><b>W5192</b> NO. 11238602800</p> <p><b>POLIE DA CAMBOTA (6 PISTAS)</b></p> <p>BMW 1 (F21): 120 i 07.2016/&gt;&gt;&gt; 135KW 184CV 1998CC - BMW 1 (F21): 125 i 10.2015/&gt;&gt;&gt; 165KW 224CV 1998CC</p> <p>d158mm d59mm</p>		<p><b>W5210</b> NO. 11237619245 - 11237797996 - 11238518985 - 11238578993 - 11238585220 - 11238586724 - 11238651643</p> <p><b>POLIE DA CAMBOTA (6 PISTAS)</b></p> <p>BMW 1 (F21): 118 d 12.2011/02.2015 100KW 136CV 1995CC - BMW 1 (F21): 118 d 12.2011/&gt;&gt;&gt; 105KW 143CV 1995CC - BMW 1 (F21): 118 d xDrive 05.2013/&gt;&gt;&gt; 105KW 143CV 1995CC - BMW 1 (F21): 118 d 03.2015/&gt;&gt;&gt; 110KW 150CV 1995CC - BMW 1 (F21): 118 d xDrive 03.2015/&gt;&gt;&gt; 110KW 150CV 1995CC - BMW 1 (F21): 120 d 07.2012/&gt;&gt;&gt; 120KW 163CV 1995CC - BMW 1 (F21): 120 d 07.2012/&gt;&gt;&gt; 135KW 184CV 1995CC - BMW 1 (F21): 120 d...</p> <p>d155mm d40/60mm 4f-d10mm</p>

## BMW SERIE 2 (F22) - (F87)

	<p><b>A2569</b> NO. 22316796617</p> <p><b>APOIO DA CAIXA DE VELOCIDADES</b></p> <p>BMW 2 Cabriolet (F23) 218 d (De 07.2015 -) 110kW 150cv 1995cm3 Cabriolet - BMW 2 Cabriolet (F23) 218 i (De 03.2015 -) 100kW 136cv 1499cm3 Cabriolet - BMW 2 Cabriolet (F23) 220 d (De 03.2014 -) 140kW 190cv 1995cm3 Cabriolet - BMW 2 Cabriolet (F23) 220 i (De 04.2014 Até 07.2016) 135kW 184cv 1997cm3 Cabriolet - BMW 2 Cabriolet (F23) 220 i (De 09.2015 -) 135kW 184cv 1998cm3 Cabriolet - BMW 2 Cabriolet...</p> <p>74x46x40mm 1p-d7x16mm 1p-d8x31mm</p>		<p><b>D0022</b> NO. 26111209168 - 26111227420 - 26111227717 - 26111229080 - 26111229360 - 261117511454</p> <p><b>CARDAN TRANSMISSÃO D135X30MM 6 FUROS 12MM ENTRE FUROS 96MM</b></p> <p>BMW 2 Coupé (F22, F87) 218 d 03.2014/06.2015 100KW 136CV 1995CC N47 D20 CB47 D20 A 0005BUC - BMW 2 Coupé (F22, F87) 218 d 03.2014/06.2015 105KW 143CV 1995CC N47 D20 C 0005BUB - BMW 2 Coupé (F22, F87) 218 d desde 07.2015 110KW 150CV 1995CC B47 D20 A 0005CCX - BMW 2 Coupé (F22, F87) 218 i desde 03.2015 100KW 136CV 1995CC B38 B15 A 0005BYM 0005DFD - BMW 2 Coupé (F22, F87) 220 d 10.2012/11.2014 135KW 184CV 1995CC N47 D20 C 00...</p> <p>d132x123x30mm 6f-d12mm</p>
	<p><b>D0022</b> NO. 26111209168 - 26111227420 - 26111227717 - 26111229080 - 26111229360 - 261117511454</p> <p><b>CARDAN TRANSMISSÃO D135X30MM 6 FUROS 12MM ENTRE FUROS 96MM</b></p> <p>BMW 2 Coupé (F87) 218 d 03.2014/06.2015 100KW 136CV 1995CC N47 D20 CB47 D20 A 0005BUC - BMW 2 Coupé (F87) 218 d 03.2014/06.2015 105KW 143CV 1995CC N47 D20 C 0005BUB - BMW 2 Coupé (F87) 218 d desde 07.2015 110KW 150CV 1995CC B47 D20 A 0005CCX - BMW 2 Coupé (F87) 218 i desde 03.2015 100KW 136CV 1995CC B38 B15 A 0005BYM 0005DFD - BMW 2 Coupé (F87) 220 d 10.2012/11.2014 135KW 184CV 1995CC N47 D20 C 00...</p> <p>d132x123x30mm 6f-d12mm</p>		<p><b>KUR21999</b> NO. 1f-d24mm 1f-d10mm 1f-d10mm 1f-d19mm</p> <p><b>KIT DE REPARAÇÃO ALAVANCA DE VELOCIDADES</b></p> <p>BMW 2 Coupé (F22, F87) 218 d (De 03.2014 -) 100kW 136cv 1995cm3 Coupé - BMW 2 Coupé (F22, F87) 218 d (De 03.2014 Até 06.2015) 105kW 143cv 1995cm3 Coupé - BMW 2 Coupé (F22, F87) 218 d (De 07.2015 -) 110kW 150cv 1995cm3 Coupé - BMW 2 Coupé (F22, F87) 218 d (De 03.2015 -) 100kW 136cv 1499cm3 Coupé - BMW 2 Coupé (F22, F87) 220 d (De 11.2014 -) 120kW 163cv 1995cm3 Coupé - BMW 2 Coupé (F22, F87) 220 d (...)</p> <p>d37x18mm d19x25mm d7x22mm d31x21mm d31x21mm d14x19mm d14x19mm d15mm</p>
	<p><b>S1618</b> NO. 33326792543</p> <p><b>SILENT-BLOC BRAÇO SUPERIOR SUSPENSÃO TRÁS EXTERIOR</b></p> <p>BMW 2 Coupé (F22, F87) 218 d 03.2014/09.2020 100KW 136CV 1995CC N47 D20 C B47 D20 A 0005BUC - BMW 2 Coupé (F22, F87) 218 d 03.2014/06.2015 105KW 143CV 1995CC N47 D20 C 0005BUB - BMW 2 Coupé (F22, F87) 218 d 07.2015/09.2020 110KW 150CV 1995CC B47 D20 A 0005CCX - BMW 2 Coupé (F22, F87) 218 i 03.2015/06.2021 100KW 136CV 1499CC B38 B15 A 0005BYM 0005DFD - BMW 2 Coupé (F22, F87) 220 d 10.2012/11.2014 1...</p> <p>d46x49mm c32mm 1f-d12mm</p>		<p><b>S1619</b> NO. 33326792544</p> <p><b>SILENT-BLOC BRAÇO SUPERIOR SUSPENSÃO TRÁS INTERIOR</b></p> <p>BMW 2 Coupé (F22, F87) 218 d 03.2014/09.2020 100KW 136CV 1995CC N47 D20 C B47 D20 A 0005BUC - BMW 2 Coupé (F22, F87) 218 d 03.2014/06.2015 105KW 143CV 1995CC N47 D20 C 0005BUB - BMW 2 Coupé (F22, F87) 218 d 07.2015/09.2020 110KW 150CV 1995CC B47 D20 A 0005CCX - BMW 2 Coupé (F22, F87) 218 i 03.2015/06.2021 100KW 136CV 1499CC B38 B15 A 0005BYM 0005DFD - BMW 2 Coupé (F22, F87) 220...</p> <p>d40x48mm c38mm 1f-d12mm</p>
	<p><b>UAP81292</b> NO. 13532247156 - 2247156</p> <p><b>ANILHA PROTEÇÃO TÉRMICA INJECTORES</b></p> <p>BMW 2 Coupé (F22 - F87) 218 d (De 01-2014 Até .1-20 -) 105kW 143CV 1995cc Coupé BMW 2 Coupé (F22 - F87) 220 d (De 10-2012 Até 11-2014) 135kW 184CV 1995cc Coupé BMW 2 Coupé (F22 - F87) 220 d (De 03-2014 Até .1-20 -) 140kW 190CV 1995cc Coupé BMW 2 Coupé (F22 - F87) 220 d xDrive (De 06-2014 Até .1-20 -) 140kW 190CV 1995cc Coupé BMW 2 Coupé (F22 - F87) 225 d (De 01-2014 Até .1-20 -) 160kW 218CV 1995cc...</p> <p>d16x1mm 1f-d7mm</p>		<p><b>UAP81905</b> NO. 13532247156 - 2247156</p> <p><b>ANILHA PROTEÇÃO TÉRMICA INJECTORES</b></p> <p>BMW 2 Coupé (F22 - F87) 218 d (De 01-2014 Até .1-20 -) 105kW 143CV 1995cc Coupé BMW 2 Coupé (F22 - F87) 220 d (De 10-2012 Até 11-2014) 135kW 184CV 1995cc Coupé BMW 2 Coupé (F22 - F87) 220 d (De 03-2014 Até .1-20 -) 140kW 190CV 1995cc Coupé BMW 2 Coupé (F22 - F87) 220 d xDrive (De 06-2014 Até .1-20 -) 140kW 190CV 1995cc Coupé BMW 2 Coupé (F22 - F87) 225 d (De 01-2014 Até .1-20 -) 160kW 218CV 1995cc...</p> <p>d14x1mm 1f-d7mm</p>
	<p><b>W5192</b> NO. 11238602800</p> <p><b>POLIE DA CAMBOTA (6 PISTAS)</b></p> <p>BMW 2 Coupé (F22, F87): 220 i 09.2015/&gt;&gt;&gt; 135KW 184CV 1998CC - BMW 2 Coupé (F22, F87): 230 i 07.2016/&gt;&gt;&gt; 185KW 252CV 1998CC</p> <p>d158mm d59mm</p>		<p><b>W5210</b> NO. 11237619245 - 11237797996 - 11238518985 - 11238578993 - 11238585220 - 11238586724 - 11238651643</p> <p><b>POLIE DA CAMBOTA (6 PISTAS)</b></p> <p>BMW 2 Coupé (F22, F87): 218 d 03.2014/06.2015 105KW 143CV 1995CC - BMW 2 Coupé (F22, F87): 218 d 07.2015/&gt;&gt;&gt; 110KW 150CV 1995CC - BMW 2 Coupé (F22, F87): 220 d 10.2012/11.2014 135KW 184CV 1995CC - BMW 2 Coupé (F22, F87): 220 d 03.2014/&gt;&gt;&gt; 140KW 190CV 1995CC - BMW 2 Coupé (F22, F87): 220 d xDrive 06.2014/&gt;&gt;&gt; 140KW 190CV 1995CC - BMW 2 Coupé (F22, F87): 220 d 10.2012/11.2014 147KW 200CV 1995CC</p> <p>d155mm d40/60mm 4f-d10mm</p>



	<p><b>D0022</b> NO. 26111209168 - 26111227420 - 26111227717 - 26111229080 - 26111229360 - 26117511454</p> <p><b>CARDAN TRANSMISSÃO D135X30MM 6 FUROS 12MM ENTRE FUROS 96MM</b></p> <p>BMW 2 Cabriolet (F23) 218 d desde 07.2015 100KW 136CV 1995CC B47 D20 A 0005CDB - BMW 2 Cabriolet (F23) 218 d desde 07.2015 110KW 150CV 1995CC B47 D20 A 0005CDA - BMW 2 Cabriolet (F23) 218 i desde 03.2015 100KW 136CV 1499CC B38 B15 A 0005BYS 0005DFE - BMW 2 Cabriolet (F23) 220 d desde 03.2014 140KW 190CV 1995CC B47 D20 A 0005BYW - BMW 2 Cabriolet (F23) 220 i 04.2014/07.2016 135KW 184CV 1997CC N20 B...</p> <p>d132x123x30mm 6f-d12mm</p>		<p><b>KUR21999</b> NO. 1f-d24mm 1f-d10mm 1f-d10mm 1f-d19mm</p> <p><b>KIT DE REPARAÇÃO ALAVANCA DE VELOCIDADES</b></p> <p>BMW 2 Cabriolet (F23) 218 d (De 07.2015 -) 110KW 150cv 1995cm3 Cabriolet - BMW 2 Cabriolet (F23) 218 i (De 03.2015 -) 100kW 136cv 1499cm3 Cabriolet - BMW 2 Cabriolet (F23) 220 d (De 03.2014 -) 140KW 190cv 1995cm3 Cabriolet - BMW 2 Cabriolet (F23) 220 i (De 09.2015 -) 135kW 184cv 1998cm3 Cabriolet - BMW 2 Cabriolet (F23) 230 i (De 07.2016 -) 185KW 252cv 1998cm3 Cabriolet - BMW 2 Cabriolet (F23) M ...</p> <p>d37x18mm d19x25mm d17x22mm d31x21mm d31x20mm d12x10mm d12x10mm d12x10mm d12x10mm d12x10mm d12x10mm</p>
	<p><b>S1618</b> NO. 33326792543</p> <p><b>SILENT-BLOC BRAÇO SUPERIOR SUSPENSÃO TRÁS EXTERIOR</b></p> <p>BMW 2 Cabriolet (F23) 218 d 07.2015/09.2020 100KW 136CV 1995CC B47 D20 A 0005CDB - BMW 2 Cabriolet (F23) 218 d 07.2015/09.2020 110KW 150CV 1995CC B47 D20 A 0005CDA - BMW 2 Cabriolet (F23) 218 i 03.2015/06.2021 100KW 136CV 1499CC B38 B15 A 0005BYS - BMW 2 Cabriolet (F23) 220 d 03.2014/09.2020 140KW 190CV 1995CC B47 D20 A 0005BYW - BMW 2 Cabriolet (F23) 220 i 03.2014/06.2021 135KW 184CV 1997...</p> <p>d40x48mm c38mm 1f-d12mm</p>		<p><b>S1619</b> NO. 33326792544</p> <p><b>SILENT-BLOC BRAÇO SUPERIOR SUSPENSÃO TRÁS INTERIOR</b></p> <p>BMW 2 Cabriolet (F23) 218 d 07.2015/09.2020 100KW 136CV 1995CC B47 D20 A 0005CDB - BMW 2 Cabriolet (F23) 218 d 07.2015/09.2020 110KW 150CV 1995CC B47 D20 A 0005CDA - BMW 2 Cabriolet (F23) 218 i 03.2015/06.2021 100KW 136CV 1499CC B38 B15 A 0005BYS - BMW 2 Cabriolet (F23) 220 d 03.2014/09.2020 140KW 190CV 1995CC B47 D20 A 0005BYW - BMW 2 Cabriolet (F23) 220 i 04.2014/06.2021 135KW 184CV 1997CC N20 B...</p> <p>d40x48mm c38mm 1f-d12mm</p>
	<p><b>UAP81292</b> NO. 13532247156 - 2247156</p> <p><b>ANILHA PROTEÇÃO TÉRMICA INJECTORES</b></p> <p>BMW 2 Cabriolet (F23) 220 d (De 03-2014 Até .1-20 -) 140KW 190CV 1995cc Cabriolet BMW 2 Cabriolet (F23) 225 d (De 07-2015 Até .1-20 -) 165kW 224CV 1995cc Cabriolet</p> <p>d16x1mm 1f-d7mm</p>		<p><b>UAP81905</b> NO. 13532247156 - 2247156</p> <p><b>ANILHA PROTEÇÃO TÉRMICA INJECTORES</b></p> <p>BMW 2 Cabriolet (F23) 220 d (De 03-2014 Até .1-20 -) 140KW 190CV 1995cc Cabriolet BMW 2 Cabriolet (F23) 225 d (De 07-2015 Até .1-20 -) 165kW 224CV 1995cc Cabriolet</p> <p>d14x1mm 1f-d7mm</p>
	<p><b>W5192</b> NO. 11238602800</p> <p><b>POLIE DA CABBOTA (6 PISTAS)</b></p> <p>BMW 2 Cabriolet (F23): 220 i 09.2015/&gt;&gt;&gt; 135KW 184CV 1998CC - BMW 2 Cabriolet (F23): 230 i 07.2016/&gt;&gt;&gt; 185KW 252CV 1998CC</p> <p>d158mm d59mm</p>		<p><b>W5210</b> NO. 11237619245 - 11237797996 - 11238518985 - 11238578993 - 11238585220 - 11238586724 - 11238651643</p> <p><b>POLIE DA CABBOTA (6 PISTAS)</b></p> <p>BMW 2 Cabriolet (F23) 218 d 07.2015/&gt;&gt;&gt; 100kW 136CV 1995CC - BMW 2 Cabriolet (F23): 218 d 07.2015/&gt;&gt;&gt; 110KW 150CV 1995CC - BMW 2 Cabriolet (F23): 220 d 03.2014/&gt;&gt;&gt; 140KW 190CV 1995CC</p> <p>d155mm d40/60mm 4f-d10mm</p>

BMW SERIE 2 (F45)

	<p><b>E0643-M</b> NO. 22116885788 - 6885788</p> <p><b>ESTICADOR SUPORTE APOIO MOTOR TRAS</b></p> <p>BMW 2 Active Tourer (F45) 214 d 07.2014/02.2018 70KW 95CV 1496CC B37 C15 A 0005CJT 0005BZB - BMW 2 Active Tourer (F45) 216 d 03.2014/10.2021 85KW 116CV 1496CC B37 C15 A 0005CJU 0005BXS - BMW 2 Active Tourer (F45) 216 i 02.2015/02.2018 75KW 102CV 1499CC B38 A15 A 0005CJM 0005CBW - BMW 2 Active Tourer (F45) 216 i 03.2018/10.2021 80KW 109CV 1499CC B38 A15 A 0005CQW - BMW 2 Active Tourer (F45) 218 d 1...</p> <p>253x62x75mm 1f-d13mm 1f-d12mm</p>		<p><b>S1618</b> NO. 33326792543</p> <p><b>SILENT-BLOC BRAÇO SUPERIOR SUSPENSÃO TRÁS EXTERIOR</b></p> <p>BMW 2 Active Tourer (F45) 214 d 07.2014/02.2018 70KW 95CV 1496CC B37 C15 A 0005CJT 0005BZB - BMW 2 Active Tourer (F45) 216 d 03.2014/10.2021 85KW 116CV 1496CC B37 C15 A 0005CJU 0005BXS - BMW 2 Active Tourer (F45) 216 i 02.2015/02.2018 75KW 102CV 1499CC B38 A15 A 0005CJM 0005CBW - BMW 2 Active Tourer (F45) 218 d 11.2013/10.2021 100KW 136CV 1995CC B47 C20 B B47 C20 A 0005CJW 0005BWQ - BMW 2 Active T...</p> <p>d46x49mm c32mm 1f-d12mm</p>
	<p><b>S1619</b> NO. 33326792544</p> <p><b>SILENT-BLOC BRAÇO SUPERIOR SUSPENSÃO TRÁS INTERIOR</b></p> <p>BMW 2 Active Tourer (F45) 214 d 07.2014/02.2018 70KW 95CV 1496CC B37 C15 A 0005CJT 0005BZB - BMW 2 Active Tourer (F45) 216 d 03.2014/10.2021 85KW 116CV 1496CC B37 C15 A 0005CJU 0005BXS - BMW 2 Active Tourer (F45) 216 i 02.2015/02.2018 75KW 102CV 1499CC B38 A15 A 0005CJM 0005CBW - BMW 2 Active Tourer (F45) 218 d 11.2013/10.2021 100KW 136CV 1995CC B47 C20 B B47 C20 A 0005CJW 0005BWQ - BMW 2 Active T...</p> <p>d40x48mm c38mm 1f-d12mm</p>		<p><b>UAP81292</b> NO. 13532247156 - 2247156</p> <p><b>ANILHA PROTEÇÃO TÉRMICA INJECTORES</b></p> <p>BMW 2 Active Tourer (F45) 214 d (De 07-2014 Até 02-2018) 70kW 95CV 1496cc Veículo multiuso BMW 2 Active Tourer (F45) 216 d (De 03-2014 Até .1-20 -) 85kW 116CV 1496cc Veículo multiuso BMW 2 Active Tourer (F45) 218 d xDrive (De 12-2014 Até .1-20 -) 110kW 150CV 1995cc Veículo multiuso</p> <p>d16x1mm 1f-d7mm</p>
	<p><b>UAP81905</b> NO. 13532247156 - 2247156</p> <p><b>ANILHA PROTEÇÃO TÉRMICA INJECTORES</b></p> <p>BMW 2 Active Tourer (F45) 214 d (De 07-2014 Até 02-2018) 70kW 95CV 1496cc Veículo multiuso BMW 2 Active Tourer (F45) 216 d (De 03-2014 Até .1-20 -) 85kW 116CV 1496cc Veículo multiuso BMW 2 Active Tourer (F45) 218 d xDrive (De 12-2014 Até .1-20 -) 110kW 150CV 1995cc Veículo multiuso</p> <p>d14x1mm 1f-d7mm</p>		<p><b>W5184</b> NO. 11237643074 - 11238584913 - 7643074 - 8584913</p> <p><b>POLIE DA CABBOTA (6 PISTAS)</b></p> <p>BMW 2 Active Tourer (F45): 214 d 07.2014/02.2018 70KW 95CV 1496CC - BMW 2 Active Tourer (F45): 216 d 03.2014/&gt;&gt;&gt; 85KW 116CV 1496CC</p> <p>d157/68mm d38mm</p>

## BMW SERIE 2 (F45)

Rafri, Lda.















	<p><b>W5192</b> NO. 11238602800</p> <p><i>POLIE DA CAMBOTA (6 PISTAS)</i></p> <p>BMW 2 Active Tourer (F45): 220 i 03.2014/&gt;&gt;&gt; 141KW 192CV 1998CC - BMW 2 Active Tourer (F45): 225 i 11.2013/&gt;&gt;&gt; 170KW 231CV 1998CC - BMW 2 Active Tourer (F45): 225 i xDrive 03.2014/&gt;&gt;&gt; 170KW 231CV 1998CC - BMW 2 Active Tourer (F45): 218 d 11.2013/&gt;&gt;&gt; 100KW 136CV 1995CC - BMW 2 Active Tourer (F45): 218 d 11.2013/&gt;&gt;&gt; 110KW 150CV 1995CC - BMW 2 Active Tourer (F45): 218 d xDrive 12.2014/&gt;&gt;&gt; 110KW 150CV...</p> <p>d158mm d59mm</p>		<p><b>Z55278</b> NO. 51410407983 - 51418224781 - 51430141025</p> <p><i>MOLA PAINEL RESVESTIMENTO PORTAS</i></p> <p>BMW 2 Active Tourer (F45) 214 d (07.2014 - 02.2018) 70kw 95cv 1496cm3 Veículo multiuso BMW 2 Active Tourer (F45) 216 d (03.2014 - 10.2021) 85kw 116cv 1496cm3 Veículo multiuso BMW 2 Active Tourer (F45) 216 i (02.2015 - 02.2018) 75kw 102cv 1499cm3 Veículo multiuso BMW 2 Active Tourer (F45) 218 d (11.2013 - 10.2021) 100kw 136cv 1995cm3 Veículo multiuso BMW 2 Active Tourer (F45) 218 d (11.2013 - 10.20...</p> <p>F-8T-18mm L-14H-21S1-7mm</p>
	<p><b>Z80910</b> NO. 51777171002</p> <p><i>MOLA DO PAINEL DA PORTA</i></p> <p>BMW 2 Active Tourer (F45) 214 d 07.2014/02.2018 70KW 95CV 1496CC B37 C15 A 0005CJT 0005BZB - BMW 2 Active Tourer (F45) 216 d 03.2014/10.2021 85KW 116CV 1496CC B37 C15 A 0005CJU 0005BXS - BMW 2 Active Tourer (F45) 216 i 02.2015/02.2018 75KW 102CV 1499CC B38 A15 A 0005CJM 0005CBW - BMW 2 Active Tourer (F45) 216 i 03.2018/10.2021 80KW 109CV 1499CC B38 A15 A 0005CQW - BMW 2 Active Tourer (F45) 218 d 1...</p> <p>F-8 T-18 L-16 H-21 S1-3</p>		

## BMW SERIE 2 (F46)

	<p><b>E0643-M</b> NO. 22116885788 - 6885788</p> <p><i>ESTICADOR SUPORTE APOIO MOTOR TRAS</i></p> <p>BMW 2 Gran Coupe (F44) 218 d desde 11.2019 100KW 136CV 1995CC B47 C20 B 0005DBA - BMW 2 Gran Coupe (F44) 218 d desde 07.2020 110KW 150CV 1995CC B47 C20 B 0005DAZ - BMW 2 Gran Coupe (F44) 220 d desde 11.2019 120KW 163CV 1995CC B47 C20 B 0005CYE - BMW 2 Gran Coupe (F44) 220 d desde 11.2019 140KW 190CV 1995CC B47 C20 B 0005DFU - BMW 2 Gran Coupe (F44) 220 d xDrive desde 07.2020 140KW 190CV 19...</p> <p>253x62x75mm 1f-d13mm 1f-d12mm</p>		<p><b>S1618</b> NO. 33326792543</p> <p><i>SILENT-BLOC BRAÇO SUPERIOR SUSPENSÃO TRÁS EXTERIOR</i></p> <p>BMW 2 Gran Tourer (F46) 214 d (07.2015/02.2018 70KW 95CV 1496CC B37 C15 A 0005CKG 0005CBT - BMW 2 Gran Tourer (F46) 216 d desde 03.2015 85KW 116CV 1496CC B37 C15 A 0005CKH 0005BZE - BMW 2 Gran Tourer (F46) 216 i 09.2014/02.2018 75KW 102CV 1499CC B38 A15 A 0005CKD 0005CBS - BMW 2 Gran Tourer (F46) 218 d desde 07.2014 100KW 136CV 1995CC B47 C20 A B47 C20 B 0005CKJ 0005BZF - BMW 2 Gran Tourer (F46) 21...</p> <p>d46x49mm c32mm 1f-d12mm</p>
	<p><b>S1619</b> NO. 33326792544</p> <p><i>SILENT-BLOC BRAÇO SUPERIOR SUSPENSÃO TRÁS INTERIOR</i></p> <p>BMW 2 Gran Tourer (F46) 214 d (07.2015/02.2018 70KW 95CV 1496CC B37 C15 A 0005CKG 0005CBT - BMW 2 Gran Tourer (F46) 216 d desde 03.2015 85KW 116CV 1496CC B37 C15 A 0005CKH 0005BZE - BMW 2 Gran Tourer (F46) 216 i 09.2014/02.2018 75KW 102CV 1499CC B38 A15 A 0005CKD 0005CBS - BMW 2 Gran Tourer (F46) 218 d desde 07.2014 100KW 136CV 1995CC B47 C20 A B47 C20 B 0005CKJ 0005BZF - BMW 2 Gran Tourer (F46) 21...</p> <p>d40x48mm c38mm 1f-d12mm</p>		<p><b>UAP81292</b> NO. 13532247156 - 2247156</p> <p><i>ANILHA PROTEÇÃO TÉRMICA INJECTORES</i></p> <p>BMW 2 Gran Tourer (F46) 214 d (De 07-2015 Até 02-2018) 70kW 95CV 1496cc Veículo multiuso BMW 2 Gran Tourer (F46) 216 d (De 08-2014 Até .1-20 -) 85kW 116CV 1496cc Veículo multiuso</p> <p>d16x1mm 1f-d7mm</p>
	<p><b>UAP81905</b> NO. 13532247156 - 2247156</p> <p><i>ANILHA PROTEÇÃO TÉRMICA INJECTORES</i></p> <p>BMW 2 Gran Tourer (F46) 214 d (De 07-2015 Até 02-2018) 70kW 95CV 1496cc Veículo multiuso BMW 2 Gran Tourer (F46) 216 d (De 08-2014 Até .1-20 -) 85kW 116CV 1496cc Veículo multiuso</p> <p>d14x1mm 1f-d7mm</p>		<p><b>W5184</b> NO. 11237643074 - 11238584913</p> <p><i>POLIE DA CAMBOTA (6 PISTAS)</i></p> <p>BMW 2 Gran Tourer (F46): 214 d 07.2015/02.2018 70KW 95CV 1496CC - BMW 2 Gran Tourer (F46): 216 d 08.2014/&gt;&gt;&gt; 85KW 116CV 1496CC</p> <p>d157/68mm d38mm</p>
	<p><b>W5192</b> NO. 11238602800</p> <p><i>POLIE DA CAMBOTA (6 PISTAS)</i></p> <p>BMW 2 Gran Tourer (F46): 220 i 03.2015/&gt;&gt;&gt; 141KW 192CV 1998CC - BMW 2 Gran Tourer (F46): 218 d 07.2014/&gt;&gt;&gt; 110KW 150CV 1995CC - BMW 2 Gran Tourer (F46): 218 d xDrive 03.2015/&gt;&gt;&gt; 110KW 150CV 1995CC - BMW 2 Gran Tourer (F46): 220 d xDrive 03.2015/&gt;&gt;&gt; 120KW 163CV 1995CC - BMW 2 Gran Tourer (F46): 220 d 09.2014/&gt;&gt;&gt; 140KW 190CV 1995CC - BMW 2 Gran Tourer (F46): 220 d xDrive 03.2015/&gt;&gt;&gt; 140KW 190CV 1995...</p> <p>d158mm d59mm</p>		<p><b>Z80910</b> NO. 51777171002</p> <p><i>MOLA DO PAINEL DA PORTA</i></p> <p>BMW 2 Gran Tourer (F46) 214 d (07.2015/02.2018 70KW 95CV 1496CC B37 C15 A 0005CKG 0005CBT - BMW 2 Gran Tourer (F46) 216 d desde 08.2014 85KW 116CV 1496CC B37 C15 A 0005CKH 0005BZE - BMW 2 Gran Tourer (F46) 216 i 09.2014/02.2018 75KW 102CV 1499CC B38 A15 A 0005CKD 0005CBS - BMW 2 Gran Tourer (F46) 216 i desde 03.2018 80KW 109CV 1499CC B38 A15 A 0005CQV - BMW 2 Gran Tourer (F46) 218 d desde 07.2014 1...</p> <p>F-8 T-18 L-16 H-21 S1-3</p>

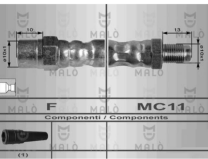
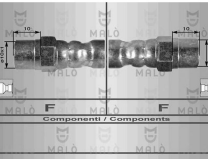

	<p><b>A0948</b> NO. 26111206502 - 26121104355 - A26111206502</p> <p><b>APOIO SUPORTE CENTRAL DA TRANSMISSÃO COM ROLAMENTO</b></p> <p>BMW 3 (E21) 315 03.1981/03.1984 55KW 75CV 1573CC M10 B16 (164VB) 0005418 - BMW 3 (E21) 316 08.1975/08.1980 66KW 90CV 1573CC M10 B16 (164VA) 0005385 - BMW 3 (E21) 316 09.1980/12.1982 66KW 90CV 1766CC M10 B18 (184VC) 0005416 - BMW 3 (E21) 318 08.1975/08.1980 72KW 98CV 1766CC M10 B18 (184VA) 0005386 - BMW 3 (E21) 318 i 11.1979/08.1982 77KW 105CV 1766CC M10 B18 (184VA) 0005417 - BMW 3 (E21) 320 06.197...</p> <p>155x101x42mm d30mm</p>		<p><b>A1317</b> NO. 11811132321 - 11811132323 - 11811175212 - 11811246437</p> <p><b>APOIO SUPORTE DA FRENTE ESQUERDA DO MOTOR</b></p> <p>BMW 3 (E21) 320/6 08.1977/10.1982 90KW 122CV 1990CC M20 B20 (206VA) 0005404 - BMW 3 (E21) 323 i 01.1978/10.1982 105KW 143CV 2316CC M20 B23 (236EA) 0005405</p> <p>d70x48mm 1p-d10-35mm 1p-d10-22mm</p>
	<p><b>A1949</b> NO. 0019811225 - 0029812925 - 0039812325 - 0089814325 - 26121103728 - 26121209590 - 26121225071 - 261212...</p> <p><b>APOIO DA TRANSMISSÃO</b></p> <p>BMW 3 (E21) 315 (03.81 A 03.84) 75cv 1573cc três volumes - BMW 3 (E21) 316 (08.75 A 08.80) 90cv 1573cc três volumes - BMW 3 (E21) 316 (09.80 A 08.82) 90cv 1766cc três volumes - BMW 3 (E21) 318 CÃ3digo do motor: M 10B18D (08.75 A 08.80) 98cv 1766cc três volumes - BMW 3 (E21) 318 i (11.79 A 08.82) 105cv 1766cc três volumes - BMW 3 (E21) 320 (08.75 A 08.77) 109cv 1990cc três volumes - BM...</p> <p>170x110x56mm 1f-d30mm</p>		<p><b>A2292</b> NO. 11811109174</p> <p><b>APOIO DO MOTOR LADO ESQUERDO</b></p> <p>BMW 3 (E21) 316 (De 1975.08 Até 1980.08) 66kW 90cv 1573cm3 três volumes - BMW 3 (E21) 316 (De 1980.09 Até 1982.12) 66kW 90cv 1766cm3 três volumes - BMW 3 (E21) 318 (De 1975.08 Até 1980.08) 72kW 98cv 1766cm3 três volumes - BMW 3 (E21) 320 (De 1975.06 Até 1979.07) 80kW 109cv 1990cm3 três volumes - BMW 3 (E21) 320 i (De 1975.06 Até 1982.06) 92kW 125cv 1990cm3 três volumes</p> <p>170x110x56mm 1p-d10x16mm 1p-d10x16mm</p>
	<p><b>A2293</b> NO. 11811245620</p> <p><b>APOIO DO MOTOR LADO DIREITO</b></p> <p>BMW 3 (E21): 315 03.1981/03.1984 55KW 75CV 1573CC - BMW 3 (E21): 316 08.1975/08.1980 66KW 90CV 1573CC - BMW 3 (E21): 316 09.1980/12.1982 66KW 90CV 1766CC - BMW 3 (E21): 318 08.1975/08.1980 72KW 98CV 1766CC - BMW 3 (E21): 318 i 11.1979/08.1982 77KW 105CV 1766CC - BMW 3 (E21): 320 06.1975/07.1979 80KW 109CV 1990CC - BMW 3 (E21): 320 i 06.1975/08.1982 92KW 125CV 1990CC</p> <p>79x60x56mm 1p-d10x16mm 1p-d10x16mm</p>		<p><b>D0004</b> NO. 1 106 113 - 26111106113</p> <p><b>CARDAN TRANSMISSÃO D107X38MM 8 FUROS 10MM ENTRE FUROS 78MM</b></p> <p>BMW 3 (E21): 316 08.1975/08.1980 66KW 90CV 1573CC - BMW 3 (E21): 316 09.1980/12.1982 66KW 90CV 1766CC - BMW 3 (E21): 318 08.1975/08.1980 72KW 98CV 1766CC - BMW 3 (E21): 318 i 11.1979/08.1982 77KW 105CV 1766CC - BMW 3 (E21): 320 06.1975/07.1979 80KW 109CV 1990CC - BMW 3 (E21): 320/6 08.1977/10.1982 90KW 122CV 1990CC - BMW 3 (E21): 320 i 06.1975/08.1982 92KW 125CV 1990CC - BMW 3 (E21): 323 i 01.1978...</p> <p>d110x39mm 8f-d9mm</p>
	<p><b>D0026</b> NO. 26111204294 - 26111207785 - 26111225624</p> <p><b>CARDAN TRANSMISSÃO D110X28MM 6 FUROS 10MM ENTRE FUROS 78MM</b></p> <p>BMW 3 (E21) 315 (03.81 A 03.84) 75cv 1573cc três volumes - BMW 3 (E21) 316 Tipo de caixa de velocidades: para caixa de velocidades manual (08.75 A 08.80) 90cv 1573cc três volumes - BMW 3 (E21) 316 Tipo de caixa de velocidades: para caixa de velocidades manual (09.80 A 08.82) 90cv 1766cc três volumes - BMW 3 (E21) 318 Tipo de caixa de velocidades: para caixa de velocidades manual (08.75 A 08...</p> <p>d110x28mm 1f-d40mm 6f-d10mm</p>		<p><b>D0060</b> NO. 32311115090 - 32311115092</p> <p><b>CARDAN COLUNA DIREÇÃO</b></p> <p>BMW 3 (E21) 315 03.1981/03.1984 55KW 75CV 1573CC M10 B16 (164VB) 0005418 - BMW 3 (E21) 316 08.1975/08.1980 66KW 90CV 1573CC M10 B16 (164VA) 0005385 - BMW 3 (E21) 316 09.1980/12.1982 66KW 90CV 1766CC M10 B18 (184VC) 0005416 - BMW 3 (E21) 318 08.1975/08.1980 72KW 98CV 1766CC M10 B18 (184VA) 0005386 - BMW 3 (E21) 318 i 11.1979/08.1982 77KW 105CV 1766CC M10 B18 (184VA) 0005417 - BMW 3 (E21) 320 06.197...</p> <p>65x65x13mm 4f-d8mm</p>
	<p><b>F0469-I</b> NO. 16110170470102 - 16410.17047.01.02 - 16410170470106 - 60507865 - 60805170 - 60811991 - 700610 - 8034...</p> <p><b>FOLE DA TRANSMISSÃO LADO DA CAIXA</b></p> <p>BMW 3 (E21): 315 03.1981/03.1984 55KW 75CV 1573CC - BMW 3 (E21): 316 08.1975/08.1980 66KW 90CV 1573CC - BMW 3 (E21): 316 09.1980/12.1982 66KW 90CV 1766CC - BMW 3 (E21): 318 08.1975/08.1980 72KW 98CV 1766CC - BMW 3 (E21): 318 i 11.1979/08.1982 77KW 105CV 1766CC - BMW 3 (E21): 320 06.1975/07.1979 80KW 109KW 1990CC - BMW 3 (E21): 320/6 08.1977/10.1982 90KW 122CV 1990CC - BMW 3 (E21): 320 i 06.1975/08...</p> <p>d85x80mm 1f-d61mm 1f-d23mm</p>		<p><b>F0548-I</b> NO. 33211105446 - 3321110544603 - 33211205816</p> <p><b>FOLE DO SEMI-EIXO LADO CAIXA</b></p> <p>BMW 316 - 318 - 320 - 320i - 323 (APÓS 75)</p> <p>d85x80mm 1f-d51mm 1f-d23mm</p>
	<p><b>F0549-I</b> NO. 32111116067 - 32111118688 - 32111125131</p> <p><b>FOLE DA DIREÇÃO DO LADO DIREITO (E ESQUERDO NOS MODELOS 315 - 316 - 318 - 320-4)</b></p> <p>BMW 3 (E21) 315 03.1981/03.1984 55KW 75CV 1573CC M10 B16 (164VB) 0005418 - BMW 3 (E21) 316 08.1975/08.1980 66KW 90CV 1573CC M10 B16 (164VA) 0005385 - BMW 3 (E21) 316 09.1980/12.1982 66KW 90CV 1766CC M10 B18 (184VC) 0005416 - BMW 3 (E21) 318 08.1975/08.1980 72KW 98CV 1766CC M10 B18 (184VA) 0005386 - BMW 3 (E21) 318 i 11.1979/08.1982 77KW 105CV 1766CC M10 B18 (184VA) 0005417 - BMW 3 (E21) 320 06.197...</p> <p>d59x162mm 1f-d45 1f-d38mm</p>		<p><b>F0550-I</b> NO. 32111116068 - 32111117426 - 32111117698</p> <p><b>FOLE DA DIREÇÃO ESQUERDO</b></p> <p>BMW 3 (E21) 315 03.1981/03.1984 55KW 75CV 1573CC M10 B16 (164VB) 0005418 - BMW 3 (E21) 316 08.1975/08.1980 66KW 90CV 1573CC M10 B16 (164VA) 0005385 - BMW 3 (E21) 316 09.1980/12.1982 66KW 90CV 1766CC M10 B18 (184VC) 0005416 - BMW 3 (E21) 318 08.1975/08.1980 72KW 98CV 1766CC M10 B18 (184VA) 0005386 - BMW 3 (E21) 318 i 11.1979/08.1982 77KW 105CV 1766CC M10 B18 (184VA) 0005417 - BMW 3 (E21) 320 06.197...</p> <p>d65x134mm 2f-d53mm</p>
	<p><b>KF0549-I</b> NO. 32111116067 - 32111118688 - 32111125131</p> <p><b>KIT FOLE DIREÇÃO</b></p> <p>BMW 3 (E21) 315 (03.81 A 03.84) 75cv 1573cc três volumes - BMW 3 (E21) 316 (08.75 A 08.80) 90cv 1573cc três volumes - BMW 3 (E21) 316 (09.80 A 08.82) 90cv 1766cc três volumes - BMW 3 (E21) 318 (08.75 A 08.80) 98cv 1766cc três volumes - BMW 3 (E21) 320 (08.75 A 08.77) 109cv 1990cc três volumes - BMW 3 (E30) 315 (09.82 A 12.91) 75cv 1573cc três volumes</p> <p>d59x162mm 1f-d38mm 1f-d45mm</p>		<p><b>KUR21999</b> NO. 1f-d24mm 1f-d10mm 1f-d10mm 1f-d19m</p> <p><b>KIT DE REPARAÇÃO ALAVANCA DE VELOCIDADES</b></p> <p>BMW 3 (E21) 315 (De 03.1981 Até 03.1984) 55kW 75cv 1573cm3 três volumes - BMW 3 (E21) 316 (De 08.1975 Até 08.1980) 66kW 90cv 1573cm3 três volumes - BMW 3 (E21) 316 (De 09.1980 Até 12.1982) 66kW 90cv 1766cm3 três volumes - BMW 3 (E21) 318 (De 08.1975 Até 08.1980) 72kW 98cv 1766cm3 três volumes - BMW 3 (E21) 318 i (De 11.1979 Até 08.1982) 77kW 105cv 1766cm3 três volumes - BMW 3 (E21) 320 (De 06.1975...</p> <p>d37x18mm d19x25mm d17x22mm d31x21mm d36x21mm d41x24mm d44x24mm d47x24mm</p>
	<p><b>M6017</b> NO. 18111175311 - 18111245489 - 18111245840 - 18111245960 - 18114690146</p> <p><b>JUNTA DE ESCAPE</b></p> <p>BMW SERIE 3 (E21)</p> <p>d56.5x10mm 1f-d44mm</p>		<p><b>M6028</b> NO. 18111175311</p> <p><b>JUNTA DE ESCAPE</b></p> <p>BMW 3 (E21) 315 03.1981/03.1984 55KW 75CV 1573CC M10 B16 (164VB) 0005418 - BMW 3 (E21) 316 08.1975/08.1980 66KW 90CV 1573CC M10 B16 (164VA) 0005385 - BMW 3 (E21) 316 09.1980/12.1982 66KW 90CV 1766CC M10 B18 (184VC) 0005416 - BMW 3 (E21) 318 08.1975/08.1980 72KW 98CV 1766CC M10 B18 (184VA) 0005386 - BMW 3 (E21) 318 i 11.1979/08.1982 77KW 105CV 1766CC M10 B18 (184VA) 0005417 - BMW 3 (E21) 320 06.197...</p> <p>d57x10mm 1f-d47mm</p>

	<p><b>M6032</b> NO. 18111245500 - 18111728363 - 18114690142 - 18114790110</p> <p><b>JUNTA DE ESCAPE</b></p> <p>BMW E21 316 (1975 A 1982) - 318 (1975 A 1982) - 318i (1978 A 1982) - 320i (1975 A 1986) - 323i (1982 A 1986)</p> <p>110x80mm 2f-d40mm</p>		<p><b>M6083</b> NO. 18111101192 - 18111245429 - 18111723843</p> <p><b>JUNTA DE ESCAPE</b></p> <p>BMW E21 320i (1977 A 1991) - 323i (1978 A 1987)</p> <p>87x78mm 1f-d39mm</p>
	<p><b>N0500</b> NO. 18211105635 - 18211105638 - 18211105677 - 18211177708 - 18211728332 - 18214490159 - 1824490159</p> <p><b>ANEL DE SUPORTE DE ESCAPE</b></p> <p>BMW SERIE 3 (E21)</p> <p>65x18mm</p>		<p><b>N1617</b> NO.</p> <p><b>ANEL DE ESCAPE</b></p> <p>BMW E21 315 - 316 - 318 - 320</p> <p>d65x13mm 1f-d40mm</p>
	<p><b>N2331</b> NO. 182111101878 - 18211245113</p> <p><b>ANEL ESCAPE</b></p> <p>BMW E21 315 (1980 A 1994) - 316 - 318i - 320i - 323i</p> <p>d58x14mm 1f-d31mm</p>		<p><b>N3727</b> NO. 3100099 - 90301-34207-000</p> <p><b>ANEL DE ESCAPE</b></p> <p>BMW E21 316 - 320</p> <p>d55x12mm 1f-d31mm</p>
	<p><b>P1005</b> NO. 4504.12</p> <p><b>CAPA PEDAL TRAVAO</b></p> <p>BMW 3 (E21) 315 03.1981/03.1984 55KW 75CV 1573CC M10 B16 (164VB) 0005418 - BMW 3 (E21) 316 08.1975/08.1980 66KW 90CV 1573CC M10 B16 (164VA) 0005385 - BMW 3 (E21) 316 09.1980/12.1982 66KW 90CV 1766CC M10 B18 (184VC) 0005416 - BMW 3 (E21) 318 08.1975/08.1980 72KW 98CV 1766CC M10 B18 (184VA) 0005386 - BMW 3 (E21) 318 i 11.1979/08.1982 77KW 105CV 1766CC M10 B18 (184VA) 0005417 - BMW 3 (E21) 320 i 06.1990/06.1994 80KW 109CV 1990CC M10 B20 0005387</p> <p>85x57x12mm</p>		<p><b>P1059</b> NO. 1 108 634 - 35211108634</p> <p><b>CAPA DE PEDAL DO TRAVÃO</b></p> <p>BMW SÉRIE 3 (E21) 315 - 316 - 318 - 318i - 320 - 320i - 320-6 - 323i (08-1975 A 08-1982)</p> <p>75x62x12mm</p>
	<p><b>R220045</b> NO. 11530788175 - 11531266469</p> <p><b>TUBO DO TERMOSTASTO</b></p> <p>BMW 3 (E21) 315 03.1981/03.1984 55KW 75CV 1573CC M10 B16 (164VB) 0005418 - BMW 3 (E21) 316 08.1975/08.1980 66KW 90CV 1573CC M10 B16 (164VA) 0005385 - BMW 3 (E21) 316 11.1979/08.1982 77KW 105CV 1766CC M10 B18 (184VC) 0005416 - BMW 3 (E21) 318 08.1975/08.1980 72KW 98CV 1766CC M10 B18 (184VA) 0005386 - BMW 3 (E21) 320 06.1975/07.1979 80KW 109CV 1990CC M10 B20 0005387</p> <p>B245-d30/30mm 85-190mm</p>		<p><b>R220075</b> NO. 11531266463</p> <p><b>TUBO INFERIOR DO RADIADOR</b></p> <p>BMW 3 (E21) 315 03.1981/03.1984 55KW 75CV 1573CC M10 B16 (164VB) 0005418 - BMW 3 (E21) 316 08.1975/08.1980 66KW 90CV 1573CC M10 B16 (164VA) 0005385 - BMW 3 (E21) 316 09.1980/12.1982 66KW 90CV 1766CC M10 B18 (184VC) 0005416 - BMW 3 (E21) 318 08.1975/08.1980 72KW 98CV 1766CC M10 B18 (184VA) 0005386 - BMW 3 (E21) 318 i 11.1979/08.1982 77KW 105CV 1766CC M10 B18 (184VA) 0005417 - BMW 3 (E21) 320 06.1975/07.1979 80KW 109CV 1990CC M10 B20 0005387</p> <p>B225-d35/35mm 60-95-80-45mm</p>
	<p><b>R220077</b> NO. 11531262751 - 11531266464 - 134396</p> <p><b>TUBO DE RADIADOR SUPERIOR</b></p> <p>BMW 3 (E21) 315 03.1981/03.1984 55KW 75CV 1573CC M10 B16 (164VB) 0005418 - BMW 3 (E21) 316 08.1975/08.1980 66KW 90CV 1573CC M10 B16 (164VA) 0005385 - BMW 3 (E21) 316 09.1980/12.1982 66KW 90CV 1766CC M10 B18 (184VC) 0005416 - BMW 3 (E21) 318 08.1975/08.1980 72KW 98CV 1766CC M10 B18 (184VA) 0005386 - BMW 3 (E21) 318 i 11.1979/08.1982 77KW 105CV 1766CC M10 B18 (184VA) 0005417 - BMW 3 (E21) 320 06.1975/07.1979 80KW 109CV 1990CC M10 B20 0005387</p> <p>B230-D30/30mm 100-65-50-80mm</p>		<p><b>R220135</b> NO. 64211360653</p> <p><b>TUBO DE RETORNO DE ÁGUA DO AQUECIMENTO</b></p> <p>BMW 3 (E21) 315 03.1981/03.1984 55KW 75CV 1573CC M10 B16 (164VB) 0005418 - BMW 3 (E21) 316 08.1975/08.1980 66KW 90CV 1573CC M10 B16 (164VA) 0005385 - BMW 3 (E21) 316 09.1980/12.1982 66KW 90CV 1766CC M10 B18 (184VC) 0005416 - BMW 3 (E21) 318 08.1975/08.1980 72KW 98CV 1766CC M10 B18 (184VA) 0005386 - BMW 3 (E21) 318 i 11.1979/08.1982 77KW 105CV 1766CC M10 B18 (184VA) 0005417 - BMW 3 (E21) 320 06.1975/07.1979 80KW 109CV 1990CC M10 B20 0005387</p> <p>B245-d18/25mm 90-85-75-55mm</p>
	<p><b>R8152</b> NO. 11531260206 - 11531266463</p> <p><b>TUBO SUPERIOR DO RADIADOR</b></p> <p>BMW 3 (E21) 315 03.1981/03.1984 55KW 75CV 1573CC M10 B16 (164VB) 0005418 - BMW 3 (E21) 316 08.1975/08.1980 66KW 90CV 1573CC M10 B16 (164VA) 0005385 - BMW 3 (E21) 318 i 11.1979/08.1982 77KW 105CV 1766CC M10 B18 (184VA) 0005386 - BMW 3 (E21) 320 06.1975/07.1979 80KW 109CV 1990CC M10 B20 0005387</p> <p>B260-33/33mm 155-155mm</p>		<p><b>R8153</b> NO. 11531260206 - 11531266463</p> <p><b>TUBO SUPERIOR DO RADIADOR</b></p> <p>BMW 3 (E21) 315 03.1981/03.1984 55KW 75CV 1573CC M10 B16 (164VB) 0005418 - BMW 3 (E21) 316 08.1975/08.1980 66KW 90CV 1573CC M10 B16 (164VA) 0005385 - BMW 3 (E21) 318 i 11.1979/08.1982 77KW 105CV 1766CC M10 B18 (184VA) 0005417 - BMW 3 (E21) 320 06.1975/07.1979 80KW 109CV 1990CC M10 B20 0005387</p> <p>B190-32/32mm 155-157mm</p>
	<p><b>RT08457</b> NO. 34321154904</p> <p><b>TUBO DE TRAVÃO TRÁS LH-RH</b></p> <p>BMW 3 (E21) 316 (De 08.1975 Até 08.1980) 66KW 90cv 1573cm3 três volumes - BMW 3 (E21) 316 (De 09.1980 Até 12.1982) 66KW 90cv 1766cm3 três volumes - BMW 3 (E21) 318 (De 08.1975 Até 08.1980) 72KW 98cv 1766cm3 três volumes - BMW 3 (E21) 318 i (De 11.1979 Até 08.1982) 77KW 105cv 1766cm3 três volumes - BMW 3 (E21) 320 (De 06.1975 Até 07.1979) 80KW 109cv 1990cm3 três volumes - BMW 3 (E21) 320 i (De 06.1990 Até 06.1994) 80KW 109cv 1990cm3 três volumes</p> <p>ponteira-1 (F) ponteira-2 (M) 100-300mm</p>		<p><b>RT08693</b> NO. 34321108135 - 34321113183 - 34321115695 - 34321159878 - 34321159881 - 34324050542</p> <p><b>TUBO DE TRAVÃO TRÁS RH</b></p> <p>BMW SÉRIE 3 (E21) TT (06-1975 A 12-1983)</p> <p>225mm F - F</p>



	<b>S1910</b>	NO. 31121123037 - 31129056376		<b>U0020</b>	NO. 18214490157 - A18214490157
	<p><b>SILENT-BLOC DO BRAÇO SUSPENSÃO DA FRENTE PARTE EXTERIOR</b></p> <p>BMW 3 (E21) 315 (De 03.1981 Até 03.1984) 55kW 75cv 1573cm3 três volumes - BMW 3 (E21) 316 (De 08.1975 Até 08.1980) 66kW 90cv 1573cm3 três volumes - BMW 3 (E21) 316 (De 09.1980 Até 12.1982) 66kW 90cv 1766cm3 três volumes - BMW 3 (E21) 318 i (De 11.1979 Até 08.1982) 77kW 105cv 1766cm3 três volumes - BMW 3 (E21) 320 (De 06.1975 Até 07.1979) 80kW 109cv 1990cm3 três volumes - BMW 3 (E21) 320 i (De 06.1...</p>			<p><b>TACO DE NYLON PARA ANEIS DE ESCAPE N0500</b></p> <p>BMW SERIE 3(E21)</p>	
d53x58mm		c29mm d42mm 1f-d16mm	34x25x18mm		
	<b>U7033K</b>	NO. 61671379609 - 64500149356 - 64500301636 - 64501363572 - 64501466019 - 64501468463 - 64508390601		<b>UMB84029</b>	NO. 07119937320 - 11111276472 - 11111717939 - 1717939 - 9937321
	<p><b>ORINGS BOMBA DIREÇÃO ASSITIDA</b></p> <p>BMW 3 (E21) 315 (03.1981 - 03.1984) 55kw 75cv 1573cm3 três volumes BMW 3 (E21) 316 (09.1980 - 12.1982) 66kw 90cv 1766cm3 três volumes</p>			<p><b>TAMPÃO BLOCO MOTOR</b></p> <p>BMW 3 (E21) 315 (De 03-1981 Até 03-1984) 55kW 75CV 1573cc três volumes BMW 3 (E21) 316 (De 08-1975 Até 08-1980) 66kW 90CV 1573cc três volumes BMW 3 (E21) 316 (De 09-1980 Até 08-1982) 66kW 90CV 1766cc três volumes BMW 3 (E21) 318 (De 08-1975 Até 08-1980) 72kW 98CV 1766cc três volumes BMW 3 (E21) 318 i (De 11-1979 Até 08-1982) 77kW 105CV 1766cc três volumes BMW 3 (E21) 320 (De 08-1975 Até 08-19...</p>	
d11x2mm d10x2mm		1f-d7mm 1f-d6mm	d36x10mm		di-32mm
	<b>UMB84038</b>	NO. 07119937331 - 11111276473 - 11111714712		<b>UTR0631</b>	NO. 17111100848 - 17111102672 - 17111120062
	<p><b>TAMPÃO BLOCO MOTOR</b></p> <p>BMW 3 (E21) 320/6 (09.77 A 08.82) 122cv 1990cc três volumes - BMW 3 (E21) 323 i (01.78 A 08.82) 143cv 2316cc três volumes - BMW 3 (E30) 320 i (09.82 A 12.91) 125cv 1990cc três volumes - BMW 3 (E30) 320 i (12.85 A 06.91) 129cv 1990cc três volumes - BMW 3 (E30) 323 i (09.82 A 08.83) 139cv 2316cc três volumes - BMW 3 (E30) 323 i (09.83 A 08.86) 150cv 2316cc três volumes - BMW 3 (E30) 325 ...</p>			<p><b>TAMPÃO RADIADOR</b></p> <p>BMW 3 (E21): 315 03.1981/03.1984 55KW 75CV 1573CC - BMW 3 (E21): 316 08.1975/08.1980 66KW 90CV 1573CC - BMW 3 (E21): 316 09.1980/12.1982 66KW 90CV 1766CC - BMW 3 (E21): 318 08.1975/08.1980 72KW 98CV 1766CC - BMW 3 (E21): 318 i 11.1979/08.1982 77KW 105CV 1766CC - BMW 3 (E21): 320 06.1975/07.1979 80KW 109CV 1990CC - BMW 3 (E21): 320/6 08.1977/10.1982 90KW 122CV 1990CC - BMW 3 (E21): 320 i 06.1975/08...</p>	
d-45x12,1mm		di-42mm	d59/79x29mm		d38x26mm
	<b>Y3239</b>	NO. 36130141574 - 36130141576 - 36131095390 - 36131116717 - 36131117190 - 36131126191		<b>Z86003</b>	NO. 51711932996
	<p><b>PARAFUSO PERNO RODA CHAVE 17 M12X1,50X50MM ( BASE CONICA )</b></p> <p>BMW 3 (E21) 315 03.1981/03.1984 55KW 75CV 1573CC M10 B16 (164VB) 0005418 - BMW 3 (E21) 316 08.1975/08.1980 66KW 90CV 1573CC M10 B16 (164VA) 0005385 - BMW 3 (E21) 316 09.1980/12.1982 66KW 90CV 1766CC M10 B18 (184VC) 0005416 - BMW 3 (E21) 318 08.1975/08.1980 72KW 98CV 1766CC M10 B18 (184VA) 0005386 - BMW 3 (E21) 318 i 11.1979/08.1982 77KW 105CV 1766CC M10 B18 (184VA) 0005417 - BMW 3 (E21) 320 06.197...</p>			<p><b>MOLAS FIXACAO MOLDURA PORTAS</b></p> <p>BMW 3 (E30) 315 09.1982/12.1991 55KW 75CV 1573CC M10 B16 (16A) 0005437 - BMW 3 (E30) 316 09.1983/06.1988 66KW 90CV 1766CC M10 B18 (184VD) 0005426 - BMW 3 (E30) 316 (Econronic) 09.1983/06.1988 66KW 90CV 1766CC M10 B18 (184VD) 0005500 - BMW 3 (E30) 316 i 08.1987/08.1988 75KW 102CV 1766CC M10 B18 (184KA) 0005439 - BMW 3 (E30) 316 i 09.1987/06.1991 73KW 100CV 1596CC M40 B16 (164E1) 0005483 - BMW 3 (E3...</p>	
c51mm (ch-17mm)		M12x1x24mm	F-4G- mm		T-12L-8H-7S-1mm

BMW SERIE 3(E30)

	<b>A0948</b>	NO. 26111206502 - 26121104355 - A26111206502		<b>A1284</b>	NO. 33521128819
	<p><b>APOIO SUPORTE CENTRAL DA TRANSMISSÃO COM ROLAMENTO</b></p> <p>BMW 3 (E30) 315 09.1982/12.1991 55KW 75CV 1573CC M10 B16 (16A) 0005437</p>			<p><b>APOIO DO AMORTECEDOR</b></p> <p>BMW E30 316i - 318 - 320 - 324TD - 325i</p>	
155x101x42mm		d30mm	106x73x34mm		1f-d10mm
	<b>A1317</b>	NO. 11811132321 - 11811132323 - 11811175212 - 11811246437		<b>A1947</b>	NO. 0019811225 - 0029812925 - 0039812325 - 0089814325 - 26121103728 - 26121209590 - 26121225071 - 261212...
	<p><b>APOIO SUPORTE DA FRENTE ESQUERDA DO MOTOR</b></p> <p>BMW 3 (E30) 320 i 09.1982/12.1991 92KW 125CV 1990CC M20 B20 (206EB) 0005428 - BMW 3 (E30) 320 i 10.1986/04.1991 95KW 129CV 1990CC M20 B20 (206KA) 0005502 0005452 - BMW 3 (E30) 325 e 2.7 10.1983/12.1988 90KW 122CV 2693CC M20 B27 (276KB) M20 B27 (276KA) 0005438 - BMW 3 (E30) 325 e 2.7 01.1985/08.1987 95KW 129CV 2693CC M20 B27 (276KB) 0005459 - BMW 3 (E30) 325 i 09.1983/11.1989 126KW 171CV 2494CC M20...</p>			<p><b>APOIO DA TRANSMISSÃO</b></p> <p>BMW 3 Touring (E 30) 316 i (09.91 A 06.94) 100cv 1596cc Combi - BMW 3 (E36) 316 i (09.90 A 09.93) 100cv 1596cc três volumes - BMW 3 (E 36) 316 i (09.90 A 09.93) 102cv 1596cc três volumes - BMW 3 (E 36) 316 i (07.93 A 02.98) 102cv 1596cc três volumes - BMW 3 (E 36) 318 i (12.90 A 10.93) 113cv 1796 três volumes - BMW 3 (E 36) 318 i (10.93 A 02.98) 115cv 1796cc três volumes - BMW 3 (E 36)...</p>	
d70x48mm		1p-d10-35mm 1p-d10-22mm	180x100x45mm		1f-d30mm
	<b>A2293</b>	NO. 11811245620		<b>D0022</b>	NO. 26111209168 - 26111227420 - 26111227717 - 26111229080 - 26111229360 - 261117511454
	<p><b>APOIO DO MOTOR LADO DIREITO</b></p> <p>BMW 3 (E30): 315 09.1982/12.1991 55KW 75CV 1573CC</p>			<p><b>CARDAN TRANSMISSÃO D135X30MM 6 FUROS 12MM ENTRE FUROS 96MM</b></p> <p>BMW 3 (E30) 320 i 05.1988/12.1990 141KW 192CV 1990CC S14 B20 (204EA) - BMW 3 (E30) 324 td 09.1987/08.1991 85KW 115CV 2443CC M21 D24 (246TB) 0005469 - BMW 3 (E30) 325 e 2.7 10.1983/12.1988 90KW 122CV 2693CC M20 B27 (276KB) M20 B27 (276KA) 0005438 - BMW 3 (E30) 325 e 2.7 01.1985/08.1987 95KW 129CV 2693CC M20 B27 (276KB) 0005459 - BMW 3 (E30) 325 i X 03.1986/12.1987 126KW 171CV 2494CC M20 B25 (256K1...</p>	
79x60x56mm		1p-d10x16mm 1p-d10x16mm	d132x123x30mm		6f-d12mm







	<p><b>P1059</b> NO. 1 108 634 - 35211108634</p> <p>CAPA DE PEDAL DO TRAVÃO</p> <p>BMW SÉRIE 3 (E30) 315 - 316 - 316i - 316 (ECOTRONIC) - 318i - 318iS - 320i - 320iS - 323i - 324D - 324TD - 325iX - 325(2.7) - M3(2.3) (09-1982 A 081991)</p> <p>75x62x12mm</p>		<p><b>R021812</b> NO. 13311288284</p> <p>TUBO DE LIGAÇÃO DO CARBURADOR AO COLECTOR</p> <p>BMW 3 (E30): 316 (Ecotronic) 09.1983/06.1988 66KW 90CV 1766CC - BMW 3 (E30): 316 09.1983/06.1988 66KW 90CV 1766CC - BMW 3 (E30): 316 i 09.1987/06.1991 73KW 100CV 1596CC - BMW 3 (E30): 316 i 07.1988/06.1991 75KW 102CV 1596CC - BMW 3 (E30): 318 i 12.1984/08.1988 75KW 102CV 1766CC - BMW 3 (E30): 318 i 09.1982/08.1987 77KW 105CV 1766CC - BMW 3 (E30): 318 i 06.1987/12.1991 83KW 113CV 1796CC - BMW 3 (E3...)</p> <p>B245-d7/7mm 235-65mm</p>
	<p><b>R021925</b> NO. 13311288284</p> <p>TUBO DE LIGAÇÃO DO CARBURADOR AO COLECTOR</p> <p>BMW 3 (E30): 316 (Ecotronic) 09.1983/06.1988 66KW 90CV 1766CC - BMW 3 (E30): 316 09.1983/06.1988 66KW 90CV 1766CC - BMW 3 (E30): 316 i 09.1987/06.1991 73KW 100CV 1596CC - BMW 3 (E30): 316 i 07.1988/06.1991 75KW 102CV 1596CC - BMW 3 (E30): 318 i 12.1984/08.1988 75KW 102CV 1766CC - BMW 3 (E30): 318 i 09.1982/08.1987 77KW 105CV 1766CC - BMW 3 (E30): 318 i 06.1987/12.1991 83KW 113CV 1796CC - BMW 3 (E3...)</p> <p>B230-7/7mm 205x55mm</p>		<p><b>R220045</b> NO. 11530788175 - 11531266469</p> <p>TUBO DO TERMOSTASTO</p> <p>BMW 3 (E30) 315 09.1982/12.1991 55KW 75CV 1573CC M10 B16 (16A) 0005437</p> <p>B245-d30/30mm 85-190mm</p>
	<p><b>R220075</b> NO. 11531266463</p> <p>TUBO INFERIOR DO RADIADOR</p> <p>BMW 3 (E30) 315 09.1982/12.1991 55KW 75CV 1573CC M10 B16 (16A) 0005437</p> <p>B225-d35/35mm 60-95-80-45mm</p>		<p><b>R220077</b> NO. 11531262751 - 11531266464 - 134396</p> <p>TUBO DE RADIADOR SUPERIOR</p> <p>BMW 3 (E30) 315 09.1982/12.1991 55KW 75CV 1573CC M10 B16 (16A) 0005437</p> <p>B230-D30/30mm 100-65-50-80mm</p>
	<p><b>R220208</b> NO. 11531278908</p> <p>TUBO DE RADIADOR INFERIOR</p> <p>BMW 3 (E30) 316 09.1983/06.1988 66KW 90CV 1766CC M10 B18 (184VD) 0005426 - BMW 3 (E30) 316 (Ecotronic) 09.1983/06.1988 66KW 90CV 1766CC M10 B18 (184VD) 0005500 - BMW 3 (E30) 318 i 09.1982/08.1987 77KW 105CV 1766CC M10 B18 (184EZ) M10 B18 (184EB) M10 B18 (184EA) 0005427</p> <p>B245-d36/32mm 60-150-40-55mm</p>		<p><b>R220209</b> NO. 11531276449 - 11531278909</p> <p>TUBO SUPERIOR DO RADIADOR</p> <p>BMW 3 (E30): 316 (Ecotronic) 09.1983/06.1988 66KW 90CV 1766CC - BMW 3 (E30): 316 09.1983/06.1988 66KW 90CV 1766CC - BMW 3 (E30): 316 i 08.1987/08.1988 75KW 102CV 1766CC - BMW 3 (E30): 318 i 12.1984/08.1988 75KW 102CV 1766CC - BMW 3 (E30): 318 i 09.1982/08.1987 77KW 105CV 1766CC</p> <p>B285-d30/36mm 90-55-100-110mm</p>
	<p><b>R220858</b> NO. 11531715219</p> <p>TUBO SUPERIOR DO RADIADOR</p> <p>BMW 3 (E30) 316 i 09.1987/06.1991 73KW 100CV 1596CC M40 B16 (164E1) 0005483 - BMW 3 (E30) 316 i 07.1988/06.1991 75KW 102CV 1596CC M40 B16 (164E1) 0005511 0005482 - BMW 3 (E30) 318 i 12.1984/08.1988 75KW 102CV 1766CC M10 B18 (184KA) 0005439 0005501 - BMW 3 (E30) 318 i 06.1987/12.1991 83KW 113CV 1796CC M40 B18 (184E1) 0005471 - BMW 3 (E30) 318 i 09.1987/06.1991 85KW 115CV 1796CC M40 B18 (184E1) 0005...</p> <p>B305-35/37mm 43x50x76x140mm</p>		<p><b>R220859</b> NO. 11531709051</p> <p>TUBO INFERIOR RADIADOR</p> <p>BMW 3 (E30) 316 i 09.1987/06.1991 73KW 100CV 1596CC M40 B16 (164E1) 0005483 - BMW 3 (E30) 316 i 07.1988/06.1991 75KW 102CV 1596CC M40 B16 (164E1) 0005511 0005482 - BMW 3 (E30) 318 i 12.1984/08.1988 75KW 102CV 1766CC M10 B18 (184KA) 0005439 0005501 - BMW 3 (E30) 318 i 06.1987/12.1991 83KW 113CV 1796CC M40 B18 (184E1) 0005471 - BMW 3 (E30) 318 i 09.1987/06.1991 85KW 115CV 1796CC M40 B18 (184E1) 0005...</p> <p>B275-33/37mm 87-62-116-73mm</p>
	<p><b>R220862</b> NO. 11531287651 - 11531287654</p> <p>TUBO LIGAÇÃO BOMBA DE ÁGUA</p> <p>BMW 3 (E30): 320 i 09.1982/12.1991 92KW 125CV 1990CC - BMW 3 (E30): 320 i 10.1986/04.1991 95KW 129CV 1990CC - BMW 3 (E30): 325 i 12.1986/06.1991 125KW 170CV 2494CC - BMW 3 (E30): 325 i X 09.1986/08.1991 125KW 170CV 2494CC - BMW 3 (E30): 325 i 09.1983/11.1989 126KW 171CV 2494CC - BMW 3 (E30): 325 i X 03.1986/12.1987 126KW 171CV 2494CC - BMW 3 (E30): 325 e 2.7 10.1983/12.1988 90KW 122CV 2693CC - BMW...</p> <p>B200-33/35mm 60-170-160-100mm</p>		<p><b>R221208</b> NO. 11531715154</p> <p>TUBO ADMISSÃO FILTRO DE AR</p> <p>BMW 3 (E30) 316 i 09.1987/06.1991 73KW 100CV 1596CC M40 B16 (164E1) 0005483 - BMW 3 (E30) 316 i 07.1988/06.1991 75KW 102CV 1596CC M40 B16 (164E1) 0005511 0005482 - BMW 3 (E30) 318 i 12.1984/08.1988 75KW 102CV 1766CC M10 B18 (184KA) 0005439 0005501 - BMW 3 (E30) 318 i 06.1987/12.1991 83KW 113CV 1796CC M40 B18 (184E1) 0005471 - BMW 3 (E30) 318 i 09.1987/06.1991 85KW 115CV 1796CC M40 B18 (184E1) 0005...</p> <p>B94-10/13mm 50-45mm</p>
	<p><b>R225332</b> NO. 13717597586 - 7597586</p> <p>TUBO DE ADMISSÃO FILTRO DE AR</p> <p>BMW 3 (E30) 316 i 08.1987/08.1988 75KW 102CV 1766CC M10 B18 (184KA) 0005439 - BMW 3 (E30) 316 i 09.1987/06.1991 73KW 100CV 1596CC M40 B16 (164E1) 0005483 - BMW 3 (E30) 316 i 07.1988/06.1991 75KW 102CV 1596CC M40 B16 (164E1) 0005511 0005482 - BMW 3 (E30) 320 i 09.1982/12.1991 92KW 125CV 1990CC M20 B20 (206EB) 0005428 - BMW 3 (E30) 320 i 10.1986/04.1991 95KW 129CV 1990CC M20 B20 (206KA) 0005502 0005...</p> <p>B220-46/69mm 143-105mm</p>		<p><b>R8183</b> NO. 13711709755</p> <p>TUBO DO FILTRO DE AR</p> <p>BMW 3 (E30) 316 i 09.1987/06.1991 73KW 100CV 1596CC M40 B16 (164E1) 0005483 - BMW 3 (E30) 316 i 07.1988/06.1991 75KW 102CV 1596CC M40 B16 (164E1) 0005511 0005482 - BMW 3 (E30) 318 i 316 i 09.1991/06.1994 73KW 100CV 1596CC M40 B16 (164E1) 0005512 - BMW 3 (E30) 316 i 09.1991/06.1994 75KW 102CV 1596CC M40 B16 (164E1) 0005513</p> <p>B250-53/61mm 174x71mm</p>
	<p><b>RT08457</b> NO. 34321154904</p> <p>TUBO DE TRAVÃO TRÁS LH-RH</p> <p>BMW 3 (E30) 315 (De 09.1982 Até 12.1991) 55KW 75CV 1573cm3 três volumes - BMW 3 (E30) 316 (De 09.1983 Até 06.1988) 66KW 90CV 1766cm3 três volumes - BMW 3 (E30) 316 (Ecotronic) (De 09.1983 Até 06.1988) 66KW 90CV 1766cm3 três volumes - BMW 3 (E30) 316 i (De 09.1987 Até 06.1991) 73KW 100CV 1596cm3 três volumes - BMW 3 (E30) 316 i (De 07.1988 Até 06.1991) 75KW 102CV 1596cm3 três volumes - BMW 3 (E30)...</p> <p>ponteira-1 (F) ponteira-2 (M) 300mm</p>		<p><b>RT08693</b> NO. 34321108135 - 34321113183 - 34321115695 - 34321159878 - 34321159881 - 34324050542</p> <p>TUBO DE TRAVÃO TRÁS LH-RH</p> <p>BMW SÉRIE 3 (E30) TT (03-1982 A 12-1991)</p> <p>225mm F - F</p>

	<p><b>T0621-I</b> NO. 31331124449 - 31331124573 - 31331125215</p> <p><b>BATENTE SUSPENSÃO FRENTE</b></p> <p>BMW 3 (E30) 315 (09.82 A 12.91) 75cv 1573cc três volumes - BMW 3 (E30) 316 (Ecotronic) (09.83 A 12.90) 90cv 1766cc três volumes - BMW 3 (E30) 316 (09.82 A 12.87) 90cv 1766cc três volumes - BMW 3 (E30) 316 i (09.87 A 06.91) 100cv 1596cc três volumes - BMW 3 (E30) 316 i (07.88 A 06.91) 102cv 1596cc três volumes - BMW 3 (E30) 316 i (08.87 A 08.88) 102cv 1766cc três volumes - BMW 3 (E30) 318 i (...)</p> <p>d59x85mm 1f-d26mm 1f-d18mm</p>		<p><b>T0621-I</b> NO. 31331124449 - 31331125215</p> <p><b>BATENTE SUSPENSÃO FRENTE</b></p> <p>BMW 3 (E30) 315 (09.82 A 12.91) 75cv 1573cc três volumes - BMW 3 (E30) 316 (Ecotronic) (09.83 A 12.90) 90cv 1766cc três volumes - BMW 3 (E30) 316 (09.82 A 12.87) 90cv 1766cc três volumes - BMW 3 (E30) 316 i (09.87 A 06.91) 100cv 1596cc três volumes - BMW 3 (E30) 316 i (07.88 A 06.91) 102cv 1596cc três volumes - BMW 3 (E30) 318 i (08.87 A 08.88) 102cv 1766cc três volumes - BMW 3 (E30) 318 i (...)</p> <p>d59x85mm 1f-d26mm 1f-d18mm</p>
	<p><b>T0621-I</b> NO. 31331124449 - 31331125215</p> <p><b>BATENTE SUSPENSÃO FRENTE</b></p> <p>BMW 3 (E30) 316 (Ecotronic) (09.83 A 12.90) 90cv 1766 três volumes - BMW 3 (E30) 316 (09.82 A 12.87) 90cv 1766cc três volumes - BMW 3 (E30) 316 i (09.87 A 06.91) 100cv 1596cc três volumes - BMW 3 (E30) 316 i (07.88 A 06.91) 102cv 1596cc três volumes - BMW 3 (E30) 316 i (08.87 A 08.88) 102cv 1766cc três volumes - BMW 3 (E30) 318 i (12.84 A 08.88) 102cv 1766cc três volumes - BMW 3 (E30) 318 i (0...)</p> <p>d59x85mm 1f-d26mm 1f-d18mm</p>		<p><b>U7033K</b> NO. 61671378609 - 64500149356 - 64500301636 - 64501363572 - 64501466019 - 64501468463 - 64508390601</p> <p><b>ORINGS BOMBA DIREÇÃO ASSISTIDA</b></p> <p>BMW 3 (E30) 316 (09.1983 - 06.1988) 66kw 90cv 1766cm3 três volumes BMW 3 (E30) 316 (Ecotronic) (09.1983 - 06.1988) 66kw 90cv 1766cm3 três volumes BMW 3 (E30) 316 i (07.1988 - 06.1991) 75kw 102cv 1596cm3 três volumes BMW 3 (E30) 316 i (08.1987 - 08.1988) 75kw 102cv 1766cm3 três volumes BMW 3 (E30) 318 i (12.1984 - 08.1988) 75kw 102cv 1766cm3 três volumes BMW 3 (E30) 318 i (09.1982 - 08.1987) 77kw ...</p> <p>d11x2mm d10x2mm 1f-d7mm 1f-d6mm</p>
	<p><b>U7033K</b> NO. 61671378609 - 64500149356 - 64500301636 - 64501363572 - 64501466019 - 64501468463 - 64508390601</p> <p><b>ORINGS BOMBA DIREÇÃO ASSISTIDA</b></p> <p>BMW 3 Cabriolet (E30) 316 i Baur TC (09.1987 - 12.1989) 73kw 99cv 1596cm3 Cabriolet BMW 3 Cabriolet (E30) 318 Baur TC (09.1983 - 06.1988) 66kw 90cv 1766cm3 Cabriolet BMW 3 Cabriolet (E30) 318 i (09.1990 - 10.1993) 83kw 113cv 1796cm3 Cabriolet BMW 3 Cabriolet (E30) 318 i Baur TC (09.1982 - 06.1990) 77kw 105cv 1766cm3 Cabriolet BMW 3 Cabriolet (E30) 320 i (07.1987 - 10.1993) 93kw 126cv 1990cm3 Cabr...</p> <p>d11x2mm d10x2mm 1f-d7mm 1f-d6mm</p>		<p><b>U7033K</b> NO. 61671378609 - 64500149356 - 64500301636 - 64501363572 - 64501466019 - 64501468463 - 64508390601</p> <p><b>ORINGS BOMBA DIREÇÃO ASSISTIDA</b></p> <p>BMW 3 Touring (E30) 316 i (09.1991 - 06.1994) 73kw 100cv 1596cm3 Combi BMW 3 Touring (E30) 316 i (09.1991 - 06.1994) 75kw 102cv 1596cm3 Combi BMW 3 Touring (E30) 318 i (04.1989 - 06.1994) 83kw 113cv 1796cm3 Combi BMW 3 Touring (E30) 318 i (09.1987 - 06.1991) 85kw 115cv 1796cm3 Combi BMW 3 Touring (E30) 320 i (01.1988 - 12.1991) 95kw 129cv 1991cm3 Combi BMW 3 Touring (E30) 324 td (01.1988 - 06.1991...</p> <p>d11x2mm d10x2mm 1f-d7mm 1f-d6mm</p>
	<p><b>UCRZ1093</b> NO. 26111105398 - 26117518304 - 26203401609 - 26207526677</p> <p><b>CRUZETA DO VEIO TRANSMISSÃO LONGITUDINAL</b></p> <p>BMW 3 (E30) 316 (Ecotronic) (De 09.1983 Até 2006.1988) 66kW 90cv 1766cm3 três volumes - BMW 3 (E30) 316 i (De 09.1987 Até 2006.1991) 73kW 100cv 1596cm3 três volumes - BMW 3 (E30) 316 i (De 07.1988 Até 2006.1991) 75kW 102cv 1596cm3 três volumes - BMW 3 (E30) 316 i (De 08.1987 Até 2008.1988) 75kW 102cv 1766cm3 três volumes - BMW 3 (E30) 318 i (De 12.1984 Até 2008.1988) 75kW 102cv 1766cm3 três volume...</p> <p>d24x63mm 43mm</p>		<p><b>UMB84029</b> NO. 07119937320 - 11111276472 - 11111717939 - 1717939 - 9937321</p> <p><b>TAMPÃO BLOCO MOTOR</b></p> <p>BMW 3 (E30) 316 (Ecotronic) (De 09-1983 Até 12-1990) 66kW 90CV 1766cc três volumes BMW 3 (E30) 316 (De 09-1982 Até 12-1987) 66kW 90CV 1766cc três volumes BMW 3 (E30) 316 i (De 09-1987 Até 06-1991) 73kW 100CV 1596cc três volumes BMW 3 (E30) 316 i (De 07-1988 Até 06-1991) 75kW 102CV 1596cc três volumes BMW 3 (E30) 316 i (De 08-1987 Até 08-1988) 75kW 102CV 1766cc três volumes BMW 3 (E30) 318 i (...)</p> <p>d36x10mm di-32mm</p>
	<p><b>UMV26826</b> NO. 25111221290 - 25111222280 - 25111434494 - 25111434495</p> <p><b>MANETE PUNHO TOPO ALAVANCA MUDANÇAS 5 VELOCIDADES F12MM C/LUZ</b></p> <p>BMW 3 (E30) 316 09.1983/06.1988 66KW 90CV 1766CC M10 B18 (184VD) 0005426 - BMW 3 (E30) 316 i 08.1987/08.1988 75KW 102CV 1766CC M10 B18 (184KA) 0005439 - BMW 3 (E30) 316 i 09.1987/06.1991 73KW 100CV 1596CC M40 B16 (164E1) 0005483 - BMW 3 (E30) 316 i 07.1988/06.1991 75KW 102CV 1596CC M40 B16 (164E1) 0005511 0005482 - BMW 3 (E30) 318 i 06.1987/12.1991 83KW 113CV 1796CC M40 B18 (184E1) 0005471 - BMW 3...</p> <p>54x45x91mm DIAMETRO INTERIOR 12MM</p>		<p><b>UMV26826</b> NO. 25111221290 - 25111434494 - 25111434495</p> <p><b>MANETE PUNHO TOPO ALAVANCA MUDANÇAS 5 VELOCIDADES F12MM C/LUZ</b></p> <p>BMW 3 Cabriolet (E30) 318 i 09.1990/10.1993 83KW 113CV 1796CC M40 B18 (184E1) 0005496 - BMW 3 Cabriolet (E30) 320 i 05.1986/11.1993 95KW 129CV 1990CC M20 B20 (206KA) 0005453 - BMW 3 Cabriolet (E30) 320 i 07.1987/10.1993 93KW 126CV 1990CC M20 B20 (206KA) - BMW 3 Cabriolet (E30) 325 i 12.1985/12.1987 126KW 171CV 2494CC M20 B25 (256E2) M20 B25 (256E1) 0005454 - BMW 3 Cabriolet (E30) 325 i 08.1987/11....</p> <p>54x45x91mm DIAMETRO INTERIOR 12MM</p>
	<p><b>UMV26826</b> NO. 25111221290 - 25111222280 - 25111434494 - 25111434495</p> <p><b>MANETE PUNHO TOPO ALAVANCA MUDANÇAS 5 VELOCIDADES F12MM C/LUZ</b></p> <p>BMW 3 Touring (E30) 316 i (De 09.1991 Até 06.1994) 73kW 100cv 1596cm3 Combi - BMW 3 Touring (E30) 316 i (De 09.1991 Até 06.1994) 75kW 102cv 1596cm3 Combi - BMW 3 Touring (E30) 318 i (De 04.1989 Até 06.1994) 83kW 113cv 1796cm3 Combi - BMW 3 Touring (E30) 318 i (De 09.1987 Até 06.1991) 85kW 115cv 1796cm3 Combi - BMW 3 Touring (E30) 320 i (De 01.1988 Até 12.1991) 95kW 129cv 1991cm3 Combi - BMW 3 Tour...</p> <p>54x45x91mm DIAMETRO INTERIOR 12MM</p>		<p><b>UTR0631</b> NO. 17111100848 - 17111102672 - 17111120062</p> <p><b>TAMPÃO RADIADOR</b></p> <p>BMW 3 (E30): 315 09.1982/12.1991 55KW 75CV 1573CC - BMW 3 (E30): 316 i 09.1987/06.1991 73KW 100CV 1596CC - BMW 3 (E30): 316 i 07.1988/06.1991 75KW 102CV 1596CC - BMW 3 (E30): 316 i 08.1987/08.1988 75KW 102CV 1766CC - BMW 3 (E30): 318 i 12.1984/08.1988 75KW 102CV 1766CC - BMW 3 (E30): 318 i 09.1982/08.1987 77KW 105CV 1766CC - BMW 3 (E30): 318 i 06.1987/12.1991 83KW 113CV 1796CC - BMW 3 (E30): 318 i...</p> <p>d59/79x29mm d38x26mm</p>
	<p><b>UTR0812</b> NO. 17110152374 - 17111468076 - 17111712492 - 17111712669 - 17111742231 - 17117639022 - 17119071581</p> <p><b>TAMPÃO RESERVATÓRIO LIQUIDO REFRIGERAÇÃO</b></p> <p>BMW 3 (E30) 315 (09.82 A 12.91) 75cv 1573cc três volumes - BMW 3 (E30) 316 (Ecotronic) (09.83 A 12.90) 90cv 1766cc três volumes - BMW 3 (E30) 316 (09.82 A 12.87) 90cv 1766cc três volumes - BMW 3 (E30) 320 i (12.85 A 06.91) 129cv 1991cc três volumes - BMW 3 (E30) 325 i (12.86 A 06.91) 170cv 2494cc três volumes - BMW 3 (E30) 325 i X (12.86 A 08.91) 170cv 2494cc três volumes - BMW 3 (E30)...</p> <p>d65x45mm 1f-d52x20mm</p>		<p><b>UTR0813</b> NO. 17111468077 - 17111712188 - 17111712232 - 17111719167 - 17111742232 - 17112242256 - 17114379048</p> <p><b>TAMPÃO RESERVATÓRIO LIQUIDO REFRIGERAÇÃO</b></p> <p>BMW 3 (E30) 316 i (09.87 A 06.91) 100cv 1596cc três volumes - BMW 3 (E30) 316 i (09.87 A 06.91) 102cv 1596cc três volumes - BMW 3 (E30) 318 i (09.87 A 06.91) 113cv 1796cc três volumes - BMW 3 (E30) 318 i (09.87 A 06.91) 115cv 1796cc três volumes - BMW 3 (E30) 318 is (09.89 A 08.91) 136cv 1796cc três volumes - BMW 3 (E30) 320 i (09.82 A 12.85) 125cv 1990cc três volumes - BMW 3 (E30) 320...</p> <p>d66x45mm 1f-d52x20mm</p>
	<p><b>Y3239</b> NO. 36130141574 - 36130141576 - 36131095390 - 36131116717 - 36131117190 - 36131126191</p> <p><b>PARAFUSO PERNO RODA CHAVE 17 M12X1,50X50MM ( BASE CONICA )</b></p> <p>BMW 3 (E30) 316 09.1983/06.1988 66KW 90CV 1766CC M10 B18 (184VD) 0005426 - BMW 3 (E30) 316 (Ecotronic) 09.1983/06.1988 66KW 90CV 1766CC M10 B18 (184VD) 0005500 - BMW 3 (E30) 316 i 08.1987/08.1988 75KW 102CV 1766CC M10 B18 (184KA) 0005439 - BMW 3 (E30) 316 i 09.1987/06.1991 73KW 100CV 1596CC M40 B16 (164E1) 0005483 - BMW 3 (E30) 316 i 07.1988/06.1991 75KW 102CV 1596CC M40 B16 (164E1) 0005511 0005482...</p> <p>c51mm (ch-17mm) M12x1x24mm</p>		<p><b>Y3239</b> NO. 36130141574 - 36130141576 - 36131095390 - 36131116717 - 36131117190 - 36131126191</p> <p><b>PARAFUSO PERNO RODA CHAVE 17 M12X1,50X50MM ( BASE CONICA )</b></p> <p>BMW 3 Cabriolet (E30) 318 i 09.1990/10.1993 83KW 113CV 1796CC M40 B18 (184E1) 0005496 - BMW 3 Cabriolet (E30) 320 i 05.1986/11.1993 95KW 129CV 1990VV M20 B20 (206KA) 0005453 - BMW 3 Cabriolet (E30) 325 i 12.1985/12.1987 126KW 171CV 2494CC M20 B25 (256E2) M20 B25 (256E1) 0005454 - BMW 3 Cabriolet (E30) 325 i 08.1987/11.1993 125KW 170CV 2494CC M20 B25 (256K1) M20 B25 (256E2) M20 B25 (256EX) 0005462 ...</p> <p>c51mm (ch-17mm) M12x1x24mm</p>













	<b>Y3239</b>	NO. 36130141574 - 36130141576 - 36131095390 - 36131116717 - 36131117190 - 36131126191		<b>Z80802</b>	NO. 51231885969 - 51231889018 - 51411802258 - 51411807439 - 51411844033 - 51411852599 - 51411868613
	PARAFUSO PERNO RODA CHAVE 17 M12X1,50X50MM ( BASE CONICA ) BMW 3 Touring (E30) 316 i 09.1991/06.1994 73KW 100CV 1596CC M40 B16 (164E1) 0005512 - BMW 3 Touring (E30) 318 i 09.1987/06.1991 85KW 115CV 1796CC M40 B18 (184E1) 0005485 - BMW 3 Touring (E30) 318 i 04.1989/06.1994 83KW 113CV 1796CC M40 B18 (184E1) 0005486 - BMW 3 Touring (E30) 320 i 01.1988/12.1991 95KW 129CV 1991CC M20 B20 (206KA) 0005477 - BMW 3 Touring (E30) 324 td 01.1988/06.1993 85KW 115CV 24...			Mola de painel BMW SÉRIE 3(E30)	
c51mm (ch-17mm)		M12x1x24mm	d18x17.8mm		1p-d8-11.4mm

## BMW SERIE 3(E36)

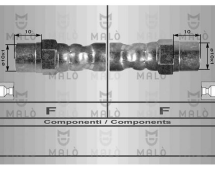
	<b>A1296</b>	NO. 18211723101		<b>A1520</b>	NO. 11811137238 - 11811137775 - 11811141377
	APOIO DE ESCAPE BMW E36 316i (1991 A 03-1993) - 316i KAT (APOS 1991) - 318i (APOS 11-1990) - 318i KAT (APOS 1991)			APOIO MOTOR LADO DIREITO E ESQUERDO BMW SERIE 3 (E36-Z3) (1991 A 1998) 1.8 - 1.9 (M43) - 316G - 316I - 316I (M40) - 316I (M43) - 316I 1.6 - 316I 1.9 - 318I (M40) - 318I (M43) - 318IS (M42) - 318IS (M44) - 318TDS (SO LADO ESQUERDO) - 318TI (M42) - 318TI (M44)	
			d104x68mm		1p-d10/29mm 1p-d10/18mm
	<b>A1521</b>	NO. 11811092583 - 11811136542 - 11811140985 - 11812228298 - 11812283798 - 11817837985 - 22111095444 -		<b>A1746</b>	NO. 22311094916 - 22316771221 - 23711131664
	APOIO MOTOR LADO DIREITO E ESQUERDO BMW SERIE 3 (E36-Z3) (1991 A 1998) 320I (M50) - 325I - 325IT			APOIO DA CAIXA DE VELOCIDADES PARTE DE TRÁS BMW 3 (E36) 325 td 09.1991/02.1998 85KW 115CV 2497CC M51 D25 (256T1) 0005517 0005578 - BMW 3 (E36) 325 tds 05.1993/02.1998 105KW 143CV 2497CC M51 D25 (256T1) 0005536 0005579 - BMW 3 Touring (E36) 325 tds 03.1995/04.1999 105KW 143CV 2497CC M51 D25 (256T1) 0005561	
d104x71mm		1p-d10/28mm 1p-d9/20mm	d50x34mm		2p-d8-17/19mm
	<b>A1886</b>	NO. 26121229317 - 26121229682		<b>A1959</b>	NO. 1138427 - 24701138427
	APOIO DA TRANSMISSÃO BMW 3 Compact (E36) 318tds Hatchback (01-1995 A 08-2000) 90CV 1665CC - BMW 3 (E46) 316i (06-2002 A 02-2005) 115CV 1596CC - BMW 3 (E46) 316i (02-2002 A 02-2005) 115CV 1796CC - BMW 3 (E46) 318i (09-2001 A 02-2005) 143CV 1995CC - BMW 3 (E46) 325xi (09-2000 A			APOIO ESQUERDO CAIXA VELOCIDADES BMW 3 (E36) 320 i (09.90 A 02.98) 150cv 1991cc três volumes - BMW 3 (E36) 325 i (09.90 A 09.95) 192cv 2494cc três volumes - BMW 3 Coupé (E36) 325 i (03.92 A 04.99) 192cv 2494cc Coupé	
160x100x50mm		1f-d30mm	48x45x42mm		2p-d8x16mm
	<b>A1960</b>	NO. 1138428 - 24701138428		<b>D0022</b>	NO. 26111209168 - 26111227420 - 26111227717 - 26111229080 - 26111229360 - 26117511454
	APOIO DIREITO CAIXA VELOCIDADES BMW 3 (E36) 320 i (09.90 A 02.98) 150cv 1991cc três volumes - BMW 3 (E36) 325 i (09.90 A 09.95) 192cv 2494cc três volumes - BMW 3 Coupé (E36) 325 i (03.92 A 04.99) 192cv 2494cc Coupé			CARDAN TRANSMISSÃO D135X30MM 6 FUROS 12MM ENTRE FUROS 96MM BMW 3 (E36) 323 i 05.1995/11.1998 125KW 170CV 2494CC M52 B25 (256S3) 0005560 - BMW 3 (E36) 325 i 09.1990/12.1995 141KW 192CV 2494CC M50 B25 (256S1) M50 B25 (256S2) 0005506 - BMW 3 (E36) 325 td 09.1991/02.1998 85KW 115CV 2497CC M51 D25 (256T1) 0005517 0005578 - BMW 3 (E36) 325 tds 05.1993/02.1998 105KW 143CV 2497CC M51 D25 (256T1) 0005536 0005579 - BMW 3 (E36) 328 i 01.1995/04.1998 142KW 193CV 2793...	
48x45x42mm		2p-d8x16mm	d132x123x30mm		6f-d12mm
	<b>D0049</b>	NO. 1227410 - 1227869 - 1229516 - 26111227410 - 26111227869 - 26111229516 - 26611227410 - 26611227869		<b>E0083</b>	NO. 33551135307 - 33551131131 - 33551135307 - 33551135 - 1131131 - 1135307
	CARDAN TRANSMISSÃO BMW 3 (E36) 316 i 03.1991/08.1993 73KW 100CV 1596CC M40 B16 (164E1) 0005508 - BMW 3 (E36) 316 i 09.1993/05.1998 75KW 102CV 1596CC M43 B16 (164E2) 0005507 0005537 0005573 - BMW 3 (E36) 318 i 09.1990/08.1993 83KW 113CV 1796CC M40 B18 (184E1) 0005504 - BMW 3 (E36) 318 i 02.1992/12.1995 103KW 140CV 1796CC M42 B18 (184S1) - BMW 3 (E36) 318 i 09.1993/11.1998 85KW 115CV 1796CC M43 B18 (184E2) 0005503 000...			ESTICADOR BARRA ESTABILIZADORA TRAS ( GASTA 2 UNIDADES ) BMW 3 (E36) 318 tds 01.1995/02.1998 66KW 90CV 1665CC M41 D17 (174T1) 0005547 - BMW 3 (E36) M3 3.2 10.1995/01.1998 236KW 321CV 3201CC S50 B32 (326S1) 7909308 - BMW 3 Cabriolet (E36) 323 i 05.1995/11.1999 125KW 170CV 2494CC M52 B25 (256S3) 0005563 - BMW 3 Cabriolet (E36) M3 3.2 03.1996/09.1999 236KW 321CV 3201CC S50 B32 (326S1) 7909307 - BMW 3 Compact (E36) 316 g 02.1996/08.2000 75KW 102CV 1596CC ...	
111x107x32mm		6f-d12mm	93x34x26mm		2f-d8mm
	<b>E0123</b>	NO. 31351091764 - 31351127689 - 31351128737		<b>E1019</b>	NO. 18211723646 - 18301703634
	ESTICADOR DA BARRA ESTABILIZADORA DA FRENTE BMW SERIE 3 (E36)			ESTICADOR DE ESCAPE BMW E36 - 320i - 325i - 325i KAT	
105x42x29mm		1p-d10x22mm 1f-d8mm	72x50x14mm		

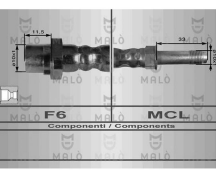
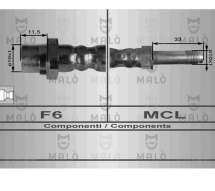









	<p><b>KUR21999</b> NO. 1f-d24mm 1f-d10mm 1f-d10mm 1f-d19mm</p> <p><b>KIT DE REPARAÇÃO ALAVANCA DE VELOCIDADES</b></p> <p>BMW 3 Compact (E36) 316 g (De 02.1996 Até 08.2000) 75kW 102cv 1596cm3 Hatchback - BMW 3 Compact (E36) 316 i (De 01.1994 Até 08.2000) 75kW 102cv 1596cm3 Hatchback - BMW 3 Compact (E36) 316 i (De 01.1999 Até 08.2000) 77kW 105cv 1895cm3 Hatchback - BMW 3 Compact (E36) 318 tds (De 06.1995 Até 08.2000) 66kW 90cv 1665cm3 Hatchback - BMW 3 Compact (E36) 318 ti (De 09.1994 Até 12.1995) 103kW 140cv 1796cm...</p> <p>d37x18mm d19x25mm d17x22x4mm d31x210mm d31x26x120mm d24x19x4</p>		<p><b>KUR21999</b> NO. 1f-d24mm 1f-d10mm 1f-d10mm 1f-d19mm</p> <p><b>KIT DE REPARAÇÃO ALAVANCA DE VELOCIDADES</b></p> <p>BMW 3 Touring (E36) 316 i (De 03.1997 Até 05.1999) 75kW 102cv 1596cm3 Combi - BMW 3 Touring (E36) 318 i (De 09.1995 Até 04.1999) 85kW 116cv 1796cm3 Combi - BMW 3 Touring (E36) 318 tds (De 03.1995 Até 04.1999) 66kW 90cv 1665cm3 Combi - BMW 3 Touring (E36) 320 i (De 01.1995 Até 04.1999) 110kW 150cv 1990cm3 Combi - BMW 3 Touring (E36) 323 i (De 12.1995 Até 04.1999) 125kW 170cv 2494cm3 Combi - BMW 3 T...</p> <p>.d37x18mm d19x25mm d17x22x4mm d31x210mm d31x26x120mm d24x19x4</p>
	<p><b>M6026</b> NO. 18111176651 - 18111719446</p> <p><b>JUNTA DE ESCAPE</b></p> <p>BMW E36 325i (1990 A 1995) - 328i (APÓS 1994)</p> <p>d54,6x10mm 1f-d46mm</p>		<p><b>N0500</b> NO. 1821105635 - 1821105638 - 1821105677 - 1821177708 - 18211728332 - 18214490159 - 1824490159</p> <p><b>ANEL DE SUPORTE DE ESCAPE</b></p> <p>BMW SERIE 3 (E36)</p> <p>65x18mm</p>
	<p><b>P1042</b> NO. 35211160422</p> <p><b>CAPA DE PEDAL</b></p> <p>BMW SERIE 3 (E36): 316 i 03.1991/08.1993 73KW 100CV 1596CC - BMW SERIE 3 (E36): 316 i 09.1993/05.1998 75KW 102CV 1596CC - BMW SERIE 3 (E36): 318 i 09.1990/08.1993 83KW 113CV 1796CC - BMW SERIE 3 (E36): 318 i 09.1993/11.1998 85KW 115CV 1796CV - BMW SERIE 3 (E36): 318 is 09.1993/12.1995 103KW 140CV 1796CC - BMW SERIE 3 (E36): 318 is 01.1996/05.1998 103KW 140CV 1895CC - BMW SERIE 3 (E36): 320 i 01.1...</p> <p>75x65x40mm</p>		<p><b>P1055</b> NO. 35211160421</p> <p><b>CAPA DE PEDAL DO TRAVÃO (VEÍCULOS COM CAIXA AUTOMÁTICA)</b></p> <p>BMW SERIE 3 (E36) 316 i Gasolina 73kW 100hp M40 B16 (164E1) 09.1990/09.1993 Salão - BMW SERIE 3 (E36) 316 i Gasolina 75kW 102hp M43 B16 (164E2) 09.1990/09.1993 Salão - BMW SERIE 3 (E36) 316 i Gasolina 75kW 102hp M43 B16 (164E2) 07.1993/02.1998 Salão - BMW SERIE 3 (E36) 318 i Gasolina 83kW 113hp M40 B18 (184E1) 12.1990/10.1993 Salão - BMW SERIE 3 (E36) 318 i Gasolina 85kW 115hp M43 B18 (184E2) 10.1...</p> <p>74x107x42mm</p>
	<p><b>P1059</b> NO. 1 108 634 - 35211108634</p> <p><b>CAPA DE PEDAL DO TRAVÃO</b></p> <p>BMW SÉRIE 3 (E36) 316i - 318i - 318iS - 318TDS - 320i - 323i (2.5) - 325i - 325TD - 325TDS - 328i - M3 (3.0) - M3 (3.2) (09-1990 A 02-1998)</p> <p>75x62x12mm</p>		<p><b>RT08693</b> NO. 34321108135 - 34321113183 - 34321115695 - 34321159878 - 34321159881 - 34324050542</p> <p><b>TUBO DE TRAVÃO TRÁS LH-RH</b></p> <p>BMW SÉRIE 3 (E36) TT (09-1990 A 12-1998)</p> <p>225mm F - F</p>
	<p><b>RT08907</b> NO. 34321159717</p> <p><b>TUBO DE TRAVÃO FRETE LH-RH</b></p> <p>BMW SÉRIE 3 (E 36) TT (09-1990 A 12-1998)</p> <p>ponteira-1Fponteira-2M Compr-453mm</p>		<p><b>RT08908</b> NO. 34321159524</p> <p><b>TUBO DE TRAVÃO TRÁS LH-RH</b></p> <p>BMW SÉRIE 3 (E 36) TT (09-1990 A 12-1998)</p> <p>ponteira-1Fponteira-2F Compr-223mm</p>
	<p><b>RT08909</b> NO. 34301165074 - 34301165174</p> <p><b>TUBO DE TRAVÃO TRÁS LH-RH</b></p> <p>BMW SÉRIE 3 E36 316.318 TDS TT C- ABS-ASC (09-1990 A 12-1998)</p> <p>504mm F6 - MCL</p>		<p><b>RT08909</b> NO. 34301165074 - 34301165174</p> <p><b>TUBO DE TRAVÃO TRÁS LH-RH</b></p> <p>BMW SÉRIE 3 E46 TT S-ABS</p> <p>504mm F6 - MCL</p>
	<p><b>S1270</b> NO.</p> <p><b>SILENT-BLOC DA MANGA DE EIXO DE TRÁS</b></p> <p>BMW E36</p>		<p><b>S1271</b> NO. 31106770689 - 31106770690 - 31121092019 - 31121094235 - 31121122462 - 31121124622 - 31121133236 - 31121133237</p> <p><b>SILENT-BLOC DO BRAÇO DA SUSPENSÃO (FRENTE CENTRO)</b></p> <p>BMW 3 (E36): 316 i 03.1991/08.1993 73KW 100CV 1596CC - BMW 3 (E36): 316 i 09.1993/05.1998 75KW 102CV 1596CC - BMW 3 (E36): 318 i 09.1990/08.1993 83KW 113CV 1796CC - BMW 3 (E36): 318 i 09.1993/11.1998 85CV 115CV 1796CC - BMW 3 (E36): 318 is 09.1993/12.1995 103KW 140CV 1796CC - BMW 3 (E36): 318 is 01.1996/05.1998 103KW 140CV 1895CC - BMW 3 (E36): 320 i 01.1991/02.1998 110KW 150CV 1990CC - BMW 3 (E36)...</p> <p>d46x52mm c40mm 1f-d12mm</p>
	<p><b>S1273</b> NO. 33321123462 - 33321125563 - 33321137459 - 33329058823 - 33329061946</p> <p><b>SILENT-BLOC DAS PONTAS DO BRAÇO DA SUSPENSÃO TRÁS</b></p> <p>BMW 5 (E34) 518 i 09.1989/04.1994 83KW 113CV 1796CC M40 B18 (184E1) 0005491 - BMW 5 (E34) 518 i 05.1994/08.1995 85KW 115CV 1796CC M43 B18 (184E2) 0005490 - BMW 5 (E34) 520 i 06.1987/09.1990 95KW 129CV 1990CC M20 B20 (206KA) 0005472 - BMW 5 (E34) 520 i 24V 04.1990/08.1995 110KW 150CV 1990CC M50 B20 (206S2) M50 B20 (206S1) 0005492 - BMW 5 (E34) 524 td 03.1988/08.1991 85KW 115CV 2443CC M21 D24 (246TB)...</p> <p>d44x67mm c52mm 1f-d12mm</p>		<p><b>S1301</b> NO. 33319059300</p> <p><b>SILENT-BLOC DA SUSPENSÃO TRÁS(DIAMETRO 60.5)</b></p> <p>BMW 3 (E36) 316 i 03.1991/08.1993 73KW 100CV 1596CC M40 B16 (164E1) 0005508 - BMW 3 (E36) 316 i 09.1993/05.1998 75KW 102CV 1596CC M43 B16 (164E2) 0005507 0005573 - BMW 3 (E36) 318 i 09.1990/08.1993 83KW 113CV 1796CC M40 B18 (184E1) 0005504 - BMW 3 (E36) 318 i 09.1993/11.1998 85KW 115CV 1796CC M43 B18 (184E2) 0005503 0005574 - BMW 3 (E36) 318 is 09.1993/12.1995 103KW 140CV 1796CC M42 B18 (1...</p> <p>d71x77mm d60mm 1f-d12mm</p>

	<p><b>S1302</b> NO. 1136311 - 33321136311 - 33326471828 - 33326771828 - 6771828 - 33332136311</p> <p><b>SILENT-BLOC EXTERNO DO BRAÇO OSCILANTE SUSPENSÃO TRÁS</b></p> <p>BMW 3 (E36) 316 i 03.1991/08.1993 73KW 100CV 1596CC M40 B16 (164E1) 0005508 - BMW 3 (E36) 316 i 09.1993/05.1998 75KW 102CV 1596CC M43 B16 (164E2) 0005507 0005537 0005573 - BMW 3 (E36) 318 i 09.1990/08.1993 83KW 113CV 1796CC M40 B18 (184E1) 0005504 - BMW 3 (E36) 318 i 02.1992/12.1995 103KW 140CV 1796CC M42 B18 (184S1) - BMW 3 (E36) 318 i 09.1993/11.1998 85KW 115CV 1796CC M43 B18 (184E2) 0005503 000...</p> <p>d45x57mm c32.5mm 1f-d12mm</p>		<p><b>S1303</b> NO. 33321110115 - 33321117259 - 33321123774 - 33321137564 - 33329058221 - 33329061945</p> <p><b>SILENT-BLOC DO BRAÇO OSCILANTE SUSPENSÃO TRÁS</b></p> <p>BMW 3 Compact (E36) 316 g 02.1996/08.2000 75KW 102CV 1596CC M43 B16 (164E2) 0005541 0005621 - BMW 3 Compact (E36) 316 i 01.1994/08.2000 75KW 102CV 1596CC M43 B16 (164E2) 0005541 0005565 - BMW 3 Compact (E36) 316 i 01.1999/08.2000 77KW 105CV 1895CC M43 B19 (194E1) 0005650 - BMW 3 Compact (E36) 318 tds 06.1995/08.2000 66KW 90CV 1665CC M41 D17 (174T1) 0005548 - BMW 3 Compact (E36) 318 ti 09.1994/12.1...</p> <p>d35x70mm 1f-d12mm</p>
	<p><b>S1328</b> NO. 31129064875</p> <p><b>SILENT-BLOC DO BRAÇO INFERIOR SUSPENSÃO FRENTE</b></p> <p>BMW 3 (E36) 316 i 03.1991/08.1993 73KW 100CV 1596CC M40 B16 (164E1) 0005508 - BMW 3 (E36) 316 i 09.1993/05.1998 75KW 102CV 1596CC M43 B16 (164E2) 0005507 0005537 0005573 - BMW 3 (E36) 318 i 09.1990/08.1993 83KW 113CV 1796CC M40 B18 (184E1) 0005504 - BMW 3 (E36) 318 i 02.1992/12.1995 103KW 140CV 1796CC M42 B18 (184E2) 0005503 0005574 - BMW 3 (E36) 318 is 09.1993/12.1995 103KW 140CV 1796CC M42 B18 (1...</p> <p>d60x33mm 1f-d18mm</p>		<p><b>S1329</b> NO. 31121135079 - 31121135351 - 31129059288 - 1135079 - 1135351 - 9059288</p> <p><b>SILENT-BLOC DO BRAÇO INFERIOR SUSPENSÃO FRENTE</b></p> <p>S1329 S1329 BMW 3 (E36) 316 i 03.1991/08.1993 73KW 100CV 1596CC M40 B16 (164E1) 0005508 - BMW 3 (E36) 316 i 09.1993/05.1998 75KW 102CV 1596CC M43 B16 (164E2) 0005507 0005537 0005573 - BMW 3 (E36) 318 i 02.1992/12.1995 103KW 140CV 1796CC M42 B18 (184S1) - BMW 3 (E36) 318 i 09.1993/11.1998 85KW 115CV 1796CC M43 B18 (184E2) 0005503 0005574 - BMW 3 (E36) 318 i 09.1990/08.1993 83KW ...</p> <p>d61x34mm c33mm 1f-d18mm</p>
	<p><b>S1532</b> NO. 33311090945 - 33311090946 - 33331090945 - 1090945 - 1090946</p> <p><b>SILENT BLOC DO BRAÇO DA SUSPENSÃO DE TRÁS</b></p> <p>BMW 3 (E36) 316 i 03.1991/08.1993 73KW 100CV 1596CC M40 B16 (164E1) 0005508 - BMW 3 (E36) 316 i 09.1993/05.1998 75KW 102CV 1596CC M43 B16 (164E2) 0005507 0005537 0005573 - BMW 3 (E36) 318 i 09.1990/08.1993 83KW 113CV 1796CC M40 B18 (184E1) 0005504 - BMW 3 (E36) 318 i 02.1992/12.1995 103KW 140CV 1796CC M42 B18 (184S1) - BMW 3 (E36) 318 i 09.1993/11.1998 85KW 115CV 1796CC M43 B18 (184E2) 0005503 000...</p> <p>d76,5x84mm c70mm d58,5mm 1f-d14,3mm</p>		<p><b>S1635</b> NO. 33306852895 - 33321138722 - 33321140345 - 33326775551 - 1138722 - 1140345 - 6775551 - 6852895</p> <p><b>SILENT-BLOC DO BRAÇO SUSPENSÃO DA FRENTE</b></p> <p>BMW 3 (E36) 316 i 03.1991/08.1993 73KW 100CV 1596CC M40 B16 (164E1) 0005508 - BMW 3 (E36) 316 i 09.1993/05.1998 75KW 102CV 1596CC M43 B16 (164E2) 0005507 0005537 0005573 - BMW 3 (E36) 318 i 09.1990/08.1993 83KW 113CV 1796CC M40 B18 (184E1) 0005504 - BMW 3 (E36) 318 i 09.1993/11.1998 85KW 115CV 1796CC M43 B18 (184E2) 0005503 0005574 - BMW 3 (E36) 318 is 09.1993/12.1995 103KW 140CV 1796CC M42 B18 (1...</p> <p>d45x57mm c47mm 1f-d12mm</p>
	<p><b>S1959</b> NO. 33321092247 - 33321137571</p> <p><b>SILENT-BLOC BRAÇO SUSPENSÃO TRÁS SUPERIOR PARTE INTERIOR</b></p> <p>BMW 3 (E36) 316 i (De 03.1991 Até 08.1993) 73kW 100cv 1596cm3 três volumes - BMW 3 (E36) 316 i (De 09.1993 Até 05.1998) 75kW 102cv 1596cm3 três volumes - BMW 3 (E36) 318 i (De 09.1990 Até 08.1993) 83kW 113cv 1796cm3 três volumes - BMW 3 (E36) 318 i (De 09.1993 Até 11.1998) 85kW 115cv 1796cm3 três volumes - BMW 3 (E36) 318 i (De 02.1992 Até 12.1995) 103kW 140cv 1796cm3 três volumes - BMW 3 (E36) 31...</p> <p>d35x66mm c42mm 1f-d12mm</p>		<p><b>S1959</b> NO. 33321092247 - 33321137571</p> <p><b>SILENT-BLOC BRAÇO SUSPENSÃO TRÁS SUPERIOR PARTE INTERIOR</b></p> <p>BMW 3 Cabriolet (E36) 318 i (De 03.1994 Até 11.1999) 85kW 115cv 1796cm3 Cabriolet - BMW 3 Cabriolet (E36) 318 i (De 01.1994 Até 12.1995) 103kW 140cv 1796cm3 Cabriolet - BMW 3 Cabriolet (E36) 320 i (De 12.1993 Até 11.1999) 110kW 150cv 1990cm3 Cabriolet - BMW 3 Cabriolet (E36) 323 i (De 05.1995 Até 11.1999) 125kW 170cv 2494cm3 Cabriolet - BMW 3 Cabriolet (E36) 325 i (De 03.1993 Até 08.1995) 141kW 19...</p> <p>d35x66mm c42mm 1f-d12mm</p>
	<p><b>S1959</b> NO. 33321092247 - 33321137571</p> <p><b>SILENT-BLOC BRAÇO SUSPENSÃO TRÁS SUPERIOR PARTE INTERIOR</b></p> <p>BMW 3 Compact (E36) 316 g (De 02.1996 Até 08.2000) 75kW 102cv 1596cm3 Hatchback - BMW 3 Compact (E36) 316 i (De 01.1994 Até 08.2000) 75kW 102cv 1596cm3 Hatchback - BMW 3 Compact (E36) 316 i (De 01.1999 Até 08.2000) 77kW 105cv 1895cm3 Hatchback - BMW 3 Compact (E36) 318 tds (De 06.1995 Até 08.2000) 66kW 90cv 1665cm3 Hatchback - BMW 3 Compact (E36) 318 ti (De 09.1994 Até 12.1995) 103kW 140cv 1796cm3...</p> <p>d35x66mm c42mm 1f-d12mm</p>		<p><b>S1959</b> NO. 33321092247 - 33321137571</p> <p><b>SILENT-BLOC BRAÇO SUSPENSÃO TRÁS SUPERIOR PARTE INTERIOR</b></p> <p>BMW 3 Coupé (E36) 316 i (De 09.1993 Até 11.1998) 75kW 102cv 1596cm3 Coupé - BMW 3 Coupé (E36) 318 is (De 09.1995 Até 04.1999) 103kW 140cv 1895cm3 Coupé - BMW 3 Coupé (E36) 318 is (De 01.1992 Até 12.1995) 103kW 140cv 1796cm3 Coupé - BMW 3 Coupé (E36) 320 i (De 12.1991 Até 11.1998) 110kW 150cv 1990cm3 Coupé - BMW 3 Coupé (E36) 323 i (De 05.1995 Até 04.1999) 125kW 170cv 2494cm3 Coupé - BMW 3 Coupé (E36) 325 i (De 03.1993 Até 08.1995) 141kW 19...</p> <p>d35x66mm c42mm 1f-d12mm</p>
	<p><b>S1959</b> NO. 33321092247 - 33321137571</p> <p><b>SILENT-BLOC BRAÇO SUSPENSÃO TRÁS SUPERIOR PARTE INTERIOR</b></p> <p>BMW 3 Touring (E36) 316 i (De 03.1997 Até 05.1999) 75kW 102cv 1596cm3 Combi - BMW 3 Touring (E36) 318 i (De 09.1995 Até 04.1999) 85kW 116cv 1796cm3 Combi - BMW 3 Touring (E36) 318 td (De 03.1995 Até 04.1999) 66kW 90cv 1665cm3 Combi - BMW 3 Touring (E36) 320 i (De 01.1995 Até 04.1999) 110kW 150cv 1990cm3 Combi - BMW 3 Touring (E36) 323 i (De 12.1995 Até 04.1999) 125kW 170cv 2494cm3 Combi - BMW 3 To...</p> <p>d35x66mm c42mm 1f-d12mm</p>		<p><b>T0621-I</b> NO. 31331124449 - 31331125215</p> <p><b>BATENTE SUSPENSÃO FRENTE</b></p> <p>BMW 3 (E36) 316 i (09.90 A 09.93) 100cv 1596cc três volumes - BMW 3 (E36) 316 i (07.93 A 02.98) 102cv 1596cc três volumes - BMW 3 (E36) 318 i (12.90 A 10.93) 113cv 1796cc três volumes - BMW 3 (E36) 318 i (10.93 A 02.98) 115cv 1796cc três volumes - BMW 3 (E36) 318 is (03.93 A 02.98) 140cv 1796cc três volumes - BMW 3 (E36) 318 is (09.95 A 02.98) 140cv 1895cc três volumes - BMW 3 (E36) 320 i (0...</p> <p>d59x85mm 1f-d26mm 1f-d18mm</p>
	<p><b>T0626-I</b> NO. 33531138109</p> <p><b>BATENTE SUSPENSÃO FRENTE</b></p> <p>BMW 3 (E36) 316 i (09.90 A 09.93) 100cv 1596cc três volumes - BMW 3 (E36) 316 i (07.93 A 02.98) 102cv 1596cc três volumes - BMW 3 (E36) 318 i (12.90 A 10.93) 113cv 1796cc três volumes - BMW 3 (E36) 318 i (10.93 A 02.98) 115cv 1796cc três volumes - BMW 3 (E36) 318 is (03.93 A 02.98) 140cv 1796cc três volumes - BMW 3 (E36) 318 is (09.95 A 02.98) 140cv 1895cc três volumes - BMW 3 (E36) 320 i (0...</p> <p>d56x110mm 1f-d16mm 1f-d10mm</p>		<p><b>U7004</b> NO. 13641286708 - 13641730767</p> <p><b>ORING DE VÁLVULA INJETORA (Di 7,52 - De 14,58 - E 3,53)</b></p> <p>BMW 3 (E36) 316 i (03.1991 - 08.1993) 73kw 100cv 1596cm3 três volumes BMW 3 (E36) 316 i (09.1993 - 05.1998) 75kw 102cv 1596cm3 três volumes BMW 3 (E36) 318 i (09.1990 - 08.1993) 83kw 113cv 1796cm3 três volumes BMW 3 (E36) 318 i (09.1993 - 11.1998) 85kw 115cv 1796cm3 três volumes BMW 3 (E36) 318 is (09.1993 - 12.1995) 103kw 140cv 1796cm3 três volumes BMW 3 (E36) 318 is (01.1996 - 05.1998) 103kw 140...</p> <p>d14x3mm 1f-d8mm</p>
	<p><b>U7004</b> NO. 13641286708 - 13641730767</p> <p><b>ORING DE VÁLVULA INJETORA (Di 7,52 - De 14,58 - E 3,53)</b></p> <p>BMW 3 Cabriolet (E36) 320 i (12.1993 - 11.1999) 110kw 150cv 1990cm3 Cabriolet BMW 3 Cabriolet (E36) 323 i (05.1995 - 11.1999) 125kw 170cv 2494cm3 Cabriolet BMW 3 Cabriolet (E36) 325 i (03.1993 - 08.1995) 141kw 192cv 2494cm3 Cabriolet BMW 3 Cabriolet (E36) 328 i (01.1995 - 11.1999) 142kw 193cv 2793cm3 Cabriolet BMW 3 Cabriolet (E36) M3 3.0 (04.1994 - 07.1995) 210kw 286cv 2990cm3 Cabriolet BMW 3 Cab...</p> <p>d14x3mm 1f-d8mm</p>		<p><b>U7033K</b> NO. 61671378609 - 64500149356 - 64500301636 - 64501363572 - 64501466019 - 64501468463 - 64508390601</p> <p><b>ORINGS BOMBA DIREÇÃO ASSISTIDA</b></p> <p>BMW 3 (E36) 316 i (03.1991 - 08.1993) 73kw 100cv 1596cm3 três volumes BMW 3 (E36) 316 i (09.1993 - 05.1998) 75kw 102cv 1596cm3 três volumes BMW 3 (E36) 318 i (09.1990 - 08.1993) 83kw 113cv 1796cm3 três volumes BMW 3 (E36) 318 i (09.1993 - 11.1998) 85kw 115cv 1796cm3 três volumes BMW 3 (E36) 318 is (09.1993 - 12.1995) 103kw 140cv 1796cm3 três volumes BMW 3 (E36) 318 is (09.1993 - 12.1995) 103kw 140...</p> <p>d11x2mm d10x2mm 1f-d7mm 1f-d6mm</p>







	<p><b>U7033K</b> NO. 61671378609 - 64500149356 - 64500301636 - 64501363572 - 64501466019 - 64501468463 - 64508390601</p> <p><b>ORINGS BOMBA DIREÇÃO ASSITIDA</b></p> <p>BMW 3 Cabriolet (E36) 318 i (03.1994 - 11.1999) 85kw 115cv 1796cm3 Cabriolet BMW 3 Cabriolet (E36) 318 i (01.1994 - 12.1995) 103kw 140cv 1796cm3 Cabriolet BMW 3 Cabriolet (E36) 320 i (12.1993 - 11.1999) 110kw 150cv 1990cm3 Cabriolet BMW 3 Cabriolet (E36) 323 i (05.1995 - 11.1999) 125kw 170cv 2494cm3 Cabriolet BMW 3 Cabriolet (E36) 325 i (03.1993 - 08.1995) 141kw 192cv 2494cm3 Cabriolet BMW 3 Cabr...</p> <p>d11x2mm d10x2mm 1f-d7mm 1f-d6mm</p>		<p><b>U7033K</b> NO. 61671378609 - 64500149356 - 64500301636 - 64501363572 - 64501466019 - 64501468463 - 64508390601</p> <p><b>ORINGS BOMBA DIREÇÃO ASSITIDA</b></p> <p>BMW 3 Cabriolet (E36) 318 i (03.1994 - 11.1999) 85kw 115cv 1796cm3 Cabriolet BMW 3 Cabriolet (E36) 318 i (01.1994 - 12.1995) 103kw 140cv 1796cm3 Cabriolet BMW 3 Cabriolet (E36) 320 i (12.1993 - 11.1999) 110kw 150cv 1990cm3 Cabriolet BMW 3 Cabriolet (E36) 323 i (05.1995 - 11.1999) 125kw 170cv 2494cm3 Cabriolet BMW 3 Cabriolet (E36) 325 i (03.1993 - 08.1995) 141kw 192cv 2494cm3 Cabriolet BMW 3 Cabr...</p> <p>d11x2mm d10x2mm 1f-d7mm 1f-d6mm</p>
	<p><b>U7033K</b> NO. 61671378609 - 64500149356 - 64500301636 - 64501363572 - 64501466019 - 64501468463 - 64508390601</p> <p><b>ORINGS BOMBA DIREÇÃO ASSITIDA</b></p> <p>BMW 3 Compact (E36) 316 g (02.1996 - 08.2000) 75kw 102cv 1596cm3 Hatchback BMW 3 Compact (E36) 316 i (01.1994 - 08.2000) 75kw 102cv 1596cm3 Hatchback BMW 3 Compact (E36) 316 i (01.1999 - 08.2000) 77kw 105cv 1895cm3 Hatchback BMW 3 Compact (E36) 318 tds (06.1995 - 08.2000) 66kw 90cv 1665cm3 Hatchback BMW 3 Compact (E36) 318 ti (09.1994 - 12.1995) 103kw 140cv 1796cm3 Hatchback BMW 3 Compact (E36) 3...</p> <p>d11x2mm d10x2mm 1f-d7mm 1f-d6mm</p>		<p><b>U7033K</b> NO. 61671378609 - 64500149356 - 64500301636 - 64501363572 - 64501466019 - 64501468463 - 64508390601</p> <p><b>ORINGS BOMBA DIREÇÃO ASSITIDA</b></p> <p>BMW 3 Coupé (E36) 318 is (09.1995 - 04.1999) 103kw 140cv 1895cm3 Coupé BMW 3 Coupé (E36) 320 i (12.1991 - 11.1998) 110kw 150cv 1990cm3 Coupé BMW 3 Coupé (E36) 323 i (05.1995 - 04.1999) 125kw 170cv 2494cm3 Coupé BMW 3 Coupé (E36) 325 i (10.1991 - 02.1995) 141kw 192cv 2494cm3 Coupé BMW 3 Coupé (E36) 325 is (10.1991 - 08.1995) 141kw 192cv 2494cm3 Coupé BMW 3 Coupé (E36) 328 i (01.1995 - 04.1999) 142...</p> <p>d11x2mm d10x2mm 1f-d7mm 1f-d6mm</p>
	<p><b>U7033K</b> NO. 61671378609 - 64500149356 - 64500301636 - 64501363572 - 64501466019 - 64501468463 - 64508390601</p> <p><b>ORINGS BOMBA DIREÇÃO ASSITIDA</b></p> <p>BMW 3 Touring (E36) 316 i (03.1997 - 05.1999) 75kw 102cv 1596cm3 Combi BMW 3 Touring (E36) 318 i (09.1995 - 04.1999) 85kw 116cv 1796cm3 Combi BMW 3 Touring (E36) 318 tds (03.1995 - 04.1999) 66kw 90cv 1665cm3 Combi BMW 3 Touring (E36) 320 i (01.1995 - 04.1999) 110kw 150cv 1990cm3 Combi BMW 3 Touring (E36) 323 i (12.1995 - 04.1999) 125kw 170cv 2494cm3 Combi BMW 3 Touring (E36) 325 tds (03.1995 - 04...</p> <p>d11x2mm d10x2mm 1f-d7mm 1f-d6mm</p>		<p><b>UCRZ1054</b> NO. 32311092958 - 32311150489</p> <p><b>CRUZETA VEIO DIREÇÃO D15X40MM</b></p> <p>BMW 3 (E21) 315FA1:F49 (De 03.1981 Até 03.1984) 55kw 75cv 1573cm3 três volumes - BMW 3 (E21) 316 (De 09.1980 Até 12.1982) 66kw 90cv 1766cm3 três volumes - BMW 3 (E36) 316 i (De 09.1993 Até 05.1998) 75kw 102cv 1596cm3 três volumes - BMW 3 (E36) 318 i (De 09.1993 Até 11.1998) 85kw 115cv 1796cm3 três volumes - BMW 3 (E36) 318 i (De 02.1992 Até 12.1995) 103kw 140cv 1796cm3 três volumes - BMW 3 (E36) 3...</p> <p>d15x28x40mm</p>
	<p><b>UFQ23302</b> NO. 21511223302</p> <p><b>FORQUILHA DA EMBRAIAGEM</b></p> <p>BMW 3 (E36) 318 tds 01.1995/02.1998 66KW 90CV 1665CC M41 D17 (174T1) 0005547 - BMW 3 (E36) 320 i 01.1991/02.1998 110KW 150CV 1990CC M52 B20 (206S3) M50 B20 (206S2) M50 B20 (206S1) 0005505 0005550 - BMW 3 (E36) 323 i 05.1995/11.1998 125KW 170CV 2494CC M52 B25 (256S3) 0005560 - BMW 3 (E36) 325 i 09.1990/12.1995 141KW 192CV 2494CC M50 B25 (256S1) M50 B25 (256S2) 0005506 - BMW 3 (E36) 328 i 01.1995/04...</p> <p>252x83x28mm 1f-47x75mm</p>		<p><b>UFQ23302</b> NO. 21511223302</p> <p><b>FORQUILHA DA EMBRAIAGEM</b></p> <p>BMW 3 Cabriolet (E36) 320 i 12.1993/11.1999 110KW 150CV 1990CC M52 B20 (206S3) M50 B20 (206S2) 0005530 0005552 - BMW 3 Cabriolet (E36) 323 i 05.1995/11.1999 125KW 170CV 2494CC M52 B25 (256S3) 0005563 - BMW 3 Cabriolet (E36) 325 i 03.1993/08.1995 141KW 192CV 2494CC M50 B25 (256S2) 0005531 - BMW 3 Cabriolet (E36) 328 i 01.1995/11.1999 142KW 193CV 2793CC M52 B28 (286S1) 0005559 - BMW 3 Cabriolet (E36)...</p> <p>252x83x28mm 1f-47x75mm</p>
	<p><b>UFQ23302</b> NO. 21511223302</p> <p><b>FORQUILHA DA EMBRAIAGEM</b></p> <p>BMW 3 Compact (E36) 318 tds 06.1995/08.2000 66KW 90CV 1665CC M41 D17 (174T1) 0005548 - BMW 3 Compact (E36) 323 ti 09.1997/08.2000 125KW 170CV 2494CC M52 B25 (256S3) 0005612</p> <p>252x83x28mm 1f-47x75mm</p>		<p><b>UFQ23302</b> NO. 21511223302</p> <p><b>FORQUILHA DA EMBRAIAGEM</b></p> <p>BMW 3 Coupé (E36) 320 i 12.1991/11.1998 110KW 150CV 1990CC M52 B20 (206S3) M50 B20 (206S2) M50 B20 (206S1) 0005519 0005551 - BMW 3 Coupé (E36) 323 i 05.1995/04.1999 125KW 170CV 2494CC M52 B25 (256S3) 0005562 - BMW 3 Coupé (E36) 325 i 10.1991/02.1995 141KW 192CV 2494CC M50 B25 (256S2) M50 B25 (256S1) 0005520 - BMW 3 Coupé (E36) 325 is 10.1991/08.1995 141KW 192CV 2494CC M50 B25 (256S2) M50 B25 (256S...</p> <p>252x83x28mm 1f-47x75mm</p>
	<p><b>UFQ23302</b> NO. 21511223302</p> <p><b>FORQUILHA DA EMBRAIAGEM</b></p> <p>BMW 3 Touring (E36) 318 tds 03.1995/04.1999 66KW 90CV 1665CC M41 D17 (174T1) 0005554 - BMW 3 Touring (E36) 320 i 01.1995/04.1999 110KW 150CV 1990CC M52 B20 (206S3) 0005555 - BMW 3 Touring (E36) 323 i 12.1995/04.1999 125KW 170CV 2494CC M52 B25 (256S3) 0005577 - BMW 3 Touring (E36) 328 i 02.1995/04.1999 142KW 193CV 2793CC M52 B28 (286S1) 0005557</p> <p>252x83x28mm 1f-47x75mm</p>		<p><b>UMB84029</b> NO. 07119837320 - 11111276472 - 11111717939 - 1717939 - 9937321</p> <p><b>TAMPÃO BLOCO MOTOR</b></p> <p>BMW 3 (E36) 316 i (De 09-1990 Até 09-1993) 73kw 100CV 1596cc três volumes BMW 3 (E36) 316 i (De 07-1993 Até 02-1998) 75kw 102CV 1596cc três volumes BMW 3 (E36) 318 i (De 12-1990 Até 10-1993) 83kw 113CV 1796cc três volumes BMW 3 (E36) 318 i (De 10-1993 Até 02-1998) 85kw 115CV 1796cc três volumes BMW 3 (E36) 318 is (De 03-1993 Até 02-1998) 103kw 140CV 1796cc três volumes BMW 3 (E36) 318 is (De ...</p> <p>d36x10mm di-32mm</p>
	<p><b>UMV25110</b> NO. 25111434495 - 25117500299 - 25117503231 - 25117523817 - 25117544524</p> <p><b>MANETE PUNHO TOPO ALAVANCA MUDANÇAS 5 VELOCIDADES NAPEL F14MM</b></p> <p>BMW 3 (E36): 318 is 09.1993/12.1995 103KW 140CV 1796CC - BMW 3 (E36): 320 i 01.1991/02.1998 110KW 150CV 1990CC - BMW 3 (E36): 323 i 05.1995/11.1998 125KW 170CV 2494CC - BMW 3 (E36): 328 i 01.1995/04.1998 142KW 193CV 2793CC - BMW 3 (E36): M3 3.0 10.1994/07.1995 210KW 286CV 2990CC - BMW 3 (E36): M3 3.2 10.1995/01.1998 236KW 321CV 3201CC - BMW 3 (E36): 318 tds 01.1995/02.1998 66KW 90CV 1665CC - BMW 3...</p> <p>d51x91mm 1f-d14mm</p>		<p><b>UMV25114</b> NO. 25111434495 - 25117500299 - 25117503231 - 25117523817 - 25117544524</p> <p><b>MANETE PUNHO TOPO ALAVANCA MUDANÇAS 5 VELOCIDADES F14MM</b></p> <p>BMW 3 (E36): 318 is 09.1993/12.1995 103KW 140CV 1796CC - BMW 3 (E36): 320 i 01.1991/02.1998 110KW 150CV 1990CC - BMW 3 (E36): 323 i 05.1995/11.1998 125KW 170CV 2494CC - BMW 3 (E36): 328 i 01.1995/04.1998 142KW 193CV 2793CC - BMW 3 (E36): M3 3.0 10.1994/07.1995 210KW 286CV 2990CC - BMW 3 (E36): M3 3.2 10.1995/01.1998 236KW 321CV 3201CC - BMW 3 (E36): 318 tds 01.1995/02.1998 66KW 90CV 1665CC - BMW 3...</p> <p>d56x94mm 1f-d14mm</p>
	<p><b>UMV26815</b> NO. 25111434495 - 25111434719</p> <p><b>MANETE PUNHO TOPO ALAVANCA MUDANÇAS 5 VELOCIDADES F13MM</b></p> <p>BMW E36</p> <p>55x44x94mm 1f-d13mm</p>		<p><b>UMV26816</b> NO. 25112229442 - 25117566267 - 25117833136 - 25118037305</p> <p><b>MANETE PUNHO TOPO ALAVANCA MUDANÇAS 6 VELOCIDADES F13MM</b></p> <p>BMW E36</p> <p>55x44x94mm 1f-d13mm</p>

	<p><b>UMV26820</b> NO. 25111221290 - 25111222280 - 25111434494 - 25111434495</p> <p><b>MANETE PUNHO TOPO ALAVANCA MUDANÇAS 5 VELOCIDADES F14MM</b></p> <p>BMW 3 (E36): 318 is 09.1993/12.1995 103KW 140CV 1796CC - BMW 3 (E36): 320 i 01.1991/02.1998 110KW 150CV 1990CC - BMW 3 (E36): 323 i 05.1995/11.1998 125KW 170CV 2494CC - BMW 3 (E36): 328 i 01.1995/04.1998 142KW 193CV 2793CC - BMW 3 (E36): M3 3.0 10.1994/07.1995 210KW 286CV 2990CC - BMW 3 (E36): M3 3.2 10.1995/01.1998 236KW 321CV 3201CC - BMW 3 (E36): 318 tds 01.1995/02.1998 66KW 90CV 1665CC - BMW 3...</p> <p>d46x94mm 1f-d14mm</p>		<p><b>UMV26822</b> NO. 25111434495 - 25117500299 - 25117503231 - 25117523817 - 25117544524</p> <p><b>MANETE PUNHO TOPO ALAVANCA MUDANÇAS 5 VELOCIDADES F15MM</b></p> <p>BMW 3 (E36): 318 is 09.1993/12.1995 103KW 140CV 1796CC - BMW 3 (E36): 320 i 01.1991/02.1998 110KW 150CV 1990CC - BMW 3 (E36): 323 i 05.1995/11.1998 125KW 170CV 2494CC - BMW 3 (E36): 328 i 01.1995/04.1998 142KW 193CV 2793CC - BMW 3 (E36): M3 3.0 10.1994/07.1995 210KW 286CV 2990CC - BMW 3 (E36): M3 3.2 10.1995/01.1998 236KW 321CV 3201CC - BMW 3 (E36): 318 tds 01.1995/02.1998 66KW 90CV 1665CC - BMW 3...</p> <p>d49x95mm 1f-d15mm</p>
	<p><b>UMV26826</b> NO. 25111221290 - 25111222280 - 25111434494 - 25111434495</p> <p><b>MANETE PUNHO TOPO ALAVANCA MUDANÇAS 5 VELOCIDADES F12MM C/LUZ</b></p> <p>BMW 3 (E36) 316 i 03.1991/08.1993 73KW 100CV 1596CC M40 B16 (164E1) 0005508 - BMW 3 (E36) 316 i 09.1993/05.1998 75KW 102CV 1596CC M43 B16 (164E2) 0005507 0005537 0005573 - BMW 3 (E36) 318 i 09.1990/08.1993 83KW 113CV 1796CC M40 B18 (184E1) 0005504 - BMW 3 (E36) 318 i 09.1993/11.1998 85KW 115CV 1796CC M43 B18 (184E2) 0005503 0005574 - BMW 3 (E36) 318 is 09.1993/12.1995 103KW 140CV 1796CC M42 B18 (1...</p> <p>54x45x91mm DIAMETRO INTERIOR 12MM</p>		<p><b>UMV26826</b> NO. 25111221290 - 25111222280 - 25111434494 - 25111434495</p> <p><b>MANETE PUNHO TOPO ALAVANCA MUDANÇAS 5 VELOCIDADES F12MM C/LUZ</b></p> <p>BMW 3 Cabriolet (E36) 318 i 01.1994/12.1995 103KW 140CV 1796CC M42 B18 (184S1) - BMW 3 Cabriolet (E36) 318 i 03.1994/11.1999 85KW 115CV 1796CC M43 B18 (184E2) 0005540 0005495 0005581 - BMW 3 Cabriolet (E36) 320 i 12.1993/11.1999 110KW 150CV 1990CC M52 B20 (206S3) M50 B20 (206S2) 0005530 0005552 - BMW 3 Cabriolet (E36) 323 i 05.1995/11.1999 125KW 170CV 2494CC M52 B25 (256S3) 0005563 - BMW 3 Cabriolet...</p> <p>54x45x91mm DIAMETRO INTERIOR 12MM</p>
	<p><b>UMV26826</b> NO. 25111221290 - 25111222280 - 25111434494 - 25111434495</p> <p><b>MANETE PUNHO TOPO ALAVANCA MUDANÇAS 5 VELOCIDADES F12MM C/LUZ</b></p> <p>BMW 3 Compact (E36) 316 g (De 02.1996 Até 08.2000) 75KW 102cv 1596cm3 Hatchback - BMW 3 Compact (E36) 316 i (De 01.1994 Até 08.2000) 75KW 102cv 1596cm3 Hatchback - BMW 3 Compact (E36) 316 i (De 01.1999 Até 08.2000) 77KW 105cv 1895cm3 Hatchback - BMW 3 Compact (E36) 318 tds (De 06.1995 Até 08.2000) 66KW 90cv 1665cm3 Hatchback - BMW 3 Compact (E36) 318 ti (De 09.1994 Até 12.1995) 103KW 140cv 1796cm3...</p> <p>54x45x91mm DIAMETRO INTERIOR 12MM</p>		<p><b>UMV26826</b> NO. 25111221290 - 25111222280 - 25111434494 - 25111434495</p> <p><b>MANETE PUNHO TOPO ALAVANCA MUDANÇAS 5 VELOCIDADES F12MM C/LUZ</b></p> <p>BMW 3 Coupé (E36) 316 i (De 09.1993 Até 11.1998) 75KW 102cv 1596cm3 Coupé - BMW 3 Coupé (E36) 318 is (De 01.1992 Até 12.1995) 103KW 140cv 1796cm3 Coupé - BMW 3 Coupé (E36) 318 is (De 09.1995 Até 04.1999) 103KW 140cv 1895cm3 Coupé - BMW 3 Coupé (E36) 320 i (De 12.1991 Até 11.1998) 110KW 150cv 1990cm3 Coupé - BMW 3 Coupé (E36) 323 i (De 05.1995 Até 04.1999) 125KW 170cv 2494cm3 Coupé - BMW 3 Coupé (E...</p> <p>54x45x91mm DIAMETRO INTERIOR 12MM</p>
	<p><b>UMV26826</b> NO. 25111221290 - 25111222280 - 25111434494 - 25111434495</p> <p><b>MANETE PUNHO TOPO ALAVANCA MUDANÇAS 5 VELOCIDADES F12MM C/LUZ</b></p> <p>BMW 3 Coupé (E46) 318 Ci (De 09.2001 Até 02.2004) 105KW 143cv 1995cm3 Coupé - BMW 3 Coupé (E46) 320 Ci (De 01.2000 Até 05.2006) 125KW 170cv 2171cm3 Coupé - BMW 3 Coupé (E46) 323 Ci (De 04.1999 Até 09.2000) 125KW 170cv 2494cm3 Coupé - BMW 3 Coupé (E46) 325 Ci (De 09.2000 Até 05.2006) 141KW 192cv 2494cm3 Coupé -</p> <p>54x45x91mm DIAMETRO INTERIOR 12MM</p>		<p><b>UMV26826</b> NO. 25111221290 - 25111222280 - 25111434494 - 25111434495</p> <p><b>MANETE PUNHO TOPO ALAVANCA MUDANÇAS 5 VELOCIDADES F12MM C/LUZ</b></p> <p>BMW 3 Touring (E36) 316 i (De 03.1997 Até 05.1999) 75KW 102cv 1596cm3 Combi - BMW 3 Touring (E36) 318 i (De 09.1995 Até 04.1999) 85KW 116cv 1796cm3 Combi - BMW 3 Touring (E36) 318 tds (De 03.1995 Até 04.1999) 66KW 90cv 1665cm3 Combi - BMW 3 Touring (E36) 320 i (De 01.1995 Até 04.1999) 110KW 150cv 1990cm3 Combi - BMW 3 Touring (E36) 323 i (De 12.1995 Até 04.1999) 125KW 170cv 2494cm3 Combi - BMW 3 T...</p> <p>54x45x91mm DIAMETRO INTERIOR 12MM</p>
	<p><b>UMV26828</b> NO. 82239405686</p> <p><b>MANETE PUNHO TOPO ALAVANCA MUDANÇAS 5 VELOCIDADES F13MM</b></p> <p>BMW SERIE 3 (E36) 328i</p> <p>46x55x96mm 1f-d13mm</p>		<p><b>UMV26829</b> NO. 25119416257</p> <p><b>MANETE PUNHO TOPO ALAVANCA MUDANÇAS 6 VELOCIDADES F14MM</b></p> <p>BMW SERIE 3 (E36)</p> <p>55x47x97mm 1f-d14mm</p>
	<p><b>UPV86150</b> NO. 1384859 - 61601384859</p> <p><b>PULVERIZADOR ESGUICHO PARA-BRISAS</b></p> <p>BMW 3 (E36) 316 A1:B45i (De 03.1991 Até 08.1993) 73KW 100cv 1596cm3 três volumes - BMW 3 (E36) 316 i (De 09.1993 Até 05.1998) 75KW 102cv 1596cm3 três volumes - BMW 3 (E36) 318 i (De 09.1990 Até 08.1993) 83KW 113cv 1796cm3 três volumes - BMW 3 (E36) 318 i (De 09.1993 Até 11.1998) 85KW 115cv 1796cm3 três volumes - BMW 3 (E36) 318 is (De 09.1993 Até 12.1995) 103KW 140cv 1796cm3 três volumes - BMW 3 (...)</p> <p>30x20x48mm 1p-d6x38mm</p>		<p><b>UTR0846</b> NO. 1029727 - 7166662 - 95VB8100AD - 95VB8100AE</p> <p><b>TAMPÃO RESERVATÓRIO LIQUIDO REFRIGERAÇÃO</b></p> <p>BMW 3 Coupé (E36) M3 3.2 (10.95 A 04.99) 321cv 3201cc Coupé</p> <p>62x37mm 1f-d52x12mm</p>
	<p><b>W5047</b> NO. 0614610 - 0614612 - 11232244417 - 11232245377 - 11232246510 - 11232246511 - 614610 - 614612 - ...</p> <p><b>POLIE DA CAMBOTA (5 PISTAS)</b></p> <p>BMW 3 (E36): 325 td 09.1991/02.1998 85KW 115CV 2497CC - BMW 3 (E36): 325 tds 05.1993/02.1998 105KW 143CV 2497CC - BMW 3 Touring (E36): 325 tds 03.1995/04.1999 105KW 143CV 2497CC</p> <p>d157/205mm d45mm</p>		<p><b>Y3239</b> NO. 36130141574 - 36130141576 - 36131095390 - 36131116717 - 36131117190 - 36131126191</p> <p><b>PARAFUSO PERNO RODA CHAVE 17 M12X1,50X50MM ( BASE CONICA )</b></p> <p>BMW 3 (E36) 316 i 03.1991/08.1993 73KW 100CV 1596CC M40 B16 (164E1) 0005508 - BMW 3 (E36) 316 i 09.1993/05.1998 75KW 102CV 1596CC M43 B16 (164E2) 0005507 0005537 0005573 - BMW 3 (E36) 318 i 09.1990/08.1993 83KW 113CV 1796CC M40 B18 (184E1) 0005504 - BMW 3 (E36) 318 i 09.1993/11.1998 85KW 115CV 1796CC M43 B18 (184E2) 0005503 0005574 - BMW 3 (E36) 318 is 09.1993/12.1995 103KW 140CV 1796CC M42 B18 (1...</p> <p>c51mm (ch-17mm) M12x1x24mm</p>
	<p><b>Y3239</b> NO. 36130141574 - 36130141576 - 36131095390 - 36131116717 - 36131117190 - 36131126191</p> <p><b>PARAFUSO PERNO RODA CHAVE 17 M12X1,50X50MM ( BASE CONICA )</b></p> <p>BMW 3 Cabriolet (E36) 318 i 03.1994/11.1999 85KW 115CV 1796CC M43 B18 (184E2) 0005540 0005495 0005581 - BMW 3 Cabriolet (E36) 320 i 12.1993/11.1999 110KW 150CV 1990CC M52 B20 (206S3) M50 B20 (206S2) 0005530 0005552 - BMW 3 Cabriolet (E36) 323 i 05.1995/11.1999 125KW 170CV 2494CC M52 B25 (256S3) 0005563 - BMW 3 Cabriolet (E36) 325 i 03.1993/08.1995 141KW 192CV 2494CC M50 B25 (256S2) 0005531 - BMW 3...</p> <p>c51mm (ch-17mm) M12x1x24mm</p>		<p><b>Y3239</b> NO. 36130141574 - 36130141576 - 36131095390 - 36131116717 - 36131117190 - 36131126191</p> <p><b>PARAFUSO PERNO RODA CHAVE 17 M12X1,50X50MM ( BASE CONICA )</b></p> <p>BMW 3 Coupé (E36) 316 i 09.1993/11.1998 75KW 102CV 1596CC M43 B16 (164E2) 0005538 0005580 - BMW 3 Coupé (E36) 318 is 01.1992/12.1995 103KW 140CV 1796CC M42 B18 (184S1) 0005518 - BMW 3 Coupé (E36) 318 is 09.1995/04.1999 103KW 140CV 1895CC M44 B19 (194S1) 0005582 - BMW 3 Coupé (E36) 320 i 12.1991/11.1998 110KW 150CV 1990CC M52 B20 (206S3) M50 B20 (206S2) M50 B20 (206S1) 0005519 0005551 - BMW 3 Coupé...</p> <p>c51mm (ch-17mm) M12x1x24mm</p>

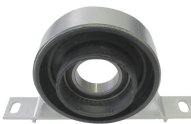
	<p><b>Y3239</b> NO. 36130141574 - 36130141576 - 36131095390 - 36131116717 - 36131117190 - 36131126191</p> <p><b>PARAFUSO PERNO RODA CHAVE 17 M12X1,50X50MM ( BASE CONICA )</b></p> <p>BMW 3 Touring (E36) 316 i 03.1997/05.1999 75KW 102CV 1596CC M43 B16 (164E2) 0005617 - BMW 3 Touring (E36) 318 i 09.1995/04.1999 85KW 116CV 1796CC M43 B18 (184E2) 0005575 - BMW 3 Touring (E36) 318 tds 03.1995/04.1999 66KW 90CV 1665CC M41 D17 (174T1) 0005554 - BMW 3 Touring (E36) 320 i 01.1995/04.1999 110KW 150CV 1990CC M52 B20 (206S3) 0005555 - BMW 3 Touring (E36) 323 i 12.1995/04.1999 125KW 170CV ...</p> <p>c51mm (ch-17mm) M12x1x24mm</p>		<p><b>Z71231</b> NO. 51718184574 - 8184574</p> <p><b>MOLA DE FIXAÇÃO MOLDURA DE PORTA</b></p> <p>BMW 3 (E36) 316 i 03.1991/08.1993 73KW 100CV 1596CC M40 B16 (164E1) 0005508 - BMW 3 (E36) 316 i 09.1993/05.1998 75KW 102CV 1596CC M43 B16 (164E2) 0005507 0005537 0005573 - BMW 3 (E36) 318 i 09.1990/08.1993 83KW 113CV 1796CC M40 B18 (184E1) 0005504 - BMW 3 (E36) 318 i 09.1993/11.1998 85KW 115CV 1796CC M43 B18 (184E2) 0005503 0005574 - BMW 3 (E36) 318 is 09.1993/12.1995 103KW 140CV 1796CC M42 B18 (1...)</p> <p>32x20x9mm 1p-d4x9mm</p>
	<p><b>Z80726</b> NO. 51131960054</p> <p><b>Mola de friso</b></p> <p>BMW 3 (E36) 316 i 03.1991/08.1993 73KW 100CV 1596CC M40 B16 (164E1) 0005508 - BMW 3 (E36) 316 i 09.1993/05.1998 75KW 102CV 1596CC M43 B16 (164E2) 0005507 0005537 0005573 - BMW 3 (E36) 318 i 09.1990/08.1993 83KW 113CV 1796CC M40 B18 (184E1) 0005504 - BMW 3 (E36) 318 i 02.1992/12.1995 103KW 140CV 1796CC M42 B18 (184S1) - BMW 3 (E36) 318 i 09.1993/11.1998 85KW 115CV 1796CC M43 B18 (184E2) 0005503 000...</p> <p>35x22,5x21,7mm</p>		<p><b>Z80751</b> NO. 51132251394</p> <p><b>Mola de friso</b></p> <p><b>BMW SÉRIE 3(E36) (De 1990 A 1998)</b></p> <p>31x12,6x24mm</p>
	<p><b>Z80834</b> NO. 51321938884</p> <p><b>MOLA DE FIXAÇÃO</b></p> <p>BMW 3 (E36): 316 i 03.1991/08.1993 73KW 100CV 1596CC - BMW 3 (E36): 316 i 09.1993/05.1998 75KW 102CV 1596CC - BMW 3 (E36): 318 i 09.1990/08.1993 83KW 113CV 1796CC - BMW 3 (E36): 318 i 09.1993/11.1998 85KW 115CV 1796CC - BMW 3 (E36): 318 is 09.1993/12.1995 103KW 140CV 1796CC - BMW 3 (E36): 318 is 01.1996/05.1998 103KW 140CV 1796CC - BMW 3 (E36): 320 i 01.1991/02.1998 110KW 150CV 1990CC - BMW 3 (E36)...</p> <p>37x29x12,2mm</p>		<p><b>Z80849</b> NO. 51411973500 - 51418161527 - 51477025224 - 51477117532</p> <p><b>Mola de painel</b></p> <p><b>BMW</b></p> <p>3 (E36)</p> <p><b>INFORMAÇÕES</b></p> <p>TIPO</p> <p>ANO DE CONSTRUÇÃO</p> <p>KW</p> <p>HP</p> <p>CC</p> <p><b>CÓDIGO DO MOTOR</b> 1p-d9-13mm</p> <p><b>NUMERO KBA (ALEMANHA)</b></p> <p>316 i 03.1991 - 08.1993 73 100 1596 M40 B16 (164E1) 0005508 316 i 09.1993 - 05.1998 75 102 1596 M43 B16 (164E2) 0005507 0005537 0005573 318 i 09.1990 - 08.1993 83 113 1796 M40 B18 (184E1) 0005504 318 i 02.1992 - 12.1995 103 140 1796 M42 B18 (184S1) 318 i...</p>

## BMW SERIE 3(E46)

	<p><b>A1746</b> NO. 22311094916 - 22316771221 - 23711131664</p> <p><b>APOIO DA CAIXA DE VELOCIDADES PARTE DE TRÁS</b></p> <p>BMW 3 (E46) 320 i 09.2000/02.2005 125KW 170CV 2171CC M54 B22 (226S1) 0005704 - BMW 3 (E46) 325 i 09.2000/02.2005 141KW 192CV 2494CC M54 B25 (256S5) 0005708 - BMW 3 (E46) 330 d 10.1999/02.2005 135KW 184CV 2926CC M57 D30 (306D1) 0005662 - BMW 3 (E46) 330 d 03.2003/02.2005 150KW 204CV 2993CC M57 D30 (306D2) 0005768 - BMW 3 (E46) 330 xd 01.2000/02.2003 135KW 184CV 2926CC M57 D30 (306D1) 0005712 - BMW ...</p> <p>d50x34mm 2p-d8-17/19mm</p>		<p><b>A1751</b> NO. 22111094814 - 22116771360 - 22116779972</p> <p><b>APOIO DO MOTOR PARTE DA FRENTE DIREITO</b></p> <p>BMW SÉRIE 3(E46) 316 i (04-2000 A 02-2005) - 316 Ti COMPACT (06-2001 A 02-2005) - 316 Ci COUPÉ (APÓS 04-2000) - 316 i TOURING (03-2002 A 02-2005) - 318 D (09-2001 A02-2005) - 318 i (02-1998 A 02-2005) - 318 Ci CABRIOLET (APÓS 09-2001) - 318 TD COMPACT (03)</p> <p>104x71mm 1p-d10-28mm 1p-d10-20mm</p>
	<p><b>A1885</b> NO. 26121229492 - 26127501257</p> <p><b>APOIO DA TRANSMISSÃO</b></p> <p>BMW 3 (E46) 316 i (02-2002 A 02-2005) 115CV 1796CC - BMW 3 (E46) 316i (09-1998 A 02-2005) 105CV 1895CC - BMW 3 (E46) 318i (02-1998 A 09-2001) 118CV 1895CC - BMW 3 (E46) 318i (09-2001 A 02-2005) 143CV 1995CC - BMW 3 (E46) 320i (03-1998 A 09-2000) 150CV 199</p> <p>182x105x32mm 1f-d30mm</p>		<p><b>A2462</b> NO. 26122282496 - 26127501258 - 26127506783</p> <p><b>APOIO DA TRANSMISSÃO</b></p> <p>BMW 3 (E46): 330 d 10.1999/02.2005 135KW 184CV 2926CC - BMW 3 (E46): 330 d 03.2003/02.2005 150KW 204CV 2993CC - BMW 3 Coupé (E46): 330 Cd 03.2003/07.2006 150KW 204CV 2993CC - BMW 3 Cabriolet (E46): 330 Cd 08.2005/12.2007 150KW 204CV 2993CC - BMW 3 Touring (E46): 330 d 10.1999/02.2005 135KW 184CV 2926CC - BMW 3 Touring (E46): 330 d 03.2003/02.2005 150KW 204CV 2993CC</p> <p>182x36x101mm 2f-9x16mm 1f-d35mm</p>
	<p><b>D0022</b> NO. 26111209168 - 26111227420 - 26111227717 - 26111229080 - 26111229360 - 26117511454</p> <p><b>CARDAN TRANSMISSÃO D135X30MM 6 FUROS 12MM ENTRE FUROS 96MM</b></p> <p>BMW (E46) 316 i 04.2000/02.2005 77KW 105CV 1596CC M43 B16 (164E3) 0005648 - BMW (E46) 316 i 02.2002/02.2005 85KW 115CV 1796CC N46 B18 A N42 B18 A 0005754 - BMW (E46) 318 d 09.2001/03.2003 85KW 116CV 1951CC M47 D20 (204D1) 0005725 - BMW (E46) 318 d 03.2003/02.2005 85KW 116CV 1955CC M47 D20 (204D4) 0005766 - BMW (E46) 318 i 09.2001/02.2005 105KW 143CV 1995CC N46 B20 A N46 B20 C N42 B20 A 0005733 - B...</p> <p>d132x123x30mm 6f-d12mm</p>		<p><b>D0030</b> NO. 26111229754 - 26117572664</p> <p><b>CARDAN TRANSMISSÃO D162X42MM 6 FUROS 12MM ENTRE FUROS 110MM</b></p> <p>BMW 3 (E46) 330 d 10.1999/02.2005 135KW 184CV 2926CC M57 D30 (306D1) 0005662 - BMW 3 (E46) 330 d 03.2003/02.2005 150KW 204CV 2993CC M57 D30 (306D2) 0005768 - BMW 3 Cabriolet (E46) 330 Cd 08.2005/12.2007 150KW 204CV 2993CC M57 D30 (306D2) 0005842 0005AEM - BMW 3 Coupé (E46) 330 Cd 03.2003/07.2006 150KW 204CV 2993CC M57 D30 (306D2) 0005764 0005AET - BMW 3 Touring (E46) 330 d 10.1999/02.2005 135KW 18...</p> <p>d160x42mm 1f-d45mm 6f-d12mm</p>
	<p><b>D0031</b> NO. 26111229065 - 26111277690</p> <p><b>CARDAN TRANSMISSÃO D140X38MM 6 FUROS 14MM ENTRE FUROS 105MM</b></p> <p>BMW 3 (E46) 330 d 10.1999/02.2005 135KW 184CV 2926CC M57 D30 (306D1) 0005662 - BMW 3 (E46) 330 d 03.2003/02.2005 150KW 204CV 2993CC M57 D30 (306D2) 0005768 - BMW 3 Cabriolet (E46) 330 Cd 08.2005/12.2007 150KW 204CV 2993CC M57 D30 (306D2) 0005842 0005AEM - BMW 3 Coupé (E46) 330 Cd 03.2003/07.2006 150KW 204CV 2993CC M57 D30 (306D2) 0005764 0005AET - BMW 3 Touring (E46) 330 d 10.1999/02.2005 135KW 18...</p> <p>d140x38mm 1f-d52mm 6f-d14mm</p>		<p><b>D0049</b> NO. 1227410 - 1227869 - 1229516 - 26111227410 - 26111227869 - 26111229516 - 26111227410 - 26111227869</p> <p><b>CARDAN TRANSMISSÃO</b></p> <p>BMW 3 (E46) 316 i 12.1998/02.2002 77KW 105CV 1895CC M43 B19 (194E1) 0005628 - BMW 3 (E46) 316 i 04.2000/02.2005 77KW 105CV 1596CC M43 B16 (164E3) 0005648 - BMW 3 (E46) 316 i 02.2002/02.2005 85KW 115CV 1796CC N46 B18 A N42 B18 A 0005754 - BMW 3 (E46) 316 i 06.2002/02.2005 85KW 115CV 1596CC N40 B16 A N45 B16 A 0005741 - BMW 3 (E46) 318 i 12.1997/09.2001 87KW 118CV 1895CC M43 B19 (194E1) 0005622 0005...</p> <p>111x107x32mm 6f-d12mm</p>



	<p><b>E0122</b> NO. 33551094619</p> <p>ESTICADOR DA BARRA ESTABILIZADORA DE TRÁS</p> <p>BMW SERIE 3 E46 TT</p> <p>125x31x28mm 1f-d8mm</p>		<p><b>E0124</b> NO. 31351095694 - 893407465 - 893407465A - 8A0407465 - 8A0407465B - 8A0407465C - 95994977</p> <p>ESTICADOR DA BARRA ESTABILIZADORA DA FRENTE</p> <p>BMW SERIE 3 E46 TT</p> <p>310x36x36mm 2p-d10-23mm</p>
	<p><b>E0171</b> NO. 31356751080</p> <p>ESTICADOR DA BARRA ESTABILIZADORA DE TRÁS LADO DIREITO</p> <p>BMW SERIE 3 (E46) 325 Xi - 330 Xi - 330 XD (APÓS 02-2005)</p> <p>345x35x35mm 2p-d10-21mm</p>		<p><b>E0173</b> NO. 31356751079</p> <p>ESTICADOR DA BARRA ESTABILIZADORA DA FRENTE LADO ESQUERDO</p> <p>BMW SERIE 3 (E46) 325 Xi - 330 Xi - 330 XD (APÓS 02-2005)</p> <p>340x35x35mm 2p-d10-20mm</p>
	<p><b>E0174</b> NO. 33552282182</p> <p>ESTICADOR DA BARRA ESTABILIZADORA DE TRÁS</p> <p>BMW SERIE 3 (E46) M3 3.2 CABRIOLET - COUPÉ - BMW Z4 2.2 - 2.5 - 3.0</p> <p>120x31x23mm 1f-d8mm 1f-d7mm</p>		<p><b>E1094</b> NO. 18201732926 - 18207503246</p> <p>ESTICADOR DE ESCAPE</p> <p>BMW (E46) (APÓS 1998) 316i - 316Ci - 318i - 318Ci - 320i - 320Ci - 323i - 323Ci - 325i - 325Ci - 328i - 328Ci - 330i - 330Ci - BMW(Z3) 2.0 (1999 A 2003)</p> <p>170x80x31mm</p>
	<p><b>E1095</b> NO. 1438435 - 18201438435 - 18207786468 - 18211248109 - 18212248109</p> <p>ESTICADOR DE ESCAPE</p> <p>BMW 3 (E46) 320 d 04.1998/09.2001 100KW 136CV 1951CC M47 D20 (204D1) 0005624 - BMW 3 Touring (E46) 320 d 03.2000/09.2001 100KW 136CV 1951CC M47 D20 (204D1) 0005659</p> <p>145x80x34mm</p>		<p><b>E1104</b> NO.</p> <p>ESTICADOR DO ESCAPE PARTE DE TRÁS</p> <p>BMW - 3 (E46) - 318d TRÊS VOLUMES 116CV 1951cc (09-2001 A 03-2003) - 318d TRÊS VOLUMES 116CV 1995cc (03-2003 A 02-2005) - 320d TRÊS VOLUMES 150CV 1995cc (09-2001 A 02-2005) - 330d TRÊS VOLUMES 204CV 2993cc (03-2003 A 02-2005) - 330 xd TRÊS VOLUMES 204CV 29</p> <p>88x91x24mm 3f-d10mm</p>
	<p><b>F1641-A-I</b> NO. 33211229209 - 33211229378 - 33217504705 - 33219067805</p> <p>FOLE DA TRANSMISSÃO JUNTO À CAIXA</p> <p>BMW 3 Cabriolet (E46) M3 03.2001/08.2006 252KW 343CV 3246CC S54 B32 (326S4) 7909315 - BMW 3 Coupé (E46) M3 07.2000/05.2006 252KW 343CV 3246CC S54 B32 (326S4) 7909312, 7909AAC</p> <p>d110x92mm 1f-d106mm 1f-d25mm</p>		<p><b>F1799-I</b> NO. 33211229593 - 33217529916 - 33217547081</p> <p>FOLE TRANSMISSÃO JUNTO A CAIXA FALANGE D105MM</p> <p>BMW SÉRIE 3 (E46) (APÓS 1998) 2.0 TD i.d.320 D - 2.0 TDCR 318D - 2.0 TDCR 320CD - 2.0 TDCR 320 D - 2.0 TDCR 320 TD - 2.0i 320i - 2.5i 323Ci - 2.5i 323i - 2.8i - 3.0 TDCR</p> <p>d102x100mm 1f-d100mm 1f-d23mm</p>
	<p><b>F1805-I</b> NO. 1094933 - 32131094933 - 32131096465 - 32131096910 - 32211139786</p> <p>FOLE DIREÇÃO ( GASTA 2 UNIDADES )</p> <p>BMW SERIE 3 (E46)</p> <p>d70x175mm 1f-d55mm 1f-d42mm</p>		<p><b>F1834-T</b> NO. 31607507403</p> <p>FOLE DA TRANSMISSÃO JUNTO À CAIXA</p> <p>BMW SÉRIE 3(E46) 2.5i 325Xi 4X4 - 3.0i 330Xi 4X4 - 3.0 TDCR 330XD 4X4 (APÓS 1998)</p> <p>d100x128mm 1f-d96mm 1f-d27mm</p>
	<p><b>F1846-I</b> NO. 33211229594 - 33217527325 - 33217527326 - 33217529915 - 33217547080</p> <p>FOLE DA TRANSMISSÃO JUNTO À RODA</p> <p>BMW SÉRIE 3 (E46) 2.0i 320i - 2.0 TD ID 320D - 2.0 TDCR 318D - 2.0 TDCR 320D - 2.5i 323i - 2.5i 325Xi 4X4 - 2.8i 328i - 3.0 TDCR 330XD 4X4 - 2.0 TDCR 320CD - 2.5i 323Ci - 2.5i 325Ci - 2.8i 328Ci - 2.0 TDCR 320TD - 2.5i 325Ti (1998 A 2005)</p> <p>d80x78mm 1f-d51mm 1f-d31mm</p>		<p><b>F1847-I</b> NO. 33211229590 - 33217527323 - 33217527324 - 33217529919</p> <p>FOLE DA TRANSMISSÃO JUNTO À RODA</p> <p>BMW SÉRIE 3 (E46) 1.6i 316i - 1.9i 316i - 1.9i 318i - 2.0i 318i - 2.0i 320i - 2.2i 320i - 1.6i 316Ci - 1.9i 318Ci - 2.0i 318Ci - 2.0i 320Ci - 2.2i 320Ci - 1.6i 316Ti - 1.8i 316Ti - 2.0i 318Ti (APOS 1998)</p> <p>d80x78mm 1f-d44mm 1f-d30mm</p>
	<p><b>F4207</b> NO. 25118036629 - 25118037309</p> <p>FOLE ALAVANCA VELOCIDADES C/ MANETE PUNHO TOPO COMPLETO 6 VELOCIDADES</p> <p>BMW E46</p> <p>172x153x212mm 135x145mm</p>		<p><b>F4245</b> NO. 25111434098</p> <p>FOLE ALAVANCA VELOCIDADES</p> <p>BMW 3 (E46) 316 i (De 04.2000 Até 02.2005) 77kW 105cv 1596cm3 três volumes - BMW 3 (E46) 316 i (De 06.2002 Até 02.2005) 85kW 115cv 1596cm3 três volumes - BMW 3 (E46) 316 i (De 02.2002 Até 02.2005) 85kW 115cv 1796cm3 três volumes - BMW 3 (E46) 316 i (De 12.1998 Até 02.2002) 77kW 105cv 1895cm3 três volumes - BMW 3 (E46) 318 d (De 09.2001 Até 03.2003) 85kW 116cv 1951cm3 três volumes - BMW 3 (E46) 318...</p> <p>166x129x170mm 1f-117x146mm</p>







	<p><b>R222280</b> NO. 11617791393 - 116177913931 - 1161779397 - 11617793971</p> <p>TUBO ADMISSÃO FILTRO DE AR</p> <p>BMW 3 (E46) 318 d 03.2003/02.2005 85KW 116CV 1995CC M47 D20 (204D4) 0005766 - BMW 3 (E46) 320 d 04.1998/09.2001 100KW 136CV 1951CC M47 D20 (204D1) 0005624 - BMW 3 (E46) 320 d 09.2001/05.2005 110KW 150CV 1995CC M47 D20 (204D4) 0005737 - BMW 3 Compact (E46) 320 td 09.2001/02.2005 110KW 150CV 1995CC M47 D20 (204D4) 0005720 - BMW 3 Coupé (E46) 320 Cd 11.2003/07.2006 110KW 150CV 1995CC M47 D20 (204D4) ...</p> <p>B250-d51/57mm 100-200mm</p>		<p><b>R222281</b> NO. 11617791393 - 116177913932 - 1161779397 - 11617793972</p> <p>TUBO ADMISSÃO FILTRO DE AR</p> <p>BMW 3 (E46) 318 d 03.2003/02.2005 85KW 116CV 1995CC M47 D20 (204D4) 0005766 - BMW 3 (E46) 320 d 04.1998/09.2001 100KW 136CV 1951CC M47 D20 (204D1) 0005624 - BMW 3 (E46) 320 d 09.2001/05.2005 110KW 150CV 1995CC M47 D20 (204D4) 0005737 - BMW 3 Compact (E46) 320 td 09.2001/02.2005 110KW 150CV 1995CC M47 D20 (204D4) 0005720 - BMW 3 Coupé (E46) 320 Cd 11.2003/07.2006 110KW 150CV 1995CC M47 D20 (204D4) ...</p> <p>B235-d55/56mm 100-100-90mm</p>
	<p><b>R222287</b> NO. 11617779963 - 11617797707 - 11617799400</p> <p>TUBO DO AR SOBREALIMENTAÇÃO</p> <p>BMW 3 (E46) 320 d (De 04.1998 Até 09.2001) 100kW 136cv 1951cm3 três volumes - BMW 3 (E46) 320 d (De 09.2001 Até 05.2005) 110kW 150cv 1995cm3 três volumes -</p> <p>B200-53/63mm 100x81mm</p>		<p><b>R224689</b> NO. 11532249778 - 2249778</p> <p>TUBO SUPERIOR DO RADIADOR LADO ESQUERDO</p> <p>BMW 3 (E46) 318 d 09.2001/03.2003 85KW 116CV 1951CC M47 D20 (204D1) 0005725 - BMW 3 (E46) 318 d 03.2003/02.2005 85KW 116CV 1995CC M47 D20 (204D4) 0005766 - BMW 3 (E46) 320 d 09.2001/05.2005 110KW 150CV 1995CC M47 D20 (204D4) 0005737</p> <p>B625-38/39mm 130-80-200-75-74-53-120mm</p>
	<p><b>R224689</b> NO. 11532249778</p> <p>TUBO SUPERIOR DO RADIADOR LADO ESQUERDO</p> <p>BMW 3 Cabriolet (E46) 320 Cd 02.2005/12.2007 110KW 150CV 1995CC M47 D20 (204D4) 0005815 0005AEK</p> <p>B625-38/39mm 130-80-200-75-74-53-120mm</p>		<p><b>R224689</b> NO. 11532249778</p> <p>TUBO SUPERIOR DO RADIADOR LADO ESQUERDO</p> <p>BMW 3 Compact (E46) 318 td 03.2003/02.2005 85KW 115CV 1995CC M47 D20 (204D4) 0005765 - BMW 3 Compact (E46) 320 td 09.2001/02.2005 110KW 150CV 1995CC M47 D20 (204D4) 0005720</p> <p>B625-38/39mm 130-80-200-75-74-53-120mm</p>
	<p><b>R224689</b> NO. 11532249778</p> <p>TUBO SUPERIOR DO RADIADOR LADO ESQUERDO</p> <p>BMW 3 Coupé (E46) 320 Cd 11.2003/07.2006 110KW 150CV 1995CC M47 D20 (204D4) 0005763 0005AEV</p> <p>B625-38/39mm 130-80-200-75-74-53-120mm</p>		<p><b>R224689</b> NO. 11532249778</p> <p>TUBO SUPERIOR DO RADIADOR LADO ESQUERDO</p> <p>BMW 3 Touring (E46) 318 d 03.2003/02.2005 85KW 116CV 1995CC M47 D20 (204D4) 0005767 - BMW 3 Touring (E46) 320 d 09.2001/02.2005 110KW 150CV 1995CC M47 D20 (204D4) 0005738</p> <p>B625-38/39mm 130-80-200-75-74-53-120mm</p>
	<p><b>R225322</b> NO. 11617789963 - 11617797707 - 11617799400</p> <p>TUBO DO AR SOBREALIMENTAÇÃO</p> <p>BMW 3 (E46) 320 d (De 04.1998 Até 09.2001) 100kW 136cv 1951cm3 três volumes - BMW 3 (E46) 320 d (De 09.2001 Até 05.2005) 110kW 150cv 1995cm3 três volumes -</p> <p>B205-52/63mm B205-56/64mm 101x88x50mm</p>		<p><b>R225323</b> NO. 11617789963 - 11617797707 - 11617799400</p> <p>TUBO DO AR SOBREALIMENTAÇÃO</p> <p>BMW 3 (E46) 320 d (De 04.1998 Até 09.2001) 100kW 136cv 1951cm3 três volumes - BMW 3 (E46) 320 d (De 09.2001 Até 05.2005) 110kW 150cv 1995cm3 três volumes -</p> <p>B220-57/63mm 104x72x53mm</p>
	<p><b>R225923</b> NO. 64218377781</p> <p>TUBO DO PERMUTADOR DO AQUECIMENTO</p> <p>BMW 3 (E46) 316 i 12.1998/02.2002 77KW 105CV 1895CC M43 B19 (194E1) 0005628 - BMW 3 (E46) 316 i 04.2000/02.2005 77KW 105CV 1596CC M43 B16 (164E3) 0005648 - BMW 3 (E46) 316 i 06.2002/02.2005 85KW 115CV 1596CC N40 B16 A N45 B16 A 0005741 - BMW 3 (E46) 318 i 12.1997/09.2001 87KW 118CV 1895CC M43 B19 (194E1) 0005622 0005642 - BMW 3 Coupé (E46) 316 Ci 04.2000/07.2006 77KW 105CV 1596CC M43 B16 (164E3) 0...</p> <p>B235-18/18mm 36x37x89x41x31mm</p>		<p><b>R8184</b> NO. 32411093130 - 32411095526</p> <p>TUBO DE LIGAÇÃO DA BOMBA HIDRÁULICA DIREÇÃO</p> <p>BMW 3 (E46) 320 i 03.1998/09.2000 110KW 150CV 1990CC M52 B20 (206SA) 0005625 - BMW 3 (E46) 320 i 09.2000/02.2005 125KW 170CV 2171CC M54 B22 (226S1) 0005704 - BMW 323 i 03.1998/09.2000 125KW 170CV 2494CC M52 B25 (256SA) 0005626 - BMW 3 (E46) 325 i 09.2000/02.2005 141KW 192CV 2494CC M54 B25 (256S5) 0005708 - BMW 3 (E46) 325 xi 09.2000/02.2005 141KW 192CV 2494CC M54 B25 (256S5) 0005710 - BMW 3 (E46) ...</p> <p>B360-d16/d16mm</p>
	<p><b>RT08910</b> NO. 34321165587 - 34326766967</p> <p>TUBO DE TRAVÃO FRENTE LH-RH</p> <p>BMW SÉRIE 3 E46 S- ABS TT</p> <p>405mm F6 - MCL</p>		<p><b>S1302</b> NO. 1136311 - 33321136311 - 33326471828 - 33326771828 - 6771828</p> <p>SILENT-BLOC EXTERNO DO BRAÇO OSCILANTE SUSPENSÃO TRÁS</p> <p>BMW 3 (E46) 316 i 12.1998/02.2002 77KW 105CV 1895CC M43 B19 (194E1) 0005628 - BMW 3 (E46) 316 i 04.2000/02.2005 77KW 105CV 1596CC M43 B16 (164E3) 0005648 - BMW 3 (E46) 316 i 02.2002/02.2005 85KW 115CV 1796CC N46 B18 A N42 B18 A 0005754 - BMW 3 (E46) 316 i 06.2002/02.2005 85KW 115CV 1596CC N40 B16 A N45 B16 A 0005741 - BMW 3 (E46) 318 d 09.2001/03.2003 85KW 116CV 1951CC M47 D20 (204D1) 0005725 - BM...</p> <p>d45x57mm c32.5mm 1f-d12mm</p>
	<p><b>S1635</b> NO. 33306852895 - 33321138722 - 33321140345 - 33326775551</p> <p>SILENT-BLOC DO BRAÇO SUSPENSÃO DA FRENTE</p> <p>BMW 3 (E46) 316 i 12.1998/02.2002 77KW 105CV 1895CC M43 B19 (194E1) 0005628 - BMW 3 (E46) 316 i 02.2002/02.2005 85KW 115CV 1796CC N46 B18 A N42 B18 A 0005754 - BMW 3 (E46) 318 i 12.1997/09.2001 87KW 118CV 1895CC M43 B19 (194E1) 0005622 0005642 - BMW 3 (E46) 318 i 09.2001/02.2005 105KW 143CV 1995CC N46 B20 A N46 B20 C N42 B20 A 0005733 - BMW 3 (E46) 320 d 04.1998/09.2001 100KW 136CV 1951CC M47 D20 ...</p> <p>d45x57mm c47mm 1f-d12mm</p>		<p><b>S1959</b> NO. 33321092247 - 33321137571</p> <p>SILENT-BLOC BRAÇO SUSPENSÃO TRÁS SUPERIOR PARTE INTERIOR</p> <p>BMW 3 (E46) 316 i (De 06.2002 Até 02.2005) 85kW 115cv 1596cm3 três volumes - BMW 3 (E46) 316 i (De 02.2002 Até 02.2005) 85kW 115cv 1796cm3 três volumes - BMW 3 (E46) 316 i (De 12.1998 Até 02.2002) 77kW 105cv 1895cm3 três volumes - BMW 3 (E46) 316 i (De 04.2000 Até 02.2005) 77kW 105cv 1596cm3 três volumes - BMW 3 (E46) 318 d (De 09.2001 Até 03.2003) 85kW 116cv 1951cm3 três volumes - BMW 3 (E46) 318...</p> <p>d35x66mm c42mm 1f-d12mm</p>

	<p><b>S1959</b> NO. 33321092247 - 33321137571</p> <p><b>SILENT-BLOC BRAÇO SUSPENSÃO TRÁS SUPERIOR PARTE INTERIOR</b></p> <p>BMW 3 Cabriolet (E46) 318 Ci (De 09.2001 Até 12.2007) 105kW 143cv 1995cm3 Cabriolet - BMW 3 Cabriolet (E46) 318 Ci (De 03.2004 Até 08.2006) 110kW 150cv 1995cm3 Cabriolet - BMW 3 Cabriolet (E46) 320 Cd (De 02.2005 Até 12.2007) 110kW 150cv 1995cm3 Cabriolet - BMW 3 Cabriolet (E46) 320 Ci (De 09.2000 Até 12.2007) 125kW 170cv 2171cm3 Cabriolet - BMW 3 Cabriolet (E46) 323 Ci (De 04.2000 Até 09.2000) 12...</p> <p>d35x66mm c42mm 1f-d12mm</p>		<p><b>S1959</b> NO. 33321092247 - 33321137571</p> <p><b>SILENT-BLOC BRAÇO SUSPENSÃO TRÁS SUPERIOR PARTE INTERIOR</b></p> <p>BMW 3 Compact (E46) 316 ti (De 06.2002 Até 02.2005) 85kW 115cv 1596cm3 Hatchback - BMW 3 Compact (E46) 316 ti (De 06.2001 Até 02.2005) 85kW 115cv 1796cm3 Hatchback - BMW 3 Compact (E46) 318 td (De 03.2003 Até 02.2005) 85kW 115cv 1995cm3 Hatchback - BMW 3 Compact (E46) 318 ti (De 03.2001 Até 12.2004) 105kW 143cv 1995cm3 Hatchback - BMW 3 Compact (E46) 320 td (De 09.2001 Até 02.2005) 110kW 150cv 199...</p> <p>d35x66mm c42mm 1f-d12mm</p>
	<p><b>S1959</b> NO. 33321092247 - 33321137571</p> <p><b>SILENT-BLOC BRAÇO SUSPENSÃO TRÁS SUPERIOR PARTE INTERIOR</b></p> <p>BMW 3 Coupé (E46) 316 Ci (De 04.2000 Até 07.2006) 77kW 105cv 1596cm3 Coupé - BMW 3 Coupé (E46) 316 Ci (De 06.2002 Até 07.2006) 85kW 115cv 1596cm3 Coupé - BMW 3 Coupé (E46) 318 Ci (De 12.1999 Até 08.2001) 87kW 118cv 1895cm3 Coupé - BMW 3 Coupé (E46) 318 Ci (De 09.2001 Até 02.2004) 105kW 143cv 1995cm3 Coupé - BMW 3 Coupé (E46) 318 Ci (De 03.2004 Até 05.2006) 110kW 150cv 1995cm3 Coupé - BMW 3 Coupé (...)</p> <p>d35x66mm c42mm 1f-d12mm</p>		<p><b>S1959</b> NO. 33321092247 - 33321137571</p> <p><b>SILENT-BLOC BRAÇO SUSPENSÃO TRÁS SUPERIOR PARTE INTERIOR</b></p> <p>BMW 3 Touring (E46) 316 i (De 03.2002 Até 02.2005) 85kW 115cv 1796cm3 Combi - BMW 3 Touring (E46) 318 d (De 10.2002 Até 03.2003) 85kW 115cv 1951cm3 Combi - BMW 3 Touring (E46) 318 d (De 03.2003 Até 02.2005) 85kW 116cv 1995cm3 Combi - BMW 3 Touring (E46) 318 i (De 10.1999 Até 09.2001) 87kW 118cv 1895cm3 Combi - BMW 3 Touring (E46) 318 i (De 09.2001 Até 07.2005) 105kW 143cv 1995cm3 Combi - BMW 3 Tou...</p> <p>d35x66mm c42mm 1f-d12mm</p>
	<p><b>S2061</b> NO. 33171093565 - 33176751808 - 33316769376</p> <p><b>SILENT-BLOC DO EIXO SUSPENSÃO DE TRÁS</b></p> <p>BMW 3 (E46) 316 i (De 04.2000 Até 02.2005) 77kW 105cv 1596cm3 três volumes - BMW 3 (E46) 316 i (De 12.1998 Até 02.2002) 77kW 105cv 1895cm3 três volumes - BMW 3 (E46) 318 i (De 12.1997 Até 09.2001) 87kW 118cv 1895cm3 três volumes - BMW 3 (E46) 320 d (De 04.1998 Até 09.2001) 100kW 136cv 1951cm3 três volumes - BMW 3 (E46) 320 i (De 03.1998 Até 09.2000) 110kW 150cv 1990cm3 três volumes - BMW 3 (E46) 3...</p> <p>d68x60mm c55mm 1f-d18mm</p>		<p><b>S2061</b> NO. 33171093565 - 33176751808 - 33316769376</p> <p><b>SILENT-BLOC DO EIXO SUSPENSÃO DE TRÁS</b></p> <p>BMW 3 Coupé (E46) 318 Ci (De 12.1999 Até 08.2001) 87kW 118cv 1895cm3 Coupé - BMW 3 Coupé (E46) 320 Ci (De 02.1999 Até 08.2001) 110kW 150cv 1990cm3 Coupé - BMW 3 Touring (E46) 318 i (De 10.1999 Até 09.2001) 87kW 118cv 1895cm3 Combi - BMW 3 Touring (E46) 320 d (De 03.2000 Até 09.2001) 100kW 136cv 1951cm3 Combi - BMW 3 Touring (E46) 320 i (De 10.1999 Até 09.2000) 110kW 150cv 1990cm3 Combi - BMW 3 Tou...</p> <p>d68x60mm c55mm 1f-d18mm</p>
	<p><b>S2078</b> NO. 33171093175 - 33176770788</p> <p><b>SILENT-BLOC DA SUSPENSÃO EIXO TRASEIRO CENTRO</b></p> <p>BMW 3 (E46) 316 i (De 04.2000 Até 02.2005) 77kW 105cv 1596cm3 três volumes - BMW 3 (E46) 316 i (De 02.2002 Até 02.2005) 85kW 115cv 1796cm3 três volumes - BMW 3 (E46) 316 i (De 12.1998 Até 02.2002) 77kW 105cv 1895cm3 três volumes - BMW 3 (E46) 318 i (De 12.1997 Até 09.2001) 87kW 118cv 1895cm3 três volumes - BMW 3 (E46) 318 i (De 09.2001 Até 02.2005) 105kW 143cv 1995cm3 três volumes - BMW 3 (E46) 32...</p> <p>d47x47mm c40mm 1f-d12mm</p>		<p><b>S2079</b> NO. 33311092517 - 33316770781</p> <p><b>SILENT-BLOC DA SUSPENSÃO EIXO TRASEIRO AMBOS OS LADOS</b></p> <p>BMW 3 (E46) 316 i (De 04.2000 Até 02.2005) 77kW 105cv 1596cm3 três volumes - BMW 3 (E46) 316 i (De 02.2002 Até 02.2005) 85kW 115cv 1796cm3 três volumes - BMW 3 (E46) 316 i (De 12.1998 Até 02.2002) 77kW 105cv 1895cm3 três volumes - BMW 3 (E46) 318 i (De 12.1997 Até 09.2001) 87kW 118cv 1895cm3 três volumes - BMW 3 (E46) 318 i (De 09.2001 Até 02.2005) 105kW 143cv 1995cm3 três volumes - BMW 3 (E46) 3...</p> <p>d81x 63mm d74mm 1f-d20mm</p>
	<p><b>S2080</b> NO. 33311092516 - 33316757394 - 33316770784</p> <p><b>SILENT-BLOC DA SUSPENSÃO EIXO TRASEIRO LADO DIREITO</b></p> <p>BMW 3 (E46) 316 i (De 06.2002 Até 02.2005) 85kW 115cv 1596cm3 três volumes - BMW 3 (E46) 316 i (De 02.2002 Até 02.2005) 85kW 115cv 1796cm3 três volumes - BMW 3 (E46) 316 i (De 12.1998 Até 02.2002) 77kW 105cv 1895cm3 três volumes - BMW 3 (E46) 318 d (De 09.2001 Até 03.2003) 85kW 116cv 1951cm3 três volumes - BMW 3 (E46) 318 d (De 03.2003 Até 02.2005) 85kW 116cv 1995cm3 três volumes - BMW 3 (E46) 318...</p> <p>d81x 63mm d70mm 1f-d12mm</p>		<p><b>S2081</b> NO. 33311092515 - 33316757393 - 33316770783</p> <p><b>SILENT-BLOC DA SUSPENSÃO EIXO TRASEIRO LADO ESQUERDO</b></p> <p>BMW 3 (E46) 316 i (De 06.2002 Até 02.2005) 85kW 115cv 1596cm3 três volumes - BMW 3 (E46) 316 i (De 02.2002 Até 02.2005) 85kW 115cv 1796cm3 três volumes - BMW 3 (E46) 316 i (De 12.1998 Até 02.2002) 77kW 105cv 1895cm3 três volumes - BMW 3 (E46) 318 d (De 09.2001 Até 03.2003) 85kW 116cv 1951cm3 três volumes - BMW 3 (E46) 318 d (De 03.2003 Até 02.2005) 85kW 116cv 1995cm3 três volumes - BMW 3 (E46) 318 d (De 03.2003 Até 02.2005) 85kW 116cv 1995cm3 três volumes - BMW 3 (E46) 318...</p> <p>d82x 63mm d70mm 1f-d12mm</p>
	<p><b>T0627-I</b> NO. 31331094750 - 31336771380</p> <p><b>BATENTE SUSPENSÃO FRENTE</b></p> <p>BMW 3 (E46) 316 i 12.1998/02.2002 77KW 105CV 1895CC M43 B19 (194E1) 0005628 - BMW 3 (E46) 316 i 04.2000/02.2005 77KW 105CV 1596CC M43 B16 (164E3) 0005648 - BMW 3 (E46) 316 i 02.2002/02.2005 85KW 115CV 1796CC N46 B18 A N42 B18 A 0005754 - BMW 3 (E46) 318 d 09.2001/03.2003 85KW 116CV 1951CC M47 D20 (204D1) 0005725 - BMW 3 (E46) 318 i 12.1997/09.2001 87KW 118CV 1895CC M43 B19 (194E1) 0005622 0005642 ...</p> <p>d68x86mm 1f-d28mm 1f-d26mm</p>		<p><b>U7033K</b> NO. 61671378609 - 64500149356 - 64500301636 - 64501363572 - 64501466019 - 64501468463 - 64508390601</p> <p><b>ORINGS BOMBA DIREÇÃO ASSITIDA</b></p> <p>BMW 3 (E46) 316 i (04.2000 - 02.2005) 77kw 105cv 1596cm3 três volumes BMW 3 (E46) 316 i (12.1998 - 02.2002) 77kw 105cv 1895cm3 três volumes BMW 3 (E46) 318 d (09.2001 - 03.2003) 85kw 116cv 1951cm3 três volumes BMW 3 (E46) 318 d (03.2003 - 02.2005) 85kw 116cv 1995cm3 três volumes BMW 3 (E46) 320 d (04.1998 - 09.2001) 100kw 136cv 1951cm3 três volumes BMW 3 (E46) 320 d (09.2001 - 05.2005) 110kw 150cv...</p> <p>d11x2mm d10x2mm 1f-d7mm 1f-d6mm</p>
	<p><b>U7033K</b> NO. 61671378609 - 64500149356 - 64500301636 - 64501363572 - 64501466019 - 64501468463 - 64508390601</p> <p><b>ORINGS BOMBA DIREÇÃO ASSITIDA</b></p> <p>BMW 3 Cabriolet (E46) 320 Cd (02.2005 - 12.2007) 110kw 150cv 1995cm3 Cabriolet BMW 3 Cabriolet (E46) 320 Ci (09.2000 - 12.2007) 125kw 170cv 2171cm3 Cabriolet BMW 3 Cabriolet (E46) 323 Ci (04.2000 - 09.2000) 125kw 170cv 2494cm3 Cabriolet BMW 3 Cabriolet (E46) 325 Ci (09.2000 - 08.2006) 141kw 192cv 2494cm3 Cabriolet BMW 3 Cabriolet (E46) 330 Cd (08.2005 - 12.2007) 150kw 204cv 2993cm3 Cabriolet BMW ...</p> <p>d11x2mm d10x2mm 1f-d7mm 1f-d6mm</p>		<p><b>U7033K</b> NO. 61671378609 - 64500149356 - 64500301636 - 64501363572 - 64501466019 - 64501468463 - 64508390601</p> <p><b>ORINGS BOMBA DIREÇÃO ASSITIDA</b></p> <p>BMW 3 Coupé (E46) 316 Ci (04.2000 - 07.2006) 77kw 105cv 1596cm3 Coupé BMW 3 Coupé (E46) 318 Ci (12.1999 - 08.2001) 87kw 118cv 1895cm3 Coupé BMW 3 Coupé (E46) 320 Cd (11.2003 - 07.2006) 110kw 150cv 1995cm3 Coupé BMW 3 Coupé (E46) 320 Ci (02.1999 - 08.2001) 110kw 150cv 1990cm3 Coupé BMW 3 Coupé (E46) 320 Ci (01.2000 - 05.2006) 125kw 170cv 2171cm3 Coupé BMW 3 Coupé (E46) 323 Ci (04.1999 - 09.2000) 1...</p> <p>d11x2mm d10x2mm 1f-d7mm 1f-d6mm</p>
	<p><b>U7033K</b> NO. 61671378609 - 64500149356 - 64500301636 - 64501363572 - 64501466019 - 64501468463 - 64508390601</p> <p><b>ORINGS BOMBA DIREÇÃO ASSITIDA</b></p> <p>BMW 3 Touring (E46) 318 d (10.2002 - 03.2003) 85kw 115cv 1951cm3 Combi BMW 3 Touring (E46) 318 d (03.2003 - 02.2005) 85kw 116cv 1995cm3 Combi BMW 3 Touring (E46) 318 i (10.1999 - 09.2001) 87kw 118cv 1895cm3 Combi BMW 3 Touring (E46) 320 d (03.2000 - 09.2001) 100kw 136cv 1951cm3 Combi BMW 3 Touring (E46) 320 d (09.2001 - 02.2005) 110kw 150cv 1995cm3 Combi BMW 3 Touring (E46) 320 i (10.1999 - 09.2000)...</p> <p>d11x2mm d10x2mm 1f-d7mm 1f-d6mm</p>		<p><b>UAP81292</b> NO. 13532247156 - 2247156</p> <p><b>ANILHA PROTEÇÃO TÉRMICA INJECTORES</b></p> <p>BMW 3 (E46) 330 xd (De 09.2002 Até 12.2004) 150kW 204CV 2993cc três volumes BMW 3 (E90) 316 d (De 07.2009 Até 12.2011) 85kW 116CV 1995cc três volumes BMW 3 (E90) 318 d (De 02.2007 Até 10.2011) 105kW 143CV 1995cc três volumes BMW 3 (E90) 320 d (De 12.2004 Até 12.2011) 120kW 163CV 1995cc três volumes BMW 3 (E90) 320 d (De 09.2007 Até 03.2010) 130kW 177CV 1995cc três volumes BMW 3 (E90) 320 d xD...</p> <p>d16x1mm 1f-d7mm</p>



	<p><b>UAP81905</b> NO. 13532247156 - 2247156</p> <p><b>ANILHA PROTEÇÃO TÉRMICA INJECTORES</b></p> <p>BMW 3 (E46) 330 xd (De 09-2002 Até 12-2004) 150KW 204CV 2993cc três volumes - BMW 3 (E90) 316 d (De 07-2009 Até 12-2011) 85KW 116CV 1995cc três volumes - BMW 3 (E90) 318 d (De 02-2007 Até 10-2011) 105KW 143CV 1995cc três volumes - BMW 3 (E90) 320 d (De 12-2004 Até 12-2011) 120KW 163CV 1995cc três volumes - BMW 3 (E90) 320 d (De 09-2007 Até 03-2010) 130KW 177CV 1995cc três volumes - BMW 3 (E90) 320 d xD...</p> <p>d14x1mm      1f-d7mm</p>		<p><b>UAP83244</b> NO. 13537785722</p> <p><b>ANILHA PROTEÇÃO TÉRMICA INJECTORES</b></p> <p>BMW 3 (E46) 330 d (De 10-1999 Até 02-2005) 135KW 184CV 2926cc três volumes - BMW 3 (E46) 330 xd (De 01-2000 Até 02-2003) 135KW 184CV 2926cc três volumes - BMW 3 Touring (E46) 330 d (De 10-1999 Até 02-2005) 135KW 184CV 2926cc Combi - BMW 3 Touring (E46) 330 xd (De 01-2000 Até 03-2003) 135KW 184CV 2926cc Combi</p> <p>d15x2mm      1f-d7mm</p>
	<p><b>UFQ23302</b> NO. 21511223302</p> <p><b>FORQUILHA DA EMBRAIAGEM</b></p> <p>BMW 3 (E46) 320 d 04.1998/09.2001 100KW 136CV 1951CC M47 D20 (204D1) 0005624 - BMW 3 (E46) 320 d 09.2001/05.2005 110KW 150CV 1995CC M47 D20 (204D4) 0005737 - BMW 3 (E46) 320 i 03.1998/09.2000 110KW 150CV 1990CC M52 B20 (206S4) 0005625 - BMW 3 (E46) 320 i 09.2000/02.2005 125KW 170CV 2171CC M54 B22 (226S1) 0005704 - BMW 3 (E46) 323 i 03.1998/09.2000 125KW 170CV 2494CC M52 B25 (256S4) 0005626 - BMW 3...</p> <p>252x83x28mm      1f-47x75mm</p>		<p><b>UFQ23302</b> NO. 21511223302</p> <p><b>FORQUILHA DA EMBRAIAGEM</b></p> <p>BMW 3 Cabriolet (E46) 320 Cd 02.2005/12.2007 110KW 150CV 1995CC M47 D20 (204D4) 0005815 0005AEK - BMW 3 Cabriolet (E46) 320 Ci 09.2000/12.2007 125KW 170CV 2171CC M54 B22 (226S1) 0005701 0005AEG - BMW 3 Cabriolet (E46) 323 Ci 04.2000/09.2000 125KW 170CV 2494CC M52 B25 (256S4) 0005675 - BMW 3 Cabriolet (E46) 325 Ci 09.2000/08.2006 141KW 192CV 2494CC M54 B25 (256S5) 0005703 0005AEL - BMW 3 Cabriolet ...</p> <p>252x83x28mm      1f-47x75mm</p>
	<p><b>UFQ23302</b> NO. 21511223302</p> <p><b>FORQUILHA DA EMBRAIAGEM</b></p> <p>BMW 3 Touring (E46) 320 d 03.2000/09.2001 100KW 136CV 1951CC M47 D20 (204D1) 0005659 - BMW 3 Touring (E46) 320 d 09.2001/02.2005 110KW 150CV 1995CC M47 D20 (204D4) 0005738 - BMW 3 Touring (E46) 320 i 10.1999/09.2000 110KW 150CV 1990CC M52 B20 (206S4) 0005660 - BMW 3 Touring (E46) 320 i 09.2000/02.2005 125KW 170CV 2171CC M54 B22 (226S1) 0005705 - BMW 3 Touring (E46) 323 i 10.1999/12.2000 125KW 170CV...</p> <p>252x83x28mm      1f-47x75mm</p>		<p><b>UMB84029</b> NO. 07119937320 - 11111276472 - 11111717939 - 1717939 - 9937321</p> <p><b>TAMPÃO BLOCO MOTOR</b></p> <p>BMW 3 (E46) 316 i (De 09-1998 Até 02-2005) 77kW 105CV 1895cc três volumes - BMW 3 (E46) 318 i (De 02-1998 Até 09-2001) 87kW 118CV 1895cc três volumes - BMW 3 Coupé (E46) 316 Ci (De 04-2000 Até 07-2006) 77kW 105CV 1596cc Coupé - BMW 3 Coupé (E46) 318 Ci (De 11-1999 Até 09-2001) 87kW 118CV 1895cc Coupé - BMW 3 Touring (E46) 318 i (De 10-1999 Até 09-2001) 87kW 118CV 1895cc Combi</p> <p>d36x10mm      di-32mm</p>
	<p><b>UMV25106</b> NO. 25117503100 - 25117566267</p> <p><b>MANETE PUNHO TOPO ALAVANCA MUDANÇAS 5 VELOCIDADES F14MM</b></p> <p>BMW 3 (E46) 320 d 04.1998/09.2001 100KW 136CV 1951CC M47 D20 (204D1) 0005624 - BMW 3 (E46) 320 d 09.2001/05.2005 110KW 150CV 1995CC M47 D20 (204D4) 0005737 - BMW 3 (E46) 330 d 10.1999/02.2005 135KW 184CV 2926CC M57 D30 (306D1) 0005662 - BMW 3 (E46) 330 d 03.2003/02.2005 150KW 204CV 2993CC M57 D30 (306D2) 0005768 - BMW 3 (E46) 330 xd 01.2000/02.2003 135KW 184CV 2926CC M57 D30 (306D1) 0005712 - BMW ...</p> <p>95x45x55mm      1f-d14mm</p>		<p><b>UMV25106</b> NO. 25117503100 - 25117566267</p> <p><b>MANETE PUNHO TOPO ALAVANCA MUDANÇAS 5 VELOCIDADES F14MM</b></p> <p>BMW 3 Cabriolet (E46) 320 Cd 02.2005/12.2007 110KW 150CV 1995CC M47 D20 (204D4) 0005815 0005AEK - BMW 3 Cabriolet (E46) 330 Cd 08.2005/12.2007 150KW 204CV 2993CC M57 D30 (306D2) 0005842 0005AEM - BMW 3 Cabriolet (E46) 330 Ci 06.2000/08.2006 170KW 231CV 2979CC M54 B30 (306S3) 0005682 0005AEI</p> <p>95x45x55mm      1f-d14mm</p>
	<p><b>UMV25106</b> NO. 25117503100 - 25117566267</p> <p><b>MANETE PUNHO TOPO ALAVANCA MUDANÇAS 5 VELOCIDADES F14MM</b></p> <p>BMW 3 Compact (E46) 320 td 09.2001/02.2005 110KW 150CV 1995CC M47 D20 (204D4) 0005720 - BMW 3 Compact (E46) 325 ti 04.2001/12.2004 141KW 192CV 2494CC M54 B25 (256S5) 0005717</p> <p>95x45x55mm      1f-d14mm</p>		<p><b>UMV25106</b> NO. 25117503100 - 25117566267</p> <p><b>MANETE PUNHO TOPO ALAVANCA MUDANÇAS 5 VELOCIDADES F14MM</b></p> <p>BMW 3 Coupé (E46) 320 Cd 11.2003/07.2006 110KW 150CV 1995CC M47 D20 (204D4) 0005763 0005AEV - BMW 3 Coupé (E46) 330 Cd 03.2003/07.2006 150KW 204CV 2993CC M57 D30 (306D2) 0005764 0005AET - BMW 3 Coupé (E46) 330 Ci 06.2000/05.2006 170KW 231CV 2979CC M54 B30 (306S3) 0005683 0005AER - BMW 3 Coupé (E46) 330 xi 06.2000/07.2006 170KW 231CV 2979CC M54 B30 (306S3)</p> <p>95x45x55mm      1f-d14mm</p>
	<p><b>UMV25106</b> NO. 25117503100 - 25117566267</p> <p><b>MANETE PUNHO TOPO ALAVANCA MUDANÇAS 5 VELOCIDADES F14MM</b></p> <p>BMW 3 Touring (E46) 320 d 03.2000/09.2001 100KW 136CV 1951CC M47 D20 (204D1) 0005659 - BMW 3 Touring (E46) 320 d 09.2001/02.2005 110KW 150CV 1995CC M47 D20 (204D4) 0005738 - BMW 3 Touring (E46) 330 d 10.1999/02.2005 135KW 184CV 2926CC M57 D30 (306D1) 0005661 - BMW 3 Touring (E46) 330 d 03.2003/02.2005 150KW 204CV 2993CC M57 D30 (306D2) 0005769 - BMW 3 Touring (E46) 330 i 06.2000/02.2005 170KW 231CV...</p> <p>95x45x55mm      1f-d14mm</p>		<p><b>UMV25110</b> NO. 25111434495 - 25117500299 - 25117503231 - 25117523817 - 25117544524</p> <p><b>MANETE PUNHO TOPO ALAVANCA MUDANÇAS 5 VELOCIDADES NAPEL F14MM</b></p> <p>BMW 3 (E46) 316 i 04.2000/02.2005 77KW 105CV 1596CC - BMW 3 (E46) 316 i 06.2002/02.2005 85KW 115CV 1596CC - BMW 3 (E46) 316 i 12.1998/02.2002 77KW 105CV 1895CC - BMW 3 (E46) 320 i 03.1998/09.2000 110KW 150CV 1990CC - BMW 3 (E46) 320 i 09.2000/02.2005 125KW 170CV 2171CC - BMW 3 (E46) 323 i 03.1998/09.2000 125KW 170KW 2494CC - BMW 3 (E46) 325 i 09.2000/02.2005 141KW 192CV 2494CC - BMW 3 (E46)...</p> <p>d51x91mm      1f-d14mm</p>
	<p><b>UMV25111</b> NO. 25111434495 - 25117500299 - 25117503231 - 25117523817 - 25117544524</p> <p><b>MANETE PUNHO TOPO ALAVANCA MUDANÇAS 6 VELOCIDADES F14MM</b></p> <p>BMW 3 (E46) 316 i 04.2000/02.2005 77KW 105CV 1596CC - BMW 3 (E46) 316 i 06.2002/02.2005 85KW 115CV 1596CC - BMW 3 (E46) 316 i 12.1998/02.2002 77KW 105CV 1895CC - BMW 3 (E46) 320 i 03.1998/09.2000 110KW 150CV 1990CC - BMW 3 (E46) 320 i 09.2000/02.2005 125KW 170CV 2171CC - BMW 3 (E46) 323 i 03.1998/09.2000 125KW 170KW 2494CC - BMW 3 (E46) 325 i 09.2000/02.2005 141KW 192CV 2494CC - BMW 3 (E46)...</p> <p>d46x91mm      1f-d14mm</p>		<p><b>UMV25113</b> NO. 25112229442 - 25117566267 - 25117833136 - 25118037305</p> <p><b>MANETE PUNHO TOPO ALAVANCA MUDANÇAS 6 VELOCIDADES F14MM</b></p> <p>BMW 3 (E46) 320 d 04.1998/09.2001 100KW 136CV 1951CC M47 D20 (204D1) 0005624 - BMW 3 (E46) 320 d 09.2001/05.2005 110KW 150CV 1995CC M47 D20 (204D4) 0005737 - BMW 3 (E46) 330 d 10.1999/02.2005 135KW 184CV 2926CC M57 D30 (306D1) 0005662 - BMW 3 (E46) 330 d 03.2003/02.2005 150KW 204CV 2993CC M57 D30 (306D2) 0005768 - BMW 3 (E46) 330 i 06.2000/02.2005 170KW 231CV 2979CC M54 B30 (306S3) 0005684 - BMW 3...</p> <p>95x54x45mm      1f-d14mm</p>
	<p><b>UMV25114</b> NO. 25111434495 - 25117500299 - 25117503231 - 25117523817 - 25117544524</p> <p><b>MANETE PUNHO TOPO ALAVANCA MUDANÇAS 5 VELOCIDADES F14MM</b></p> <p>BMW 3 (E46) 316 i 04.2000/02.2005 77KW 105CV 1596CC - BMW 3 (E46) 316 i 06.2002/02.2005 85KW 115CV 1596CC - BMW 3 (E46) 316 i 12.1998/02.2002 77KW 105CV 1895CC - BMW 3 (E46) 320 i 03.1998/09.2000 110KW 150CV 1990CC - BMW 3 (E46) 320 i 09.2000/02.2005 125KW 170CV 2171CC - BMW 3 (E46) 323 i 03.1998/09.2000 125KW 170CV 2494CC - BMW 3 (E46) 325 i 09.2000/02.2005 141KW 192CV 2494CC - BMW 3 (E46)...</p> <p>d56x94mm      1f-d14mm</p>		<p><b>UMV25127</b> NO. 25112229442 - 25117566267 - 25117833136 - 25118037305</p> <p><b>MANETE PUNHO TOPO ALAVANCA MUDANÇAS 5 VELOCIDADES F14MM</b></p> <p>BMW 3 (E46) 320 d (De 04.1998 Até 09.2001) 100kW 136cv 1951cm3 três volumes - BMW 3 (E46) 320 d (De 09.2001 Até 05.2005) 110KW 150cv 1995cm3 três volumes - BMW 3 (E46) 330 d (De 10.1999 Até 02.2005) 135kW 184cv 2926cm3 três volumes - BMW 3 (E46) 330 d (De 03.2003 Até 02.2005) 150kW 204cv 2993cm3 três volumes - BMW 3 (E46) 330 xd (De 01.2000 Até 02.2003) 135kW 184cv 2926cm3 três volumes - BMW 3 (E...)</p> <p>d46x94mm      1f-d14mm</p>





	<p><b>UMV26815</b> NO. 25111434495 - 25111434719</p> <p>MANETE PUNHO TOPO ALAVANCA MUDANÇAS 5 VELOCIDADES F13MM BMW E46</p>		<p><b>UMV26816</b> NO. 25112229442 - 25117566267 - 25117833136 - 25118037305</p> <p>MANETE PUNHO TOPO ALAVANCA MUDANÇAS 6 VELOCIDADES F13MM BMW E46</p>
	<p><b>UMV26820</b> NO. 2511222280 - 25111434495 - 25112229183</p> <p>MANETE PUNHO TOPO ALAVANCA MUDANÇAS 5 VELOCIDADES F14MM</p> <p>BMW 3 (E46): 316 i 04.2000/02.2005 77KW 105CV 1596CC - BMW 3 (E46): 316 i 06.2002/02.2005 85KW 115CV 1596CC - BMW 3 (E46): 316 i 12.1998/02.2002 77KW 105CV 1895CC - BMW 3 (E46): 320 i 03.1998/09.2000 110KW 150CV 1990CC - BMW 3 (E46): 320 i 09.2000/02.2005 125KW 170CV 2171CC - BMW 3 (E46): 323 i 03.1998/09.2000 125KW 170KW 2494CC - BMW 3 (E46): 325 i 09.2000/02.2005 141KW 192CV 2494CC - BMW 3 (E46)...</p>		<p><b>UMV26822</b> NO. 25111434495 - 25117500299 - 25117503231 - 25117523817 - 25117544524</p> <p>MANETE PUNHO TOPO ALAVANCA MUDANÇAS 5 VELOCIDADES F15MM</p> <p>BMW 3 (E46): 316 i 04.2000/02.2005 77KW 105CV 1596CC - BMW 3 (E46): 316 i 06.2002/02.2005 85KW 115CV 1596CC - BMW 3 (E46): 316 i 12.1998/02.2002 77KW 105CV 1895CC - BMW 3 (E46): 320 i 03.1998/09.2000 110KW 150CV 1990CC - BMW 3 (E46): 320 i 09.2000/02.2005 125KW 170CV 2171CC - BMW 3 (E46): 323 i 03.1998/09.2000 125KW 170KW 2494CC - BMW 3 (E46): 325 i 09.2000/02.2005 141KW 192CV 2494CC - BMW 3 (E46)...</p>
	<p><b>UMV26826</b> NO. 25111221290 - 25111434494 - 25111434495</p> <p>MANETE PUNHO TOPO ALAVANCA MUDANÇAS 5 VELOCIDADES F12MM C/LUZ</p> <p>BMW 3 (E46) 316 i 12.1998/02.2002 77KW 105CV 1895CC M43 B19 (194E1) 0005628 - BMW 3 (E46) 316 i 04.2000/02.2005 77KW 105CV 1596CC M43 B16 (164E3) 0005648 - BMW 3 (E46) 316 i 02.2002/02.2005 85KW 115CV 1796CC N46 B18 A N42 B18 A 0005754 - BMW 3 (E46) 316 i 06.2002/02.2005 85KW 115CV 1596CC N40 B16 A N45 B16 A 0005741 - BMW 3 (E46) 318 d 09.2001/03.2003 85KW 116CV 1951CC M47 D20 (204D1) 0005725 - BM...</p>		<p><b>UMV26826</b> NO. 25111221290 - 25111434494 - 25111434495</p> <p>MANETE PUNHO TOPO ALAVANCA MUDANÇAS 5 VELOCIDADES F12MM C/LUZ</p> <p>BMW 3 Cabriolet (E46) 316 i (De 09.2001 Até 12.2007) 105kW 143cv 1995cm3 Cabriolet - BMW 3 Cabriolet (E46) 320 Ci (De 09.2000 Até 12.2007) 125kW 170cv 2171cm3 Cabriolet - BMW 3 Cabriolet (E46) 323 Ci (De 04.2000 Até 09.2000) 125kW 170cv 2494cm3 Cabriolet -</p>
	<p><b>UMV26826</b> NO. 25111221290 - 25111434494 - 25111434495</p> <p>MANETE PUNHO TOPO ALAVANCA MUDANÇAS 5 VELOCIDADES F12MM C/LUZ</p> <p>BMW 3 Compact (E46) 316 ti (De 06.2002 Até 02.2005) 85KW 115cv 1596cm3 Hatchback - BMW 3 Compact (E46) 316 ti (De 06.2001 Até 02.2005) 85KW 115cv 1796cm3 Hatchback - BMW 3 Compact (E46) 318 td (De 03.2003 Até 02.2005) 85KW 115cv 1995cm3 Hatchback - BMW 3 Compact (E46) 318 ti (De 03.2001 Até 12.2004) 105kW 143cv 1995cm3 Hatchback - BMW 3 Compact (E46) 320 td (De 09.2001 Até 02.2005) 110kW 150cv 199...</p>		<p><b>UMV26826</b> NO. 25111221290 - 25111434494 - 25111434495</p> <p>MANETE PUNHO TOPO ALAVANCA MUDANÇAS 5 VELOCIDADES F12MM C/LUZ</p> <p>BMW 3 Touring (E46) 316 i (De 03.2002 Até 02.2005) 85KW 115cv 1796cm3 Combi - BMW 3 Touring (E46) 318 d (De 10.2002 Até 03.2003) 85KW 115cv 1951cm3 Combi - BMW 3 Touring (E46) 318 d (De 03.2003 Até 02.2005) 85KW 116cv 1995cm3 Combi - BMW 3 Touring (E46) 318 i (De 09.2001 Até 07.2005) 105kW 143cv 1995cm3 Combi - BMW 3 Touring (E46) 318 i (De 10.1999 Até 09.2001) 87kW 118cv 1895cm3 Combi - BMW 3 Tou...</p>
	<p><b>UMV26829</b> NO. 25119416257</p> <p>MANETE PUNHO TOPO ALAVANCA MUDANÇAS 6 VELOCIDADES F14MM BMW SERIE 3 (E46)</p>		<p><b>W5057</b> NO. 0614602 - 0614602 - 11232247886 - 11232247890 - 614602 - 93171365 - LHG000100</p> <p>POLIE DA CAMBOTA (5 + 5 PISTAS)</p> <p>BMW SERIE 3 E46 330D 330 XD (10-1999 A 02-2005 Mtr M57D30 (184CV))</p>
	<p><b>W5058</b> NO. 11237787304 - 11237787326 - 11237790921 - 11237790922 - 11237793882 - 11237801977 - 11237805686</p> <p>POLIE DA CAMBOTA (6 + 4 PISTAS)</p> <p>BMW SERIE 3 E46 318D APÓS 06-2004 Mtr M47N20 (116CV) BMW SERIE 3 (E46) 320D APÓS 06-2004 Mtr M47N20 (150CV)</p>		<p><b>W5072</b> NO. 11232247260 - 11232247565 - 11232248268</p> <p>POLIE DA CAMBOTA (5 + 5 PISTAS)</p> <p>BMW E46 318 D - 320 D</p>
	<p><b>W5099</b> NO. 11232247932 - 11237786611 - 11237786611 - 11237793593 - 11238511371</p> <p>POLIE DA CAMBOTA (4+6 PISTAS)</p> <p>BMW 3 (E46) 330 d 03.2003/02.2005 150KW 204CV 2993CC M57 D30 (306D2) 0005768 - BMW 3 (E46) 330 xd 09.2002/12.2004 150KW 204CV 2993CC M57 D30 (306D2) 0005770 - BMW 3 Cabriolet (E46) 330 Cd 08.2005/12.2007 150KW 204CV 2993CC M57 D30 (306D2) 0005842, 0005AEM - BMW 3 Coupé (E46) 330 Cd 03.2003/07.2006 150KW 204CV 2993CC M57 D30 (306D2) 0005764, 0005AET - BMW 3 Touring (E46) 330 d 03.2003/02.2005 150KW...</p>		<p><b>W5099-C</b> NO. 11237788611 - 11237793593</p> <p>POLIE DA CAMBOTA (4+6 PISTAS)</p> <p>BMW 3 (E46) 330 d 03.2003/02.2005 150KW 204CV 2993CC M57 D30 (306D2) 0005768 - BMW 3 (E46) 330 xd 09.2002/12.2004 150KW 204CV 2993CC M57 D30 (306D2) 0005770 - BMW 3 Cabriolet (E46) 330 Cd 08.2005/12.2007 150KW 204CV 2993CC M57 D30 (306D2) 0005842, 0005AEM - BMW 3 Coupé (E46) 330 Cd 03.2003/07.2006 150KW 204CV 2993CC M57 D30 (306D2) 0005764, 0005AET - BMW 3 Touring (E46) 330 d 03.2003/02.2005 150KW...</p>
	<p><b>W5225</b> NO. 32417787106</p> <p>POLIE DA BOMBA HIDRÁULICA</p> <p>BMW 3 (E46) 330 d 03.2003/02.2005 150KW 204CV 2993CC M57 D30 (306D2) 0005768 - BMW 3 (E46) 330 xd 09.2002/12.2004 150KW 204CV 2993CC M57 D30 (306D2) 0005770 - BMW 3 Cabriolet (E46) 330 Cd 08.2005/12.2007 150KW 204CV 2993CC M57 D30 (306D2) 0005842 0005AEM</p>		<p><b>W5225</b> NO. 32417787106</p> <p>POLIE DA BOMBA HIDRÁULICA</p> <p>BMW 3 Coupé (E46) 330 Cd 03.2003/07.2006 150KW 204CV 2993CC M57 D30 (306D2) 0005764 0005AET</p>

	<p><b>W5225</b> NO. 32417787106</p> <p>POLIE DA BOMBA HIDRÁULICA</p> <p>BMW 3 Touring (E46) 330 d 03.2003/02.2005 150KW 204CV 2993CC M57 D30 (306D2) 0005769 - BMW 3 Touring (E46) 330 xd 08.2002/05.2005 150KW 204CV 2993CC M57 D30 (306D2) 0005771</p> <p>d143x28mm 1f-d30mm 3f-d8mm</p>		<p><b>Y3239</b> NO. 36130141574 - 36130141576 - 36131095390 - 36131116717 - 36131117190 - 36131126191</p> <p>PARAFUSO PERNO RODA CHAVE 17 M12X1,50X50MM ( BASE CONICA )</p> <p>BMW 3 (E46) 316 i 12.1998/02.2002 77KW 105CV 1895CC M43 B19 (194E1) 0005628 - BMW 3 (E46) 316 i 02.2002/02.2005 85KW 115CV 1796CC N46 B18 A N42 B18 A 0005754 - BMW 3 (E46) 318 d 09.2001/03.2003 85KW 116CV 1951CC M47 D20 (204D1) 0005725 - BMW 3 (E46) 318 d 03.2003/02.2005 85KW 116CV 1995CC M47 D20 (204D4) 0005766 - BMW 3 (E46) 318 i 12.1997/09.2001 87KW 118CV 1895CC M43 B19 (194E1) 0005622 0005642 ...</p> <p>c51mm (ch-17mm) M12x1x24mm</p>
	<p><b>Y3239</b> NO. 36130141574 - 36130141576 - 36131095390 - 36131116717 - 36131117190 - 36131126191</p> <p>PARAFUSO PERNO RODA CHAVE 17 M12X1,50X50MM ( BASE CONICA )</p> <p>BMW 3 Cabriolet (E46) 318 Ci 09.2001/12.2007 105KW 143CV 1995CC N46 B20 A N42 B20 A 0005727 - BMW 3 Cabriolet (E46) 320 Ci 09.2000/12.2007 125KW 170CV 2171CC M54 B22 (226S1) 0005701 0005AEG - BMW 3 Cabriolet (E46) 323 Ci 04.2000/09.2000 125KW 170CV 2494CC M52 B25 (256S4) 0005675 - BMW 3 Cabriolet (E46) 325 Ci 09.2000/08.2006 141KW 192CV 2494CC M54 B25 (256S5) 0005703 0005AEL - BMW 3 Cabriolet (E46)...</p> <p>c51mm (ch-17mm) M12x1x24mm</p>		<p><b>Y3239</b> NO. 36130141574 - 36130141576 - 36131095390 - 36131116717 - 36131117190 - 36131126191</p> <p>PARAFUSO PERNO RODA CHAVE 17 M12X1,50X50MM ( BASE CONICA )</p> <p>BMW 3 Coupé (E46) 316 Ci 04.2000/07.2006 77KW 105CV 1596CC M43 B16 (164E3) 0005665 - BMW 3 Coupé (E46) 316 Ci 06.2002/07.2006 85KW 115CV 1596CC N45 B16 A 0005742 0005AEW - BMW 3 Coupé (E46) 318 Ci 12.1999/08.2001 87KW 118CV 1895CC M43 B19 (194E1) 0005657 - BMW 3 Coupé (E46) 318 Ci 09.2001/02.2004 105KW 143CV 1995CC N42 B20 A 0005729 - BMW 3 Coupé (E46) 318 Ci 03.2004/05.2006 110KW 150CV 1995CC N46...</p> <p>c51mm (ch-17mm) M12x1x24mm</p>
	<p><b>Y3239</b> NO. 36130141574 - 36130141576 - 36131095390 - 36131116717 - 36131117190 - 36131126191</p> <p>PARAFUSO PERNO RODA CHAVE 17 M12X1,50X50MM ( BASE CONICA )</p> <p>BMW 3 Touring (E46) 316 i 03.2002/02.2005 85KW 115CV 1796CC N42 B18 A N46 B18 A 0005755 - BMW 3 Touring (E46) 318 d 10.2002/03.2003 85KW 115CV 1951CC M47 D20 (204D1) 0005726 - BMW 3 Touring (E46) 318 d 03.2003/02.2005 85KW 116CV 1995CC M47 D20 (204D4) 0005767 - BMW 3 Touring (E46) 318 i 10.1999/09.2001 87KW 118CV 1895CC M43 B19 (194E1) 0005653 - BMW 3 Touring (E46) 318 i 09.2001/07.2005 105KW 143CV...</p> <p>c51mm (ch-17mm) M12x1x24mm</p>		<p><b>Z55278</b> NO. 51410407983 - 51418224781 - 51430141025</p> <p>MOLA PAINEL RESVESTIMENTO PORTAS</p> <p>BMW 3 (E46) 316 i (04.2000 - 02.2005) 77kw 105cv 1596cm3 três volumes BMW 3 (E46) 316 i (06.2002 - 02.2005) 85kw 115cv 1596cm3 três volumes BMW 3 (E46) 316 i (02.2002 - 02.2005) 85kw 115cv 1796cm3 três volumes BMW 3 (E46) 316 i (12.1998 - 02.2002) 77kw 105cv 1895cm3 três volumes BMW 3 (E46) 318 d (09.2001 - 03.2003) 85kw 116cv 1951cm3 três volumes BMW 3 (E46) 318 d (03.2003 - 02.2005) 85kw 116cv 1...</p> <p>F-8T-18mm L-14H-21S1-7mm</p>
	<p><b>Z55278</b> NO. 51410407983 - 51418224781 - 51430141025</p> <p>MOLA PAINEL RESVESTIMENTO PORTAS</p> <p>BMW 3 Cabriolet (E46) 318 Ci (09.2001 - 12.2007) 105kw 143cv 1995cm3 Cabriolet BMW 3 Cabriolet (E46) 318 Ci (03.2004 - 08.2006) 110kw 150cv 1995cm3 Cabriolet BMW 3 Cabriolet (E46) 320 Cd (02.2005 - 12.2007) 110kw 150cv 1995cm3 Cabriolet BMW 3 Cabriolet (E46) 320 Ci (09.2000 - 12.2007) 125kw 170cv 2171cm3 Cabriolet BMW 3 Cabriolet (E46) 323 Ci (04.2000 - 09.2000) 125kw 170cv 2494cm3 Cabriolet BMW 3...</p> <p>F-8T-18mm L-14H-21S1-7mm</p>		<p><b>Z55278</b> NO. 51410407983 - 51418224781 - 51430141025</p> <p>MOLA PAINEL RESVESTIMENTO PORTAS</p> <p>BMW 3 Coupé (E46) 316 Ci (06.2002 - 07.2006) 85kw 115cv 1596cm3 Coupé BMW 3 Coupé (E46) 316 Ci (04.2000 - 07.2006) 77kw 105cv 1596cm3 Coupé BMW 3 Coupé (E46) 318 Ci (12.1999 - 08.2001) 87kw 118cv 1895cm3 Coupé BMW 3 Coupé (E46) 318 Ci (09.2001 - 02.2004) 105kw 143cv 1995cm3 Coupé BMW 3 Coupé (E46) 318 Ci (03.2004 - 05.2006) 110kw 150cv 1995cm3 Coupé BMW 3 Coupé (E46) 320 Cd (11.2003 - 07.2006) 110...</p> <p>F-8T-18mm L-14H-21S1-7mm</p>
	<p><b>Z55278</b> NO. 51410407983 - 51418224781 - 51430141025</p> <p>MOLA PAINEL RESVESTIMENTO PORTAS</p> <p>BMW 3 Touring (E46) 316 i (03.2002 - 02.2005) 85kw 115cv 1796cm3 Combi BMW 3 Touring (E46) 318 d (10.2002 - 03.2003) 85kw 115cv 1951cm3 Combi BMW 3 Touring (E46) 318 d (03.2003 - 02.2005) 85kw 116cv 1995cm3 Combi BMW 3 Touring (E46) 318 i (10.1999 - 09.2001) 87kw 118cv 1895cm3 Combi BMW 3 Touring (E46) 318 i (09.2001 - 07.2005) 105kw 143c 1995cm3 Combi BMW 3 Touring (E46) 320 d (03.2000 - 09.2001)...</p> <p>F-8T-18mm L-14H-21S1-7mm</p>		<p><b>Z71231</b> NO. 51718184574</p> <p>MOLA DE FIXAÇÃO MOLDURA DE PORTA</p> <p>BMW 3 (E46) 316 i 12.1998/02.2002 77KW 105CV 1895CC M43 B19 (194E1) 0005628 - BMW 3 (E46) 316 i 04.2000/02.2005 77KW 105CV 1596CC M43 B16 (164E3) 0005648 - BMW 3 (E46) 316 i 02.2002/02.2005 85KW 115CV 1796CC N46 B18 A N42 B18 A 0005754 - BMW 3 (E46) 316 i 06.2002/02.2005 85KW 115CV 1596CC N40 B16 A N45 B16 A 0005741 - BMW 3 (E46) 318 d 09.2001/03.2003 85KW 116CV 1951CC M47 D20 (204D1) 0005725 - BM...</p> <p>32x20x9mm 1p-d4x9mm</p>
	<p><b>Z80726</b> NO. 51131960054</p> <p>Mola de friso</p> <p>BMW 3 (E46) 316 i 12.1998/02.2002 77KW 105CV 1895CC M43 B19 (194E1) 0005628 - BMW 3 (E46) 316 i 04.2000/02.2005 77KW 105CV 1596CC M43 B16 (164E3) 0005648 - BMW 3 (E46) 316 i 02.2002/02.2005 85KW 115CV 1796CC N46 B18 A N42 B18 A 0005754 - BMW 3 (E46) 316 i 06.2002/02.2005 85KW 115CV 1596CC N40 B16 A N45 B16 A 0005741 - BMW 3 (E46) 318 d 09.2001/03.2003 85KW 116CV 1951CC M47 D20 (204D1) 0005725 - BM...</p> <p>35x22,5x21,7mm</p>		<p><b>Z80849</b> NO. 51411973500 - 99950758240</p> <p>Mola de painel</p> <p>BMW SÉRIE 3(E46)</p> <p>d18x21mm 1p-d9-13mm</p>
	<p><b>Z80879</b> NO. 51138231130 - 8231130</p> <p>MOLA FRISO LATERAL PORTA</p> <p>BMW 3 (E46) 316 i 12.1998/02.2002 77KW 105CV 1895CC M43 B19 (194E1) 0005628 - BMW 3 (E46) 316 i 04.2000/02.2005 77KW 105CV 1596CC M43 B16 (164E3) 0005648 - BMW 3 (E46) 316 i 02.2002/02.2005 85KW 115CV 1796CC N46 B18 A N42 B18 A 0005754 - BMW 3 (E46) 316 i 06.2002/02.2005 85KW 115CV 1596CC N40 B16 A N45 B16 A 0005741 - BMW 3 (E46) 318 d 09.2001/03.2003 85KW 116CV 1951CC M47 D20 (204D1) 0005725 - BM...</p> <p>35x20,5mm 1p-7,5x8-9mm</p>		

	<p><b>A2270</b> NO. 22114038372</p> <p><b>APOIO DO MOTOR LADO DIREITO</b></p> <p>BMW 3 (E90) 325 d (De 2006.09 Até 2010.02) 145kW 197cv 2993cm3 três volumes -                      BMW 3 (E90) 330 d (De 2005.09 Até 2008.09) 170kW 231cv 2993cm3 três volumes -                      BMW 3 (E90) 330 d (De 2008.09 Até 2011.10) 180kW 245cv 2993cm3 três volumes -                      BMW 3 (E90) 335 d (De 2006.09 Até 2011.12) 210kW 286cv 2993cm3 três volumes -</p> <p>149x111x134mm 2r-d8mm 1r-d6mm 1p-d10x26mm</p>		<p><b>A2271</b> NO. 22114038371 - 221167732347</p> <p><b>APOIO DO MOTOR LADO ESQUERDO</b></p> <p>BMW 3 (E90) 325 d (De 2006.09 Até 2010.02) 145kW 197cv 2993cm3 três volumes -                      BMW 3 (E90) 330 d (De 2005.09 Até 2008.09) 170kW 231cv 2993cm3 três volumes -                      BMW 3 (E90) 330 d (De 2008.09 Até 2011.10) 180kW 245cv 2993cm3 três volumes -                      BMW 3 (E90) 335 d (De 2006.09 Até 2011.12) 210kW 286cv 2993cm3 três volumes -</p> <p>149x111x134mm 2r-d8mm 1r-d6mm 1p-d10x26mm</p>
	<p><b>D0022</b> NO. 26111209168 - 26111227420 - 26111227717 - 26111229080 - 26111229360 - 26117511454</p> <p><b>CARDAN TRANSMISSÃO D135X30MM 6 FUROS 12MM ENTRE FUROS 96MM</b></p> <p>BMW 3 (E90) 316 d 07.2009/12.2011 85KW 116CV 1995CC N47 D20 C 0005AQL 0005AVU - BMW 3 (E90) 316 i 09.2005/10.2011 85KW 115CV 1596CC N45 B16 A N45 B16 AC 0005871 0005ADI 0005AVV - BMW 3 (E90) 316 i 09.2007/10.2011 90KW 122CV 1599CC N43 B16 AA N43 B16 A 0005ALC 0005AVW - BMW 3 (E90) 318 d 03.2005/08.2007 90KW 122CV 1995CC M47 D20 (204D4) 0005872 0005873 0005ADG 0005ADU - BMW 3 (E90) 318 d 02.2007/10...</p> <p>d132x123x30mm 6f-d12mm</p>		<p><b>D0063</b> NO. 26117542238</p> <p><b>CARDAN DA TRANSMISSÃO</b></p> <p>BMW 3 (E90) 325 d (De 09-2006 Até 02-2010) 145kW 197CV 2993cc três volumes BMW 3 (E90) 330 d (De 09-2005 Até 09-2008) 170kW 231CV 2993cc três volumes</p> <p>163x155x42mm 6f-d12mm</p>
	<p><b>E1111</b> NO. 18207534092 - 18207589931 - 18208511880</p> <p><b>ESTICADOR DO ESCAPE</b></p> <p>BMW 3 (E90) 316 i (01.05 A 10.11) 115cv 1596cc três volumes - BMW 3 (E90) 318 i (09.05 A 03.07) 129cv 1995cc três volumes - BMW 3 (E90) 318 i (09.07 A 12.11) 143cv 1995cc três volumes - BMW 3 (E90) 320 i (01.05 A 03.07) 150cv 1995cc três volumes - BMW 3 (E90) 320 i (09.07 A 12.11) 170cv 1995cc três volumes - BMW 3 (E90) 320 si (09.05 A 08.06) 173cv 1997cc três volumes - BMW 3 (E90) 3...</p> <p>71x54x32mm 2f-d10mm</p>		<p><b>F1846-I</b> NO. 33211229594 - 33217527325 - 33217527326 - 33217529915 - 33217547080</p> <p><b>FOLE DA TRANSMISSÃO JUNTO À RODA</b></p> <p>BMW SÉRIE 3 (E90) 2.5i 325i - 2.5i 325Xi 4X4 - 3.0i 330i - 3.0i 330Xi 4X4 (APÓS 2005)</p> <p>d80x78mm 1f-d51mm 1f-d31mm</p>
	<p><b>F1847-I</b> NO. 33211229590 - 33217527323 - 33217527324 - 33217529919</p> <p><b>FOLE DA TRANSMISSÃO JUNTO À RODA</b></p> <p>BMW SÉRIE 3 (E90) 2.0i 318i - 2.0i 320i (APÓS 2005)</p> <p>d80x78mm 1f-d44mm 1f-d30mm</p>		<p><b>F4207</b> NO. 25118036629 - 25118037309</p> <p><b>FOLE ALAVANCA VELOCIDADES C/ MANETE PUNHO TOPO COMPLETO 6 VELOCIDADES</b></p> <p>BMW E90</p> <p>172x153x212mm 135x145mm</p>
	<p><b>KU80186</b> NO. 51217162427 - 51217162428 - 7162427 - 7162428</p> <p><b>KIT COMANDO PUXADORES PORTAS ( 77,30MM )</b></p> <p>BMW 3 (E90): 316 i 09.2005/10.2011 85KW 115CV 1596CC - BMW 3 (E90): 316 i 09.2007/10.2011 90KW 122CV 1599CC - BMW 3 (E90): 318 i 09.2005/08.2007 95KW 129CV 1995CC - BMW 3 (E90): 318 i 09.2007/10.2011 105KW 143CV 1995CC - BMW 3 (E90): 320 i 12.2004/08.2007 110KW 150CV 1995CC - BMW 3 (E90): 320 i 02.2007/12.2011 115KW 156CV 1995CC - BMW 3 (E90): 330 i 09.2007/10.2011 125KW 170CV 1995CC - BMW 3 (E90)...</p> <p>d20x77mm</p>		<p><b>KUR21999</b> NO. 1f-d24mm 1f-d10mm 1f-d10mm 1f-d19mm</p> <p><b>KIT DE REPARAÇÃO ALAVANCA DE VELOCIDADES</b></p> <p>BMW 3 (E90) 316 d (De 07.2009 Até 12.2011) 85kW 116cv 1995cm3 três volumes - BMW 3 (E90) 316 i (De 09.2005 Até 10.2011) 85kW 115cv 1596cm3 três volumes - BMW 3 (E90) 316 i (De 09.2007 Até 10.2011) 90kW 122cv 1599cm3 três volumes - BMW 3 (E90) 318 d (De 03.2005 Até 08.2007) 90kW 122cv 1995cm3 três volumes - BMW 3 (E90) 318 d (De 09.2007 Até 10.2011) 100kW 136cv 1995cm3 três volumes - BMW 3 (E90) 31...</p> <p>d37x18mm d19x25mm d17x22mm d31x210mm d43x126x120mm d44x190x411rd15</p>
	<p><b>P1042</b> NO. 35211160422</p> <p><b>CAPA DE PEDAL</b></p> <p>BMW 3 (E90): 318 i 09.2005/08.2007 95KW 129CV 1995CC - BMW 3 (E90): 320 i 12.2004/08.2007 110KW 150CV 1995CC - BMW 3 (E90): 325 xi 12.2004/12.2011 160KW 218CV 2497CC - BMW 3 (E90): 325 xi 09.2005/08.2008 160KW 218CV 2497CC - BMW 3 (E90): 330 xi 12.2004/10.2011 190KW 258CV 2996CC - BMW 3 (E90): 330 xi 09.2005/08.2007 190KW 258CV 2996CC - BMW 3 (E90): 320 d 12.2004/10.2011 120KW 163CV 1995CC</p> <p>75x65x40mm</p>		<p><b>P1055</b> NO. 35211160421</p> <p><b>CAPA DE PEDAL DO TRAVÃO (VEICULOS COM CAIXA AUTOMÁTICA)</b></p> <p>BMW SÉRIE 3 (E90) 318 i Gasolina 95kW 129hp N46 B20 B 09.2005/03.2007 Salão - BMW SÉRIE 3 (E90) 320 d Diesel 120kW 163hp N47 D20 C 01.2005/12.2011 Salão - BMW SÉRIE 3 (E90) 320 d Diesel 120kW 163hp M47 D20 (204D4) 01.2005/12.2011 Salão - BMW SÉRIE 3 (E90) 320 i Gasolina 110kW 150hp N46 B20 A 01.2005/03.2007 Salão - BMW SÉRIE 3 (E90) 320 i Gasolina 110kW 150hp N46 B20 C 01.2005/03.2007 Salão - BMW ...</p> <p>74x107x42mm</p>
	<p><b>P1059</b> NO. 1 108 634 - 35211108634</p> <p><b>CAPA DE PEDAL DO TRAVÃO</b></p> <p>BMW SÉRIE 3 (E90) 320i - 325i (APÓS 01-2005)</p> <p>75x62x12mm</p>		<p><b>R222288</b> NO. 11617797482 - 11617823887 - 7797482 - 7823887</p> <p><b>TUBO DO AR SOBREALIMENTAÇÃO</b></p> <p>BMW 3 (E90) 316 d 07.2009/12.2011 85KW 116CV 1995CC N47 D20 C 0005AQL 0005AVU - BMW 3 (E90) 318 d 03.2005/08.2007 90KW 122CV 1995CC M47 D20 (204D4) 0005872 0005873 0005ADG 0005ADU - BMW 3 (E90) 318 d 02.2007/10.2011 105KW 143CV 1995CC N47 D20 C N47 D20 A 0005ALH 0005AVX - BMW 3 (E90) 318 d 09.2007/10.2011 100KW 136CV 1995CC N47 D20 C N47 D20 A 0005ALI 0005AWA</p> <p>B335-46/46mm 71x89x68x95mm</p>
	<p><b>RT80266</b> NO. 34306771720</p> <p><b>TUBO DE TRAVÃO FRENTE LH-RH</b></p> <p>BMW SÉRIE 3 (E90) 320D (APÓS 01-2005) - SÉRIE 3 (E90) 325i (APÓS 01-2005) - SÉRIE 3 (E90) 325Xi (APÓS 01-2005) - SÉRIE 3 (E90) 330i (APÓS 01-2005)</p> <p>553mm F6 - MC11</p>		<p><b>S1617</b> NO. 31126768818 - 31120410791 - 31126768983 - 0410791 - 6768818</p> <p><b>SILENT-BLOC BRAÇO SUSPENSÃO DA FRENTE PARTE TRÁS</b></p> <p>BMW 3 (E90) 320 d xDrive 09.2008/10.2011 120KW 163CV 1995CC N47 D20 C 0005AOA 0005AWQ - BMW 3 (E90) 320 d xDrive 09.2008/02.2010 130KW 177CV 1995CC N47 D20 A N47 D20 C 0005ANE - BMW 3 (E90) 320 d xDrive 03.2010/10.2011 135KW 184CV 1995CC N47 D20 C 0005AWS - BMW 3 (E90) 325 i xDrive 09.2008/10.2011 160KW 218CV 2996CC N53 B30 A 0005ALV 0005AWR - BMW 3 (E90) 325 xi 09.2005/08.2008 160KW 218CV 2497CC ...</p> <p>d70x66mm c61mm 1f-d12mm</p>

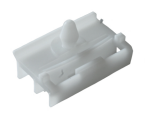

	<p><b>S1875</b> NO. 33176760288 - 33176770866</p> <p><b>SILENT-BLOC DA CAIXA VELOCIDADES AUTOMÁTICA</b></p> <p>BMW 3 (E90) 316 i (De 09.2005 Até 10.2011) 85kW 115cv 1596cm3 três volumes - BMW 3 (E90) 318 i (De 09.2005 Até 08.2009) 95kW 129cv 1995cm3 três volumes - BMW 3 (E90) 318 i (De 09.2007 Até 10.2011) 105kW 143cv 1995cm3 três volumes - BMW 3 (E90) 320 i (De 12.2004 Até 08.2007) 110kW 150cv 1995cm3 três volumes - BMW 3 (E90) 320 i (De 09.2007 Até 10.2011) 125kW 170cv 1995cm3 três volumes - BMW 3 (E90) ...</p> <p>d69x57mm 1f-11x14mm</p>		<p><b>T0623-I</b> NO. 33504034410 - 33536767334 - 33536783482</p> <p><b>BATENTE SUSPENSÃO FRENTE</b></p> <p>BMW 3 (E90) 316 d 07.2009/12.2011 85KW 116CV 1995CC N47 D20 C 0005AQL 0005AVU - BMW 3 (E90) 316 i 09.2005/10.2011 85KW 115CV 1596CC N45 B16 A N45 B16 AC 0005871 0005ADI 0005AVV - BMW 3 (E90) 316 i 09.2007/10.2011 90KW 122CV 1599CC N43 B16 AA N43 B16 A 0005ALC 0005AVV - BMW 3 (E90) 318 d 03.2005/08.2007 90KW 122CV 1995CC M47 D20 (204D4) 0005872 0005873 0005ADG 0005ADU - BMW 3 (E90) 318 d 02.2007/10...</p> <p>d57x89mm 1f-d20mm 1f-d16mm</p>
	<p><b>UMV25105</b> NO. 25117531232</p> <p><b>MANETE PUNHO TOPO ALAVANCA MUDANÇAS 6 VELOCIDADES F14MM</b></p> <p>BMW 3 (E90): 323 i 09.2005/02.2007 130KW 177CV 2497CC - BMW 3 (E90): 323 i 03.2007/12.2011 140KW 190CV 2497CC - BMW 3 (E90): 325 i 12.2004/12.2011 160KW 218CV 2497CC - BMW 3 (E90): 325 xi 09.2005/08.2008 160KW 218CV 2497CC - BMW 3 (E90): 325 xi 09.2005/08.2006 160KW 218CV 2996CC - BMW 3 (E90): 325 i 03.2007/12.2011 160KW 218CV 2996CC - BMW 3 (E90): 328 i 09.2006/12.2011 172KW 234CV 2996CC - MERCEDES...</p> <p>d46x94mm 1f-d14mm</p>		<p><b>UMV25106</b> NO. 25117503100 - 25117566267</p> <p><b>MANETE PUNHO TOPO ALAVANCA MUDANÇAS 5 VELOCIDADES F14MM</b></p> <p>BMW 3 (E90) 316 i 09.2005/10.2011 85KW 115CV 1596CC N45 B16 A N45 B16 AC 0005871 0005ADI 0005AVV - BMW 3 (E90) 316 i 09.2007/10.2011 90KW 122CV 1599CC N43 B16 AA N43 B16 A 0005ALC 0005AVV - BMW 3 (E90) 318 d 03.2005/08.2007 90KW 122CV 1995CC M47 D20 (204D4) 0005872 0005873 0005ADG 0005ADU - BMW 3 (E90) 318 d 02.2007/10.2011 105KW 143CV 1995CC N47 D20 C N47 D20 A 0005ALH 0005AVX - BMW 3 (E90) 318 d...</p> <p>95x45x55mm 1f-d14mm</p>
	<p><b>UMV25127</b> NO. 25112229442 - 25117566267 - 25117833136 - 25118037305</p> <p><b>MANETE PUNHO TOPO ALAVANCA MUDANÇAS 5 VELOCIDADES F14MM</b></p> <p>BMW 3 (E90) 316 i (De 09.2005 Até 10.2011) 85kW 115cv 1596cm3 três volumes - BMW 3 (E90) 316 i (De 09.2007 Até 10.2011) 90kW 122cv 1599cm3 três volumes - BMW 3 (E90) 318 d (De 03.2005 Até 08.2007) 90kW 122cv 1995cm3 três volumes - BMW 3 (E90) 318 d (De 09.2007 Até 10.2011) 100kW 136cv 1995cm3 três volumes - BMW 3 (E90) 318 d (De 02.2007 Até 10.2011) 105kW 143cv 1995cm3 três volumes - BMW 3 (E90) 3...</p> <p>d46x94mm 1f-d14mm</p>		<p><b>UMV26815</b> NO. 25111434495 - 25111434719</p> <p><b>MANETE PUNHO TOPO ALAVANCA MUDANÇAS 5 VELOCIDADES F13MM</b></p> <p>BMW E90</p> <p>55x44x94mm 1f-d13mm</p>
	<p><b>UMV26816</b> NO. 25112229442 - 25117566267 - 25117833136 - 25118037305</p> <p><b>MANETE PUNHO TOPO ALAVANCA MUDANÇAS 6 VELOCIDADES F13MM</b></p> <p>BMW E90</p> <p>55x44x94mm 1f-d13mm</p>		<p><b>UMV26820</b> NO. 2511221290 - 25111434494 - 25111434495</p> <p><b>MANETE PUNHO TOPO ALAVANCA MUDANÇAS 5 VELOCIDADES F14MM</b></p> <p>BMW 3 (E90) 316 d 07.2009/12.2011 85KW 116CV 1995CC N47 D20 C 0005AQL 0005AVU - BMW 3 (E90) 316 i 09.2005/10.2011 85KW 115CV 1596CC N45 B16 A N45 B16 AC 0005871 0005ADI 0005AVV - BMW 3 (E90) 316 i 09.2007/10.2011 90KW 122CV 1599CC N43 B16 AA N43 B16 A 0005ALC 0005AVV - BMW 3 (E90) 318 d 03.2005/08.2007 90KW 122CV 1995CC M47 D20 (204D4) 0005872 0005873 0005ADG 0005ADU - BMW 3 (E90) 318 d 02.2007/10...</p> <p>d46x94mm 1f-d14mm</p>
	<p><b>UMV26822</b> NO. 25111434495 - 25117500299 - 25117503231 - 25117523817 - 25117544524</p> <p><b>MANETE PUNHO TOPO ALAVANCA MUDANÇAS 5 VELOCIDADES F15MM</b></p> <p>BMW 3 (E90) 316 d 07.2009/12.2011 85KW 116CV 1995CC N47 D20 C 0005AQL 0005AVU - BMW 3 (E90) 316 i 09.2005/10.2011 85KW 115CV 1596CC N45 B16 A N45 B16 AC 0005871 0005ADI 0005AVV - BMW 3 (E90) 316 i 09.2007/10.2011 90KW 122CV 1599CC N43 B16 AA N43 B16 A 0005ALC 0005AVV - BMW 3 (E90) 318 d 03.2005/08.2007 90KW 122CV 1995CC M47 D20 (204D4) 0005872 0005873 0005ADG 0005ADU - BMW 3 (E90) 318 d 02.2007/10...</p> <p>d49x95mm 1f-d15mm</p>		<p><b>UTR0848</b> NO. 17117521071</p> <p><b>TAMPÃO RESERVATÓRIO LÍQUIDO REFRIGERAÇÃO</b></p> <p>BMW 3 (E90) 316 i (03.05 A 10.11) 115cv 1596cc três volumes - BMW 3 (E90) 318 i (08.04 A 08.07) 129cv 1995cc três volumes - BMW 3 (E90) 318 i (02.07 A 10.11) 143cv 1995cc três volumes - BMW 3 (E90) 320 i (06.04 A 03.07) 150cv 1995cc três volumes - BMW 3 (E90) 320 i (03.07 A 12.11) 170cv 1995cc três volumes - BMW 3 (E90) 320 si (09.05 A 08.06) 173cv 1997cc três volumes - BMW 3 (E90) 323...</p> <p>d88x45mm 1f-d53x25mm</p>
	<p><b>W5099</b> NO. 11232247932 - 11237786611 - 11237786611 - 11237793593 - 11238511371</p> <p><b>POLIE DA CAMBOTA (4+6 PISTAS)</b></p> <p>BMW 3 (E90) 325 d 09.2006/02.2010 145KW 197CV 2993CC M57 D30 (306D3) 0005AFG - BMW 3 (E90) 330 d 09.2005/09.2008 170KW 231CV 2993CC M57 D30 (306D3) 0005875, 0005ADH - BMW 3 (E90) 330 xd 09.2005/08.2008 170KW 231CV 2993CC M57 D30 (306D3) 0005882, 0005AEC - BMW 3 (E90) 335 d 09.2006/12.2011 210KW 286CV 2993CC M57 D30 (306D5) 0005AFH, 0005AWO</p> <p>d191mm</p>		<p><b>W5099-C</b> NO. 11237786611 - 11237793593</p> <p><b>POLIE DA CAMBOTA (4+6 PISTAS)</b></p> <p>BMW 3 (E90) 325 d 09.2006/02.2010 145KW 197CV 2993CC M57 D30 (306D3) 0005AFG - BMW 3 (E90) 330 d 09.2005/09.2008 170KW 231CV 2993CC M57 D30 (306D3) 0005875, 0005ADH - BMW 3 (E90) 330 xd 09.2005/08.2008 170KW 231CV 2993CC M57 D30 (306D3) 0005882, 0005AEC - BMW 3 (E90) 335 d 09.2006/12.2011 210KW 286CV 2993CC M57 D30 (306D5) 0005AFH, 0005AWO</p> <p>d191mm</p>
	<p><b>W5109</b> NO. 11237797995 - 11237797996 - 11237799153 - 11237823191 - 11238578993 - 11238585220 - 11238651643</p> <p><b>POLIE DA CAMBOTA (6 PISTAS)</b></p> <p>BMW SÉRIE 3 (E90) 318 D 122CV (09-2005 A 12-2011) - 320 D 163 CV (01-2005 A 12-2011) - 320 XD 177CV (09-2007 A 12-2011)</p> <p>d190mm 4f-d10mm</p>		<p><b>W5142</b> NO. 11237797996 - 11238512072 - 11238578993 - 11238585220 - 11238651643</p> <p><b>POLIE DA CAMBOTA 6 PISTAS</b></p> <p>BMW SÉRIE 3 (E90) 316 d (07.09 A 12.11) 116cv 1995cc três volumes - BMW 3 (E90) 318 d (09.09 A 10.11) 143cv 1995cc três volumes - BMW 3 (E90) 320 d (01.10 A 12.11) 184cv 1995cc três volumes - BMW 3 (E90) 320 d xDrive (01.10 A 12.11) 184cv 1995cc três volumes</p> <p>d185mm d10mm</p>
	<p><b>W5209</b> NO. 11237797996 - 11237800385 - 11238578993 - 11238585220 - 11238586724 - 11238651643</p> <p><b>POLIE DA CAMBOTA (6 PISTAS)</b></p> <p>BMW 3 (E90): 325 d 03.2010/10.2011 150KW 204CV 2993CC - BMW 3 (E90): 330 d 09.2005/09.2008 170KW 231CV 2993CC - BMW 3 (E90): 330 xd 09.2005/08.2008 170KW 231CV 2993CC - BMW 3 (E90): 330 d 09.2008/10.2011 180KW 245CV 2993CC - BMW 3 (E90): 330 d xDrive 09.2008/10.2011 180KW 245CV 2993CC</p> <p>d196mm d40/60mm 4f-d10mm</p>		<p><b>Y3239</b> NO. 36130141574 - 36130141576 - 36131095390 - 36131116717 - 36131117190 - 36131126191</p> <p><b>PARAFUSO PERNO RODA CHAVE 17 M12x1,50x50MM (BASE CÔNICA)</b></p> <p>BMW 3 (E90) 318 d 03.2005/08.2007 90KW 122CV 1995CC M47 D20 (204D4) 0005872 0005873 0005ADG 0005ADU - BMW 3 (E90) 318 i 09.2005/08.2007 95KW 129CV 1995CC N46 B20 B 0005874 0005ADK - BMW 3 (E90) 320 i 12.2004/08.2007 110KW 150CV 1995CC N46 B20 CB N46 B20 BD N46 B20 B N46 B20 C 0005820 0005ADN - BMW 3 (E90) 320 si 09.2005/08.2006 127KW 173CV 1997CC N45 B20 A 0005ABY - BMW 3 (E90) 323 i 09.2005/02.20...</p> <p>c51mm (ch-17mm) M12x1x24mm</p>

	<p><b>Z55278</b> NO. 51410407983 - 51418224781 - 51430141025</p> <p>MOLA PAINEL RESVESTIMENTO PORTAS</p> <p>BMW 3 (E90) 316 d (07.2009 - 12.2011) 85kw 116cv 1995cm3 três volumes BMW 3 (E90) 316 i (09.2005 - 10.2011) 85kw 115cv 1596cm3 três volumes BMW 3 (E90) 316 i (09.2007 - 10.2011) 90kw 122cv 1599cm3 três volumes BMW 3 (E90) 318 d (03.2005 - 08.2007) 90kw 122cv 1995cm3 três volumes BMW 3 (E90) 318 d (09.2007 - 10.2011) 100kw 136cv 1995cm3 três volumes BMW 3 (E90) 318 d (02.2007 - 10.2011) 105kw 143cv...</p> <p>F-8T-18mm L-14H-21S1-7mm</p>		<p><b>Z71231</b> NO. 51718184574</p> <p>MOLA DE FIXAÇÃO MOLDURA DE PORTA</p> <p>BMW 3 (E90) 316 d 07.2009/12.2011 85KW 116CV 1995CC N47 D20 C 0005AQL 0005AVU - BMW 3 (E90) 316 i 09.2005/10.2011 85KW 115CV 1596CC N45 B16 A N45 B16 AC 0005871 0005ADI 0005AVV - BMW 3 (E90) 316 i 09.2007/10.2011 90KW 122CV 1599CC N43 B16 AA N43 B16 A 0005ALC 0005AVW - BMW 3 (E90) 318 d 03.2005/08.2007 90KW 122CV 1995CC M47 D20 (204D4) 0005872 0005873 0005ADG 0005ADU - BMW 3 (E90) 318 d 02.2007/10...</p> <p>32x20x9mm 1p-d4x9mm</p>
	<p><b>Z80740</b> NO. 51111944537</p> <p>Mola de fixação</p> <p>BMW SÉRIE 3(E90)</p> <p>d20x32mm 1p-d6.5-15.5mm</p>		<p><b>Z80741</b> NO. 51118174185</p> <p>Mola de fixação</p> <p>BMW SÉRIE 3(E90)</p> <p>d20x33mm 1p-d6.5-15mm</p>
	<p><b>Z80742</b> NO. 51111908077 - N90359101</p> <p>Mola de fixação</p> <p>BMW SÉRIE 3(E90)</p> <p>d15x33mm 1p-d6.5-15.5mm</p>		<p><b>Z80745</b> NO. 51118174186</p> <p>Mola de fixação</p> <p>BMW SÉRIE 3(E90)</p> <p>d15x44mm 1p-d6.5-20mm</p>
	<p><b>Z80768</b> NO. 1299900092 - 12999000927190 - 2019900292 - 30820141 - 51470146782 - 51470390017 - 51471911992 - M820...</p> <p>Mola de fixação</p> <p>BMW SÉRIE 3(E90)</p> <p>d20x28mm 1p-d8-14mm</p>		<p><b>Z80834</b> NO. 51321938884</p> <p>MOLA DE FIXAÇÃO</p> <p>BMW 3 (E90): 316 i 09.2005/10.2011 85KW 115CV 1596CC - BMW 3 (E90): 316 i 09.2007/10.2011 90KW 122CV 1599CC - BMW 3 (E90): 318 i 09.2005/08.2007 95KW 129CV 1995CC - BMW 3 (E90): 318 i 09.2007/10.2011 105KW 143CV 1995CC - BMW 3 (E90): 320 i 12.2004/08.2007 110KW 150CV 1995CC - BMW 3 (E90): 320 i 02.2007/12.2011 115KW 156CV 1995CC - BMW 3 (E90): 320i 09.2007/10.2011 125KW 170CV 1995CC - BMW 3 (E90):...</p> <p>37x29x12.2mm</p>

BMW SERIE 3(E91)

	<p><b>A2270</b> NO. 22114038372</p> <p>APOIO DO MOTOR LADO DIREITO</p> <p>BMW 3 Touring (E91) 325 d (De 2006.09 Até 2012.06) 145kW 197cv 2993cm3 Combi - BMW 3 Touring (E91) 330 d (De 2004.12 Até 2008.08) 170kW 231cv 2993cm3 Combi - BMW 3 Touring (E91) 330 d (De 2008.02 Até 2012.05) 180kW 245cv 2993cm3 Combi - BMW 3 Touring (E91) 335 d (De 2006.09 Até 2012.06) 210kW 286cv 2993cm3 Combi -</p> <p>149x111x134mm 2r-d8mm 1r-d6mm 1p-d10x26mm</p>		<p><b>A2271</b> NO. 22114038371 - 221167732347</p> <p>APOIO DO MOTOR LADO ESQUERDO</p> <p>BMW 3 Touring (E91) 325 d (De 2006.09 Até 2012.06) 145kW 197cv 2993cm3 Combi - BMW 3 Touring (E91) 330 d (De 2004.12 Até 2008.08) 170kW 231cv 2993cm3 Combi - BMW 3 Touring (E91) 330 d (De 2008.02 Até 2012.05) 180kW 245cv 2993cm3 Combi - BMW 3 Touring (E91) 335 d (De 2006.09 Até 2012.06) 210kW 286cv 2993cm3 Combi -</p> <p>149x111x134mm 2r-d8mm 1r-d6mm 1p-d10x26mm</p>
	<p><b>D0022</b> NO. 26111209168 - 26111227420 - 26111227717 - 26111229080 - 26111229360 - 26117511454</p> <p>CARDAN TRANSMISSÃO D135X30MM 6 FUROS 12MM ENTRE FUROS 96MM</p> <p>BMW 3 Touring (E91) 316 d 09.2009/06.2012 85KW 116CV 1995CC N47 D20 C 0005AWY - BMW 3 Touring (E91) 316 i 09.2008/06.2012 90KW 122CV 1599CC N43 B16 AA 0005ANK 0005AWZ - BMW 3 Touring (E91) 318 d 09.2005/08.2007 90KW 122CV 1995CC M47 D20 (204D4) 0005ABZ 0005ACA - BMW 3 Touring (E91) 318 d 07.2007/06.2012 100KW 136CV 1995CC N47 D20 A N47 D20 C 0005BEC 0005ALR 0005AXA - BMW 3 Touring (E91) 318 d 09.2...</p> <p>d132x123x30mm 6f-d12mm</p>		<p><b>D0063</b> NO. 26117542238</p> <p>CARDAN DA TRANSMISSÃO</p> <p>BMW 3 Touring (E91) 325 d (De 09-2006 Até 06-2012) 145kW 197CV 2993cc Combi BMW 3 Touring (E91) 330 d (De 12-2004 Até 08-2008) 170kW 231CV 2993cc Combi</p> <p>163x155x42mm 6f-d12mm</p>
	<p><b>F4207</b> NO. 25118036629 - 25118037309</p> <p>FOLE ALAVANCA VELOCIDADES C/ MANETE PUNHO TOPO COMPLETO 6 VELOCIDADES BMW E91</p> <p>172x153x212mm 135x145mm</p>		<p><b>KT0624-I</b> NO. 31330146239 - 31331094749 - 31336764085</p> <p>KIT BATENTE SUSPENSÃO DA FRENTE</p> <p>BMW 3 Touring (E91) 318 i (De 01-2006 Até 08-2007) 95KW 129CV 1995cc Combi BMW 3 Touring (E91) 318 i (De 05-2007 Até 05-2012) 105KW 143CV 1995cc Combi BMW 3 Touring (E91) 320 i (De 09-2005 Até 06-2012) 110KW 150CV 1995cc Combi BMW 3 Touring (E91) 320 i (De 02-2007 Até 05-2012) 125KW 170CV 1995cc Combi BMW 3 Touring (E91) 325 xi (De 08-2005 Até 08-2011) 160KW 218CV 2497cc Combi BMW 3 Touring (E91) ...</p> <p>d90x190mm 1f-d23mm 1f-d70mm</p>





	<p><b>KU80186</b> NO. 51217162427 - 51217162428 - 7162427 - 7162428</p> <p><b>KIT COMANDO PUXADORES PORTAS ( 77,30MM )</b></p> <p>BMW 3 Touring (E91): 316 i 09.2008/06.2012 90KW 122CV 1599CC - BMW 3 Touring (E91): 318 i 01.2006/08.2007 95KW 129CV 1995CC - BMW 3 Touring (E91): 318 i 09.2007/03.2012 100KW 136CV 1995CC - BMW 3 Touring (E91): 318 i 05.2007/05.2012 105KW 143CV 1995CC - BMW 3 Touring (E91): 320 i 09.2005/06.2012 110KW 150CV 1995CC - BMW 3 Touring (E91): 320 i 02.2007/12.2012 125KW 170CV 1995CC - BMW 3 Touring (E9...</p> <p>d20x77mm</p>		<p><b>KUR21999</b> NO. 1f-d24mm 1f-d10mm 1f-d10mm 1f-d19m</p> <p><b>KIT DE REPARAÇÃO ALAVANCA DE VELOCIDADES</b></p> <p>BMW 3 Touring (E91) 316 d (De 09.2009 Até 06.2012) 85kW 116cv 1995cm3 Combi - BMW 3 Touring (E91) 316 i (De 09.2008 Até 06.2012) 90kW 122cv 1599cm3 Combi - BMW 3 Touring (E91) 318 d (De 09.2005 Até 08.2007) 90kW 122cv 1995cm3 Combi - BMW 3 Touring (E91) 318 d (De 07.2007 Até 06.2012) 100kW 136cv 1995cm3 Combi - BMW 3 Touring (E91) 318 d (De 09.2007 Até 06.2012) 105kW 143cv 1995cm3 Combi - BMW 3 To...</p> <p>d37x18mm d19x25mm d17x22mm d31x21mm d31x26mm d19x15mm d19x15mm d19x15mm</p>
	<p><b>P1042</b> NO. 35211160422</p> <p><b>CAPA DE PEDAL</b></p> <p>BMW 3 Touring (E91): 320 i 09.2005/06.2012 110KW 150CV 1995CC - BMW 3 Touring (E91): 325 i 12.2004/08.2008 160KW 218CV 2497CC - BMW 3 Touring (E91): 325 xi 08.2005/08.2008 160KW 218CV 2497CC - BMW 3 Touring (E91): 330 i 08.2005/08.2007 190KW 258CV 2996CC - BMW 3 Touring (E91): 330 xi 09.2005/08.2007 190KW 258CV 2996CC - BMW 3 Touring (E91): 320 d 06.2005/06.2012 120KW 163CV 1995CC</p> <p>75x65x40mm</p>		<p><b>P1055</b> NO. 35211160421</p> <p><b>CAPA DE PEDAL DO TRAVÃO(VEICULOS COM CAIXA AUTOMÁTICA)</b></p> <p>BMW 3 Touring (E91) 320 d 06.2005/06.2012 120KW 163CV 1995CC N47 D20 A M47 D20 (204D4) N47 D20 C 0005AXE 0005BDT 0005850 0005ADP - BMW 3 Touring (E91) 320 i 09.2005/06.2012 110KW 150CV 1995CC N46 B20 B N46 B20 C 0005877 0005ADX - BMW 3 Touring (E91) 325 i 12.2004/08.2008 160KW 218CV 2497CC N52 B25 A 0005AXN 0005849 0005ADO - BMW 3 Touring (E91) 325 xi 08.2005/08.2008 160KW 218CV 2497CC N52 B25 A 0...</p> <p>74x107x42mm</p>
	<p><b>R222288</b> NO. 11617797482 - 11617823887 - 7797482 - 7823887</p> <p><b>TUBO DO AR SOBREALIMENTAÇÃO</b></p> <p>BMW 3 Touring (E91) 316 d 09.2009/06.2012 85KW 116CV 1995CC N47 D20 C 0005AWY - BMW 3 Touring (E91) 318 d 09.2005/08.2007 90KW 122CV 1995CC M47 D20 (204D4) 0005ABZ 0005ACA - BMW 3 Touring (E91) 318 d 07.2007/06.2012 100KW 136CV 1995CC N47 D20 A N47 D20 C 0005BEC 0005ALR 0005AXA - BMW 3 Touring (E91) 318 d 09.2007/06.2012 105KW 143CV 1995CC N47 D20 C N47 D20 A 0005BDX 0005ALQ 0005AXB</p> <p>B335-46/46mm 71x89x68x95mm</p>		<p><b>S1617</b> NO. 31126768818</p> <p><b>SILENT-BLOC BRAÇO SUSPENSÃO DA FRENTE PARTE TRÁS</b></p> <p>BMW 3 Touring (E91) 320 d xDrive 02.2008/02.2010 145KW 197CV 1995CC N47 D20 C - BMW 3 Touring (E91) 320 d xDrive 09.2008/02.2010 130KW 177CV 1995CC N47 D20 C 0005ANF - BMW 3 Touring (E91) 320 d xDrive 07.2009/06.2012 120KW 163CV 1995CC N47 D20 C 0005AXT 0005ANZ 0005BDV - BMW 3 Touring (E91) 320 d xDrive 03.2010/06.2012 135KW 184CV 1995CC N47 D20 C 0005AXU 0005BDU - BMW 3 Touring (E91) 320 d xDrive...</p> <p>d70x66mm c61mm 1f-d12mm</p>
	<p><b>S1618</b> NO. 33326792543</p> <p><b>SILENT-BLOC BRAÇO SUPERIOR SUSPENSÃO TRÁS EXTERIOR</b></p> <p>BMW 3 Touring (E91) 325 i 09.2007/06.2012 155KW 211CV 2996CC N53 B30 A 0005AXL 0005ALP</p> <p>d46x49mm c32mm 1f-d12mm</p>		<p><b>S1619</b> NO. 33326792544</p> <p><b>SILENT-BLOC BRAÇO SUPERIOR SUSPENSÃO TRÁS INTERIOR</b></p> <p>BMW 3 Touring (E91) 325 i 09.2007/06.2012 155KW 211CV 2996CC N53 B30 A 0005AXL 0005ALP</p> <p>d40x48mm c38mm 1f-d12mm</p>
	<p><b>S1875</b> NO. 33176760288 - 33176770866</p> <p><b>SILENT-BLOC DA CAIXA VELOCIDADES AUTOMÁTICA</b></p> <p>BMW 3 Touring (E91) 318 i (De 01.2006 Até 08.2007) 95KW 129cv 1995cm3 Combi - BMW 3 Touring (E91) 318 i (De 05.2007 Até 05.2012) 105kW 143cv 1995cm3 Combi - BMW 3 Touring (E91) 320 d (De 12.2004 Até 08.2007) 110kW 150cv 1995cm3 Combi - BMW 3 Touring (E91) 320 d (De 06.2005 Até 06.2012) 120kW 163cv 1995cm3 Combi - BMW 3 Touring (E91) 320 d (De 02.2007 Até 12.2010) 130kW 177cv 1995cm3 Combi - BMW 3 ...</p> <p>d69x57mm 1f-11x14mm</p>		<p><b>T0623-I</b> NO. 33504034410 - 33536767334 - 33536783482</p> <p><b>BATENTE SUSPENSÃO FRENTE</b></p> <p>BMW 3 Touring (E91) 318 d 09.2007/06.2012 105KW 143CV 1995CC N47 D20 C N47 D20 A 0005BDX 0005ALQ 0005AXB - BMW 3 Touring (E91) 318 i 05.2007/05.2012 105KW 143CV 1995CC N43 B20 A 0005ALK 0005AXD - BMW 3 Touring (E91) 320 d 06.2005/06.2012 120KW 163CV 1995CC N47 D20 A M47 D20 (204D4) N47 D20 C 0005AXE 0005BDT 0005850 0005ADP - BMW 3 Touring (E91) 320 d 02.2007/12.2010 130KW 177CV 1995CC N47 D20 A N4...</p> <p>d57x89mm 1f-d20mm 1f-d16mm</p>
	<p><b>U7033K</b> NO. 61671378609 - 64500149356 - 64500301636 - 64501363572 - 64501466019 - 64501468463 - 64508390601</p> <p><b>ORINGS BOMBA DIREÇÃO ASSITIDA</b></p> <p>BMW 3 Touring (E91) 320 d xDrive (07.2009 - 06.2012) 120kw 163cv 1995cm3 Combi BMW 3 Touring (E91) 320 d xDrive (09.2008 - 02.2010) 130kw 177cv 1995cm3 Combi BMW 3 Touring (E91) 320 d xDrive (03.2010 - 06.2012) 135kw 184cv 1995cm3 Combi BMW 3 Touring (E91) 320 d xDrive (02.2008 - 02.2010) 145kw 197cv 1995cm3 Combi</p> <p>d11x2mm d10x2mm 1f-d7mm 1f-d6mm</p>		<p><b>UAP81292</b> NO. 13532247156 - 2247156</p> <p><b>ANILHA PROTEÇÃO TÉRMICA INJECTORES</b></p> <p>BMW 3 Touring (E91) 316 d (De 09-2009 Até 06-2012) 85kW 116CV 1995cc Combi BMW 3 Touring (E91) 318 d (De 07-2007 Até 06-2012) 100kW 136CV 1995cc Combi BMW 3 Touring (E91) 318 d (De 09-2007 Até 06-2012) 105kW 143CV 1995cc Combi BMW 3 Touring (E91) 320 d (De 02-2007 Até 12-2010) 130kW 177CV 1995cc Combi BMW 3 Touring (E91) 320 d xDrive (De 02-2008 Até 02-2010) 130kW 177CV 1995cc Combi BMW 3 Touring ...</p> <p>d16x1mm 1f-d7mm</p>
	<p><b>UAP81905</b> NO. 13532247156 - 2247156</p> <p><b>ANILHA PROTEÇÃO TÉRMICA INJECTORES</b></p> <p>BMW 3 Touring (E91) 316 d (De 09-2009 Até 06-2012) 85kW 116CV 1995cc Combi BMW 3 Touring (E91) 318 d (De 07-2007 Até 06-2012) 100kW 136CV 1995cc Combi BMW 3 Touring (E91) 318 d (De 09-2007 Até 06-2012) 105kW 143CV 1995cc Combi BMW 3 Touring (E91) 320 d (De 02-2007 Até 12-2010) 130kW 177CV 1995cc Combi BMW 3 Touring (E91) 320 d xDrive (De 02-2008 Até 02-2010) 130kW 177CV 1995cc Combi BMW 3 Touring ...</p> <p>d14x1mm 1f-d7mm</p>		<p><b>UMV25105</b> NO. 25117531232</p> <p><b>MANETE PUNHO TOPO ALAVANCA MUDANÇAS 6 VELOCIDADES F14MM</b></p> <p>BMW 3 Touring (E91): 323 i 04.2006/06.2007 130KW 177CV 2497CC - BMW 3 Touring (E91): 323 i 09.2006/07.2008 140KW 190CV 2497CC - BMW 3 Touring (E91): 325 i 12.2004/08.2008 160KW 218CV 2497CC - BMW 3 Touring (E91): 325 xi 08.2005/08.2008 160KW 218CV 2497CC - BMW 3 Touring (E91): 325 i 09.2007/06.2012 155KW 211CV 2996CC - BMW 3 Touring (E91): 325 i 09.2007/06.2012 160KW 218CV 2996CC - BMW 3 Touring (...)</p> <p>d46x94mm 1f-d14mm</p>
	<p><b>UMV25106</b> NO. 25117503100 - 25117566267</p> <p><b>MANETE PUNHO TOPO ALAVANCA MUDANÇAS 5 VELOCIDADES F14MM</b></p> <p>BMW 3 Touring (E91) 316 d 09.2009/06.2012 85KW 116CV 1995CC N47 D20 C 0005AWY - BMW 3 Touring (E91) 316 i 09.2008/06.2012 90KW 122CV 1599CC N43 B16 AA 0005ANK 0005AWZ - BMW 3 Touring (E91) 318 d 09.2005/08.2007 90KW 122CV 1995CC M47 D20 (204D4) 0005ABZ 0005ACA - BMW 3 Touring (E91) 318 d 07.2007/06.2012 100KW 136CV 1995CC N47 D20 A N47 D20 C 0005BEC 0005ALR 0005AXA - BMW 3 Touring (E91) 318 d 09...</p> <p>95x45x55mm 1f-d14mm</p>		<p><b>UMV25127</b> NO. 25112229442 - 25117566267 - 25117833136 - 25118037305</p> <p><b>MANETE PUNHO TOPO ALAVANCA MUDANÇAS 5 VELOCIDADES F14MM</b></p> <p>BMW 3 Touring (E91) 316 d (De 09.2009 Até 06.2012) 85kW 116cv 1995cm3 Combi - BMW 3 Touring (E91) 316 i (De 09.2008 Até 06.2012) 90kW 122cv 1599cm3 Combi - BMW 3 Touring (E91) 318 d (De 09.2005 Até 08.2007) 90kW 122cv 1995cm3 Combi - BMW 3 Touring (E91) 318 d (De 07.2007 Até 06.2012) 100kW 136cv 1995cm3 Combi - BMW 3 Touring (E91) 318 d (De 09.2007 Até 06.2012) 105kW 143cv 1995cm3 Combi - BMW 3 To...</p> <p>d46x94mm 1f-d14mm</p>



	<p><b>UMV26815</b> NO. 25111434495 - 25111434719</p> <p>MANETE PUNHO TOPO ALAVANCA MUDANÇAS 5 VELOCIDADES F13MM BMW E91</p>		<p><b>UMV26816</b> NO. 25112229442 - 25117566267 - 25117833136 - 25118037305</p> <p>MANETE PUNHO TOPO ALAVANCA MUDANÇAS 6 VELOCIDADES F13MM BMW E91</p>
	<p><b>UMV26820</b> NO. 25111221290 - 25111222280 - 25111434494 - 25111434495</p> <p>MANETE PUNHO TOPO ALAVANCA MUDANÇAS 5 VELOCIDADES F14MM</p> <p>BMW 3 Touring (E91) 316 d 09.2009/06.2012 85KW 116CV 1995CC N47 D20 C 0005AWY - BMW 3 Touring (E91) 316 i 09.2008/06.2012 90KW 122CV 1599CC N43 B16 AA 0005ANK 0005AWZ - BMW 3 Touring (E91) 318 d 09.2005/08.2007 90KW 122CV 1995CC M47 D20 (204D4) 0005ABZ 0005ACA - BMW 3 Touring (E91) 318 d 07.2007/06.2012 100KW 136CV 1995CC N47 D20 A N47 D20 C 0005BEC 0005ALR 0005AXA - BMW 3 Touring (E91) 318 d 09.200...</p>		<p><b>UMV26822</b> NO. 25111434495 - 25117500299 - 25117503231 - 25117523817 - 25117544524</p> <p>MANETE PUNHO TOPO ALAVANCA MUDANÇAS 5 VELOCIDADES F15MM</p> <p>BMW 3 Touring (E91) 316 d 09.2009/06.2012 85KW 116CV 1995CC N47 D20 C 0005AWY - BMW 3 Touring (E91) 316 i 09.2008/06.2012 90KW 122CV 1599CC N43 B16 AA 0005ANK 0005AWZ - BMW 3 Touring (E91) 318 d 09.2005/08.2007 90KW 122CV 1995CC M47 D20 (204D4) 0005ABZ 0005ACA - BMW 3 Touring (E91) 318 d 07.2007/06.2012 100KW 136CV 1995CC N47 D20 A N47 D20 C 0005BEC 0005ALR 0005AXA - BMW 3 Touring (E91) 318 d 09...</p>
	<p><b>W5099</b> NO. 11232247932 - 11237786611 - 11237786611 - 11237793593 - 11238511371</p> <p>POLIE DA CAMBOTA (4+6 PISTAS)</p> <p>BMW 3 Touring (E91) 325 d 09.2006/06.2012 145KW 197CV 2993CC M57 D30 (306D3) 0005AFJ - BMW 3 Touring (E91) 330 d 12.2004/08.2008 170KW 231CV 2993CC M57 D30 (306D3) 0005878, 0005ADM - BMW 3 Touring (E91) 330 xd 09.2005/06.2012 170KW 231CV 2993CC M57 D30 (306D3) 0005885, 0005AED - BMW 3 Touring (E91) 335 d 09.2006/06.2012 210KW 286CV 2993CC M57 D30 (306D5) 0005AXR, 0005BEA, 0005AFK</p>		<p><b>W5099-C</b> NO. 11237788611 - 11237793593</p> <p>POLIE DA CAMBOTA (4+6 PISTAS)</p> <p>BMW 3 Touring (E91) 325 d 09.2006/06.2012 145KW 197CV 2993CC M57 D30 (306D3) 0005AFJ - BMW 3 Touring (E91) 330 d 12.2004/08.2008 170KW 231CV 2993CC M57 D30 (306D3) 0005878, 0005ADM - BMW 3 Touring (E91) 330 xd 09.2005/06.2012 170KW 231CV 2993CC M57 D30 (306D3) 0005885, 0005AED - BMW 3 Touring (E91) 335 d 09.2006/06.2012 210KW 286CV 2993CC M57 D30 (306D5) 0005AXR, 0005BEA, 0005AFK</p>
	<p><b>W5109</b> NO. 11237797995 - 11237797996 - 11237799153 - 11237823191 - 11238578993 - 11238585220 - 11238651643</p> <p>POLIE DA CAMBOTA (6 PISTAS)</p> <p>BMW SÉRIE 3 Touring (E91) 318 D 122CV (APÓS 09-2005) - 320D 163CV (APÓS 09-2005)</p>		<p><b>W5142</b> NO. 11237797996 - 11238512072 - 11238578993 - 11238585220 - 11238651643</p> <p>POLIE DA CAMBOTA 6 PISTAS</p> <p>BMW SÉRIE 3 Touring (E91) 316 d (09.09 A 06.12) 116cv 1995cc Combi - BMW 3 Touring (E91) 318 d (07.07 A 06.12) 136cv 1995cc Combi - BMW 3 Touring (E91) 318 d (09.07 A 06.12) 143cv 1995cc Combi - BMW 3 Touring (E91) 320 d (03.10 A 05.12) 184cv 1995cc Combi - BMW 3 Touring (E91) 320 d xDrive (03.10 A 05.12) 184cv 1995cc Combi</p>
	<p><b>W5209</b> NO. 11237797996 - 11237800385 - 11238578993 - 11238585220 - 11238586724 - 11238651643</p> <p>POLIE DA CAMBOTA (6 PISTAS)</p> <p>BMW 3 Touring (E91): 325 d 09.2006/06.2012 145KW 197CV 2993CC - BMW 3 Touring (E91): 325 d 02.2010/06.2012 150KW 204CV 2993CC - BMW 3 Touring (E91): 330 d 12.2004/08.2008 170KW 231CV 2993CC - BMW 3 Touring (E91): 330 xd 09.2005/06.2012 170KW 231CV 2993CC - BMW 3 Touring (E91): 330 d 02.2008/05.2012 180KW 245CV 2993CC - BMW 3 Touring (E91): 330 d xDrive 01.2009/06.2012 180KW 245CV 2993CC</p>		<p><b>Y3239</b> NO. 36130141574 - 36130141576 - 36131095390 - 36131116717 - 36131117190 - 36131126191</p> <p>PARAFUSO PERNO RODA CHAVE 17 M12X1,50X50MM (BASE CONICA)</p> <p>BMW 3 Touring (E91) 318 i 01.2006/08.2007 95KW 129CV 1995CC N46 B20 B 0005ABX - BMW 3 Touring (E91) 320 d 06.2005/06.2012 120KW 163CV 1995CC N47 D20 A M47 D20 (204D4) N47 D20 C 0005AXE 0005BDT 0005850 0005ADP - BMW 3 Touring (E91) 320 i 09.2005/06.2012 110KW 150CV 1995CC N46 B20 B N46 B20 C 0005877 0005ADX - BMW 3 Touring (E91) 323 i 04.2006/06.2007 130KW 177CV 2497CC N52 B25 A - BMW 3 Touring (E9...</p>
	<p><b>Z55278</b> NO. 51410407983 - 51418224781 - 51430141025</p> <p>MOLA PAINEL RESVESTIMENTO PORTAS</p> <p>BMW 3 Touring (E91) 316 d (09.2009 - 06.2012) 85kw 116cv 1995cm3 Combi BMW 3 Touring (E91) 316 i (09.2008 - 06.2012) 90kw 122cv 1599cm3 Combi BMW 3 Touring (E91) 318 d (09.2005 - 08.2007) 90kw 122cv 1995cm3 Combi BMW 3 Touring (E91) 318 d (07.2007 - 06.2012) 100kw 136cv 1995cm3 Combi BMW 3 Touring (E91) 318 d (09.2007 - 06.2012) 105kw 143cv 1995cm3 Combi BMW 3 Touring (E91) 318 i (01.2006 - 08.200...</p>		<p><b>Z71231</b> NO. 51718184574</p> <p>MOLA DE FIXAÇÃO MOLDURA DE PORTA</p> <p>BMW 3 Touring (E91) 316 d 09.2009/06.2012 85KW 116CV 1995CC N47 D20 C 0005AWY - BMW 3 Touring (E91) 316 i 09.2008/06.2012 90KW 122CV 1599CC N43 B16 AA 0005ANK 0005AWZ - BMW 3 Touring (E91) 318 d 09.2005/08.2007 90KW 122CV 1995CC M47 D20 (204D4) 0005ABZ 0005ACA - BMW 3 Touring (E91) 318 d 07.2007/06.2012 100KW 136CV 1995CC N47 D20 A N47 D20 C 0005BEC 0005ALR 0005AXA - BMW 3 Touring (E91) 318 d 09.200...</p>

BMW SERIE 3(E92)

	<p><b>A2270</b> NO. 22114038372</p> <p>APOIO DO MOTOR LADO DIREITO</p> <p>BMW 3 Coupé (E92) 325 d (De 2007.02 Até 2010.02) 145kW 197cv 2993cm3 Coupé - BMW 3 Coupé (E92) 330 d (De 2006.03 Até 2008.08) 170kW 231cv 2993cm3 Coupé - BMW 3 Coupé (E92) 330 d (De 2009.01 Até 2013.12) 180kW 245cv 2993cm3 Coupé - BMW 3 Coupé (E92) 335 d (De 2006.03 Até 2013.03) 210kW 286cv 2993cm3 Coupé -</p>		<p><b>A2271</b> NO. 22114038371 - 221167732347</p> <p>APOIO DO MOTOR LADO ESQUERDO</p> <p>BMW 3 Coupé (E92) 325 d (De 2007.02 Até 2010.02) 145kW 197cv 2993cm3 Coupé - BMW 3 Coupé (E92) 330 d (De 2006.03 Até 2008.08) 170kW 231cv 2993cm3 Coupé - BMW 3 Coupé (E92) 330 d (De 2009.01 Até 2013.12) 180kW 245cv 2993cm3 Coupé - BMW 3 Coupé (E92) 335 d (De 2006.03 Até 2013.03) 210kW 286cv 2993cm3 Coupé -</p>
---	---	--	---

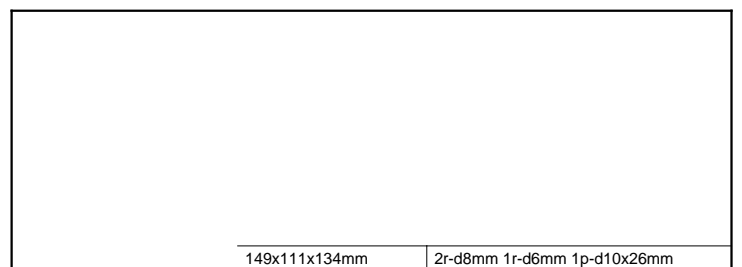





	<p><b>UTR0802</b> NO. 171121321D - 377121321A - 443121131 - 443121321 - 443121321A - 547121321</p> <p>TAMPÃO RESERVATÓRIO LIQUIDO REFRIGERAÇÃO</p> <p>BMW 3 Coupé (E92) 330 i (09.06 A 02.10) 272cv 2996cc Coupé</p> <p>d58x24mm 1f-d49x13mm</p>		<p><b>W5099</b> NO. 11232247932 - 11237786611 - 11237786611 - 11237793593 - 11238511371</p> <p>POLIE DA CAMBOTA (4+6 PISTAS)</p> <p>BMW 3 Coupé (E92) 325 d 02.2007/02.2010 145KW 197CV 2993CC M57 D30 (306D3) 0005AJQ - BMW 3 Coupé (E92) 330 d 03.2006/08.2008 170KW 231CV 2993CC M57 D30 (306D3) 0005AFN - BMW 3 Coupé (E92) 330 xd 03.2006/08.2008 170KW 231CV 2993CC M57 D30 (306D3) 0005AFR - BMW 3 Coupé (E92) 335 d 03.2006/03.2013 210KW 286CV 2993CC M57 D30 (306D5) 0005AVL, 0005AFP</p> <p>d191mm</p>
	<p><b>W5099-C</b> NO. 11237786611 - 11237793593</p> <p>POLIE DA CAMBOTA (4+6 PISTAS)</p> <p>BMW 3 Coupé (E92) 325 d 02.2007/02.2010 145KW 197CV 2993CC M57 D30 (306D3) 0005AJQ - BMW 3 Coupé (E92) 330 d 03.2006/08.2008 170KW 231CV 2993CC M57 D30 (306D3) 0005AFN - BMW 3 Coupé (E92) 330 xd 03.2006/08.2008 170KW 231CV 2993CC M57 D30 (306D3) 0005AFR - BMW 3 Coupé (E92) 335 d 03.2006/03.2013 210KW 286CV 2993CC M57 D30 (306D5) 0005AVL, 0005AFP</p> <p>d191mm</p>		<p><b>W5109</b> NO. 11237797995 - 11237797996 - 11237799153 - 11237823191 - 11238578993 - 11238585220 - 11238651643</p> <p>POLIE DA CAMBOTA (6 PISTAS)</p> <p>BMW SÉRIE 3 COUPÉ (E92) 320 D 177CV (APÓS 03-2007) - 320 XD 177CV (APÓS 03-2007)</p> <p>d190mm 4f-d10mm</p>
	<p><b>W5209</b> NO. 11237797996 - 11237800385 - 11238578993 - 11238585220 - 11238586724 - 11238651643</p> <p>POLIE DA CAMBOTA (6 PISTAS)</p> <p>BMW 3 Coupé (E92): 325 d 09.2009/12.2013 150KW 204CV 2993CC - BMW 3 Coupé (E92): 330 d 03.2006/08.2008 170KW 231CV 2993CC - BMW 3 Coupé (E92): 330 xd 03.2006/08.2008 170KW 231CV 2993CC - BMW 3 Coupé (E92): 330 d 01.2009/12.2013 180KW 245CV 2993CC - BMW 3 Coupé (E92): 330 xd 03.2008/02.2010 180KW 245CV 2993CC - BMW 3 Coupé (E92): 330 d xDrive 02.2010/06.2013 180KW 245CV 2993CC</p> <p>d196mm d40/60mm 4f-d10mm</p>		<p><b>Y3239</b> NO. 36130141574 - 36130141576 - 36131095390 - 36131116717 - 36131117190 - 36131126191</p> <p>PARAFUSO PERNO RODA CHAVE 17 M12X1,50X50MM ( BASE CONICA )</p> <p>BMW 3 Coupé (E92) 320 d 09.2006/02.2010 130KW 177CV 1995CC N47 D20 A N47 D20 C 0005AJP - BMW 3 Coupé (E92) 325 d 02.2007/02.2010 145KW 197CV 2993CC M57 D30 (306D3) 0005AJQ - BMW 3 Coupé (E92) 325 i 06.2006/02.2010 160KW 218CV 2497CC N52 B25 BF N52 B25 AF N52 B25 A 0005895 0005AVF 0005AFM - BMW 3 Coupé (E92) 325 xi 09.2006/02.2010 160KW 218CV 2497CC N52 B25 A 0005AVP 0005AFQ - BMW 3 Coupé (E92) 330...</p> <p>c51mm (ch-17mm) M12x1x24mm</p>
	<p><b>Z55278</b> NO. 51410407983 - 51418224781 - 51430141025</p> <p>MOLA PAINEL RESVESTIMENTO PORTAS</p> <p>BMW 3 Coupé (E92) 316 i (09.2007 - 06.2013) 90kw 122cv 1599cm3 Coupé BMW 3 Coupé (E92) 318 i (03.2010 - 12.2013) 105kw 143cv 1995cm3 Coupé BMW 3 Coupé (E92) 320 d (03.2007 - 06.2013) 120kw 163cv 1995cm3 Coupé BMW 3 Coupé (E92) 320 d (09.2006 - 02.2010) 130kw 177cv 1995cm3 Coupé BMW 3 Coupé (E92) 320 d (03.2010 - 06.2013) 135kw 184cv 1995cm3 Coupé BMW 3 Coupé (E92) 320 d (09.2006 - 02.2010) 145kw 1...</p> <p>F-8T-18mm L-14H-21S1-7mm</p>		<p><b>Z80834</b> NO. 51321938884</p> <p>MOLA DE FIXAÇÃO</p> <p>BMW 3 Coupé (E92): 316 i 09.2007/06.2013 90KW 122CV 1599CC - BMW 3 Coupé (E92): 318 i 03.2010/12.2013 105KW 143CV 1995CC - BMW 3 Coupé (E92): 320 i 06.2007/12.2013 115KW 156CV 1995CC - BMW 3 Coupé (E92): 320 i 01.2007/12.2013 120KW 163CV 1995CC - BMW 3 Coupé (E92): 320 d 03.2007/12.2013 125KW 170CV 1995CC - BMW 3 Coupé (E92): 325 i xDrive 03.2010/04.2013 150KW 204CV 2497CC - BMW 3 Coupé (E92): 325...</p> <p>37x29x12.2mm</p>

## BMW SERIE 3(E93)

	<p><b>A2270</b> NO. 22114038372</p> <p>APOIO DO MOTOR LADO DIREITO</p> <p>BMW 3 Cabriolet (E93) 325 d (De 2007.03 Até 2010.12) 145kW 197cv 2993cm3 Cabriolet - BMW 3 Cabriolet (E93) 330 d (De 2007.03 Até 2013.12) 170kW 231cv 2993cm3 Cabriolet -</p> <p>149x111x134mm 2r-d8mm 1r-d6mm 1p-d10x26mm</p>		<p><b>A2271</b> NO. 22114038371 - 221167732347</p> <p>APOIO DO MOTOR LADO ESQUERDO</p> <p>BMW 3 Cabriolet (E93) 325 d (De 2007.03 Até 2010.12) 145kW 197cv 2993cm3 Cabriolet - BMW 3 Cabriolet (E93) 330 d (De 2007.03 Até 2013.12) 170kW 231cv 2993cm3 Cabriolet -</p> <p>149x111x134mm 2r-d8mm 1r-d6mm 1p-d10x26mm</p>
	<p><b>D0022</b> NO. 26111209168 - 26111227420 - 26111227717 - 26111229080 - 26111229360 - 26117511454</p> <p>CARDAN TRANSMISSÃO D135X30MM 6 FUROS 12MM ENTRE FUROS 96MM</p> <p>BMW SERIE 3 (E93)</p> <p>d132x123x30mm 6f-d12mm</p>		<p><b>D0063</b> NO. 26117542238</p> <p>CARDAN DA TRANSMISSÃO</p> <p>BMW 3 Cabriolet (E93) 330 d (De 03-2007 Até 12-2013) 170kW 231CV 2993cc Cabriolet</p> <p>163x155x42mm 6f-d12mm</p>
	<p><b>F4207</b> NO. 25118036629 - 25118037309</p> <p>FOLE ALAVANCA VELOCIDADES C/ MANETE PUNHO TOPO COMPLETO 6 VELOCIDADES</p> <p>BMW E93</p> <p>172x153x212mm 135x145mm</p>		<p><b>KT0624-I</b> NO. 31330146239 - 31331094749 - 31336764085</p> <p>KIT BATENTE SUSPENSÃO DA FRENTE</p> <p>BMW 3 Cabriolet (E93) 325 i (De 03-2007 Até 12-2013) 160KW 218CV 2996cc Cabriolet BMW 3 Cabriolet (E93) 330 i (De 03-2007 Até 12-2013) 200KW 272CV 2996cc Cabriolet BMW 3 Cabriolet (E93) 335 i (De 05-2006 Até 10-2013) 225KW 306CV 2979cc Cabriolet BMW 3 Cabriolet (E93) 320 d (De 03-2010 Até 10-2013) 135KW 184CV 1995cc Cabriolet BMW 3 Cabriolet (E93) 325 d (De 09-2009 Até 09-2013) 150KW 204CV 2993cc ...</p> <p>d90x190mm 1f-d23mm 1f-d70mm</p>

	<p><b>KUR21999</b> NO. 1f-d10mm 1f-d10mm 1f-d10mm 1f-d10mm</p> <p><b>KIT DE REPARAÇÃO ALAVANCA DE VELOCIDADES</b></p> <p>BMW 3 Cabriolet (E93) 318 i (De 03.2010 Até 12.2013) 105kW 143cv 1995cm3 Cabriolet - BMW 3 Cabriolet (E93) 320 d (De 01.2008 Até 12.2013) 120kW 163cv 1995cm3 Cabriolet - BMW 3 Cabriolet (E93) 320 d (De 03.2008 Até 02.2010) 130kW 177cv 1995cm3 Cabriolet - BMW 3 Cabriolet (E93) 320 d (De 03.2010 Até 10.2013) 135kW 184cv 1995cm3 Cabriolet - BMW 3 Cabriolet (E93) 320 d (De 09.2007 Até 02.2010) 145kW 1...</p> <p>d37x18mm d19x25mm d17x22x4mm d31x210mm d31x26x120mm d24x19x6d</p>		<p><b>P1042</b> NO. 35211160422</p> <p><b>CAPA DE PEDAL</b></p> <p>BMW SERIE 3(E93)</p> <p>.75x65x40mm</p>
	<p><b>P1042</b> NO. 35211160422</p> <p><b>CAPA DE PEDAL</b></p> <p>BMW 3 Cabriolet (E93) 320 i 03.2007/10.2013 125KW 170CV 1995CC N43 B20 A 0005AUM 0005AHL - BMW 3 Cabriolet (E93) 325 i 12.2006/02.2010 160KW 218CV 2497CC N52 B25 A 0005AUP 0005AIX - BMW 3 Cabriolet (E93) 330 i 03.2007/10.2013 200KW 272CV 2996CC N53 B30 A 0005AUU 0005AHN - BMW 3 Cabriolet (E93) 335 i 12.2006/10.2013 225KW 306CV 2979CC N55 B30 A N54 B30 A 0005AUV 0005AHK</p> <p>75x65x40mm</p>		<p><b>UAP81292</b> NO. 13532247156 - 2247156</p> <p><b>ANILHA PROTEÇÃO TÉRMICA INJECTORES</b></p> <p>BMW 3 Cabriolet (E93) 320 d (De 09-2007 Até 02-2010) 130kW 177CV 1995cc Cabriolet BMW 3 Cabriolet (E93) 320 d (De 03-2010 Até 10-2013) 135kW 184CV 1995cc Cabriolet</p> <p>d16x1mm 1f-d7mm</p>
	<p><b>UAP81905</b> NO. 13532247156 - 2247156</p> <p><b>ANILHA PROTEÇÃO TÉRMICA INJECTORES</b></p> <p>BMW 3 Cabriolet (E93) 320 d (De 09-2007 Até 02-2010) 130kW 177CV 1995cc Cabriolet BMW 3 Cabriolet (E93) 320 d (De 03-2010 Até 10-2013) 135kW 184CV 1995cc Cabriolet</p> <p>d14x1mm 1f-d7mm</p>		<p><b>UMV25106</b> NO. 25117503100 - 25117566267</p> <p><b>MANETE PUNHO TOPO ALAVANCA MUDANÇAS 5 VELOCIDADES F14MM</b></p> <p>BMW 3 Cabriolet (E93) 318 i 03.2010/12.2013 105KW 143CV 1995CC N43 B20 A 0005AUH - BMW 3 Cabriolet (E93) 320 d 09.2007/02.2010 145KW 197CV 1995CC N47 D20 C N47 D20 A - BMW 3 Cabriolet (E93) 320 d 01.2008/12.2013 120KW 163CV 1995CC N47 D20 C 0005AUI 0005AKZ - BMW 3 Cabriolet (E93) 320 d 03.2008/02.2010 130KW 177CV 1995CC N47 D20 A N47 D20 C 0005AKY - BMW 3 Cabriolet (E93) 320 d 03.2010/10.2013 135K...</p> <p>95x45x55mm 1f-d14mm</p>
	<p><b>UMV25127</b> NO. 25112229442 - 25117566267 - 25117833136 - 25118037305</p> <p><b>MANETE PUNHO TOPO ALAVANCA MUDANÇAS 5 VELOCIDADES F14MM</b></p> <p>BMW 3 Cabriolet (E93) 318 i (De 03.2010 Até 12.2013) 105kW 143cv 1995cm3 Cabriolet - BMW 3 Cabriolet (E93) 320 d (De 01.2008 Até 12.2013) 120kW 163cv 1995cm3 Cabriolet - BMW 3 Cabriolet (E93) 320 d (De 03.2008 Até 02.2010) 130kW 177cv 1995cm3 Cabriolet - BMW 3 Cabriolet (E93) 320 d (De 03.2010 Até 10.2013) 135kW 184cv 1995cm3 Cabriolet - BMW 3 Cabriolet (E93) 320 d (De 09.2007 Até 02.2010) 145kW 1...</p> <p>d46x94mm 1f-d14mm</p>		<p><b>UMV26815</b> NO. 25111434495 - 25111434719</p> <p><b>MANETE PUNHO TOPO ALAVANCA MUDANÇAS 5 VELOCIDADES F13MM</b></p> <p>BMW E93</p> <p>55x44x94mm 1f-d13mm</p>
	<p><b>UMV26816</b> NO. 25112229442 - 25117566267 - 25117833136 - 25118037305</p> <p><b>MANETE PUNHO TOPO ALAVANCA MUDANÇAS 6 VELOCIDADES F13MM</b></p> <p>BMW E93</p> <p>55x44x94mm 1f-d13mm</p>		<p><b>W5099</b> NO. 11232247932 - 11237786611 - 11237786611 - 11237793593 - 11238511371</p> <p><b>POLIE DA CAMBOTA (4+6 PISTAS)</b></p> <p>BMW 3 Cabriolet (E93) 325 d 03.2007/12.2010 145KW 197CV 2993CC M57 D30 (306D3) 0005AKX - BMW 3 Cabriolet (E93) 330 d 03.2007/12.2013 170KW 231CV 2993CC M57 D30 (306D3) 0005AHO</p> <p>d191mm</p>
	<p><b>W5099-C</b> NO. 11237788611 - 11237793593</p> <p><b>POLIE DA CAMBOTA (4+6 PISTAS)</b></p> <p>BMW 3 Cabriolet (E93) 325 d 03.2007/12.2010 145KW 197CV 2993CC M57 D30 (306D3) 0005AKX - BMW 3 Cabriolet (E93) 330 d 03.2007/12.2013 170KW 231CV 2993CC M57 D30 (306D3) 0005AHO</p> <p>d191mm</p>		<p><b>W5109</b> NO. 11237797995 - 11237797996 - 11237799153 - 11237823191 - 11238578993 - 11238585220 - 11238651643</p> <p><b>POLIE DA CAMBOTA (6 PISTAS)</b></p> <p>BMW SÉRIE 3 Cabriolet (E93) 320 D 177CV (APÓS 03-2007)</p> <p>d190mm 4f-d10mm</p>
	<p><b>W5209</b> NO. 11237797996 - 11237800385 - 11238578993 - 11238585220 - 11238586724 - 11238651643</p> <p><b>POLIE DA CAMBOTA (6 PISTAS)</b></p> <p>BMW 3 Cabriolet (E93): 325 d 03.2007/12.2010 145KW 197CV 2993CC - BMW 3 Cabriolet (E93): 325 d 09.2009/09.2013 150KW 204CV 2993CC - BMW 3 Cabriolet (E93): 330 d 03.2007/12.2013 170KW 231CV 2993CC - BMW 3 Cabriolet (E93): 330 d 01.2009/12.2013 180KW 245CV 2993CC</p> <p>d196mm d40/60mm 4f-d10mm</p>		<p><b>Z55278</b> NO. 51410407983 - 51418224781 - 51430141025</p> <p><b>MOLA PAINEL RESVESTIMENTO PORTAS</b></p> <p>BMW 3 Cabriolet (E93) 318 i (03.2010 - 12.2013) 105kw 143cv 1995cm3 Cabriolet BMW 3 Cabriolet (E93) 320 d (01.2008 - 12.2013) 120kw 163cv 1995cm3 Cabriolet BMW 3 Cabriolet (E93) 320 d (03.2008 - 02.2010) 130kw 177cv 1995cm3 Cabriolet BMW 3 Cabriolet (E93) 320 d (03.2010 - 10.2013) 135kw 184cv 1995cm3 Cabriolet BMW 3 Cabriolet (E93) 320 d (09.2007 - 02.2010) 145kw 197cv 1995cm3 Cabriolet BMW 3 Cabr...</p> <p>F-8T-18mm L-14H-21S1-7mm</p>
	<p><b>Z80834</b> NO. 51321938884</p> <p><b>MOLA DE FIXAÇÃO</b></p> <p>BMW 3 Cabriolet (E93): 318 i 03.2010/12.2013 105KW 143CV 1995CC - BMW 3 Cabriolet (E93): 320 i 01.2007/08.2013 115KW 156CV 1995CC - BMW 3 Cabriolet (E93): 320 i 03.2007/10.2013 125KW 170CV 1995CC - BMW 3 Cabriolet (E93): 323 i 03.2007/09.2011 140KW 190CV 2497CC - BMW 3 Cabriolet (E93): 325 i 12.2006/02.2010 160KW 218CV 2497CC - BMW 3 Cabriolet (E93): 325 i 03.2007/12.2013 160KW 218CV 2996CC - BMW ...</p> <p>37x29x12.2mm</p>		





	<p><b>UAP81905</b> NO. 13532247156 - 2247156</p> <p><b>ANILHA PROTEÇÃO TÉRMICA INJECTORES</b></p> <p>BMW 3 (F30 - F80) 316 d (De 05-2011 Até .1-20 -) 85kW 116CV 1995cc três volumes BMW 3 (F30 - F80) 318 d (De 05-2011 Até 06-2015) 105kW 143CV 1995cc três volumes BMW 3 (F30 - F80) 318 d xDrive (De 11-2012 Até 05-2015) 105kW 143CV 1995cc três volumes BMW 3 (F30 - F80) 318 d (De 10-2014 Até .1-20 -) 110kW 150CV 1995cc três volumes BMW 3 (F30 - F80) 318 d xDrive (De 11-2014 Até .1-20 -) 110kW 150C...</p> <p>d14x1mm 1f-d7mm</p>		<p><b>UAP81905</b> NO. 13532247156 - 2247156</p> <p><b>ANILHA PROTEÇÃO TÉRMICA INJECTORES</b></p> <p>BMW 3 Touring (F31) 316 d (De 02-2012 Até .1-20 -) 85kW 116CV 1995cc Combi BMW 3 Touring (F31) 318 d (De 07-2011 Até 06-2015) 105kW 143CV 1995cc Combi BMW 3 Touring (F31) 318 d xDrive (De 01-2013 Até 05-2015) 105kW 143CV 1995cc Combi BMW 3 Touring (F31) 318 d (De 09-2014 Até .1-20 -) 110kW 150CV 1995cc Combi BMW 3 Touring (F31) 318 d xDrive (De 03-2015 Até .1-20 -) 110kW 150CV 1995cc Combi BMW 3 T...</p> <p>d14x1mm 1f-d7mm</p>
	<p><b>W5125</b> NO. 11517545958 - 11517571012 - 11517619020 - 7545958 - 7571012 - 7619020</p> <p><b>POLIE DA BOMBA DE ÁGUA</b></p> <p>BMW SÉRIE 3 (F30) - 316 i (PÓS 10.12) 136cv 1598cc três volumes - BMW SÉRIE 3 (F30) - 320 i (APÓS 02.12) 170cv 1598cc três volumes</p> <p>d123mm d20mm</p>		<p><b>W5125</b> NO. 11517545958 - 11517571012 - 11517619020 - 7545958 - 7571012 - 7619020</p> <p><b>POLIE DA BOMBA DE ÁGUA</b></p> <p>BMW SÉRIE 3 Touring (F31) - 316 i 03.13 - 100 136 - 136 1598 Combi</p> <p>d123mm d20mm</p>
	<p><b>W5125</b> NO. 11517545958 - 11517571012 - 11517619020 - 7545958 - 7571012 - 7619020</p> <p><b>POLIE DA BOMBA DE ÁGUA</b></p> <p>BMW SÉRIE 3 (F35) - 316 i (PÓS 10.12) 136cv 1598cc três volumes - BMW SÉRIE 3 (F35) - 320 i (APÓS 02.12) 170cv 1598cc três volumes</p> <p>d123mm d20mm</p>		<p><b>W5125</b> NO. 11517545958 - 11517571012 - 11517619020 - 7545958 - 7571012 - 7619020</p> <p><b>POLIE DA BOMBA DE ÁGUA</b></p> <p>BMW SÉRIE 3 (F80) - 316 i (PÓS 10.12) 136cv 1598cc três volumes - BMW SÉRIE 3 (F80) - 320 i (APÓS 02.12) 170cv 1598cc três volumes</p> <p>d123mm d20mm</p>
	<p><b>W5142</b> NO. 11237797996 - 11238512072 - 11238578993 - 11238585220 - 11238651643</p> <p><b>POLIE DA CAMBOTA 6 PISTAS</b></p> <p>BMW SÉRIE 3 (F30 - F80) 320 i xDrive (APÓS 11.11) 184cv 1997cc três volumes - BMW 3 (F30 - F80) 316 d (APÓS 02.12) 116cv 1995cc três volumes - BMW 3 (F30 - F80) 318 d (APÓS 02.12) 143cv 1995cc três volumes - BMW 3 (F30 - F80) 320 d (APÓS 10.11) 163cv 1995cc três volumes - BMW 3 (F30 - F80) 320 d (10.11 A 07.15) 184cv 1995cc três volumes</p> <p>d185mm d10mm</p>		<p><b>W5142</b> NO. 11238512072 - 11238578993 - 11238585220 - 11238651643</p> <p><b>POLIE DA CAMBOTA 6 PISTAS</b></p> <p>BMW SÉRIE 3 Touring (F31) 316 d (APÓS 06.12) 116cv 1995cc Combi - BMW 3 Touring (F31) 318 d (APÓS 06.12) 143cv 1995cc Combi - BMW 3 Touring (F31) 320 d (06.12 A 07.15) 184cv 1995cc Combi</p> <p>d185mm d10mm</p>
	<p><b>W5192</b> NO. 11238602800</p> <p><b>POLIE DA CAMBOTA (6 PISTAS)</b></p> <p>BMW 3 (F30, F80): 330 e 11.2015/10.2018 135KW 184CV 1998CC - BMW 3 (F30, F80): 320 i 07.2015/10.2018 135KW 184CV 1998CC - BMW 3 (F30, F80): 320 i xDrive 07.2015/10.2018 135KW 184CV 1998CC - BMW 3 (F30, F80): 330 i 07.2015/10.2018 185KW 252CV 1998CC - BMW 3 (F30, F80): 330 i xDrive 07.2015/10.2018 185KW 252CV 1998CC</p> <p>d158mm d59mm</p>		<p><b>W5192</b> NO. 11238602800</p> <p><b>POLIE DA CAMBOTA (6 PISTAS)</b></p> <p>BMW 3 (F30, F80): 330 e 11.2015/10.2018 135KW 184CV 1998CC - BMW 3 (F30, F80): 320 i 07.2015/10.2018 135KW 184CV 1998CC - BMW 3 (F30, F80): 320 i xDrive 07.2015/10.2018 135KW 184CV 1998CC - BMW 3 (F30, F80): 330 i 07.2015/10.2018 185KW 252CV 1998CC - BMW 3 (F30, F80): 330 i xDrive 07.2015/10.2018 185KW 252CV 1998CC</p> <p>d158mm d59mm</p>
	<p><b>W5192</b> NO. 11238602800</p> <p><b>POLIE DA CAMBOTA (6 PISTAS)</b></p> <p>BMW 3 Touring (F31): 320 i 07.2015/06.2019 135KW 184CV 1998CC - BMW 3 Touring (F31): 320 i xDrive 07.2015/06.2019 135KW 184CV 1998CC - BMW 3 Touring (F31): 330 i 07.2015/06.2019 185KW 252CV 1998CC - BMW 3 Touring (F31): 330 i xDrive 07.2015/06.2019 185KW 252CV 1998CC</p> <p>d158mm d59mm</p>		<p><b>W5208</b> NO. 11237797996 - 11238511321 - 11238518985 - 11238578993 - 11238585220 - 11238586724 - 11238651643</p> <p><b>POLIE DA CAMBOTA (6 pistas)</b></p> <p>BMW 3 (F30, F80): 330 d 07.2012/10.2018 190KW 258CV 2993CC - BMW 3 (F30, F80): 330 d xDrive 03.2013/10.2018 190KW 258CV 2993CC - BMW 3 (F30, F80): 330 d 07.2012/10.2018 210KW 286CV 2993CC - BMW 3 (F30, F80): 330 d xDrive 03.2013/10.2018 210KW 286CV 2993CC - BMW 3 (F30, F80): 335 d xDrive 07.2013/10.2018 230KW 313CV 2993CC</p> <p>d196mm d40/60mm 4f-d10mm</p>
	<p><b>W5208</b> NO. 11237797996 - 11238511321 - 11238518985 - 11238578993 - 11238585220 - 11238586724 - 11238651643</p> <p><b>POLIE DA CAMBOTA (6 pistas)</b></p> <p>BMW 3 Touring (F31): 330 d 07.2012/06.2019 190CV 258CV 2993CC - BMW 3 Touring (F31): 330 d xDrive 03.2013/06.2019 190KW 258CV 2993CC - BMW 3 Touring (F31): 330 d 07.2012/06.2019 210KW 286CV 2993CC - BMW 3 Touring (F31): 330 d xDrive 03.2013/06.2019 210KW 286CV 2993CC - BMW 3 Touring (F31): 335 d xDrive 11.2013/06.2019 230KW 313CV 2993CC</p> <p>d196mm d40/60mm 4f-d10mm</p>		<p><b>W5210</b> NO. 11237619245 - 11237797996 - 11238518985 - 11238578993 - 11238585220 - 11238586724 - 11238651643</p> <p><b>POLIE DA CAMBOTA (6 PISTAS)</b></p> <p>BMW 3 (F30, F80): 316 d 03.2012/10.2018 85KW 116CV 1995CC - BMW 3 (F30, F80): 318 d 03.2012/06.2015 105K2 143CV 1995CC - BMW 3 (F30, F80): 318 d xDrive 07.2013/06.2015 105KW 143CV 1995CC - BMW 3 (F30, F80): 318 d 07.2015/10.2018 110KW 150CV 1995CC - BMW 3 (F30, F80): 318 d xDrive 07.2015/02.2018 110KW 150CV 1995CC - BMW 3 (F30, F80): 320 d 11.2011/10.2018 120KW 163CV 1995CC - BMW 3 (F30, F80): 320 ...</p> <p>d155mm d40/60mm 4f-d10mm</p>

	<b>KUBT3023</b> NO. 1f-d39mm(x2) 1f-d48mm(x2) 1f-d5mm		
	<b>KIT BORRACHAS TRAVAO PINÇA TRAS BRENBO 40MM</b>  BMW 3 (G20, G80, G28) 318 d 03.2019/03.2020 100KW 136CV 1995CC B47 D20 B 0005CTU - BMW 3 (G20, G80, G28) 318 d 03.2019/03.2020 110KW 150CV 1995CC B47 D20 B 0005CTV - BMW 3 (G20, G80, G28) 320 d 11.2018/02.2020 120KW 163CV 1995CC B47 D20 B 0005CTW - BMW 3 (G20, G80, G28) 320 d desde 11.2018 140KW 190CV 1995CC B47 D20 B 0005CTX - BMW 3 (G20, G80, G28) 320 d xDrive 11.2018/02.2020 120KW 163CV 1995CC ...		
	d59x12mm(x2) d54x3mm(x2) d59x11(x2) 1f-d48mm(x2) 1f-d5mm 1p-d10x17mm...		

## BMW SERIE 3 Gran Turismo (F34)

	<b>A2569</b> NO. 22316796617		<b>D0022</b> NO. 26111209168 - 26111227420 - 26111227717 - 26111229080 - 26111229360 - 26117511454
	<b>APOIO DA CAIXA DE VELOCIDADES</b>  BMW 3 Gran Turismo (F34) 318 d (De 03.2013 Até 06.2015) 100kW 136cv 1995cm3 Hatchback - BMW 3 Gran Turismo (F34) 318 d (De 03.2013 Até 06.2015) 105kW 143cv 1995cm3 Hatchback - BMW 3 Gran Turismo (F34) 318 d (De 07.2015 -) 110kW 150cv 1995cm3 Hatchback - BMW 3 Gran Turismo (F34) 320 d (De 03.2013 Até 06.2015) 120kW 163cv 1995cm3 Hatchback - BMW 3 Gran Turismo (F34) 320 d (De 03.2013 Até 06.2015) 1...		<b>CARDAN TRANSMISSÃO D135X30MM 6 FUIROS 12MM ENTRE FUIROS 96MM</b> <b>BMW SERIE 3 GRAN TURISMO (F34)</b>
	74x46x40mm 1p-d7x16mm 1p-d8x31mm		d132x123x30mm 6f-d12mm
	<b>F4363</b> NO. 25117596009		<b>KUR21999</b> NO. 1f-d24mm 1f-d10mm 1f-d10mm 1f-d19mm
	<b>FOLE ALAVANCA VELOCIDADES C/ MANETE PUNHO TOPO COMPLETO 6 VELOCIDADES</b>  BMW 3 Gran Turismo (F34) 318 d 03.2013/06.2015 100KW 136CV 1995CC N47 D20 C B47 D20 A 0005BON - BMW 3 Gran Turismo (F34) 318 d 03.2013/06.2015 105KW 143CV 1995CC N47 D20 C 0005BOM - BMW 3 Gran Turismo (F34) 320 d 03.2013/06.2015 120KW 163CV 1995CC N47 D20 C B47 D20 A 0005BOP - BMW 3 Gran Turismo (F34) 320 d 03.2013/06.2015 135KW 184CV 1995CC N47 D20 C 0005BOO - BMW 3 Gran Turismo (F34) 320 d 03.20...		<b>KIT DE REPARAÇÃO ALAVANCA DE VELOCIDADES</b>  BMW 3 Gran Turismo (F34) 318 d (De 2003.2013 -) 100kW 136cv 1995cm3 Hatchback - BMW 3 Gran Turismo (F34) 318 d (De 03.2013 Até 06.2015) 105kW 143cv 1995cm3 Hatchback - BMW 3 Gran Turismo (F34) 318 d (De 2007.2015 -) 110kW 150cv 1995cm3 Hatchback - BMW 3 Gran Turismo (F34) 320 d (De 2003.2013 -) 120kW 163cv 1995cm3 Hatchback - BMW 3 Gran Turismo (F34) 320 d (De 03.2013 Até 06.2015) 135kW 184cv 1995...
	240x152x146mm 1f-134x141mm		d37x18mm d19x25mm d72x24mm d31x21mm d43x26mm d124x19mm d141x15mm
	<b>S1271</b> NO. 31106770689 - 31106770690 - 31121092019 - 31121094235 - 31121122462 - 31121124622 - 31121133236 - 31...		<b>S1618</b> NO. 33326792543
	<b>SILENT-BLOC DO BRAÇO DA SUSPENSÃO (FRENTE CENTRO)</b>  BMW 8 (E31) 840 Ci 03.1996/06.1999 210KW 286CV 4398CC M62 B44 (448S1) 0005588 - BMW 8 (E31) 840 i 03.1993/02.1996 210KW 286CV 3982CC M60 B40 (408S1) 0005532 - BMW 8 (E31) 850 Ci 09.1994/12.1999 240KW 326CV 5379CC M73 B54 (54121) 0005553 - BMW 8 (E31) 850 Ci S1 11.1992/12.1996 280KW 380CV 5576CC S70 B56 (56121) 0575309 7909301 - BMW 8 (E31) 850 i, Ci 01.1990/08.1994 220KW 300CV 4988CC M70 B50 (5012)...		<b>SILENT-BLOC BRAÇO SUPERIOR SUSPENSÃO TRÁS EXTERIOR</b>  BMW 3 Gran Turismo (F34) 318 d 03.2013/03.2018 100KW 136CV 1995CC N47 D20 C B47 D20 A 0005BON - BMW 3 Gran Turismo (F34) 318 d 03.2013/06.2015 105KW 143CV 1995CC N47 D20 C 0005BOM - BMW 3 Gran Turismo (F34) 318 d desde 07.2015 110KW 150CV 1995CC B47 D20 A 0005CCS - BMW 3 Gran Turismo (F34) 320 d 03.2013/06.2015 135KW 184CV 1995CC N47 D20 C 0005BOO - BMW 3 Gran Turismo (F34) 320 d 03.2013/06.2015 1...
	d46x52mm c40mm 1f-d12mm		d46x49mm c32mm 1f-d12mm
	<b>S1619</b> NO. 33326792544		<b>UAP81292</b> NO. 13532247156 - 2247156
	<b>SILENT-BLOC BRAÇO SUPERIOR SUSPENSÃO TRÁS INTERIOR</b>  BMW 3 Gran Turismo (F34) 318 d 03.2013/03.2018 100KW 136CV 1995CC N47 D20 C B47 D20 A 0005BON - BMW 3 Gran Turismo (F34) 318 d 03.2013/06.2015 105KW 143CV 1995CC N47 D20 C 0005BOM - BMW 3 Gran Turismo (F34) 318 d desde 07.2015 110KW 150CV 1995CC B47 D20 A 0005CCS - BMW 3 Gran Turismo (F34) 320 d 03.2013/06.2015 135KW 184CV 1995CC N47 D20 C 0005BOO - BMW 3 Gran Turismo (F34) 320 d 03.2013/06.2015 1...		<b>ANILHA PROTEÇÃO TÉRMICA INJECTORES</b>  BMW 3 Gran Turismo (F34) 318 d (De 03-2013 Até .1-20 -) 105kW 143CV 1995cc Hatchback BMW 3 Gran Turismo (F34) 318 d (De 07-2015 Até .1-20 -) 110kW 150CV 1995cc Hatchback BMW 3 Gran Turismo (F34) 320 d (De 03-2013 Até 07-2015) 135kW 184CV 1995cc Hatchback BMW 3 Gran Turismo (F34) 320 d xDrive (De 03-2013 Até 07-2015) 135kW 184CV 1995cc Hatchback BMW 3 Gran Turismo (F34) 320 d (De 07-2015 Até .1-20 -) ...
	d40x48mm c38mm 1f-d12mm		d16x1mm 1f-d7mm
	<b>UAP81905</b> NO. 13532247156 - 2247156		<b>W5142</b> NO. 11238512072 - 11238578993 - 11238585220 - 11238651643
	<b>ANILHA PROTEÇÃO TÉRMICA INJECTORES</b>  BMW 3 Gran Turismo (F34) 318 d (De 03-2013 Até .1-20 -) 105kW 143CV 1995cc Hatchback BMW 3 Gran Turismo (F34) 318 d (De 07-2015 Até .1-20 -) 110kW 150CV 1995cc Hatchback BMW 3 Gran Turismo (F34) 320 d (De 03-2013 Até 07-2015) 135kW 184CV 1995cc Hatchback BMW 3 Gran Turismo (F34) 320 d xDrive (De 03-2013 Até 07-2015) 135kW 184CV 1995cc Hatchback BMW 3 Gran Turismo (F34) 320 d (De 07-2015 Até .1-20 -) ...		<b>POLIE DA CAMBOTA 6 PISTAS</b>  <b>BMW SÉRIE 3 Gran Turismo (F34) 318 d (APÓS 03.13) 143cv 1995cc Hatchback - BMW 3 Gran Turismo (F34) 320 d (03.13 A 07.15) 184cv 1995cc Hatchback</b>
	d14x1mm 1f-d7mm		d185mm d10mm
	<b>W5186</b> NO. 11238515002		<b>W5192</b> NO. 11238602800
	<b>POLIE DA CAMBOTA (6 PISTAS)</b>  BMW 3 Gran Turismo (F34): 335 d xDrive 03.2014/>>> 230KW 313CV 2993CC		<b>POLIE DA CAMBOTA (6 PISTAS)</b>  BMW 3 Gran Turismo (F34): 320 i 07.2016/>>> 135KW 184CV 1998CC - BMW 3 Gran Turismo (F34): 320 i xDrive 07.2016/>>> 135KW 184CV 1998CC - BMW 3 Gran Turismo (F34): 330 i 07.2016/>>> 185KW 252CV 1998CC - BMW 3 Gran Turismo (F34): 330 i xDrive 07.2016/>>> 185KW 252CV 1998CC
	d195/170mm d40mm		d158mm d59mm

	<b>W5208</b> NO. 11237797996 - 11238511321 - 11238518985 - 11238578993 - 11238585220 - 11238586724 - 11238651643		<b>W5210</b> NO. 11237619245 - 11237797996 - 11238518985 - 11238578993 - 11238585220 - 11238586724 - 11238651643
	POLIE DA CAMBOTA (6 pistas) BMW 3 Gran Turismo (F34): 330 d 03.2014/>>> 190KW 258CV 2993CC - BMW 3 Gran Turismo (F34): 330 d xDrive 03.2014/>>> 190KW 258CV 2993CC - BMW 3 Gran Turismo (F34): 330 d 03.2014/>>> 210KW 286CV 2993CC - BMW 3 Gran Turismo (F34): 330 d xDrive 03.2014/>>> 210KW 286CV 2993CC - BMW 3 Gran Turismo (F34): 335 d xDrive 03.2014/>>> 230KW 313CV 2993CC		POLIE DA CAMBOTA (6 PISTAS) BMW 3 Gran Turismo (F34): 318 d 07.2015/>>> 110KW 150CV 1995CC - BMW 3 Gran Turismo (F34): 320 d 07.2015/>>> 140KW 190CV 1995CC - BMW 3 Gran Turismo (F34): 320 d xDrive 07.2015/>>> 140KW 190CV 1995CC - BMW 3 Gran Turismo (F34): 320 d 03.2013/06.2015 147KW 200CV 1995CC
d196mm d40/60mm 4f-d10mm		d155mm d40/60mm 4f-d10mm	
	<b>Z55186</b> NO. 07147145753		
	MOLA DE PAINEL BMW 3 Gran Turismo (F34) 318 d (03.2013 - 03.2018) 100kw 136cv 1995cm3 Hatchback BMW 3 Gran Turismo (F34) 318 d (03.2013 - 06.2015) 105kw 143cv 1995cm3 Hatchback BMW 3 Gran Turismo (F34) 318 d (07.2015 -) 110kw 150cv 1995cm3 Hatchback BMW 3 Gran Turismo (F34) 320 d (03.2013 - 06.2015) 147kw 200cv 1995cm3 Hatchback BMW 3 Gran Turismo (F34) 320 d (03.2013 - 03.2018) 120kw 163cv 1995cm3 Hatchback BMW...		
d8x 18mm f-d18mm			

**BMW SERIE 3 TOURING SERIE 3(F31)**

	<b>W5210</b> NO. 11237619245 - 11237797996 - 11238518985 - 11238578993 - 11238585220 - 11238586724 - 11238651643		
	POLIE DA CAMBOTA (6 PISTAS) BMW 3 Touring (F31): 318 d 07.2015/06.2019 110KW 150CV 1995CC - BMW 3 Touring (F31): 318 d xDrive 07.2015/02.2018 110KW 150CV 1995CC - BMW 3 Touring (F31): 320 d 07.2012/06.2019 120KW 163CV 1995CC - BMW 3 Touring (F31): 320 d 07.2015/06.2019 140KW 190CV 1995CC - BMW 3 Touring (F31): 320 d xDrive 07.2015/06.2019 140KW 190CV 1995CC		
d155mm d40/60mm 4f-d10mm			

**BMW SERIE 4 (F32) - (F82) - (F33) - (F83)**





	<b>A2569</b> NO. 22316796617		<b>A2569</b> NO. 22316796617
	APOIO DA CAIXA DE VELOCIDADES BMW 4 Cabriolet (F33, F83) 420 d (De 10.2013 Até 06.2015) 135kW 184cv 1995cm3 Cabriolet - BMW 4 Cabriolet (F33, F83) 420 d (De 07.2015 -) 140kW 190cv 1995cm3 Cabriolet - BMW 4 Cabriolet (F33, F83) 420 i (De 07.2014 Até 02.2016) 135kW 184cv 1997cm3 Cabriolet - BMW 4 Cabriolet (F33, F83) 420 i (De 03.2016 -) 135kW 184cv 1998cm3 Cabriolet - BMW 4 Cabriolet (F33, F83) 425 d (De 03.2016 Até 02.2018) 1...		APOIO DA CAIXA DE VELOCIDADES BMW 4 Coupé (F32, F82) 418 d (De 03.2015 Até 10.2017) 110KW 150cv 1995cm3 Coupé - BMW 4 Coupé (F32, F82) 420 d (De 07.2013 Até 02.2015) 135kW 184cv 1995cm3 Coupé - BMW 4 Coupé (F32, F82) 420 d (De 03.2015 -) 140kW 190cv 1995cm3 Coupé - BMW 4 Coupé (F32, F82) 420 i (De 11.2013 Até 02.2017) 135kW 184cv 1997cm3 Coupé - BMW 4 Coupé (F32, F82) 420 i (De 03.2016 -) 135kW 184cv 1998cm3 Coupé - BMW 4 Cou...
74x46x40mm 1p-d7x16mm 1p-d8x31mm		74x46x40mm 1p-d7x16mm 1p-d8x31mm	
	<b>D0022</b> NO. 26111209168 - 26111227420 - 26111227717 - 26111229080 - 26111229360 - 26117511454		<b>D0022</b> NO. 26111209168 - 26111227420 - 26111227717 - 26111229080 - 26111229360 - 26117511454
	CARDAN TRANSMISSÃO D135X30MM 6 FUROS 12MM ENTRE FUROS 96MM BMW SERIE 4 (F32)		CARDAN TRANSMISSÃO D135X30MM 6 FUROS 12MM ENTRE FUROS 96MM BMW SERIE 4 (F33)
d132x123x30mm 6f-d12mm		d132x123x30mm 6f-d12mm	
	<b>D0022</b> NO. 26111209168 - 26111227420 - 26111227717 - 26111229080 - 26111229360 - 26117511454		<b>D0022</b> NO. 26111209168 - 26111227420 - 26111227717 - 26111229080 - 26111229360 - 26117511454
	CARDAN TRANSMISSÃO D135X30MM 6 FUROS 12MM ENTRE FUROS 96MM BMW SERIE 4 (F82)		CARDAN TRANSMISSÃO D135X30MM 6 FUROS 12MM ENTRE FUROS 96MM BMW SERIE 4 (F83)
d132x123x30mm 6f-d12mm		d132x123x30mm 6f-d12mm	



	<p><b>F4363</b> NO. 25117596009</p> <p><b>FOLE ALAVANCA VELOCIDADES C/ MANETE PUNHO TOPO COMPLETO 6 VELOCIDADES</b></p> <p>BMW 4 Coupé (F32, F82) 420 d xDrive 11.2013/02.2015 135KW 184CV 1995CC N47 D20 C 0005BSV - BMW 4 Coupé (F32, F82) 420 d xDrive 11.2013/03.2015 147KW 200CV 1995CC N47 D20 C 0005BSX</p> <p>d37x152x146mm 1f-134x141mm</p>		<p><b>KUR21999</b> NO. 1f-d24mm 1f-d10mm 1f-d10mm 1f-d19mm</p> <p><b>KIT DE REPARAÇÃO ALAVANCA DE VELOCIDADES</b></p> <p>BMW 4 Cabriolet (F33, F83) 420 d (De 11.2013 -) 120kW 163cv 1995cm3 Cabriolet - BMW 4 Cabriolet (F33, F83) 420 d (De 10.2013 Até 06.2015) 135kW 184cv 1995cm3 Cabriolet - BMW 4 Cabriolet (F33, F83) 420 d (De 07.2015 -) 140kW 190cv 1995cm3 Cabriolet - BMW 4 Cabriolet (F33, F83) 420 d (De 10.2013 Até 06.2015) 147KW 200cv 1995cm3 Cabriolet - BMW 4 Cabriolet (F33, F83) 420 i (De 07.2014 Até 02.2016) 13... d37x18mm d19x25mm d17x22x4mm d31x210mm d31x26x120mm d44x19x4mm d19x15mm</p>
	<p><b>KUR21999</b> NO. 1f-d24mm 1f-d10mm 1f-d10mm 1f-d19mm</p> <p><b>KIT DE REPARAÇÃO ALAVANCA DE VELOCIDADES</b></p> <p>BMW 4 Coupé (F32, F82) 418 d (De 03.2015 Até 10.2017) 110kW 150cv 1995cm3 Coupé - BMW 4 Coupé (F32, F82) 418 i (De 03.2016 -) 100kW 136cv 1499cm3 Coupé - BMW 4 Coupé (F32, F82) 420 d (De 07.2013 -) 120kW 163cv 1995cm3 Coupé - BMW 4 Coupé (F32, F82) 420 d (De 07.2013 Até 02.2015) 135kW 184cv 1995cm3 Coupé - BMW 4 Coupé (F32, F82) 420 d (De 2003.2015 -) 140kW 190cv 1995cm3 Coupé - BMW 4 Coupé (F32, ... d37x18mm d19x25mm d17x22x4mm d31x210mm d31x26x120mm d44x19x4mm</p>		<p><b>S1618</b> NO. 33326792543</p> <p><b>SILENT-BLOC BRAÇO SUPERIOR SUSPENSÃO TRÁS EXTERIOR</b></p> <p>BMW 4 Coupé (F32, F82) 418 d 03.2015/10.2017 110KW 150CV 1995CC B47 D20 A 0005CBA - BMW 4 Coupé (F32, F82) 418 i 03.2016/06.2020 100KW 136CV 1499CC B38 B15 A 0005CGT - BMW 4 Coupé (F32, F82) 420 d 07.2013/02.2015 135KW 184CV 1995CC N47 D20 C 0005BQZ - BMW 4 Coupé (F32, F82) 420 d 03.2015/06.2020 140KW 190CV 1995CC B47 D20 A 0005CBC - BMW 4 Coupé (F32, F82) 420 d xDrive 11.2013/02.2015 135KW 184CV ... .d46x49mm c32mm 1f-d12mm</p>
	<p><b>S1618</b> NO. 33326792543</p> <p><b>SILENT-BLOC BRAÇO SUPERIOR SUSPENSÃO TRÁS EXTERIOR</b></p> <p>BMW 4 Cabriolet (F33, F83) 420 d 10.2013/06.2015 135KW 184CV 1995CC N47 D20 C 0005BTC - BMW 4 Cabriolet (F33, F83) 420 d 10.2013/06.2015 147KW 200CV 1995CC N47 D20 C 0005BTE - BMW 4 Cabriolet (F33, F83) 420 d 07.2015/07.2020 140KW 190CV 1995CC B47 D20 A 0005CDD - BMW 4 Cabriolet (F33, F83) 420 i 07.2014/02.2016 135KW 184CV 1997CC N20 B20 B 0005BVV - BMW 4 Cabriolet (F33, F83) 420 i 03.2016/07.2020... d46x49mm c32mm 1f-d12mm</p>		<p><b>S1619</b> NO. 33326792544</p> <p><b>SILENT-BLOC BRAÇO SUPERIOR SUSPENSÃO TRÁS INTERIOR</b></p> <p>BMW 4 Coupé (F32, F82) 418 d 03.2015/10.2017 110KW 150CV 1995CC B47 D20 A 0005CBA - BMW 4 Coupé (F32, F82) 418 i 03.2016/06.2020 100KW 136CV 1499CC B38 B15 A 0005CGT - BMW 4 Coupé (F32, F82) 420 d 07.2013/02.2015 135KW 184CV 1995CC N47 D20 C 0005BQZ - BMW 4 Coupé (F32, F82) 420 d 03.2015/06.2020 140KW 190CV 1995CC B47 D20 A 0005CBC - BMW 4 Coupé (F32, F82) 420 d xDrive 11.2013/02.2015 135KW 184CV ... d40x48mm c38mm 1f-d12mm</p>
	<p><b>S1619</b> NO. 33326792544</p> <p><b>SILENT-BLOC BRAÇO SUPERIOR SUSPENSÃO TRÁS INTERIOR</b></p> <p>BMW 4 Cabriolet (F33, F83) 420 d 10.2013/06.2015 135KW 184CV 1995CC N47 D20 C 0005BTC - BMW 4 Cabriolet (F33, F83) 420 d 10.2013/06.2015 147KW 200CV 1995CC N47 D20 C 0005BTE - BMW 4 Cabriolet (F33, F83) 420 d 07.2015/07.2020 140KW 190CV 1995CC B47 D20 A 0005CDD - BMW 4 Cabriolet (F33, F83) 420 i 07.2014/02.2016 135KW 184CV 1997CC N20 B20 B 0005BVV - BMW 4 Cabriolet (F33, F83) 420 i 03.2016/07.2020... d40x48mm c38mm 1f-d12mm</p>		<p><b>UAP81292</b> NO. 13532247156 - 2247156</p> <p><b>ANILHA PROTEÇÃO TÉRMICA INJECTORES</b></p> <p>BMW 4 Coupé (F32 - F82) 420 d xDrive (De 11-2013 Até 03-2015) 135kW 184CV 1995cc Coupé BMW 4 Coupé (F32 - F82) 425 d (De 01-2014 Até .1-20 -) 160kW 218CV 1995cc Coupé BMW 4 Coupé (F32 - F82) 430 d (De 11-2013 Até .1-20 -) 190kW 258CV 2993cc Coupé BMW 4 Coupé (F32 - F82) 430 d xDrive (De 01-2014 Até .1-20 -) 190kW 258CV 2993cc Coupé BMW 4 Coupé (F32 - F82) 435 d xDrive (De 11-2013 Até .1-20 -) 230k... d16x1mm 1f-d7mm</p>
	<p><b>UAP81292</b> NO. 13532247156 - 2247156</p> <p><b>ANILHA PROTEÇÃO TÉRMICA INJECTORES</b></p> <p>BMW 4 Cabriolet (F33 - F83) 420 d (De 10-2013 Até 07-2015) 135kW 184CV 1995cc Cabriolet BMW 4 Cabriolet (F33 - F83) 420 d (De 07-2015 Até .1-20 -) 140kW 190CV 1995cc Cabriolet BMW 4 Cabriolet (F33 - F83) 425 d (De 07-2014 Até .1-20 -) 160kW 218CV 1995cc Cabriolet BMW 4 Cabriolet (F33 - F83) 430 d (De 07-2014 Até .1-20 -) 190kW 258CV 2993cc Cabriolet BMW 4 Cabriolet (F33 - F83) 435 d xDrive (De 07-... d16x1mm 1f-d7mm</p>		<p><b>UAP81905</b> NO. 13532247156 - 2247156</p> <p><b>ANILHA PROTEÇÃO TÉRMICA INJECTORES</b></p> <p>BMW 4 Coupé (F32 - F82) 420 d xDrive (De 11-2013 Até 03-2015) 135kW 184CV 1995cc Coupé BMW 4 Coupé (F32 - F82) 425 d (De 01-2014 Até .1-20 -) 160kW 218CV 1995cc Coupé BMW 4 Coupé (F32 - F82) 430 d (De 11-2013 Até .1-20 -) 190kW 258CV 2993cc Coupé BMW 4 Coupé (F32 - F82) 430 d xDrive (De 01-2014 Até .1-20 -) 190kW 258CV 2993cc Coupé BMW 4 Coupé (F32 - F82) 435 d xDrive (De 11-2013 Até .1-20 -) 230k... d14x1mm 1f-d7mm</p>
	<p><b>UAP81905</b> NO. 13532247156 - 2247156</p> <p><b>ANILHA PROTEÇÃO TÉRMICA INJECTORES</b></p> <p>BMW 4 Cabriolet (F33 - F83) 420 d (De 10-2013 Até 07-2015) 135kW 184CV 1995cc Cabriolet BMW 4 Cabriolet (F33 - F83) 420 d (De 07-2015 Até .1-20 -) 140kW 190CV 1995cc Cabriolet BMW 4 Cabriolet (F33 - F83) 425 d (De 07-2014 Até .1-20 -) 160kW 218CV 1995cc Cabriolet BMW 4 Cabriolet (F33 - F83) 430 d (De 07-2014 Até .1-20 -) 190kW 258CV 2993cc Cabriolet BMW 4 Cabriolet (F33 - F83) 435 d xDrive (De 07-... d14x1mm 1f-d7mm</p>		<p><b>W5142</b> NO. 11238512072 - 11238578993 - 11238585220 - 11238651643</p> <p><b>POLIE DA CAMBOTA 6 PISTAS</b></p> <p>BMW SÉRIE 4 Coupé (F32 - F82) 420 d (07.13 A 03.15) 184cv 1995cc Coupé d185mm d10mm</p>
	<p><b>W5186</b> NO. 11238515002</p> <p><b>POLIE DA CAMBOTA (6 PISTAS)</b></p> <p>BMW 4 Coupé (F32, F82): 430 d 11.2013/&gt;&gt;&gt; 190KW 258CV 2993CC - BMW 4 Coupé (F32, F82): 430 d xDrive 03.2014/&gt;&gt;&gt; 190KW 258CV 2993CC d195/170mm d40mm</p>		<p><b>W5186</b> NO. 11238515002</p> <p><b>POLIE DA CAMBOTA (6 PISTAS)</b></p> <p>BMW 4 Cabriolet (F33, F83): 430 d 07.2014/&gt;&gt;&gt; 190KW 258CV 2993CC d195/170mm d40mm</p>
	<p><b>W5186</b> NO. 11238515002</p> <p><b>POLIE DA CAMBOTA (6 PISTAS)</b></p> <p>BMW 4 Coupé (F32, F82): 430 d 11.2013/&gt;&gt;&gt; 190KW 258CV 2993CC - BMW 4 Coupé (F32, F82): 430 d xDrive 03.2014/&gt;&gt;&gt; 190KW 258CV 2993CC d195/170mm d40mm</p>		<p><b>W5186</b> NO. 11238515002</p> <p><b>POLIE DA CAMBOTA (6 PISTAS)</b></p> <p>BMW 4 Cabriolet (F33, F83): 430 d 07.2014/&gt;&gt;&gt; 190KW 258CV 2993CC d195/170mm d40mm</p>

	<b>W5192</b>	NO. 11238602800		<b>W5192</b>	NO. 11238602800
	POLIE DA CAMBOTA (6 PISTAS)			POLIE DA CAMBOTA (6 PISTAS)	
BMW 4 Coupé (F32, F82): 420 i 03.2016/>>> 135KW 184CV 1998CC - BMW 4 Coupé (F32, F82): 430 i xDrive 03.2016/>>> 185KW 252CV 1998CC			BMW 4 Cabriolet (F33, F83): 420 i 03.2016/>>> 135KW 184CV 1998CC - BMW 4 Cabriolet (F33, F83): 430 i 03.2016/>>> 185KW 252CV 1998CC - BMW 4 Cabriolet (F33, F83): 430 i xDrive 03.2016/>>> 185KW 252CV 1998CC		
d158mm		d59mm	d158mm		d59mm
	<b>W5192</b>	NO. 11238602800		<b>W5192</b>	NO. 11238602800
	POLIE DA CAMBOTA (6 PISTAS)			POLIE DA CAMBOTA (6 PISTAS)	
BMW 4 Cabriolet (F33, F83): 420 i 03.2016/>>> 135KW 184CV 1998CC - BMW 4 Cabriolet (F33, F83): 430 i 03.2016/>>> 185KW 252CV 1998CC - BMW 4 Cabriolet (F33, F83): 430 i xDrive 03.2016/>>> 185KW 252CV 1998CC			BMW 4 Coupé (F32, F82): 420 i 03.2016/>>> 135KW 184CV 1998CC - BMW 4 Coupé (F32, F82): 430 i xDrive 03.2016/>>> 185KW 252CV 1998CC		
d158mm		d59mm	d158mm		d59mm
	<b>W5208</b>	NO. 11237797996 - 11238511321 - 11238518985 - 11238578993 - 11238585220 - 11238586724 - 11238651643		<b>W5208</b>	NO. 11237797996 - 11238511321 - 11238518985 - 11238578993 - 11238585220 - 11238586724 - 11238651643
	POLIE DA CAMBOTA (6 PISTAS)			POLIE DA CAMBOTA (6 PISTAS)	
BMW 4 Cabriolet (F33, F83): 430 d 07.2014/>>> 190KW 258CV 2993CC - BMW 4 Cabriolet (F33, F83): 430 d 07.2014/>>> 210KW 286CV 2993CC - BMW 4 Cabriolet (F33, F83): 435 d xDrive 07.2014/>>> 230KW 313CV 2993CC			BMW 4 Coupé (F32, F82): 430 d 11.2013/>>> 190KW 258CV 2993CC - BMW 4 Coupé (F32, F82): 430 d xDrive 03.2014/>>> 190KW 258CV 2993CC - BMW 4 Coupé (F32, F82): 430 d 11.2013/>>> 210KW 286CV 2993CC - BMW 4 Coupé (F32, F82): 430 d xDrive 03.2014/>>> 210KW 286CV 2993CC - BMW 4 Coupé (F32, F82): 435 d xDrive 11.2013/12.2020 230KW 313CV 2993CC		
d196mm		d40/60mm 4f-d10mm	d196mm		d40/60mm 4f-d10mm
	<b>W5210</b>	NO. 11237619245 - 11237797996 - 11238518985 - 11238578993 - 11238585220 - 11238586724 - 11238651643		<b>W5210</b>	NO. 11237619245 - 11237797996 - 11238518985 - 11238578993 - 11238585220 - 11238586724 - 11238651643
	POLIE DA CAMBOTA (6 PISTAS)			POLIE DA CAMBOTA (6 PISTAS)	
BMW 4 Cabriolet (F33, F83) 420 d 11.2013/>>> 120KW 163CV 1995CC - BMW 4 Cabriolet (F33, F83): 420 d 07.2015/>>> 140KW 190CV 1995CC			BMW 4 Coupé (F32, F82) 418 d 03.2015/10.2017 100kW 136CV 1995CC - BMW 4 Coupé (F32, F82): 418 d 03.2015/10.2017 110kW 150CV 1995CC - BMW 4 Coupé (F32, F82): 420 d 03.2015/>>> 140KW 190CV 1995CC - BMW 4 Coupé (F32, F82): 420 d xDrive 03.2015/>>> 140KW 190CV 1995CC - BMW 4 Coupé (F32, F82): 425 d 03.2016/10.2017 165KW 224CV 1995CC		
d155mm		d40/60mm 4f-d10mm	d155mm		d40/60mm 4f-d10mm
	<b>Z55278</b>	NO. 51410407983 - 51418224781 - 51430141025		<b>Z55278</b>	NO. 51410407983 - 51418224781 - 51430141025
	MOLA PAINEL RESVESTIMENTO PORTAS			MOLA PAINEL RESVESTIMENTO PORTAS	
BMW 4 Cabriolet (F33, F83) 420 d (11.2013 - 07.2020) 120kw 163cv 1995cm3 Cabriolet BMW 4 Cabriolet (F33, F83) 420 d (10.2013 - 06.2015) 135kw 184cv 1995cm3 Cabriolet BMW 4 Cabriolet (F33, F83) 420 d (07.2015 - 07.2020) 140kw 190cv 1995cm3 Cabriolet BMW 4 Cabriolet (F33, F83) 420 d (10.2013 - 06.2015) 147kw 200cv 1995cm3 Cabriolet BMW 4 Cabriolet (F33, F83) 420 d (07.2015 - 07.2020) 151kw 205cv 199...			BMW 4 Coupé (F32, F82) 418 d (03.2015 - 10.2017) 100kw 136cv 1995cm3 Coupé BMW 4 Coupé (F32, F82) 418 d (03.2015 - 10.2017) 110kw 150cv 1995cm3 Coupé BMW 4 Coupé (F32, F82) 418 i (03.2016 - 06.2020) 100kw 136cv 1499cm3 Coupé BMW 4 Coupé (F32, F82) 420 d (07.2013 - 06.2020) 120kw 163cv 1995cm3 Coupé BMW 4 Coupé (F32, F82) 420 d (07.2013 - 02.2015) 135kw 184cv 1995cm3 Coupé BMW 4 Coupé (F32, F82) 42...		
F-8T-18mm		L-14H-21S1-7mm	F-8T-18mm		L-14H-21S1-7mm

**BMW SERIE 4 (F36)**

	<b>A2569</b>	NO. 22316796617		<b>D0022</b>	NO. 26111209168 - 26111227420 - 26111227717 - 26111229080 - 26111229360 - 26117511454
	APOIO DA CAIXA DE VELOCIDADES			CARDAN TRANSMISSÃO D135X30MM 6 FUROS 12MM ENTRE FUROS 96MM	
BMW 4 Gran Coupe (F36) 418 d (De 03.2014 Até 06.2015) 105kW 143cv 1995cm3 Coupé - BMW 4 Gran Coupe (F36) 418 d (De 07.2015 Até 12.2020) 110kW 150cv 1995cm3 Coupé - BMW 4 Gran Coupe (F36) 420 d (De 03.2014 Até 02.2015) 135kW 184cv 1995cm3 Coupé - BMW 4 Gran Coupe (F36) 420 d (De 03.2015 -) 140kW 190cv 1995cm3 Coupé - BMW 4 Gran Coupe (F36) 420 i (De 03.2014 Até 02.2017) 135kW 184cv 1997cm3 Coupé - ...			BMW SERIE 4 (F36)		
74x46x40mm		1p-d7x16mm 1p-d8x31mm	d132x123x30mm		6f-d12mm
	<b>F4363</b>	NO. 25117596009		<b>KUR21999</b>	NO. 1f-d24mm 1f-d10mm 1f-d10mm 1f-d19mm
	FOLE ALAVANCA VELOCIDADES C/ MANETE PUNHO TOPO COMPLETO 6 VELOCIDADES			KIT DE REPARAÇÃO ALAVANCA DE VELOCIDADES	
BMW 4 Gran Coupe (F36) 418 d 03.2014/12.2020 100KW 136CV 1995CC B47 D20 A N47 D20 C 0005BUU - BMW 4 Gran Coupe (F36) 418 d 03.2014/06.2015 105KW 143CV 1995CC N47 D20 C 0005BUT - BMW 4 Gran Coupe (F36) 420 d 03.2014/12.2020 120KW 163CV 1995CC N47 D20 C B47 D20 A 0005BUW - BMW 4 Gran Coupe (F36) 420 d 03.2014/02.2015 135KW 184CV 1995CC N47 D20 C 0005BUV - BMW 4 Gran Coupe (F36) 420 d 03.2014/02.2015...			BMW 4 Gran Coupe (F36) 418 d (De 09.2014 -) 100kW 136cv 1995cm3 Coupé - BMW 4 Gran Coupe (F36) 418 d (De 03.2014 Até 06.2015) 105kW 143cv 1995cm3 Coupé - BMW 4 Gran Coupe (F36) 418 d (De 07.2015 -) 110kW 150cv 1995cm3 Coupé - BMW 4 Gran Coupe (F36) 418 i (De 07.2015 -) 100kW 136cv 1499cm3 Coupé - BMW 4 Gran Coupe (F36) 420 d (De 03.2014 -) 120kW 163cv 1995cm3 Coupé - BMW 4 Gran Coupe (F36) 420 d ...		
240x152x146mm		1f-134x141mm	d37x18mm d19x25mm d7		d22x4mm d31x20mm d43x20mm d41x20mm d41x19mm d19x15mm

## BMW SERIE 4 (F36)

Rafri, Lda.

	<b>S1618</b> NO. 33326792543 <b>SILENT-BLOC BRAÇO SUPERIOR SUSPENSÃO TRÁS EXTERIOR</b> BMW 4 Gran Coupe (F36) 418 d 03.2014/12.2020 100KW 136CV 1995CC B47 D20 A N47 D20 C 0005BUU - BMW 4 Gran Coupe (F36) 418 d 03.2014/06.2015 105KW 143CV 1995CC N47 D20 C 0005BUT - BMW 4 Gran Coupe (F36) 418 d 07.2015/12.2020 110KW 150CV 1995CC B47 D20 A 0005CDF - BMW 4 Gran Coupe (F36) 418 i 07.2015/12.2020 100KW 136CV 1499CC B38 B15 A 0005CBG - BMW 4 Gran Coupe (F36) 420 d 03.2014/12.2020 120KW 163... d46x49mm c32mm 1f-d12mm		<b>S1619</b> NO. 33326792544 <b>SILENT-BLOC BRAÇO SUPERIOR SUSPENSÃO TRÁS INTERIOR</b> BMW 4 Gran Coupe (F36) 418 d 03.2014/12.2020 100KW 136CV 1995CC B47 D20 A N47 D20 C 0005BUU - BMW 4 Gran Coupe (F36) 418 d 03.2014/06.2015 105KW 143CV 1995CC N47 D20 C 0005BUT - BMW 4 Gran Coupe (F36) 418 d 07.2015/12.2020 110KW 150CV 1995CC B47 D20 A 0005CDF - BMW 4 Gran Coupe (F36) 418 i 07.2015/12.2020 100KW 136CV 1499CC B38 B15 A 0005CBG - BMW 4 Gran Coupe (F36) 420 d 03.2014/12.2020 120KW 163... d40x48mm c38mm 1f-d12mm
	<b>UAP81292</b> NO. 13532247156 - 2247156 <b>ANILHA PROTEÇÃO TÉRMICA INJECTORES</b> BMW 4 Gran Coupe (F36) 418 d (De 03-2014 Até .1-20 -) 105kW 143CV 1995cc Coupé BMW 4 Gran Coupe (F36) 418 d (De 07-2015 Até .1-20 -) 110kW 150CV 1995cc Coupé BMW 4 Gran Coupe (F36) 420 d (De 03-2014 Até 03-2015) 135kW 184CV 1995cc Coupé BMW 4 Gran Coupe (F36) 420 d xDrive (De 03-2014 Até 03-2015) 135kW 184CV 1995cc Coupé BMW 4 Gran Coupe (F36) 430 d (De 07-2014 Até .1-20 -) 190kW 258CV 2993cc Coup... d16x1mm 1f-d7mm		<b>UAP81905</b> NO. 13532247156 - 2247156 <b>ANILHA PROTEÇÃO TÉRMICA INJECTORES</b> BMW 4 Gran Coupe (F36) 418 d (De 03-2014 Até .1-20 -) 105kW 143CV 1995cc Coupé BMW 4 Gran Coupe (F36) 418 d (De 07-2015 Até .1-20 -) 110kW 150CV 1995cc Coupé BMW 4 Gran Coupe (F36) 420 d (De 03-2014 Até 03-2015) 135kW 184CV 1995cc Coupé BMW 4 Gran Coupe (F36) 420 d xDrive (De 03-2014 Até 03-2015) 135kW 184CV 1995cc Coupé BMW 4 Gran Coupe (F36) 430 d (De 07-2014 Até .1-20 -) 190kW 258CV 2993cc Coup... d14x1mm 1f-d7mm
	<b>W5186</b> NO. 11238515002 <b>POLIE DA CAMBOTA (6 PISTAS)</b> BMW 4 Gran Coupe (F36): 430 d 07.2014/>>> 190KW 258CV 2993CC - BMW 4 Gran Coupe (F36): 430 d xDrive 07.2014/>>> 190KW 258CV 2993CC - BMW 4 Gran Coupe (F36): 435 d xDrive 07.2014/>>> 230KW 313CV 2993CC d195/170mm d40mm		<b>W5192</b> NO. 11238602800 <b>POLIE DA CAMBOTA (6 PISTAS)</b> BMW 4 Gran Coupe (F36): 420 i xDrive 03.2016/>>> 135KW 184CV 1998CC - BMW 4 Gran Coupe (F36): 430 i 03.2016/>>> 185KW 252CV 1998CC - BMW 4 Gran Coupe (F36): 430 i xDrive 03.2016/>>> 185KW 252CV 1998CC d158mm d59mm
	<b>W5208</b> NO. 11237797996 - 11238511321 - 11238518985 - 11238578993 - 11238585220 - 11238586724 - 11238651643 <b>POLIE DA CAMBOTA (6 pistas)</b> BMW 4 Gran Coupe (F36): 430 d 07.2014/>>> 210KW 286CV 2993CC - BMW 4 Gran Coupe (F36): 430 d xDrive 07.2014/>>> 210KW 286CV 2993CC d196mm d40/60mm 4f-d10mm		<b>W5210</b> NO. 11237619245 - 11237797996 - 11238578993 - 11238585220 - 11238586724 - 11238651643 <b>POLIE DA CAMBOTA (6 PISTAS)</b> BMW 4 Gran Coupe (F36) 418 d 03.2014/06.2015) 100KW 136CV 1995CC - BMW 4 Gran Coupe (F36): 418 d 07.2015/>>> 110KW 150CV 1995CC - BMW 4 Gran Coupe (F36) 420 d xDrive 03.2014/02.2015) 120KW 163CV 1995CC - BMW 4 Gran Coupe (F36): 420 d 03.2015/>>> 140KW 190CV 1995CC - BMW 4 Gran Coupe (F36): 420 d xDrive 03.2015/>>> 140KW 190CV 1995CC d155mm d40/60mm 4f-d10mm
	<b>Z55186</b> NO. 07147145753 <b>MOLA DE PAINEL</b> BMW 4 Gran Coupe (F36) 418 d (03.2014 - 12.2020) 100kw 136cv 1995cm3 Coupé BMW 4 Gran Coupe (F36) 418 d (03.2014 - 06.2015) 105kw 143cv 1995cm3 Coupé BMW 4 Gran Coupe (F36) 418 d (07.2015 - 12.2020) 110kw 150cv 1995cm3 Coupé BMW 4 Gran Coupe (F36) 418 i (07.2015 - 12.2020) 100kw 136cv 1499cm3 Coupé BMW 4 Gran Coupe (F36) 420 d (03.2014 - 12.2020) 120kw 163cv 1995cm3 Coupé BMW 4 Gran Coupe (F36) 42... d8x 18mm f-d18mm		

## BMW SERIE 5(E12)

	<b>A0948</b> NO. 26111206502 - 26121104355 - A26111206502 <b>APOIO SUPORTE CENTRAL DA TRANSMISSÃO COM ROLAMENTO</b> BMW 5 (E12) 518 07.1974/05.1981 66KW 90CV 1766CC M10 B18 (184VB) 0005400 0005379 - BMW 5 (E12) 518 i 06.1979 - 06.1981 75 102 1766 M10 B18 (184EB) - BMW 5 (E12) 520 06.1972/01.1979 85KW 115CV 1990CC M10 B20 0005373 - BMW 5 (E12) 520 i 03.1972/07.1979 92KW 125CV 1990CC M10 B20 0005391 - BMW 5 (E12) 520 i 08.1972/10.1975 96KW 131CV 1990CC M10 B20 0005374 - BMW 5 (E12) 520/6 03.1977/06.1981 90KW 122C... 155x101x42mm d30mm		<b>A1317</b> NO. 11811132321 - 11811132323 - 11811175212 - 11811246437 <b>APOIO SUPORTE DA FRENTE ESQUERDA DO MOTOR</b> BMW 5 (E12) 520/6 03.1977/06.1981 90KW 122CV 1990CC M20 B20 (206VA) 0005401 d70x48mm 1p-d10-35mm 1p-d10-22mm
	<b>A1949</b> NO. 0019811225 - 0029812925 - 0039812325 - 0089814325 - 26121103728 - 26121209590 - 26121225071 - 261212... <b>APOIO DA TRANSMISSÃO</b> BMW 5 (E12) 518 (07.74 A 05.81) 90cv 1766cc três volumes - BMW 5 (E12) 520 (08.72 A 08.77) 115cv 1990cc três volumes - BMW 5 (E12) 520 i (03.72 A 07.79) 125cv 1990cc três volumes - BMW 5 (E12) 520 i (08.72 A 10.75) 131cv 1990cc três volumes - BMW 5 (E12) 520/6 (09.77 A 05.81) 122cv 1990cc três volumes - BMW 5 (E12) 525 (06.73 A 06.81) 146cv 2494cc três volumes - BMW 5 (E12) 525 (08.76 ... 170x110x56mm 1f-d30mm		<b>A2292</b> NO. 11811109174 <b>APOIO DO MOTOR LADO ESQUERDO</b> BMW 5 (E12) 518 (De 1974.07 Até 1981.05) 66kW 90cv 1766cm3 três volumes - BMW 5 (E12) 520 (De 1972.06 Até 1979.01) 85kW 115cv 1990cm3 três volumes - BMW 5 (E12) 520 i (De 1972.03 Até 1979.07) 92kW 125cv 1990cm3 três volumes - BMW 5 (E12) 520 i (De 1972.08 Até 1975.10) 96kW 131cv 1990cm3 três volumes - 80x60x78mm 2p-d10x18mm



	<p><b>D0004</b> NO. 1 106 113 - 26111106113</p> <p>CARDAN TRANSMISSÃO D107X38MM 8 FUROS 10MM ENTRE FUROS 76MM</p> <p>BMW 5 (E12): 518 07.1974/05.1981 66KW 90CV 1766CC - BMW 5 (E12): 520 06.1972/01.1979 85KW 115CV 1990CC - BMW 5 (E12): 520 i 03.1972/07.1979 92KW 125CV 1990CC - BMW 5 (E12): 520 i 08.1972/10.1975 96KW 131CV 1990CC - BMW 5 (E12): 520/6 03.1977/06.1981 90KW 122CV 1990CC</p> <p>d110x39mm 8f-d9mm</p>		<p><b>D0022</b> NO. 26111209168 - 26111227420 - 26111227717 - 26111229080 - 26111229360 - 26117511454</p> <p>CARDAN TRANSMISSÃO D135X30MM 6 FUROS 12MM ENTRE FUROS 96MM</p> <p>BMW 5 (E12) 525 10.1973/08.1976 107KW 145CV 2494CC M30 B25 A 0005375 - BMW 5 (E12) 525 08.1975/06.1981 110KW 150CV 2494CC M30 B25 (256VA) 0005394 0005402 - BMW 5 (E12) 528 i 03.1977/09.1979 130KW 177CV 2788CC M30 B28 0005403 - BMW 5 (E12) 528 i 08.1979/06.1981 135KW 184CV 2788CC M30 B28 0005410 - BMW 5 (E12) M535 i 04.1980/05.1981 160KW 218CV 3453CC M30 B35 (356EA) 0005415</p> <p>d132x123x30mm 6f-d12mm</p>
	<p><b>D0026</b> NO. 26111204294 - 26111207785 - 26111225624</p> <p>CARDAN TRANSMISSÃO D110X28MM 6 FUROS 10MM ENTRE FUROS 78MM</p> <p>BMW 5 (E12) 518 (07.74 A 05.81) 90cv 1766cc três volumes 4 / 5 - BMW 5 (E12) 520 (08.72 A 08.77) 115cv 1990cc três volumes - BMW 5 (E12) 520 i (10.75 A 05.77) 125cv 1990cc três volumes - BMW 5 (E12) 520 i (08.72 A 10.75) 131cv 1990cc três volumes - BMW 5 (E12) 520/6 (09.77 A 05.81) 122cv 1990cc três volumes - BMW 5 (E28) 518 (06.81 A 08.84) 90cv 1766cc três volumes - BMW 5 (E28) 518 i...</p> <p>d110x28mm 1f-d40mm 6f-d10mm</p>		<p><b>D0059</b> NO. 26111109603</p> <p>CARDAN TRANSMISSÃO</p> <p>BMW 5 (E12) 518 (De 07-1974 Até 05-1981) 66kW 90CV 1766cc três volumes BMW 5 (E12) 520 (De 08-1972 Até 08-1977) 85kW 115CV 1990cc três volumes BMW 5 (E12) 525 (De 06-1973 Até 06-1981) 107kW 146CV 2494cc três volumes BMW 5 (E12) 525 (De 08-1976 Até 05-1981) 110kW 150CV 2494cc três volumes BMW 5 (E12) 528 i 08.1979/06.1981 135KW 184CV 2788CC - BMW 5 (E12): 528 i 08.1979/06.1981 135KW 184CV 2788CC - BMW 5 (E12): 528 i 08...</p> <p>d135x30mm 6f-d12mm</p>
	<p><b>D0077</b> NO. 32311112359</p> <p>CARDAN DIRECÇÃO</p> <p>BMW 5 (E12): 518 07.1974/05.1981 66KW 90CV 1766CC - BMW 5 (E12): 518 i 06.1979/06.1981 75KW 102CV 1766CC - BMW 5 (E12): 520 06.1972/01.1979 85KW 115CV 1990CC - BMW 5 (E12): 520 i 03.1972/07.1979 92KW 125CV 1990CC - BMW 5 (E12): 520 i 08.1972/10.1975 96KW 131CV 1990CC - BMW 5 (E12): 520/6 03.1977/06.1981 90KW 122CV 1990CC - BMW 5 (E12): 525 10.1973/08.1976 107KW 145CV 2494CC - BMW 5 (E12): 525 08.1...</p> <p>d74x12mm 4f-d8mm 1f-d16mm</p>		<p><b>F0469-I</b> NO. 16110170470102 - 16410.17047.01.02 - 16410170470106 - 60507865 - 60805170 - 60811991 - 799610 - 9934</p> <p>FOLE DA TRANSMISSÃO LADO DA CAIXA</p> <p>BMW 5 (E12): 518 07.1974/05.1981 66KW 90CV 1766CC - BMW 5 (E12): 520 06.1972/01.1979 85KW 115CV 1990CC - BMW 5 (E12): 520/6 03.1977/06.1981 90KW 122CV 1990CC - BMW 5 (E12): 525 10.1973/08.1976 107KW 145CV 2494CC - BMW 5 (E12): 525 08.1975/06.1981 110KW 150CV 2494CC - BMW 5 (E12): 528 08.1975/07.1977 125KW 170CV 2788CC - BMW 5 (E12): 528 i 08.1979/06.1981 135KW 184CV 2788CC - BMW 5 (E12): 528 i 08...</p> <p>d85x80mm 1f-d61mm 1f-d23mm</p>
	<p><b>F0548-I</b> NO. 33211105446 - 3321110544603 - 33211205816</p> <p>FOLE DO SEMI-EIXO LADO CAIXA</p> <p>BMW 518 - 520 (APÓS 72)</p> <p>d85x80mm 1f-d51mm 1f-d23mm</p>		<p><b>F1650A-I</b> NO. 33211209551 - 33211229221 - 33219067815 - 33219067906</p> <p>FOLE DA TRANSMISSÃO JUNTO À CAIXA</p> <p>BMW SÉRIE 5(E12) 2.0i 520i - 2.4TD 524 TD - 2.5 525 - 2.5i 525i - 525iX 24V - 2.7i 525E - 2.8i 528i - 3.0i 530i - 3.0i 530i V8 - 3.4i 535i (1972 A 1981)</p> <p>d110x125mm 1f-d108mm 1f-d25mm</p>
	<p><b>KUR21999</b> NO. 1f-d24mm 1f-d10mm 1f-d10mm 1f-d19mm</p> <p>KIT DE REPARAÇÃO ALAVANCA DE VELOCIDADES</p> <p>BMW 5 (E12) 518 (De 07.1974 Até 05.1981) 66kW 90cv 1766cm3 três volumes - BMW 5 (E12) 520 i/6 (De 09.1976 Até 07.1978) 90kW 122cv 1990cm3 três volumes - BMW 5 (E12) 520/6 (De 03.1977 Até 06.1981) 90kW 122cv 1990cm3 três volumes - BMW 5 (E12) 525 (De 10.1973 Até 08.1976) 107kW 145cv 2494cm3 três volumes - BMW 5 (E12) 525 (De 08.1975 Até 06.1981) 110kW 150cv 2494cm3 três volumes - BMW 5 (E12) 528 (D...</p> <p>d37x18mm d19x25mm d17x22x4mm d31x210mm d31x261x20mm d24x19x6</p>		<p><b>M6017</b> NO. 18111175311 - 18111245489 - 18111245840 - 18111245960 - 18114690146</p> <p>JUNTA DE ESCAPE</p> <p>BMW SERIE 5 (E12)</p> <p>.d56.5x10mm 1f-d44mm</p>
	<p><b>M6032</b> NO. 18111245500 - 18111728363 - 18114690142 - 18114790110</p> <p>JUNTA DE ESCAPE</p> <p>BMW E12 518i - 520i - 525 - 528i</p> <p>110x80mm 2f-d40mm</p>		<p><b>M6083</b> NO. 18111101192 - 18111245429 - 18111723843</p> <p>JUNTA DE ESCAPE</p> <p>BMW E12 520i (1977 A 1988) - 525i (1973 A 1988) - 528i (1977 A 1988)</p> <p>87x78mm 1f-d39mm</p>
	<p><b>N0500</b> NO. 18211105635 - 18211105638 - 18211105677 - 18211177708 - 18211728332 - 18214490159 - 1824490159</p> <p>ANEL DE SUPORTE DE ESCAPE</p> <p>BMW SERIE 5 (E12)</p> <p>65x18mm</p>		<p><b>N2331</b> NO. 18211101878 - 18211245113</p> <p>ANEL ESCAPE</p> <p>BMW E12 518 - 520i - 525 - 528i</p> <p>d58x14mm 1f-d31mm</p>
	<p><b>N3727</b> NO. 3100099 - 90301-34207-000</p> <p>ANEL DE ESCAPE</p> <p>BMW E12 520 - 518 (ATÉ VIAT. 462680)</p> <p>d55x12mm 1f-d31mm</p>		<p><b>P1059</b> NO. 1 108 634 - 35211108634</p> <p>CAPA DE PEDAL DO TRAVÃO</p> <p>BMW SÉRIE 5 (E12) 518 - 518i - 520 - 520i - 520-6 - 525 - 525 - 528 - 528i - (08-1972 A 05-1981)</p> <p>75x62x12mm</p>

	<p><b>R220045</b> NO. 11530788175 - 11531266469</p> <p>TUBO DO TERMOSTASTO</p> <p>BMW 5 (E12) 518 07.1974/05.1981 66KW 90CV 1766CC M10 B18 (184VB) 0005400005379 - BMW 5 (E12) 520 06.1972/01.1979 85KW 115CV 1990CC M10 B20 0005373 - BMW 5 (E12) 520 i 03.1972/07.1979 92KW 125CV 1990CC M10 B20 0005391 - BMW 5 (E12) 520 i 08.1972/10.1975 96KW 131CV 1990CC M10 B20 0005374</p> <p>B245-d30/30mm 85-190mm</p>		<p><b>R220053</b> NO. 11531250387 - 11531266459</p> <p>TUBO DE LIGAÇÃO TERMOSTATO Á BOMBA DE ÁGUA</p> <p>BMW 5 (E12) 525 10.1973/08.1976 107KW 145CV 2494CC M30 B25 A 0005375 - BMW 5 (E12) 525 08.1975/06.1981 110KW 150CV 2494CC M30 B25 (256VA) 0005394 0005402 - BMW 5 (E12) 528 01.1975/08.1976 121KW 165CV 2788CC M30 B28 0005382 - BMW 5 (E12) 528 08.1975/07.1977 125KW 170CV 2788CC M30 B28 0005395 - BMW 5 (E12) 528 i 03.1977/09.1979 130KW 177CV 2788CC M30 B28 0005403 - BMW 5 (E12) 528 i 08.1979/06.1981 1...</p> <p>B113-d39/d39mm 45-50mm</p>
	<p><b>R220075</b> NO. 11531266463</p> <p>TUBO INFERIOR DO RADIADOR</p> <p>BMW 5 (E12) 518 07.1974/05.1981 66KW 90CV 1766CC M10 B18 (184VB) 0005400 0005379</p> <p>B225-d35/35mm 60-95-80-45mm</p>		<p><b>R220077</b> NO. 11531262751 - 11531266464 - 134396</p> <p>TUBO DE RADIADOR SUPERIOR</p> <p>BMW 5 (E12) 518 07.1974/05.1981 66KW 90CV 1766CC M10 B18 (184VB) 0005400 0005379 - BMW 5 (E12) 518 i 06.1979/06.1981 75K2 102CV 1766CC M10 B18 (184EB) - BMW 5 (E12) 520 06.1972/01.1979 85KW 115CV 1990CC M10 B20 0005373 - BMW 5 (E12) 520 i 03.1972/07.1979 92KW 125CV 1990CC M10 B20 0005391 - BMW 5 (E12) 520 i 08.1972/10.1975 96KW 131CV 1990CC M10 B20 0005374</p> <p>B230-D30/30mm 100-65-50-80mm</p>
	<p><b>R8152</b> NO. 11531260206 - 11531266463</p> <p>TUBO SUPERIOR DO RADIADOR</p> <p>BMW 5 (E12) 518 07.1974/05.1981 66KW 90CV 1766CC M10 B18 (184VB) 0005400 0005379</p> <p>B260-33/33mm 155-155mm</p>		<p><b>R8153</b> NO. 11531260206 - 11531266463</p> <p>TUBO SUPERIOR DO RADIADOR</p> <p>BMW 5 (E12) 518 07.1974/05.1981 66KW 90CV 1766CC M10 B18 (184VB) 0005400 0005379</p> <p>B190-32/32mm 155-157mm</p>
	<p><b>RT08693</b> NO. 34321108135 - 34321113183 - 34321115695 - 34321159878 - 34321159881 - 34324050542</p> <p>TUBO DE TRAVÃO TRÁS LH-RH</p> <p>BMW SÉRIE 5 (E12) TT (08-1972 A 08-1981)</p> <p>225mm F - F</p>		<p><b>U0020</b> NO. 18214490157 - A18214490157</p> <p>TACO DE NYLON PARA ANEIS DE ESCAPE N0500</p> <p>BMW SERIE 5(E12)</p> <p>34x25x18mm</p>
	<p><b>UCRZ1093</b> NO. 26111105398 - 26117518304 - 26203401609 - 26207526677</p> <p>CRUZETA DO VEIO TRANSMISSÃO LONGITUDINAL</p> <p>BMW 5 (E12) M535 i (De 04.1980 Até 05.1981) 160kW 218cv 3453cm3 três volumes - BMW 5 (E12) M535 i (De 04.1980 Até 05.1981) 160kW 218cv 3453cm3 três volumes -</p> <p>d24x63mm 43mm</p>		<p><b>UMB84029</b> NO. 07119937320 - 11111276472 - 11111717939 - 1717939 - 9937321</p> <p>TAMPÃO BLOCO MOTOR</p> <p>BMW 5 (E12) 518 (De 07-1974 Até 05-1981) 66kW 90CV 1766cc três volumes BMW 5 (E12) 520 (De 08-1972 Até 08-1977) 85KW 115CV 1990cc três volumes BMW 5 (E12) 520 i (De 03-1972 Até 07-1979) 92KW 125CV 1990cc três volumes BMW 5 (E12) 520 i (De 08-1972 Até 10-1975) 96KW 131CV 1990cc três volumes BMW 5 (E12) 525 (De 10-1973 Até 08-1976) 107KW 146CV 2494cc três volumes BMW 5 (E12) 528 (De 01-1975 Até...</p> <p>d36x10mm di-32mm</p>
	<p><b>UMB84038</b> NO. 07119937331 - 11111276473 - 11111717472</p> <p>TAMPÃO BLOCO MOTOR</p> <p>BMW 5 (E12) 520 / 6 (09.77 A 05.81) 122cv 1990cc três volumes - BMW 5 (E12) 525 (06.73 A 06.81) 146cv 2494cc três volumes - BMW 5 (E12) 525 (08.76 A 05.81) 150cv 2494cc três volumes - BMW 5 (E12) 528 (01.75 A 08.77) 165cv 2788cc três volumes - BMW 5 (E12) 528 (01.75 A 08.77) 170cv 2788cc três volumes - BMW 5 (E12) 528 i (04.77 A 05.81) 177cv 2788cc três volumes - BMW...</p> <p>d-45x12,1mm di-42mm</p>		<p><b>UTR0631</b> NO. 17111100848 - 17111102672 - 17111120062</p> <p>TAMPÃO RADIADOR</p> <p>BMW 5 (E12): 518 07.1974/05.1981 66KW 90CV 1766CC - BMW 5 (E12): 518 i 06.1979/06.1981 75KW 102CV 1766CC - BMW 5 (E12): 520 06.1972/01.1979 85KW 115CV 1990CC - BMW 5 (E12): 520 i 03.1972/07.1979 92KW 125CV 1990CC - BMW 5 (E12): 520 i 08.1972/10.1975 96KW 131CV 1990CC - BMW 5 (E12): 520/6 03.1977/06.1981 90KW 122CV 1990CC - BMW 5 (E12): 525 10.1973/08.1976 107KW 145CV 2494CC - BMW 5 (E12): 525 08.1...</p> <p>d59/79x29mm d38x26mm</p>
	<p><b>Y3239</b> NO. 36130141574 - 36130141576 - 36131095390 - 36131116717 - 36131117190 - 36131126191</p> <p>PARAFUSO PERNO RODA CHAVE 17 M12X1,50X50MM ( BASE CONICA )</p> <p>BMW 5 (E12) 518 07.1974/05.1981 66KW 90CV 1766CC M10 B18 (184VB) 0005400 0005379 - BMW 5 (E12) 520 06.1972/01.1979 85KW 115CV 1990CC M10 B20 0005373 - BMW 5 (E12) 520 i 03.1972/07.1979 92KW 125CV 1990CC M10 B20 0005391 - BMW 5 (E12) 520 i 08.1972/10.1975 96KW 131CV 1990CC M10 B20 0005374 - BMW 5 (E12) 520/6 03.1977/06.1981 90KW 122CV 1990CC M20 B20 (206VA) 0005401 - BMW 5 (E12) 525 10.1973/08.19...</p> <p>c51mm (ch-17mm) M12x1x24mm</p>		<p><b>Z86003</b> NO. 51711932996</p> <p>MOLAS FIXAÇÃO MOLDURA PORTAS</p> <p>5 (E28)</p> <p>Informações</p> <p>Tipo</p> <p>Ano de construção</p> <p>kW</p> <p>HP</p> <p>cc</p> <p>Código(s) do motor</p> <p>Fabricante (Alemanha) T-12L-8H-7S-1mm</p> <p>518 06.1981 - 09.1984 66 90 1766 M10 B18 (184VD) M10 B18 (184VC) 0005420 518 i 05.1981 - 12.1987 75 102 1766 M10 B18 (184EB) 518 i 05.1981 - 12.1987 77 105 1766 M10 B18 (184EB) 0005435 520 i 06.1981 - 12.1987 92 125 1990 M20 B20 (206EZ) M20 B20 (206EB) M20 B20 (...)</p>

	<p><b>A0948</b> NO. 26111206502 - 26121104355 - A26111206502</p> <p><b>APOIO SUPORTE CENTRAL DA TRANSMISSÃO COM ROLAMENTO</b></p> <p>BMW 5 (E28) 525 i 06.1981/12.1987 110KW 150CV 2494CC M30 B25 (256EA) 0005422 - BMW 5 (E28) 528 i 06.1981/12.1987 135KW 184CV 2788CC M30 B28 (286EA) 0005423 - BMW 5 (E28) M5 08.1985/12.1987 210KW 286CV 3453CC S38 B35 (356ED)</p> <p>155x101x42mm d30mm</p>		<p><b>D0022</b> NO. 26111209168 - 26111227420 - 26111227717 - 26111229080 - 26111229360 - 26117511454</p> <p><b>CARDAN TRANSMISSÃO D135X30MM 6 FUROS 12MM ENTRE FUROS 96MM</b></p> <p>BMW 5 (E28) 524 td 09.1983/12.1987 85KW 115CV 2443CC M21 D24 (246TA) 0005431 - BMW 5 (E28) 525 e 09.1981/12.1987 90KW 122CV 2693CC M20 B27 (276KA) M20 B27 (276KB) 0005440 - BMW 5 (E28) 525 e 03.1983/12.1987 92KW 125CV 2693CC M20 B27 (276EA) 0005430 - BMW 5 (E28) 525 e 09.1985/12.1987 95KW 129CV 2693CC M20 B27 (276KB) M20 B27 (276EB) 0005451 - BMW 5 (E28) 525 i 06.1981/12.1987 110KW 150CV 2494CC M3...</p> <p>d132x123x30mm 6f-d12mm</p>
	<p><b>D0059</b> NO. 26111109603</p> <p><b>CARDAN TRANSMISSÃO</b></p> <p>BMW 5 (E28) 525 i (De 06-1981 Até 12-1987) 110KW 150CV 2494cc três volumes BMW 5 (E28) 525 e (De 09-1981 Até 12-1987) 90KW 122CV 2693cc três volumes BMW 5 (E28) 525 e (De 05-1983 Até 12-1987) 92KW 125CV 2693cc três volumes BMW 5 (E28) 525 e (De 12-1984 Até 12-1987) 95KW 129CV 2693cc três volumes BMW 5 (E28) 528 i (De 06-1981 Até 12-1987) 135KW 184CV 2788cc três volumes BMW 5 (E28) 535 i - M 5...</p> <p>d135x30mm 6f-d12mm</p>		<p><b>D0060</b> NO. 32311115090 - 32311115092</p> <p><b>CARDAN COLUNA DIREÇÃO</b></p> <p>BMW 5 (E28) 518 06.1981/09.1984 66KW 90CV 1766CC M10 B18 (184VD) M10 B18 (184VC) 0005420 - BMW 5 (E28) 518 i 05.1981/12.1987 75KW 102CV 1766CC M10 B18 (184EB) - BMW 5 (E28) 518 i 05.1981/12.1987 77KW 105CV 1766CC M10 B18 (184EB) 0005435 - BMW 5 (E28) 520 i 06.1981/12.1987 92KW 125CV 1990CC M20 B20 (206EZ) M20 B20 (206EB) M20 B20 (206EC) M20 B20 (206EA) 0005419 0005421 - BMW 5 (E28) 520 i 08.1985/1...</p> <p>65x65x13mm 4f-d8mm</p>
	<p><b>E0125</b> NO. 31351124380 - 31351127194 - 31351128050 - 31351130075 - 31351134582 - 31352227203</p> <p><b>ESTICADOR DA BARRA ESTABILIZADORA DA FRENTE</b></p> <p>BMW SERIE 5 (E28) TT - SERIE 5 (E34) TT</p> <p>280x36x36mm 2p-d10-20mm</p>		<p><b>F0469-I</b> NO. 16110170470102 - 16410.17047.01.02 - 16410170470106 - 60507865 - 60805170 - 60811991 - 799610 - 9954</p> <p><b>FOLE DA TRANSMISSÃO LADO DA CAIXA</b></p> <p>BMW 5 (E28): 518 06.1981/09.1984 66KW 90CV 1766CC - BMW 5 (E28): 518 i 05.1981/12.1987 77KW 105CV 1766CC - BMW 5 (E28): 520 i 06.1981/12.1987 92KW 125CV 1990CC - BMW 5 (E28): 520 i 08.1985/12.1987 95KW 129CV 1990CC - BMW 5 (E28): 525 i 06.1981/12.1987 110KW 150CV 2494CC - BMW 5 (E28): 525 i 06.1981/12.1987 110KW 150CV 2494CC - BMW 5 (E28): 524 d 03.1986/12.1987 63KW 86CV 2443CC - BMW 5 (E28): 524 ...</p> <p>d85x80mm 1f-d61mm 1f-d23mm</p>
	<p><b>F1082-I</b> NO. 32111127104</p> <p><b>FOLE DA DIREÇÃO ESQUERDO</b></p> <p>BMW E28 316 ? 318i (APÓS 1982)</p> <p>d67-165mm 1f-d44mm 1f-d36mm</p>		<p><b>F1650A-I</b> NO. 33211209551 - 33211229221 - 33219067815 - 33219067906</p> <p><b>FOLE DA TRANSMISSÃO JUNTO Á CAIXA</b></p> <p>BMW SÉRIE 5(E28) 2.0i - 2.4 TD - 2.5i - 2.7i - 2.8i - 3.4i (1980 A 1990)</p> <p>d110x125mm 1f-d108mm 1f-d25mm</p>
	<p><b>KUR21999</b> NO. 1f-d24mm 1f-d10mm 1f-d10mm 1f-d19mm</p> <p><b>KIT DE REPARAÇÃO ALAVANCA DE VELOCIDADES</b></p> <p>BMW 5 (E28) 518 (De 06.1981 Até 09.1984) 66KW 90cv 1766cm3 três volumes - BMW 5 (E28) 518 i (De 05.1981 Até 12.1987) 77KW 105cv 1766cm3 três volumes - BMW 5 (E28) 520 i (De 06.1981 Até 12.1987) 92KW 125cv 1990cm3 três volumes - BMW 5 (E28) 520 i (De 08.1985 Até 12.1987) 95KW 129cv 1990cm3 três volumes - BMW 5 (E28) 524 d (De 03.1986 Até 12.1987) 63KW 86cv 2443cm3 três volumes - BMW 5 (E28) 524 td ...</p> <p>d37x18mm d19x25mm d17x22x4mm d31x210mm d31x261x20mm d24x19x6</p>		<p><b>M6009</b> NO. 18111245429 - 18111719313</p> <p><b>JUNTA DE ESCAPE</b></p> <p>BMW E28 524 (1986 A 1989) - 524i (1988 A 1990)</p> <p>.d86x5mm 1f-d78mm</p>
	<p><b>M6017</b> NO. 18111175311 - 18111245489 - 18111245840 - 18111245960 - 18114690146</p> <p><b>JUNTA DE ESCAPE</b></p> <p>BMW SERIE 5 (E30)</p> <p>d56.5x10mm 1f-d44mm</p>		<p><b>M6028</b> NO. 18111175311</p> <p><b>JUNTA DE ESCAPE</b></p> <p>BMW 5 (E28) 518 06.1981/09.1984 66KW 90CV 1766CC M10 B18 (184VD) M10 B18 (184VC) 0005420 - BMW 5 (E28) 518 i 05.1981/12.1987 77KW 105CV 1766CC M10 B18 (184EB) 0005435 - BMW 5 (E28) 528 i 06.1981/12.1987 135KW 184CV 2788CC M30 B28 (286EA) 0005423 - BMW 5 (E28) 535 i 01.1985/12.1987 162KW 220CV 3430CC M30 B34 (346EC) 0005436</p> <p>d57x10mm 1f-d47mm</p>
	<p><b>M6032</b> NO. 18111245500 - 18111728363 - 18114690142 - 18114790110</p> <p><b>JUNTA DE ESCAPE</b></p> <p>BMW E28 518i - 520i - 525 - 528i</p> <p>110x80mm 2f-d40mm</p>		<p><b>M6059</b> NO. 11761277954 - 11761711717 - 18301723885</p> <p><b>JUNTA DE ESCAPE</b></p> <p>BMW E28 520i (1986 A 1990) - 525i (1987 A 1990) - 525ix (1990 A 1996) - 530i (1988 A 1991) - 535i ((1988 A 1991)</p> <p>77x85mm 1f-d46mm</p>
	<p><b>M6065</b> NO. 11761711718 - 11761711968 - 18101176502 - 18111177768 - 18111718364</p> <p><b>JUNTA DE ESCAPE</b></p> <p>BMW E28 518 (1983 A 1988) - 518i (1984 A 1988)</p> <p>145x77mm 2f-d42mm</p>		<p><b>M6083</b> NO. 18111101192 - 18111245429 - 18111723843</p> <p><b>JUNTA DE ESCAPE</b></p> <p>BMW E28 520i (1977 A 1988) - 525i (1973 A 1988) - 528i (1977 A 1988)</p> <p>87x78mm 1f-d39mm</p>



	<p><b>N0500</b> NO. 18211105635 - 18211105638 - 18211105677 - 18211177708 - 18211728332 - 18214490159 - 1824490159</p> <p><b>ANEL DE SUPORTE DE ESCAPE</b></p> <p>BMW 5 (E28): 518 06.1981/09.1984 66KW 90CV 1766CC - BMW 5 (E28): 518 i 05.1981/12.1987 77KW 105CV 1766CC - BMW 5 (E28): 518 i 05.1981/12.1987 75KW 102CV 1766CC - BMW 5 (E28): 520 i 06.1981/12.1987 92KW 125CV 1990CC - BMW 5 (E28): 520 i 08.1985/12.1987 95KW 129CV 1990CC - BMW 5 (E28): 520 i 12.1986/12.1987 110KW 150CV 1990CC - BMW 5 (E28): 525 i 06.1981/12.1987 110KW 150CV 2494CC - BMW 5 (E28): 525...</p> <p>65x18mm</p>		<p><b>N1617</b> NO.</p> <p><b>ANEL DE ESCAPE</b></p> <p>BMW E28 518 - 520 - 525 - 528</p> <p>d65x13mm 1f-d40mm</p>
	<p><b>N2001</b> NO. 4387294 - RF138115514A - SE138115514A</p> <p><b>ANEL DE ESCAPE TRÁS</b></p> <p>BMW E28 518 - 520</p> <p>d70x14mm 1f-d46mm</p>		<p><b>N2004</b> NO. 18211176424 - 18211245985 - 18211712838</p> <p><b>ANEL DE ESCAPE</b></p> <p>BMW SÉRIE 5 (E28) TT - 518 - 520 - 525 - 535</p> <p>d78x39mm 1f-d43mm</p>
	<p><b>P1059</b> NO. 1 108 634 - 35211108634</p> <p><b>CAPA DE PEDAL DO TRAVÃO</b></p> <p>BMW SÉRIE 5 (E28) 518 - 518i - 520i - 524D - 524TD - 525i - 525 (2.7) - 528i - 535i (06-1981 A 06-1990)</p> <p>75x62x12mm</p>		<p><b>R021812</b> NO. 13311288284</p> <p><b>TUBO DE LIGAÇÃO DO CARBURADOR AO COLECTOR</b></p> <p>BMW 5 (E28): 518 i 05.1981/12.1987 77KW 105CV 1766CC - BMW 5 (E28): 518 i 05.1981/12.1987 75KW 102CV 1766CC - BMW 5 (E28): 520 i 06.1981/12.1987 92KW 125CV 1990CC - BMW 5 (E28): 520 i 08.1985/12.1987 95KW 129CV 1990CC - BMW 5 (E28): 520 i 12.1986/12.1987 110KW 150CV 1990CC - BMW 5 (E28): 525 e 09.1981/12.1987 90KW 122CV 2693CC - BMW 5 (E28): 525 e 03.1983/12.1987 92KW 125CV 2693CC - BMW 5 (E28): 5...</p> <p>B245-d77mm 235-65mm</p>
	<p><b>R220053</b> NO. 11531250387 - 11531266459</p> <p><b>TUBO DE LIGAÇÃO TERMOSTATO Á BOMBA DE ÁGUA</b></p> <p>BMW 5 (E28) 525 i 06.1981/12.1987 110KW 150CV 2494CC M30 B25 (256EA) 0005422 - BMW 5 (E28) 528 i 06.1981/12.1987 135KW 184CV 2788CC M30 B28 (286EA) 0005423 - BMW 5 (E28) 535 i 01.1985/12.1987 162KW 220CV 3430CC M30 B34 (346EC) 0005436 - BMW 5 (E28) 535 i, M 535 i 01.1985/12.1987 136KW 185CV 3430CC M30 B34 (346KA) 0005441 - BMW 5 (E28) 535 i, M 535 i 01.1985/12.1987 141KW 192CV 3430CC M30 B34 (346K...</p> <p>B113-d39/d39mm 45-50mm</p>		<p><b>R220077</b> NO. 11531262751 - 11531266464</p> <p><b>TUBO DE RADIADOR SUPERIOR</b></p> <p>BMW 5 (E28) 518 06.1981/09.1984 66KW 90CV 1766CC M10 B18 (184VD) M10 B18 (184VC) 0005420 - BMW 5 (E28) 518 i 05.1981/12.1987 75KW 102CV 1766CC M10 B18 (184EB) - BMW 5 (E28) 518 i 05.1981/12.1987 77KW 105CV 1766CC M10 B18 (184EB) - BMW 5 (E28) 518 i 05.1981/12.1987 77KW 105CV 1766CC M10 B18 (184EB) 0005435</p> <p>B230-D30/30mm 100-65-50-80mm</p>
	<p><b>R220209</b> NO. 11531276449 - 11531278909</p> <p><b>TUBO SUPERIOR DO RADIADOR</b></p> <p>BMW 5 (E28): 518 06.1981/09.1984 66KW 90CV 1766CC - BMW 5 (E28): 518 i 05.1981/12.1987 77KW 105CV 1766CC</p> <p>B285-d30/36mm 90-55-100-110mm</p>		<p><b>R220862</b> NO. 11531287651 - 11531287654</p> <p><b>TUBO LIGAÇÃO BOMBA DE ÁGUA</b></p> <p>BMW 5 (E28): 520 i 06.1981/12.1987 92KW 125CV 1990CC - BMW 5 (E28): 520 i 08.1985/12.1987 95KW 129CV 1990CC - BMW 5 (E28): 520 i 12.1986/12.1987 110KW 150CV 1990CC - BMW 5 (E28): 525 e 09.1981/12.1987 90KW 122CV 2693CC - BMW 5 (E28): 525 e 03.1983/12.1987 92KW 125CV 2693CC - BMW 5 (E28): 525 e 09.1985/12.1987 95KW 129CV 2693CC - BMW 5 (E28): 525 i 06.1987/09.1990 95KW 129CV 1990CC - BMW 5 (E28): 525 i 06.1987/09.1990 95KW 129CV 1990CC - BMW 5 (E28): 525 e (09.81 A 12.87) 122cv 2693cc três volumes - BMW 5 (E28) 525 e (05.83 ...</p> <p>B200-33/35mm 60-170-160-100mm</p>
	<p><b>RT08693</b> NO. 34321108135 - 34321113183 - 34321115695 - 34321159878 - 34321159881 - 34324050542</p> <p><b>TUBO DE TRAVÃO TRÁS LH-RH</b></p> <p>BMW SÉRIE 5 (E28) TT (06-1981 A 12-1987)</p> <p>225mm F - F</p>		<p><b>S1271</b> NO. 31106770689 - 31106770690 - 31121092019 - 31121094235 - 31121122462 - 31121124622 - 31121133236 -</p> <p><b>SILENT-BLOC DO BRAÇO DA SUSPENSÃO (FRENTE CENTRO)</b></p> <p>BMW 5 (E28) 518 06.1981/09.1984 66KW 90CV 1766CC M10 B18 (184VD) M10 B18 (184VC) 0005420 - BMW 5 (E28) 518 i 05.1981/12.1987 75KW 102CV 1766CC M10 B18 (184EB) - BMW 5 (E28) 518 i 05.1981/12.1987 77KW 105CV 1766CC M10 B18 (184EB) 0005435 - BMW 5 (E28) 520 i 06.1981/12.1987 92KW 125CV 1990CC M20 B20 (206EZ) M20 B20 (206EB) M20 B20 (206EC) M20 B20 (206EA) 0005419 0005421 - BMW 5 (E28) 520 i 08.1985/1...</p> <p>d46x52mm c40mm 1f-d12mm</p>
	<p><b>T0621-I</b> NO. 31331124449 - 31331124573 - 31331125215</p> <p><b>BATENTE SUSPENSÃO FRENTE</b></p> <p>BMW 5 (E28) 518 (06.81 A 08.84) 90cv 1766cc três volumes - BMW 5 (E28) 518 i (05.81 A 12.87) 105cv 1766cc três volumes - BMW 5 (E28) 520 i (06.81 A 12.87) 125cv 1990cc três volumes - BMW 5 (E28) 520 i (08.85 A 12.87) 129cv 1990cc três volumes - BMW 5 (E28) 525 i (06.81 A 12.87) 150cv 2495cc três volumes - BMW 5 (E28) 525 e (09.81 A 12.87) 122cv 2693cc três volumes - BMW 5 (E28) 525 e (05.83 ...</p> <p>d59x85mm 1f-d26mm 1f-d18mm</p>		<p><b>T0622-I</b> NO. 33 35 2 124 573 - 33521124573</p> <p><b>BATENTE SUSPENSÃO FRENTE</b></p> <p>BMW 5 (E28) 518 (06.81 A 08.84) 90cv 1766cc três volumes - BMW 5 (E28) 518 i (05.81 A 12.87) 105cv 1766cc três volumes - BMW 5 (E28) 520 i (06.81 A 12.87) 125cv 1990cc três volumes - BMW 5 (E28) 520 i (08.85 A 12.87) 129cv 1990cc três volumes - BMW 5 (E28) 525 i (06.81 A 12.87) 150cv 2495cc três volumes - BMW 5 (E28) 525 e (09.81 A 12.87) 122cv 2693cc três volumes - BMW 5 (E28) 525 e (05.83 ...</p> <p>d58x83mm 1f-d18mm 1f-d12mm</p>
	<p><b>U7033K</b> NO. 61671378609 - 64500149356 - 64500301636 - 64501363572 - 64501466019 - 64501468463 - 64508390601</p> <p><b>ORINGS BOMBA DIREÇÃO ASSITIDA</b></p> <p>BMW 5 (E28) 518 (06.1981 - 09.1984) 66kw 90cv 1766cm3 três volumes BMW 5 (E28) 518 i (05.1981 - 12.1987) 77kw 105cv 1766cm3 três volumes BMW 5 (E28) 518 i (05.1981 - 12.1987) 75kw 102cv 1766cm3 três volumes BMW 5 (E28) 520 i (06.1981 - 12.1987) 92kw 125cv 1990cm3 três volumes BMW 5 (E28) 520 i (08.1985 - 12.1987) 95kw 129cv 1990cm3 três volumes BMW 5 (E28) 520 i (12.1986 - 12.1987) 110kw 150cv 19...</p> <p>d11x2mm d10x2mm 1f-d7mm 1f-d6mm</p>		<p><b>UCRZ1054</b> NO. 32311092958 - 32311150489</p> <p><b>CRUZETA VEIO DIREÇÃO D15X40MM</b></p> <p>BMW 5 (E28) 518 (De 06.1981 Até 09.1984) 66kw 90cv 1766cm3 três volumes - BMW 5 (E28) 518 i (De 05.1981 Até 12.1987) 77kw 105cv 1766cm3 três volumes - BMW 5 (E28) 518 i (De 05.1981 Até 12.1987) 75kw 102cv 1766cm3 três volumes - BMW 5 (E28) 520 i (De 06.1981 Até 12.1987) 92kw 125cv 1990cm3 três volumes - BMW 5 (E28) 520 i (De 08.1985 Até 12.1987) 95kw 129cv 1990cm3 três volumes - BMW 5 (E28) 520 i (De 12.1986 Até 12.1987) 110kw 150cv 19...</p> <p>d15x28x40mm</p>

	<p><b>UCRZ1093</b> NO. 26111105398 - 26117518304 - 26203401609 - 26207526677</p> <p><b>CRUZETA DO VEIO TRANSMISSÃO LONGITUDINAL</b></p> <p>BMW 5 (E28) 520 i (De 06.1981 Até 12.1987) 92kW 125cv 1990cm3 três volumes - BMW 5 (E28) 520 i (De 08.1985 Até 12.1987) 95kW 129cv 1990cm3 três volumes - BMW 5 (E28) 520 i (De 12.1986 Até 12.1987) 110kW 150cv 1990cm3 três volumes - BMW 5 (E28) 524 td (De 09.1983 Até 12.1987) 85kW 115cv 2443cm3 três volumes - BMW 5 (E28) 524 td (De 09.1983 Até 12.1987) 85kW 115cv 2443cm3 três volumes - BMW 5 (E28) ...</p> <p>d24x63mm      43mm</p>		<p><b>UMB84029</b> NO. 071119937320 - 11111276472 - 11111717939 - 1717939 - 9937321</p> <p><b>TAMPÃO BLOCO MOTOR</b></p> <p>BMW 5 (E28) 518 (De 06-1981 Até 08-1984) 66kW 90CV 1766cc três volumes - BMW 5 (E28) 518 i (De 05-1981 Até 12-1987) 77kW 105CV 1766cc três volumes - BMW 5 (E28) 525 i (De 06-1981 Até 12-1987) 110kW 150CV 2494cc três volumes - BMW 5 (E28) 528 i (De 06-1981 Até 12-1987) 135kW 184CV 2788cc três volumes - BMW 5 (E28) 535 i - M 535 i (De 01-1985 Até 12-1987) 136kW 185CV 3430cc três volumes - BMW 5 (E28) 535...</p> <p>d36x10mm      di-32mm</p>
	<p><b>UTR0631</b> NO. 17111100848 - 17111102672 - 17111120062</p> <p><b>TAMPÃO RADIADOR</b></p> <p>BMW 5 (E28) 518 06.1981/09.1984 66KW 90CV 1766CC M10 B18 (184VD) M10 B18 (184VC) 0005420 - BMW 5 (E28) 518 i 05.1981/12.1987 75CV 102CV 1766CC M10 B18 (184EB) - BMW 5 (E28) 518 i 05.1981/12.1987 77KW 105CV 1766CC M10 B18 (184EB) 0005435 - BMW 5 (E28) 520 i 06.1981/12.1987 92KW 125CV 1990CC M20 B20 (206EZ) M20 B20 (206EB) M20 B20 (206EC) M20 B20 (206EA) 0005419 0005421 - BMW 5 (E28) 520 i 08.1985/1...</p> <p>d59/79x29mm      d38x26mm</p>		<p><b>Y3239</b> NO. 0019811225 - 0029812925 - 0039812325 - 0089814325 - 26121103728 - 26121209590 - 26121225071 - 261212...</p> <p><b>PARAFUSO PERNO RODA CHAVE 17 M12X1,50X50MM (BASE CONICA)</b></p> <p>BMW 5 (E28) 518 06.1981/09.1984 66KW 90CV 1766CC M10 B18 (184VD) M10 B18 (184VC) 0005420 - BMW 5 (E28) 518 i 05.1981/12.1987 77KW 105CV 1766CC M10 B18 (184EB) 0005435 - BMW 5 (E28) 520 i 06.1981/12.1987 92KW 125CV 1990CC M20 B20 (206EZ) M20 B20 (206EB) M20 B20 (206EC) M20 B20 (206EA) 0005419 0005421 - BMW 5 (E28) 520 i 08.1985/12.1987 95KW 129CV 1990CC M20 B20 (206KA) 0005450 - BMW 5 (E28) 524 d 0...</p> <p>c51mm (ch-17mm)      M12x1x24mm</p>

BMW SERIE 5(E34)

	<p><b>A1746</b> NO. 22311094916 - 22316771221 - 23711131664</p> <p><b>APOIO DA CAIXA DE VELOCIDADES PARTE DE TRÁS</b></p> <p>BMW 5 (E34) 520 i 06.1987/09.1990 95KW 129CV 1990CC M20 B20 (206KA) 0005472 - BMW 5 (E34) 524 td 03.1988/08.1991 85KW 115CV 2443CC M21 D24 (246TB) 0005476 - BMW 5 (E34) 525 i 02.1988/08.1990 125KW 170CV 2494CC M20 B25 (256K1) 0005473 - BMW 5 (E34) 525 td 03.1993/08.1995 85KW 115CV 2497CC M51 D25 (256T1) 0005476 - BMW 5 (E34) 525 tds 09.1991/08.1995 105KW 143CV 2497CC M51 D25 (256T1) 0005514 - BMW ...</p> <p>d50x34mm      2p-d8-17/19mm</p>		<p><b>A1947</b> NO. 0019811225 - 0029812925 - 0039812325 - 0089814325 - 26121103728 - 26121209590 - 26121225071 - 261212...</p> <p><b>APOIO DA TRANSMISSÃO</b></p> <p>BMW 5 (E34) 518 i Tipo de caixa de velocidades: para caixa de velocidades manual (08.89 A 09.95) 113cv 1796cc três volumes - BMW 5 (E34) 518 i Tipo de caixa de velocidades: para caixa de velocidades automática (08.89 A 09.95) 115cv 1796cc três volumes - BMW 5 Touring (E34) 518 i Tipo de caixa de velocidades: para caixa de velocidades manual (03.93 A 09.94) 113cv 1796cc Combi - BMW 5 Touring...</p> <p>180x100x45mm      1f-d30mm</p>
	<p><b>A1959</b> NO. 1138427 - 24701138427</p> <p><b>APOIO ESQUERDO CAIXA VELOCIDADES</b></p> <p>BMW 5 (E34) 520 i 24V (09.89 A 09.95) 150cv 1991cc três volumes - BMW 5 (E34) 525 i 24V (09.89 A 09.95) 192cv 2494cc três volumes - BMW 5 Touring (E34) 520 i (11.91 A 01.97) 150cv 1991cc Combi - BMW 5 Touring (E34) 525 i (11.91 A 01.97) 192cv 2494cc Combi</p> <p>48x45x42mm      2p-d8x16mm</p>		<p><b>A1960</b> NO. 1138428 - 24701138428</p> <p><b>APOIO DIREITO CAIXA VELOCIDADES</b></p> <p>BMW 5 (E34) 520 i 24V (09.89 A 09.95) 150cv 1991cc três volumes - BMW 5 (E34) 525 i 24V (09.89 A 09.95) 192cv 2494cc três volumes - BMW 5 Touring (E34) 520 i (11.91 A 01.97) 150cv 1991cc Combi - BMW 5 Touring (E34) 525 i (11.91 A 01.97) 192cv 2494cc Combi</p> <p>48x45x42mm      2p-d8x16mm</p>
	<p><b>A2357</b> NO. 33171133552</p> <p><b>APOIO DA CAIXA DE VELOCIDADES</b></p> <p>BMW 5 (E34) 518 i (De 09.1989 Até 04.1994) 4632kW 83cv 113cm3 1796 - BMW 5 (E34) 518 i (De 05.1994 Até 08.1995) 4631kW 85cv 115cm3 1796 - BMW 5 (E34) 520 i (De 06.1987 Até 09.1990) 237KW 95cv 129cm3 1990 - BMW 5 (E34) 520 i 24V (De 04.1990 Até 08.1995) 238kW 110cv 150cm3 1991 - BMW 5 (E34) 525 td (De 03.1993 Até 08.1995) 7069kW 85cv 115cm3 2497 - BMW 5 (E34) 525 tds (De 09.1991 Até 08.1995) 243kW ...</p> <p>178x80x63mm      1r-d10mm 4f-d10mm</p>		<p><b>D0022</b> NO. 26111209168 - 26111227420 - 26111227717 - 26111229080 - 26111229360 - 26117511454</p> <p><b>CARDAN TRANSMISSÃO D135X30MM 6 FUROS 12MM ENTRE FUROS 96MM</b></p> <p>BMW 5 (E34) 524 td 03.1988/08.1991 85KW 115CV 2443CC M21 D24 (246TB) 0005476 - BMW 5 (E34) 525 i 02.1988/08.1990 125KW 170CV 2494CC M20 B25 (256K1) 0005473 - BMW 5 (E34) 525 i 24V 03.1990/08.1995 141KW 192CV 2494CC M50 B25 (256S1) M50 B25 (256S2) 0005493 - BMW 5 (E34) 525 iX 24V 10.1991/08.1995 141KW 192CV 2494CC M50 B25 (256S2) M50 B25 (256S1) 0005521 - BMW 5 (E34) 525 td 03.1993/08.1995 85KW 115...</p> <p>d132x123x30mm      6f-d12mm</p>
	<p><b>D0031</b> NO. 26111229065 - 26111277690</p> <p><b>CARDAN TRANSMISSÃO D140X38MM 6 FUROS 14MM ENTRE FUROS 105MM</b></p> <p>BMW 5 (E34) 540 i V8 09.1992/12.1995 210KW 286CV 3982CC M60 B40 (408S1) 0005527 - BMW 5 Touring (E34) 540 i 09.1993/07.1996 210KW 286CV 3982CC M60 B40 (408S1) 0005539 - BMW 5 (E39) 525 d 02.2000/06.2003 120KW 163CV 2497CC M57 D25 (256D1) 0005672 - BMW 5 (E39) 530 d 08.1998/09.2000 135KW 184CV 2926CC M57 D30 (306D1) 0005631 - BMW 5 (E39) 530 d 09.1998/06.2003 142KW 193CV 2926CC M57 D30 (306D1) 0005...</p> <p>d140x38mm      1f-d52mm 6f-d14mm</p>		<p><b>D0049</b> NO. 1227410 - 1227869 - 1229516 - 26111227410 - 26111227869 - 26111229516 - 26611227410 - 26611227869</p> <p><b>CARDAN TRANSMISSÃO</b></p> <p>BMW 5 (E34) 518 i 09.1989/04.1994 83KW 113CV 1796CC M40 B18 (184E1) 0005491 - BMW 5 (E34) 518 i 05.1994/08.1995 85KW 115CV 1796CC M43 B18 (184E2) 0005490 - BMW 5 (E34) 520 i 06.1987/09.1990 95KW 129CV 1990CC M20 B20 (206KA) 0005472 - BMW 5 (E34) 520 i 24V 04.1990/08.1995 110KW 150CV 1990CC M50 B20 (206S2) M50 B20 (206S1) 0005492 - BMW 5 (E34) 525 td 03.1993/08.1995 85KW 115CV 2497CC M51 D25 (256T1)...</p> <p>111x107x32mm      6f-d12mm</p>
	<p><b>D0060</b> NO. 32311115090 - 32311115092</p> <p><b>CARDAN COLUNA DIREÇÃO</b></p> <p>BMW 5 (E34) 518 i 09.1989/04.1994 83KW 113CV 1796CC M40 B18 (184E1) 0005491 - BMW 5 (E34) 518 i 05.1994/08.1995 85KW 115CV 1796CC M43 B18 (184E2) 0005490 - BMW 5 (E34) 520 i 06.1987/09.1990 95KW 129CV 1990CC M20 B20 (206KA) 0005472 - BMW 5 (E34) 520 i 24V 04.1990/08.1995 110KW 150CV 1990CC M50 B20 (206S2) M50 B20 (206S1) 0005492 - BMW 5 (E34) 524 td 03.1988/08.1991 85KW 115CV 2443CC M21 D24 (246TB)...</p> <p>65x65x13mm      4f-d8mm</p>		<p><b>F1650A-I</b> NO. 33211209551 - 33211229221 - 33219067815 - 33219067906</p> <p><b>FOLE DA TRANSMISSÃO JUNTO À CAIXA</b></p> <p>BMW SÉRIE 5(E34) 2.5i - 3.0i - 3.4i (1988 A 1997)</p> <p>d110x125mm      1f-d108mm 1f-d25mm</p>

	<p><b>F1800-I</b> NO. 33211226033 - 33211226719 - 33211229205 - 33217504703 - 33219067809 - 33219067814 - 33219067895 -</p> <p><b>FOLE TRANSMISSÃO JUNTO A CAIXA FALANGE D105MM</b></p> <p>BMW SÉRIE 5(E34) 1.8i 518i - 2.0i 520i - 2.0i 520i 24V - 2.4TD 524TD - 2.5TD 525TD - 2.5TD 525TDS - 2.5i 525i - 525iX 24V - 3.0i 530i - 4.0i 540i V8 (88 A 97)</p> <p>d102x94mm 1f-d100mm 1f-d22mm</p>		<p><b>F1805-I</b> NO. 1094933 - 32131094933 - 32131096465 - 32131096910 - 32211139786</p> <p><b>FOLE DIREÇÃO ( GASTA 2 UNIDADES )</b></p> <p>BMW SERIE 5 (E34)</p> <p>d70x175mm 1f-d55mm 1f-d42mm</p>
	<p><b>F4308</b> NO. 25111221757 - 25111221885 - 25111221886 - 25111221887 - 25111221915</p> <p><b>FOLE ALAVANCA VELOCIDADES</b></p> <p>BMW 5 (E34) 518 i (09.1989 - 04.1994) 83kw 113cv 1796cm3 três volumes BMW 5 (E34) 518 i (05.1994 - 08.1995) 85kw 115cv 1796cm3 três volumes BMW 5 (E34) 520 i (06.1987 - 09.1990) 95kw 129cv 1990cm3 três volumes BMW 5 (E34) 520 i 24V (04.1990 - 08.1995) 110kw 150cv 1990cm3 três volumes BMW 5 (E34) 524 td (03.1988 - 08.1991) 85kw 115cv 2443cm3 três volumes BMW 5 (E34) 525 i (02.1988 - 08.1990) 125kw ...</p> <p>170x170x138mm 1f-157x126mm</p>		<p><b>F4309</b> NO. 25111221217 - 25111221219 - 25111221222 - 25111221757 - 25111221767 - 25111221885 - 25111221886 - 25111221887</p> <p><b>FOLE ALAVANCA VELOCIDADES</b></p> <p>BMW 5 (E34) 518 i 09.1989/04.1994 83KW 113CV 1796CC M40 B18 (184E1) 0005491 - BMW 5 (E34) 518 i 05.1994/08.1995 85KW 115CV 1796CC M43 B18 (184E2) 0005490 - BMW 5 (E34) 520 i 06.1987/09.1990 95KW 129CV 1990CC M20 B20 (206KA) 0005472 - BMW 5 (E34) 520 i 24V 04.1990/08.1995 110KW 150CV 1990CC M50 B20 (206S2) M50 B20 (206S1) 0005492 - BMW 5 (E34) 524 td 03.1988/08.1991 85KW 115CV 2443CC M21 D24 (246TB)...</p> <p>188x150x107mm 1f-132x87mm</p>
	<p><b>F4345</b> NO. 33211226033 - 33211226264 - 33211229221 - 3321129376 - 33217504704 - 33219067813 - 33219067815</p> <p><b>FOLE TRANSMISSÃO JUNTO A RODA ( GASTA 2 UNIDADES )</b></p> <p>BMW 5 (E34) 518 i 09.1989/04.1994 83KW 113CV 1796CC M40 B18 (184E1) 0005491 - BMW 5 (E34) 520 i 06.1987/09.1990 95KW 129CV 1990CC M20 B20 (206KA) 0005472 - BMW 5 (E34) 520 i 24V 04.1990/08.1995 110KW 150CV 1990CC M50 B20 (206S2) M50 B20 (206S1) 0005492 - BMW 5 (E34) 524 td 03.1988/08.1991 85KW 115CV 2443CC M21 D24 (246TB) 0005476 - BMW 5 (E34) 525 i 02.1988/08.1990 125KW 170CV 2494CC M20 B25 (256K...</p> <p>d81x79mm 1f-d22mm-1f-d52mm</p>		<p><b>F4345</b> NO. 33211226033 - 33211226264 - 33211229221 - 3321129376 - 33217504704 - 33219067813 - 33219067815</p> <p><b>FOLE TRANSMISSÃO JUNTO A RODA ( GASTA 2 UNIDADES )</b></p> <p>BMW 5 Touring (E34) 518 i 04.1993/04.1994 83KW 113CV 1796CC M40 B18 (184E1) 0005533 - BMW 5 Touring (E34) 520 i 07.1991/07.1996 110KW 150CV 1990CC M50 B20 (206S2) M50 B20 (206S1) 0005515 - BMW 5 Touring (E34) 525 i 07.1991/07.1996 141KW 192CV 2494CC M50 B25 (256S2) M50 B25 (256S1) 0005516 - BMW 5 Touring (E34) 525 ix 01.1992/03.1996 141KW 192CV 2494CC M50 B25 (256S1) M50 B25 (256S2) 0005522 - BMW ...</p> <p>d81x79mm 1f-d22mm-1f-d52mm</p>
	<p><b>KT0621-I</b> NO. 31331124449 - 31331137932</p> <p><b>KIT BATENTE SUSPENSÃO DA FRENTE</b></p> <p>BMW 5 (E34) 518 i (De 08-1989 Até 09-1995) 83kw 113CV 1796cc três volumes - BMW 5 (E34) 518 i (De 08-1989 Até 09-1995) 85kw 115CV 1796cc três volumes - BMW 5 (E34) 520 i (De 01-1988 Até 08-1991) 95kw 129CV 1990cc três volumes - BMW 5 (E34) 520 i 24V (De 09-1989 Até 09-1995) 110kW 150CV 1991cc três volumes - BMW 5 (E34) 525 i (De 01-1988 Até 08-1991) 125kW 170CV 2494cc três volumes - BMW 5 (E34) 525 i 2...</p> <p>d73x145mm 1f-d68mm 1f-d19mm</p>		<p><b>KUR21999</b> NO. 1f-d24mm 1f-d10mm 1f-d10mm 1f-d19mm</p> <p><b>KIT DE REPARAÇÃO ALAVANCA DE VELOCIDADES</b></p> <p>BMW 5 (E34) 518 i (De 09.1989 Até 04.1994) 83kw 113cv 1796cm3 três volumes - BMW 5 (E34) 518 i (De 05.1994 Até 08.1995) 85kw 115cv 1796cm3 três volumes - BMW 5 (E34) 520 i (De 06.1987 Até 09.1990) 95kw 129cv 1990cm3 três volumes - BMW 5 (E34) 520 i 24V (De 04.1990 Até 08.1995) 110kW 150cv 1990cm3 três volumes - BMW 5 (E34) 524 td (De 03.1988 Até 08.1991) 85kw 115cv 2443cm3 três volumes - BMW 5 (E3...</p> <p>d37x18mm d19x25mm d17x22mm d31x21mm d31x26mm d20mm d24x19mm d15mm</p>
	<p><b>KUR21999</b> NO. 1f-d24mm 1f-d10mm 1f-d10mm 1f-d19mm</p> <p><b>KIT DE REPARAÇÃO ALAVANCA DE VELOCIDADES</b></p> <p>BMW 5 Touring (E34) 518 g (De 02.1996 Até 07.1996) 85kw 115cv 1796cm3 Combi - BMW 5 Touring (E34) 518 i (De 04.1993 Até 04.1994) 83kw 113cv 1796cm3 Combi - BMW 5 Touring (E34) 518 i (De 05.1994 Até 07.1996) 85kw 115cv 1796cm3 Combi - BMW 5 Touring (E34) 520 i (De 07.1991 Até 07.1996) 110kW 150cv 1990cm3 Combi - BMW 5 Touring (E34) 525 i (De 07.1991 Até 07.1996) 141kW 192cv 2494cm3 Combi - BMW 5 To...</p> <p>d37x18mm d19x25mm d17x22mm d31x21mm d31x26mm d20mm d24x19mm d15mm</p>		<p><b>M6017</b> NO. 18111175311 - 18111245489 - 18111245840 - 18111245960 - 18114690146</p> <p><b>JUNTA DE ESCAPE</b></p> <p>BMW SERIE 5 (E34)</p> <p>..d56.5x10mm 1f-d44mm</p>
	<p><b>M6028</b> NO. 18111175311</p> <p><b>JUNTA DE ESCAPE</b></p> <p>BMW 5 (E34) 525 iX 24V 10.1991/08.1995 141KW 192CV 2494CC M50 B25 (256S2) M50 B25 (256S1) 0005521 - BMW 5 (E34) 530 i 01.1988/04.1990 138KW 188CV 2986CC M30 B30 (306KA) 0005474 - BMW 5 (E34) 530 i V8 09.1992/12.1995 160KW 218CV 2997CC M60 B30 (308S1) 0005526 - BMW 5 (E34) 535 i 11.1987/02.1993 155KW 211CV 3430CC M30 B34 (346KB) 0005475 - BMW 5 Touring (E34) 525 i 01.1992/03.1996 141KW 192CV 2494C...</p> <p>d57x10mm 1f-d47mm</p>		<p><b>M6059</b> NO. 11761277954 - 11761711717 - 18301723885</p> <p><b>JUNTA DE ESCAPE</b></p> <p>BMW E34 520i (1986 A 1990) - 525i (1987 A 1990) - 525ix (1990 A 1996) - 530i (1988 A 1991) - 535i ((1988 A 1991)</p> <p>77x85mm 1f-d46mm</p>
	<p><b>N0500</b> NO. 18211105635 - 18211105638 - 18211105677 - 18211177708 - 18211728332 - 18214490159 - 1824490159</p> <p><b>ANEL DE SUPORTE DE ESCAPE</b></p> <p>BMW 5 (E34): 520 i 06.1987/09.1990 95KW 129CV 1990CC - BMW 5 (E34): 525 i 24V 03.1990/08.1995 141KW 192CV 2494CC - BMW 5 (E34): 525 iX 24V 10.1991/08.1995 141KW 192CV 2494CC - BMW 5 (E34): 524 td 03.1988/08.1991 85KW 115CV 2443CC - BMW 5 Touring (E34): 525 i 07.1991/07.1996 141KW 192CV 2494CC - BMW 5 Touring (E34): 525 ix 01.1992/03.1996 141KW 192CV 2494CC</p> <p>65x18mm</p>		<p><b>N1617</b> NO.</p> <p><b>ANEL DE ESCAPE</b></p> <p>BMW E34 518 - 520 - 525 - 528</p> <p>d65x13mm 1f-d40mm</p>
	<p><b>N2001</b> NO. 4387294 - RF138115514A - SE138115514A</p> <p><b>ANEL DE ESCAPE TRÁS</b></p> <p>BMW E34 518 - 520</p> <p>d70x14mm 1f-d46mm</p>		<p><b>N2004</b> NO. 18211176424 - 18211245985 - 18211712838</p> <p><b>ANEL DE ESCAPE</b></p> <p>BMW SÉRIE 3 E34 TT - 518 - 520 - 525 - 535</p> <p>d78x39mm 1f-d43mm</p>



	<p><b>P1042</b> NO. 35211160422</p> <p><b>CAPA DE PEDAL</b></p> <p>BMW 5 (E34) 518 i 09.1989/04.1994 83KW 113CV 1796CC M40 B18 (184E1) 0005491 - BMW 5 (E34) 518 i 05.1994/08.1995 85KW 115CV 1796CC M43 B18 (184E2) 0005490 - BMW 5 (E34) 520 i 06.1987/09.1990 95KW 129CV 1990CC M20 B20 (206KA) 0005472 - BMW 5 (E34) 520 i 24V 04.1990/08.1995 110KW 150CV 1990CC M50 B20 (206S2) M50 B20 (206S1) 0005492 - BMW 5 (E34) 524 td 03.1988/08.1991 85KW 115CV 2...</p> <p>75x65x40mm</p>		<p><b>P1055</b> NO. 35211160421</p> <p><b>CAPA DE PEDAL DO TRAVÃO(VEÍCULOS COM CAIXA AUTOMÁTICA)</b></p> <p>BMW 5 (E34) 518 i 09.1989/04.1994 83KW 113CV 1796CC M40 B18 (184E1) 0005491 - BMW 5 (E34) 518 i 05.1994/08.1995 85KW 115CV 1796CC M43 B18 (184E2) 0005490 - BMW 5 (E34) 520 i 06.1987/09.1990 95KW 129CV 1990CC M20 B20 (206KA) 0005472 - BMW 5 (E34) 520 i 24V 04.1990/08.1995 110KW 150CV 1990CC M50 B20 (206S2) M50 B20 (206S1) 0005492 - BMW 5 (E34) 525 i 02.1988/08.1990 125KW 170CV 2494CC M20 B25 (256K1...</p> <p>74x107x42mm</p>
	<p><b>P1059</b> NO. 1 108 634 - 35211108634</p> <p><b>CAPA DE PEDAL DO TRAVÃO</b></p> <p>BMW SÉRIE 5(E34) 518i - 520i - 524TD - 525i - 525TD - 525TDS - 530i - 535i - 540i - M5 (3.6) - M5 (3.8) (01-1988 A 09-1995)</p> <p>75x62x12mm</p>		<p><b>Q2009</b> NO.</p> <p><b>UNIÃO DE ESCAPE 47/52,5x90mm</b></p> <p>BMW SÉRIE 5 (E34) - 525 i 24V Código do mot or: M50 - Mod. t ipo: E34 5 - Mod. t ipo: H - Mod. t ipo: Hx5 - Tipo de caixa de velocidades: Caixa de velocidades manual - ou: - Ano fabric. até: (02.95) - Código do mot or: M50 (Motronic) - Mod. t ipo: E34 (09.89 - 0</p> <p>90x58x78mm 1f-d47mm</p>
	<p><b>R021812</b> NO. 13311288284</p> <p><b>TUBO DE LIGAÇÃO DO CARBURADOR AO COLECTOR</b></p> <p>BMW 5 (E34): 520 i 06.1987/09.1990 95KW 129CV 1990CC - BMW 5 (E34): 525 i 02.1988/08.1990 125KW 170CV 2494CC - BMW 5 (E34): 525 iX 24V 10.1991/08.1995 141KW 192CV 2494CC - BMW 5 (E34): 535 i 11.1987/02.1993 155KW 211CV 3430CC - BMW 5 (E34): 540 i V8 09.1992/12.1995 210KW 286CV 3982CC - BMW 5 Touring (E34): 525 iX 01.1992/03.1996 141KW 192CV 2494CC - BMW 5 Touring (E34): 540 i 09.1993/07.1996 210KW...</p> <p>B245-d77mm 235-65mm</p>		<p><b>R021925</b> NO. 13311288284</p> <p><b>TUBO DE LIGAÇÃO DO CARBURADOR AO COLECTOR</b></p> <p>BMW 5 (E34): 520 i 06.1987/09.1990 95KW 129CV 1990CC - BMW 5 (E34): 525 i 02.1988/08.1990 125KW 170CV 2494CC - BMW 5 (E34): 525 iX 24V 10.1991/08.1995 141KW 192CV 2494CC - BMW 5 (E34): 535 i 11.1987/02.1993 155KW 211CV 3430CC - BMW 5 (E34): 540 i V8 09.1992/12.1995 210KW 286CV 3982CC - BMW 5 Touring (E34): 525 iX 01.1992/03.1996 141KW 192CV 2494CC - BMW 5 Touring (E34): 540 i 09.1993/07.1996 210KW...</p> <p>B230-77mm 205x55mm</p>
	<p><b>R220053</b> NO. 11531250387 - 11531266459</p> <p><b>TUBO DE LIGAÇÃO TERMOSTATO Á BOMBA DE ÁGUA</b></p> <p>BMW 5 (E34) 530 i 01.1988/04.1990 138KW 188CV 2986CC M30 B30 (306KA) 0005474 - BMW 5 (E34) 535 i 11.1987/02.1993 155KW 211CV 3430CC M30 B34 (346KB) 0005475</p> <p>B113-d39/d39mm 45-50mm</p>		<p><b>R220862</b> NO. 11531287651 - 11531287654</p> <p><b>TUBO LIGAÇÃO BOMBA DE ÁGUA</b></p> <p>BMW 5 (E34): 520 i 06.1987/09.1990 95KW 129CV 1990CC - BMW 5 (E34): 525 i 02.1988/08.1990 125KW 170CV 2494CC</p> <p>B200-33/35mm 60-170-160-100mm</p>
	<p><b>RT08693</b> NO. 34321108135 - 34321113183 - 34321115695 - 34321159878 - 34321159881 - 34324050542</p> <p><b>TUBO DE TRAVÃO TRÁS LH-RH</b></p> <p>BMW SÉRIE 5 (E34) TT (01-1988 A 09-1995)</p> <p>225mm F - F</p>		<p><b>S1271</b> NO. 31106770689 - 31106770690 - 31121092019 - 31121094235 - 31121122462 - 31121124622 - 31121133236 - 31...</p> <p><b>SILENT-BLOC DO BRAÇO DA SUSPENSÃO (FRENTE CENTRO)</b></p> <p>BMW 5 (E34) 518 i 09.1989/04.1994 83KW 113CV 1796CC M40 B18 (184E1) 0005491 - BMW 5 (E34) 518 i 05.1994/08.1995 85KW 115CV 1796CC M43 B18 (184E2) 0005490 - BMW 5 (E34) 520 i 06.1987/09.1990 95KW 129CV 1990CC M20 B20 (206KA) 0005472 - BMW 5 (E34) 520 i 24V 04.1990/08.1995 110KW 150CV 1990CC M50 B20 (206S2) M50 B20 (206S1) 0005492 - BMW 5 (E34) 524 td 03.1988/08.1991 85KW 115CV 2...</p> <p>d46x52mm c40mm 1f-d12mm</p>
	<p><b>T0621-I</b> NO. 31331124449 - 31331125215</p> <p><b>BATENTE SUSPENSÃO FRENTE</b></p> <p>BMW 5 Touring (E34) 518 i 03.93 - 09.94 83 113 1796 Combi BMW 5 Touring (E34) 518 g 11.95 - 06.96 85 115 1796 Combi BMW 5 Touring (E34) 520 i 11.91 - 01.97 110 150 1991 Combi - BMW 5 Touring (E34) 525 td (03.93 A 01.97) 115cv 2497cc Combi - BMW 5 Touring (E34) 525 tds (12.91 A 01.97) 143cv 2503cc Combi - BMW 5 Touring (E39) 520 i (04.99 A 05.04) 136cv 1991cc Combi - BMW 5 Touring (E39) 520 i (01...</p> <p>d59x85mm 1f-d26mm 1f-d18mm</p>		<p><b>T0621-I</b> NO. 31331124449 - 31331124573 - 31331125215</p> <p><b>BATENTE SUSPENSÃO FRENTE</b></p> <p>BMW 5 (E34) 5 1 8 i Chassis: para veic ulos sem chassis desportivo (08.89 A 09.95) 113cv 1796cc três volumes - BMW 5 (E34) 518 i (08.89 A 09.95) 115cv 1796cc três volumes - BMW 5 (E34) 520 i (01.88 A 08.91) 129cv 1990cc três volumes - BMW 5 (E34) 520 i 24V (09.89 A 09.95) 150cv 1991cc três volumes - BMW 5 (E34) 525 i (01.88 A 08.91) 170cv 2494cc três volumes - BMW 5 (E34) 525 i 24V (09.89 A 0...</p> <p>d59x85mm 1f-d26mm 1f-d18mm</p>
	<p><b>T1278</b> NO. 31135133738-31351133783-11337388</p> <p><b>BATENTE DA BARRA ESTABILIZADORA DA FRENTE</b></p> <p>BMW 5 (E34) 518 i 09.1989/04.1994 83KW 113CV 1796CC M40 B18 (184E1) 0005491 - BMW 5 (E34) 518 i 05.1994/08.1995 85KW 115CV 1796CC M43 B18 (184E2) 0005490 - BMW 5 (E34) 520 i 06.1987/09.1990 95KW 129CV 1990CC M20 B20 (206KA) 0005472 - BMW 5 (E34) 520 i 24V 04.1990/08.1995 110KW 150CV 1990CC M50 B20 (206S2) M50 B20 (206S1) 0005492 - BMW 5 (E34) 524 td 03.1988/08.1991 85KW 115CV 2443CC M21 D24 (246TB...</p> <p>53x54x61mm 1f-d22mm</p>		<p><b>U0020</b> NO. 18214490157 - A18214490157</p> <p><b>TACO DE NYLON PARA ANEIS DE ESCAPE N0500</b></p> <p>BMW SERIE 5(E34)</p> <p>34x25x18mm</p>
	<p><b>U7033K</b> NO. 61671378609 - 64500149356 - 64500301636 - 64501363572 - 64501466019 - 64501468463 - 64508390601</p> <p><b>ORINGS BOMBA DIREÇÃO ASSITIDA</b></p> <p>BMW 5 (E34) 518 i (09.1989 - 04.1994) 83kw 113cv 1796cm3 três volumes BMW 5 (E34) 518 i (05.1994 - 08.1995) 85kw 115cv 1796cm3 três volumes BMW 5 (E34) 520 i (06.1987 - 09.1990) 95kw 129cv 1990cm3 três volumes BMW 5 (E34) 520 i 24V (04.1990 - 08.1995) 110kw 150cv 1990cm3 três volumes BMW 5 (E34) 524 td (03.1988 - 08.1991) 85kw 115cv 2443cm3 três volumes BMW 5 (E34) 525 i (02.1988 - 08.1990) 125kw...</p> <p>d11x2mm d10x2mm 1f-d7mm 1f-d6mm</p>		<p><b>U7033K</b> NO. 61671378609 - 64500149356 - 64500301636 - 64501363572 - 64501466019 - 64501468463 - 64508390601</p> <p><b>ORINGS BOMBA DIREÇÃO ASSITIDA</b></p> <p>BMW 5 Touring (E34) 518 g (02.1996 - 07.1996) 74kw 101cv 1796cm3 Combi BMW 5 Touring (E34) 518 i (04.1993 - 04.1994) 83kw 113cv 1796cm3 Combi BMW 5 Touring (E34) 518 i (05.1994 - 07.1996) 85kw 115cv 1796cm3 Combi BMW 5 Touring (E34) 520 i (07.1991 - 07.1996) 110kw 150cv 1990cm3 Combi BMW 5 Touring (E34) 525 i (07.1991 - 07.1996) 141kw 192cv 2494cm3 Combi BMW 5 Touring (E34) 525 iX (01.1992 - 03.1...</p> <p>d11x2mm d10x2mm 1f-d7mm 1f-d6mm</p>

	<p><b>UCRZ1054</b> NO. 32311092958 - 32311150489</p> <p><i>CRUZETA VEIO DIREÇÃO D15X40MM</i></p> <p>BMW 5 (E34) 518 i (De 09.1989 Até 04.1994) 83kW 113cv 1796cm3 três volumes - BMW 5 (E34) 518 i (De 05.1994 Até 08.1995) 85kW 115cv 1796cm3 três volumes - BMW 5 (E34) 520 i (De 06.1987 Até 09.1990) 95kW 129cv 1990cm3 três volumes - BMW 5 (E34) 520 i 24V (De 04.1990 Até 08.1995) 110kW 150cv 1990cm3 três volumes - BMW 5 (E34) 524 td (De 03.1988 Até 08.1991) 85kW 115cv 2443cm3 três volumes - BMW 5 (E3...</p> <p>d15x28x40mm</p>		<p><b>UCRZ1093</b> NO. 26111105398 - 26117518304 - 26203401609 - 26207526677</p> <p><i>CRUZETA DO VEIO TRANSMISSÃO LONGITUDINAL</i></p> <p>BMW 5 (E34) 518 i (De 09.1989 Até 04.1994) 83kW 113cv 1796cm3 três volumes - BMW 5 (E34) 524 td (De 03.1988 Até 08.1991) 85kW 115cv 2443cm3 três volumes - BMW 5 (E34) 524 td (De 03.1988 Até 08.1991) 85kW 115cv 2443cm3 três volumes - BMW 5 (E34) 525 i (De 02.1988 Até 08.1990) 125kW 170cv 2494cm3 três volumes - BMW 5 (E34) 525 i 24V (De 03.1990 Até 08.1995) 141kW 192cv 2494cm3 três volumes - BMW 5 (...</p> <p>d24x63mm 43mm</p>
	<p><b>UFQ23302</b> NO. 21511223302</p> <p><i>FORQUILHA DA EMBRAIAGEM</i></p> <p>BMW 5 (E34) 520 i 24V 04.1990/08.1995 110KW 150CV 1990CC M50 B20 (206S2) M50 B20 (206S1) 0005492 - BMW 5 (E34) 525 i 24V 03.1990/08.1995 141KW 192CV 2494CC M50 B25 (256S1) M50 B25 (256S2) 0005493 - BMW 5 (E34) 525 iX 24V 10.1991/08.1995 141KW 192CV 2494CC M50 B25 (256S2) M50 B25 (256S1) 0005521 - BMW 5 (E34) 530 i V8 09.1992/12.1995 160KW 218CV 2997CC M60 B30 (308S1) 0005526 - BMW 5 (E34) 540 i V8...</p> <p>252x83x28mm 1f-47x75mm</p>		<p><b>UFQ23302</b> NO. 21511223302</p> <p><i>FORQUILHA DA EMBRAIAGEM</i></p> <p>BMW 5 (E34) 520 i 24V 04.1990/08.1995 110KW 150CV 1990CC M50 B20 (206S2) M50 B20 (206S1) 0005492 - BMW 5 (E34) 525 i 24V 03.1990/08.1995 141KW 192CV 2494CC M50 B25 (256S1) M50 B25 (256S2) 0005493 - BMW 5 (E34) 525 iX 24V 10.1991/08.1995 141KW 192CV 2494CC M50 B25 (256S2) M50 B25 (256S1) 0005521 - BMW 5 (E34) 530 i V8 09.1992/12.1995 160KW 218CV 2997CC M60 B30 (308S1) 0005526 - BMW 5 (E34) 540 i V8...</p> <p>252x83x28mm 1f-47x75mm</p>
	<p><b>UMB84029</b> NO. 07119937320 - 11111276472 - 11111717939 - 1717939 - 9937321</p> <p><i>TAMPÃO BLOCO MOTOR</i></p> <p>BMW 5 (E34) 518 i (De 08-1989 Até 09-1995) 83kW 113CV 1796cc três volumes - BMW 5 (E34) 530 i (De 01-1988 Até 08-1991) 138kW 188CV 2986cc três volumes - BMW 5 (E34) 535 i (De 01-1988 Até 09-1995) 155kW 211CV 3430cc três volumes - BMW 5 (E34) M5 Cat (De 10-1988 Até 05-1992) 232kW 315CV 3535cc três volumes - BMW 5 (E34) M5 (De 03-1992 Até 09-1995) 250kW 340CV 3795cc três volumes - BMW 5 Touring (E34) 518...</p> <p>d36x10mm di-32mm</p>		<p><b>UMV25110</b> NO. 25111434495 - 25117500299 - 25117503231 - 25117523817 - 25117544524</p> <p><i>MANETE PUNHO TOPO ALAVANCA MUDANÇAS 5 VELOCIDADES NAPEL F14MM</i></p> <p>BMW 5 (E34): 518 i 09.1989/04.1994 83KW 113CV 1796CC - BMW 5 (E34): 518 i 05.1994/08.1995 85KW 115CV 1796CC - BMW 5 (E34): 520 i 06.1987/09.1990 95KW 129CV 1990CC - BMW 5 (E34): 520 i 24V 04.1990/08.1995 110KW 150CV 1990CC - BMW 5 (E34): 530 i 01.1988/04.1990 138KW 188CV 2986CC - BMW 5 (E34): 530 i V8 09.1992/12.1995 160KW 218CV 2997CC - BMW 5 (E34): 535 i 11.1987/02.1993 155KW 211CV 3430CC - BMW ...</p> <p>d51x91mm 1f-d14mm</p>
	<p><b>UMV25114</b> NO. 25111434495 - 25117500299 - 25117503231 - 25117523817 - 25117544524</p> <p><i>MANETE PUNHO TOPO ALAVANCA MUDANÇAS 5 VELOCIDADES F14MM</i></p> <p>BMW 5 (E34): 518 i 09.1989/04.1994 83KW 113CV 1796CC - BMW 5 (E34): 518 i 05.1994/08.1995 85KW 115CV 1796CC - BMW 5 (E34): 520 i 06.1987/09.1990 95KW 129CV 1990CC - BMW 5 (E34): 520 i 24V 04.1990/08.1995 110KW 150CV 1990CC - BMW 5 (E34): 530 i 01.1988/04.1990 138KW 188CV 2986CC - BMW 5 (E34): 530 i V8 09.1992/12.1995 160KW 218CV 2997CC - BMW 5 (E34): 535 i 11.1987/02.1993 155KW 211CV 3430CC - BMW ...</p> <p>d56x94mm 1f-d14mm</p>		<p><b>UMV26826</b> NO. 25111221290 - 25111222280 - 25111434494 - 25111434495</p> <p><i>MANETE PUNHO TOPO ALAVANCA MUDANÇAS 5 VELOCIDADES F12MM C/LUZ</i></p> <p>BMW 5 (E34): 518 i 09.1989/04.1994 83KW 113CV 1796CC - BMW 5 (E34): 518 i 05.1994/08.1995 85KW 115CV 1796CC - BMW 5 (E34): 520 i 06.1987/09.1990 95KW 129CV 1990CC - BMW 5 (E34): 520 i 24V 04.1990/08.1995 110KW 150CV 1990CC - BMW 5 (E34): 530 i 01.1988/04.1990 138KW 188CV 2986CC - BMW 5 (E34): 530 i V8 09.1992/12.1995 160KW 218CV 2997CC - BMW 5 (E34): 535 i 11.1987/02.1993 155KW 211CV 3430CC - BMW ...</p> <p>54x45x91mm DIAMETRO INTERIOR 12MM</p>
	<p><b>UMV26829</b> NO. 25119416257</p> <p><i>MANETE PUNHO TOPO ALAVANCA MUDANÇAS 6 VELOCIDADES F14MM</i></p> <p>BMW SERIE 5 (E34)</p> <p>55x47x97mm 1f-d14mm</p>		<p><b>UTR0812</b> NO. 17110152374 - 17111468076 - 17111712492 - 17111712669 - 17111742231 - 17117690022 - 17119071581</p> <p><i>TAMPÃO RESERVATÓRIO LÍQUIDO REFRIGERAÇÃO</i></p> <p>BMW 5 (E34) 518 i (08.89 A 09.95) 113cv 1796cc três volumes - BMW 5 (E34) 518 i (08.89 A 09.95) 115cv 1796cc três volumes - BMW 5 (E34) 520 i (01.88 A 08.91) 129cv 1990cc três volumes - BMW 5 (E34) 520 i 24 V (09.89 A 09.95) 150cv 1991cc três volumes - BMW 5 (E34) 525 i (01.88 A 08.91) 170cv 2494cc três volumes - BMW 5 (E34) 525 i 24 V (09.89 A 09.95) 192cv 2494cc três volumes - B...</p> <p>d65x45mm 1f-d52x20mm</p>
	<p><b>UTR0813</b> NO. 17111468077 - 17111712188 - 17111712232 - 17111719167 - 17111742232 - 17112242256 - 17114379048 - 17114379048</p> <p><i>TAMPÃO RESERVATÓRIO LÍQUIDO REFRIGERAÇÃO</i></p> <p>BMW 5 (E34) 518 i (08.89 A 09.95) 113cv 1796cc três volumes - BMW 5 (E34) 520 i (01.88 A 08.91) 129cv 1990cc três volumes - BMW 5 (E34) 520 i 24 V (09.89 A 09.95) 150cv 1991cc três volumes - BMW 5 (E34) 525 i (01.88 A 08.91) 170cv 2494cc três volumes - BMW 5 (E34) 524 td (03.88 A 09.95) 115cv 2443cc três volumes - BMW 5 (E34) 525 td (04.93 A 09.95) 115cv 2497cc três volumes - BMW 5 (...</p> <p>d66x45mm 1f-d52x20mm</p>		<p><b>W5047</b> NO. 0614610 - 0614612 - 11232244417 - 11232245377 - 11232246510 - 11232246511 - 614610 - 614612 - ...</p> <p><i>POLIE DA CAMBOTA (5 PISTAS)</i></p> <p>BMW 5 (E34): 525 td 03.1993/08.1995 85KW 115CV 2497CC - BMW 5 (E34): 525 tds 09.1991/08.1995 105KW 143CV 2497CC - BMW 5 Touring (E34): 525 td 03.1993/07.1996 85KW 115CV 2497CC - BMW 5 Touring (E34): 525 tds 12.1991/07.1996 105KW 143CV 2497CC</p> <p>d157/205mm d45mm</p>
	<p><b>Y3239</b> NO. 36130141574 - 36130141576 - 36131095390 - 36131116717 - 36131117190 - 36131126191</p> <p><i>PARAFUSO PERNO RODA CHAVE 17 M12X1,50X50MM ( BASE CONICA )</i></p> <p>BMW 5 (E34) 518 i 09.1989/04.1994 83KW 113CV 1796CC M40 B18 (184E1) 0005491 - BMW 5 (E34) 518 i 05.1994/08.1995 85KW 115CV 1796CC M43 B18 (184E2) 0005490 - BMW 5 (E34) 520 i 06.1987/09.1990 95KW 129CV 1990CC M20 B20 (206KA) 0005472 - BMW 5 (E34) 520 i 24V 04.1990/08.1995 110KW 150CV 1990CC M50 B20 (206S2) M50 B20 (206S1) 0005492 - BMW 5 (E34) 524 td 03.1988/08.1991 85KW 115CV 2443CC M21 D24 (246TB...</p> <p>c51mm (ch-17mm) M12x1x24mm</p>		<p><b>Y3239</b> NO. 36130141574 - 36130141576 - 36131095390 - 36131116717 - 36131117190 - 36131126191</p> <p><i>PARAFUSO PERNO RODA CHAVE 17 M12X1,50X50MM ( BASE CONICA )</i></p> <p>BMW 5 Touring (E34) 518 i 04.1993/04.1994 83KW 113CV 1796CC M40 B18 (184E1) 0005533 - BMW 5 Touring (E34) 518 i 05.1994/07.1996 85KW 115CV 1796CC M43 B18 (184E2) 0005545 - BMW 5 Touring (E34) 520 i 07.1991/07.1996 110KW 150CV 1990CC M50 B20 (206S2) M50 B20 (206S1) 0005515 - BMW 5 Touring (E34) 525 i 07.1991/07.1996 141KW 192CV 2494CC M50 B25 (256S2) M50 B25 (256S1) 0005516 - BMW 5 Touring (E34) 52...</p> <p>c51mm (ch-17mm) M12x1x24mm</p>
	<p><b>Z80788</b> NO. 51481915964</p> <p><i>Mola de fixação</i></p> <p>BMW SÉRIE 5(E34)</p> <p>d20x23mm 1p-d7-11mm</p>		<p><b>Z80834</b> NO. 51321938884</p> <p><i>MOLA DE FIXAÇÃO</i></p> <p>BMW 5 (E34): 518 i 09.1989/04.1994 83KW 113CV 1796CC - BMW 5 (E34): 518 i 05.1994/08.1995 85KW 115CV 1796CC - BMW 5 (E34): 520 i 06.1987/09.1990 95KW 129CV 1990CC - BMW 5 (E34): 520 i 24V 04.1990/08.1995 110KW 150CV 1990CC - BMW 5 (E34): 525 i 02.1988/08.1990 125KW 170CV 2494CC - BMW 5 (E34): 525 i 24V 03.1990/08.1995 141KW 192CV 2494CC - BMW 5 (E34): 525 iX 24V 10.1991/08.1995 141KW 192CV 2494CC ...</p> <p>37x29x12.2mm</p>

	<b>Z80849</b>	NO. 51411973500 - 99950758240		
	Mola de painel BMW SÉRIE 5(E34)			
	d18x21mm	1p-d9-13mm		

BMW SERIE 5(E39)

	<b>A1746</b>	NO. 22311094916 - 22316771221 - 23711131664		<b>A1894</b>	NO. 26121227997 - 26121229242 - 26121229431
	APOIO DA CAIXA DE VELOCIDADES PARTE DE TRÁS BMW 5 (E39) 520 i 01.1996/06.2003 110KW 150CV 1990CC M52 B20 (206S4) M52 B20 (206S3) 0005569 - BMW 5 (E39) 520 i 09.2000/06.2003 125KW 170CV 2171CC M54 B22 (226S1) 0005688 - BMW 5 (E39) 523 i 09.1995/08.2000 125KW 170CV 2494CC M52 B25 (256S3) M52 B25 (256S4) 0005601 0005567 - BMW 5 (E39) 525 d 02.2000/06.2003 120KW 163CV 2497CC M57 D25 (256D1) 0005672 - BMW 5 (E39) 525 i 09.2000/06.2003 141KW 192C...			APOIO DE TRANSMISSÃO COM ROLAMENTO 30MM BMW 5 (E39): 525 d 02.2000/06.2003 120KW 163CV 2497CC - BMW 5 (E39): 530 d 08.1998/09.2000 135KW 184CV 2926CC - BMW 5 (E39): 530 d 09.1998/06.2003 142KW 193CV 2926CC - BMW 5 Touring (E39): 525 d 02.2000/05.2004 120KW 163CV 2497CC - BMW 5 Touring (E39): 530 d 08.1998/09.2000 135KW 184CV 2926CC - BMW 5 Touring (E39): 530 d 09.2000/05.2004 142KW 193CV 2926CC	
	d50x34mm	2p-d8-17/19mm		185x100x43mm	1f-d30mm
	<b>A2015</b>	NO. 22111096514		<b>A2016</b>	NO. 22111091153 - 22111097153 - 22116750039 - 22116751281
	APOIO MOTOR FRENTE DIREITO BMW 5 (E39) 525 d (De 02-2000 Até 06-2003) 120kW 163CV 2497cc três volumes BMW 5 (E39) 530 d (De 08-1998 Até 09-2000) 135kW 184CV 2926cc três volumes BMW 5 (E39) 530 d (De 09-1998 Até 06-2003) 142kW 193CV 2926cc três volumes BMW 5 Touring (E39) 525 d (De 02-2000 Até 05-2004) 120kW 163CV 2497cc Combi BMW 5 Touring (E39) 530 d (De 08-1998 Até 09-2000) 135kW 184CV 2926cc Combi BMW 5 Touring (E39)...			APOIO MOTOR FRENTE ESQUERDO BMW 5 (E39) 525 d (De 02-2000 Até 06-2003) 120kW 163CV 2497cc três volumes BMW 5 (E39) 530 d (De 08-1998 Até 09-2000) 135kW 184CV 2926cc três volumes BMW 5 (E39) 530 d (De 09-1998 Até 06-2003) 142kW 193CV 2926cc três volumes BMW 5 Touring (E39) 525 d (De 02-2000 Até 05-2004) 120kW 163CV 2497cc Combi BMW 5 Touring (E39) 530 d (De 08-1998 Até 09-2000) 135kW 184CV 2926cc Combi BMW 5 Touring (E39)...	
	104x92mm	1p-d10x24mm 1p-24x20x36mm 1f-d8mm		108x102mm	2p-d10x25mm
	<b>A2061</b>	NO. 22116752741		<b>D0022</b>	NO. 26111209168 - 26111227420 - 26111227717 - 26111229080 - 26111229360 - 261117511454
	APOIO DO MOTOR FRENTE ESQUERDO BMW 5 (E39) 520 d (De 02-2000 Até 06-2003) 100kW 136CV 1951cc três volumes BMW 5 Touring (E39) 520 d (De 02-2000 Até 09-2003) 100kW 136CV 1951cc Combi			CARDAN TRANSMISSÃO D135X30MM 6 FUROS 12MM ENTRE FUROS 96MM BMW 5 (E39) 520 i 01.1996/06.2003 110KW 150CV 1990CC M52 B20 (206S4) M52 B20 (206S3) 0005569 - BMW 5 (E39) 520 i 09.2000/06.2003 125KW 170CV 2171CC M54 B22 (226S1) 0005688 - BMW 5 (E39) 523 i 09.1995/08.2000 125KW 170CV 2494CC M52 B25 (256S3) M52 B25 (256S4) 0005601 0005567 - BMW 5 (E39) 525 i 09.2000/06.2003 141KW 192CV 2494CC M54 B25 (256S5) 0005692 - BMW 5 (E39) 525 td 01.19...	
	d100x82mm	1p-d10x27mm 1p-d923mm		d132x123x30mm	6f-d12mm
	<b>D0030</b>	NO. 26111229754 - 26117572664		<b>D0049</b>	NO. 1227410 - 1227869 - 1229516 - 26111227410 - 26111227869 - 26111229516 - 26111227410 - 26611227869
	CARDAN TRANSMISSÃO D162X42MM 6 FUROS 12MM ENTRE FUROS 110MM BMW 5 (E39) 520 d 02.2000/06.2003 100KW 136CV 1951CC M47 D20 (204D1) 0005670 - BMW 5 (E39) 525 d 02.2000/06.2003 120KW 163CV 2497CC M57 D25 (256D1) 0005672 - BMW 5 (E39) 530 d 08.1998/09.2000 135KW 184CV 2926CC M57 D30 (306D1) 0005631 - BMW 5 (E39) 530 d 09.1998/06.2003 142KW 193CV 2926CC M57 D30 (306D1) 0005696 - BMW 5 Touring (E39) 520 d 02.2000/09.2003 100KW 136CV 1951CC M47 D20 (204D1) 0005671...			CARDAN TRANSMISSÃO BMW 5 (E39) 520 i 01.1996/06.2003 100KW 136CV 1990CC M52 B20 (206S4) M52 B20 (206S3) 0005613 - BMW 5 (E39) 520 i 01.1996/06.2003 110KW 150CV 1990CC M52 B20 (206S4) M52 B20 (206S3) 0005569 - BMW 5 (E39) 520 i 09.2000/06.2003 125KW 170CV 2171CC M54 B22 (226S1) 0005688 - BMW 5 (E39) 523 i 09.1995/08.2000 125KW 170CV 2494CC M52 B25 (256S3) M52 B25 (256S4) 0005601 0005567 - BMW 5 (E39) 525 i 09.2000/06... - BMW 5 (E39) 525 i 09.2000/06...	
	d160x42mm	1f-d45mm 6f-d12mm		111x107x32mm	6f-d12mm
	<b>E0126</b>	NO. 31351091856 - 31351095662		<b>E0127</b>	NO. 31351091855 - 31351095661
	ESTICADOR DA BARRA ESTABILIZADORA DA FRENTE LADO DIREITO BMW SERIE 5 (E39) TT			ESTICADOR DA BARRA ESTABILIZADORA DA FRENTE LADO ESQUERDO BMW SERIE 5 (E39) TT	
	280x40x40mm	2p-d10-30mm		275x36x36mm	2p-d10-30mm
	<b>F1641A-I</b>	NO. 33211229209 - 33211229378 - 33217504705 - 33219067805		<b>F1653-I</b>	NO. 33211227602 - 33211229373 - 33219067817
	FOLE DA TRANSMISSÃO JUNTO À CAIXA BMW 5 (E39) 525 d 02.2000/06.2003 120KW 163CV 2497CC M57 D25 (256D1) 0005672 - BMW 5 (E39) 530 d 08.1998/09.2000 135KW 184CV 2926CC M57 D30 (306D1) 0005631 - BMW 5 (E39) 530 d 09.1998/06.2003 142KW 193CV 2926CC M57 D30 (306D1) 0005696 - BMW 5 Touring (E39) 525 d 02.2000/05.2004 120KW 163CV 2497 M57 D25 (256D1) 0005673 - BMW 5 Touring (E39) 530 d 08.1998/09.2000 135KW 184CV 2926 M57 D30 (306D1) 000...			FOLE DA TRANSMISSÃO JUNTO À CAIXA BMW SÉRIE 5 2.0i 520i - 2.2i 520i (1995 A 2004)	
	d110x92mm	1f-d106mm 1f-d25mm		d81x77mm	1f-d45mm 1f-d23mm



	<p><b>F1805-I</b> NO. 1094933 - 32131094933 - 32131096465 - 32131096910 - 32211139786</p> <p><b>FOLE DIREÇÃO ( GASTA 2 UNIDADES )</b></p> <p>BMW SERIE 5 (E86)</p> <p>d70x175mm 1f-d55mm 1f-d42mm</p>		<p><b>F4207</b> NO. 25118036629 - 25118037309</p> <p><b>FOLE ALAVANCA VELOCIDADES C/ MANETE PUNHO TOPO COMPLETO 6 VELOCIDADES</b></p> <p>BMW E39</p> <p>172x153x212mm 135x145mm</p>
	<p><b>F4345</b> NO. 33211226033 - 33211226264 - 33211229221 - 3321129376 - 33217504704 - 33219067813 - 33219067815</p> <p><b>FOLE TRANSMISSÃO JUNTO A RODA ( GASTA 2 UNIDADES )</b></p> <p>BMW 5 (E39) 520 d 02.2000/06.2003 100KW 136CV 1951CC M47 D20 (204D1) 0005670 - BMW 5 (E39) 523i 09.1995/08.2000 125KW 170CV 2494CC M52 B25 (256S3) M52 B25 (256S4) 0005601 0005567 - BMW 5 (E39) 525i 09.2000/06.2003 141KW 192CV 2494CC M54 B25 (256S5) 0005692 - BMW 5 (E39) 525td 01.1997/06.2003 85KW 116CV 2497CC M51 D25 (256T1) 0005616 - BMW 5 (E39) 525tds 01.1996/06.2003 105KW 143CV 2497CC M51 D...</p> <p>d81x79mm 1f-d22mm-1f-d52mm</p>		<p><b>F4345</b> NO. 33211226033 - 33211226264 - 33211229221 - 3321129376 - 33217504704 - 33219067813 - 33219067815</p> <p><b>FOLE TRANSMISSÃO JUNTO A RODA ( GASTA 2 UNIDADES )</b></p> <p>BMW 5 Touring (E39) 520 d 02.2000/09.2003 100KW 136CV 1951CC M47 D20 (204D1) 0005671 - BMW 5 Touring (E39) 520i 03.1997/08.2001 100KW 136CV 1990CC M52 B20 (206S3) M52 B20 (206S4) 0005615 - BMW 5 Touring (E39) 520i 03.1997/08.2001 110KW 150CV 1990CC M52 B20 (206S4) M52 B20 (206S3) 0005602 - BMW 5 Touring (E39) 520i 09.2000/12.2003 125KW 170CV 2171CC M54 B22 (226S1) 0005689 - BMW 5 Touring (E39) ...</p> <p>d81x79mm 1f-d22mm-1f-d52mm</p>
	<p><b>KUBT3028</b> NO. 34211164186 - 34216765212</p> <p><b>KIT BORRACHAS TRAVAO PINÇA TRAS ATE/TEVES 42MM</b></p> <p>BMW 5 (E39) 520 d 02.2000/06.2003 100KW 136CV 1951CC M47 D20 (204D1) 0005670 - BMW 5 (E39) 520i 01.1996/06.2003 100KW 136CV 1990CC M52 B20 (206S4) M52 B20 (206S3) 0005613 - BMW 5 (E39) 520i 01.1996/06.2003 110KW 150CV 1990CC M52 B20 (206S4) M52 B20 (206S3) 0005569 - BMW 5 (E39) 520i 09.2000/06.2003 125KW 170CV 2171CC M54 B22 (226S1) 0005688 - BMW 5 (E39) 523i 09.1995/08.2000 125KW 170CV 2494CC...</p> <p>d58x14mm d49x3mm d14x16mm 1f-d42mm 1f-d4mm</p>		<p><b>KUBT3028</b> NO. 34211164186 - 34216765212</p> <p><b>KIT BORRACHAS TRAVAO PINÇA TRAS ATE/TEVES 42MM</b></p> <p>BMW 5 Touring (E39) 520 d 02.2000/09.2003 100KW 136CV 1951CC M47 D20 (204D1) 0005671 - BMW 5 Touring (E39) 520i 03.1997/08.2001 100KW 136CV 1990CC M52 B20 (206S3) M52 B20 (206S4) 0005615 - BMW 5 Touring (E39) 520i 03.1997/08.2001 110KW 150CV 1990CC M52 B20 (206S4) M52 B20 (206S3) 0005602 - BMW 5 Touring (E39) 520i 09.2000/12.2003 125KW 170CV 2171CC M54 B22 (226S1) 0005689 - BMW 5 Touring (E39) ...</p> <p>d58x14mm d49x3mm d14x16mm 1f-d42mm 1f-d4mm</p>
	<p><b>KUR21999</b> NO. 1f-d24mm 1f-d10mm 1f-d10mm 1f-d19m</p> <p><b>KIT DE REPARAÇÃO ALAVANCA DE VELOCIDADES</b></p> <p>BMW 5 (E39) 520 d (De 02.2000 Até 06.2003) 100kW 136cv 1951cm3 três volumes - BMW 5 (E39) 520i (De 01.1996 Até 06.2003) 100kW 136cv 1990cm3 três volumes - BMW 5 (E39) 520i (De 01.1996 Até 06.2003) 110kW 150cv 1990cm3 três volumes - BMW 5 (E39) 520i (De 09.2000 Até 06.2003) 125kW 170cv 2171cm3 três volumes - BMW 5 (E39) 523i (De 09.1995 Até 08.2000) 125kW 170cv 2494cm3 três volumes - BMW 5 (E39)...</p> <p>d37x18mm d19x25mm d17x22mm d31x21mm d43x26mm d20mm 1f-d19mm 1f-d15mm</p>		<p><b>KUR21999</b> NO. 1f-d24mm 1f-d10mm 1f-d10mm 1f-d19m</p> <p><b>KIT DE REPARAÇÃO ALAVANCA DE VELOCIDADES</b></p> <p>BMW 5 Touring (E39) 520 d (De 02.2000 Até 09.2003) 100kW 136cv 1951cm3 Combi - BMW 5 Touring (E39) 520i (De 03.1997 Até 08.2001) 100kW 136cv 1990cm3 Combi - BMW 5 Touring (E39) 520i (De 03.1997 Até 08.2001) 110kW 150cv 1990cm3 Combi - BMW 5 Touring (E39) 520i (De 09.2000 Até 12.2003) 125kW 170cv 2171cm3 Combi - BMW 5 Touring (E39) 520i (De 03.1997 Até 08.2000) 125kW 170cv 2494cm3 Combi - BMW 5...</p> <p>d37x18mm d19x25mm d17x22mm d31x21mm d43x26mm d20mm 1f-d19mm 1f-d15mm</p>
	<p><b>P1042</b> NO. 35211160422</p> <p><b>CAPA DE PEDAL</b></p> <p>BMW 5 (E39) 520 d 02.2000/06.2003 100KW 136CV 1951CC M47 D20 (204D1) 0005670 - BMW 5 (E39) 520i 01.1996/06.2003 100KW 136CV 1990CC M52 B20 (206S4) M52 B20 (206S3) 0005613 - BMW 5 (E39) 520i 01.1996/06.2003 110KW 150CV 1990CC M52 B20 (206S4) M52 B20 (206S3) 0005569 - BMW 5 (E39) 520i 09.2000/06.2003 125KW 170CV 2171CC M54 B22 (226S1) 0005688 - BMW 5 (E39) 523i 09.1995/08.2000 125KW 170CV 2494CC...</p> <p>75x65x40mm</p>		<p><b>P1055</b> NO. 35211160421</p> <p><b>CAPA DE PEDAL DO TRAVÃO(VEÍCULOS COM CAIXA AUTOMÁTICA)</b></p> <p>BMW 5 (E39) 520i 01.1996/06.2003 110KW 150CV 1990CC M52 B20 (206S4) M52 B20 (206S3) 0005569 - BMW 5 (E39) 520i 09.2000/06.2003 125KW 170CV 2171CC M54 B22 (226S1) 0005688 523i 09.1995 - 08.2000 125 170 2494 M52 B25 (256S3) M52 B25 (256S4) 0005601 0005567 - BMW 5 (E39) 525 d 02.2000/06.2003 120KW 163CV 2497CC M57 D25 (256D1) 0005672 - BMW 5 (E39) 525i 09.2000/06.2003 141KW 192CV 2494CC M54 B25 (...)</p> <p>74x107x42mm</p>
	<p><b>P1059</b> NO. 1 108 634 - 35211108634</p> <p><b>CAPA DE PEDAL DO TRAVÃO</b></p> <p>BMW SÉRIE 5(E39) 520i - 520D - 523i - 525TD - 525TDS - 528i - 530D - 535i - 540i - M5 (11-1995 A 06-2003)</p> <p>75x62x12mm</p>		<p><b>R080024</b> NO. 48-56-36-225-27-41-19mm 1f-d6mm 1f</p> <p><b>TUBO RIGIDO DE REFRIGERAÇÃO</b></p> <p>BMW 5 (E39) 520i 01.1996/06.2003 110KW 150CV 1990CC M52 B20 (206S4) M52 B20 (206S3) 0005569 - BMW 5 (E39) 520i 09.2000/06.2003 125KW 170CV 2171CC M54 B22 (226S1) 0005688 - BMW 5 (E39) 523i 09.1995/08.2000 125KW 170CV 2494CC M52 B25 (256S3) M52 B25 (256S4) 0005601 0005567 - BMW 5 (E39) 525i 09.2000/06.2003 141KW 192CV 2494CC M54 B25 (256S5) 0005692 - BMW 5 (E39) 528i 09.1995/08.2000 142KW 193CV...</p> <p>B475-14/17mm 48-56-36-225-27-41-19mm 1f-d6mm 1f-d9mm...</p>
	<p><b>R080024</b> NO. 48-56-36-225-27-41-19mm 1f-d6mm 1f</p> <p><b>TUBO RIGIDO DE REFRIGERAÇÃO</b></p> <p>BMW 5 Touring (E39) 520i 03.1997/08.2001 110KW 150CV 1990CC M52 B20 (206S4) M52 B20 (206S3) 0005602 - BMW 5 Touring (E39) 520i 09.2000/12.2003 125KW 170CV 2171CC M54 B22 (226S1) 0005689 - BMW 5 Touring (E39) 523i 03.1997/08.2000 125KW 170CV 2494CC M52 B25 (256S3) M52 B25 (256S4) 0005601 0005567 - BMW 5 (E39) 525i 09.2000/05.2004 141KW 192CV 2494CC M54 B25 (256S5) 0005693 - BMW 5 Touring (E39) ...</p> <p>B475-14/17mm 48-56-36-225-27-41-19mm 1f-d6mm 1f-d9mm...</p>		<p><b>R222269</b> NO. 11612248622 - 11617786530</p> <p><b>TUBO DE LIGAÇÃO DO AR AO TURBO</b></p> <p>BMW 5 (E39) 525 d 02.2000/06.2003 120KW 163CV 2497CC M57 D25 (256D1) 0005672 - BMW 5 (E39) 530 d 08.1998/09.2000 135KW 184CV 2926CC M57 D30 (306D1) 0005631 - BMW 5 (E39) 530 d 09.1998/06.2003 142KW 193CV 2926CC M57 D30 (306D1) 0005696 - BMW 5 Touring (E39) 525 d 02.2000/05.2004 120KW 163CV 2497CC M57 D25 (256D1) 0005673 - BMW 5 Touring (E39) 530 d 08.1998/09.2000 135KW 184CV 2926CC M57 D30 (306D1)...</p> <p>B140-50/55mm 90-90mm</p>
	<p><b>R222277</b> NO. 11612247322 - 11617780009 - 11617785063 - 11617799391 - 11617799393</p> <p><b>TUBO DO AR SOBREALIMENTAÇÃO</b></p> <p>BMW 5 (E39) 520 d (De 2000.02 Até 2003.06) 100kW 136cv 1951cm3 três volumes -</p> <p>B155-53/53mm 76-76mm</p>		<p><b>R225953</b> NO. 13541435625</p> <p><b>TUBO DE ADMISSÃO FILTRO DE AR</b></p> <p>BMW 5 (E39) 520i 01.1996/06.2003 100KW 136CV 1990CC M52 B20 (206S4) M52 B20 (206S3) 0005613 - BMW 5 (E39) 520i 01.1996/06.2003 110KW 150CV 1990CC M52 B20 (206S4) M52 B20 (206S3) 0005569 - BMW 5 (E39) 520i 09.2000/06.2003 125KW 170CV 2171CC M54 B22 (226S1) 0005688 - BMW 5 (E39) 523i 09.1995/08.2000 125KW 170CV 2494CC M52 B25 (256S3) M52 B25 (256S4) 0005601 0005567 - BMW 5 (E39) 525i 09.2000/06...</p> <p>B190-74/77mm 91x140mm ch-d15x20mm</p>

	<p><b>R8184</b> NO. 32411093130 - 32411095526</p> <p><b>TUBO DE LIGAÇÃO DA BOMBA HIDRÁULICA DIREÇÃO</b></p> <p>BMW 5 (E39) 520 i 01.1996/06.2003 100KW 136CV 1990CC M52 B20 (206S4) M52 B20 (206S3) 0005613 - BMW 5 (E39) 520 i 01.1996/06.2003 110KW 150CV 1990CC M52 B20 (206S4) M52 B20 (206S3) 0005569 - BMW 5 (E39) 520 i 09.2000/06.2003 125KW 170CV 2171CC M54 B22 (226S1) 0005688 - BMW 5 (E39) 523 i 09.1995/08.2000 125KW 170CV 2494CC M52 B25 (256S3) M52 B25 (256S4) 0005601 0005567 - BMW 5 (E39) 525 i 09.2000/06...</p> <p>B360-d16/d16mm</p>		<p><b>S1271</b> NO. 31106770689 - 31106770690 - 31121092019 - 31121094235 - 31121122462 - 31121124622 - 31121133236 - 31121133236</p> <p><b>SILENT-BLOC DO BRAÇO DA SUSPENSÃO (FRENTE CENTRO)</b></p> <p>BMW 5 (E39) 520 d 02.2000/06.2003 100KW 136CV 1951CC M47 D20 (204D1) 0005670 - BMW 5 (E39) 520 i 01.1996/06.2003 100KW 136CV 1990CC M52 B20 (206S4) M52 B20 (206S3) 0005613 - BMW 5 (E39) 520 i 01.1996/06.2003 110KW 150CV 1990CC M52 B20 (206S4) M52 B20 (206S3) 0005569 - BMW 5 (E39) 520 i 09.2000/06.2003 125KW 170CV 2171CC M54 B22 (226S1) 0005688 - BMW 5 (E39) 523 i 09.1995/08.2000 125KW 170CV 2494CC...</p> <p>d46x52mm c40mm 1f-d12mm</p>
	<p><b>S1720</b> NO. 31126757551 - 31126767530 - 31126757511 - 31124012193</p> <p><b>SILENT-BLOC DO BRAÇO SUSPENSÃO TRANSVERSAL PARTE DE TRÁS</b></p> <p>BMW 5 Touring (E39) 530 d 09.2000/05.2004 142KW 193CV 2926CC M57 D30 (306D1) 0005697</p> <p>d67x63mm 1f-d30mm</p>		<p><b>S1861</b> NO. 33326755471 - 33326755472</p> <p><b>SILENT-BLOC DO EIXO SUSPENSÃO TRÁS PARTE FRENTE</b></p> <p>BMW 5 (E39) 520 d 02.2000/06.2003 100KW 136CV 1951CC M47 D20 (204D1) 0005670 - BMW 5 (E39) 520 i 01.1996/06.2003 100KW 136CV 1990CC M52 B20 (206S4) M52 B20 (206S3) 0005613 - BMW 5 (E39) 520 i 01.1996/06.2003 110KW 150CV 1990CC M52 B20 (206S4) M52 B20 (206S3) 0005569 - BMW 5 (E39) 520 i 09.2000/06.2003 125KW 170CV 2171CC M54 B22 (226S1) 0005688 - BMW 5 (E39) 523 i 09.1995/08.2000 125KW 170CV 2494CC...</p> <p>d51x70mm c49mm 1f-d10mm</p>
	<p><b>S1862</b> NO. 33321090031 - 33321090032 - 33321090519 - 33321093713 - 33321093714 - 33321093723 - 33321093724 - 33321093725</p> <p><b>SILENT-BLOC DO EIXO SUSPENSÃO TRÁS PARTE TRÁS</b></p> <p>BMW 5 (E39) 520 d 02.2000/06.2003 100KW 136CV 1951CC M47 D20 (204D1) 0005670 - BMW 5 (E39) 520 i 01.1996/06.2003 100KW 136CV 1990CC M52 B20 (206S4) M52 B20 (206S3) 0005613 - BMW 5 (E39) 520 i 01.1996/06.2003 110KW 150CV 1990CC M52 B20 (206S4) M52 B20 (206S3) 0005569 - BMW 5 (E39) 520 i 09.2000/06.2003 125KW 170CV 2171CC M54 B22 (226S1) 0005688 - BMW 5 (E39) 523 i 09.1995/08.2000 125KW 170CV 2494CC...</p> <p>d53x65mm c50mm 1f-d12mm</p>		<p><b>T0621-I</b> NO. 31331124449 - 31331124573 - 31331125215</p> <p><b>BATENTE SUSPENSÃO FRENTE</b></p> <p>BMW 5 (E39) 520 i (01.96A - 09.00) 150cv 1991cc três volumes 3/3 - BMW 5 (E39) 520 i (01.96 A 09.00) 150cv 1991cc três volumes - BMW 5 (E39) 523 i (11.95 A 09.00) 170cv 2494cc três volumes - BMW 5 (E39) 528 i (11.95 A 09.00) 193cv 2793cc três volumes - BMW 5 (E39) 535 i 04.96 A 03.99) 235cv 3498cc três volumes - BMW 5 (E39) 540 i (04.9 A 06.03) 286cv 4398cc três volumes - BMW 5 (E39) 525 td...</p> <p>d59x85mm 1f-d26mm 1f-d18mm</p>
	<p><b>T0625-I</b> NO. 33531091031</p> <p><b>BATENTE SUSPENSÃO FRENTE</b></p> <p>BMW 5 (E39) 520 i (04.99 A 06.03) 136cv 1991cc três volumes - BMW 5 (E39) 520 i (01.96 A 09.00) 150cv 1991cc três volumes - BMW 5 (E39) 520 i (09.00 A 06.03) 170cv 2171cc três volumes - BMW 5 (E39) 523 i (11.95 A 09.00) 170cv 2494cc três volumes - BMW 5 (E39) 525 i (09.00 A 06.03) 192cv 2494cc três volumes - BMW 5 (E39) 528 i (11.95 - 09.00) 193cv 2793cc três volumes - BMW 5 (E39) 530 i (09...</p> <p>d68x93mm 1f-d26mm 1f-d12mm</p>		<p><b>U7004</b> NO. 13641286708 - 13641730767</p> <p><b>ORING DE VÁLVULA INJETORA (Di 7,52 - De 14,58 - E 3,53)</b></p> <p>BMW 5 (E39) 520 i (01.1996 - 06.2003) 110kw 150cv 1990cm3 três volumes BMW 5 (E39) 523 i (09.1995 - 08.2000) 125kw 170cv 2494cm3 três volumes BMW 5 (E39) 528 i (09.1995 - 08.2000) 142kw 193cv 2793cm3 três volumes BMW 5 (E39) 535 i (03.1997 - 08.1998) 173kw 235cv 3498cm3 três volumes BMW 5 (E39) 540 i (03.1996 - 06.2003) 210kw 286cv 4398cm3 três volumes BMW 5 (E39) M5 (10.1998 - 06.2003) 294kw 400cv...</p> <p>d14x3mm 1f-d8mm</p>
	<p><b>U7033K</b> NO. 61671378609 - 64500149356 - 64500301636 - 64501363572 - 64501466019 - 64501468463 - 64508390601</p> <p><b>ORINGS BOMBA DIREÇÃO ASSISTIDA</b></p> <p>BMW 5 (E39) 520 d (02.2000 - 06.2003) 100kw 136cv 1951cm3 três volumes BMW 5 (E39) 520 i (01.1996 - 06.2003) 100kw 136cv 1990cm3 três volumes BMW 5 (E39) 520 i (01.1996 - 06.2003) 110kw 150cv 1990cm3 três volumes BMW 5 (E39) 520 i (09.2000 - 06.2003) 125kw 170cv 2171cm3 três volumes BMW 5 (E39) 523 i (09.1995 - 08.2000) 125kw 170cv 2494cm3 três volumes BMW 5 (E39) 525 d (02.2000 - 06.2003) 120kw ...</p> <p>d11x2mm d10x2mm 1f-d7mm 1f-d6mm</p>		<p><b>U7033K</b> NO. 61671378609 - 64500149356 - 64500301636 - 64501363572 - 64501466019 - 64501468463 - 64508390601</p> <p><b>ORINGS BOMBA DIREÇÃO ASSISTIDA</b></p> <p>BMW 5 Touring (E39) 520 d (02.2000 - 09.2003) 100kw 136cv 1951cm3 Combi BMW 5 Touring (E39) 520 i (03.1997 - 08.2001) 100kw 136cv 1990cm3 Combi BMW 5 Touring (E39) 520 i (03.1997 - 08.2001) 110kw 150cv 1990cm3 Combi BMW 5 Touring (E39) 523 i (03.1997 - 08.2000) 125kw 170cv 2494cm3 Combi BMW 5 Touring (E39) 525 d (02.2000 - 05.2004) 120kw 163cv 2497cm3 Combi BMW 5 Touring (E39) 525 i (09.2000 - 0...</p> <p>d11x2mm d10x2mm 1f-d7mm 1f-d6mm</p>
	<p><b>UAP83244</b> NO. 13537785722</p> <p><b>ANILHA PROTEÇÃO TÉRMICA INJETORES</b></p> <p>BMW 5 (E39) 525 d (De 02-2000 Até 06-2003) 120kW 163CV 2497cc três volumes BMW 5 (E39) 530 d (De 08-1998 Até 09-2000) 135kW 184CV 2926cc três volumes BMW 5 (E39) 530 d (De 09-1998 Até 06-2003) 142kW 193CV 2926cc três volumes BMW 5 Touring (E39) 525 d (De 02-2000 Até 05-2004) 120kW 163CV 2497cc Combi BMW 5 Touring (E39) 530 d (De 08-1998 Até 09-2000) 135kW 184CV 2926cc Combi BMW 5 Touring (E39)...</p> <p>d15x2mm 1f-d7mm</p>		<p><b>UFQ23302</b> NO. 21511223302</p> <p><b>FORQUILHA DA EMBRAIAGEM</b></p> <p>BMW 5 (E39) 520 i 01.1996/06.2003 100KW 136CV 1990CC M52 B20 (206S4) M52 B20 (206S3) 0005613 - BMW 5 (E39) 520 i 01.1996/06.2003 110KW 150CV 1990CC M52 B20 (206S4) M52 B20 (206S3) 0005569 - BMW 5 (E39) 520 i 09.2000/06.2003 125KW 170CV 2171CC M54 B22 (226S1) 0005688 - BMW 5 (E39) 523 i 09.1995/08.2000 125KW 170CV 2494CC M52 B25 (256S3) M52 B25 (256S4) 0005601 0005567 - BMW 5 (E39) 525 d 02.2000/06...</p> <p>252x83x28mm 1f-47x75mm</p>
	<p><b>UFQ23302</b> NO. 21511223302</p> <p><b>FORQUILHA DA EMBRAIAGEM</b></p> <p>BMW 5 Touring (E39) 520 i 03.1997/08.2001 100KW 136CV 1990CC M52 B20 (206S3) M52 B20 (206S4) 0005615 - BMW 5 Touring (E39) 520 i 03.1997/08.2001 110KW 150CV 1990CC M52 B20 (206S4) M52 B20 (206S3) 0005602 - BMW 5 Touring (E39) 520 i 09.2000/12.2003 125KW 170CV 2171CC M54 B22 (226S1) 0005689 - BMW 5 Touring (E39) 523 i 03.1997/08.2000 125KW 170CV 2494CC M52 B25 (256S3) M52 B25 (256S4) 0005604 - BMW ...</p> <p>252x83x28mm 1f-47x75mm</p>		<p><b>UMV25113</b> NO. 25112229442 - 25117566267 - 25117833136 - 25118037305</p> <p><b>MANETE PUNHO TOPO ALAVANCA MUDANÇAS 6 VELOCIDADES F14MM</b></p> <p>BMW 5 (E39) 540 i 03.1996/06.2003 210KW 286CV 4398CC M62 B44 (448S2) M62 B44 (448S1) 0005619 0005572 - BMW 5 Touring (E39) 540 i 04.1997/12.2003 210KW 286CV 4398CC M62 B44 (448S2) M62 B44 (448S1) 0005606</p> <p>95x54x45mm 1f-d14mm</p>
	<p><b>UMV25127</b> NO. 25112229442 - 25117566267 - 25117833136 - 25118037305</p> <p><b>MANETE PUNHO TOPO ALAVANCA MUDANÇAS 5 VELOCIDADES F14MM</b></p> <p>BMW 5 (E39) 540 i (De 03.1996 Até 06.2003) 210kW 286cv 4398cm3 três volumes -</p> <p>d46x94mm 1f-d14mm</p>		<p><b>W5047</b> NO. 0614610 - 0614612 - 11232244417 - 11232245377 - 11232246510 - 11232246511 - 614610 - 614612 - ...</p> <p><b>POLIE DA CABBOTA (5 PISTAS)</b></p> <p>BMW 5 (E39): 525 td 01.1997/06.2003 85KW 116CV 2497CC - BMW 5 (E39): 525 tds 01.1996/06.2003 105KW 143CV 2497CC - BMW 5 Touring (E39): 525 tds 03.1997/05.2004 105KW 143CV 2497CC</p> <p>d157/205mm d45mm</p>

	<p><b>W5057</b> NO. 0614602 - 0614602 - 11232247886 - 11232247890 - 614602 - 93171365 - LHG000100</p> <p>POLIE DA CAMBOTA (5 + 5 PISTAS)</p> <p>BMW SERIE 5 (E39) 525D (02-2000 A 06-2003) Mtr M57256D1 (163CV) BMW SERIE 5 (E39) 530D (09-2000 A 06-2003 Mtr M57D30 (184-193CV)</p> <p>d155mm d10mm</p>		<p><b>W5072</b> NO. 11232247260 - 11232247565 - 11232248268</p> <p>POLIE DA CAMBOTA (5 + 5 PISTAS)</p> <p>BMW 520 D E39</p> <p>d141.8/149.8mm d18.5mm</p>
	<p><b>Y3239</b> NO. 36130141574 - 36130141576 - 36131095390 - 36131116717 - 36131117190 - 36131126191</p> <p>PARAFUSO PERNO RODA CHAVE 17 M12X1,50X50MM ( BASE CONICA )</p> <p>BMW 5 (E39) 520 d 02.2000/06.2003 100KW 136CV 1951CC M47 D20 (204D1) 0005670 - BMW 5 (E39) 520 i 01.1996/06.2003 100KW 136CV 1990CC M52 B20 (206S4) M52 B20 (206S3) 0005613 - BMW 5 (E39) 520 i 01.1996/06.2003 110KW 150CV 1990CC M52 B20 (206S4) M52 B20 (206S3) 0005569 - BMW 5 (E39) 520 i 09.2000/06.2003 125KW 170CV 2171CC M54 B22 (226S1) 0005688 - BMW 5 (E39) 523 i 09.1995/08.2000 125KW 170CV 2494CC...</p> <p>c51mm (ch-17mm) M12x1x24mm</p>		<p><b>Y3239</b> NO. 36130141574 - 36130141576 - 36131095390 - 36131116717 - 36131117190 - 36131126191</p> <p>PARAFUSO PERNO RODA CHAVE 17 M12X1,50X50MM ( BASE CONICA )</p> <p>BMW 5 Touring (E39) 520 d 02.2000/09.2003 100KW 136CV 1951CC M47 D20 (204D1) 0005671 - BMW 5 Touring (E39) 520 i 03.1997/08.2001 100KW 136CV 1990CC M52 B20 (206S3) M52 B20 (206S4) 0005615 - BMW 5 Touring (E39) 520 i 03.1997/08.2001 110KW 150CV 1990CC M52 B20 (206S4) M52 B20 (206S3) 0005602 - BMW 5 Touring (E39) 520 i 09.2000/12.2003 125KW 170CV 2171CC M54 B22 (226S1) 0005689 - BMW 5 Touring (E39) ...</p> <p>c51mm (ch-17mm) M12x1x24mm</p>
	<p><b>Z80849</b> NO. 51411973500 - 99950758240</p> <p>Mola de painel</p> <p>BMW SÉRIE 5(E39)</p> <p>d18x21mm 1p-d9-13mm</p>		

## BMW SERIE 5(E60)

	<p><b>A1887</b> NO. 26103413996 - 26123413997 - 26127521855</p> <p>APOIO DA TRANSMISSÃO</p> <p>BMW 5 (E60) 520i (07-2003 A 03-2010) 170CV 2171CC - BMW 5 (E60) 523i (07-2005 A 03-2010) 177CV 2497CC - BMW 5 (E60) 523i (01-2007 A 03-2010) 190CV 2497CC - BMW 5 (E60) 523i (01-2007 A 03-2010) 190CV 2497CC - BMW 5 (E60) 525i (09-2003 A 03-2010) 192CV 2494</p> <p>180x108x34mm 1f-d30mm</p>		<p><b>A1891</b> NO. 26127521856</p> <p>APOIO DA TRANSMISSÃO</p> <p>BMW 5 (E60) 545i (09-2003 A 03-2010) 333CV 4398CC - BMW 5 (E60) 540i (07-2005 A 03-2010) 306CV 4000CC - BMW 5 (E60) 550i (07-2005 A 03-2010) 367CV 4799CC - BMW 5 (E60) 525d (12-2004 A 03-2010) 163CV 2497CC - BMW 5 (E60) 525d (06-2004 A 03-2010) 177CV 2497</p> <p>182x105x32mm 1f-d35mm</p>
	<p><b>D0035</b> NO. 26117522027</p> <p>CARDAN TRANSMISSÃO</p> <p>BMW 5 (E60) 520 i (09.07 A 03.10) 170cv 1995cc três volumes - BMW 5 (E60) 520 i (07.03 A 03.10) 170cv 2171cc três volumes - BMW 5 (E60) 523i (07.05 A 03.10) 177cv 2497cc três volumes - BMW 5 (E60) 523i (01.07 A 03.10) 190cv 2497cc três volumes - BMW 5 (E60) 525 i (09.03 A 03.10) 192cv 2494cc três volumes - BMW 5 (E60) 525 i (07.05 A 03.10) 218cv 2497cc três volumes - BMW 5 (E60) 525 ...</p> <p>125x135x32mm 6f-d12mm</p>		<p><b>D0063</b> NO. 26117542238</p> <p>CARDAN DA TRANSMISSÃO</p> <p>BMW 5 (E60) 545 i (De 09-2003 Até 03-2010) 245kW 333CV 4398cc três volumes BMW 5 (E60) 540 i (De 07-2005 Até 03-2010) 225kW 306CV 4000cc três volumes BMW 5 (E60) 550 i (De 07-2005 Até 03-2010) 270kW 367CV 4799cc três volumes BMW 5 (E60) 525 d (De 12-2004 Até 03-2010) 120kW 163CV 2497cc três volumes BMW 5 (E60) 525 d (De 06-2004 Até 03-2010) 130kW 177CV 2497cc três volumes BMW 5 (E60) 525 d (D...</p> <p>163x155x42mm 6f-d12mm</p>
	<p><b>E1116</b> NO. 18307793793</p> <p>APOIO DO ESCAPE</p> <p>BMW 5 (E60) 535 d (09.04 A 03.10) 272cv 2993cc três volumes - BMW 5 Touring (E61) 535 d (09.04 A 12.10) 272cv 2993cc Combi</p> <p>70x40x26mm</p>		<p><b>E1122</b> NO. 18203404099 - 18207544809 - 18207568777 - 18207791570 - 18207798560</p> <p>ESTICADOR DO ESCAPE PANELA DE TRÁS</p> <p>BMW 5 (E60) 525 d (De 12.2004 Até 03.2010) 120kW 163cv 2497cm3 três volumes -</p> <p>82x50x25mm 2f-d10mm</p>
	<p><b>F1846-I</b> NO. 33211229594 - 33217527325 - 33217527326 - 33217529915 - 33217547080</p> <p>FOLE DA TRANSMISSÃO JUNTO Á RODA</p> <p>BMW SÉRIE 5 (E60) 2.5i 525i - 3.0i 530i (APÓS 2003)</p> <p>d80x78mm 1f-d51mm 1f-d31mm</p>		<p><b>F1847-I</b> NO. 33211229590 - 33217527323 - 33217527324 - 33217529919</p> <p>FOLE DA TRANSMISSÃO JUNTO Á RODA</p> <p>BMW SÉRIE 5 (E60) 2.2i 520i (APÓS 2003)</p> <p>d80x78mm 1f-d44mm 1f-d30mm</p>



	<p><b>F4207</b> NO. 25118036629 - 25118037309</p> <p>FOLE ALAVANCA VELOCIDADES C/ MANETE PUNHO TOPO COMPLETO 6 VELOCIDADES BMW E60</p> <p>172x153x212mm 135x145mm</p>		<p><b>KUBT3028</b> NO. 34211164186 - 34216765212</p> <p>KIT BORRACHAS TRAVAO PINÇA TRAS ATE/TEVES 42MM</p> <p>BMW 5 (E60) 520 d 09.2005/02.2007 110KW 150CV 1995CC M47 D20 (204D4) 0005ABQ 0005867 - BMW 5 (E60) 520 d 09.2005/12.2009 120KW 163CV 1995CC N47 D20 C M47 D20 (204D4) N47 D20 A 0005ABI 0005865 - BMW 5 (E60) 520 d 09.2007/12.2009 130KW 177CV 1995CC N47 D20 A N47 D20 C 0005AJC - BMW 5 (E60) 520 i 07.2003/03.2010 125KW 170CV 2171CC M54 B22 (226S1) 0005759 - BMW 5 (E60) 520 i 09.2007/02.2010 115KW 156C...</p> <p>d58x14mm d49x3mm d14x8mm d10x6mm 1f-d42mm 1f-d4mm</p>
	<p><b>KUBT3037</b> NO. 1f-d31mm 1f-d12/16mm 1f-d43mm 1f-d</p> <p>KIT BORRACHAS TRAVAO PINÇA TRAS ATE 42MM</p> <p>BMW X5 (E53) 4.4 i 10.2003/10.2006 235KW 320CV 4398CC N62 B44 A 0005AMX 0005785 - BMW X5 (E53) 4.6 is 10.2001/09.2003 255KW 347CV 4619CC M62 B46 (468S1) 0005756 - BMW X5 (E53) 4.8 is 04.2004/09.2006 265KW 360CV 4799CC N62 B48 A 0005800</p> <p>d58x12mm d21x40mm(x2) 14x8mm 1f-d42mm 1f-d43mm 1f-d13mm</p>		<p><b>KUBT3037</b> NO. 1f-d31mm 1f-d12/16mm 1f-d43mm 1f-d</p> <p>KIT BORRACHAS TRAVAO PINÇA TRAS ATE 42MM</p> <p>BMW 5 (E60) 520 d 09.2005/02.2007 110KW 150CV 1995CC M47 D20 (204D4) 0005ABQ 0005867 - BMW 5 (E60) 520 d 09.2005/12.2009 120KW 163CV 1995CC N47 D20 C M47 D20 (204D4) N47 D20 A 0005ABI 0005865 - BMW 5 (E60) 520 d 09.2007/12.2009 130KW 177CV 1995CC N47 D20 A N47 D20 C 0005AJC - BMW 5 (E60) 520 i 07.2003/03.2010 125KW 170CV 2171CC M54 B22 (226S1) 0005759 - BMW 5 (E60) 520 i 12.2006/03.2010 120KW 163C...</p> <p>d58x12mm d21x40mm(x2) 14x8mm 1f-d42mm 1f-d43mm 1f-d13mm...</p>
	<p><b>KUR21999</b> NO. 1f-d24mm 1f-d10mm 1f-d10mm 1f-d19mm</p> <p>KIT DE REPARAÇÃO ALAVANCA DE VELOCIDADES</p> <p>BMW 5 (E60) 520 d (De 09.2005 Até 02.2007) 110kW 150cv 1995cm3 três volumes - BMW 5 (E60) 520 d (De 09.2005 Até 12.2009) 120kW 163cv 1995cm3 três volumes - BMW 5 (E60) 520 d (De 09.2007 Até 12.2009) 130kW 177cv 1995cm3 três volumes - BMW 5 (E60) 520 i (De 09.2007 Até 02.2010) 115kW 156cv 1995cm3 três volumes - BMW 5 (E60) 520 i (De 09.2007 Até 12.2009) 125kW 170cv 1995cm3 três volumes - BMW 5 (E60)...</p> <p>d37x18mm d19x25mm d17x22mm d31x21mm d31x21mm 1f-d19mm</p>		<p><b>P1042</b> NO. 35211160422</p> <p>CAPA DE PEDAL</p> <p>BMW 5 (E60) 520 d 09.2005/12.2009 120KW 163CV 1995CC N47 D20 C M47 D20 (204D4) N47 D20 A 0005ABI 0005865 - BMW 5 (E60) 520 i 07.2003/03.2010 125KW 170CV 2171CC M54 B22 (226S1) 0005759 - BMW 5 (E60) 523 i 10.2004/02.2007 130KW 177CV 2497CC N52 B25 B N52 B25 BE N52 B25 A 0005834 0005ABC - BMW 5 (E60) 525 d 06.2004/03.2010 130KW 177CV 2497CC M57 D25 (256D2) 0005ABL 0005796 - BMW 5 (E60) 525 i 09.2003...</p> <p>.75x65x40mm</p>
	<p><b>P1055</b> NO. 35211160421</p> <p>CAPA DE PEDAL DO TRAVÃO(VEÍCULOS COM CAIXA AUTOMÁTICA)</p> <p>BMW 5 (E60) 520 d 09.2005/12.2009 120KW 163CV 1995CC N47 D20 C M47 D20 (204D4) N47 D20 A 0005ABI 0005865 - BMW 5 (E60) 520 i 07.2003/03.2010 125KW 170CV 2171CC M54 B22 (226S1) 0005759 - BMW 5 (E60) 523 i 10.2004/02.2007 130KW 177CV 2497CC N52 B25 B N52 B25 BE N52 B25 A 0005834 0005ABC - BMW 5 (E60) 525 d 06.2004/03.2010 130KW 177CV 2497CC M57 D25 (256D2) 0005ABL 0005796 - BMW 5 (E60) 525 i 09.2003...</p> <p>74x107x42mm</p>		<p><b>P1059</b> NO. 1 108 634 - 35211108634</p> <p>CAPA DE PEDAL DO TRAVÃO</p> <p>BMW SÉRIE 5(E60) 525i - 530i - 530XD - 535D - 545i - 550i - (APÓS 07-2003)</p> <p>75x62x12mm</p>
	<p><b>R222229</b> NO. 17127787448 - 7787448</p> <p>TUBO SUPERIOR DO RADIADOR LADO ESQUERDO COM BOCAL</p> <p>BMW 5 (E60) 520 d 09.2005/02.2007 110KW 150CV 1995CC M47 D20 (204D4) 0005ABQ 0005867 - BMW 5 (E60) 520 d 09.2005/12.2009 120KW 163CV 1995CC N47 D20 C M47 D20 (204D4) N47 D20 A 0005ABI 0005865 - BMW 5 (E60) 520 d 09.2007/12.2009 130KW 177CV 1995CC N47 D20 A N47 D20 C 0005AJC - BMW 5 (E60) 520 i 07.2003/03.2010 125KW 170CV 2171CC M54 B22 (226S1) 0005759</p> <p>B560-39/39mm 122x145x78x200x63x81mm</p>		<p><b>R222271</b> NO. 11617787468 - 11617794064</p> <p>TUBO ADMISSÃO FILTRO DE AR</p> <p>BMW 5 (E60) 525 d 06.2004/03.2010 130KW 177CV 2497CC M57 D25 (256D2) 0005ABL 0005796 - BMW 5 (E60) 525 d 12.2004/03.2010 120KW 163CV 2497CC M57 D25 (256D2) 0005ABS 0005797 - BMW 5 (E60) 525 d 01.2007/03.2010 145KW 197CV 2993CC M57 D30 (306D3) 0005AIC - BMW 5 (E60) 525 d xDrive 09.2007/12.2009 145KW 197CV 2993CC M57 D30 (306D3) 0005AJE - BMW 5 (E60) 525 xd 11.2006/08.2007 145KW 197CV 2993CC M57 D30...</p> <p>B245-55/62mm 50-140-80mm</p>
	<p><b>R222272</b> NO. 11617790090 - 116177900901</p> <p>TUBO ADMISSÃO FILTRO DE AR</p> <p>BMW 5 (E60) 520 d 09.2005/02.2007 110KW 150CV 1995CC M47 D20 (204D4) 0005ABQ 0005867 - BMW 5 (E60) 520 d 09.2005/12.2009 120KW 163CV 1995CC N47 D20 C M47 D20 (204D4) N47 D20 A 0005ABI 0005865 - BMW 5 (E60) 520 d 09.2007/12.2009 130KW 177CV 1995CC N47 D20 A N47 D20 C 0005AJC</p> <p>B225-55/59mm B160-55/610x76mm</p>		<p><b>R222282</b> NO. 11617791664 - 11617796294 - 11617797697 - 11617799401 - 116177994011</p> <p>TUBO ADMISSÃO FILTRO DE AR</p> <p>BMW 5 (E60) 520 d 09.2005/02.2007 110KW 150CV 1995CC M47 D20 (204D4) 0005ABQ 0005867 - BMW 5 (E60) 520 d 09.2005/12.2009 120KW 163CV 1995CC N47 D20 C M47 D20 (204D4) N47 D20 A 0005ABI 0005865 - BMW 5 (E60) 520 d 09.2007/12.2009 130KW 177CV 1995CC N47 D20 A N47 D20 C 0005AJC - BMW 5 (E60) 525 d 06.2004/03.2010 130KW 177CV 2497CC M57 D25 (256D2) 0005ABL 0005796 - BMW 5 (E60) 525 d 01.2007/03.2010 14...</p> <p>B140-d55/64mm 50-120mm</p>
	<p><b>R222283</b> NO. 11617791664 - 11617797697 - 11617799401</p> <p>TUBO DO AR SOBREALIMENTAÇÃO</p> <p>BMW 5 (E60) 520 d (De 09.2005 Até 02.2007) 110kW 150cv 1995cm3 três volumes - BMW 5 (E60) 520 d (De 09.2005 Até 12.2009) 120kW 163cv 1995cm3 três volumes - BMW 5 (E60) 520 d (De 09.2007 Até 12.2009) 130kW 177cv 1995cm3 três volumes - BMW 5 (E60) 525 d (De 06.2004 Até 03.2010) 130kW 177cv 2497cc três volumes - BMW 5 (E60) 525 d (De 01.2007 Até 03.2010) 145kW 197cv 2993cm3 três volumes - BMW 5 (E6...</p> <p>B194-53/62mm 112x85mm</p>		<p><b>R222287</b> NO. 1161779963 - 11617797707 - 11617799400</p> <p>TUBO DO AR SOBREALIMENTAÇÃO</p> <p>BMW 5 (E60) 530 d (De 09.2002 Até 12.2009) 155kW 211cv 2993cm3 três volumes - BMW 5 (E60) 530 d (De 09.2002 Até 09.2005) 160kW 218cv 2993cm3 três volumes - BMW 5 (E60) 530 d (De 09.2005 Até 03.2007) 170kW 231cv 2993cm3 três volumes - BMW 5 (E60) 530 d (De 02.2007 Até 12.2009) 173kW 235cv 2993cm3 três volumes - BMW 5 (E60) 530 xd (De 02.2005 Até 02.2007) 170kW 231cv 2993cm3 três volumes - BMW 5 (E6...</p> <p>B200-53/63mm 100x81mm</p>
	<p><b>R224946</b> NO. 11614727353 - 11617798438 - 11617808414</p> <p>TUBO DO AR SOBREALIMENTAÇÃO</p> <p>BMW 5 (E60) 525 d (De 12.2004 Até 03.2010) 120kW 163cv 2497cm3 três volumes - BMW 5 (E60) 525 d (De 06.2004 Até 03.2010) 130kW 177cv 2497cm3 três volumes - BMW 5 (E60) 525 d (De 01.2007 Até 03.2010) 145kW 197cv 2993cm3 três volumes - BMW 5 (E60) 525 d xDrive (De 09.2007 Até 12.2009) 145kW 197cv 2993cm3 três volumes - BMW 5 (E60) 525 xd (De 11.2006 Até 08.2007) 145kW 197cv 2993cm3 três volumes - BM...</p> <p>B238-53/63mm 188x45mm</p>		<p><b>R225318</b> NO. 11617791664 - 11617796294 - 11617797697 - 11617799401</p> <p>TUBO DO AR SOBREALIMENTAÇÃO</p> <p>BMW 5 (E60) 520 d (De 09.2005 Até 02.2007) 110kW 150cv 1995cm3 três volumes - BMW 5 (E60) 520 d (De 09.2005 Até 12.2009) 120kW 163cv 1995cm3 três volumes - BMW 5 (E60) 520 d (De 09.2007 Até 12.2009) 130kW 177cv 1995cm3 três volumes - BMW 5 (E60) 525 d (De 06.2004 Até 03.2010) 130kW 177cv 2497cm3 três volumes - BMW 5 (E60) 525 d (De 01.2007 Até 03.2010) 145kW 197cv 2993cm3 três volumes - BMW 5 (E60)...</p> <p>B205-54/72mm B210-56/640x87mm 91x84x51mm</p>

	<p><b>R225322</b> NO. 11617789963 - 11617797707 - 11617799400</p> <p><b>TUBO DO AR SOBREALIMENTAÇÃO</b></p> <p>BMW 5 (E60) 530 d (De 09.2002 Até 12.2009) 155kW 211cv 2993cm3 três volumes - BMW 5 (E60) 530 d (De 09.2002 Até 09.2005) 160kW 218cv 2993cm3 três volumes - BMW 5 (E60) 530 d (De 09.2005 Até 03.2007) 170kW 231cv 2993cm3 três volumes - BMW 5 (E60) 530 d (De 02.2007 Até 12.2009) 173kW 235cv 2993cm3 três volumes - BMW 5 (E60) 530 xd (De 02.2005 Até 02.2007) 170kW 231cv 2993cm3 três volumes - BMW 5 (E6...</p> <p>B205-52/63mm B205-56/6405x85mm 101x88x50mm</p>		<p><b>R225323</b> NO. 11617789963 - 11617797707 - 11617799400</p> <p><b>TUBO DO AR SOBREALIMENTAÇÃO</b></p> <p>BMW 5 (E60) 530 d (De 09.2002 Até 12.2009) 155kW 211cv 2993cm3 três volumes - BMW 5 (E60) 530 d (De 09.2002 Até 09.2005) 160kW 218cv 2993cm3 três volumes - BMW 5 (E60) 530 d (De 09.2005 Até 03.2007) 170kW 231cv 2993cm3 três volumes - BMW 5 (E60) 530 d (De 02.2007 Até 12.2009) 173kW 235cv 2993cm3 três volumes - BMW 5 (E60) 530 xd (De 02.2005 Até 02.2007) 170kW 231cv 2993cm3 três volumes - BMW 5 (E6...</p> <p>B220-57/63mm 104x72x53mm</p>
	<p><b>RT08457</b> NO. 34321154904</p> <p><b>TUBO DE TRAVÃO TRÁS LH-RH</b></p> <p>BMW 5 (E60) 520 d (De 09.2005 Até 12.2009) 120kW 163cv 1995cm3 três volumes - BMW 5 (E60) 520 i (De 07.2003 Até 03.2010) 125kW 170cv 2171cm3 três volumes - BMW 5 (E60) 523 i (De 10.2004 Até 02.2007) 130kW 177cv 2497cm3 três volumes - BMW 5 (E60) 525 d (De 06.2004 Até 03.2010) 130kW 177cv 2497cm3 três volumes - BMW 5 (E60) 525 i (De 09.2003 Até 02.2005) 141kW 192cv 2494cm3 três volumes - BMW 5 (E6...</p> <p>ponteira-1 (F) ponteira-2 (M) 101x300mm</p>		<p><b>RT80281</b> NO. 34226760909 - 34326767390</p> <p><b>TUBO DE TRAVÃO FRENTE LH-RH</b></p> <p>BMW SÉRIE 5 (E60) 520 D (APÓS 09-2005) - SÉRIE 5 (E60) 520 i (APÓS 07-2003) - SÉRIE 5 (E60) 525 D (APÓS 06-2004) - SÉRIE 5 (E60) 525 i (APÓS 09-2003) - SÉRIE 5 (E60) 530 D (APÓS 07-2003) - SÉRIE 5 (E60) 530 i (APÓS 07-2003) - SÉRIE 5 (E60) 535 D (APÓS 09</p> <p>580mm F6 - MC55</p>
	<p><b>S1271</b> NO. 31106770689 - 31106770690 - 31121092019 - 31121094235 - 31121122462 - 31121124622 - 31121133236 - 31121133237</p> <p><b>SILENT-BLOC DO BRAÇO DA SUSPENSÃO (FRENTE CENTRO)</b></p> <p>BMW 5 (E60) 525 d xDrive 09.2008/12.2009 145KW 197CV 2993CC M57 D30 (306D3) 0005AJE - BMW 5 (E60) 525 i xDrive 09.2008/03.2010 160KW 218CV 2996CC N53 B30 A 0005AIO - BMW 5 (E60) 525 xd 09.2007/08.2008 145KW 197CV 2993CC M57 D30 (306D3) 0005AJE - BMW 5 (E60) 525 xi 04.2005/02.2007 160KW 218CV 2497CC N52 B25 A 0005176 0005AHD - BMW 5 (E60) 525 xi 03.2007/12.2009 160KW 218CV 2996CC N53 B30 A 0005AIO ...</p> <p>d46x52mm c40mm 1f-d12mm</p>		<p><b>T0624-I</b> NO. 31330146239 - 31331094749 - 31336764085</p> <p><b>BATENTE SUSPENSÃO FRENTE</b></p> <p>BMW 5 (E60) 520 d 09.2005/02.2007 110KW 150CV 1995CC M47 D20 (204D4) 0005ABQ 0005867 - BMW 5 (E60) 520 d 09.2005/12.2009 120KW 163CV 1995CC N47 D20 C M47 D20 (204D4) N47 D20 A 0005ABI 0005865 - BMW 5 (E60) 520 d 09.2007 - 12.2009 130KW 177CV 1995CC N47 D20 A N47 D20 C 0005AJC - BMW 5 (E60) 520 i 07.2003/03.2010 125KW 170CV 2171CC M54 B22 (226S1) 0005759 - BMW 5 (E60) 520 i 09.2007/02.2010 115KW 15...</p> <p>d58x87mm 1f-d27mm 1f-d23mm</p>
	<p><b>U7033K</b> NO. 61671378609 - 64500149356 - 64500301636 - 64501363572 - 64501466019 - 64501468463 - 64508390601</p> <p><b>ORINGS BOMBA DIREÇÃO ASSITIDA</b></p> <p>BMW 5 (E60) 520 d (09.2007 - 12.2009) 130kw 177cv 1995cm3 três volumes BMW 5 (E60) 520 d (09.2005 - 02.2007) 110kw 150cv 1995cm3 três volumes BMW 5 (E60) 520 d (09.2005 - 12.2009) 120kw 163cv 1995cm3 três volumes BMW 5 (E60) 523 i (10.2004 - 02.2007) 130kw 177cv 2497cm3 três volumes BMW 5 (E60) 523 i (03.2007 - 12.2009) 140kw 190cv 2497cm3 três volumes BMW 5 (E60) 525 d (12.2004 - 03.2010) 120kw ...</p> <p>d11x2mm d10x2mm 1f-d7mm 1f-d6mm</p>		<p><b>UAP81292</b> NO. 13532247156 - 2247156</p> <p><b>ANILHA PROTEÇÃO TÉRMICA INJECTORES</b></p> <p>BMW 5 (E60) 520 d (De 04-2006 Até 12-2009) 130kW 177CV 1995cc três volumes BMW 5 (E60) 525 d (De 01-2007 Até 03-2010) 145kW 197CV 2993cc três volumes BMW 5 (E60) 530 xd (De 03-2007 Até 08-2007) 173kW 235CV 2993cc três volumes</p> <p>d16x1mm 1f-d7mm</p>
	<p><b>UAP81905</b> NO. 13532247156 - 2247156</p> <p><b>ANILHA PROTEÇÃO TÉRMICA INJECTORES</b></p> <p>BMW 5 (E60) 520 d (De 04-2006 Até 12-2009) 130kW 177CV 1995cc três volumes BMW 5 (E60) 525 d (De 01-2007 Até 03-2010) 145kW 197CV 2993cc três volumes BMW 5 (E60) 530 xd (De 03-2007 Até 08-2007) 173kW 235CV 2993cc três volumes</p> <p>d14x1mm 1f-d7mm</p>		<p><b>UFQ23302</b> NO. 21511223302</p> <p><b>FORQUILHA DA EMBRAIAGEM</b></p> <p>BMW 5 (E60) 520 i 07.2003/03.2010 125KW 170CV 2171CC M54 B22 (226S1) 0005759 - BMW 5 (E60) 525 d 06.2004/03.2010 130KW 177CV 2497CC M57 D25 (256D2) 0005ABL 0005796 - BMW 5 (E60) 525 d 12.2004/03.2010 120KW 163CV 2497CC M57 D25 (256D2) 0005ABS 0005797 - BMW 5 (E60) 525 d 01.2007/03.2010 145KW 197CV 2993CC M57 D30 (306D3) 0005AIC - BMW 5 (E60) 525 i 09.2003/02.2005 141KW 192CV 2494CC M54 B25 (256S5)...</p> <p>252x83x28mm 1f-47x75mm</p>
	<p><b>UMV25106</b> NO. 25117503100 - 25117566267</p> <p><b>MANETE PUNHO TOPO ALAVANCA MUDANÇAS 5 VELOCIDADES F14MM</b></p> <p>BMW 5 (E60) 520 d 09.2005/02.2007 110KW 150CV 1995CC M47 D20 (204D4) 0005ABQ 0005867 - BMW 5 (E60) 520 d 09.2005/12.2009 120KW 163CV 1995CC N47 D20 C M47 D20 (204D4) N47 D20 A 0005ABI 0005865 - BMW 5 (E60) 520 d 09.2007/12.2009 130KW 177CV 1995CC N47 D20 A N47 D20 C 0005AJC - BMW 5 (E60) 520 i 12.2006/03.2010 120KW 163CV 1995CC N43 B20 A 0005AJA - BMW 5 (E60) 520 i 09.2007/02.2010 115KW 156CV 1995...</p> <p>95x45x55mm 1f-d14mm</p>		<p><b>UMV25107</b> NO. 25117550685</p> <p><b>MANETE PUNHO TOPO ALAVANCA MUDANÇAS 6 VELOCIDADES F14MM</b></p> <p>BMW 5 (E60) 520 d 09.2005/02.2007 110KW 150CV 1995CC M47 D20 (204D4) 0005ABQ 0005867 - BMW 5 (E60) 520 d 09.2005/12.2009 120KW 163CV 1995CC N47 D20 C M47 D20 (204D4) N47 D20 A 0005ABI 0005865 - BMW 5 (E60) 520 i 07.2003/03.2010 125KW 170CV 2171CC M54 B22 (226S1) 0005759 - BMW 5 (E60) 523 i 10.2004/02.2007 130KW 177CV 2497CC N52 B25 B N52 B25 BE N52 B25 A 0005834 0005ABC - BMW 5 (E60) 523 i 03.2007...</p> <p>95x45x54mm 1f-d14mm</p>
	<p><b>UMV25111</b> NO. 25111434495 - 25117500299 - 25117503231 - 25117523817 - 25117544524</p> <p><b>MANETE PUNHO TOPO ALAVANCA MUDANÇAS 6 VELOCIDADES F14MM</b></p> <p>BMW 5 (E60) 520 d 09.2005/02.2007 110KW 150CV 1995CC M47 D20 (204D4) 0005ABQ 0005867 - BMW 5 (E60) 520 d 09.2005/12.2009 120KW 163CV 1995CC N47 D20 C M47 D20 (204D4) N47 D20 A 0005ABI 0005865 - BMW 5 (E60) 520 d 09.2007/12.2009 130KW 177CV 1995CC N47 D20 A N47 D20 C 0005AJCC - BMW 5 (E60) 520 i 07.2003/03.2010 125KW 170CV 2171CC M54 B22 (226S1) 0005759 - BMW 5 (E60) 520 i 12.2006/03.2010 120KW 163...</p> <p>d46x91mm 1f-d14mm</p>		<p><b>UMV25127</b> NO. 25112229442 - 25117566267 - 25117833136 - 25118037305</p> <p><b>MANETE PUNHO TOPO ALAVANCA MUDANÇAS 5 VELOCIDADES F14MM</b></p> <p>BMW 5 (E60) 520 d (De 09.2005 Até 02.2007) 110kW 150cv 1995cm3 três volumes - BMW 5 (E60) 520 d (De 09.2005 Até 12.2009) 120kW 163cv 1995cm3 três volumes - BMW 5 (E60) 520 d (De 09.2007 Até 12.2009) 130kW 177cv 1995cm3 três volumes - BMW 5 (E60) 520 i (De 09.2007 Até 02.2010) 115kW 156cv 1995cm3 três volumes - BMW 5 (E60) 520 i (De 12.2006 Até 03.2010) 120kW 163cv 1995cm3 três volumes - BMW 5 (E60) 523 i 03.2007...</p> <p>d46x94mm 1f-d14mm</p>
	<p><b>UMV25128</b> NO. 25117550685</p> <p><b>MANETE PUNHO TOPO ALAVANCA MUDANÇAS 6 VELOCIDADES F14MM</b></p> <p>BMW 5 (E60) 520 d 09.2005/02.2007 110KW 150CV 1995CC M47 D20 (204D4) 0005ABQ 0005867 - BMW 5 (E60) 520 d 09.2005/12.2009 120KW 163CV 1995CC N47 D20 C M47 D20 (204D4) N47 D20 A 0005ABI 0005865 - BMW 5 (E60) 520 i 07.2003/03.2010 125KW 170CV 2171CC M54 B22 (226S1) 0005759 - BMW 5 (E60) 523 i 10.2004/02.2007 130KW 177CV 2497CC N52 B25 B N52 B25 BE N52 B25 A 0005834 0005ABC - BMW 5 (E60) 523 i 03.2007...</p> <p>96x46x55mm 1f-d14mm</p>		<p><b>UMV26815</b> NO. 25111434495 - 25111434719</p> <p><b>MANETE PUNHO TOPO ALAVANCA MUDANÇAS 5 VELOCIDADES F13MM</b></p> <p>BMW E60</p> <p>55x44x94mm 1f-d13mm</p>



	<p><b>UMV26816</b> NO. 25112229442 - 25117566267 - 25117833136 - 25118037305</p> <p>MANETE PUNHO TOPO ALAVANCA MUDANÇAS 6 VELOCIDADES F13MM BMW E60</p> <p>55x44x94mm 1f-d13mm</p>		<p><b>UMV26820</b> NO. 25111221290 - 25111222280 - 25111434494 - 25111434495</p> <p>MANETE PUNHO TOPO ALAVANCA MUDANÇAS 5 VELOCIDADES F14MM</p> <p>BMW 5 (E60) 520 d 09.2005/02.2007 110KW 150CV 1995CC M47 D20 (204D4) 0005ABQ 0005867 - BMW 5 (E60) 520 d 09.2005/12.2009 120KW 163CV 1995CC N47 D20 C M47 D20 (204D4) N47 D20 A 0005ABI 0005865 - BMW 5 (E60) 520 d 09.2007/12.2009 130KW 177CV 1995CC N47 D20 A N47 D20 C 0005AJCC - BMW 5 (E60) 520 i 07.2003/03.2010 125KW 170CV 2171CC M54 B22 (226S1) 0005759 - BMW 5 (E60) 520 i 12.2006/03.2010 120KW 163...</p> <p>d46x94mm 1f-d14mm</p>
	<p><b>UMV26822</b> NO. 25111434495 - 25117500299 - 25117503231 - 25117523817 - 25117544524</p> <p>MANETE PUNHO TOPO ALAVANCA MUDANÇAS 5 VELOCIDADES F15MM</p> <p>BMW 5 (E60) 520 d 09.2005/02.2007 110KW 150CV 1995CC M47 D20 (204D4) 0005ABQ 0005867 - BMW 5 (E60) 520 d 09.2005/12.2009 120KW 163CV 1995CC N47 D20 C M47 D20 (204D4) N47 D20 A 0005ABI 0005865 - BMW 5 (E60) 520 d 09.2007/12.2009 130KW 177CV 1995CC N47 D20 A N47 D20 C 0005AJCC - BMW 5 (E60) 520 i 07.2003/03.2010 125KW 170CV 2171CC M54 B22 (226S1) 0005759 - BMW 5 (E60) 520 i 12.2006/03.2010 120KW 163...</p> <p>d49x95mm 1f-d15mm</p>		<p><b>UTR0855</b> NO. 17137516004</p> <p>TAMPÃO RESERVATÓRIO LIQUIDO REFRIGERAÇÃO</p> <p>BMW 5 (E60) 520 i (04.06 A 12.09) 156cv 1995cc três volumes - BMW 5 (E60) 520 i (09.07 A 03.10) 170cv 1995cc três volumes - BMW 5 (E60) 520 i (07.03 A 03.10) 170cv 2171cc três volumes - BMW 5 (E60) 523 i (10.04 A 02.07) 177cv 2497cc três volumes - BMW 5 (E60) 523 i (01.07 A 03.10) 190cv 2497cc três volumes - BMW 5 (E60) 525 i (09.03 A 03.10) 192cv 2494cc três volumes - BMW 5 (E60) 525 ...</p> <p>d88x45mm 1f-d53x25mm</p>
	<p><b>W5099</b> NO. 11232247932 - 11237786611 - 11237786611 - 11237793593 - 11238511371</p> <p>POLIE DA CAMBOTA (4+6 PISTAS)</p> <p>BMW 5 (E60) 525 d 06.2004/03.2010 130KW 177CV 2497CC M57 D25 (256D2) 0005ABL, 0005796 - BMW 5 (E60) 525 d 12.2004/03.2010 120KW 163CV 2497CC M57 D25 (256D2) M57 D25 (256D1) 0005ABS, 0005797 - BMW 5 (E60) 525 d 01.2007/03.2010 145KW 197CV 2993CC M57 D30 (306D3) 0005AIC - BMW 5 (E60) 525 d xDrive 09.2007/12.2009 145KW 197CV 2993CC M57 D30 (306D3) 0005AJE - BMW 5 (E60) 525 xd 11.2006/08.2007 145KW 19...</p> <p>d191mm</p>		<p><b>W5099-C</b> NO. 11237788611 - 11237793593</p> <p>POLIE DA CAMBOTA (4+6 PISTAS)</p> <p>BMW 5 (E60) 525 d 06.2004/03.2010 130KW 177CV 2497CC M57 D25 (256D2) 0005ABL, 0005796 - BMW 5 (E60) 525 d 12.2004/03.2010 120KW 163CV 2497CC M57 D25 (256D2) M57 D25 (256D1) 0005ABS, 0005797 - BMW 5 (E60) 525 d 01.2007/03.2010 145KW 197CV 2993CC M57 D30 (306D3) 0005AIC - BMW 5 (E60) 525 d xDrive 09.2007/12.2009 145KW 197CV 2993CC M57 D30 (306D3) 0005AJE - BMW 5 (E60) 525 xd 11.2006/08.2007 145KW 19...</p> <p>d191mm</p>
	<p><b>W5109</b> NO. 11237797996 - 11237799153 - 11237823191 - 11238578993 - 11238858220 - 11238651643 - 1237797995</p> <p>POLIE DA CAMBOTA (6 PISTAS)</p> <p>BMW SÉRIE 5 (E60) 520D 163CV (07-2005 A 03-2010) - 520D 177CV (09-2007 A 03-2010)</p> <p>d190mm 4f-d10mm</p>		<p><b>W5169</b> NO. 11231439683 - 11237568345</p> <p>POLIE DA CAMBOTA (4 + 6 PISTAS)</p> <p>BMW 5 (E60) 545 i (De 09-2003 Até 03-2010) 245kW 333CV 4398cc três volumes BMW 5 (E60) 545 i (De 09-2003 Até 03-2010) 245kW 333CV 4398cc três volumes BMW 5 (E60) 540 i (De 07-2005 Até 03-2010) 225kW 306CV 4000cc três volumes BMW 5 (E60) 540 i (De 07-2005 Até 03-2010) 225kW 306CV 4000cc três volumes BMW 5 (E60) 550 i (De 07-2005 Até 03-2010) 270kW 367CV 4799cc três volumes BMW 5 (E60) 550 i (D...</p> <p>d174/152mm d37mm</p>
	<p><b>W5225</b> NO. 32417787106</p> <p>POLIE DA BOMBA HIDRÁULICA</p> <p>BMW 5 (E60) 525 d 06.2004/03.2010 130KW 177CV 2497CC M57 D25 (256D2) 0005ABL 0005796 - BMW 5 (E60) 525 d 12.2004/03.2010 120KW 163CV 2497CC M57 D25 (256D2) 0005ABS 0005797 - BMW 5 (E60) 525 d 01.2007/03.2010 145KW 197CV 2993CC M57 D30 (306D3) 0005AIC - BMW 5 (E60) 530 d 09.2005/03.2007 170KW 231CV 2993CC M57 D30 (306D3) 0005ABH 0005863 - BMW 5 (E60) 530 d 02.2007/12.2009 173KW 235CV 2993CC M57 D30...</p> <p>d143x28mm 1f-d30mm 3f-d8mm</p>		<p><b>Y3239</b> NO. 36130141574 - 36130141576 - 36131095390 - 36131116717 - 36131117190 - 36131126191</p> <p>PARAFUSO PERNO RODA CHAVE 17 M12X1,50X50MM (BASE CONICA)</p> <p>BMW 5 (E60) 520 d 09.2005/02.2007 110KW 150CV 1995CC M47 D20 (204D4) 0005ABQ 0005867 - BMW 5 (E60) 520 d 09.2005/12.2009 120KW 163CV 1995CC N47 D20 C M47 D20 (204D4) N47 D20 A 0005ABI 0005865 - BMW 5 (E60) 520 i 07.2003/03.2010 125KW 170CV 2171CC M54 B22 (226S1) 0005759 - BMW 5 (E60) 523 i 10.2004/02.2007 130KW 177CV 2497CC N52 B25 B N52 BE N52 B25 A 0005834 0005ABC - BMW 5 (E60) 525 d 06.2004...</p> <p>c51mm (ch-17mm) M12x1x24mm</p>
	<p><b>Z55278</b> NO. 51410407983 - 51418224781 - 51430141025</p> <p>MOLA PAINEL REVESTIMENTO PORTAS</p> <p>BMW 5 (E60) 520 d (09.2005 - 02.2007) 110kw 150cv 1995cm3 três volumes BMW 5 (E60) 520 d (09.2005 - 12.2009) 120kw 163cv 1995cm3 três volumes BMW 5 (E60) 520 i (12.2006 - 03.2010) 120kw 163cv 1995cm3 três volumes BMW 5 (E60) 520 i (07.2003 - 03.2010) 125kw 170cv 2171cm3 três volumes BMW 5 (E60) 523 i (10.2004 - 02.2007) 130kw 177cv 2497cm3 três volumes BMW 5 (E60) 525 d (12.2004 - 03.2010) 120kw 1...</p> <p>F-8T-18mm L-14H-21S1-7mm</p>		<p><b>Z80721</b> NO. 51318177850</p> <p>Mola de fixação</p> <p>BMW SÉRIE 5(E60)</p>
	<p><b>Z80768</b> NO. 51470146782 - 51470390017 - 51471911992</p> <p>Mola de fixação</p> <p>BMW SÉRIE 5(E60)</p> <p>d20x28mm 1p-d8-14mm</p>		<p><b>Z80799</b> NO. 1H0853585B - 51218205295</p> <p>Mola de fixação</p> <p>BMW SÉRIE 5(E60)</p> <p>d19.7x34.3mm 1p-d7.5-18.6mm</p>
	<p><b>Z80802</b> NO. 51231885969 - 51231889018 - 51411802258 - 51411807439 - 51411844033 - 51411852599 - 51411868613</p> <p>Mola de painel</p> <p>BMW SÉRIE 5(E60)</p> <p>d18x17,8mm 1p-d8-11.4mm</p>		<p><b>Z80843</b> NO. 51317064098</p> <p>MOLA DE FIXAÇÃO</p> <p>BMW SÉRIE 5(E60) (Após 2002)</p> <p>40x12x8.5mm</p>



	<p><b>D0035</b> NO. 26117522027</p> <p>CARDAN TRANSMISSÃO</p> <p>BMW 5 Touring (E61) 520 i (09.07 A 12.10) 170cv 1995cc Combi - BMW 5 Touring (E61) 523 i (07.05 A 12.10) 177cv 2497cc Combi - BMW 5 Touring (E61) 523 i (01.07 A 12.10) 190cv 2497cc Combi - BMW 5 Touring (E61) 525 i (06.04 A 12.10) 192cv 2494cc Combi - BMW 5 Touring (E61) 525 i (07.05 A 12.10) 218cv 2497cc Combi - BMW 5 Touring (E61) 525 i (01.07 A 12.10) 218cv 2996cc Combi - BMW 5 Tour...</p> <p>125x135x32mm 6f-d12mm</p>		<p><b>D0063</b> NO. 26117542238</p> <p>CARDAN DA TRANSMISSÃO</p> <p>BMW 5 Touring (E61) 545 i (De 06-2004 Até 12-2010) 245KW 333CV 4398cc Combi BMW 5 Touring (E61) 550 i (De 07-2005 Até 12-2010) 270kW 367CV 4799cc Combi BMW 5 Touring (E61) 525 d (De 03-2004 Até 03-2007) 120kW 163CV 2497cc Combi BMW 5 Touring (E61) 525 d (De 03-2004 Até 03-2007) 130kW 177CV 2497cc Combi BMW 5 Touring (E61) 525 d (De 03-2007 Até 05-2010) 145kW 197CV 2993cc Combi BMW 5 Touring (E61) ...</p> <p>163x155x42mm 6f-d12mm</p>
	<p><b>F1846-I</b> NO. 33211229594 - 33217527325 - 33217527326 - 33217529915 - 33217547080</p> <p>FOLE DA TRANSMISSÃO JUNTO À RODA</p> <p>BMW SÉRIE 5 (E61) 2.5i 525i - 3.0i 530i (APÓS 2003)</p> <p>d80x78mm 1f-d51mm 1f-d31mm</p>		<p><b>F1847-I</b> NO. 33211229590 - 33217527323 - 33217527324 - 33217529919</p> <p>FOLE DA TRANSMISSÃO JUNTO À RODA</p> <p>BMW SÉRIE 5 (E61) 2.2i 520i (APÓS 2003)</p> <p>d80x78mm 1f-d44mm 1f-d30mm</p>
	<p><b>F4207</b> NO. 25118036629 - 25118037309</p> <p>FOLE ALAVANCA VELOCIDADES C/ MANETE PUNHO TOPO COMPLETO 6 VELOCIDADES</p> <p>BMW E61</p> <p>172x153x212mm 135x145mm</p>		<p><b>KUBT3028</b> NO. 34211164186 - 34216765212</p> <p>KIT BORRACHAS TRAVAO PINÇA TRAS ATE/TEVES 42MM</p> <p>BMW 5 Touring (E61) 520 d 04.2005/05.2010 120KW 163CV 1995CC M47 D20 (204D4) N47 D20 C N47 D20 A 0005ABB 0005866 - BMW 5 Touring (E61) 520 d 09.2005/02.2007 110KW 150CV 1995CC M47 D20 (204D4) 0005ABU 0005868 - BMW 5 Touring (E61) 520 d 09.2007/05.2010 130KW 177CV 1995CC N47 D20 C N47 D20 A 0005AJD - BMW 5 Touring (E61) 520 i 07.2007/08.2010 120KW 163CV 1995CC N43 B20 A 0005AJB - BMW 5 Touring (E61)...</p> <p>d58x14mm d49x3mm d14x4mm d30mm 1f-d42mm 1f-d4mm</p>
	<p><b>KUBT3037</b> NO. 1f-d31mm 1f-d12/16mm 1f-d43mm 1f-d</p> <p>KIT BORRACHAS TRAVAO PINÇA TRAS ATE 42MM</p> <p>BMW 5 Touring (E61) 520 d 04.2005/05.2010 120KW 163CV 1995CC M47 D20 (204D4) N47 D20 C N47 D20 A 0005ABB 0005866 - BMW 5 Touring (E61) 520 d 09.2005/02.2007 110KW 150CV 1995CC M47 D20 (204D4) 0005ABU 0005868 - BMW 5 Touring (E61) 520 d 09.2007/05.2010 130KW 177CV 1995CC N47 D20 C N47 D20 A 0005AJD - BMW 5 Touring (E61) 520 i 07.2007/08.2010 120KW 163CV 1995CC N43 B20 A 0005AJB - BMW 5 Touring (E61)...</p> <p>d58x12mm d21x40mm(x2) 14x30mm 1f-d31mm 1f-d12/16mm 1f-d43mm 1f-d13</p>		<p><b>KUR21999</b> NO. 1f-d24mm 1f-d10mm 1f-d10mm 1f-d19mm</p> <p>KIT DE REPARAÇÃO ALAVANCA DE VELOCIDADES</p> <p>BMW 5 Touring (E61) 520 d (De 09.2005 Até 02.2007) 110kW 150cv 1995cm3 Combi - BMW 5 Touring (E61) 520 d (De 04.2005 Até 05.2010) 120kW 163cv 1995cm3 Combi - BMW 5 Touring (E61) 520 d (De 09.2007 Até 05.2010) 130kW 177cv 1995cm3 Combi - BMW 5 Touring (E61) 520 i (De 07.2007 Até 08.2010) 120kW 163cv 1995cm3 Combi - BMW 5 Touring (E61) 520 i (De 09.2007 Até 12.2010) 125kW 170cv 1995cm3 Combi - BMW 5...</p> <p>d37x18mm d19x25mm d7x22mm d31x21mm d31x21mm d12x19mm d19x15mm</p>
	<p><b>P1042</b> NO. 35211160422</p> <p>CAPA DE PEDAL</p> <p>BMW 5 Touring (E61) 520 d 04.2005/05.2010 120KW 163CV 1995CC M47 D20 (204D4) N47 D20 C N47 D20 A 0005ABB 0005866 - BMW 5 Touring (E61) 523 i 10.2004/02.2007 130KW 177CV 2497CC N52 B25 B N52 B25 BE N52 B25 A 0005838 0005AAW - BMW 5 Touring (E61) 525 d 03.2004/03.2007 130KW 177CV 2497CC M57 D25 (256D2) 0005ABM 0005792 - BMW 5 Touring (E61) 525 i 06.2004/12.2010 141KW 192CV 2494CC M54 B25 (256SS) 000...</p> <p>75x65x40mm</p>		<p><b>P1055</b> NO. 35211160421</p> <p>CAPA DE PEDAL DO TRAVÃO (VEÍCULOS COM CAIXA AUTOMÁTICA)</p> <p>BMW 5 Touring (E61) 520 d 04.2005/05.2010 120KW 163CV 1995CC M47 D20 (204D4) N47 D20 C N47 D20 A 0005ABB 0005866 - BMW 5 Touring (E61) 523 i 10.2004/02.2007 130KW 177CV 2497CC N52 B25 B N52 B25 BE N52 B25 A 0005838 0005AAW - BMW 5 Touring (E61) 525 d 03.2004/03.2007 130KW 177CV 2497CC M57 D25 (256D2) 0005ABM 0005792 - BMW 5 Touring (E61) 525 i 06.2004/12.2010 141KW 192CV 2494CC M54 B25 (256SS) 000...</p> <p>74x107x42mm</p>
	<p><b>P1059</b> NO. 1 108 634 - 35211108634</p> <p>CAPA DE PEDAL DO TRAVÃO</p> <p>BMW SÉRIE 5(E61) 525i - 530i - 530XD - 535D - 545i - (APÓS 06-2004)</p> <p>75x62x12mm</p>		<p><b>R222229</b> NO. 17127787448 - 7787448</p> <p>TUBO SUPERIOR DO RADIADOR LADO ESQUERDO COM BOCAL</p> <p>BMW 5 Touring (E61) 520 d 04.2005/05.2010 120KW 163CV 1995CC M47 D20 (204D4) N47 D20 C N47 D20 A 0005ABB 0005866 - BMW 5 Touring (E61) 520 d 09.2005/02.2007 110KW 150CV 1995CC M47 D20 (204D4) 0005ABU 0005868 - BMW 5 Touring (E61) 520 d 09.2007 - 05.2010 130KW 177CV 1995CC N47 D20 C N47 D20 A 0005AJD</p> <p>B560-39/39mm 122x145x78x200x63x81mm</p>
	<p><b>R222271</b> NO. 11617787468 - 11617794064</p> <p>TUBO ADMISSÃO FILTRO DE AR</p> <p>BMW 5 Touring (E61) 525 d 03.2004/03.2007 120KW 163CV 2497CC M57 D25 (256D2) 0005ABT 0005793 - BMW 5 Touring (E61) 525 d 03.2004/03.2007 130KW 177CV 2497CC M57 D25 (256D2) 0005ABM 0005792 - BMW 5 Touring (E61) 525 d 03.2007/05.2010 145KW 197CV 2993CC M57 D30 (306D3) 0005AII - BMW 5 Touring (E61) 525 d xDrive 09.2008/05.2010 145KW 197CV 2993CC M57 D30 (306D3) 0005AJF - BMW 5 Touring (E61) 525 xd 09...</p> <p>B245-55/62mm 50-140-80mm</p>		<p><b>R222272</b> NO. 11617790090 - 116177900901</p> <p>TUBO ADMISÃO FILTRO DE AR</p> <p>BMW 5 Touring (E61) 520 d 04.2005/05.2010 120KW 163CV 1995CC M47 D20 (204D4) N47 D20 C N47 D20 A 0005ABB 0005866</p> <p>B225-55/59mm B160-55/6160x76mm</p>
	<p><b>R222283</b> NO. 11617791664 - 11617797697 - 11617799401</p> <p>TUBO DO AR SOBREALIMENTAÇÃO</p> <p>BMW 5 Touring (E61) 525 d (De 03.2004 Até 03.2007) 130kW 177cv 2497cm3 Combi - BMW 5 Touring (E61) 525 d (De 03.2007 Até 05.2010) 145kW 197cv 2993cm3 Combi - BMW 5 Touring (E61) 525 d xDrive (De 09.2008 Até 05.2010) 145kW 197cv 2993cm3 Combi - BMW 5 Touring (E61) 525 xd (De 09.2007 Até 09.2008) 145kW 197cv 2993cm3 Combi - BMW 5 Touring (E61) 530 d (De 03.2004 Até 09.2005) 160kW 218cv 2993cm3 Comb...</p> <p>B194-53/62mm 112x85mm</p>		<p><b>R222287</b> NO. 1161779963 - 11617797707 - 11617799400</p> <p>TUBO DO AR SOBREALIMENTAÇÃO</p> <p>BMW 5 Touring (E61) 530 d (De 03.2004 Até 09.2005) 160kW 218cv 2993cm3 Combi - BMW 5 Touring (E61) 530 d (De 02.2005 Até 02.2007) 170kW 231cv 2993cm3 Combi - BMW 5 Touring (E61) 530 d (De 02.2007 Até 05.2010) 173kW 235cv 2993cm3 Combi - BMW 5 Touring (E61) 530 d xDrive (De 09.2007 Até 05.2010) 173kW 235cv 2993cm3 Combi - BMW 5 Touring (E61) 530 xd (De 02.2005 Até 02.2007) 170kW 231cv 2993cm3 Combi...</p> <p>B200-53/63mm 100x81mm</p>

	<p><b>R224946</b> NO. 11614727353 - 11617798438 - 11617808414</p> <p><b>TUBO DO AR SOBREALIMENTAÇÃO</b></p> <p>BMW 5 Touring (E61) 525 d (De 03.2004 Até 03.2007) 120kW 163cv 2497cm3 Combi - BMW 5 Touring (E61) 525 d (De 03.2004 Até 03.2007) 130kW 177cv 2497cm3 Combi - BMW 5 Touring (E61) 525 d (De 03.2007 Até 05.2010) 145kW 197cv 2993cm3 Combi - BMW 5 Touring (E61) 525 d xDrive (De 09.2008 Até 05.2010) 145kW 197cv 2993cm3 Combi - BMW 5 Touring (E61) 525 xd (De 09.2007 Até 09.2008) 145kW 197cv 2993cm3 Combi...</p> <p>B238-53/63mm 188x45mm</p>		<p><b>R225318</b> NO. 11617791664 - 11617796294 - 11617797697 - 11617799401</p> <p><b>TUBO DO AR SOBREALIMENTAÇÃO</b></p> <p>BMW 5 Touring (E61) 525 d (De 03.2004 Até 03.2007) 130kW 177cv 2497cm3 Combi - BMW 5 Touring (E61) 525 d (De 03.2007 Até 05.2010) 145kW 197cv 2993cm3 Combi - BMW 5 Touring (E61) 525 d xDrive (De 09.2008 Até 05.2010) 145kW 197cv 2993cm3 Combi - BMW 5 Touring (E61) 525 xd (De 09.2007 Até 09.2008) 145kW 197cv 2993cm3 Combi - BMW 5 Touring (E61) 530 d (De 03.2004 Até 09.2005) 160kW 218cv 2993cm3 Combi...</p> <p>B205-54/72mm B210-56/640x87mm 91x84x51mm</p>
	<p><b>R225322</b> NO. 11617789963 - 11617797707 - 11617799400</p> <p><b>TUBO DO AR SOBREALIMENTAÇÃO</b></p> <p>BMW 5 Touring (E61) 530 d (De 03.2004 Até 09.2005) 160kW 218cv 2993cm3 Combi - BMW 5 Touring (E61) 530 d (De 02.2005 Até 02.2007) 170kW 231cv 2993cm3 Combi - BMW 5 Touring (E61) 530 d (De 02.2007 Até 05.2010) 173kW 235cv 2993cm3 Combi - BMW 5 Touring (E61) 530 d xDrive (De 09.2007 Até 05.2010) 173kW 235cv 2993cm3 Combi - BMW 5 Touring (E61) 530 xd (De 02.2005 Até 02.2007) 170kW 231cv 2993cm3 Combi...</p> <p>B205-52/63mm B205-56/640x85mm 101x88x50mm</p>		<p><b>R225323</b> NO. 11617789963 - 11617797707 - 11617799400</p> <p><b>TUBO DO AR SOBREALIMENTAÇÃO</b></p> <p>BMW 5 Touring (E61) 530 d (De 03.2004 Até 09.2005) 160kW 218cv 2993cm3 Combi - BMW 5 Touring (E61) 530 d (De 02.2005 Até 02.2007) 170kW 231cv 2993cm3 Combi - BMW 5 Touring (E61) 530 d (De 02.2007 Até 05.2010) 173kW 235cv 2993cm3 Combi - BMW 5 Touring (E61) 530 d xDrive (De 09.2007 Até 05.2010) 173kW 235cv 2993cm3 Combi - BMW 5 Touring (E61) 530 xd (De 02.2005 Até 02.2007) 170kW 231cv 2993cm3 Combi...</p> <p>B220-57/63mm 104x72x53mm</p>
	<p><b>RT80281</b> NO. 34226760909 - 34326767390</p> <p><b>TUBO DE TRAVÃO FRENTE LH-RH</b></p> <p>BMW SÉRIE 5 TOURING (E61) 520 D (APÓS 09-2005) - SÉRIE 5 TOURING (E61) 525 D (APÓS 12-2004)</p> <p>F6 - MC55</p> <p>580mm</p>		<p><b>S1271</b> NO. 31106770689 - 31106770690 - 31121092019 - 31121094235 - 31121122462 - 31121124622 - 31121133236 -</p> <p><b>SILENT-BLOC DO BRAÇO DA SUSPENSÃO (FRENTE CENTRO)</b></p> <p>BMW 5 Touring (E61) 525 d xDrive 09.2008/05.2010 145KW 197CV 2993CC M57 D30 (306D3) 0005AJF - BMW 5 Touring (E61) 525 i xDrive 09.2008/12.2010 160KW 218CV 2996CC N53 B30 A 0005AIR - BMW 5 Touring (E61) 525 xd 09.2007/09.2008 145KW 197CV 2993CC M57 D30 (306D3) 0005AJF - BMW 5 Touring (E61) 525 xi 07.2005/12.2010 160KW 218CV 2497CC N52 B25 A 0005177 0005AHC - BMW 5 Touring (E61) 525 xi 01.2007/12.2010...</p> <p>d46x52mm c40mm 1f-d12mm</p>
	<p><b>T0624-I</b> NO. 31330146239 - 31331094749 - 31336764085</p> <p><b>BATENTE SUSPENSÃO FRENTE</b></p> <p>BMW 5 Touring (E61) 520 d 04.2005/05.2010 120KW 163CV 1995CC M47 D20 (204D4) N47 D20 C N47 D20 A 0005ABB 0005866 - BMW 5 Touring (E61) 520 d 09.2005/02.2007 110KW 150CV 1995CC M47 D20 (204D4) 0005ABU 0005868 - BMW 5 Touring (E61) 520 d 09.2007/05.2010 130KW 177CV 1995CC N47 D20 C N47 D20 A 0005AJD - BMW 5 Touring (E61) 520 i 09.2007/12.2010 125KW 170CV 1995CC N43 B20 A 0005AIZ - BMW 5 Touring (E61)...</p> <p>d58x87mm 1f-d27mm 1f-d23mm</p>		<p><b>U7033K</b> NO. 61671378609 - 64500149356 - 64500301636 - 64501363572 - 64501466019 - 64501468463 - 64508390601</p> <p><b>ORINGS BOMBA DIREÇÃO ASSITIDA</b></p> <p>BMW 5 Touring (E61) 520 d (09.2005 - 02.2007) 110kw 150cv 1995cm3 Combi BMW 5 Touring (E61) 520 d (04.2005 - 05.2010) 120kw 163cv 1995cm3 Combi BMW 5 Touring (E61) 520 d (09.2007 - 05.2010) 130kw 177cv 1995cm3 Combi BMW 5 Touring (E61) 523 i (10.2004 - 02.2007) 130kw 177cv 2497cm3 Combi BMW 5 Touring (E61) 523 i (03.2007 - 01.2010) 140kw 190cv 2497cm3 Combi BMW 5 Touring (E61) 525 d (03.2004 - 03...)</p> <p>d11x2mm d10x2mm 1f-d7mm 1f-d6mm</p>
	<p><b>UAP81292</b> NO. 13532247156 - 2247156</p> <p><b>ANILHA PROTEÇÃO TÉRMICA INJECTORES</b></p> <p>BMW 5 Touring (E61) 520 d (De 04-2005 Até 02-2008) 110kW 150CV 1995cc Combi BMW 5 Touring (E61) 520 d (De 03-2007 Até 05-2010) 130kW 177CV 1995cc Combi BMW 5 Touring (E61) 525 d (De 03-2007 Até 05-2010) 145kW 197CV 2993cc Combi</p> <p>d16x1mm 1f-d7mm</p>		<p><b>UAP81905</b> NO. 13532247156 - 2247156</p> <p><b>ANILHA PROTEÇÃO TÉRMICA INJECTORES</b></p> <p>BMW 5 Touring (E61) 520 d (De 04-2005 Até 02-2008) 110kW 150CV 1995cc Combi BMW 5 Touring (E61) 520 d (De 03-2007 Até 05-2010) 130kW 177CV 1995cc Combi BMW 5 Touring (E61) 525 d (De 03-2007 Até 05-2010) 145kW 197CV 2993cc Combi</p> <p>d14x1mm 1f-d7mm</p>
	<p><b>UFQ23302</b> NO. 21511223302</p> <p><b>FORQUILHA DA EMBRAIAGEM</b></p> <p>BMW 5 Touring (E61) 525 d 03.2004/03.2007 120KW 163CV 2497CC M57 D25 (256D2) 0005ABT 0005793 - BMW 5 Touring (E61) 525 d 03.2004/03.2007 130KW 177CV 2497CC M57 D25 (256D2) 0005ABM 0005792 - BMW 5 Touring (E61) 525 i 06.2004/12.2010 141KW 192CV 2494CC M54 B25 (256S5) 0005798 - BMW 5 Touring (E61) 530 d 03.2004/09.2005 160KW 218CV 2993CC M57 D30 (306D2) 0005794 - BMW 5 Touring (E61) 530 d 02.2005/02...</p> <p>252x83x28mm 1f-47x75mm</p>		<p><b>UMV25106</b> NO. 25117503100 - 25117566267</p> <p><b>MANETE PUNHO TOPO ALAVANCA MUDANÇAS 5 VELOCIDADES F14MM</b></p> <p>BMW 5 Touring (E61) 520 d 04.2005/05.2010 120KW 163CV 1995CC M47 D20 (204D4) N47 D20 C N47 D20 A 0005ABB 0005866 - BMW 5 Touring (E61) 520 d 09.2005/02.2007 110KW 150CV 1995CC M47 D20 (204D4) 0005ABU 0005868 - BMW 5 Touring (E61) 520 d 09.2007/05.2010 130KW 177CV 1995CC N47 D20 C N47 D20 A 0005AJD - BMW 5 Touring (E61) 520 i 07.2007/08.2010 120KW 163CV 1995CC N43 B20 A 0005AIB - BMW 5 Touring (E61)...</p> <p>95x45x55mm 1f-d14mm</p>
	<p><b>UMV25107</b> NO. 25117550685</p> <p><b>MANETE PUNHO TOPO ALAVANCA MUDANÇAS 6 VELOCIDADES F14MM</b></p> <p>BMW 5 Touring (E61) 520 d 04.2005/05.2010 120KW 163CV 1995CC M47 D20 (204D4) N47 D20 C N47 D20 A 0005ABB 0005866 - BMW 5 Touring (E61) 520 d 09.2005/02.2007 110KW 150CV 1995CC M47 D20 (204D4) 0005ABU 0005868 - BMW 5 Touring (E61) 523 i 10.2004/02.2010 130KW 177CV 2497CC N52 B25 B N52 B25 BE N52 B25 A 0005838 0005AAW - BMW 5 Touring (E61) 523 i 03.2007/01.2010 140KW 190CV 2497CC N52 B25 A 0005AIF - ...</p> <p>95x45x54mm 1f-d14mm</p>		<p><b>UMV25111</b> NO. 25111434495 - 25117500299 - 25117503231 - 25117523817 - 25117544524</p> <p><b>MANETE PUNHO TOPO ALAVANCA MUDANÇAS 6 VELOCIDADES F14MM</b></p> <p>BMW 5 Touring (E61) 520 d 04.2005/05.2010 120KW 163CV 1995CC M47 D20 (204D4) N47 D20 C N47 D20 A 0005ABB 0005866 - BMW 5 Touring (E61) 520 d 09.2005/02.2007 110KW 150CV 1995CC M47 D20 (204D4) 0005ABU 0005868 - BMW 5 Touring (E61) 520 d 09.2007/05.2010 130KW 177CV 1995CC N47 D20 C N47 D20 A 0005AJD - BMW 5 Touring (E61) 520 i 07.2007/08.2010 120KW 163CV 1995CC N43 B20 A 0005AIB - BMW 5 Touring (E61)...</p> <p>d46x91mm 1f-d14mm</p>
	<p><b>UMV25127</b> NO. 25112229442 - 25117566267 - 25117833136 - 25118037305</p> <p><b>MANETE PUNHO TOPO ALAVANCA MUDANÇAS 5 VELOCIDADES F14MM</b></p> <p>BMW 5 Touring (E61) 520 d (De 09.2005 Até 02.2007) 110kW 150cv 1995cm3 Combi - BMW 5 Touring (E61) 520 d (De 04.2005 Até 05.2010) 120kW 163cv 1995cm3 Combi - BMW 5 Touring (E61) 520 d (De 09.2007 Até 05.2010) 130kW 177cv 1995cm3 Combi - BMW 5 Touring (E61) 520 i (De 07.2007 Até 08.2010) 120kW 163cv 1995cm3 Combi - BMW 5 Touring (E61) 520 i (De 09.2007 Até 12.2010) 125kW 170cv 1995cm3 Combi - BMW 5...</p> <p>d46x94mm 1f-d14mm</p>		<p><b>UMV25128</b> NO. 25117550685</p> <p><b>MANETE PUNHO TOPO ALAVANCA MUDANÇAS 6 VELOCIDADES F14MM</b></p> <p>BMW 5 Touring (E61) 520 d 04.2005/05.2010 120KW 163CV 1995CC M47 D20 (204D4) N47 D20 C N47 D20 A 0005ABB 0005866 - BMW 5 Touring (E61) 520 d 09.2005/02.2007 110KW 150CV 1995CC M47 D20 (204D4) 0005ABU 0005868 - BMW 5 Touring (E61) 523 i 10.2004/02.2010 130KW 177CV 2497CC N52 B25 B N52 B25 BE N52 B25 A 0005838 0005AAW - BMW 5 Touring (E61) 523 i 03.2007/01.2010 140KW 190CV 2497CC N52 B25 A 0005AIF - ...</p> <p>96x46x55mm 1f-d14mm</p>



## BMW SERIE 5(E61)

	<b>UMV26820</b> NO. 25111221290 - 25111222280 - 25111434494 - 25111434495 <b>MANETE PUNHO TOPO ALAVANCA MUDANÇAS 5 VELOCIDADES F14MM</b> BMW 5 Touring (E61) 520 d 04.2005/05.2010 120KW 163CV 1995CC M47 D20 (204D4) N47 D20 C N47 D20 A 0005ABB 0005866 - BMW 5 Touring (E61) 520 d 09.2005/02.2007 110KW 150CV 1995CC M47 D20 (204D4) 0005ABU 0005868 - BMW 5 Touring (E61) 520 d 09.2007/05.2010 130KW 177CV 1995CC N47 D20 C N47 D20 A 0005AJD - BMW 5 Touring (E61) 520 i 07.2007/08.2010 120KW 163CV 1995CC N43 B20 A 0005AJB - BMW 5 Touring (E61)...		<b>UMV26822</b> NO. 25111434495 - 25117500299 - 25117503231 - 25117523817 - 25117544524 <b>MANETE PUNHO TOPO ALAVANCA MUDANÇAS 5 VELOCIDADES F15MM</b> BMW 5 Touring (E61) 520 d 04.2005/05.2010 120KW 163CV 1995CC M47 D20 (204D4) N47 D20 C N47 D20 A 0005ABB 0005866 - BMW 5 Touring (E61) 520 d 09.2005/02.2007 110KW 150CV 1995CC M47 D20 (204D4) 0005ABU 0005868 - BMW 5 Touring (E61) 520 d 09.2007/05.2010 130KW 177CV 1995CC N47 D20 C N47 D20 A 0005AJD - BMW 5 Touring (E61) 520 i 07.2007/08.2010 120KW 163CV 1995CC N43 B20 A 0005AJB - BMW 5 Touring (E61)...
	<b>W5099</b> NO. 11232247932 - 11237786611 - 11237786611 - 11237793593 - 11238511371 <b>POLIE DA CAMBOTA (4+6 PISTAS)</b> BMW 5 Touring (E61) 525 d 03.2004/03.2007 120KW 163CV 2497CC M57 D25 (256D2) 0005ABT, 0005793 - BMW 5 Touring (E61) 525 d 03.2004/03.2007 130KW 177CV 2497CC M57 D25 (256D2) 0005ABM, 0005792 - BMW 5 Touring (E61) 525 d 03.2007/05.2010 145KW 197CV 2993CC M57 D30 (306D3) 0005AII - BMW 5 Touring (E61) 525 d xDrive 09.2008/05.2010 145KW 197CV 2993CC M57 D30 (306D3) 0005AJF - BMW 5 Touring (E61) 525 xd ...		<b>W5099-C</b> NO. 11237786611 - 11237793593 <b>POLIE DA CAMBOTA (4+6 PISTAS)</b> BMW 5 Touring (E61) 525 d 03.2004/03.2007 120KW 163CV 2497CC M57 D25 (256D2) 0005ABT, 0005793 - BMW 5 Touring (E61) 525 d 03.2004/03.2007 130KW 177CV 2497CC M57 D25 (256D2) 0005ABM, 0005792 - BMW 5 Touring (E61) 525 d 03.2007/05.2010 145KW 197CV 2993CC M57 D30 (306D3) 0005AII - BMW 5 Touring (E61) 525 d xDrive 09.2008/05.2010 145KW 197CV 2993CC M57 D30 (306D3) 0005AJF - BMW 5 Touring (E61) 525 xd ...
	<b>W5109</b> NO. 11237797995 - 11237797996 - 11237799153 - 11237823191 - 11238578993 - 11238585220 - 11238651643 <b>POLIE DA CAMBOTA (6 PISTAS)</b> BMW SÉRIE 5 Touring (E61) 520D 163CV (APÓS 07-2005) - 520D 177CV (APÓS 09-2007)		<b>W5169</b> NO. 11231439683 - 11237568345 <b>POLIE DA CAMBOTA (4 + 6 PISTAS)</b> BMW 5 Touring (E61) 545 i (De 06-2004 Até 12-2010) 245KW 333CV 4398cc Combi BMW 5 Touring (E61) 545 i (De 06-2004 Até 12-2010) 245KW 333CV 4398cc Combi BMW 5 Touring (E61) 550 i (De 07-2005 Até 12-2010) 270KW 367CV 4799cc Combi BMW 5 Touring (E61) 550 i (De 07-2005 Até 12-2010) 270KW 367CV 4799cc Combi
	<b>W5225</b> NO. 32417787106 <b>POLIE DA BOMBA HIDRÁULICA</b> BMW 5 Touring (E61) 525 d 03.2004/03.2007 120KW 163CV 2497CC M57 D25 (256D2) 0005ABT 0005793 - BMW 5 Touring (E61) 525 d 03.2007/05.2010 145KW 197CV 2993CC M57 D30 (306D3) 0005AII - BMW 5 Touring (E61) 525 xd 09.2007/09.2008 145KW 197CV 2993CC M57 D30 (306D3) 0005AJF - BMW 5 Touring (E61) 530 d 03.2004/09.2005 160KW 218CV 2993CC M57 D30 (306D2) 0005794 - BMW 5 Touring (E61) 530 d 02.2005/02.2007 1...		<b>Y3239</b> NO. 36130141574 - 36130141576 - 36131095390 - 36131116717 - 36131117190 - 36131126191 <b>PARAFUSO PERNO RODA CHAVE 17 M12X1,50X50MM ( BASE CONICA )</b> BMW 5 Touring (E61) 520 d 04.2005/05.2010 120KW 163CV 1995CC M47 D20 (204D4) N47 D20 C N47 D20 A 0005ABB 0005866 - BMW 5 Touring (E61) 520 d 09.2005/02.2007 110KW 150CV 1995CC M47 D20 (204D4) 0005ABU 0005868 - BMW 5 Touring (E61) 523 i 10.2004/02.2007 130KW 177CV 2497CC N52 B25 B N52 B25 BE N52 B25 A 0005838 0005AAW - BMW 5 Touring (E61) 525 d 03.2004/03.2007 130KW 177CV 2497CC M57 D25 (256D2) 000...
	<b>Z55278</b> NO. 51410407983 - 51418224781 - 51430141025 <b>MOLA PAINEL RESVESTIMENTO PORTAS</b> BMW 5 Touring (E61) 520 d (09.2005 - 02.2007) 110 150 1995 Combi BMW 5 Touring (E61) 520 d (04.2005 - 05.2010) 120 163 1995 Combi BMW 5 Touring (E61) 523 i (10.2004 - 02.2007) 130 177 2497 Combi BMW 5 Touring (E61) 525 d (03.2004 - 03.2007) 120 163 2497 Combi BMW 5 Touring (E61) 525 d (03.2004 - 03.2007) 130 177 2497 Combi BMW 5 Touring (E61) 525 i (06.2004 - 12.2010) 141 192 2494 Combi BMW 5 Tour...		<b>Z80843</b> NO. 51317064098 <b>MOLA DE FIXAÇÃO</b> BMW SÉRIE 5(E61) (Após 2002)
	F-8T-18mm L-14H-21S1-7mm		40x12x8.5mm

## BMW SERIE 5 (F07)

	<b>R224951</b> NO. 11617810614 <b>TUBO DO AR SOBREALIMENTAÇÃO</b> BMW 5 Gran Turismo (F07) 520 d (De 2012.07 Até 2013.06) 120kW 163cv 1995cm3 Hatchback - BMW 5 Gran Turismo (F07) 520 d (De 2011.04 Até 2017.02) 135kW 184cv 1995cm3 Hatchback -		<b>S1824</b> NO. 33324062629 - 33324062630 - 33326780069 - 33326780070 - 33326784351 - 33326784352 - 33326794877 - 33326794878 <b>SILENT-BLOC DO BRÇO SUSPENSÃO INFERIOR TRÁS</b> BMW 5 Gran Turismo (F07) 520 d 04.2011/02.2017 135KW 184CV 1995CC N47 D20 C 0005BAB 0005BJQ 0005BJR - BMW 5 Gran Turismo (F07) 520 d 07.2012/06.2013 120KW 163CV 1995CC N47 D20 C 0005BJT 0005BJS - BMW 5 Gran Turismo (F07) 530 d 08.2009/06.2012 180KW 245CV 2993CC N57 D30 A 0005ASK 0005API 0005BAD - BMW 5 Gran Turismo (F07) 530 d 09.2010/02.2017 155KW 211CV 2993CC N57 D30 A 0005BNB 0005BBB 0005BBC - ...
	B367-50/58mm 150x63x135mm		d73x70mm d59mm c50mm 1f-d14mm
	<b>UAP81292</b> NO. 13532247156 - 2247156 <b>ANILHA PROTEÇÃO TÉRMICA INJECTORES</b> BMW 5 Gran Turismo (F07) 520 d (De 04-2011 Até 02-2017) 135kW 184CV 1995cc Hatchback BMW 5 Gran Turismo (F07) 530 d (De 09-2010 Até 06-2012) 155kW 211CV 2993cc Hatchback BMW 5 Gran Turismo (F07) 530 d (De 08-2009 Até 06-2012) 180kW 245CV 2993cc Hatchback BMW 5 Gran Turismo (F07) 530 d xDrive (De 06-2010 Até 06-2012) 180kW 245CV 2993cc Hatchback BMW 5 Gran Turismo (F07) 530 d (De 07-2012 Até 02-2017)...		<b>UAP81905</b> NO. 13532247156 - 2247156 <b>ANILHA PROTEÇÃO TÉRMICA INJECTORES</b> BMW 5 Gran Turismo (F07) 520 d (De 04-2011 Até 02-2017) 135kW 184CV 1995cc Hatchback BMW 5 Gran Turismo (F07) 530 d (De 09-2010 Até 06-2012) 155kW 211CV 2993cc Hatchback BMW 5 Gran Turismo (F07) 530 d (De 08-2009 Até 06-2012) 180kW 245CV 2993cc Hatchback BMW 5 Gran Turismo (F07) 530 d xDrive (De 06-2010 Até 06-2012) 180kW 245CV 2993cc Hatchback BMW 5 Gran Turismo (F07) 530 d (De 07-2012 Até 02-2017)...
	d16x1mm 1f-d7mm		d14x1mm 1f-d7mm



	<p><b>UCRZ1097</b> NO. 26207556020 - 26207593164 - 26207597649 - 26207620521 - 26207629988 - 26208605866 - 26208628043</p> <p><b>CRUZETA TRANSMISSAO VEIO LONGITUDINAL D24X56MM</b></p> <p>BMW 5 Gran Turismo (F07) 530 d xDrive 06.2010/06.2012 180KW 245CV 2993CC N57 D30 A 0005AZA 0005BAS - BMW 5 Gran Turismo (F07) 530 d xDrive 07.2012/02.2017 190KW 258CV 2993CC N57 D30 A 0005BEN 0005BKA 0005BKB - BMW 5 Gran Turismo (F07) 535 d xDrive 03.2010/06.2012 220KW 299CV 2993CC N57 D30 B 0005AZB 0005BCY - BMW 5 Gran Turismo (F07) 535 d xDrive 07.2012/02.2017 230KW 313CV 2993CC N57 D30 B 0005BK...</p> <p>d24mm</p>		<p><b>UTR0848</b> NO. 17117521071</p> <p><b>TAMPÃO RESERVATÓRIO LÍQUIDO REFRIGERAÇÃO</b></p> <p>BMW 5 Gran Turismo ( F 07 ) 530 d (A Partir de 03.10) 211cv 2993cc Hatchback - BMW 5 Gran Turismo ( F 0 7 ) 530 d (01.09 A 06.12) 245cv 2993cc Hatchback - BMW 5 Gran Turismo ( F 07 ) 530 d (A Partir de 10.11) 258cv 2993cc Hatchback - BMW 5 Gran Turismo ( F 07 ) 535 d (05.09 A 06.12) 299cv 2993cc Hatchback - BMW 5 Gran Turismo ( F 07 ) 535 d (A Partir de 01.12) 313cv 2993cc Hatchback - BM...</p> <p>d88x45mm 1f-d53x25mm</p>
	<p><b>W5140</b> NO. 11237797996 - 11237800026 - 11238578993 - 11238585220 - 11238651643</p> <p><b>POLIE DA CAMBOTA 7 PISTAS</b></p> <p>BMW SÉRIE 5 Gran Turismo (F07) 530 d (03.10 A 06.12) 211cv 2993cc Hatchback - BMW 5 Gran Turismo (F07) 530 d (01.09 A 06.12) 245cv 2993cc Hatchback - BMW 5 Gran Turismo (F07) 530 d xDrive (01.10 A 06.12) 245cv 2993cc Hatchback - BMW 5 Gran Turismo (F07) 530 d (APÓS 04.11) 258cv 2993cc Hatchback - BMW 5 Gran Turismo (F07) 530 d xDrive (APÓS 05.11) 258cv 2993cc Hatchback - BMW 5 Gran Turismo (F...</p> <p>d190mm d10mm</p>		<p><b>W5142</b> NO. 11238512072 - 11238578993 - 11238585220 - 11238651643</p> <p><b>POLIE DA CAMBOTA 6 PISTAS</b></p> <p>BMW SÉRIE 5 Gran Turismo (F07) 520 d (APÓS 10.11) 184cv 1995cc Hatchback</p> <p>d185mm d10mm</p>
	<p><b>W5208</b> NO. 11237797996 - 11238511321 - 11238518985 - 11238578993 - 11238585220 - 11238586724 - 11238651643</p> <p><b>POLIE DA CAMBOTA (6 pistas)</b></p> <p>BMW 5 Gran Turismo (F07): 530 d xDrive 06.2010/06.2012 180KW 245CV 2993CC - BMW 5 Gran Turismo (F07): 530 d 07.2012/02.2017 190KW 258CV 2993CC - BMW 5 Gran Turismo (F07): 530 d xDrive 07.2012/02.2017 190KW 258CV 2993CC</p> <p>d196mm d40/60mm 4f-d10mm</p>		<p><b>W5209</b> NO. 11237797996 - 11237800385 - 11238578993 - 11238585220 - 11238586724 - 11238651643</p> <p><b>POLIE DA CAMBOTA (6 PISTAS)</b></p> <p>BMW 5 Gran Turismo (F07): 530 d 08.2009/06.2012 180KW 245CV 2993CC</p> <p>d196mm d40/60mm 4f-d10mm</p>
	<p><b>Z55186</b> NO. 07147145753</p> <p><b>MOLA DE PAINEL</b></p> <p>BMW 5 Gran Turismo (F07) 520 d (07.2012 - 06.2013) 120kw 163cv 1995cm3 Hatchback BMW 5 Gran Turismo (F07) 520 d (04.2011 - 02.2017) 135kw 184cv 1995cm3 Hatchback BMW 5 Gran Turismo (F07) 530 d (09.2010 - 02.2017) 155kw 211cv 2993cm3 Hatchback BMW 5 Gran Turismo (F07) 530 d (08.2009 - 06.2012) 180kw 245cv 2993cm3 Hatchback BMW 5 Gran Turismo (F07) 530 d (07.2012 - 02.2017) 190kw 258cv 2993cm3 Hatch...</p> <p>d8x 18mm f-d18mm</p>		<p><b>Z55278</b> NO. 51410407983 - 51418224781 - 51430141025</p> <p><b>MOLA PAINEL RESVESTIMENTO PORTAS</b></p> <p>BMW 5 Gran Turismo (F07) 520 d (04.2011 - 02.2017) 135kw 184cv 1995cm3 Hatchback BMW 5 Gran Turismo (F07) 530 d (09.2010 - 02.2017) 155kw 211cv 2993cm3 Hatchback BMW 5 Gran Turismo (F07) 530 d (07.2012 - 02.2017) 190kw 258cv 2993cm3 Hatchback BMW 5 Gran Turismo (F07) 530 d xDrive (07.2012 - 02.2017) 190kw 258cv 2993cm3 Hatchback BMW 5 Gran Turismo (F07) 535 d (07.2012 - 02.2017) 230kw 313cv 2993cm3...</p> <p>F-8T-18mm L-14H-21S1-7mm</p>

BMW SERIE 5 (F10)

	<p><b>D0022</b> NO. 26111209168 - 26111227420 - 26111227717 - 26111229080 - 26111229360 - 26117511454</p> <p><b>CARDAN TRANSMISSÃO D135X30MM 6 FUROS 12MM ENTRE FUROS 96MM</b></p> <p>BMW SERIE 5 (F10)</p> <p>d132x123x30mm 6f-d12mm</p>		<p><b>KUR21999</b> NO. 1f-d24mm 1f-d10mm 1f-d10mm 1f-d19mm</p> <p><b>KIT DE REPARAÇÃO ALAVANCA DE VELOCIDADES</b></p> <p>BMW 5 (F10) 518 d (De 07.2013 Até 06.2014) 100kW 136cv 1995cm3 três volumes - BMW 5 (F10) 518 d (De 07.2013 Até 06.2014) 105kW 143cv 1995cm3 três volumes - BMW 5 (F10) 518 d (De 07.2014 Até 10.2016) 110kW 150cv 1995cm3 três volumes - BMW 5 (F10) 520 d (De 06.2010 Até 10.2016) 120kW 163cv 1995cm3 três volumes - BMW 5 (F10) 520 d (De 06.2010 Até 06.2014) 135kW 184cv 1995cm3 três volumes - BMW 5 (F10)...</p> <p>d37x18mm d19x25mm d17x22mm d31x20mm d31x20mm d12x19mm d11x15mm</p>
	<p><b>P1042</b> NO. 35211160422</p> <p><b>CAPA DE PEDAL</b></p> <p>BMW 5 (F10) 520 i 09.2011/10.2016 135KW 184CV 1997CC N20 B20 A N20 B20 B 0005BFL 0005BFN - BMW 5 (F10) 528 i 09.2011/10.2016 180KW 245CV 1997CC N20 B20 A 0005BFO - BMW 5 (F10) 535 i 01.2010/10.2016 225KW 306CV 2979CC N55 B30 A 0005ATC 0005BFK - BMW 5 (F10) 550 i 03.2010/06.2013 300KW 408CV 4395CC N63 B44 A 0005ATD - BMW 5 (F10) M5 09.2011/10.2016 412KW 560CV 4395CC S63 B44 B 7909AAY</p> <p>75x65x40mm</p>		<p><b>P1042</b> NO. 35211160422</p> <p><b>CAPA DE PEDAL</b></p> <p>BMW SERIE 5(F10)</p> <p>75x65x40mm</p>
	<p><b>R224951</b> NO. 11617810614</p> <p><b>TUBO DO AR SOBREALIMENTAÇÃO</b></p> <p>BMW 5 (F10) 518 d (De 2013.07 Até 2014.06) 105kW 143cv 1995cm3 três volumes - BMW 5 (F10) 518 d (De 2014.07 Até 2016.10) 110kW 150cv 1995cm3 três volumes - BMW 5 (F10) 520 d (De 2010.06 Até 2016.10) 120kW 163cv 1995cm3 três volumes - BMW 5 (F10) 520 d (De 2010.06 Até 2014.06) 135kW 184cv 1995cm3 três volumes - BMW 5 (F10) 520 d xDrive (De 2013.07 Até 2014.06) 135kW 184cv ...</p> <p>d73x70mm d59mm c50mm 1f-d14mm</p>		<p><b>S1824</b> NO. 33324062629 - 33324062630 - 33326780069 - 33326780070 - 33326784351 - 33326784352 - 33326794877 - 33326794878</p> <p><b>SILENT-BLOC DO BRAÇO SUSPENSÃO INFERIOR TRÁS</b></p> <p>BMW 5 (F10) 518 d 07.2013/10.2016 100KW 136CV 1995CC N47 D20 C B47 D20 A 0005BQC - BMW 5 (F10) 518 d 07.2013/06.2014 105KW 143CV 1995CC N47 D20 C 0005BQD - BMW 5 (F10) 518 d 07.2014/10.2016 110KW 150CV 1995CC B47 D20 A 0005BWU - BMW 5 (F10) 520 d 06.2010/10.2016 120KW 163CV 1995CC B47 D20 A N47 D20 C 0005ATH - BMW 5 (F10) 520 d 06.2010/06.2014 135KW 184CV 1995CC N47 D20 C 0005ATE - BMW 5 (F10) 5...</p> <p>d73x70mm d59mm c50mm 1f-d14mm</p>

	<p><b>T0723-I</b> NO. 33536789386</p> <p><b>BATENTE SUSPENSÃO DE TRÁS AMBOS OS LADOS</b></p> <p>BMW 5 (F10) 520 i (De 2011.09 Até 2016.10) 120kW 163cv 1997cm3 três volumes -  BMW 5 (F10) 520 i (De 2011.09 Até 2016.10) 135kW 184cv 1997cm3 três volumes -  BMW 5 (F10) 523 i (De 2009.06 Até 2011.08) 150kW 204cv 2996cm3 três volumes -  BMW 5 (F10) 528 i (De 2011.09 Até 2016.10) 180kW 245cv 1997cm3 três volumes -  BMW 5 (F10) 528 i (De 2010.10 Até 2011.08) 190kW 258cv 2996cm3...</p>		<p><b>U7033K</b> NO. 61671378609 - 64500149356 - 64500301636 - 64501363572 - 64501466019 - 64501468463 - 64508390601</p> <p><b>ORINGS BOMBA DIREÇÃO ASSISTIDA</b></p> <p>BMW 5 (F10) M5 (09.2011 - 10.2016) 412kw 560cv 4395cm3 três volumes BMW 5 (F10) M5 30th Anniversary (07.2014 - 10.2016) 441kw 600cv 4395cm3 três volumes BMW 5 (F10) M5 Competition (02.2013 - 10.2016) 423kw 575cv 4395cm3 três volumes</p>
	<p><b>UAP81292</b> NO. 13532247156 - 2247156</p> <p><b>ANILHA PROTEÇÃO TÉRMICA INJECTORES</b></p> <p>BMW 5 (F10) 518 d (De 02-2013 Até 06-2014) 105kW 143CV 1995cc três volumes BMW 5 (F10) 518 d (De 10-2013 Até 10-2016) 110kW 150CV 1995cc três volumes BMW 5 (F10) 520 d (De 03-2010 Até 06-2014) 135kW 184CV 1995cc três volumes BMW 5 (F10) 520 d xDrive (De 01-2013 Até 06-2014) 135kW 184CV 1995cc três volumes BMW 5 (F10) 520 d (De 10-2013 Até 10-2016) 140kW 190CV 1995cc três volumes BMW 5 (F10) 5...</p>		<p><b>UAP81905</b> NO. 13532247156 - 2247156</p> <p><b>ANILHA PROTEÇÃO TÉRMICA INJECTORES</b></p> <p>BMW 5 (F10) 518 d (De 02-2013 Até 06-2014) 105kW 143CV 1995cc três volumes BMW 5 (F10) 518 d (De 10-2013 Até 10-2016) 110kW 150CV 1995cc três volumes BMW 5 (F10) 520 d (De 03-2010 Até 06-2014) 135kW 184CV 1995cc três volumes BMW 5 (F10) 520 d xDrive (De 01-2013 Até 06-2014) 135kW 184CV 1995cc três volumes BMW 5 (F10) 520 d (De 10-2013 Até 10-2016) 140kW 190CV 1995cc três volumes BMW 5 (F10) 5...</p>
	<p><b>UCRZ1097</b> NO. 26207556020 - 26207593164 - 26207597649 - 26207620521 - 26207629988 - 26208605866 - 26208628043</p> <p><b>CRUZETA TRANSMISSAO VEIO LONGITUDINAL D24X56MM</b></p> <p>BMW 5 (F10) 520 d xDrive 01.2013/06.2014 147KW 200CV 1995CC N47 D20 C 0005BQF - BMW 5 (F10) 520 d xDrive 07.2013/06.2014 135KW 184CV 1995CC N47 D20 C 0005BQG - BMW 5 (F10) 525 d xDrive 09.2011/10.2016 155KW 211CV 1995CC N47 D20 D 0005BFU - BMW 5 (F10) 525 d xDrive 09.2011/10.2016 160KW 218CV 1995CC N47 D20 D 0005BFV - BMW 5 (F10) 528 i xDrive 09.2011/10.2016 180KW 245CV 1997CC N20 B20 A 0005BFT - ...</p>		<p><b>W5140</b> NO. 11237797996 - 11237800026 - 11238578993 - 11238585220 - 11238651643</p> <p><b>POLIE DA CAMBOTA 7 PISTAS</b></p> <p>BMW SÉRIE 5 (F10) 525 d (APÓS 02.10) 204cv 2993cc três volumes - BMW 5 (F10) 530 d (APÓS 12.09) 245cv 2993cc três volumes - BMW 5 (F10) 530 d (APÓS 09.11) 258cv 2993cc três volumes BMW 5 (F10) 535 d (APÓS 08.10) 299cv 2993cc três volumes - BMW 5 (F10) 535 d (APÓS 09.11) 313cv 2993cc três volumes</p>
	<p><b>W5141</b> NO. 11237797996 - 11238513539 - 11238578993 - 11238585220 - 11238651643</p> <p><b>POLIE DA CAMBOTA 7 PISTAS</b></p> <p>BMW SÉRIE 5 (F10) 525 d (APÓS 09.11) 211cv 1995cc três volumes - BMW 5 (F10) 525 d xDrive (APÓS 09.11) 211cv 1995cc três volumes</p>		<p><b>W5141</b> NO. 11237797996 - 11238513539 - 11238578993 - 11238585220 - 11238651643</p> <p><b>POLIE DA CAMBOTA 7 PISTAS</b></p> <p>BMW SÉRIE 5 Touring (F11) 525 d (APÓS 09.11) 218cv 1995cc Combi - BMW 5 Touring (F11) 525 d xDrive (APÓS 09.11) 218cv 1995cc Combi</p>
	<p><b>W5142</b> NO. 11238512072 - 11238578993 - 11238585220 - 11238651643</p> <p><b>POLIE DA CAMBOTA 6 PISTAS</b></p> <p>BMW SÉRIE 5 (F10) 520 d xDrive (01.13 A 06.14) 184cv 1995cc três volumes - BMW 5 (F10) 525 d (APÓS 09.11) 211cv 1995cc três volumes</p>		<p><b>W5186</b> NO. 11238515002</p> <p><b>POLIE DA CAMBOTA (6 PISTAS)</b></p> <p>BMW 5 Gran Turismo (F07): 530 d 07.2012/02.2017 190KW 258CV 2993CC - BMW 5 Gran Turismo (F07): 530 d xDrive 07.2012/02.2017 190KW 258CV 2993CC - BMW 5 Gran Turismo (F07): 535 d 07.2012/02.2017 230KW 313CV 2993CC - BMW 5 Gran Turismo (F07): 535 d xDrive 07.2012/02.2017 230KW 313CV 2993CC - BMW 5 (F10): 535 d 09.2011/10.2016 220KW 299CV 2993CC - BMW 5 (F10): 535 d 09.2011/10.2016 230KW 313CV 2993CC ...</p>
	<p><b>W5192</b> NO. 11238602800</p> <p><b>POLIE DA CAMBOTA (6 PISTAS)</b></p> <p>BMW 5 (F10): 518 d 07.2013/06.2014 105KW 143CV 1995CC - BMW 5 (F10): 518 d 07.2014/10.2016 110KW 150CV 1995CC - BMW 5 (F10): 520 d 06.2010/06.2014 135KW 184CV 1995CC - BMW 5 (F10): 520 d xDrive 07.2013/06.2014 135KW 184CV 1995CC - BMW 5 (F10): 520 d 07.2014/10.2016 140KW 190CV 1995CC - BMW 5 (F10): 520 d xDrive 07.2014/10.2016 140KW 190CV 1995CC - BMW 5 (F10): 520 d 06.2010/06.2014 147KW 200CV 199...</p>		<p><b>W5208</b> NO. 11237797996 - 11238511321 - 11238518985 - 11238578993 - 11238585220 - 11238586724 - 11238651643</p> <p><b>POLIE DA CAMBOTA (6 pistas)</b></p> <p>BMW 5 (F10): 530 d 09.2011/10.2016 190KW 258CV 2993CC - BMW 5 (F10): 530 d xDrive 03.2011/10.2016 190KW 258CV 2993CC - BMW 5 (F10): 530 d 09.2010/10.2016 210KW 286CV 2993CC - BMW 5 (F10): 530 d xDrive 03.2011/10.2016 210KW 286CV 2993CC</p>
	<p><b>W5209</b> NO. 11237797996 - 11237800385 - 11238578993 - 11238585220 - 11238586724 - 11238651643</p> <p><b>POLIE DA CAMBOTA (6 PISTAS)</b></p> <p>BMW 5 (F10): 525 d 03.2010/08.2011 150KW 204CV 2993CC - BMW 5 (F10): 530 d 01.2010/08.2011 180KW 245CV 2993CC</p>		<p><b>W5210</b> NO. 11237619245 - 11237797996 - 11238518985 - 11238578993 - 11238585220 - 11238586724 - 11238651643</p> <p><b>POLIE DA CAMBOTA (6 PISTAS)</b></p> <p>BMW 5 (F10): 518 d 07.2014/10.2016 110KW 150CV 1995CC - BMW 5 (F10) 520 d 06.2010/10.2016 120KW 163CV 1995CC - BMW 5 (F10) 520 d xDrive 10.2013/10.2016 120kW 163CV 1995CC - BMW 5 (F10): 520 d 07.2014/10.2016 140KW 190CV 1995CC - BMW 5 (F10): 520 d xDrive 07.2014/10.2016 140KW 190CV 1995CC - BMW 5 (F10) 520 d 10.2013/10.2016 155KW 211CV 1995CC - BMW 5 (F10) 520 d xDrive 10.2013/10.2016 155KW 211...</p>
	<p><b>Z50360</b> NO. 51161881149 - 7703072116 - N10259301</p> <p><b>MOLA REBITE FIXAÇÃO</b></p> <p>BMW 5 (F10) 518 d (07.2013 - 06.2014) 105kW 143cv 1995cm3 três volumes BMW 5 (F10) 518 d (07.2014 - 10.2016) 110kW 150cv 1995cm3 três volumes BMW 5 (F10) 520 d (06.2010 - 06.2014) 135kW 184cv 1995cm3 três volumes BMW 5 (F10) 520 d (07.2014 - 10.2016) 140kW 190cv 1995cm3 três volumes BMW 5 (F10) 520 d (06.2010 - 06.2014) 155kW 211cv 1995cm3 três volumes BMW 5 (F10) 520 d xDrive (07.2013 - 06.2014) ...</p>		<p><b>Z55186</b> NO. 07147145753</p> <p><b>MOLA DE PAINEL</b></p> <p>BMW 5 (F10) 518 d (07.2013 - 10.2016) 100kW 136cv 1995cm3 três volumes BMW 5 (F10) 518 d (07.2013 - 06.2014) 105kW 143cv 1995cm3 três volumes BMW 5 (F10) 518 d (07.2014 - 10.2016) 110kW 150cv 1995cm3 três volumes BMW 5 (F10) 520 d (10.2013 - 10.2016) 155kW 211cv 1995cm3 três volumes BMW 5 (F10) 520 d (06.2010 - 10.2016) 120kW 163cv 1995cm3 três volumes BMW 5 (F10) 520 d (06.2010 - 06.2014) 135kW 1...</p>



	<p><b>D0022</b> NO. 26111209168 - 26111227420 - 26111227717 - 26111229080 - 26111229360 - 26117511454</p> <p>CARDAN TRANSMISSÃO D135X30MM 6 FUROS 12MM ENTRE FUROS 96MM BMW SERIE 5 (F11) TOURING</p>		<p><b>KUR21999</b> NO. 1f-d24mm 1f-d10mm 1f-d10mm 1f-d19mm</p> <p>KIT DE REPARAÇÃO ALAVANCA DE VELOCIDADES</p> <p>BMW 5 Touring (F11) 518 d (De 07.2013 Até 02.2017) 100kW 136cv 1995cm3 Combi - BMW 5 Touring (F11) 518 d (De 07.2013 Até 06.2014) 105kW 143cv 1995cm3 Combi - BMW 5 Touring (F11) 518 d (De 07.2014 Até 02.2017) 110kW 150cv 1995cm3 Combi - BMW 5 Touring (F11) 518 d (De 07.2014 Até 02.2017) 120kW 163cv 1995cm3 Combi - BMW 5 Touring (F11) 520 d (De 06.2010 Até 02.2017) 120kW 163cv 1995cm3 Combi - BMW 5...</p>
	<p><b>P1042</b> NO. 35211160422</p> <p>CAPA DE PEDAL DA EMBRAIAGEM</p> <p>BMW 5 Touring (F11) 520 i 10.2010/02.2017 135KW 184CV 1997CC N20 B20 B N20 B20 A 0005BFZ - BMW 5 Touring (F11) 528 i 09.2011/02.2017 180KW 245CV 1997CC N20 B20 A 0005BGA - BMW 5 Touring (F11) 535 i 06.2010/02.2017 225KW 306CV 2979CC N55 B30 A 0005ASM 0005AYV</p>		<p><b>R224951</b> NO. 11617810614</p> <p>TUBO DO AR SOBREALIMENTAÇÃO</p> <p>BMW 5 Touring (F11) 518 d (De 2013.07 Até 2017.02) 100kW 136cv 1995cm3 Combi - BMW 5 Touring (F11) 518 d (De 2013.07 Até 2014.06) 105kW 143cv 1995cm3 Combi - BMW 5 Touring (F11) 520 d xDrive (De 2013.07 Até 2014.06) 135kW 184cv 1995cm3 Combi - BMW 5 Touring (F11) 525 d xDrive (De 2013.07 Até 2017.02) 155kW 211cv 1995cm3 Combi - BMW 5 Touring (F11) 525 d (De 07.2013 Até 2017...)</p>
	<p><b>S1824</b> NO. 33324062629 - 33324062630 - 33326780069 - 33326780070 - 33326784351 - 33326784352 - 33326794877 - 33326794878</p> <p>SILENT-BLOC DO BRAÇO SUSPENSÃO INFERIOR TRÁS</p> <p>BMW 5 Touring (F11) 518 d 07.2013/02.2017 100KW 136CV 1995CC B47 D20 A N47 D20 C 0005BPT - BMW 5 Touring (F11) 518 d 07.2013/06.2014 105KW 143CV 1995CC N47 D20 C 0005BPU - BMW 5 Touring (F11) 518 d 07.2014/02.2017 110KW 150CV 1995CC B47 D20 A 0005BWR - BMW 5 Touring (F11) 518 d 07.2014/02.2017 120KW 163CV 1995CC B47 D20 A - BMW 5 Touring (F11) 520 d 06.2010/02.2017 120KW 163CV 1995CC N47 D20 C B...</p>		<p><b>UAP81292</b> NO. 13532247156 - 2247156</p> <p>ANILHA PROTEÇÃO TÉRMICA INJECTORES</p> <p>BMW 5 Touring (F11) 518 d (De 10-2012 Até 07-2014) 105kW 143CV 1995cc Combi BMW 5 Touring (F11) 518 d (De 01-2014 Até .1-20 -) 110kW 150CV 1995cc Combi BMW 5 Touring (F11) 520 d (De 11-2009 Até 10-2016) 135kW 184CV 1995cc Combi BMW 5 Touring (F11) 520 d xDrive (De 02-2013 Até 07-2014) 135kW 184CV 1995cc Combi BMW 5 Touring (F11) 520 d (De 10-2013 Até .1-20 -) 140kW 190CV 1995cc Combi BMW 5 Touring...</p>
	<p><b>UAP81905</b> NO. 13532247156 - 2247156</p> <p>ANILHA PROTEÇÃO TÉRMICA INJECTORES</p> <p>BMW 5 Touring (F11) 518 d (De 10-2012 Até 07-2014) 105kW 143CV 1995cc Combi BMW 5 Touring (F11) 518 d (De 01-2014 Até .1-20 -) 110kW 150CV 1995cc Combi BMW 5 Touring (F11) 520 d (De 11-2009 Até 10-2016) 135kW 184CV 1995cc Combi BMW 5 Touring (F11) 520 d xDrive (De 02-2013 Até 07-2014) 135kW 184CV 1995cc Combi BMW 5 Touring (F11) 520 d (De 10-2013 Até .1-20 -) 140kW 190CV 1995cc Combi BMW 5 Touring...</p>		<p><b>UCRZ1097</b> NO. 26207556020 - 26207593164 - 26207597649 - 26207620521 - 26207629988 - 26208605866 - 26208628043</p> <p>CRUZETA TRANSMISSAO VEIO LONGITUDINAL D24X56MM</p> <p>BMW 5 Touring (F11) 520 d xDrive 07.2013/06.2014 135KW 184CV 1995CC N47 D20 C 0005BPW - BMW 5 Touring (F11) 520 d xDrive 07.2013/06.2014 147KW 200CV 1995CC N47 D20 C 0005BPX - BMW 5 Touring (F11) 525 d xDrive 07.2013/02.2017 155KW 211CV 1995CC N47 D20 D 0005BGG - BMW 5 Touring (F11) 525 d xDrive 07.2013/02.2017 160KW 218CV 1995CC N47 D20 D 0005BGH 0005BHT - BMW 5 Touring (F11) 528 i xDrive 09.2011...</p>
	<p><b>W5140</b> NO. 11237797996 - 11237800026 - 11238578993 - 11238585220 - 11238651643</p> <p>POLIE DA CAMBOTA 7 PISTAS</p> <p>BMW SÉRIE 5 Touring (F11) 525 d (APÓS 09.10) 204cv 2993cc Combi - BMW 5 Touring (F11) 530 d (APÓS 09.10) 245cv 2993cc Combi - BMW 5 Touring (F11) 530 d (APÓS 09.11) 258cv 2993cc Combi - BMW 5 Touring (F11) 535 d (APÓS 09.10) 299cv 2993cc Combi - BMW 5 Touring (F11) 535 d (APÓS 09.11) 313cv 2993cc Combi</p>		<p><b>W5142</b> NO. 11238512072 - 11238578993 - 11238585220 - 11238651643</p> <p>POLIE DA CAMBOTA 6 PISTAS</p> <p>BMW SÉRIE 5 Touring (F11) 518 d (APÓS 01.13) 143cv 1995cc Combi - BMW 5 Touring (F11) 520 d (06.10 A 06.14) 184cv 1995cc Combi - BMW 5 Touring (F11) 520 d xDrive (06.10 A 07.14) 184cv 1995cc Comb</p>
	<p><b>W5192</b> NO. 11238602800</p> <p>POLIE DA CAMBOTA (6 pistas)</p> <p>BMW 5 Touring (F11): 518 d 07.2013/06.2014 105KW 143CV 1995CC - BMW 5 Touring (F11): 518 d 07.2014/02.2017 110KW 150CV 1995CC - BMW 5 Touring (F11): 520 d 06.2010/06.2014 135KW 184CV 1995CC - BMW 5 Touring (F11): 520 d xDrive 07.2013/06.2014 135KW 184CV 1995CC - BMW 5 Touring (F11): 520 d 07.2014/02.2017 140KW 190CV 1995CC - BMW 5 Touring (F11): 520 d xDrive 07.2014/02.2017 140KW 190CV 1995CC - BM...</p>		<p><b>W5208</b> NO. 11237797996 - 11238511321 - 11238518985 - 11238578993 - 11238585220 - 11238586724 - 11238651643</p> <p>POLIE DA CAMBOTA (6 pistas)</p> <p>BMW 5 Touring (F11): 530 d 09.2011/02.2017 190KW 258CV 2993CC - BMW 5 Touring (F11): 530 d xDrive 03.2011/02.2017 190KW 258CV 2993CC - BMW 5 Touring (F11): 530 d 09.2011/02.2017 210KW 286CV 2993CC - BMW 5 Touring (F11): 530 d xDrive 03.2011/02.2017 210KW 286CV 2993CC</p>
	<p><b>W5209</b> NO. 11237797996 - 11237800385 - 11238578993 - 11238585220 - 11238586724 - 11238651643</p> <p>POLIE DA CAMBOTA (6 PISTAS)</p> <p>BMW 5 Touring (F11): 525 d 09.2010/08.2011 150KW 204CV 2993CC - BMW 5 Touring (F11): 530 d 06.2010/08.2011 180KW 245CV 2993CC</p>		<p><b>W5210</b> NO. 11237619245 - 11237797996 - 11238518985 - 11238578993 - 11238585220 - 11238586724 - 11238651643</p> <p>POLIE DA CAMBOTA (6 PISTAS)</p> <p>BMW 5 Touring (F11): 518 d 07.2014/02.2017 110KW 150CV 1995CC - BMW 5 Touring (F11) 518 d 07.2014/02.2017 120KW 163CV 1995CC - BMW 5 Touring (F11) 520 d xDrive 07.2014/02.2017 120KW 163CV 1995CC - BMW 5 Touring (F11): 520 d 07.2014/02.2017 140KW 190CV 1995CC - BMW 5 Touring (F11): 520 d xDrive 07.2014/02.2017 140KW 190CV 1995CC - BMW 5 Touring (F11) 520 d 07.2014/02.2017 155KW 211CV 1995CC - BMW 5...</p>
	<p><b>Z55186</b> NO. 07147145753</p> <p>MOLA DE PAINEL</p> <p>BMW 5 Touring (F11) 518 d (07.2014 - 02.2017) 120kw 163cv 1995cm3 Combi BMW 5 Touring (F11) 518 d (07.2013 - 02.2017) 100kw 136cv 1995cm3 Combi BMW 5 Touring (F11) 518 d (07.2013 - 06.2014) 105kw 143cv 1995cm3 Combi BMW 5 Touring (F11) 518 d (07.2014 - 02.2017) 110kw 150cv 1995cm3 Combi BMW 5 Touring (F11) 520 d (06.2010 - 02.2017) 120kw 163cv 1995cm3 Combi BMW 5 Touring (F11) 520 d (06.2010 - 06...</p>		<p>d155mm d40/60mm 4f-d10mm</p>
<p>d8x 18mm</p>	<p>f-d18mm</p>		



## BMW SERIE 5 (F90) - (G30)

Rafri, Lda.

	<b>E1122</b>	NO. 18203404099 - 18207544809 - 18207568777 - 18207791570 - 18207798560		<b>KUBT3023</b>	NO. 1f-d39mm(x2) 1f-d48mm(x2) 1f-d5mm
	ESTICADOR DO ESCAPE PANELA DE TRÁS			KIT BORRACHAS TRAVAO PINÇA TRAS BRENBO 40MM	
BMW 5 (G30, F90) 530 d (De 09.2016 Até 06.2020) 195kW 265cv 2993cm3 três volumes - BMW 5 (G30, F90) 530 d xDrive (De 09.2016 Até 06.2020) 195kW 265cv 2993cm3 três volumes -		82x50x25mm	2f-d10mm	BMW 5 (G30, F90) 518 d 07.2018/06.2020 100KW 136CV 1995CC B47 D20 B 0005CSR - BMW 5 (G30, F90) 518 d 07.2018/06.2020 110KW 150CV 1995CC B47 D20 B 0005CSQ - BMW 5 (G30, F90) 520 d desde 09.2016 120KW 163CV 1995CC B47 D20 AB47 D20 B 0005CNS - BMW 5 (G30, F90) 520 d desde 09.2016 140KW 190CV 1995CC B47 D20 BB47 D20 A 0005CNT - BMW 5 (G30, F90) 520 d Mild-Hybrid desde 11.2019 120KW 163CV 1995CC JA1B47...	
	<b>W5192</b>	NO. 11238602800		<b>W5192</b>	NO. 11238602800
	POLIE DA CABBOTA (6 pistas)			POLIE DA CABBOTA (6 pistas)	
BMW 5 (G30, F90): 530 e Plug-in-Hybrid 03.2017/» » » 135KW 184CV 1998CC - BMW 5 (G30, F90): 530 i 09.2016/06.2020 185KW 252CV 1998CC - BMW 5 (G30, F90): 530 i xDrive 09.2016/06.2020 185KW 252CV 1998CC		d158mm	d59mm	BMW 5 (G30, F90): 530 e Plug-in-Hybrid 03.2017/» » » 135KW 184CV 1998CC - BMW 5 (G30, F90): 530 i 09.2016/06.2020 185KW 252CV 1998CC - BMW 5 (G30, F90): 530 i xDrive 09.2016/06.2020 185KW 252CV 1998CC	
	<b>W5210</b>	NO. 11237619245 - 11237797996 - 11238518985 - 11238578993 - 11238585220 - 11238586724 - 11238651643		<b>Z55186</b>	NO. 07147145753
	POLIE DA CABBOTA (6 PISTAS)			MOLA DE PAINEL	
BMW 5 (G30, F90): 520 d 09.2016/10.2019 120KW 163CV 1995CC - BMW 5 (G30, F90): 520 d 09.2016/10.2019 140KW 190CV 1995CC - BMW 5 (G30, F90): 520 d xDrive 09.2016/10.2019 140KW 190CV 1995CC		d155mm	d40/60mm 4f-d10mm	BMW 5 (G30, F90) 518 d (07.2018 - 06.2020) 100kw 136cv 1995cm3 três volumes BMW 5 (G30, F90) 518 d (07.2018 - 06.2020) 110kw 150cv 1995cm3 três volumes BMW 5 (G30, F90) 518 d Mild-Hybrid (07.2020 - 06.2023) 110kw 150cv 1995cm3 três volumes BMW 5 (G30, F90) 520 d (09.2016 - 06.2023) 120kw 163cv 1995cm3 três volumes BMW 5 (G30, F90) 520 d (09.2016 - 06.2023) 140kw 190cv 1995cm3 três volumes BMW 5 (G...	

## BMW SERIE 5 (G31) Touring

	<b>E1122</b>	NO. 18203404099 - 18207544809 - 18207568777 - 18207791570 - 18207798560		<b>KUBT3023</b>	NO. 1f-d39mm(x2) 1f-d48mm(x2) 1f-d5mm
	ESTICADOR DO ESCAPE PANELA DE TRÁS			KIT BORRACHAS TRAVAO PINÇA TRAS BRENBO 40MM	
BMW 5 Touring (G31) 530 d (De 03.2017 Até 06.2020) 195kW 265cv 2993cm3 Combi - BMW 5 Touring (G31) 530 d xDrive (De 03.2017 Até 06.2020) 195kW 265cv 2993cm3 Combi -		82x50x25mm	2f-d10mm	BMW 5 Touring (G31) 518 d 07.2018/06.2020 100KW 136CV 1995CC B47 D20 B 0005CST - BMW 5 Touring (G31) 518 d 07.2018/06.2020 110KW 150CV 1995CC B47 D20 B 0005CSS - BMW 5 Touring (G31) 520 d desde 03.2017 140KW 190CV 1995CC B47 D20 BB47 D20 A 0005COR - BMW 5 Touring (G31) 520 d xDrive desde 07.2017 140KW 190CV 1995CC B47 D20 BB47 D20 A 0005CPS - BMW 5 Touring (G31) 520 i 07.2017/06.2020 135KW 184CV 1...	
	<b>W5192</b>	NO. 11238602800		<b>W5210</b>	NO. 11237619245 - 11237797996 - 11238518985 - 11238578993 - 11238585220 - 11238586724 - 11238651643
	POLIE DA CABBOTA (6 pistas)			POLIE DA CABBOTA (6 PISTAS)	
BMW 5 Touring (G31): 530 i 03.2017/06.2020 185KW 252CV 1998CC		d158mm	d59mm	BMW 5 Touring (G31): 520 d 03.2017/10.2019 140KW 190CV 1995CC - BMW 5 Touring (G31): 520 d xDrive 07.2017/10.2019 140KW 190CV 1995CC	





## BMW SERIE 6(E24)

	<b>A0948</b>	NO. 26111206502 - 26121104355 - A26111206502		<b>A1949</b>	NO. 0019811225 - 0029812925 - 0039812325 - 0089814325 - 26121103728 - 26121209590 - 26121225071 - 261212...
	APOIO SUPORTE CENTRAL DA TRANSMISSÃO COM ROLAMENTO			APOIO DA TRANSMISSÃO	
BMW 6 (E24) 628 CSi 09.1979/08.1987 135KW 184CV 2788CC M30 B28 0005411 0005424 - BMW 6 (E24) 630 CS 04.1976/08.1979 135KW 184CV 2986CC M30 B30 0005408 - BMW 6 (E24) 630 CS 04.1976/08.1979 136KW 185CV 2986CC M30 B30 0005392 - BMW 6 (E24) 633 CSi 10.1975/12.1981 147KW 200CV 3210CC M30 B32 0005393 - BMW 6 (E24) 633 CSi 09.1978/08.1984 145KW 197CV 3210CC M30 B32 0005409 - BMW 6 (E24) 635 CSi 12.1977/0...		155x101x42mm	d30mm	BMW 6 (E24) 628 CSi Tipo de caixa de velocidades: para caixa de velocidades manual (09.79 A 08.87) 184cv 2788cc Coupé - BMW 6 (E24) 630 CS (04.76 A 08.79) 185cv 2986cc Coupé - BMW 6 (E24) 630 CS (04.76 A 08.79) 184cv 2986cc Coupé - BMW 6 (E24) 633 CSi (10.75 A 12.81) 200cv 3210cc Coupé - BMW 6 (E24) 633 CSi (09.78 A 08.84) 197cv 3210cc Coupé - BMW 6 (E24) 635 CSi Tipo de caixa de velocid...	
		170x110x56mm	1f-d30mm		

	<p><b>D0022</b> NO. 26111209168 - 26111227420 - 26111227717 - 26111229080 - 26111229360 - 261117511454</p> <p><b>CARDAN TRANSMISSÃO D135X30MM 6 FUROS 12MM ENTRE FUROS 96MM</b></p> <p>BMW 6 (E24) 628 CSi 09.1979/08.1987 135KW 184CV 2788CC M30 B28 0005411 0005424 - BMW 6 (E24) 633 CSi 10.1975/12.1981 147KW 200CV 3210CC M30 B32 0005393 - BMW 6 (E24) 633 CSi 09.1978/08.1984 145KW 197CV 3210CC M30 B32 0005409 - BMW 6 (E24) 635 CSi 06.1978/04.1982 160KW 218CV 3453CC M30 B35 (346EC) M30 B35 (Motronic,10:1) M30 B35 (L-Jetronic,10:1) 0005407 0005425 - BMW 6 (E24) 635 CSi 12.1984/12.198...</p> <p>d132x123x30mm 6f-d12mm</p>		<p><b>D0059</b> NO. 26111109603</p> <p><b>CARDAN TRANSMISSÃO</b></p> <p>BMW 6 (E24) 628 CSi (De 09-1979 Até 08-1987) 135kW 184CV 2788cc Coupé BMW 6 (E24) 630 CS (De 04-1976 Até 08-1979) 136kW 185CV 2986cc Coupé BMW 6 (E24) 630 CS (De 04-1976 Até 08-1979) 135kW 184CV 2986cc Coupé BMW 6 (E24) 633 CSi (De 10-1975 Até 12-1981) 147KW 200CV 3210cc Coupé BMW 6 (E24) 633 CSi (De 09-1978 Até 08-1984) 145KW 197CV 3210cc Coupé BMW 6 (E24) 635 CSi (De 12-1977 Até 04-1989) 136kW 1...</p> <p>d135x30mm 6f-d12mm</p>
	<p><b>D0060</b> NO. 32311115090 - 32311115092</p> <p><b>CARDAN COLUNA DIREÇÃO</b></p> <p>BMW 6 (E24) 628 CSi 09.1979/08.1987 135KW 184CV 2788CC M30 B28 0005411 0005424 - BMW 6 (E24) 635 CSi 12.1977/04.1989 141KW 192CV 3430CC M30 B34 (346KA) M30 B34 (346EC) M30 B34 (346KB) 0005446 - BMW 6 (E24) 635 CSi 06.1978/04.1982 160KW 218CV 3453CC M30 B35 (346EC) M30 B35 (Motronic,10:1) M30 B35 (L-Jetronic,10:1) 0005407 - BMW 6 (E24) 635 CSi 12.1984/12.1986 136KW 185CV 3430CC M30 B34 (346KA) 0005...</p> <p>65x65x13mm 4f-d8mm</p>		<p><b>D0077</b> NO. 32311112359</p> <p><b>CARDAN DIREÇÃO</b></p> <p>BMW 6 (E24): 628 CSi 09.1979/08.1987 135KW 184CV 2788CC - BMW 6 (E24): 630 CS 04.1976/08.1979 136KW 185CV 2986CC - BMW 6 (E24): 630 CS 04.1976/08.1979 135KW 184CV 2986CC - BMW 6 (E24): 633 CSi 10.1975/12.1981 147KW 200CV 3210CC - BMW 6 (E24): 633 CSi 09.1978/08.1984 145KW 197KW 3210CC - BMW 6 (E24): 635 CSi 12.1984/12.1986 136KW 185CV 3430CC - BMW 6 (E24): 635 CSi 12.1977/04.1989 141KW 192CV 3430CC...</p> <p>d74x12mm 4f-d8mm 1f-d16mm</p>
	<p><b>F0469-I</b> NO. 16110170470102 - 16410.17047.01.02 - 16410170470106 - 60507865 - 60805170 - 60811991 - 766619 - 6094 - 766619 - 6094 - 766619 - 6094</p> <p><b>FOLE DA TRANSMISSÃO LADO DA CAIXA</b></p> <p>BMW 6 (E24): 628 CSi 09.1979/08.1987 135KW 184CV 2788CC - BMW 6 (E24): 630 CS 04.1976/08.1979 136KW 185CV 2986CC - BMW 6 (E24): 633 CSi 10.1975/12.1981 147KW 200CV 3210CC - BMW 6 (E24): 633 CSi 09.1978/08.1984 145KW 197CV 3210CC - BMW 6 (E24): 635 CSi 06.1978/04.1982 160KW 218CV 3453CC</p> <p>d85x80mm 1f-d61mm 1f-d23mm</p>		<p><b>F1650A-I</b> NO. 33211209551 - 33211229221 - 33219067815 - 33219067906</p> <p><b>FOLE DA TRANSMISSÃO JUNTO À CAIXA</b></p> <p>BMW SÉRIE 6(E24) 3.4i 635 CSi (1976 A 1990)</p> <p>d110x125mm 1f-d108mm 1f-d25mm</p>
	<p><b>KUR21999</b> NO. 1f-d24mm 1f-d10mm 1f-d10mm 1f-d19mm</p> <p><b>KIT DE REPARAÇÃO ALAVANCA DE VELOCIDADES</b></p> <p>BMW 6 (E24) 628 CSi (De 09.1979 Até 08.1987) 135kW 184cv 2788cm3 Coupé - BMW 6 (E24) 633 CSi (De 10.1975 Até 12.1981) 147kW 200cv 3210cm3 Coupé - BMW 6 (E24) 633 CSi (De 09.1978 Até 08.1984) 145kW 197cv 3210cm3 Coupé - BMW 6 (E24) 635 CSi (De 12.1984 Até 12.1986) 136kW 185cv 3430cm3 Coupé - BMW 6 (E24) 635 CSi (De 12.1977 Até 04.1989) 141kW 192cv 3430cm3 Coupé - BMW 6 (E24) 635 CSi (De 07.1987 Até...</p> <p>d37x18mm d19x25mm d17x22mm d31x21mm d31x21mm d12x10mm d12x10mm</p>		<p><b>M6009</b> NO. 18111245429 - 18111719313</p> <p><b>JUNTA DE ESCAPE</b></p> <p>BMW E24 635csi</p> <p>.d86x5mm 1f-d78mm</p>
	<p><b>M6017</b> NO. 18111175311 - 18111245489 - 18111245840 - 18111245960 - 18114690146</p> <p><b>JUNTA DE ESCAPE</b></p> <p>BMW 6 (E24): 628 CSi 09.1979/08.1987 135KW 184CV 2788CC - BMW 6 (E24): 630 CS 04.1976/08.1979 136KW 185CV 2986CC - BMW 6 (E24): 630 CS 04.1976/08.1979 135KW 184CV 2986CC - BMW 6 (E24): 633 CSi 10.1975/12.1981 147KW 200CV 3210CC - MAZDA 6 (E24): 633 CSi 09.1978/08.1984 145KW 197CV 3210CC</p> <p>d56.5x10mm 1f-d44mm</p>		<p><b>M6028</b> NO. 18111175311</p> <p><b>JUNTA DE ESCAPE</b></p> <p>BMW 6 (E24) 628 CSi 09.1979/08.1987 135KW 184CV 2788CC M30 B28 0005411, 0005424 - BMW 6 (E24) 635 CSi 06.1978/04.1982 160KW 218CV 3453CC M30 B35 (346EC) M30 B35 (Motronic,10:1) M30 B35 (L-Jetronic,10:1) 0005407, 0005425</p> <p>d57x10mm 1f-d47mm</p>
	<p><b>M6083</b> NO. 18111101192 - 18111245429 - 18111723843</p> <p><b>JUNTA DE ESCAPE</b></p> <p>BMW E24 628csi (1979 A 1989)</p> <p>87x78mm 1f-d39mm</p>		<p><b>N0500</b> NO. 18211105635 - 18211105638 - 18211105677 - 18211177708 - 18211728332 - 18214490159 - 1824490159</p> <p><b>ANEL DE SUPORTE DE ESCAPE</b></p> <p>BMW 6 (E24): 628 CSi 09.1979/08.1987 135KW 184CV 2788CC - BMW 6 (E24): 630 CS 04.1976/08.1979 136KW 185CV 2986CC - BMW 6 (E24): 630 CS 04.1976/08.1979 135KW 184CV 2986CC - BMW 6 (E24): 633 CSi 10.1975/12.1981 147KW 200CV 3210CC - BMW 6 (E24): 633 CSi 09.1978/08.1984 145KW 197CV 3210CC - BMW 6 (E24): 635 CSi 06.1978/04.1982 160KW 218CV 3453CC</p> <p>65x18mm</p>
	<p><b>N2004</b> NO. 18211176424 - 18211245985 - 18211712838</p> <p><b>ANEL DE ESCAPE</b></p> <p>BMW E24 628 - 630 - 633csi</p> <p>d78x39mm 1f-d43mm</p>		<p><b>N2331</b> NO. 18211101878 - 18211245113</p> <p><b>ANEL ESCAPE</b></p> <p>BMW E24 - 628 - 635csi</p> <p>d58x14mm 1f-d31mm</p>
	<p><b>N3727</b> NO. 3100099 - 90301-34207-000</p> <p><b>ANEL DE ESCAPE</b></p> <p>BMW E24 628 - 635csi</p> <p>d55x12mm 1f-d31mm</p>		<p><b>P1055</b> NO. 35211160421</p> <p><b>CAPA DE PEDAL DO TRAVÃO(VEÍCULOS COM CAIXA AUTOMÁTICA)</b></p> <p>BMW 6 (E24) 628 CSi 09.1979/08.1987 135KW 184CV 2788CC M30 B28 0005411 0005424 - BMW 6 (E24) 635 CSi 12.1977/04.1989 141KW 192CV 3430CC M30 B34 (346KA) M30 B34 (346EC) M30 B34 (346KB) 0005446 - BMW 6 (E24) 635 CSi 06.1978/04.1982 160KW 218CV 3453CC M30 B35 (346EC) M30 B35 (Motronic,10:1) M30 B35 (L-Jetronic,10:1) 0005407 0005425 - BMW 6 (E24) 635 CSi 12.1984/12.1986 136KW 185CV 3430CC M30 B34 (346...</p> <p>74x107x42mm</p>

	<p><b>P1059</b> NO. 1 108 634 - 35211108634</p> <p>CAPA DE PEDAL DO TRAVÃO</p> <p>BMW SÉRIE 6(E24) 628CSi - 630CS - 633CSi - 635CSi - (04-1976 A 05-1989)</p> <p>75x62x12mm</p>		<p><b>R220053</b> NO. 11531250387 - 11531266459</p> <p>TUBO DE LIGAÇÃO TERMOSTATO Á BOMBA DE ÁGUA</p> <p>BMW 6 (E24) 628 CSi 09.1979/08.1987 135KW 184CV 2788CC M30 B28 0005411 0005424 - BMW 6 (E24) 630 CS 04.1976/08.1979 135KW 184CV 2986CC M30 B30 0005408 - BMW 6 (E24) 630 CS 04.1976/08.1979 136KW 185CV 2986CC M30 B30 0005392 - BMW 6 (E24) 633 CSi 10.1975/12.1981 147KW 200CV 3210CC M30 B32 0005393 - BMW 6 (E24) 633 CSi 09.1978/08.1984 145KW 197CV 3210CC M30 B32 0005409 - BMW 6 (E24) 635 CSi 12.1977/0...</p> <p>B113-d39/d39mm 45-50mm</p>
	<p><b>S1271</b> NO. 31106770699 - 31106770690 - 31121092019 - 31121094235 - 31121122462 - 31121124622 - 31121133236 - 31121133236</p> <p>SILENT-BLOC DO BRAÇO DA SUSPENSÃO (FRENTE CENTRO)</p> <p>BMW 6 (E24) 628 CSi 09.1979/08.1987 135KW 184CV 2788CC M30 B28 0005411 0005424 - BMW 6 (E24) 630 CS 04.1976/08.1979 135KW 184CV 2986CC M30 B30 0005408 - BMW 6 (E24) 630 CS 04.1976/08.1979 136KW 185CV 2986CC M30 B30 0005392 - BMW 6 (E24) 633 CSi 10.1975/12.1981 147KW 200CV 3210CC M30 B32 0005393 - BMW 6 (E24) 633 CSi 09.1978/08.1984 145KW 197CV 3210CC M30 B32 0005409 - BMW 6 (E24) 635 CSi 12.1977/0...</p> <p>d46x52mm c40mm 1f-d12mm</p>		<p><b>T0621-I</b> NO. 31331124449 - 31331124573 - 31331125215</p> <p>BATERNTE SUSPENSÃO FRENTE</p> <p>BMW 6 (E24) 628 CSi (09.79 A 08.87) 184cv 2788cc Coupé - BMW 6 (E24) 635 CSi (12.77 A 04.89) 185cv 3430cc Coupé - BMW 6 (E24) 635 CSi (08.87 A 04.89) 211cv 3430cc Coupé - BMW 6 (E24) 635 CSi (06.78 A 08.88) 218cv 3453cc Coupé - BMW 6 (E24) M 635 CSi (04.84 A 12.88) 286cv 3453cc Coupé</p> <p>d59x85mm 1f-d26mm 1f-d18mm</p>
	<p><b>T0622-I</b> NO. 33 35 2 124 573 - 33521124573</p> <p>BATERNTE SUSPENSÃO FRENTE</p> <p>BMW 6 (E24) 628 CSi (09.79 A 08.87) 184cv 2788cc Coupé - BMW 6 (E24) 635 CSi (12.77 A 04.89) 185cv 3430cc Coupé - BMW 6 (E24) 635 CSi (12.77 A 04.89) 192cv 3430cc Coupé - BMW 6 (E24) 635 CSi (08.87 A 04.89) 211cv 3430cc Coupé - BMW 6 (E24) 635 CSi (06.78 A 08.88) 218cv 3453cc Coupé</p> <p>d58x83mm 1f-d18mm 1f-d12mm</p>		<p><b>U0020</b> NO. 18214490157 - A18214490157</p> <p>TACO DE NYLON PARA ANEIS DE ESCAPE N0500</p> <p>BMW SERIE 6(E24)</p> <p>34x25x18mm</p>
	<p><b>U7033K</b> NO. 61671378609 - 64500149356 - 64500301636 - 64501363572 - 64501466019 - 64501468463 - 64508390601</p> <p>ORINGS BOMBA DIREÇÃO ASSITIDA</p> <p>BMW 6 (E24) 635 CSi (12.1984 - 12.1986) 136kw 185cv 3430cm3 Coupé BMW 6 (E24) 635 CSi (07.1987 - 04.1989) 155kw 211cv 3430cm3 Coupé BMW 6 (E24) M 635 CSi (04.1986 - 02.1989) 191kw 260cv 3453cm3 Coupé BMW 6 (E24) M 635 CSi (04.1984 - 12.1988) 210kw 286cv 3453cm3 Coupé</p> <p>d11x2mm d10x2mm 1f-d7mm 1f-d6mm</p>		<p><b>UAP81905</b> NO. 13532247156 - 2247156</p> <p>ANILHA PROTEÇÃO TÉRMICA INJECTORES</p> <p>BMW 6 Cabriolet (F12) 640 d (De 09-2011 Até .1-20 -) 230kW 313CV 2993cc Cabriolet BMW 6 Cabriolet (F12) 640 d xDrive (De 09-2011 Até .1-20 -) 230kW 313CV 2993cc Cabriolet</p> <p>d14x1mm 1f-d7mm</p>
	<p><b>UAP81905</b> NO. 13532247156 - 2247156</p> <p>ANILHA PROTEÇÃO TÉRMICA INJECTORES</p> <p>BMW 6 Coupé (F13) 640 d (De 11-2010 Até .1-20 -) 230kW 313CV 2993cc Coupé BMW 6 Coupé (F13) 640 d xDrive (De 09-2011 Até .1-20 -) 230kW 313CV 2993cc Coupé</p> <p>d14x1mm 1f-d7mm</p>		<p><b>UAP81905</b> NO. 13532247156 - 2247156</p> <p>ANILHA PROTEÇÃO TÉRMICA INJECTORES</p> <p>BMW 6 Gran Coupe (F06) 640 d (De 09-2011 Até .1-20 -) 230kW 313CV 2993cc Coupé BMW 6 Gran Coupe (F06) 640 d xDrive (De 01-2013 Até .1-20 -) 230kW 313CV 2993cc Coupé</p> <p>d14x1mm 1f-d7mm</p>
	<p><b>UCRZ1054</b> NO. 32311092958 - 32311150489</p> <p>CRUZETA VEIO DIREÇÃO D15X40MM</p> <p>BMW 6 (E24) 635 CSi (De 12.1984 Até 12.1986) 136kW 185cv 3430cm3 Coupé - BMW 6 (E24) 635 CSi (De 07.1987 Até 04.1989) 155kW 211cv 3430cm3 Coupé - BMW 6 (E24) M 635 CSi (De 04.1986 Até 02.1989) 191kW 260cv 3453cm3 Coupé - BMW 6 (E24) M 635 CSi (De 04.1984 Até 12.1988) 210kW 286cv 3453cm3 Coupé -</p> <p>d15x28x40mm</p>		<p><b>UCRZ1093</b> NO. 26111105398 - 26117518304 - 26203401609 - 26207526677</p> <p>CRUZETA DO VEIO TRANSMISSÃO LONGITUDINAL</p> <p>BMW 6 (E24) 635 CSi (De 12.1984 Até 12.1986) 136kW 185cv 3430cm3 Coupé - BMW 6 (E24) 635 CSi (De 07.1987 Até 04.1989) 155kW 211cv 3430cm3 Coupé - BMW 6 (E24) M 635 CSi (De 04.1986 Até 02.1989) 191kW 260cv 3453cm3 Coupé - BMW 6 (E24) M 635 CSi (De 04.1986 Até 02.1989) 191kW 260cv 3453cm3 Coupé - BMW 6 (E24) M 635 CSi (De 04.1984 Até 12.1988) 210kW 286cv 3453cm3 Coupé - BMW 6 (E24) M 635 CSi (De 04....</p> <p>d24x63mm 43mm</p>
	<p><b>UMB84029</b> NO. 07119937320 - 11111276472 - 11111717939 - 1717939 - 9937321</p> <p>TAMPÃO BLOCO MOTOR</p> <p>BMW 6 (E24) 628 CSi (De 09-1979 Até 08-1987) 135kW 184CV 2788cc Coupé BMW 6 (E24) 630 CS (De 04-1976 Até 08-1979) 136kW 185CV 2986cc Coupé BMW 6 (E24) 630 CS (De 04-1976 Até 08-1979) 135kW 184CV 2986cc Coupé BMW 6 (E24) 633 CSi (De 10-1975 Até 12-1981) 147kW 200CV 3210cc Coupé BMW 6 (E24) 633 CSi (De 09-1978 Até 08-1984) 145kW 197CV 3210cc Coupé BMW 6 (E24) 635 CSi (De 12-1984 Até 12-1986) 136kW 1...</p> <p>d36x10mm di-32mm</p>		<p><b>UMB84038</b> NO. 07119937331 - 11111276473 - 11111714712</p> <p>TAMPÃO BLOCO MOTOR</p> <p>BMW 6 (E24) 628 CSi (09.79 A 08.87) 184cv 2788cc Coupé - BMW 6 (E24) 630 CS 04.76 A 08.79) 185cv 2986cc Coupé - BMW 6 (E24) 630 CS (04.76 A 08.79) 184cv 2986cc Coupé - BMW 6 (E24) 633 CSi (09.78 A 08.84) 197cv 3210cc Coupé - BMW 6 (E24) 635 CSi (12.77 A 04.89) 185cv 3430cc Coupé - BMW 6 (E24) 635 CSi (12.77 A 04.89) 192cv 3430cc Coupé - BMW 6 (E24) 635 CSi (08.87 A 04.89) 211cv 3430cc...</p> <p>d-45x12,1mm di-42mm</p>
	<p><b>UTR0631</b> NO. 17111100848 - 17111102672 - 17111120062</p> <p>TAMPÃO RADIADOR</p> <p>BMW 6 (E24): 628 CSi 09.1979/08.1987 135KW 184CV 2788CC - BMW 6 (E24): 630 CS 04.1976/08.1979 136KW 185CV 2986CC - BMW 6 (E24): 630 CS 04.1976/08.1979 135KW 184CV 2986CC - BMW 6 (E24): 633 CSi 10.1975/12.1981 147KW 200CV 3210CC - BMW 6 (E24): 633 CSi 09.1978/08.1984 145KW 197CV 3210CC - BMW 6 (E24): 635 CSi 12.1984/12.1986 136KW 185CV 3430CC - BMW 6 (E24): 635 CSi 12.1977/04.1989 141KW 192CV 3430CC...</p> <p>d59/79x29mm d38x26mm</p>		<p><b>UTR0631</b> NO. 17111100848 - 17111102672 - 17111120062</p> <p>TAMPÃO RADIADOR</p> <p>BMW 6 (E24) 628 CSi (De 1979.09 Até 1987.08) 135kW 184cv 2788cm3 Coupé -</p> <p>d59/79x29mm d38x26mm</p>



	<p><b>Y3239</b> NO. 36130141574 - 36130141576 - 36131095390 - 36131116717 - 36131117190 - 36131126191</p> <p>PARAFUSO PERNO RODA CHAVE 17 M12X1,50X50MM ( BASE CONICA )</p> <p>BMW 6 (E24) 628 CSI 09.1979/08.1987 135KW 184CV 2788CC M30 B28 0005411 0005424 - BMW 6 (E24) 630 CS 04.1976/08.1979 135KW 184CV 2986CC M30 B30 0005408 - BMW 6 (E24) 630 CS 04.1976/08.1979 136KW 185CV 2986CC M30 B30 0005392 - BMW 6 (E24) 633 CSI 10.1975/12.1981 147KW 200CV 3210CC M30 B32 0005393 - BMW 6 (E24) 633 CSI 09.1978/08.1984 145KW 197CV 3210CC M30 B32 0005409 - BMW 6 (E24) 635 CSI 12.1977/0...</p> <p>c51mm (ch-17mm) M12x1x24mm</p>		<p><b>Z55186</b> NO. 07147145753</p> <p>MOLA DE PAINEL</p> <p>BMW 6 Cabriolet (F12) 640 d (09.2011 - 06.2018) 230kw 313cv 2993cm3 Cabriolet BMW 6 Cabriolet (F12) 640 d xDrive (03.2012 - 06.2018) 230kw 313cv 2993cm3 Cabriolet BMW 6 Cabriolet (F12) 640 i (09.2011 - 06.2018) 235kw 320cv 2979cm3 Cabriolet BMW 6 Cabriolet (F12) 640 i xDrive (03.2013 - 06.2018) 235kw 320cv 2979cm3 Cabriolet BMW 6 Cabriolet (F12) 650 i (12.2010 - 06.2012) 300kw 408cv 4395cm3 Cabrio...</p> <p>d8x 18mm f-d18mm</p>
	<p><b>Z55186</b> NO. 07147145753</p> <p>MOLA DE PAINEL</p> <p>BMW 6 Coupé (F13) 640 d (09.2011 - 10.2017) 230kw 313cv 2993cm3 Coupé BMW 6 Coupé (F13) 640 d xDrive (03.2012 - 10.2017) 230kw 313cv 2993cm3 Coupé BMW 6 Coupé (F13) 640 i (07.2011 - 10.2017) 235kw 320cv 2979cm3 Coupé BMW 6 Coupé (F13) 640 i xDrive (03.2013 - 10.2017) 235kw 320cv 2979cm3 Coupé BMW 6 Coupé (F13) 650 i (07.2012 - 10.2017) 330kw 449cv 4395cm3 Coupé BMW 6 Coupé (F13) 650 i (07.2011 - 0...</p> <p>d8x 18mm f-d18mm</p>		<p><b>Z55186</b> NO. 07147145753</p> <p>MOLA DE PAINEL</p> <p>BMW 6 Gran Coupe (F06) 640 d (03.2012 - 10.2018) 230kw 313cv 2993cm3 Coupé BMW 6 Gran Coupe (F06) 640 d xDrive (03.2013 - 10.2018) 230kw 313cv 2993cm3 Coupé BMW 6 Gran Coupe (F06) 640 i (03.2012 - 10.2018) 235kw 320cv 2979cm3 Coupé BMW 6 Gran Coupe (F06) 640 i xDrive (03.2013 - 10.2018) 235kw 320cv 2979cm3 Coupé BMW 6 Gran Coupe (F06) 650 i (07.2012 - 10.2018) 330kw 449cv 4395cm3 Coupé BMW 6 Gran ...</p> <p>d8x 18mm f-d18mm</p>
	<p><b>Z86003</b> NO. 51711932996</p> <p>MOLAS FIXACAO MOLDURA PORTAS</p> <p>BMW 6 (E24) 628 CSI 09.1979/08.1987 135KW 184CV 2788CC M30 B28 0005411 0005424 - BMW 6 (E24) 630 CS 04.1976/08.1979 135KW 184CV 2986CC M30 B30 0005408 - BMW 6 (E24) 630 CS 04.1976/08.1979 136KW 185CV 2986CC M30 B30 0005392 - BMW 6 (E24) 633 CSI 10.1975/12.1981 147KW 200CV 3210CC M30 B32 0005393 - BMW 6 (E24) 633 CSI 09.1978/08.1984 145KW 197CV 3210CC M30 B32 0005409 - BMW 6 (E24) 635 CSI 12.1977/0...</p> <p>F-4G- mm T-12L-8H-7S-1mm</p>		

BMW SERIE 6(E63)

	<p><b>D0035</b> NO. 26117522027</p> <p>CARDAN TRANSMISSÃO</p> <p>BMW 6 (E63) 630 i (09.04 A 07.10) 258cv 2996cc Coupé - BMW 6 (E63) 630 i (07.07 A 07.10) 272cv 2996cc Coupé - BMW 6 Cabriolet (E64) 630 i (09.04 A 07.10) 258cv 2996cc Cabriolet - BMW 6 Cabriolet (E64) 630 i (07.07 A 07.10) 272cv 2996cc Cabriolet</p> <p>125x135x32mm 6f-d12mm</p>		<p><b>D0063</b> NO. 26117542238</p> <p>CARDAN DA TRANSMISSÃO</p> <p>BMW 6 (E63) 645 Ci (De 01-2004 Até 08-2005) 245kW 333CV 4398cc Coupé BMW 6 (E63) 650 i (De 07-2005 Até 07-2010) 270kW 367CV 4799cc Coupé BMW 6 (E63) 635 d (De 07-2007 Até 07-2010) 210kW 286CV 2993cc Coupé</p> <p>163x155x42mm 6f-d12mm</p>
	<p><b>E1110</b> NO.</p> <p>ESTICADOR DO ESCAPE</p> <p>BMW 6 (E63) 630 i (09.04 A 07.10) 258cv 2996cc Coupé - BMW 6 (E63) 645 Ci (01.04 A 08.05) 333cv 4398cc Coupé - BMW 6 (E63) 650 i (07.05 A 07.10) 367cv 4799cc Coupé - BMW 6 Cabriolet (E64) 630 i (09.04 A 07.10) 258cv 2996cc Cabriolet - BMW 6 Cabriolet (E64) 645 Ci (04.04 A 08.05) 333cv 4398cc Cabriolet - BMW 6 Cabriolet (E64) 650 i (07.05 A 07.10) 367cv 4799cc Cabriolet</p> <p>65x64x32mm 2f-d9mm</p>		<p><b>F1846-I</b> NO. 33211229594 - 33217527325 - 33217527326 - 33217529915 - 33217547080</p> <p>FOLE DA TRANSMISSÃO JUNTO À RODA</p> <p>BMW SÉRIE 6 (E63)(E64) 3.0i 630Ci - 4.4i 645Ci VALVETRONIC V8 (APOS 2004)</p> <p>d80x78mm 1f-d51mm 1f-d31mm</p>
	<p><b>F4207</b> NO. 25118036629 - 25118037309</p> <p>FOLE ALAVANCA VELOCIDADES C/ MANETE PUNHO TOPO COMPLETO 6 VELOCIDADES</p> <p>BMW E63</p> <p>172x153x212mm 135x145mm</p>		<p><b>KUBT3028</b> NO. 34211164186 - 34216765212</p> <p>KIT BORRACHAS TRAVAO PINÇA TRAS ATE/TEVES 42MM</p> <p>BMW 6 (E63) 630 i 09.2004/08.2007 190KW 258CV 2996CC N52 B30 BF N52 B30 A 0005811 0005AGZ - BMW 6 (E63) 630 i 09.2007/08.2010 200KW 272CV 2996CC N52 B30 B N52 B30 BF N52 B30 A 0005AKF</p> <p>d58x14mm d49x3mm d14x6mm d30mm 1f-d42mm 1f-d4mm</p>
	<p><b>KUBT3037</b> NO. 1f-d31mm 1f-d12/16mm 1f-d43mm 1f-d</p> <p>KIT BORRACHAS TRAVAO PINÇA TRAS ATE 42MM</p> <p>BMW 6 (E63) 630 i 09.2004/08.2007 190KW 258CV 2996CC N52 B30 BF N52 B30 A 0005811 0005AGZ - BMW 6 (E63) 630 i 09.2007/08.2010 200KW 272CV 2996CC N52 B30 B N52 B30 BF N52 B30 A 0005AKF</p> <p>d58x12mm d21x40mm(x2) 14x30mm 14x23mm 1f-d43mm 1f-d13</p>		<p><b>KUBT3037</b> NO. 1f-d31mm 1f-d12/16mm 1f-d43mm 1f-d</p> <p>KIT BORRACHAS TRAVAO PINÇA TRAS ATE 42MM</p> <p>BMW 6 Cabriolet (E64) 630 i 09.2004/08.2007 190KW 258CV 2996CC N52 B30 BF N52 B30 B N52 B30 A 0005812 0005AGY - BMW 6 Cabriolet (E64) 630 i 09.2007/08.2010 200KW 272CV 2996CC N52 B30 BF N52 B30 B N52 B30 A 0005AKG</p> <p>d58x12mm d21x40mm(x2) 14x30mm 14x23mm 1f-d43mm 1f-d13mm...</p>













	<p><b>A0948</b> NO. 26111206502 - 26121104355 - A26111206502</p> <p><b>APOIO SUPORTE CENTRAL DA TRANSMISSÃO COM ROLAMENTO</b></p> <p>BMW 7 (E23) 728 05.1977/08.1979 125KW 170CV 2788CC M30 B28 0005397 - BMW 7 (E23) 728 i 09.1977/08.1986 135KW 184CV 2788CC M30 B28 0005412 - BMW 7 (E23) 730 05.1977/08.1979 135KW 184CV 2986CC M30 B30 0005398 - BMW 7 (E23) 733 i 05.1977/08.1986 145KW 197CV 3210CC M30 B32 0005399 - BMW 7 (E23) 735 i 09.1982/09.1986 160KW 218CV 3430CC M30 B34 (346EC) 0005413 - BMW 7 (E23) 735 i 05.1984/09.1986 136KW 1...</p> <p>155x101x42mm d30mm</p>		<p><b>A1949</b> NO. 0019811225 - 0029812925 - 0039812325 - 0089814325 - 26121103728 - 26121209590 - 26121225071 - 261212...</p> <p><b>APOIO DA TRANSMISSÃO</b></p> <p>BMW 7 (E23) 728 (05.77 A 08.79) 170cv 2788cc três volumes - BMW 7 (E23) 728 i (07.78 A 08.86) 184cv 2788cc três volumes - BMW 7 (E23) 730 (05.77 A 08.79) 184cv 2986cc três volumes - BMW 7 (E23) 733 i (05.77 A 08.86) 197cv 3210cc três volumes - BMW 7 (E23) 735 i (01.85 A 08.86) 185cv 3430cc três volumes - BMW 7 (E23) 735 i (04.85 A 08.86) 192cv 3430cc três volumes - BMW 7 (E23) 735 i (09...</p> <p>170x110x56mm 1f-d30mm</p>
	<p><b>D0022</b> NO. 26111209168 - 26111227420 - 26111227717 - 26111229080 - 26111229360 - 26117511454</p> <p><b>CARDAN TRANSMISSÃO D135X30MM 6 FUROS 12MM ENTRE FUROS 96MM</b></p> <p>BMW 7 (E23) 728 i 09.1977/08.1986 135KW 184CV 2788CC M30 B28 0005412 - BMW 7 (E23) 733 i 05.1977/08.1986 145KW 197CV 3210CC M30 B32 0005399 - BMW 7 (E23) 735 i 09.1982/09.1986 160KW 218CV 3430CC M30 B34 (346EC) 0005413 - BMW 7 (E23) 735 i 05.1984/09.1986 136KW 185CV 3430CC M30 B34 (346KA) 0005443 - BMW 7 (E23) 735 i 04.1985/08.1986 141KW 192CV 3430CC M30 B34 (346EC) 0005444</p> <p>d132x123x30mm 6f-d12mm</p>		<p><b>D0059</b> NO. 26111109603</p> <p><b>CARDAN TRANSMISSÃO</b></p> <p>BMW 7 (E23) 728 (De 05-1977 Até 08-1979) 125kW 170CV 2788cc três volumes BMW 7 (E23) 728 i (De 07-1978 Até 08-1986) 135kW 184CV 2788cc três volumes BMW 7 (E23) 730 (De 05-1977 Até 08-1979) 135kW 184CV 2986cc três volumes BMW 7 (E23) 733 i (De 05-1977 Até 08-1986) 145kW 197CV 3210cc três volumes BMW 7 (E23) 735 i (De 01-1985 Até 08-1986) 136kW 185CV 3430cc três volumes BMW 7 (E23) 735 i (De 04...</p> <p>d135x30mm 6f-d12mm</p>
	<p><b>D0060</b> NO. 32311115090 - 32311115092</p> <p><b>CARDAN COLUNA DIREÇÃO</b></p> <p>BMW 7 (E23) 728 05.1977/08.1979 125KW 170CV 2788CC M30 B28 0005397 - BMW 7 (E23) 728 i 09.1977/08.1986 135KW 184CV 2788CC M30 B28 0005412 - BMW 7 (E23) 730 05.1977/08.1979 135KW 184CV 2986CC M30 B30 0005398 - BMW 7 (E23) 733 i 05.1977/08.1986 145KW 197CV 3210CC M30 B32 0005399 - BMW 7 (E23) 735 i 09.1982/09.1986 160KW 218CV 3430CC M30 B34 (346EC) 0005413 - BMW 7 (E23) 735 i 05.1984/09.1986 136KW 1...</p> <p>65x65x13mm 4f-d8mm</p>		<p><b>F0469-I</b> NO. 16110170470102 - 16410.17047.01.02 - 16410170470106 - 60507865 - 60805170 - 60811991 - 799610 - 9994</p> <p><b>FOLE DA TRANSMISSÃO LADO DA CAIXA</b></p> <p>BMW 7 (E23): 728 05.1977/08.1979 125KW 170CV 2788CC - BMW 7 (E23): 728 i 09.1977/08.1986 135KW 184CV 2788CC - BMW 7 (E23): 733 05.1977/08.1986 145KW 197CV 3210CC</p> <p>d85x80mm 1f-d61mm 1f-d23mm</p>
	<p><b>F1650A-I</b> NO. 33211209551 - 33211229221 - 33219067815 - 33219067906</p> <p><b>FOLE DA TRANSMISSÃO JUNTO À CAIXA</b></p> <p>BMW SÉRIE 7(E23) 2.5i 24V - 3.0i 730i/II - 3.0i 730i/II V8 - 3.2i 732i/733i - 3.2i 745i - 3.4i 735i - 3.4i 735i/iL - 3.4i 745i - 4.0i 740i/iL V8 (1977 A 1986)</p> <p>d110x125mm 1f-d108mm 1f-d25mm</p>		<p><b>F1800-I</b> NO. 33211226033 - 33211226719 - 33211229205 - 33217504703 - 33219067809 - 33219067814 - 33219067895 - 799610 - 9994</p> <p><b>FOLE TRANSMISSÃO JUNTO A CAIXA FALANGE D105MM</b></p> <p>BMW SÉRIE 7(E23) 2.8 728 - 2.8i 728i-iL - 3.0i 730i-iL - 3.0i 730i-iL V8 - 3.2i 732i-733i - 3.4i 735i - 3.4i 745i - 3.5i 735i-iL - 4.4i 740i-iL (77 A 86)</p> <p>d102x94mm 1f-d100mm 1f-d22mm</p>
	<p><b>KUR21999</b> NO. 1f-d24mm 1f-d10mm 1f-d10mm 1f-d19mm</p> <p><b>KIT DE REPARAÇÃO ALAVANCA DE VELOCIDADES</b></p> <p>BMW 7 (E23) 728 (De 05.1977 Até 08.1979) 125kW 170cv 2788cm3 Coupé - BMW 7 (E23) 728 i (De 09.1977 Até 08.1986) 135kW 184cv 2788cm3 Coupé - BMW 7 (E23) 732 i (De 09.1979 Até 08.1986) 145kW 197cv 3210cm3 Coupé - BMW 7 (E23) 733 i (De 05.1977 Até 08.1986) 145kW 197cv 3210cm3 Coupé - BMW 7 (E23) 735 i (De 05.1984 Até 09.1986) 136kW 185cv 3430cm3 três volumes - BMW 7 (E23) 735 i (De 04.1985 Até 08.198...</p> <p>d37x18mm d19x25mm d17x22mm d31x210mm d31x20mm d41x19x6</p>		<p><b>M6017</b> NO. 18111175311 - 18111245489 - 18111245840 - 18111245960 - 18114690146</p> <p><b>JUNTA DE ESCAPE</b></p> <p>BMW SERIE 7 (E23)</p> <p>.d56.5x10mm 1f-d44mm</p>
	<p><b>M6028</b> NO. 18111175311</p> <p><b>JUNTA DE ESCAPE</b></p> <p>BMW 7 (E23)</p> <p>d57x10mm 1f-d47mm</p>		<p><b>M6032</b> NO. 18111245500 - 18111728363 - 18114690142 - 18114790110</p> <p><b>JUNTA DE ESCAPE</b></p> <p>BMW E23 732i - 733i - 735i</p> <p>110x80mm 2f-d40mm</p>
	<p><b>M6059</b> NO. 1176127954 - 11761711717 - 18301723885</p> <p><b>JUNTA DE ESCAPE</b></p> <p>BMW E23 735i KAT</p> <p>77x85mm 1f-d46mm</p>		<p><b>N0500</b> NO. 18211105635 - 18211105638 - 18211105677 - 18211177708 - 18211728332 - 18214490159 - 1824490159</p> <p><b>ANEL DE SUPORTE DE ESCAPE</b></p> <p>BMW SERIE 7 (E23)</p> <p>65x18mm</p>
	<p><b>N2001</b> NO. 4387294 - RF138115514A - SE138115514A</p> <p><b>ANEL DE ESCAPE TRÁS</b></p> <p>BMW E23 728 - 730 - 733i</p> <p>d70x14mm 1f-d46mm</p>		<p><b>N2004</b> NO. 18211176424 - 18211245985 - 18211712838</p> <p><b>ANEL DE ESCAPE</b></p> <p>BMW E23 728 - 745i</p> <p>d78x39mm 1f-d43mm</p>

## BMW SERIE 7(E23)

Rafri, Lda.

	<p><b>R220053</b> NO. 11531250387 - 11531266459</p> <p><b>TUBO DE LIGAÇÃO TERMOSTATO Á BOMBA DE ÁGUA</b></p> <p>BMW 7 (E23) 728 05.1977/08.1979 125KW 170CV 2788CC M30 B28 0005397 - BMW 7 (E23) 728 i 09.1977/08.1986 135KW 184CV 2788CC M30 B28 0005412 - BMW 7 (E23) 730 05.1977/08.1979 135KW 184CV 2986CC M30 B30 0005398 - BMW 7 (E23) 733 i 05.1977/08.1986 145KW 197CV 3210CC M30 B32 0005399 - BMW 7 (E23) 735 i 09.1982/09.1986 160KW 218CV 3430CC M30 B34 (346EC) 0005413 - BMW 7 (E23) 735 i 05.1984/09.1986 136KW 1...</p> <p>B113-d39/d39mm 45-50mm</p>		<p><b>T0621-I</b> NO. 31331124449 - 31331124573 - 31331125215</p> <p><b>BATENTE SUSPENSÃO FRENTE</b></p> <p>BMW 7 (E23) 728 (05.77 A 08.79) 170cv 2788cc três volumes - BMW 7 (E23) 728 i (07.78 A 08.86) 184cv 2788cc três volumes - BMW 7 (E23) 730 (5.77 A 08.79) 184cv 2986cc três volumes - BMW 7 (E23) 733 i (05.77 A 08.86) 197cv 3210cc três volumes - BMW 7 (E23) 735 i (01.85 A 08.86) 185cv 3430cc três volumes - BMW 7 (E23) 735 i (04.85 A 08.86) 192cv 3430cc três volumes - BMW 7 (E23) 735 i (09.79 A ...</p> <p>d59x85mm 1f-d26mm 1f-d18mm</p>
	<p><b>U7033K</b> NO. 61671378609 - 64500149356 - 64500301636 - 64501363572 - 64501466019 - 64501468463 - 64508390601</p> <p><b>ORINGS BOMBA DIREÇÃO ASSITIDA</b></p> <p>BMW 7 (E23) 735 i (05.1984 - 09.1986) 136kw 185cv 3430cm3 três volumes BMW 7 (E23) 735 i (04.1985 - 08.1986) 141kw 192cv 3430cm3 três volumes BMW 7 (E23) 735 i (09.1982 - 09.1986) 160kw 218cv 3430cm3 três volumes BMW 7 (E23) 745 i (04.1980 - 04.1983) 185kw 252cv 3210cm3 três volumes BMW 7 (E23) 745 i (05.1983 - 08.1986) 185kw 252cv 3430cm3 três volumes</p> <p>d11x2mm d10x2mm 1f-d7mm 1f-d6mm</p>		<p><b>UCRZ1054</b> NO. 32311092958 - 32311150489</p> <p><b>CRUZETA VEIO DIREÇÃO D15X40MM</b></p> <p>BMW 7 (E23) 735 i (De 05.1984 Até 09.1986) 136kW 185cv 3430cm3 três volumes - BMW 7 (E23) 735 i (De 04.1985 Até 08.1986) 141kW 192cv 3430cm3 três volumes - BMW 7 (E23) 735 i (De 09.1982 Até 09.1986) 160kW 218cv 3430cm3 três volumes -</p> <p>d15x28x40mm</p>
	<p><b>UCRZ1093</b> NO. 26111105398 - 26117518304 - 26203401609 - 26207526677</p> <p><b>CRUZETA DO VEIO TRANSMISSÃO LONGITUDINAL</b></p> <p>BMW 7 (E23) 735 i (De 05.1984 Até 09.1986) 136kW 185cv 3430cm3 três volumes - BMW 7 (E23) 735 i (De 04.1985 Até 08.1986) 141kW 192cv 3430cm3 três volumes - BMW 7 (E23) 735 i (De 09.1982 Até 09.1986) 160kW 218cv 3430cm3 três volumes - BMW 7 (E23) 745 i (De 04.1980 Até 04.1983) 185kW 252cv 3210cm3 três volumes - BMW 7 (E23) 745 i (De 04.1980 Até 04.1983) 185kW 252cv 3210cm3 três volumes - BMW 7 (E23)...</p> <p>d24x63mm 43mm</p>		<p><b>UMB84029</b> NO. 07119937320 - 11111276472 - 11111717939 - 1717939 - 9937321</p> <p><b>TAMPÃO BLOCO MOTOR</b></p> <p>BMW 7 (E23) 728 (De 05-1977 Até 08-1979) 125kW 170CV 2788cc três volumes BMW 7 (E23) 728 i (De 09-1977 Até 08-1986) 135kW 184CV 2788cc três volumes BMW 7 (E23) 730 (De 05-1977 Até 08-1979) 135kW 184CV 2986cc três volumes BMW 7 (E23) 733 i (De 05-1977 Até 08-1986) 145kW 197CV 3210cc três volumes BMW 7 (E23) 735 i (De 05-1984 Até 09-1986) 136kW 185CV 3430cc três volumes BMW 7 (E23) 735 i (De 04-1985...</p> <p>d36x10mm di-32mm</p>
	<p><b>UMB84038</b> NO. 07119937331 - 11111276473 - 11111714712</p> <p><b>TAMPÃO BLOCO MOTOR</b></p> <p>BMW 7 (E23) 728 (05.77 A 08.79) 170cv 2788cc três volumes - BMW 7 (E23) 728 i (07.78 A 08.86) 184cv 2788cc três volumes - BMW 7 (E23) 730 (05.77 A 08.79) 184cv 2986cc três volumes - BMW 7 (E23) 733 i (05.77 A 08.86) 197cv 3210cc três volumes - BMW 7 (E23) 735 i (01.85 A 08.86) 185cv 3430cc três volumes - BMW 7 (E23) 735 i (04.85 A 08.86) 192cv 3430cc três volumes - BMW 7 (E23) 735 i (0...</p> <p>d-45x12,1mm di-42mm</p>		<p><b>UTR0631</b> NO. 17111100848 - 17111102672 - 17111120062</p> <p><b>TAMPÃO RADIADOR</b></p> <p>BMW 7 (E23): 725 i 07.1977/06.1986 110KW 150CV 2494CC - BMW 7 (E23): 728 05.1977/08.1979 125KW 170CV 2788CC - RENAULT 7 (E23): 728 i 09.1977/08.1986 135KW 184CV 2788CC - BMW 7 (E23): 730 05.1977/08.1979 135KW 184CV 2986CC - BMW 7 (E23): 733 i 05.1977/08.1986 145KW 197CV 3210CC - BMW 7 (E23): 735 i 05.1984/09.1986 136KW 185CV 3430CC - BMW 7 (E23): 735 i 04.1985/08.1986 141KW 192CV 3430CC - BMW 7 (E...</p> <p>d59/79x29mm d38x26mm</p>
	<p><b>UTR0812</b> NO. 17110152374 - 17111468076 - 17111712492 - 17111712669 - 17111742231 - 17117639022 - 17119071581</p> <p><b>TAMPÃO RESERVATÓRIO LÍQUIDO REFRIGERAÇÃO</b></p> <p>BMW 7 (E23) 735 i (01.85 A 08.86) 185cv 3430cc três volumes - BMW 7 (E23) 735 i (04.85 A 08.86) 192cv 3430cc três volumes - BMW 7 (E23) 730 i,iL (12.86 A 09.94) 188cv 2986cc três volumes - BMW 7 (E23) 730 i,iL (12.86 A 09.94) 197cv 2986cc três volumes - BMW 7 (E23) 730 i,iL V 8 (04.92 A 09.94) 218cv 2997cc três volumes - BMW 7 (E23) 735 i,iL (09.86 A 09.92) 211cv 3430cc três volume...</p> <p>d65x45mm 1f-d52x20mm</p>		<p><b>Y3239</b> NO. 36130141574 - 36130141576 - 36131095390 - 36131116717 - 36131117190 - 36131126191</p> <p><b>PARAFUSO PERNO RODA CHAVE 17 M12X1,50X50MM ( BASE CONICA )</b></p> <p>BMW 7 (E23) 728 05.1977/08.1979 125KW 170CV 2788CC M30 B28 0005397 - BMW 7 (E23) 728 i 09.1977/08.1986 135KW 184CV 2788CC M30 B28 0005412 - BMW 7 (E23) 730 05.1977/08.1979 135KW 184CV 2986CC M30 B30 0005398 - BMW 7 (E23) 733 i 05.1977/08.1986 145KW 197CV 3210CC M30 B32 0005399 - BMW 7 (E23) 735 i 09.1982/09.1986 160KW 218CV 3430CC M30 B34 (346EC) 0005413 - BMW 7 (E23) 735 i 05.1984/09.1986 136KW 1...</p> <p>c51mm (ch-17mm) M12x1x24mm</p>
	<p><b>Z86003</b> NO. 51711932996</p> <p><b>MOLAS FIXAÇÃO MOLDURA PORTAS</b></p> <p>BMW 7 (E23) 730 i, iL 03.1985/01.1989 145KW 197CV 2986CC M30 B30 (306EA) 0005463 - BMW 7 (E23) 730 i, iL 03.1987/03.1994 138KW 188CV 2986CC M30 B30 (306KA) 0005465 - BMW 7 (E23) 730 i, iL V8 04.1992/09.1994 160KW 218CV 2997CC M60 B30 (308S1) 0005524 - BMW 7 (E23) 735 i, iL 06.1986/07.1992 155KW 211CV 3430CC M30 B34 (346KB) 0005457 - BMW 7 (E23) 735 i, iL 07.1986/01.1989 162KW 220CV 3430CC M30 ...</p> <p>F-4G- mm T-12L-8H-7S-1mm</p>		

## BMW SERIE 7(E32)

	<p><b>A0948</b> NO. 26111206502 - 26121104355 - A26111206502</p> <p><b>APOIO SUPORTE CENTRAL DA TRANSMISSÃO COM ROLAMENTO</b></p> <p>BMW 7 (E32) 735 i, iL 07.1986/01.1989 162KW 220CV 3430CC M30 B35 (Motronic,9.2:1) 0005456</p> <p>155x101x42mm d30mm</p>		<p><b>A1746</b> NO. 22311094916 - 22316771221 - 23711131664</p> <p><b>APOIO DA CAIXA DE VELOCIDADES PARTE DE TRÁS</b></p> <p>BMW 7 (E32) 730 i, iL 03.1985/01.1989 145KW 197CV 2986CC M30 B30 (306EA) 0005463 - BMW 7 (E32) 730 i, iL 03.1987/03.1994 138KW 188CV 2986CC M30 B30 (306KA) 0005465 - BMW 7 (E32) 735 i, iL 06.1986/07.1992 155KW 211CV 3430CC M30 B34 (346KB) 0005457 - BMW 7 (E32) 735 i, iL 07.1986/01.1989 162KW 220CV 3430CC M30 B35 (Motronic,9.2:1) 0005456</p> <p>d50x34mm 2p-d8-17/19mm</p>
--	--	--	---



	<p><b>D0022</b> NO. 26111209168 - 26111227420 - 26111227717 - 26111229080 - 26111229360 - 261117511454</p> <p>CARDAN TRANSMISSÃO D135X30MM 6 FUROS 12MM ENTRE FUROS 96MM</p> <p>BMW 7 (E32) 730 i, iL 03.1985/01.1989 145KW 197CV 2986CC M30 B30 (306EA) 0005463 - BMW 7 (E32) 730 i, iL 03.1987/03.1994 138KW 188CV 2986CC M30 B30 (306KA) 0005465 - BMW 7 (E32) 730 i, iL V8 04.1992/09.1994 160KW 218CV 2997CC M60 B30 (308S1) 0005524 - BMW 7 (E32) 735 i, iL 06.1986/07.1992 155KW 211CV 3430CC M30 B34 (346KB) 0005457 - BMW 7 (E32) 735 i, iL 07.1986/01.1989 162KW 220CV 3430CC M30...</p> <p>d132x123x30mm 6f-d12mm</p>		<p><b>D0031</b> NO. 26111229065 - 26111277690</p> <p>CARDAN TRANSMISSÃO D140X38MM 6 FUROS 14MM ENTRE FUROS 105MM</p> <p>BMW 7 (E32) 740 i, iL V8 05.1992/03.1994 210KW 286CV 3982CC M60 B40 (408S1) 0005525 - BMW 7 (E38) 740 i, iL 03.1994/02.1996 210KW 286CV 3982CC M60 B40 (408S1) 0005544 - BMW 7 (E38) 740 i, iL 02.1996/07.2001 210KW 286CV 4398CC M62 B44 (448S2) M62 B44 (448S1) 0005652 0005585 - BMW 7 (E38) 750 i, iL 11.1994/07.2001 240KW 326CV 5379CC M73 B54 (54121) M73 B54 (54122) 0005546 0005583</p> <p>d140x38mm 1f-d52mm 6f-d14mm</p>
	<p><b>D0060</b> NO. 32311115090 - 32311115092</p> <p>CARDAN COLUNA DIREÇÃO</p> <p>BMW 7 (E32) 730 i, iL 03.1985/01.1989 145KW 197CV 2986CC M30 B30 (306EA) 0005463 - BMW 7 (E32) 730 i, iL 03.1987/03.1994 138KW 188CV 2986CC M30 B30 (306KA) 0005465 - BMW 7 (E32) 730 i, iL V8 04.1992/09.1994 160KW 218CV 2997CC M60 B30 (308S1) 0005524 - BMW 7 (E32) 735 i, iL 06.1986/07.1992 155KW 211CV 3430CC M30 B34 (346KB) 0005457 - BMW 7 (E32) 735 i, iL 07.1986/01.1989 162KW 220CV 3430CC M30 B3...</p> <p>65x65x13mm 4f-d8mm</p>		<p><b>F1650A-I</b> NO. 33211209551 - 33211229221 - 332119067815 - 33219067906</p> <p>FOLE DA TRANSMISSÃO JUNTO À CAIXA</p> <p>BMW SÉRIE 7(E32) 3.0i - 3.4i - 4.0i (1986 A 1994)</p> <p>d110x125mm 1f-d108mm 1f-d25mm</p>
	<p><b>F1800-I</b> NO. 33211226033 - 33211226719 - 33211229205 - 332117504703 - 33219067809 - 33219067814 - 33219067895 -</p> <p>FOLE TRANSMISSÃO JUNTO A CAIXA FALANGE D105MM</p> <p>BMW SÉRIE 7 (E32) 3.0i 730i-iL - 3.0i 730i-iL V8 (1986 A 1994)</p> <p>d102x94mm 1f-d100mm 1f-d22mm</p>		<p><b>F4345</b> NO. 33211226033 - 33211226264 - 33211229221 - 3321129376 - 332117504704 - 33219067813 - 33219067815</p> <p>FOLE TRANSMISSÃO JUNTO A RODA ( GASTA 2 UNIDADES )</p> <p>BMW 7 (E32) 730 i, iL 03.1985/01.1989 145KW 197CV 2986CC M30 B30 (306EA) 0005463 - BMW 7 (E32) 730 i, iL 03.1987/03.1994 138KW 188CV 2986CC M30 B30 (306KA) 0005465 - BMW 7 (E32) 730 i, iL V8 04.1992/09.1994 160KW 218CV 2997CC M60 B30 (308S1) 0005524</p> <p>d81x79mm 1f-d22mm-1f-d52mm</p>
	<p><b>KT0621-I</b> NO. 31331124449 - 31331137932</p> <p>KIT BATENTE SUSPENSÃO DA FRENTE</p> <p>BMW 7 (E32) 735 i - iL (De 09-1986 Até 09-1992) 155kW 211CV 3430cc três volumes BMW 7 (E32) 735 i - iL (De 09-1986 Até 12-1987) 162kW 220CV 3430cc três volumes BMW 7 (E38) 735 i - iL (De 01-1996 Até 12-1998) 173kW 235CV 3498cc três volumes</p> <p>d73x145mm 1f-d68mm 1f-d19mm</p>		<p><b>KUR21999</b> NO. 1f-d24mm 1f-d10mm 1f-d10mm 1f-d19m</p> <p>KIT DE REPARAÇÃO ALAVANCA DE VELOCIDADES</p> <p>BMW 7 (E32) 730 i,iL (De 03.1987 Até 03.1994) 138kW 188cv 2986cm3 três volumes - BMW 7 (E32) 730 i,iL (De 03.1985 Até 01.1989) 145KW 197cv 2986cm3 três volumes - BMW 7 (E32) 730 i,iL V8 (De 04.1992 Até 09.1994) 160kW 218cv 2997cm3 três volumes - BMW 7 (E32) 735 i,iL (De 06.1986 Até 07.1992) 155kW 211cv 3430cm3 três volumes - BMW 7 (E32) 735 i,iL (De 07.1986 Até 01.1989) 162kW 220cv 3430cm3 três vo...</p> <p>d37x18mm d19x25mm d19x25mm d19x25mm d19x25mm d19x25mm d19x25mm</p>
	<p><b>M6009</b> NO. 18111245429 - 18111719313</p> <p>JUNTA DE ESCAPE</p> <p>BMW E32 735i</p> <p>d86x5mm 1f-d78mm</p>		<p><b>M6028</b> NO. 18111175311</p> <p>JUNTA DE ESCAPE</p> <p>BMW 7 (E32)</p> <p>d57x10mm 1f-d47mm</p>
	<p><b>M6059</b> NO. 11761277954 - 11761711717 - 18301723885</p> <p>JUNTA DE ESCAPE</p> <p>BMW E32 750i</p> <p>77x85mm 1f-d46mm</p>		<p><b>N0500</b> NO. 18211105635 - 18211105638 - 18211105677 - 18211177708 - 18211728332 - 18214490159 - 1824490159</p> <p>ANEL DE SUPORTE DE ESCAPE</p> <p>BMW SERIE 7 (E32)</p> <p>65x18mm</p>
	<p><b>P1042</b> NO. 35211160422</p> <p>CAPA DE PEDAL</p> <p>BMW 7 (E32) 730 i, iL V8 04.1992/09.1994 160KW 218CV 2997CC M60 B30 (308S1) 0005524</p> <p>75x65x40mm</p>		<p><b>P1055</b> NO. 35211160421</p> <p>CAPA DE PEDAL DO TRAVÃO(VEICULOS COM CAIXA AUTOMÁTICA)</p> <p>BMW 7 (E32) 730 i, iL 03.1985/01.1989 145KW 197CV 2986CC M30 B30 (306EA) 0005463 - BMW 7 (E32) 730 i, iL 03.1987/03.1994 138KW 188CV 2986CC M30 B30 (306KA) 0005465 - BMW 7 (E32) 730 i, iL V8 04.1992/09.1994 160KW 218CV 2997CC M60 B30 (308S1) 0005524 - BMW 7 (E32) 735 i, iL 06.1986/07.1992 155KW 211CV 3430CC M30 B34 (346KB) 0005457 - BMW 7 (E32) 735 i, iL 07.1986/01.1989 162KW 220CV 3430CC M30 ...</p> <p>74x107x42mm</p>
	<p><b>P1059</b> NO. 1 108 634 - 35211108634</p> <p>CAPA DE PEDAL DO TRAVÃO</p> <p>BMW SÉRIE 7 (E32) 730i - 735i (09-1986 A 09-1994)</p> <p>75x62x12mm</p>		<p><b>R021812</b> NO. 13311288284</p> <p>TUBO DE LIGAÇÃO DO CARBURADOR AO COLECTOR</p> <p>BMW 7 (E32): 730 i,iL 03.1987/03.1994 138KW 188CV 2986CC - BMW 7 (E32): 730 i,iL 03.1985/01.1989 145KW 197CV 2986CC - BMW 7 (E32): 735 i,iL 06.1986/07.1992 155KW 211CV 3430CC - BMW 7 (E32): 735 i,iL 07.1986/01.1989 162KW 220CV 3430CC - BMW 7 (E32): 740 i,iL V8 05.1992/03.1994 210KW 286CV 3982CC - BMW 7 (E32): 750 i,iL V12 09.1987/09.1994 220KW 300CV 4988CC</p> <p>B245-d77mm 235-65mm</p>

	<p><b>R021925</b> NO. 13311288284</p> <p><b>TUBO DE LIGAÇÃO DO CARBURADOR AO COLECTOR</b></p> <p>BMW 7 (E32): 730 i,IL 03.1987/03.1994 138KW 188CV 2986CC - BMW 7 (E32): 730 i,IL 03.1985/01.1989 145KW 197CV 2986CC - BMW 7 (E32): 735 i,IL 06.1986/07.1992 155KW 211CV 3430CC - BMW 7 (E32): 735 i,IL 07.1986/01.1989 162KW 220CV 3430CC - BMW 7 (E32): 740 i,IL V8 05.1992/03.1994 210KW 286CV 3982CC - BMW 7 (E32): 750 i,IL V12 09.1987/09.1994 220KW 300CV 4988CC</p> <p>B230-7/7mm 205x55mm</p>		<p><b>R220053</b> NO. 11531250387 - 11531266459</p> <p><b>TUBO DE LIGAÇÃO TERMOSTATO À BOMBA DE ÁGUA</b></p> <p>BMW 7 (E32) 730 i, IL 03.1985/01.1989 145KW 197CV 2986CC M30 B30 (306EA) 0005463 - BMW 7 (E32) 730 i, IL 03.1987/03.1994 138KW 188CV 2986CC M30 B30 (306KA) 0005465 - BMW 7 (E32) 735 i, IL 06.1986/07.1992 155KW 211CV 3430CC M30 B34 (346KB) 0005457 - BMW 7 (E32) 735 i, IL 07.1986/01.1989 162KW 220CV 3430CC M30 B35 (Motronic,9.2.1) 0005456</p> <p>B113-d39/d39mm 45-50mm</p>
	<p><b>S1271</b> NO. 31106770699 - 31106770699 - 31121092019 - 31121094235 - 31121122462 - 31121124622 - 31121133236 - 31121133236</p> <p><b>SILENT-BLOC DO BRAÇO DA SUSPENSÃO (FRENTE CENTRO)</b></p> <p>BMW 7 (E32) 730 i, IL 03.1985/01.1989 145KW 197CV 2986CC M30 B30 (306EA) 0005463 - BMW 7 (E32) 730 i, IL 03.1987/03.1994 138KW 188CV 2986CC M30 B30 (306KA) 0005465 - BMW 7 (E32) 730 i, IL V8 04.1992/09.1994 160KW 218CV 2997CC M60 B30 (308S1) 0005524 - BMW 7 (E32) 735 i, IL 06.1986/07.1992 155KW 211CV 3430CC M30 B34 (346KB) 0005457 - BMW 7 (E32) 735 i, IL 07.1986/01.1989 162KW 220CV 3430CC M30 ...</p> <p>d46x52mm c40mm 1f-d12mm</p>		<p><b>T0621-I</b> NO. 31331124449 - 31331124573 - 31331125215</p> <p><b>BATENTE SUSPENSÃO FRENTE</b></p> <p>BMW 7 (E32) 730 i-IL (12.86 A 09.94) 188cv 2986cc três volumes - BMW 7 (E32) 730 i-IL V8 (04.92 A 09.94) 218cv 2997cc três volumes - BMW 7 (E32) 735 i-IL (09.86 A 09.92) 211cv 3430cc três volumes - BMW 7 (E32) 735 i-IL (09.86 A 12.87) 220cv 3430cc três volumes - BMW 7 (E32) 740 i-IL V8 (04.92 A 09.94) 286cv 3982cc três volumes - BMW 7 (E32) 750 i-IL V12 (09.87 A 09.94) 300cv 4988cc três volu...</p> <p>d59x85mm 1f-d26mm 1f-d18mm</p>
	<p><b>U7033K</b> NO. 61671378609 - 64500149356 - 64500301636 - 64501363572 - 64501466019 - 64501468463 - 64508390601</p> <p><b>ORINGS BOMBA DIREÇÃO ASSISTIDA</b></p> <p>BMW 7 (E32) 730 i, IL (03.1987 - 03.1994) 138kw 188cv 2986cm3 três volumes BMW 7 (E32) 730 i, IL (03.1985 - 01.1989) 145kw 197cv 2986cm3 três volumes BMW 7 (E32) 730 i, IL (04.1992 - 09.1994) 160kw 218cv 2997cm3 três volumes BMW 7 (E32) 735 i, IL (06.1986 - 07.1992) 155kw 211cv 3430cm3 três volumes BMW 7 (E32) 735 i, IL (07.1986 - 01.1989) 162kw 220cv 3430cm3 três volumes BMW 7 (E32) 740 i, IL...</p> <p>d11x2mm d10x2mm 1f-d7mm 1f-d6mm</p>		<p><b>UCRZ1054</b> NO. 32311092958 - 32311150489</p> <p><b>CRUZETA VEIO DIREÇÃO D15X40MM</b></p> <p>BMW 7 (E32) 730 i,IL (De 03.1987 Até 03.1994) 138kw 188cv 2986cm3 três volumes - BMW 7 (E32) 730 i,IL (De 03.1985 Até 01.1989) 145KW 197cv 2986cm3 três volumes - BMW 7 (E32) 735 i,IL (De 06.1986 Até 07.1992) 155KW 211cv 3430cm3 três volumes - BMW 7 (E32) 735 i,IL (De 07.1986 Até 01.1989) 162KW 220cv 3430cm3 três volumes -</p> <p>d15x28x40mm</p>
	<p><b>UCRZ1093</b> NO. 26111105398 - 26117518304 - 26203401609 - 26207526677</p> <p><b>CRUZETA DO VEIO TRANSMISSÃO LONGITUDINAL</b></p> <p>BMW 7 (E32) 730 i, IL (De 03.1987 Até 03.1994) 138kW 188cv 2986cm3 três volumes - BMW 7 (E32) 730 i, IL (De 03.1987 Até 03.1994) 138kW 188cv 2986cm3 três volumes - BMW 7 (E32) 730 i, IL (De 03.1985 Até 01.1989) 145kW 197cv 2986cm3 três volumes - BMW 7 (E32) 730 i, IL (De 03.1985 Até 01.1989) 145kW 197cv 2986cm3 três volumes - BMW 7 (E32) 730 i, IL (De 03.1985 Até 01.1989) 145kW 197cv 2986cm3 três volumes - BMW 7 (E32) 735 i, IL (De 06.1986 Até 07.1992) 155kW 211cv 3430cm3 três volumes -</p> <p>d24x63mm 43mm</p>		<p><b>UMB84029</b> NO. 07119937320 - 11111276472 - 11111717939 - 1717939 - 9937321</p> <p><b>TAMPÃO BLOCO MOTOR</b></p> <p>BMW 7 (E32) 730 i - IL (De 12-1986 Até 09-1994) 138KW 188CV 2986cc três volumes BMW 7 (E32) 730 i - IL (De 12-1986 Até 09-1994) 145KW 197CV 2986cc três volumes BMW 7 (E32) 735 i - IL (De 09-1986 Até 09-1992) 155KW 211CV 3430cc três volumes BMW 7 (E32) 735 i - IL (De 09-1986 Até 12-1987) 162KW 220CV 3430cc três volumes</p> <p>d36x10mm di-32mm</p>
	<p><b>UMV25110</b> NO. 25111434495 - 25117500299 - 25117503231 - 25117523817 - 25117544524</p> <p><b>MANETE PUNHO TOPO ALAVANCA MUDANÇAS 5 VELOCIDADES NAPEL F14MM</b></p> <p>BMW 7 (E32): 730 i,IL V8 04.1992/09.1994 160KW 218CV 2997CC</p> <p>d51x91mm 1f-d14mm</p>		<p><b>UMV25114</b> NO. 25111434495 - 25117500299 - 25117503231 - 25117523817 - 25117544524</p> <p><b>MANETE PUNHO TOPO ALAVANCA MUDANÇAS 5 VELOCIDADES F14MM</b></p> <p>BMW 7 (E32): 730 i,IL V8 04.1992/09.1994 160KW 218CV 2997CC</p> <p>d56x94mm 1f-d14mm</p>
	<p><b>Y3239</b> NO. 36130141574 - 36130141576 - 36131095390 - 36131116717 - 36131117190 - 36131126191</p> <p><b>PARAFUSO PERNO RODA CHAVE 17 M12X1,50X50MM ( BASE CONICA )</b></p> <p>BMW 7 (E32) 730 i, IL 03.1985/01.1989 145KW 197CV 2986CC M30 B30 (306EA) 0005463 - BMW 7 (E32) 730 i, IL 03.1987/03.1994 138KW 188CV 2986CC M30 B30 (306KA) 0005465 - BMW 7 (E32) 730 i, IL V8 04.1992/09.1994 160KW 218CV 2997CC M60 B30 (308S1) 0005524 - BMW 7 (E32) 735 i, IL 06.1986/07.1992 155KW 211CV 3430CC M30 B34 (346KB) 0005457 - BMW 7 (E32) 735 i, IL 07.1986/01.1989 162KW 220CV 3430CC M30 ...</p> <p>c51mm (ch-17mm) M12x1x24mm</p>		<p><b>Z80834</b> NO. 51321938884</p> <p><b>MOLA DE FIXAÇÃO</b></p> <p>BMW 7 (E32): 730 i,IL 03.1987/03.1994 138KW 188CV 2986CC - BMW 7 (E32): 730 i,IL 03.1985/01.1989 145KW 197CV 2986CC - BMW 7 (E32): 730 i,IL V8 04.1992/09.1994 160KW 218CV 2997CC - BMW 7 (E32): 735 i,IL 06.1986/07.1992 155KW 211CV 3430CC - BMW 7 (E32): 735 i,IL 07.1986/01.1989 162KW 220CV 3430CC - BMW 7 (E32): 740 i,IL V8 05.1992/03.1994 210KW 286CV 3982CC - BMW 7 (E32): 750 i,IL V12 09.1987/09.1994...</p> <p>37x29x12,2mm</p>

## BMW SERIE 7(E38)

	<p><b>A1746</b> NO. 22311094916 - 22316771221 - 23711131664</p> <p><b>APOIO DA CAIXA DE VELOCIDADES PARTE DE TRÁS</b></p> <p>BMW 7 (E38) 725 tds 04.1996/11.2001 105KW 143CV 2497CC M51 D25 (256T1) 0005589 - BMW 7 (E38) 730 d 08.1998/04.2000 135KW 184CV 2926CC M57 D30 (306D1) 0005635 - BMW 7 (E38) 730 d 04.2000/11.2001 142KW 193CV 2926CC M57 D30 (306D1) 0005677 - BMW 7 (E38) 730 i, IL 03.1994/02.1996 160KW 218CV 2997CC M60 B30 (308S1) 0005543 - BMW 7 (E38) 730 i, IL 10.1994/11.2001 155KW 211CV 2997CC M60 B30 (308S1) 0005543 - BMW 7 (E38) 730 i, IL 10.1994/11.2001 155KW 211CV 2997CC M60 B30 (308S1) 0005543 - BMW 7 (E38) 730 i, IL 03.1996/08.1998 173KW 235CV 3498CC M62 B35 (358S1) 0005584</p> <p>d50x34mm 2p-d8-17/19mm</p>		<p><b>D0022</b> NO. 26111209168 - 26111227420 - 26111227717 - 26111229080 - 26111229360 - 26117511454</p> <p><b>CARDAN TRANSMISSÃO D135X30MM 6 FUROS 12MM ENTRE FUROS 96MM</b></p> <p>BMW 7 (E38) 728 i, IL 08.1995/11.2001 142KW 193CV 2793CC M52 B28 (286S2) M52 B28 (286S1) 0005564 - BMW 7 (E38) 730 i, IL 03.1994/02.1996 160KW 218CV 2997CC M60 B30 (308S1) 0005543 - BMW 7 (E38) 730 i, IL 10.1994/11.2001 155KW 211CV 2997CC M60 B30 (308S1) 0005542 - BMW 7 (E38) 735 i, IL 03.1996/08.1998 173KW 235CV 3498CC M62 B35 (358S1) 0005584</p> <p>d132x123x30mm 6f-d12mm</p>
--	---	---	---



	<p><b>D0030</b> NO. 26111229754 - 26117572664</p> <p>CARDAN TRANSMISSÃO D162X42MM 6 FUROS 12MM ENTRE FUROS 110MM</p> <p>BMW 7 (E38) 730 d 08.1998/04.2000 135KW 184CV 2926CC M57 D30 (306D1) 0005635 - BMW 7 (E38) 730 d 04.2000/11.2001 142KW 193CV 2926CC M57 D30 (306D1) 0005677 - BMW 7 (E38) 740 d 05.1999/11.2001 180KW 245CV 3901CC M67 D39 (398D1) 0005666 0005636 - BMW 7 (E65, E66, E67) 730 d 06.2002/02.005 160KW 218CV 2993CC M57 D30 (306D2) 0005746 - BMW 7 (E65, E66, E67) 730 i, Li 03.2003/07.2008 170KW 231CV 2979CC...</p> <p>d160x42mm 1f-d45mm 6f-d12mm</p>		<p><b>F1641A-I</b> NO. 33211229209 - 33211229378 - 33217504705 - 33219067805</p> <p>FOLE DA TRANSMISSÃO JUNTO À CAIXA</p> <p>BMW 7 (E38) 728 i, iL 08.1995/11.2001 142KW 193CV 2793CC M52 B28 (286S2) M52 B28 (286S1) 0005564 - BMW 7 (E38) 730 i, iL 03.1994/02.1996 160KW 218CV 2997CC M60 B30 (308S1) 0005543 - BMW 7 (E38) 730 i, iL 10.1994/11.2001 155KW 211CV 2997CC M60 B30 (308S1) 0005542 - BMW 7 (E38) 740 i, iL 03.1994/02.1996 210KW 286CV 3982CC M60 B40 (408S1) 0005544 - BMW 7 (E38) 740 i, iL 02.1996/07.2001 210KW 286CV 43...</p> <p>d110x92mm 1f-d106mm 1f-d25mm</p>
	<p><b>F1800-I</b> NO. 33211226033 - 33211226719 - 33211229205 - 33217504703 - 33219067809 - 33219067814 - 33219067895 -</p> <p>FOLE TRANSMISSÃO JUNTO A CAIXA FALANGE D105MM</p> <p>BMW SÉRIE 7 (E38) 2.8i 728i-iL - 3.0i 730i-iL - 3.5i 735i-iL - 4.4i 740i-iL V8</p> <p>d102x94mm 1f-d100mm 1f-d22mm</p>		<p><b>F4345</b> NO. 33211226033 - 33211226264 - 33211229221 - 3321129376 - 33217504704 - 33219067813 - 33219067815</p> <p>FOLE TRANSMISSÃO JUNTO A RODA ( GASTA 2 UNIDADES )</p> <p>BMW 7 (E38) 725 tds 04.1996/11.2001 105KW 143CV 2497CC M51 D25 (256T1) 0005589 - BMW 7 (E38) 728 i, iL 08.1995/11.2001 142KW 193CV 2793CC M52 B28 (286S2) M52 B28 (286S1) 0005564 - BMW 7 (E38) 730 i, iL 03.1994/02.1996 160KW 218CV 2997CC M60 B30 (308S1) 0005543 - BMW 7 (E38) 730 i, iL 10.1994/11.2001 155KW 211CV 2997CC M60 B30 (308S1) 0005542 - BMW 7 (E38) 740 i, iL 03.1994/02.1996 210KW 286CV 3982CC M60 B40 (408S1) 0005544</p> <p>d81x79mm 1f-d22mm-1f-d52mm</p>
	<p><b>KUBT3023</b> NO. 1f-d39mm(x2) 1f-d48mm(x2) 1f-d5mm</p> <p>KIT BORRACHAS TRAVAÇO PINÇA TRAS BRENBO 40MM</p> <p>BMW 7 (E38) 725 tds 04.1996/11.2001 105KW 143CV 2497CC M51 D25 (256T1) 0005589 - BMW 7 (E38) 728 i, iL 08.1995/11.2001 142KW 193CV 2793CC M52 B28 (286S2) M52 B28 (286S1) 0005564 - BMW 7 (E38) 730 d 08.1998/04.2000 135KW 184CV 2926CC M57 D30 (306D1) 0005635 - BMW 7 (E38) 730 d 04.2000/11.2001 142KW 193CV 2926CC M57 D30 (306D1) 0005677 - BMW 7 (E38) 730 i, iL 03.1994/02.1996 160KW 218CV 2997CC M60 B...</p> <p>d59x12mm(x2) d54x3mm(x2) d35x11mm(x2) 1f-d48mm(x2) 1f-d5mm 1p</p>		<p><b>KUR21999</b> NO. 1f-d24mm 1f-d10mm 1f-d10mm 1f-d19m</p> <p>KIT DE REPARAÇÃO ALAVANCA DE VELOCIDADES</p> <p>BMW 7 (E38) 725 tds (De 04.1996 Até 11.2001) 105KW 143cv 2497cm3 três volumes - BMW 7 (E38) 728 i, iL (De 08.1995 Até 11.2001) 142KW 193cv 2793cm3 três volumes - BMW 7 (E38) 728i X (De 11.1995 Até 09.2001) 142KW 193cv 2793cm3 três volumes - BMW 7 (E38) 730 i, iL (De 10.1994 Até 11.2001) 155KW 211cv 2997cm3 três volumes - BMW 7 (E38) 730 i, iL (De 03.1994 Até 02.1996) 160KW 218cv 2997cm3 três volum...</p> <p>d37x18mm d19x25mm d17x24mm d31x210mm d31x210mm d14x19mm d14x19mm d14x19mm</p>
	<p><b>P1042</b> NO. 35211160422</p> <p>CAPA DE PEDAL</p> <p>BMW 7 (E38) 725 tds 04.1996/11.2001 105KW 143CV 2497CC M51 D25 (256T1) 0005589 - BMW 7 (E38) 728 i, iL 08.1995/11.2001 142KW 193CV 2793CC M52 B28 (286S2) M52 B28 (286S1) 0005564 - BMW 7 (E38) 730 i, iL 03.1994/02.1996 160KW 218CV 2997CC M60 B30 (308S1) 0005543 - BMW 7 (E38) 730 i, iL 10.1994/11.2001 155KW 211CV 2997CC M60 B30 (308S1) 0005542 - BMW 7 (E38) 735 i, iL 03.1996/08.1998 173KW 235CV 3498...</p> <p>75x65x40mm</p>		<p><b>P1055</b> NO. 35211160421</p> <p>CAPA DE PEDAL DO TRAVAÇO(VEÍCULOS COM CAIXA AUTOMÁTICA)</p> <p>BMW 7 (E38) 725 tds 04.1996/11.2001 105KW 143CV 2497CC M51 D25 (256T1) 0005589 - BMW 7 (E38) 728 i, iL 08.1995/11.2001 142KW 193CV 2793CC M52 B28 (286S2) M52 B28 (286S1) 0005564 - BMW 7 (E38) 730 d 08.1998/04.2000 135KW 184CV 2926CC M57 D30 (306D1) 0005635 - BMW 7 (E38) 730 d 04.2000/11.2001 142KW 193CV 2926CC M57 D30 (306D1) 0005677 - BMW 7 (E38) 730 i, iL 03.1994/02.1996 160KW 218CV 2997CC M60 B...</p> <p>74x107x42mm</p>
	<p><b>P1059</b> NO. 1 108 634 - 35211108634</p> <p>CAPA DE PEDAL DO TRAVAÇO</p> <p>BMW SÉRIE 7 (E38) 725TDS - 728i - 730i - 735i - 740i (10-1994 A 11-2001)</p> <p>75x62x12mm</p>		<p><b>R080024</b> NO. 48-56-36-225-27-41-19mm 1f-d6mm 1f</p> <p>TUBO RÍGIDO DE REFRIGERAÇÃO</p> <p>BMW 7 (E38) 728 i, iL 08.1995/11.2001 142KW 193CV 2793CC M52 B28 (286S2) M52 B28 (286S1) 0005564</p> <p>B475-14/17mm 48-56-36-225-27-41-19mm 1f-d6mm 1f-d6mm...</p>
	<p><b>R225953</b> NO. 13541435625</p> <p>TUBO DE ADMISSÃO FILTRO DE AR</p> <p>BMW 7 (E38) 728 i, iL 08.1995/11.2001 142KW 193CV 2793CC M52 B28 (286S2) M52 B28 (286S1) 0005564</p> <p>B190-74/77mm 91x140mm ch-d15x20mm</p>		<p><b>R8184</b> NO. 32411093130 - 32411095526</p> <p>TUBO DE LIGAÇÃO DA BOMBA HIDRÁULICA DIREÇÃO</p> <p>BMW 7 (E38) 728 i, iL 08.1995/11.2001 142KW 193CV 2793CC M52 B28 (286S2) M52 B28 (286S1) 0005564</p> <p>B360-d16/d16mm</p>
	<p><b>S1271</b> NO. 31106770689 - 31106770690 - 31121092019 - 31121094235 - 31121122462 - 31121124622 - 31121133236 - 31121133236 -</p> <p>SILENT-BLOC DO BRAÇO DA SUSPENSÃO (FRENTE CENTRO)</p> <p>BMW 7 (E38) 725 tds 04.1996/11.2001 105KW 143CV 2497CC M51 D25 (256T1) 0005589 - BMW 7 (E38) 728 i, iL 08.1995/11.2001 142KW 193CV 2793CC M52 B28 (286S2) M52 B28 (286S1) 0005564 - BMW 7 (E38) 730 d 08.1998/04.2000 135KW 184CV 2926CC M57 D30 (306D1) 0005635 - BMW 7 (E38) 730 d 04.2000/11.2001 142KW 193CV 2926CC M57 D30 (306D1) 0005677 - BMW 7 (E38) 730 i, iL 03.1994/02.1996 160KW 218CV 2997CC M60 B...</p> <p>d46x52mm c40mm 1f-d12mm</p>		<p><b>S1861</b> NO. 33326755471 - 33326755472</p> <p>SILENT-BLOC DO EIXO SUSPENSÃO TRÁS PARTE DA FRENTE</p> <p>BMW 7 (E38) 725 tds (De 04.1996 Até 11.2001) 105KW 143cv 2497cm3 três volumes - BMW 7 (E38) 728 i, iL (De 08.1995 Até 11.2001) 142KW 193cv 2793cm3 três volumes - BMW 7 (E38) 728i X (De 11.1995 Até 09.2001) 142KW 193cv 2793cm3 três volumes - BMW 7 (E38) 730 d (De 08.1998 Até 04.2000) 135KW 184cv 2926cm3 três volumes - BMW 7 (E38) 730 d (De 04.2000 Até 11.2001) 142KW 193cv 2926cm3 três volumes - BMW...</p> <p>d51x70mm c49mm 1f-d10mm</p>
	<p><b>S1862</b> NO. 33321090031 - 33321090032 - 33321090519 - 33321093713 - 33321093714 - 33321093723 - 33321093724 - 33321093724 -</p> <p>SILENT-BLOC DO EIXO SUSPENSÃO TRÁS PARTE TRÁS</p> <p>BMW 7 (E38) 725 tds 04.1996/11.2001 105KW 143CV 2497CC M51 D25 (256T1) 0005589 - BMW 7 (E38) 728 i, iL 08.1995/11.2001 142KW 193CV 2793CC M52 B28 (286S2) M52 B28 (286S1) 0005564 - BMW 7 (E38) 730 d 08.1998/04.2000 135KW 184CV 2926CC M57 D30 (306D1) 0005635 - BMW 7 (E38) 730 d 04.2000/11.2001 142KW 193CV 2926CC M57 D30 (306D1) 0005677 - BMW 7 (E38) 730 i, iL 03.1994/02.1996 160KW 218CV 2997CC M60 B...</p> <p>d53x65mm c50mm 1f-d12mm</p>		<p><b>T0621-I</b> NO. 31331124449 - 31331124573 - 31331125215</p> <p>BATENTE SUSPENSÃO FRENTE</p> <p>BMW 7 (E38) 728 i-iL (08.95 A 11.01) 193cv 2793cc três volumes - BMW 7 (E38) 730 i-iL (10.94 A 11.01) 218cv 2997cc três volumes - BMW 7 (E38) 735 i-iL (01.96 A 12.98) 235cv 3498cc três volumes</p> <p>d59x85mm 1f-d26mm 1f-d18mm</p>



	<p><b>T0625-I</b> NO. 33531091031</p> <p><b>BATENTE SUSPENSÃO FRENTE</b></p> <p>BMW 7 (E38) 728 i - iL Dist ância ent re eixos: não para distância entre os eixos aumentada (08.95 A 11.01) 193cv 2793cc três volumes - BMW 7 (E38) 730 i - iL Dist ância ent re eixos: não para distância entre os eixos aumentada (10.94 A 11.01) 211cv 2997cc três volumes - BMW 7 (E38) 730 i - iL Dist ância ent re eixos: não para distância entre os eixos aumentada (10.94 A 11.01) 218cv 2997cc três...</p> <p>d68x93mm 1f-d26mm 1f-d12mm</p>		<p><b>U7004</b> NO. 13641286708 - 13641730767</p> <p><b>ORING DE VÁLVULA INJECTORA (Di 7,52 - De 14,58 - E 3,53)</b></p> <p>BMW 7 (E38) 728 i, iL (08.1995 - 11.2001) 142kw 193cv 2793cm3 três volumes BMW 7 (E38) 730 i, iL (03.1994 - 02.1996) 160kw 218cv 2997cm3 três volumes BMW 7 (E38) 735 i, iL (03.1996 - 08.1998) 173kw 235cv 3498cm3 três volumes BMW 7 (E38) 740 i, iL (03.1994 - 02.1996) 210kw 286cv 3982cm3 três volumes BMW 7 (E38) 740 i, iL (02.1996 - 07.2001) 210kw 286cv 4398cm3 três volumes BMW 7 (E38) 750 i, iL (11...</p> <p>d14x3mm 1f-d8mm</p>
	<p><b>U7033K</b> NO. 61671378609 - 64500149356 - 64500301636 - 64501363572 - 64501466019 - 64501468463 - 64508390601</p> <p><b>ORINGS BOMBA DIREÇÃO ASSITIDA</b></p> <p>BMW 7 (E38) 725 tds (04.1996 - 11.2001) 105kw 143cv 2497cm3 três volumes BMW 7 (E38) 728 i, iL (08.1995 - 11.2001) 142kw 193cv 2793cm3 três volumes BMW 7 (E38) 730 d (08.1998 - 04.2000) 135kw 184cv 2926cm3 três volumes BMW 7 (E38) 730 d (04.2000 - 11.2001) 142kw 193cv 2926cm3 três volumes BMW 7 (E38) 730 i, iL (10.1994 - 11.2001) 155kw 211cv 2997cm3 três volumes BMW 7 (E38) 730 i, iL (03.1994 - 0...</p> <p>d11x2mm d10x2mm 1f-d7mm 1f-d6mm</p>		<p><b>UAP81292</b> NO. 13532247156 - 2247156</p> <p><b>ANILHA PROTEÇÃO TÉRMICA INJECTORES</b></p> <p>BMW 7 (E38) 730 d (De 04-2000 Até 11-2001) 142kW 193CV 2926cc três volumes</p> <p>d16x1mm 1f-d7mm</p>
	<p><b>UAP81905</b> NO. 13532247156 - 2247156</p> <p><b>ANILHA PROTEÇÃO TÉRMICA INJECTORES</b></p> <p>BMW 7 (E38) 730 d (De 04-2000 Até 11-2001) 142kW 193CV 2926cc três volumes</p> <p>d14x1mm 1f-d7mm</p>		<p><b>UAP83244</b> NO. 13537785722</p> <p><b>ANILHA PROTEÇÃO TÉRMICA INJECTORES</b></p> <p>BMW 7 (E38) 730 d (De 08-1998 Até 04-2000) 135kW 184CV 2926cc três volumes BMW 7 (E38) 730 d (De 04-2000 Até 11-2001) 142kW 193CV 2926cc três volumes</p> <p>d15x2mm 1f-d7mm</p>
	<p><b>UFQ23302</b> NO. 21511223302</p> <p><b>FORQUILHA DA EMBRAIAGEM</b></p> <p>BMW 7 (E38) 728 i, iL 08.1995/11.2001 142KW 193CV 2793CC M52 B28 (286S2) M52 B28 (286S1) 0005564 - BMW 7 (E38) 730 i, iL 03.1994/02.1996 160KW 218CV 2997CC M60 B30 (308S1) 0005543 - BMW 7 (E38) 730 i, iL 10.1994/11.2001 155KW 211CV 2997CC M60 B30 (308S1) 0005542 - BMW 7 (E38) 735 i, iL 03.1996/08.1998 173KW 235CV 3498CC M62 B35 (358S1) 0005584 - BMW 7 (E38) 735 i, iL 09.1998/07.2001 175KW 238CV 34...</p> <p>252x83x28mm 1f-47x75mm</p>		<p><b>UMV25110</b> NO. 25111434495 - 25117500299 - 25117503231 - 25117523817 - 25117544524</p> <p><b>MANETE PUNHO TOPO ALAVANCA MUDANÇAS 5 VELOCIDADES NAPEL F14MM</b></p> <p>BMW 7 (E38): 728 i, iL 08.1995/11.2001 142KW 193CV 2793CC - BMW 7 (E38): 730 i, iL 10.1994/11.2001 155KW 211CV 2997CC - BMW 7 (E38): 730 i, iL 03.1994/02.1996 160KW 218CV 2997CC - BMW 7 (E38): 735 i, iL 03.1996/08.1998 173KW 235CV 3498CC - BMW 7 (E38): 735 i, iL 09.1998/07.2001 175KW 238CV 3498CC - BMW 7 (E38): 725 tds 04.1996/11.2001 105KW 143CV 2497CC</p> <p>d51x91mm 1f-d14mm</p>
	<p><b>UMV25114</b> NO. 25111434495 - 25117500299 - 25117503231 - 25117523817 - 25117544524</p> <p><b>MANETE PUNHO TOPO ALAVANCA MUDANÇAS 5 VELOCIDADES F14MM</b></p> <p>BMW 7 (E38): 728 i, iL 08.1995/11.2001 142KW 193CV 2793CC - BMW 7 (E38): 730 i, iL 10.1994/11.2001 155KW 211CV 2997CC - BMW 7 (E38): 730 i, iL 03.1994/02.1996 160KW 218CV 2997CC - BMW 7 (E38): 735 i, iL 03.1996/08.1998 173KW 235CV 3498CC - BMW 7 (E38): 735 i, iL 09.1998/07.2001 175KW 238CV 3498CC - BMW 7 (E38): 725 tds 04.1996/11.2001 105KW 143CV 2497CC</p> <p>d56x94mm 1f-d14mm</p>		<p><b>UTR0813</b> NO. 17111468077 - 17111712188 - 17111712232 - 17111719167 - 17111742232 - 17112242256 - 17114379048 - 17114379048</p> <p><b>TAMPÃO RESERVATÓRIO LÍQUIDO REFRIGERAÇÃO</b></p> <p>BMW 7 (E38) 725 tds (04.96 A 11.01) 143cv 2503cc três volumes - BMW 7 (E38) 730 d (08.98 A 04.00) 184cv 2926cc três volumes - BMW 7 (E38) 730 d (04.00 A 11.01) 193cv 2926cc três volumes - BMW 7 (E38) 740 d (05.99 A 11.01) 245cv 3901cc três volumes - BMW 7 (E65, E66, E67) 730 d (10.02 A 07.08) 218cv 2993cc três volumes - BMW 7 (E65, E66, E67) 730 Ld (07.05 A 12.09) 231cv 2993cc três volu...</p> <p>d66x45mm 1f-d52x20mm</p>
	<p><b>W5047</b> NO. 0614610 - 0614612 - 11232244417 - 11232245377 - 11232246510 - 11232246511 - 614610 - 614612 ....</p> <p><b>POLIE DA CAMBOTA (5 PISTAS)</b></p> <p>BMW 7 (E38): 725 tds 04.1996/11.2001 105KW 143CV 2497CC</p> <p>d157/205mm d45mm</p>		<p><b>Y3239</b> NO. 36130141574 - 36130141576 - 36131095390 - 36131116717 - 36131117190 - 36131126191</p> <p><b>PARAFUSO PERNO RODA CHAVE 17 M12X1,50X50MM ( BASE CONICA )</b></p> <p>BMW 7 (E38) 725 tds 04.1996/11.2001 105KW 143CV 2497CC M51 D25 (256T1) 0005589 - BMW 7 (E38) 728 i, iL 08.1995/11.2001 142KW 193CV 2793CC M52 B28 (286S2) M52 B28 (286S1) 0005564 - BMW 7 (E38) 730 d 08.1998/04.2000 135KW 184CV 2926CC M57 D30 (306D1) 0005635 - BMW 7 (E38) 730 d 04.2000/11.2001 142KW 193CV 2926CC M57 D30 (306D1) 0005677 - BMW 7 (E38) 730 i, iL 03.1994/02.1996 160KW 218CV 2997CC M60 B...</p> <p>c51mm (ch-17mm) M12x1x24mm</p>
	<p><b>Z80849</b> NO. 51411973500 - 99950758240</p> <p><b>Mola de painel</b></p> <p>BMW SÉRIE 7(E38)</p> <p>d18x21mm 1p-d9-13mm</p>		

	<p><b>D0063</b> NO. 26117542238</p> <p>CARDAN DA TRANSMISSÃO</p> <p>BMW 7 (E65 - E66 - E67) 730 i - Li (De 03-2005 Até 07-2008) 190kW 258CV 2996cc três volumes BMW 7 (E65 - E66 - E67) 740 i - Li (De 07-2005 Até 07-2008) 225kW 306CV 4000cc três volumes BMW 7 (E65 - E66 - E67) 750 i - Li (De 07-2005 Até 07-2008) 270kW 367CV 4799cc três volumes</p> <p>163x155x42mm 6f-d12mm</p>		<p><b>P1055</b> NO. 35211160421</p> <p>CAPA DE PEDAL DO TRAVÃO(VEÍCULOS COM CAIXA AUTOMÁTICA)</p> <p>BMW 7 (E65, E66, E67) 730 d 06.2002/02.2005 160KW 218CV 2993CC M57 D30 (306D2) 0005746 - BMW 7 (E65, E66, E67) 730 i, Li 03.2003/07.2008 170KW 231CV 2979CC M54 B30 (306S3) 0005750 - BMW 7 (E65, E66, E67) 735 i, Li 11.2001/02.2005 200KW 272CV 3600CC N62 B36 A 0005723 - BMW 7 (E65, E66, E67) 740 d 10.2002/02.2005 190KW 258CV 3901CC M67 D39 (398D1) 0005747 - BMW 7 (E65, E66, E67) 740 i, Li 03.2005/08...</p> <p>74x107x42mm</p>
	<p><b>RT08457</b> NO. 34321154904</p> <p>TUBO DE TRAVÃO TRÁS LH-RH</p> <p>BMW 7 (E65, E66, E67) 730 d (De 06.2002 Até 02.2005) 160kW 218cv 2993cm3 três volumes - BMW 7 (E65, E66, E67) 730 i, Li (De 03.2003 Até 07.2008) 170kW 231cv 2979cm3 três volumes - BMW 7 (E65, E66, E67) 735 i, Li (De 11.2001 Até 02.2005) 200kW 272cv 3600cm3 três volumes - BMW 7 (E65, E66, E67) 740 d (De 10.2002 Até 02.2005) 190kW 258cv 3901cm3 três volumes - BMW 7 (E65, E66, E67) 745 i, Li (De 07....</p> <p>ponteira-1 (F) ponteira-2 (M) 160hp-300mm</p>		<p><b>S1271</b> NO. 31106770689 - 31106770690 - 31121092019 - 31121094235 - 31121122462 - 31121124622 - 31121133236 - 31121133236</p> <p>SILENT-BLOC DO BRAÇO DA SUSPENSÃO (FRENTE CENTRO)</p> <p>BMW 7 (E65) 730 d 06.2002/02.2005 160KW 218CV 2993CC M57 D30 (306D2) 0005746 - BMW 7 (E65) 730 d 09.2002/08.2003 150KW 204CV 2993CC M57 D30 (306D2) 0005748 - BMW 7 (E65) 730 d 09.2003/08.2008 155KW 211CV 2993CC M57 D30 (306D2) M57 D30 (306D3) 0005752 0005ACI - BMW 7 (E65) 730 i, Li 03.2003/07.2008 170KW 231CV 2979CC M54 B30 (306S3) 0005750 - BMW 7 (E65) 730 i, Li 03.2005/08.2008 190KW 258CV 2996CC...</p> <p>d46x52mm c40mm 1f-d12mm</p>
	<p><b>U7033K</b> NO. 61671378609 - 64500149356 - 64500301636 - 64501363572 - 64501466019 - 64501468463 - 64508390601</p> <p>ORINGS BOMBA DIREÇÃO ASSITIDA</p> <p>BMW 7 (E65, E66, E67) 730 Ld (07.2005 - 08.2008) 170kw 231cv 2993cm3 três volumes BMW 7 (E65, E66, E67) 730 d (09.2002 - 08.2003) 150kw 204cv 2993cm3 três volumes BMW 7 (E65, E66, E67) 730 d (09.2003 - 08.2008) 155kw 211cv 2993cm3 três volumes BMW 7 (E65, E66, E67) 730 d (06.2002 - 02.2005) 160kw 218cv 2993cm3 três volumes BMW 7 (E65, E66, E67) 730 i, Li (03.2003 - 07.2008) 170kw 231cv 2979cm3 tr...</p> <p>d11x2mm d10x2mm 1f-d7mm 1f-d6mm</p>		<p><b>UAP81292</b> NO. 13532247156 - 2247156</p> <p>ANILHA PROTEÇÃO TÉRMICA INJECTORES</p> <p>BMW 7 (E65 - E66 - E67) 730 Ld (De 07-2005 Até 08-2008) 170kW 231CV 2993cc três volumes</p> <p>d16x1mm 1f-d7mm</p>
	<p><b>UAP81905</b> NO. 13532247156 - 2247156</p> <p>ANILHA PROTEÇÃO TÉRMICA INJECTORES</p> <p>BMW 7 (E65 - E66 - E67) 730 Ld (De 07-2005 Até 08-2008) 170kW 231CV 2993cc três volumes</p> <p>d14x1mm 1f-d7mm</p>		<p><b>W5099</b> NO. 11232247932 - 11237786611 - 11237786611 - 11237793593 - 11238511371</p> <p>POLIE DA CAMBOTA (4+6 PISTAS)</p> <p>BMW 7 (E65, E66, E67) 730 d 06.2002/02.2005 160KW 218CV 2993CC M57 D30 (306D2) 0005746 - BMW 7 (E65, E66, E67) 730 Ld 07.2005/08.2008 170KW 231CV 2993CC M57 D30 (306D3) 0005824, 0005ACK</p> <p>d191mm</p>
	<p><b>W5099-C</b> NO. 11237788611 - 11237793593</p> <p>POLIE DA CAMBOTA (4+6 PISTAS)</p> <p>BMW 7 (E65, E66, E67) 730 d 06.2002/02.2005 160KW 218CV 2993CC M57 D30 (306D2) 0005746 - BMW 7 (E65, E66, E67) 730 Ld 07.2005/08.2008 170KW 231CV 2993CC M57 D30 (306D3) 0005824, 0005ACK</p> <p>d191mm</p>		<p><b>W5169</b> NO. 11231439683 - 11237568345</p> <p>POLIE DA CAMBOTA (4 + 6 PISTAS)</p> <p>BMW 7 (E65 - E66 - E67) 735 i - Li (De 11-2001 Até 02-2005) 200kW 272CV 3600cc três volumes BMW 7 (E65 - E66 - E67) 735 i - Li (De 11-2001 Até 02-2005) 200kW 272CV 3600cc três volumes BMW 7 (E65 - E66 - E67) 740 i - Li (De 07-2005 Até 07-2008) 225kW 306CV 4000cc três volumes BMW 7 (E65 - E66 - E67) 740 i - Li (De 07-2005 Até 07-2008) 225kW 306CV 4000cc três volumes BMW 7 (E65 - E66 - E67) 745 ...</p> <p>d174/152mm d37mm</p>
	<p><b>W5225</b> NO. 32417787106</p> <p>POLIE DA BOMBA HIDRÁULICA</p> <p>BMW 7 (E65, E66, E67) 730 d 06.2002/02.2005 160KW 218CV 2993CC M57 D30 (306D2) 0005746 - BMW 7 (E65, E66, E67) 730 Ld 07.2005/08.2008 170KW 231CV 2993CC M57 D30 (306D3) 0005824 0005ACK</p> <p>d143x28mm 1f-d30mm 3f-d8mm</p>		<p><b>Z80721</b> NO. 51318177850</p> <p>Mola de fixação</p> <p>BMW SÉRIE 7(E65)</p>
	<p><b>Z80742</b> NO. 51111908077 - N90359101</p> <p>Mola de fixação</p> <p>BMW SÉRIE 7(E65)</p> <p>d15x33mm 1p-d6.5-15.5mm</p>		<p><b>Z80802</b> NO. 51231885969 - 51231889018 - 51411802258 - 51411807439 - 51411844033 - 51411852599 - 51411868613</p> <p>Mola de painel</p> <p>BMW SÉRIE 7(E65)</p> <p>d18x17.8mm 1p-d8-11.4mm</p>





	<b>KUBT3023</b> NO. 1f-d39mm(x2) 1f-d48mm(x2) 1f-d5mm		<b>W5192</b> NO. 11238602800
	<b>KIT BORRACHAS TRAVAO PINÇA TRAS BRENBO 40MM</b>  BMW 7 (G11, G12) 725 d, Ld 07.2016/02.2019 155KW 211CV 1995CC B47 D20 B 0005CIW 0005CIX - BMW 7 (G11, G12) 725 d, Ld 07.2016/02.2019 170KW 231CV 1995CC B47 D20 B 0005CGL 0005CGM - BMW 7 (G11, G12) 730 d 09.2015/06.2020 195KW 265CV 2993CC B57 D30 A 0005CEG 0005CEH - BMW 7 (G11, G12) 730 d, Ld xDrive 09.2015/06.2020 195KW 265CV 2993CC B57 D30 A 0005CFB 0005CFC - BMW 7 (G11, G12) 730 i, Li desde 03.2...		<b>POLIE DA CAMBOTA (6 pistas)</b>  BMW 7 (G11, G12): 740 e, Le 07.2016/02.2019 190KW 258CV 1998CC - BMW 7 (G11, G12): 740 e, Le 07.2016/02.2019 240KW 326CV 1998CC - BMW 7 (G11, G12): 740 Le xDrive 07.2016/02.2019 190KW 258CV 1998CC - BMW 7 (G11, G12): 740 Le xDrive 07.2016/02.2019 240KW 326CV 1998CC
	d59x12mm(x2) d54x3mm(x2) d59mm(x2) 1f-d48mm(x2) 1f-d5mm 1p		d158mm d59mm
	<b>W5192</b> NO. 11238602800		<b>Z55186</b> NO. 07147145753
	<b>POLIE DA CAMBOTA (6 pistas)</b>  BMW 7 (G11, G12): 740 e, Le 07.2016/02.2019 190KW 258CV 1998CC - BMW 7 (G11, G12): 740 e, Le 07.2016/02.2019 240KW 326CV 1998CC - BMW 7 (G11, G12): 740 Le xDrive 07.2016/02.2019 190KW 258CV 1998CC - BMW 7 (G11, G12): 740 Le xDrive 07.2016/02.2019 240KW 326CV 1998CC		<b>MOLA DE PAINEL</b>  BMW 7 (G11, G12) 725 d, Ld (07.2016 - 02.2019) 155 211 1995cm3 três volumes BMW 7 (G11, G12) 725 d, Ld (07.2016 - 02.2019) 170 231 1995cm3 três volumes BMW 7 (G11, G12) 730 d, Ld (09.2015 - 06.2020) 195 265 2993cm3 três volumes BMW 7 (G11, G12) 730 d, Ld xDrive (09.2015 - 06.2020) 195kw 265cv 2993cm3 três volumes BMW 7 (G11, G12) 740 Le xDrive (07.2016 - 02.2019) 240kw 326cv 1998cm3 três volumes B...
	d158mm d59mm		d8x 18mm f-d18mm

BMW SERIE 8(E31)

	<b>D0031</b> NO. 26111229065 - 26111277690		<b>D0060</b> NO. 32311115090 - 32311115092
	<b>CARDAN TRANSMISSÃO D140X38MM 6 FUROS 14MM ENTRE FUROS 105MM</b>  BMW 8 (E31) 840 Ci 03.1996/06.1999 210KW 286CV 4398CC M62 B44 (448S1) 0005588 - BMW 8 (E31) 840 i 03.1993/02.1996 210KW 286CV 3982CC M60 B40 (408S1) 0005532 - BMW 8 (E31) 850 Ci 09.1994/12.1999 240KW 326CV 5379CC M73 B54 (54121) 0005553 - BMW Z8 Roadster (E52) 4.9 01.2000/12.2003 294KW 400CV 4941CC S62 B50 (508S1) 0005674		<b>CARDAN COLUNA DIREÇÃO</b>  BMW 8 (E31) 840 Ci 03.1996/06.1999 210KW 286CV 4398CC M62 B44 (448S1) 0005588 - BMW 8 (E31) 840 i 03.1993/02.1996 210KW 286CV 3982CC M60 B40 (408S1) 0005532 - BMW 8 (E31) 850 Ci 09.1994/12.1999 240KW 326CV 5379CC M73 B54 (54121) 0005553 - BMW 8 (E31) 850 CSI 11.1992/12.1996 280KW 380CV 5576CC S70 B56 (56121) 0575309 7909301 - BMW 8 (E31) 850 i, Ci 01.1990/08.1994 220KW 300CV 4988CC M70 B50 (5012A) 0005494
	d140x38mm 1f-d52mm 6f-d14mm		65x65x13mm 4f-d8mm
	<b>KUBT3023</b> NO. 1f-d39mm(x2) 1f-d48mm(x2) 1f-d5mm		<b>KUR21999</b> NO. 1f-d24mm 1f-d10mm 1f-d10mm 1f-d19mm
	<b>KIT BORRACHAS TRAVAO PINÇA TRAS BRENBO 40MM</b>  BMW 8 (E31) 840 Ci 03.1996/06.1999 210KW 286CV 4398CC M62 B44 (448S1) 0005588 - BMW 8 (E31) 840 i 03.1993/02.1996 210KW 286CV 3982CC M60 B40 (408S1) 0005532 - BMW 8 (E31) 850 Ci 09.1994/12.1999 240KW 326CV 5379CC M73 B54 (54121) 0005553 - BMW 8 (E31) 850 i, Ci 01.1990/08.1994 220KW 300CV 4988CC M70 B50 (5012A) 0005494		<b>KIT DE REPARAÇÃO ALAVANCA DE VELOCIDADES</b>  BMW 8 (E31) 840 Ci (De 03.1996 Até 06.1999) 210kW 286cv 4398cm3 Coupé - BMW 8 (E31) 840 i (De 03.1993 Até 02.1996) 210kW 286cv 3982cm3 Coupé - BMW 8 (E31) 850 CSI (De 11.1992 Até 12.1996) 280kW 380cv 5576cm3 Coupé - BMW 8 (E31) 850 i,Ci (De 01.1990 Até 08.1994) 220kW 300cv 4988cm3 Coupé -
	d59x12mm(x2) d54x3mm(x2) d59mm(x2) 1f-d48mm(x2) 1f-d5mm 1p		d37x18mm d19x25mm d17x22mm d31x210mm 4x126x120mm 2x419x41mm 15
	<b>P1042</b> NO. 35211160422		<b>P1055</b> NO. 35211160421
	<b>CAPA DE PEDAL</b>  BMW 8 (E31) 840 Ci 03.1996/06.1999 210KW 286CV 4398CC M62 B44 (448S1) 0005588 - BMW 8 (E31) 840 i 03.1993/02.1996 210KW 286CV 3982CC M60 B40 (408S1) 0005532 - BMW 8 (E31) 850 Ci 09.1994/12.1999 240KW 326CV 5379CC M73 B54 (54121) 0005553 - BMW 8 (E31) 850 CSI 11.1992/12.1996 280KW 380CV 5576CC S70 B56 (56121) 0575309 7909301 - BMW 8 (E31) 850 i, Ci 01.1990/08.1994 220KW 300CV 4988CC M70 B50 (5012A) 0005494		<b>CAPA DE PEDAL DO TRAVÃO(VEICULOS COM CAIXA AUTOMÁTICA)</b>  BMW 8 (E31) 840 Ci 03.1996/06.1999 210KW 286CV 4398CC M62 B44 (448S1) 0005588 - BMW 8 (E31) 840 i 03.1993/02.1996 210KW 286CV 3982CC M60 B40 (408S1) 0005532 - BMW 8 (E31) 850 Ci 09.1994/12.1999 240KW 326CV 5379CC M73 B54 (54121) 0005553 - BMW 8 (E31) 850 i, Ci 01.1990/08.1994 220KW 300CV 4988CC M70 B50 (5012A) 0005494
	75x65x40mm		74x107x42mm
	<b>P1059</b> NO. 1 108 634 - 35211108634		<b>R021812</b> NO. 13311288284
	<b>CAPA DE PEDAL DO TRAVÃO</b>  BMW SÉRIE 8 (E31) 840i - 840Ci - 850i - 850Ci - 850CSI (04-1990 A 12-1999)		<b>TUBO DE LIGAÇÃO DO CARBURADOR AO COLECTOR</b>  BMW 8 (E31): 840 i 03.1993/02.1996 210KW 286CV 3982CC - BMW 8 (E31): 850 i,Ci 01.1990/08.1994 220KW 300CV 4988CC - BMW 8 (E31): 850 Ci 09.1994/12.1999 240KW 326CV 5379CC
	75x62x12mm		B245-d77mm 235-65mm
	<b>R021925</b> NO. 13311288284		<b>U7033K</b> NO. 61671378609 - 64500149356 - 64500301636 - 64501363572 - 64501466019 - 64501468463 - 645008390601
	<b>TUBO DE LIGAÇÃO DO CARBURADOR AO COLECTOR</b>  BMW 8 (E31): 840 i 03.1993/02.1996 210KW 286CV 3982CC - BMW 8 (E31): 850 i,Ci 01.1990/08.1994 220KW 300CV 4988CC - BMW 8 (E31): 850 Ci 09.1994/12.1999 240KW 326CV 5379CC		<b>ORINGS BOMBA DIREÇÃO ASSITIDA</b>  BMW 8 (E31) 840 Ci (03.1996 - 06.1999) 210kW 286cv 4398cm3 Coupé BMW 8 (E31) 840 i (03.1993 - 02.1996) 210kW 286cv 3982cm3 Coupé BMW 8 (E31) 850 CSI (11.1992 - 12.1996) 280kW 380cv 5576cm3 Coupé BMW 8 (E31) 850 Ci (09.1994 - 12.1999) 240kW 326cv 5379cm3 Coupé BMW 8 (E31) 850 i, Ci (01.1990 - 08.1994) 220kW 300cv 4988cm3 Coupé
	B230-7/7mm 205x55mm		d11x2mm d10x2mm 1f-d7mm 1f-d6mm

	<b>UFQ23302</b> NO. 21511223302		<b>UTR0812</b> NO. 17110152374 - 17111468076 - 17111712492 - 17111712669 - 17111742231 - 17117639022 - 17119071581
	<i>FORQUILHA DA EMBRAIAGEM</i> BMW 8 (E31) 840 Ci 03.1996/06.1999 210KW 286CV 4398CC M62 B44 (448S1) 0005588 - BMW 8 (E31) 840 i 03.1993/02.1996 210KW 286CV 3982CC M60 B40 (408S1) 0005532		<i>TAMPÃO RESERVATÓRIO LIQUIDO REFRIGERAÇÃO</i> BMW 8 (E31) 840 i (02.93 A 02.96) 286cv 3982cc Coupé - BMW 8 (E 31) 840 Ci (01.96 A 12.99) 286cv 4398cc Coupé - BMW 8 (E 31) 850 i, Ci (04.90 A 10.94) 300cv 4988cc Coupé - BMW 8 (E 31) 850 Ci (09.94 A 12.99) 326cc 5379cc Coupé - BMW 8 (E 31) 850 C Si (04.93 A 12.96) 380cv 5576cc Coupé
	252x83x28mm 1f-47x75mm		d65x45mm 1f-d52x20mm
	<b>Y3239</b> NO. 36130141574 - 36130141576 - 36131095390 - 36131116717 - 36131117190 - 36131126191		
	<i>PARAFUSO PERNO RODA CHAVE 17 M12X1,50X50MM ( BASE CONICA )</i> BMW 8 (E31) 840 Ci 03.1996/06.1999 210KW 286CV 4398CC M62 B44 (448S1) 0005588 - BMW 8 (E31) 840 i 03.1993/02.1996 210KW 286CV 3982CC M60 B40 (408S1) 0005532 - BMW 8 (E31) 850 Ci 09.1994/12.1999 240KW 326CV 5379CC M73 B54 (54121) 0005553 - BMW 8 (E31) 850 CSI 11.1992/12.1996 280KW 380CV 5576CC S70 B56 (56121) 0575309 7909301 - BMW 8 (E31) 850 i, Ci 01.1990/08.1994 220KW 300CV 4988CF M70 B50 (5012... c51mm (ch-17mm) M12x1x24mm		

## BMW SERIE 8-CABRIOLET (G14) - (F91)

	<b>KUBT3023</b> NO. 1f-d39mm(x2) 1f-d48mm(x2) 1f-d5mm		
	<i>KIT BORRACHAS TRAVAO PINÇA TRAS BRENBO 40MM</i> BMW 8 Cabriolet (G14, F91) 840 d xDrive 11.2018/10.2020 235KW 320CV 2993CC B57 D30 B 0005CTF - BMW 8 Cabriolet (G14, F91) 840 i 07.2019/10.2020 250KW 340CV 2998CC B58 B30 C 0005CVD - BMW 8 Cabriolet (G14, F91) 840 i xDrive 07.2019/10.2020 250KW 340CV 2998CC B58 B30 C 0005CVE - BMW 8 Cabriolet (G14, F91) M 850 i xDrive desde 11.2018 390KW 530CV 4395CC N63 B44 D 0005CTE		
	d59x12mm(x2) d54x3mm(x2) d59mm(x2) 1f-d48mm(x2) 1f-d5mm 1p d10x17mm...		

## BMW SERIE 8-COUPÉ (G15) - (F92)

	<b>KUBT3023</b> NO. 1f-d39mm(x2) 1f-d48mm(x2) 1f-d5mm		
	<i>KIT BORRACHAS TRAVAO PINÇA TRAS BRENBO 40MM</i> BMW 8 Coupé (G15, F92) 840 d xDrive 07.2018/10.2020 235KW 320CV 2993CC B57 D30 B 0005CSY - BMW 8 Coupé (G15, F92) 840 i 07.2019/10.2020 250KW 340CV 2998CC B58 B30 C 0005CVF - BMW 8 Coupé (G15, F92) 840 i xDrive 07.2019/10.2020 250KW 340CV 2998CC B58 B30 C 0005CVG - BMW 8 Coupé (G15, F92) M 850 i xDrive desde 10.2018 390KW 530CV 4395CC N63 B44 D 0005CTD		
	d59x12mm(x2) d54x3mm(x2) d59mm(x2) 1f-d48mm(x2) 1f-d5mm 1p d10x17mm...		

## BMW SERIE 8-GRAN COUPÉ (G16) - (F93)

	<b>KUBT3023</b> NO. 1f-d39mm(x2) 1f-d48mm(x2) 1f-d5mm		
	<i>KIT BORRACHAS TRAVAO PINÇA TRAS BRENBO 40MM</i> BMW 8 Gran Coupe (G16, F93) 840 d xDrive 07.2019/10.2020 235KW 320CV 2993CC B57 D30 B 0005CVK - BMW 8 Gran Coupe (G16, F93) 840 i 07.2019/10.2020 250KW 340CV 2998CC B58 B30 C 0005CVH - BMW 8 Gran Coupe (G16, F93) 840 i xDrive desde 07.2019 250KW 340CV 2998CC B58 B30 C 0005CVI - BMW 8 Gran Coupe (G16, F93) M 850 i xDrive desde 07.2019 390KW 530CV 4395CC N63 B44 D 0005CVJ		
	d59x12mm(x2) d54x3mm(x2) d59mm(x2) 1f-d48mm(x2) 1f-d5mm 1p d10x17mm...		

	<p><b>E0643-M</b> NO. 22116885788 - 6885788</p> <p><b>ESTICADOR SUPORTE APOIO MOTOR TRAS</b></p> <p>BMW X1 (F48) sDrive 16 d 11.2014/05.2022 85KW 116CV 1496CC B37 C15 A 0005CKU 0005CCD - BMW X1 (F48) sDrive 18 d 07.2015/06.2022 110KW 150CV 1995CC B47 C20 A B47 C20 B 0005CKV 0005CCE - BMW X1 (F48) sDrive 18 i 11.2015/06.2022 100KW 136CV 1499CC B38 A15 A B38A15F 0005CKQ 0005CBZ - BMW X1 (F48) sDrive 18 i 07.2017/06.2022 103KW 140CV 1499CC B38 A15 A 0005CPA - BMW X1 (F48) sDrive 20 d 11.2015/05.202...</p> <p>253x62x75mm 1f-d13mm 1f-d12mm</p>		<p><b>E0643-M</b> NO. 22116885788 - 6885788</p> <p><b>ESTICADOR SUPORTE APOIO MOTOR TRAS</b></p> <p>BMW X2 (F39) sDrive 16 d 11.2018/10.2023 85KW 116CV 1496CC B37 C15 A 0005CRD - BMW X2 (F39) sDrive 18 d 03.2018/10.2023 100KW 136CV 1995CC B47 C20 B B47 C20 A 0005CRF - BMW X2 (F39) sDrive 18 d 03.2018/10.2023 110KW 150CV 1995CC B47 C20 A B47 C20 B 0005CRE - BMW X2 (F39) sDrive 18 i 03.2018/10.2023 100KW 136CV 1499CC B38 A15 A B32 S15 A B38A15F 0005CQZ - BMW X2 (F39) sDrive 18 i 03.2018/10.2023 ...</p> <p>253x62x75mm 1f-d13mm 1f-d12mm</p>
	<p><b>E1111</b> NO. 18207534092 - 18207589931 - 18208511880</p> <p><b>ESTICADOR DO ESCAPE</b></p> <p>BMW X1 (E84) sDrive 18 d N.º peças nec.: 3 (10.09 A 06.15) 143cv 1995cc Combi - BMW X1 (E84) sDrive 20 d N.º peças nec.: 3 (10.09 A 06.15) 177cv 1995cc Combi</p> <p>71x54x32mm 2f-d10mm</p>		<p><b>F4207</b> NO. 25118036629 - 25118037309</p> <p><b>FOLE ALAVANCA VELOCIDADES C/ MANETE PUNHO TOPO COMPLETO 6 VELOCIDADES</b> BMW E84</p> <p>172x153x212mm 135x145mm</p>
	<p><b>KUR21999</b> NO. 1f-d24mm 1f-d10mm 1f-d10mm 1f-d19mm</p> <p><b>KIT DE REPARAÇÃO ALAVANCA DE VELOCIDADES</b></p> <p>BMW X1 (E84) sDrive 16 d (De 04.2012 Até 06.2015) 85kW 116cv 1995cm3 Combi - BMW X1 (E84) sDrive 16 i (De 03.2013 Até 06.2015) 105kW 143cv 1592cm3 Combi - BMW X1 (E84) sDrive 18 d (De 03.2009 Até 06.2015) 100kW 136cv 1995cm3 Combi - BMW X1 (E84) sDrive 18 d (De 12.2009 Até 06.2015) 105kW 143cv 1995cm3 Combi - BMW X1 (E84) sDrive 18 i (De 03.2010 Até 06.2015) 110kW 150cv 1995cm3 Combi - BMW X1 (E84)...</p> <p>d37x18mm d19x25mm d17x22x4mm d31x21mm d31x26x10mm d24x19x6</p>		<p><b>P1042</b> NO. 35211160422</p> <p><b>CAPA DE PEDAL</b></p> <p>BMW X1 (E84) sDrive 18 i 03.2010/06.2015 110KW 150CV 1995CC N46 B20 CC N46 B20 CD N46 B20 C N46 B20 E N46 B20 B N46 B20 BD 0005AQA - BMW X1 (E84) xDrive 20 i 09.2011/06.2015 135KW 184CV 1997CC N20 B20 A 0005BHA - BMW X1 (E84) xDrive 25 i 03.2010/08.2011 160KW 218CV 2996CC N52 B30 A 0005AYP - BMW X1 (E84) xDrive 28 i 09.2009/08.2011 190KW 258CV 2996CC N52 B30 A 0005APV - BMW X1 (E84) xDrive 28 i 03...</p> <p>.75x65x40mm</p>
	<p><b>R222288</b> NO. 11617797482 - 11617823887 - 7797482 - 7823887</p> <p><b>TUBO DO AR SOBREALIMENTAÇÃO</b></p> <p>BMW X1 (E84) sDrive 18 d 03.2009/06.2015 100KW 136CV 1995CC N47 D20 C 0005BDQ 0005APZ - BMW X1 (E84) sDrive 18 d 12.2009/06.2015 105KW 143CV 1995CC N47 D20 C 0005BDL 0005APY - BMW X1 (E84) xDrive 18 d 03.2009/06.2015 100KW 136CV 1995CC N47 D20 C 0005BDJ 0005AQB - BMW X1 (E84) xDrive 18 d 10.2009/06.2015 105KW 143CV 1995CC N47 D20 C 0005BDO 0005AQA</p> <p>B335-46/46mm 71x89x68x95mm</p>		<p><b>S1617</b> NO. 31126768818</p> <p><b>SILENT-BLOC BRAÇO SUSPENSÃO DA FRENTE PARTE TRÁS</b></p> <p>BMW X1 (E84) xDrive 18 d 03.2009/06.2015 100KW 136CV 1995CC N47 D20 C 0005BDJ 0005AQB - BMW X1 (E84) xDrive 18 d 10.2009/06.2015 105KW 143CV 1995CC N47 D20 C 0005BDO 0005AQA - BMW X1 (E84) xDrive 20 d 09.2009/06.2012 130KW 177CV 1995CC N47 D20 C 0005BDI 0005APS 0005APT 0005BAU 0005BBH - BMW X1 (E84) xDrive 20 d 03.2010/06.2015 120KW 163CV 1995CC N47 D20 C 0005BDN 0005APX 0005BAT 0005BBE - BMW X1 (...)</p> <p>d70x66mm c61mm 1f-d12mm</p>
	<p><b>S1875</b> NO. 33176760288 - 33176770866</p> <p><b>SILENT-BLOC DA CAIXA VELOCIDADES AUTOMÁTICA</b></p> <p>BMW X1 (E84) sDrive 18 d (De 12.2009 Até 06.2015) 105kW 143cv 1995cm3 Combi - BMW X1 (E84) sDrive 20 d (De 10.2009 Até 06.2015) 130kW 177cv 1995cm3 Combi - BMW X1 (E84) xDrive 18 d (De 10.2009 Até 06.2015) 105kW 143cv 1995cm3 Combi - BMW X1 (E84) xDrive 20 d (De 09.2009 Até 06.2012) 130kW 177cv 1995cm3 Combi - BMW X1 (E84) xDrive 23 d (De 10.2009 Até 06.2015) 150kW 204cv 1995cm3 Combi - BMW X1 (E84)...</p> <p>d69x57mm 1f-11x14mm</p>		<p><b>T0624-I</b> NO. 31330146239 - 31331094749 - 31336764085</p> <p><b>BATENTE SUSPENSÃO FRENTE</b></p> <p>BMW X1 (E84) sDrive 16 d 04.2012/06.2015 85KW 116CV 1995CC N47 D20 C 0005BNA 0005BKF - BMW X1 (E84) sDrive 18 d 12.2009/06.2015 105kW 143CV 1995CC N47 D20 C 0005BDL 0005APY - BMW X1 (E84) sDrive 18 i 03.2010/06.2015 110KW 150CV 1995CC N46 B20 CC N46 B20 CD N46 B20 C N46 B20 E N46 B20 B N46 B20 BD 0005AYQ - BMW X1 (E84) sDrive 20 d 10.2009/06.2015 130KW 177CV 1995CC N47 D20 C 0005BDM 0005APS - BMW ...</p> <p>d58x87mm 1f-d27mm 1f-d23mm</p>
	<p><b>U7033K</b> NO. 61671378609 - 64500149356 - 64500301636 - 64501363572 - 64501468019 - 64501468463 - 64508390601</p> <p><b>ORINGS BOMBA DIREÇÃO ASSITIDA</b></p> <p>BMW X1 (E84) xDrive 18 d (03.2009 - 06.2015) 100kw 136cv 1995cm3 SUV BMW X1 (E84) xDrive 18 d (10.2009 - 06.2015) 105kw 143cv 1995cm3 SUV BMW X1 (E84) xDrive 20 d (03.2010 - 06.2015) 120kw 163cv 1995cm3 SUV BMW X1 (E84) xDrive 20 d (09.2009 - 06.2012) 130kw 177cv 1995cm3 SUV BMW X1 (E84) xDrive 20 d (07.2012 - 06.2015) 135kw 184cv 1995cm3 SUV BMW X1 (E84) xDrive 20 i (09.2011 - 06.2015) 135kw 184...</p> <p>d11x2mm d10x2mm 1f-d7mm 1f-d6mm</p>		<p><b>UAP81292</b> NO. 13532247156 - 2247156</p> <p><b>ANILHA PROTEÇÃO TÉRMICA INJECTORES</b></p> <p>BMW X1 (E84) sDrive 16 d (De 04-2012 Até 06-2015) 85kW 116CV 1995cc Combi BMW X1 (E84) sDrive 18 d (De 10-2009 Até 06-2015) 105kW 143CV 1995cc Combi BMW X1 (E84) xDrive 18 d (De 10-2009 Até 06-2015) 105kW 143CV 1995cc Combi BMW X1 (E84) sDrive 20 d (De 10-2009 Até 06-2015) 130kW 177CV 1995cc Combi BMW X1 (E84) xDrive 20 d (De 10-2009 Até 06-2015) 130kW 177CV 1995cc Combi BMW X1 (E84) xDrive 20 d (De 10-2009 Até 06-2015) 130kW 177CV 1995cc Combi BMW X1 (E84) sDrive 20 d (...)</p> <p>d16x1mm 1f-d7mm</p>
	<p><b>UAP81905</b> NO. 13532247156 - 2247156</p> <p><b>ANILHA PROTEÇÃO TÉRMICA INJECTORES</b></p> <p>BMW X1 (E84) sDrive 16 d (De 04-2012 Até 06-2015) 85kW 116CV 1995cc Combi BMW X1 (E84) sDrive 18 d (De 10-2009 Até 06-2015) 105kW 143CV 1995cc Combi BMW X1 (E84) xDrive 18 d (De 10-2009 Até 06-2015) 105kW 143CV 1995cc Combi BMW X1 (E84) sDrive 20 d (De 10-2009 Até 06-2015) 130kW 177CV 1995cc Combi BMW X1 (E84) xDrive 20 d (De 10-2009 Até 06-2015) 130kW 177CV 1995cc Combi BMW X1 (E84) sDrive 20 d (...)</p> <p>d14x1mm 1f-d7mm</p>		<p><b>UMV25105</b> NO. 25117531232</p> <p><b>MANETE PUNHO TOPO ALAVANCA MUDANÇAS 6 VELOCIDADES F14MM</b></p> <p>BMW X1 (E84) xDrive 25 i 03.2010/08.2011 160KW 218CV 2996CC - BMW X1 (E84) xDrive 28 i 09.2009/08.2011 190KW 258CV 2996CC - BMW X1 (E84) sDrive 18 d 03.2009/06.2015 100KW 136CV 1995CC - BMW X1 (E84) sDrive 18 d 03.2009/06.2015 100KW 136CV 1995CC - BMW X1 (E84) sDrive 18 d 12.2009/06.2015 105KW 143CV 1995CC - BMW X1 (E84) xDrive 18 d 10.2009/06.2015 105KW 143CV 1995CC - BMW X1 (E84) sDrive 2...</p> <p>d46x94mm 1f-d14mm</p>
	<p><b>UMV25106</b> NO. 25117503100 - 25117566267</p> <p><b>MANETE PUNHO TOPO ALAVANCA MUDANÇAS 5 VELOCIDADES F14MM</b></p> <p>BMW X1 (E84) sDrive 16 d 04.2012/06.2015 85KW 116CV 1995CC N47 D20 C 0005BNA 0005BKF - BMW X1 (E84) sDrive 16 i 03.2013/06.2015 105kW 143CV 1592CC N20 B16 A 0005BOR - BMW X1 (E84) sDrive 18 d 03.2009/06.2015 100KW 136CV 1995CC N47 D20 C 0005BDQ 0005APZ - BMW X1 (E84) sDrive 18 d 12.2009/06.2015 105KW 143CV 1995CC N47 D20 C 0005BDL 0005APY - BMW X1 (E84) sDrive 18 i 03.2010/06.2015 110KW 150CV 1995...</p> <p>95x45x55mm 1f-d14mm</p>		<p><b>UMV25127</b> NO. 25112229442 - 25117566267 - 25117833136 - 25118037305</p> <p><b>MANETE PUNHO TOPO ALAVANCA MUDANÇAS 5 VELOCIDADES F14MM</b></p> <p>BMW X1 (E84) sDrive 16 d (De 04.2012 Até 06.2015) 85kW 116cv 1995cm3 SUV - BMW X1 (E84) sDrive 16 i (De 03.2013 Até 06.2015) 105kW 143cv 1592cm3 SUV - BMW X1 (E84) sDrive 18 d (De 03.2009 Até 06.2015) 100kW 136cv 1995cm3 SUV - BMW X1 (E84) sDrive 18 d (De 12.2009 Até 06.2015) 105kW 143cv 1995cm3 SUV - BMW X1 (E84) sDrive 18 i (De 03.2010 Até 06.2015) 110kW 150cv 1995cm3 SUV - BMW X1 (E84) sDrive 2...</p> <p>d46x94mm 1f-d14mm</p>



	<p><b>UTR0848</b> NO. 17117521071</p> <p>TAMPÃO RESERVATÓRIO LIQUIDO REFRIGERAÇÃO</p> <p>BMW X1 ( E 84 ) s Drive 16 i (03.13 A 06.15) 143cv 1592cc Combi - BMW X1 (E84) sDrive 18 i (01.10 A 06.15) 150cv 1995cc Combi - BMW X1 (E84) sDrive 20 i (09.11 A 06.15) 184cv 1997cc Combi - BMW X1 (E84) xDrive 20 i (09.11 A 06.15) 184cv 1997cc Combi - BMW X1 (E84) xDrive 25 i (01.10 A 06.15) 218cv 2996cc Combi - BMW X1 (E84) xDrive 28 i (04.11 A 06.15) 245cv 1997cc Combi - BMW X1 (E84)...</p> <p>d88x45mm 1f-d53x25mm</p>		<p><b>W5109</b> NO. 11237797995 - 11237797996 - 11237799153 - 11237823191 - 11238578993 - 11238585220 - 11238651643</p> <p>POLIE DA CAMBOTA (6 PISTAS)</p> <p>BMW SÉRIE X1 (E84) Sdrive 18 D 143CV (APÓS 10-2009) - Sdrive 20D 177CV (APÓS 10-2009) - Xdrive 18D 143CV (APÓS 10-2009) - Xdrive 20D 177CV (APÓS 10-2009)</p> <p>d190mm 4f-d10mm</p>
	<p><b>W5141</b> NO. 11237797996 - 11238513539 - 11238578993 - 11238585220 - 11238651643</p> <p>POLIE DA CAMBOTA 7 PISTAS</p> <p>BMW X1 (E84) xDrive 25 d (10.09 A 06.15) 218cv 1995cc Combi</p> <p>d166,7mm d10mm</p>		<p><b>W5142</b> NO. 11237797996 - 11238512072 - 11238578993 - 11238585220 - 11238651643</p> <p>POLIE DA CAMBOTA 6 PISTAS</p> <p>BMW X1 (E84) sDrive 16 d (04.12 A 06.15) 116cv 1995cc Combi - BMW X1 (E84) sDrive 18 d (10.09 A 06.15) 143cv 1995cc Combi</p> <p>d185mm d10mm</p>
	<p><b>W5184</b> NO. 11237643074 - 11238584913</p> <p>POLIE DA CAMBOTA (6 PISTAS)</p> <p>BMW X1 (F48): sDrive 16 d 11.2014/&gt;&gt;&gt; 85KW 116CV 1496CC</p> <p>d157/68mm d38mm</p>		<p><b>W5184</b> NO. 11237643074 - 11238584913</p> <p>POLIE DA CAMBOTA (6 PISTAS)</p> <p>BMW X2 (F39): sDrive 16 d 11.2018/&gt;&gt;&gt; 85KW 116CV 1496CC</p> <p>d157/68mm d38mm</p>
	<p><b>W5192</b> NO. 11238602800</p> <p>POLIE DA CAMBOTA (6 PISTAS)</p> <p>BMW X2 (F39): sDrive 20 i 11.2017/&gt;&gt;&gt; 141KW 192CV 1998CC - BMW X2 (F39): sDrive 18 d 03.2018/&gt;&gt;&gt; 110KW 150CV 1995CC - BMW X2 (F39): sDrive 20 d 11.2018/&gt;&gt;&gt; 140KW 190CV 1995CC - BMW X2 (F39): xDrive 18 d 03.2018/&gt;&gt;&gt; 110KW 150CV 1995CC - BMW X2 (F39): xDrive 20 d 11.2017/&gt;&gt;&gt; 140KW 190CV 1995CC</p> <p>d158mm d59mm</p>		<p><b>W5199</b> NO. 11234724814 - 11237803851 - 11237810458</p> <p>POLIE DA CAMBOTA (6 PISTAS)</p> <p>BMW X1 (E84): xDrive 23 d 10.2009/06.2015 150KW 204CV 1995CC</p> <p>d192/172mm d40mm</p>
	<p><b>Z55184</b> NO. 07147443710 - 07142754954</p> <p>MOLA DO PAINEL DA PORTA MOLDURA</p> <p>BMW X1 (A partir de 2014)</p> <p>F9mm T17mm L11mm H17mm S1-8mm</p>		<p><b>Z55278</b> NO. 51410407983 - 51418224781 - 51430141025</p> <p>MOLA PAINEL RESVESTIMENTO PORTAS</p> <p>BMW X1 (E84) sDrive 16 d (04.2012 - 06.2015) 85kw 116cv 1995cm3 SUV BMW X1 (E84) sDrive 16 i (03.2013 - 06.2015) 105kw 143cv 1592cm3 SUV BMW X1 (E84) sDrive 18 d (03.2009 - 06.2015) 100kw 136cv 1995cm3 SUV BMW X1 (E84) sDrive 18 d (12.2009 - 06.2015) 105kw 143cv 1995cm3 SUV BMW X1 (E84) sDrive 18 i (03.2010 - 06.2015) 110kw 150cv 1995cm3 SUV BMW X1 (E84) sDrive 20 d (03.2010 - 06.2015) 120kw 163cv...</p> <p>F-8T-18mm L-14H-21S1-7mm</p>
	<p><b>Z80910</b> NO. 51777171002</p> <p>MOLA DO PAINEL DA PORTA</p> <p>BMW X1 (F48) sDrive 16 d desde 11.2014 85KW 116CV 1496CC B37 C15 A 0005CKU 0005CCD - BMW X1 (F48) sDrive 18 d desde 07.2015 110KW 150CV 1995CC B47 C20 A B47 C20 B 0005CKV 0005CCE - BMW X1 (F48) sDrive 18 i desde 11.2015 100KW 136CV 1499CC B38 A15 A 0005CKQ 0005CBZ - BMW X1 (F48) sDrive 18 i desde 07.2017 103KW 140CV 1499CC B38 A15 A 0005CPA - BMW X1 (F48) sDrive 20 d desde 11.2015 120KW 163CV 1995...</p> <p>F-8 T-18 L-16 H-21 S1-3</p>		<p><b>Z80910</b> NO. 51777171002</p> <p>MOLA DO PAINEL DA PORTA</p> <p>BMW X2 (F39) M35 i desde 11.2018 225KW 306CV 1998CC B48 A20 E 0005CRC - BMW X2 (F39) sDrive 16 d desde 11.2018 85KW 116CV 1496CC B37 C15 A 0005CRD - BMW X2 (F39) sDrive 18 d desde 03.2018 100KW 136CV 1995CC B47 C20 B B47 C20 A 0005CRF - BMW X2 (F39) sDrive 18 d desde 03.2018 110KW 150CV 1995CC B47 C20 A B47 C20 B 0005CRE - BMW X2 (F39) sDrive 18 i desde 03.2018 100KW 136CV 1499CC B38 A15 A B32 S15...</p> <p>F-8 T-18 L-16 H-21 S1-3</p>

## BMW X3(E83)

	<p><b>D0030</b> NO. 26111229754 - 26117572664</p> <p>CARDAN TRANSMISSÃO D162X42MM 6 FUROS 12MM ENTRE FUROS 110MM</p> <p>BMW X3 (E83) 2.0 d 09.2004/08.2007 110KW 150CV 1995CC M47 D20 (204D4) 0005808 0005ACD - BMW X3 (E83) xDrive 18 d 09.2008/12.2011 105KW 143CV 1995CC N47 D20 C 0005APG</p> <p>d160x42mm 1f-d45mm 6f-d12mm</p>		<p><b>D0063</b> NO. 26117542238</p> <p>CARDAN DA TRANSMISSÃO</p> <p>BMW X3 (E83) 2.5 si (De 09-2006 Até 08-2008) 160KW 218CV 2497cc Veículo todo-terreno fechado BMW X3 (E83) 3.0 si (De 09-2006 Até 08-2008) 200KW 272CV 2996cc Veículo todo-terreno fechado BMW X3 (E83) 2.0 d (De 03-2007 Até 08-2007) 130KW 177CV 1995cc Veículo todo-terreno fechado BMW X3 (E83) 3.0 sd (De 09-2006 Até 08-2008) 210KW 286CV 2993cc Veículo todo-terreno fechado</p> <p>163x155x42mm 6f-d12mm</p>
--	--	---	---

	<p><b>F1799-I</b> NO. 33211229593 - 33217529916 - 33217547081</p> <p>FOLE TRANSMISSÃO JUNTO A CAIXA FALANGE D105MM</p> <p>BMW X3 (E83) (APÓS 2004) 2.0 TDCR 4X4 - 3.0 TDCR 4X4 - 3.0i 4X4</p> <p>d102x100mm 1f-d100mm 1f-d23mm</p>		<p><b>F1846-I</b> NO. 33211229594 - 33217527325 - 33217527326 - 33217529915 - 33217547080</p> <p>FOLE DA TRANSMISSÃO JUNTO Á RODA</p> <p>BMW X3 (E83) 2.0 TDCR 4X4 - 3.0i 4X4 - 3.0 TDCR 4X4 (APÓS 2004)</p> <p>d80x78mm 1f-d51mm 1f-d31mm</p>
	<p><b>F1847-I</b> NO. 33211229590 - 33217527323 - 33217527324 - 33217529919</p> <p>FOLE DA TRANSMISSÃO JUNTO Á RODA</p> <p>BMW X3 (E83) 2.5i 4X4 - 3.0i 4X4 (APÓS 2004)</p> <p>d80x78mm 1f-d44mm 1f-d30mm</p>		<p><b>F4207</b> NO. 25118036629 - 25118037309</p> <p>FOLE ALAVANCA VELOCIDADES C/ MANETE PUNHO TOPO COMPLETO 6 VELOCIDADES</p> <p>BMW E83</p> <p>172x153x212mm 135x145mm</p>
	<p><b>KF9024</b> NO. 31607529204</p> <p>KIT DE FOLE TRANSMISSÃO JUNTO CAIXA</p> <p>BMW X3 (E83) 2.0 i (07.05 - 08.08) 150cv 1995cc Veículo todo-terreno fechado - BMW X3 (E83) 2.5 i (01.04 - 08.06) 192cv 2494cc Veículo todo-terreno fechado - BMW X3 (E83) 2.5 si (09.06 - 08.08) 218cv 2497cc Veículo todo-terreno fechado - BMW X3 (E83) xDrive 25 i (09.08 - 12.11) 218cv 2497cc Veículo todo-terreno fechado - BMW X3 (E83) 3.0 i xDrive (01.04 - 08.06) 231cv 2979cc Veículo todo-terreno f...</p> <p>d90x90mm 1f-d22mm 1f-d80mm</p>		<p><b>KT0624-I</b> NO. 31330146239 - 31331094749 - 31336764085</p> <p>KIT BATENTE SUSPENSÃO DA FRENTE</p> <p>BMW X3 (E83) 2.0 i (De 07-2005 Até 08-2008) 110KW 150CV 1995cc Veículo todo-terreno fechado BMW X3 (E83) 2.5 i (De 01-2004 Até 08-2006) 141kW 192CV 2494cc Veículo todo-terreno fechado BMW X3 (E83) 3.0 i xDrive (De 01-2004 Até 08-2006) 170kW 231CV 2979cc Veículo todo-terreno fechado BMW X3 (E83) 2.0 d (De 11-2003 Até 08-2007) 110KW 150CV 1995cc Veículo todo-terreno fechado BMW X3 (E83) 3.0 ...</p> <p>d90x190mm 1f-d23mm 1f-d70mm</p>
	<p><b>KUBT3023</b> NO. 1f-d39mm(x2) 1f-d48mm(x2) 1f-d5mm</p> <p>KIT BORRACHAS TRAVAO PINÇA TRAS BRENBO 40MM</p> <p>BMW X3 (G01, F97) M desde 03.2019 353KW 480CV 2993CC S58 B30 A 7909ACG - BMW X3 (G01, F97) M Competition desde 03.2019 375KW 510CV 2993CC S58 B30 A 7909ACF - BMW X3 (G01, F97) xDrive 20 d 08.2017/03.2020 140KW 190CV 1995CC B47 D20 B47 D20 A 0005CQN 0005CRW - BMW X3 (G01, F97) xDrive 20 i desde 12.2017 135KW 184CV 1998CC B48 B20 AB48 B20 B 0005CRU - BMW X3 (G01, F97) xDrive 25 d desde 04.2018 155K...</p> <p>d59x12mm(x2) d54x3mm(x2) d55mm(x2) 1f-d48mm(x2) 1f-d5mm 1f-d39mm</p>		<p><b>KUBT3027</b> NO. 34103413265 - 34116750151</p> <p>KIT BORRACHAS TRAVAO PINÇA FRENTE ATE/TEVES 57MM</p> <p>BMW X3 (E83) 2.0 d 09.2004/08.2007 110KW 150CV 1995CC M47 D20 (204D4) 0005808 0005ACD - BMW X3 (E83) 2.0 i 07.2005/08.2008 110KW 150CV 1995CC N46 B20 B 0005AGS 0005851 0005AKL - BMW X3 (E83) 2.0 sd 09.2007/08.2008 130KW 177CV 1995CC N47 D20 A 0005AKJ - BMW X3 (E83) 2.5 i 03.2004/07.2006 141KW 192CV 2494CC M54 B25 (256S5) 0005789 - BMW X3 (E83) 2.5 si 08.2006 - 08.2008 160 218 2497 N52 B25 A N52 B2...</p> <p>d70x13mm d66x3mm d14x9mm d13mm 1f59mm 1f-d5mm</p>
	<p><b>KUBT3037</b> NO. 1f-d31mm 1f-d12/16mm 1f-d43mm 1f-d</p> <p>KIT BORRACHAS TRAVAO PINÇA TRAS ATE 42MM</p> <p>BMW X3 (E83) 2.0 d 09.2004/08.2007 110KW 150CV 1995CC M47 D20 (204D4) 0005808 0005ACD - BMW X3 (E83) 2.0 i 07.2005/08.2008 110KW 150CV 1995CC N46 B20 B 0005AGS 0005851 0005AKL - BMW X3 (E83) 2.0 sd 09.2007/08.2008 130KW 177CV 1995CC N47 D20 A 0005AKJ - BMW X3 (E83) 2.5 i 03.2004/07.2006 141KW 192CV 2494CC M54 B25 (256S5) 0005789 - BMW X3 (E83) 2.5 si 08.2006/08.2008 160KW 218CV 2497CC N52 B25 A N5...</p> <p>d58x12mm d21x40mm(x2) 1f-d31mm 1f-d12/16mm 1f-d43mm 1f-d13</p>		<p><b>KUR21999</b> NO. 1f-d24mm 1f-d10mm 1f-d10mm 1f-d19mm</p> <p>KIT DE REPARAÇÃO ALAVANCA DE VELOCIDADES</p> <p>BMW X3 (E83) 2.0 d (De 09.2004 Até 08.2007) 110KW 150cv 1995cm3 SUV - BMW X3 (E83) 2.0 i (De 07.2005 Até 08.2008) 110KW 150cv 1995cm3 SUV - BMW X3 (E83) 2.0 sd (De 09.2007 Até 08.2008) 130KW 177cv 1995cm3 SUV - BMW X3 (E83) 2.5 i (De 03.2004 Até 07.2006) 141KW 192cv 2494cm3 SUV - BMW X3 (E83) 2.5 si (De 08.2006 Até 08.2008) 160KW 218cv 2497cm3 SUV - BMW X3 (E83) 3.0 d (De 01.2004 Até 08.2005) 150k...</p> <p>d37x18mm d19x25mm d17x22mm d31x210mm d31x210mm d41x200mm d41x190mm d41x190mm</p>
	<p><b>P1042</b> NO. 35211160422</p> <p>CAPA DE PEDAL</p> <p>BMW X3 (E83) 2.0 i 07.2005/08.2008 110KW 150CV 1995CC N46 B20 B 0005AGS 0005851 0005AKL - BMW X3 (E83) 2.0 sd 09.2007/08.2008 130KW 177CV 1995CC N47 D20 A 0005AKJ - BMW X3 (E83) 3.0 d 09.2005/08.2008 160KW 218CV 2993CC M57 D30 (306D3) 0005853 0005AKO 0005ACB - BMW X3 (E83) xDrive 20 d 09.2008/08.2010 120KW 163CV 1995CC N47 D20 A N47 D20 C 0005AKK - BMW X3 (E83) xDrive 20 d 09.2008/08.2010 130KW 17...</p> <p>75x65x40mm</p>		<p><b>P1055</b> NO. 35211160421</p> <p>CAPA DE PEDAL DO TRAVÃO(VEICULOS COM CAIXA AUTOMÁTICA)</p> <p>BMW X3 (E83) 2.0 d 09.2004/08.2007 110KW 150CV 1995CC M47 D20 (204D4) 0005808 0005ACD - BMW X3 (E83) 2.5 i 03.2004/07.2006 141KW 192CV 2494CC M54 B25 (256S5) 0005789 - BMW X3 (E83) 3.0 d 01.2004/08.2005 150KW 204CV 2993CC M57 D30 (306D2) 0005788 - BMW X3 (E83) 3.0 i xDrive 09.2003/07.2006 170KW 231CV 2979CC M54 B30 (306S3) 0005787</p> <p>74x107x42mm</p>
	<p><b>R080024</b> NO. 48-56-36-225-27-41-19mm 1f-d6mm 1f-d</p> <p>TUBO RIGIDO DE REFRIGERAÇÃO</p> <p>BMW X3 (E83) 2.5 i 03.2004/07.2006 141KW 192CV 2494CC M54 B25 (256S5) 0005789 - BMW X3 (E83) 3.0 i xDrive 09.2003/07.2006 170KW 231CV 2979CC M54 B30 (306S3) 0005787</p> <p>B475-14/17mm 48-56-36-225-27-41-19mm 1f-d6mm 1f-d</p>		<p><b>R225320</b> NO. 11613405535 - 11613450222</p> <p>TUBO DO AR SOBREALIMENTAÇÃO</p> <p>BMW X3 (E83) 2.0 d (De 2003.11 Até 2007.08) 110KW 150cv 1995cm3 Veículo todo-terreno fechado - BMW X3 (E83) 2.0 d (De 2007.03 Até 2009.03) 130KW 177cv 1995cm3 Veículo todo-terreno fechado - BMW X3 (E83) xDrive 20 d (De 2007.09 Até 2010.08) 120KW 163cv 1995cm3 Veículo todo-terreno fechado - BMW X3 (E83) xDrive 20 d (De 2007.09 Até 2010.08) 130KW 177cv 1995cm3 Veículo todo-terreno...</p> <p>B275-54/55mm B184-46/55mm 133x40mm 67x61x71mm</p>
	<p><b>S1271</b> NO. 31106770689 - 31106770690 - 31121092019 - 31121094235 - 31121122462 - 31121124622 - 31121133236 - 31121133237</p> <p>SILENT-BLOC DO BRAÇO DA SUSPENSÃO (FRENTE CENTRO)</p> <p>BMW X3 (E83) 2.0 d 09.2004/08.2007 110KW 150CV 1995CC M47 D20 (204D4) 0005808 0005ACD - BMW X3 (E83) 2.0 i 07.2005/08.2008 110KW 150CV 1995CC N46 B20 B 0005AGS 0005851 0005AKL - BMW X3 (E83) 2.0 sd 09.2007/08.2008 130KW 177CV 1995CC N47 D20 A 0005AKJ - BMW X3 (E83) 2.5 i 03.2004/07.2006 141KW 192CV 2494CC M54 B25 (256S5) 0005789 - BMW X3 (E83) 2.5 si 08.2006/08.2008 160KW 218CV 2497CC N52 B25 A N5...</p> <p>d46x52mm c40mm 1f-d12mm</p>		<p><b>S1875</b> NO. 33176760288 - 33176770866</p> <p>SILENT-BLOC DA CAIXA DE VELOCIDADES AUTOMÁTICA</p> <p>BMW X3 (E83) 2.0 i (De 07.2005 Até 08.2008) 110KW 150cv 1995cm3 Veículo todo-terreno fechado - BMW X3 (E83) 2.5 si (De 08.2006 Até 08.2008) 160KW 218cv 2497cm3 Veículo todo-terreno fechado - BMW X3 (E83) 3.0 sd (De 09.2006 Até 08.2008) 210KW 286cv 2993cm3 Veículo todo-terreno fechado - BMW X3 (E83) 3.0 si (De 08.2006 Até 08.2008) 200KW 272cv 2996cm3 Veículo todo-terreno fechado -</p> <p>d69x57mm 1f-11x14mm</p>



	<p><b>S1959</b> NO. 33321092247 - 33321137571</p> <p><b>SILENT-BLOC BRAÇO SUSPENSÃO TRÁS SUPERIOR PARTE INTERIOR</b></p> <p>BMW X3 (E83) 2.0 d (De 09.2004 Até 08.2007) 110kW 150cv 1995cm3 SUV - BMW X3 (E83) 2.0 i (De 07.2005 Até 08.2008) 110kW 150cv 1995cm3 SUV - BMW X3 (E83) 2.0 sd (De 09.2007 Até 08.2008) 130kW 177cv 1995cm3 SUV - BMW X3 (E83) 2.5 i (De 03.2004 Até 07.2006) 141kW 192cv 2494cm3 SUV - BMW X3 (E83) 2.5 si (De 08.2006 Até 08.2008) 160kW 218cv 2497cm3 SUV - BMW X3 (E83) 3.0 d (De 01.2004 Até 08.2005) 150k...</p> <p>d35x66mm c42mm 1f-d12mm</p>		<p><b>S2080</b> NO. 33311092516 - 33316757394 - 33316770784</p> <p><b>SILENT-BLOC DA SUSPENSÃO EIXO TRASEIRO LADO DIREITO</b></p> <p>BMW X3 (E83) 2.0 d (De 09.2004 Até 08.2007) 110kW 150cv 1995cm3 SUV - BMW X3 (E83) 2.0 i (De 07.2005 Até 08.2008) 110kW 150cv 1995cm3 SUV - BMW X3 (E83) 2.0 sd (De 09.2007 Até 08.2008) 130kW 177cv 1995cm3 SUV - BMW X3 (E83) 2.5 i (De 03.2004 Até 07.2006) 141kW 192cv 2494cm3 SUV - BMW X3 (E83) 2.5 si (De 08.2006 Até 08.2008) 160kW 218cv 2497cm3 SUV - BMW X3 (E83) 3.0 d (De 01.2004 Até 08.2005) 150k...</p> <p>d81x 63mm d70mm 1f-d12mm</p>
	<p><b>S2081</b> NO. 33311092515 - 33316757393 - 33316770783</p> <p><b>SILENT-BLOC DA SUSPENSÃO EIXO TRASEIRO LADO ESQUERDO</b></p> <p>BMW X3 (E83) 2.0 d (De 09.2004 Até 08.2007) 110kW 150cv 1995cm3 SUV - BMW X3 (E83) 2.0 i (De 07.2005 Até 08.2008) 110kW 150cv 1995cm3 SUV - BMW X3 (E83) 2.0 sd (De 09.2007 Até 08.2008) 130kW 177cv 1995cm3 SUV - BMW X3 (E83) 2.5 i (De 03.2004 Até 07.2006) 141kW 192cv 2494cm3 SUV - BMW X3 (E83) 2.5 si (De 08.2006 Até 08.2008) 160kW 218cv 2497cm3 SUV - BMW X3 (E83) 3.0 d (De 01.2004 Até 08.2005) 150...</p> <p>d82x 63mm d70mm 1f-d12mm</p>		<p><b>T0627-I</b> NO. 31331094750 - 31336771380</p> <p><b>BATENTE SUSPENSÃO FRENTE</b></p> <p>BMW X3 (E83) 2.0 d 09.2004/08.2007 110KW 150CV 1995CC M47 D20 (204D4) 0005808 0005ACD - BMW X3 (E83) 2.0 i 07.2005/08.2008 110KW 150CV 1995CC N46 B20 B 0005AGS 0005851 0005AKL - BMW X3 (E83) 2.5 i 03.2004/07.2006 141KW 192CV 2494CC M54 B25 (256S5) 0005789 - BMW X3 (E83) 3.0 d 01.2004/08.2005 150KW 204CV 2993CC M57 D30 (306D2) 0005788 - BMW X3 (E83) 3.0 d 09.2005/08.2008 160KW 218CV 2993CC M57 D30 ...</p> <p>d68x86mm 1f-d28mm 1f-d26mm</p>
	<p><b>U7033K</b> NO. 61671378609 - 64500149356 - 64500301636 - 64501363572 - 64501466019 - 64501468463 - 64508390601</p> <p><b>ORINGS BOMBA DIREÇÃO ASSISTIDA</b></p> <p>BMW X3 (E83) 2.0 d (09.2004 - 08.2007) 110kW 150cv 1995cm3 SUV BMW X3 (E83) 2.5 i (03.2004 - 07.2006) 141kW 192cv 2494cm3 SUV BMW X3 (E83) 2.5 si (08.2006 - 08.2008) 160kW 218cv 2497cm3 SUV BMW X3 (E83) 3.0 d (01.2004 - 08.2005) 150kW 204cv 2993cm3 SUV BMW X3 (E83) 3.0 d (09.2005 - 08.2008) 160kW 218cv 2993cm3 SUV BMW X3 (E83) 3.0 i xDrive (09.2003 - 07.2006) 170kW 231cv 2979cm3 SUV BMW X3 (E83) ...</p> <p>d11x2mm d10x2mm 1f-d7mm 1f-d6mm</p>		<p><b>UAP81292</b> NO. 13532247156 - 2247156</p> <p><b>ANILHA PROTEÇÃO TÉRMICA INJECTORES</b></p> <p>BMW X3 (E83) xDrive 18 d (De 09-2008 Até 12-2011) 105kW 143CV 1995cc Veículo todo-terreno fechado BMW X3 (E83) 2.0 d (De 03-2007 Até 03-2009) 130kW 177CV 1995cc Veículo todo-terreno fechado BMW X3 (E83) xDrive 20 d (De 09-2007 Até 08-2010) 130kW 177CV 1995cc Veículo todo-terreno fechado BMW X3 (E83) 3.0 d (De 01-2004 Até 08-2005) 150kW 204CV 2993cc Veículo todo-terreno fechado</p> <p>d16x1mm 1f-d7mm</p>
	<p><b>UAP81905</b> NO. 13532247156 - 2247156</p> <p><b>ANILHA PROTEÇÃO TÉRMICA INJECTORES</b></p> <p>BMW X3 (E83) xDrive 18 d (De 09-2008 Até 12-2011) 105kW 143CV 1995cc Veículo todo-terreno fechado BMW X3 (E83) 2.0 d (De 03-2007 Até 03-2009) 130kW 177CV 1995cc Veículo todo-terreno fechado BMW X3 (E83) xDrive 20 d (De 09-2007 Até 08-2010) 130kW 177CV 1995cc Veículo todo-terreno fechado BMW X3 (E83) 3.0 d (De 01-2004 Até 08-2005) 150kW 204CV 2993cc Veículo todo-terreno fechado</p> <p>d14x1mm 1f-d7mm</p>		<p><b>UAP81905</b> NO. 13532247156 - 2247156</p> <p><b>ANILHA PROTEÇÃO TÉRMICA INJECTORES</b></p> <p>BMW X3 (F25) sDrive 18 d (De 08-2011 Até .1-20 -) 100kW 136CV 1995cc Veículo todo-terreno fechado BMW X3 (F25) sDrive 18 d (De 08-2011 Até .1-20 -) 105kW 143CV 1995cc Veículo todo-terreno fechado BMW X3 (F25) sDrive 18 d (De 02-2014 Até .1-20 -) 110kW 150CV 1995cc Veículo todo-terreno fechado BMW X3 (F25) xDrive 20 d (De 09-2010 Até .1-20 -) 120kW 163CV 1995cc Veículo todo-terreno fechado ...</p> <p>d14x1mm 1f-d7mm</p>
	<p><b>UCRZ1093</b> NO. 26111105398 - 26117518304 - 26203401609 - 26207526677</p> <p><b>CRUZETA DO VEIO TRANSMISSÃO LONGITUDINAL</b></p> <p>BMW X3 (E83) 2.0 d (De 09.2004 Até 08.2007) 110kW 150cv 1995cm3 SUV - BMW X3 (E83) 2.5 i (De 03.2004 Até 07.2006) 141kW 192cv 2494cm3 SUV - BMW X3 (E83) 3.0 d (De 01.2004 Até 08.2005) 150kW 204cv 2993cm3 SUV - BMW X3 (E83) 3.0 d (De 09.2005 Até 08.2008) 160kW 218cv 2993cm3 SUV - BMW X3 (E83) 3.0 i xDrive (De 09.2003 Até 07.2006) 170kW 231cv 2979cm3 SUV - BMW X3 (E83) 3.0 sd (De 09.2006 Até 08.2008)...</p> <p>d24x63mm 43mm</p>		<p><b>UFQ23302</b> NO. 21511223302</p> <p><b>FORQUILHA DA EMBRAIAGEM</b></p> <p>BMW X3 (E83) 2.0 d 09.2004/08.2007 110KW 150CV 1995CC M47 D20 (204D4) 0005808 0005ACD - BMW X3 (E83) 2.5 i 03.2004/07.2006 141KW 192CV 2494CC M54 B25 (256S5) 0005789 - BMW X3 (E83) 3.0 d 01.2004/08.2005 150KW 204CV 2993CC M57 D30 (306D2) 0005788 - BMW X3 (E83) 3.0 i xDrive 09.2003/07.2006 170KW 231CV 2979CC M54 B30 (306S3) 0005787</p> <p>252x83x28mm 1f-47x75mm</p>
	<p><b>UMV25106</b> NO. 25117503100 - 25117566267</p> <p><b>MANETE PUNHO TOPO ALAVANCA MUDANÇAS 5 VELOCIDADES F14MM</b></p> <p>BMW X3 (E83) 2.0 d 09.2004/08.2007 110KW 150CV 1995CC M47 D20 (204D4) 0005808 0005ACD - BMW X3 (E83) 2.0 i 07.2005/08.2008 110KW 150CV 1995CC N46 B20 B 0005AGS 0005851 0005AKL - BMW X3 (E83) 2.5 i 03.2004/07.2006 141KW 192CV 2494CC M54 B25 (256S5) 0005789 - BMW X3 (E83) 2.5 si 08.2006/08.2008 160KW 218CV 2497CC N52 B25 A N52 B25 BF N52 B25 AF 0005AKM 0005AFA - BMW X3 (E83) 3.0 d 01.2004/08.2005 15...</p> <p>95x45x55mm 1f-d14mm</p>		<p><b>UMV25115</b> NO. 25117520201</p> <p><b>MANETE PUNHO TOPO ALAVANCA MUDANÇAS 6 VELOCIDADES F14MM</b></p> <p>BMW X3 (E83) 2.0 d (De 09.2004 Até 08.2007) 110kW 150cv 1995cm3 SUV - BMW X3 (E83) 2.0 i (De 07.2005 Até 08.2008) 110kW 150cv 1995cm3 SUV - BMW X3 (E83) 2.5 i (De 03.2004 Até 07.2006) 141kW 192cv 2494cm3 SUV -</p> <p>d48x94mm 1f-d15mm</p>
	<p><b>UMV25127</b> NO. 25112229442 - 25117566267 - 25117833136 - 25118037305</p> <p><b>MANETE PUNHO TOPO ALAVANCA MUDANÇAS 5 VELOCIDADES F14MM</b></p> <p>BMW X3 (E83) 2.0 d (De 09.2004 Até 08.2007) 110kW 150cv 1995cm3 SUV - BMW X3 (E83) 2.0 i (De 07.2005 Até 08.2008) 110kW 150cv 1995cm3 SUV - BMW X3 (E83) 2.5 i (De 03.2004 Até 07.2006) 141kW 192cv 2494cm3 SUV - BMW X3 (E83) 2.5 si (De 08.2006 Até 08.2008) 160kW 218cv 2497cm3 SUV - BMW X3 (E83) 3.0 d (De 01.2004 Até 08.2005) 150kW 204cv 2993cm3 SUV - BMW X3 (E83) 3.0 d (De 09.2005 Até 08.2008) 160kW...</p> <p>d46x94mm 1f-d14mm</p>		<p><b>UTR0802</b> NO. 171121321D - 377121321A - 443121131 - 443121321 - 443121321A - 547121321</p> <p><b>TAMPÃO RESERVATÓRIO LIQUIDO REFRIGERAÇÃO</b></p> <p>BMW X3 (E83) 3.0 si (09.06 A 08.08) 272cv 2996cc Veículo todo-terreno fechado</p> <p>d58x24mm 1f-d49x13mm</p>
	<p><b>UTR0812</b> NO. 17110152374 - 17111468076 - 17111712492 - 17111712669 - 17111742231 - 17117639022 - 17119071581</p> <p><b>TAMPÃO RESERVATÓRIO LIQUIDO REFRIGERAÇÃO</b></p> <p>BMW X3 (E83) 2.0 i (07.05 A 08.08) 150cv 1995cc Veículo todo-terreno fechado 5/5 - BMW X3 (E83) 2.5 i (01.04 A 08.06) 192cv 2494cc Veículo todo-terreno fechado - BMW X3 (E83) 3.0 i xDrive (01.04 A 08.06) 231cv 2979cc Veículo todo-terreno fechado</p> <p>d65x45mm 1f-d52x20mm</p>		<p><b>UTR0848</b> NO. 17117521071</p> <p><b>TAMPÃO RESERVATÓRIO LIQUIDO REFRIGERAÇÃO</b></p> <p>BMW X3 (F25) sDrive 20 i (A Partir de 02.14) 184cv 1997cc Veículo todo-terreno fechado - BMW X3 (F 25) x Drive 2 i (A Partir de 09.11) 184cv 1997cc Veículo todo-terreno fechado - BMW X3 (F 25) x Drive 28 i (A Partir de 08.11) 245cv 1997cc Veículo todo-terreno fechado - BMW X3 (F 25) x Drive 28 i (A Partir de 04.11) 258cv 2996cc Veículo todo-terreno fechado BMW X3 (F 25) x Drive 3...</p> <p>d88x45mm 1f-d53x25mm</p>



	<p><b>W5099</b> NO. 11232247932 - 1123778611 - 1123778611 - 11237793593 - 11238511371</p> <p>POLIE DA CAMBOTA (4+6 PISTAS)</p> <p>BMW X3 (E83) 3.0 d 01.2004/08.2005 150KW 204CV 2993CC M57 D30 (306D2) 0005788 - BMW X3 (E83) 3.0 d 09.2005/08.2008 160KW 218CV 2993CC M57 D30 (306D3) 0005853, 0005AKO, 0005ACB - BMW X3 (E83) 3.0 sd 09.2006/08.2008 210KW 286CV 2993CC M57 D30 (306D5) 0005AKQ, 0005AEZ - BMW X3 (E83) xDrive 30 d 09.2008/08.2010 160KW 218CV 2993CC M57 D30 (306D3) 0005853, 0005AKO, 0005ACB - BMW X3 (E83) xDrive 35 d 09....</p> <p>d191mm</p>		<p><b>W5099-C</b> NO. 1123778611 - 11237793593</p> <p>POLIE DA CAMBOTA (4+6 PISTAS)</p> <p>BMW X3 (E83) 3.0 d 01.2004/08.2005 150KW 204CV 2993CC M57 D30 (306D2) 0005788 - BMW X3 (E83) 3.0 d 09.2005/08.2008 160KW 218CV 2993CC M57 D30 (306D3) 0005853, 0005AKO, 0005ACB - BMW X3 (E83) 3.0 sd 09.2006/08.2008 210KW 286CV 2993CC M57 D30 (306D5) 0005AKQ, 0005AEZ - BMW X3 (E83) xDrive 30 d 09.2008/08.2010 160KW 218CV 2993CC M57 D30 (306D3) 0005853, 0005AKO, 0005ACB - BMW X3 (E83) xDrive 35 d 09....</p> <p>d191mm</p>
	<p><b>W5109</b> NO. 11237797995 - 11237797996 - 11237799153 - 11237823191 - 11238578993 - 11238585220 - 11238651643</p> <p>POLIE DA CAMBOTA (6 PISTAS)</p> <p>BMW SÉRIE X3 (E83) 2.0 D 150CV (APÓS 10-2004)</p> <p>d190mm 4f-d10mm</p>		<p><b>W5186</b> NO. 11238515002</p> <p>POLIE DA CAMBOTA (6 PISTAS)</p> <p>BMW X3 (F25): xDrive 35 d 10.2011/08.2017 230KW 313CV 2993CC</p> <p>d195/170mm d40mm</p>
	<p><b>W5225</b> NO. 32417787106</p> <p>POLIE DA BOMBA HIDRÁULICA</p> <p>BMW X3 (E83) 3.0 d 01.2004/08.2005 150KW 204CV 2993CC M57 D30 (306D2) 0005788 - BMW X3 (E83) 3.0 d 09.2005/08.2008 160KW 218CV 2993CC M57 D30 (306D3) 0005853 0005AKO 0005ACB - BMW X3 (E83) 3.0 sd 09.2006/08.2008 210KW 286CV 2993CC M57 D30 (306D5) 0005AKQ 0005AEZ</p> <p>d143x28mm 1f-d30mm 3f-d8mm</p>		<p><b>Z55278</b> NO. 51410407983 - 51418224781 - 51430141025</p> <p>MOLA PAINEL RESVESTIMENTO PORTAS</p> <p>BMW X3 (E83) 2.0 d (09.2004 - 08.2007) 110kw 150cv 1995cm3 SUV          BMW X3 (E83) 2.0 i (07.2005 - 08.2008) 110kw 150cv 1995cm3 SUV          BMW X3 (E83) 2.0 sd (09.2007 - 08.2008) 130kw 177cv 1995cm3 SUV          BMW X3 (E83) 2.5 i (03.2004 - 07.2006) 141kw 192cv 2494cm3 SUV          BMW X3 (E83) 2.5 si (08.2006 - 08.2008) 160kw 218cv 2497cm3 SUV          BMW X3 (E83) 3.0 d (01.2004 - 08.2005) 150kw 204cv 2993cm3 SUV          BMW X3 (E83) 3.0 d (...)</p> <p>F-8T-18mm L-14H-21S1-7mm</p>
	<p><b>Z86003</b> NO. 51711932996</p> <p>MOLAS FIXAÇÃO MOLDURA PORTAS</p> <p>BMW X3 (E83) 2.0 d 09.2004/08.2007 110KW 150CV 1995CC M47 D20 (204D4) 0005808 0005ACD - BMW X3 (E83) 2.0 i 07.2005/08.2008 110KW 150CV 1995CC N46 B20 B 0005AGS 0005851 0005AKL - BMW X3 (E83) 2.0 sd 09.2007/08.2008 130KW 177CV 1995CC N47 D20 A 0005AKJ - BMW X3 (E83) 2.5 i 03.2004/07.2006 141KW 192CV 2494CC M54 B25 (256S5) 0005789 - BMW X3 (E83) 2.5 si 08.2006/08.2008 160KW 218CV 2497CC N52 B25 A N5...</p> <p>F-4G- mm T-12L-8H-7S-1mm</p>		

BMW X3(F25)

	<p><b>UMV25105</b> NO. 25117531232</p> <p>MANETE PUNHO TOPO ALAVANCA MUDANÇAS 6 VELOCIDADES F14MM</p> <p>BMW X3 (F25): xDrive 20 d 09.2010/03.2014 120KW 163CV 1995CC - BMW X3 (F25): xDrive 20 d 09.2010/03.2014 135KW 184CV 1995CC</p> <p>d46x94mm 1f-d14mm</p>		<p><b>W5192</b> NO. 11238602800</p> <p>POLIE DA CAMBOTA (6 pistas)</p> <p>BMW X3 (F25): sDrive 18 d 10.2012/03.2014 100KW 136CV 1995CC - BMW X3 (F25): sDrive 18 d 10.2012/03.2014 105KW 143CV 1995CC - BMW X3 (F25): sDrive 18 d 04.2014/08.2017 110KW 150CV 1995CC - BMW X3 (F25): xDrive 20 d 09.2010/03.2014 120KW 163CV 1995CC - BMW X3 (F25): xDrive 20 d 09.2010/03.2014 135KW 184CV 1995CC - BMW X3 (F25): xDrive 20 d 04.2014/08.2017 140KW 190CV 1995CC</p> <p>d158mm d59mm</p>
	<p><b>W5208</b> NO. 11237797996 - 11238511321 - 11238518985 - 11238578993 - 11238585220 - 11238586724 - 11238651643</p> <p>POLIE DA CAMBOTA (6 pistas)</p> <p>BMW X3 (F25): xDrive 30 d 04.2011/08.2017 155KW 211CV 2993CC - BMW X3 (F25): xDrive 30 d 04.2011/08.2017 190KW 258CV 2993CC - BMW X3 (F25): xDrive 30 d 04.2011/05.2016 210KW 286CV 2993CC</p> <p>d196mm d40/60mm 4f-d10mm</p>		<p><b>W5210</b> NO. 11237619245 - 11237797996 - 11238518985 - 11238578993 - 11238585220 - 11238586724 - 11238651643</p> <p>POLIE DA CAMBOTA (6 PISTAS)</p> <p>BMW X3 (F25): sDrive 18 d 10.2012/03.2014 100KW 136CV 1995CC - BMW X3 (F25): sDrive 18 d 10.2012/03.2014 105KW 143CV 1995CC - BMW X3 (F25): sDrive 18 d 04.2014/08.2017 110KW 150CV 1995CC - BMW X3 (F25): xDrive 20 d 09.2010/03.2014 120KW 163CV 1995CC - BMW X3 (F25): xDrive 20 d 09.2010/03.2014 135KW 184CV 1995CC - BMW X3 (F25): xDrive 20 d 04.2014/08.2017 140KW 190CV 1995CC</p> <p>d155mm d40/60mm 4f-d10mm</p>
	<p><b>Z55184</b> NO. 07147443710</p> <p>MOLA DO PAINEL DA PORTA MOLDURA</p> <p>BMW X3 (A partir de 2016)</p> <p>F9mm T17mm L11mm H17mm S1-8mm</p>		<p><b>Z55278</b> NO. 51410407983 - 51418224781 - 51430141025</p> <p>MOLA PAINEL RESVESTIMENTO PORTAS</p> <p>BMW X3 (F25) sDrive 18 d (10.2012 - 03.2014) 100kw 136cv 1995cm3 SUV          BMW X3 (F25) sDrive 18 d (10.2012 - 03.2014) 105kw 143cv 1995cm3 SUV          BMW X3 (F25) sDrive 18 d (04.2014 - 08.2017) 110kw 150cv 1995cm3 SUV          BMW X3 (F25) sDrive 20 i (04.2014 - 08.2017) 125kw 170cv 1592cm3 SUV          BMW X3 (F25) sDrive 20 i (04.2014 - 08.2017) 135kw 184cv 1997cm3 SUV          BMW X3 (F25) xDrive 20 d (09.2010 - 08.2017) 120kw 163cv...</p> <p>F-8T-18mm L-14H-21S1-7mm</p>



# BMW X3(F25)

	<b>Z80910</b>	NO. 51777171002		
	MOLA DO PAINEL DA PORTA			
BMW X3 (F25) sDrive 18 d 10.2012/03.2014 100KW 136CV 1995CC N47 D20 C 0005BNW 0005BGV - BMW X3 (F25) sDrive 18 d 10.2012/03.2014 105KW 143CV 1995CC N47 D20 C 0005BNX 0005BGU - BMW X3 (F25) sDrive 18 d 04.2014/08.2017 110KW 150CV 1995CC B47 D20 A 0005BVF - BMW X3 (F25) sDrive 20 i 04.2014/08.2017 125KW 170CV 1592CC N20 B16 A 0005BSQ - BMW X3 (F25) sDrive 20 i 04.2014/08.2017 135KW 184CV 1997CC N20 ...				
F-8 T-18 L-16 H-21 S1-3				

# BMW X4 (F26)

	<b>KUBT3023</b>	NO. 1f-d39mm(x2) 1f-d48mm(x2) 1f-d5mm		<b>W5186</b>	NO. 11238515002
	KIT BORRACHAS TRAVAO PINÇA TRAS BRENBO 40MM			POLIE DA CAMBOTA (6 PISTAS)	
BMW X4 (G02, F98) M desde 03.2019 353KW 480CV 2993CC S58 B30 A 7909ACH - BMW X4 (G02, F98) M Competition desde 03.2019 375KW 510CV 2993CC S58 B30 A 7909ACI - BMW X4 (G02, F98) M40 d xDrive 04.2018/06.2020 240KW 326CV 2993CC B57 D30 B 0005CSP - BMW X4 (G02, F98) M40 i xDrive 04.2018/08.2019 260KW 354CV 2998CC B58 B30 A 0005CSI - BMW X4 (G02, F98) M40 i xDrive desde 04.2018 265KW 360CV 2998CC B58 B3... d59x12mm(x2) d54x3mm(x2) d58x11mm(x2) 1f-d48mm(x2) 1f-d5mm 1p				BMW X4 (F26): xDrive 20 d 04.2014/03.2018 120KW 163CV 1995CC - BMW X4 (F26): xDrive 30 d 04.2014/03.2018 190KW 258CV 2993CC - BMW X4 (F26): xDrive 35 d 04.2014/03.2018 230KW 313CV 2993CC d195/170mm d40mm	
	<b>W5192</b>	NO. 11238602800		<b>W5208</b>	NO. 11237797996 - 11238511321 - 11238518985 - 11238578993 - 11238585220 - 11238586724 - 11238651643
	POLIE DA CAMBOTA (6 PISTAS)			POLIE DA CAMBOTA (6 PISTAS)	
BMW X4 (F26): xDrive 20 d 04.2014/03.2018 140KW 190CV 1995CC d158mm d59mm				BMW X4 (F26): xDrive 30 d 04.2014/03.2018 190KW 258CV 2993CC - BMW X4 (F26): xDrive 30 d 04.2014/03.2018 204KW 277CV 2993CC - BMW X4 (F26): xDrive 30 d 04.2014/03.2018 210KW 286CV 2993CC - BMW X4 (F26): xDrive 35 d 04.2014/03.2018 230KW 313CV 2993CC d196mm d40/60mm 4f-d10mm	
	<b>W5210</b>	NO. 11237619245 - 11237797996 - 11238518985 - 11238578993 - 11238585220 - 11238586724 - 11238651643		<b>Z55278</b>	NO. 51410407983 - 51418224781 - 51430141025
	POLIE DA CAMBOTA (6 PISTAS)			MOLA PAINEL RESVESTIMENTO PORTAS	
BMW X4 (F26) xDrive 20 d 04.2014/03.2018 120KW 163CV 1995CC - BMW X4 (F26): xDrive 20 d 04.2014/03.2018 140KW 190CV 1995CC d155mm d40/60mm 4f-d10mm				BMW X4 (F26) M 40 i (12.2015 - 03.2018) 265kw 360cv 2979cm3 SUV BMW X4 (F26) xDrive 20 d (04.2014 - 03.2018) 120kw 163cv 1995cm3 SUV BMW X4 (F26) xDrive 20 d (04.2014 - 03.2018) 140kw 190cv 1995cm3 SUV BMW X4 (F26) xDrive 20 i (04.2014 - 03.2018) 135kw 184cv 1997cm3 SUV BMW X4 (F26) xDrive 28 i (04.2014 - 03.2018) 180kw 245cv 1997cm3 SUV BMW X4 (F26) xDrive 30 d (04.2015 - 03.2018) 183kw 249cv 299... F-8T-18mm L-14H-21S1-7mm	
	<b>Z80910</b>	NO. 51777171002			
	MOLA DO PAINEL DA PORTA				
BMW X4 (F26) M 40 i 12.2015/03.2018 265KW 360CV 2979CC N55 B30 A 0005CBR - BMW X4 (F26) xDrive 20 i 04.2014/03.2018 135KW 184CV 1997CC N20 B20 A 0005BVI - BMW X4 (F26) xDrive 28 i 04.2014/03.2018 180KW 245CV 1997CC N20 B20 A 0005BVJ					
F-8 T-18 L-16 H-21 S1-3					

# BMW X5(E70)

	<b>A2593</b>	NO. 31336774738 - 31336776391 - 31336788776		<b>KUBT3023</b>	NO. 1f-d39mm(x2) 1f-d48mm(x2) 1f-d5mm
	APOIO SUPORTE AMORTECEDOR FRENTE ( GASTA 2 UNIDADES )			KIT BORRACHAS TRAVAO PINÇA TRAS BRENBO 40MM	
BMW X5 (E70) 3.0 d (De 12.2006 Até 09.2008) 173kW 235cv 2993cm3 SUV - BMW X5 (E70) 3.0 sd (De 10.2007 Até 09.2008) 210kW 286cv 2993cm3 SUV - BMW X5 (E70) 3.0 si (De 10.2006 Até 09.2008) 200kW 272cv 2996cm3 SUV - BMW X5 (E70) 4.8 i xDrive (De 10.2006 Até 09.2008) 261kW 355cv 4799cm3 SUV - BMW X5 (E70) M 50 d (De 08.2011 Até 06.2013) 280kW 381cv 2993cm3 SUV - BMW X5 (E70) xDrive 30 d (De 10.2008 Até... d144x45mm 1f-d12mm 3p-d8x24mm				BMW X5 (G05, F95) M50 i xDrive desde 08.2019 390KW 530CV 4395CC N63 B44 D 0005CZS 0005CXG - BMW X5 (G05, F95) xDrive 25 d desde 08.2019 155KW 211CV 1995CC B47 D20 B 0005CXM - BMW X5 (G05, F95) xDrive 25 d desde 08.2019 170KW 231CV 1995CC B47 D20 B 0005CXI - BMW X5 (G05, F95) xDrive 30 d 08.2018/07.2020 183KW 249CV 2993CC B57 D30 A 0005CTB - BMW X5 (G05, F95) xDrive 30 d 08.2018/07.2020 195KW 265CV... d59x12mm(x2) d54x3mm(x2) d58x11mm(x2) 1f-d48mm(x2) 1f-d5mm 1p d10x17mm.	

	<p><b>S2151</b> NO. 33326770951 - 33326770952</p> <p><b>SILENT-BLOC DO BRAÇO SUSPENSÃO TRÁS INTERIOR</b></p> <p>BMW X5 (E70) 3.0 3.0d 02.2007/09.2008 155kW 211CV 2993CC M57 D30 (306D3) 0005AYB 0005AHH 0005BAW 0005BBF - BMW X5 (E70) 3.0 d 12.2006/09.2008 173kW 235CV 2993CC M57 D30 (306D3) 0005AHG 0005BBJ - BMW X5 (E70) 3.0 sd 10.2007/09.2008 210kW 286CV 2993CC M57 D30 (306D5) 0005AJO - BMW X5 (E70) 3.0 si 10.2006/09.2008 200kW 272CV 2996CC N52 B30 BF N52 B30 AF N52 B30 A 0005AHU - BMW X5 (E70) 4.8 i xDrive 1...</p> <p>d51x65mm c50mm-1f-d16mm</p>		<p><b>UAP81292</b> NO. 13532247156 - 2247156</p> <p><b>ANILHA PROTEÇÃO TÉRMICA INJECTORES</b></p> <p>BMW X5 (F15 - F85) sDrive 25 d (De 07-2015 Até .1-20 -) 170kW 231CV 1995cc Veículo todo-terreno fechado BMW X5 (F15 - F85) xDrive 25 d (De 07-2015 Até .1-20 -) 170kW 231CV 1995cc Veículo todo-terreno fechado</p> <p>d16x1mm 1f-d7mm</p>
	<p><b>UAP81905</b> NO. 13532247156 - 2247156</p> <p><b>ANILHA PROTEÇÃO TÉRMICA INJECTORES</b></p> <p>BMW X5 (E70) xDrive 30 d (De 04-2010 Até 07-2013) 180kW 245CV 2993cc Veículo todo-terreno fechado BMW X5 (E70) M 50 d (De 08-2011 Até 06-2013) 280kW 381CV 2993cc Veículo todo-terreno fechado</p> <p>d14x1mm 1f-d7mm</p>		<p><b>UCRZ1083</b> NO. 31607503538 - 31607505006 - 31607545125 - 31607565314</p> <p><b>CRUZETA VEIO TRANSMISSÃO TRIPODE D43,20MM/26 DENTES</b></p> <p>BMW X5 (E70) 3.0 3.0d (De 02.2007 Até 09.2008) 155kW 211cv 2993cm3 SUV - BMW X5 (E70) 3.0 d (De 12.2006 Até 09.2008) 173kW 235cv 2993cm3 SUV - BMW X5 (E70) 3.0 sd (De 10.2007 Até 09.2008) 210kW 286cv 2993cm3 SUV - BMW X5 (E70) 3.0 si (De 10.2006 Até 09.2008) 200kW 272cv 2996cm3 SUV - BMW X5 (E70) 4.8 i xDrive (De 10.2006 Até 09.2008) 261kW 355cv 4799cm3 SUV - BMW X5 (E70) M (De 07.2009 Até 07.2013)...</p> <p>d43.2mm 26 dentes</p>
	<p><b>UCRZ1097</b> NO. 26207556020 - 26207593164 - 26207597649 - 26207620521 - 26207629988 - 26208605866 - 26208628043</p> <p><b>CRUZETA TRANSMISSÃO VEIO LONGITUDINAL D24X56MM</b></p> <p>BMW X5 (E70) 4.8 i xDrive 10.2006/09.2008 261kW 355CV 4799CC N62 B48 B 0005AMW 0005AHF - BMW X5 (E70) M 07.2009/07.2013 408kW 555CV 4395CC S63 B44 A 7909AAK - BMW X5 (E70) M 50 d 08.2011/06.2013 280kW 381CV 2993CC N57 D30 C 0005BIW - BMW X5 (E70) xDrive 30 d 10.2008/07.2013 155kW 211CV 2993CC M57 D30 (306D3) N57 D30 A 0005AYB 0005AHH 0005BAW 0005BBF - BMW X5 (E70) xDrive 30 d 04.2010/07.2013 180kW...</p> <p>d24mm</p>		<p><b>UTR0848</b> NO. 17117521071</p> <p><b>TAMPÃO RESERVATÓRIO LIQUIDO REFRIGERAÇÃO</b></p> <p>BMW X5 (E70) 3.0 si (02.06 A 09.08) 272cv 2996cc Veículo todo-terreno fechado - BMW X5 (E70) xDrive 30 i (09.08 A 03.10) 272cv 2996cc Veículo todo-terreno fechado - BMW X5 (E70) xDrive 35 i (09.10 A 06.13) 306cv 2979cc Veículo todo-terreno fechado - BMW X5 (E70) xDrive 35 i (02.12 A 06.13) 320cv 2979cc Veículo todo-terreno fechado - BMW X5 (E70) M (09.09 A 06.13) 555cv 4395cc Veículo todo...</p> <p>d88x45mm 1f-d53x25mm</p>
	<p><b>UTR0855</b> NO. 17137516004</p> <p><b>TAMPÃO RESERVATÓRIO LIQUIDO REFRIGERAÇÃO</b></p> <p>BMW X5 (E70) 3.0 si (02.06 A 09.08) 272cv 2996cc Veículo todo-terreno fechado - BMW X5 (E70) xDrive 30 i (09.08 A 03.10) 272cv 2996cc Veículo todo-terreno fechado 2 / 2 - BMW X5 (E70) xDrive 30 i (09.08 A 03.10) 272cv 2996cc Veículo todo-terreno fechado - BMW X5 (E70) xDrive 35 i (09.10 A 06.13) 306cv 2979cc Veículo todo-terreno fechado - BMW X5 (E70) xDrive 35 i (02.12 A 06.13) 320cv 297...</p> <p>d88x45mm 1f-d53x25mm</p>		<p><b>W5099</b> NO. 11232247932 - 11237786611 - 11237788611 - 11237793593 - 11238511371</p> <p><b>POLIE DA CAMBOTA (4+6 PISTAS)</b></p> <p>BMW X5 (E70) 3.0 d 12.2006/09.2008 173kW 235CV 2993CC M57 D30 (306D3) 0005AHG, 0005BBJ - BMW X5 (E70) 3.0 sd 10.2007/09.2008 210kW 286CV 2993CC M57 D30 (306D5) 0005AJO - BMW X5 (E70) xDrive 30 d 10.2008/03.2010 173kW 235CV 2993CC M57 D30 (306D3) N57 D30 A 0005BBJ - BMW X5 (E70) xDrive 35 d 10.2008/07.2013 210kW 286CV 2993CC M57 D30 (306D5) 0005BBK 0005AJO</p> <p>d191mm</p>
	<p><b>W5099-C</b> NO. 11237788611 - 11237793593</p> <p><b>POLIE DA CAMBOTA (4+6 PISTAS)</b></p> <p>BMW X5 (E70) 3.0 d 12.2006/09.2008 173kW 235CV 2993CC M57 D30 (306D3) 0005AHG, 0005BBJ - BMW X5 (E70) 3.0 sd 10.2007/09.2008 210kW 286CV 2993CC M57 D30 (306D5) 0005AJO - BMW X5 (E70) xDrive 30 d 10.2008/03.2010 173kW 235CV 2993CC M57 D30 (306D3) N57 D30 A 0005BBJ - BMW X5 (E70) xDrive 35 d 10.2008/07.2013 210kW 286CV 2993CC M57 D30 (306D5) 0005BBK 0005AJO</p> <p>d191mm</p>		<p><b>Z15529</b> NO. 07147391324</p> <p><b>REBITE PLÁSTICO DA CAVA DA RODA</b></p> <p>BMW X5 (A partir de 2012)</p> <p>F6mm T20mm L21mm H 9mm G S1-2mm S2mm S2-14mm</p>
	<p><b>Z50360</b> NO. 51161881149 - 7703072116 - N10259301</p> <p><b>MOLA REBITE FIXAÇÃO</b></p> <p>BMW X5 (E70) 3.0 d (12.2006 - 09.2008) 173kw 235cv 2993cm3 SUV BMW X5 (E70) 3.0 sd (10.2007 - 09.2008) 210kw 286cv 2993cm3 SUV BMW X5 (E70) 3.0 si (10.2006 - 09.2008) 200kw 272cv 2996cm3 SUV BMW X5 (E70) 4.8 i xDrive (10.2006 - 09.2008) 261kw 355cv 4799cm3 SUV BMW X5 (E70) M (07.2009 - 07.2013) 408kw 555cv 4395cm3 SUV BMW X5 (E70) xDrive 30 d (04.2010 - 07.2013) 180kw 245cv 2993cm3 SUV BMW X5 (E70)...</p> <p>d5.5x 5.5mm f-d11.5mm</p>		<p><b>Z55278</b> NO. 51410407983 - 51418224781 - 51430141025</p> <p><b>MOLA PAINEL RESVESTIMENTO PORTAS</b></p> <p>BMW X5 (E70) 3.0 3.0d (02.2007 - 09.2008) 155kw 211cv 2993cm3 SUV BMW X5 (E70) 3.0 d (12.2006 - 09.2008) 173kw 235cv 2993cm3 SUV BMW X5 (E70) 3.0 sd (10.2007 - 09.2008) 210kw 286cv 2993cm3 SUV BMW X5 (E70) 3.0 si (10.2006 - 09.2008) 200kw 272cv 2996cm3 SUV BMW X5 (E70) 4.8 i xDrive (10.2006 - 09.2008) 261kw 355cv 4799cm3 SUV BMW X5 (E70) M (07.2009 - 07.2013) 408kw 555cv 4395cm3 SUV BMW X5 (E70) M...</p> <p>F-8T-18mm L-14H-21S1-7mm</p>
	<p><b>Z80843</b> NO. 51317064098</p> <p><b>MOLA DE FIXAÇÃO</b></p> <p>BMW X5 (E70)</p> <p>40x12x8.5mm</p>		



	<p><b>E1122</b> NO. 18203404099 - 18207544809 - 18207568777 - 18207791570 - 18207798560</p> <p>ESTICADOR DO ESCAPE PANELA DE TRÁS</p> <p>BMW X5 (F15, F85) xDrive 30 d (De 08.2013 Até 07.2018) 190kW 258cv 2993cm3 SUV - BMW X5 (F15, F85) xDrive 40 d (De 12.2013 Até 07.2018) 230kW 313cv 2993cm3 SUV -</p> <p>82x50x25mm 2f-d10mm</p>		<p><b>S2151</b> NO. 33326770951 - 33326770952</p> <p>SILENT-BLOC DO BRAÇO SUSPENSÃO TRÁS INTERIOR</p> <p>BMW X5 (F15, F85) M 12.2014/07.2018 423KW 575CV 4395CC S63 B44 B 7909ABK - BMW X5 (F15, F85) M 50 d 12.2013/07.2018 280KW 381CV 2993CC N57 D30 C 0005BTK - BMW X5 (F15, F85) xDrive 25 d 12.2013/07.2015 160KW 218CV 1995CC N47 D20 D 0005BRU - BMW X5 (F15, F85) xDrive 25 d 04.2014/07.2018 160KW 218CV 2993CC N57 D30 A - BMW X5 (F15, F85) xDrive 25 d 08.2015/07.2018 170KW 231CV 1995CC B47 D20 B 0005CCP ...</p> <p>d51x65mm c50mm-1f-d16mm</p>
	<p><b>S2153</b> NO. 33326770951 - 33326770952 - 33326773632 - 6770951 - 6770952 - 6773632</p> <p>SILENT-BLOC DO BRAÇO SUSPENSÃO TRÁS INTERIOR À FRENTE</p> <p>BMW X5 (F15, F85) M 12.2014/07.2018 423KW 575CV 4395CC S63 B44 B 7909ABK - BMW X5 (F15, F85) M 50 d 12.2013/07.2018 280KW 381CV 2993CC N57 D30 C 0005BTK - BMW X5 (F15, F85) sDrive 25 d 12.2013/07.2015 160KW 218CV 1995CC N47 D20 D 0005BRS - BMW X5 (F15, F85) sDrive 25 d 08.2015/07.2018 170KW 231CV 1995CC B47 D20 B 0005CCO - BMW X5 (F15, F85) xDrive 25 d 12.2013/07.2015 160KW 218CV 1995CC N47 D20 D ...</p> <p>d51x70mm c50mm-1f-d12mm</p>		<p><b>UCRZ1083</b> NO. 31607503538 - 31607505006 - 31607545125 - 31607565314</p> <p>CRUZETA VEIO TRANSMISSÃO TRIPODE D43,20MM/26 DENTES</p> <p>BMW X5 (F15, F85) M (De 12.2014 Até 07.2018) 423kW 575cv 4395cm3 SUV - BMW X5 (F15, F85) xDrive 50 i (De 08.2013 Até 07.2018) 330kW 449cv 4395cm3 SUV -</p> <p>d43.2mm 26 dentes</p>
	<p><b>UCRZ1097</b> NO. 26207556020 - 26207593164 - 26207597649 - 26207620521 - 26207629988 - 26208605866 - 26208628043</p> <p>CRUZETA TRANSMISSÃO VEIO LONGITUDINAL D24X56MM</p> <p>BMW X5 (F15, F85) M 12.2014/07.2018 423KW 575CV 4395CC S63 B44 B 7909ABK - BMW X5 (F15, F85) M 50 d 12.2013/07.2018 280KW 381CV 2993CC N57 D30 C 0005BTK - BMW X5 (F15, F85) xDrive 25 d 12.2013/07.2015 160KW 218CV 1995CC N47 D20 D 0005BRU - BMW X5 (F15, F85) xDrive 25 d 04.2014/07.2018 160KW 218CV 2993CC N57 D30 A - BMW X5 (F15, F85) xDrive 25 d 08.2015/07.2018 170KW 231CV 1995CC B47 D20 B 0005CCP ...</p> <p>d24mm</p>		<p><b>W5186</b> NO. 11238515002</p> <p>POLIE DA CAMBOTA (6 PISTAS)</p> <p>BMW X5 (F15, F85): xDrive 40 d 12.2013/07.2018 230KW 313CV 2993CC</p> <p>d195/170mm d40mm</p>
	<p><b>W5186</b> NO. 11238515002</p> <p>POLIE DA CAMBOTA (6 PISTAS)</p> <p>BMW X5 (F15, F85): xDrive 40 d 12.2013/07.2018 230KW 313CV 2993CC</p> <p>d195/170mm d40mm</p>		<p><b>W5208</b> NO. 11237797996 - 11238511321 - 11238518985 - 11238578993 - 11238585220 - 11238586724 - 11238651643</p> <p>POLIE DA CAMBOTA (6 pistas)</p> <p>BMW X5 (F15, F85): xDrive 30 d 08.2013/07.2018 190KW 258CV 2993CC - BMW X5 (F15, F85): xDrive 30 d 08.2013/07.2018 204KW 277CV 2993CC - BMW X5 (F15, F85): xDrive 40 d 12.2013/07.2018 230KW 313CV 2993CC - BMW X5 (F15, F85): M 50 d 12.2013/07.2018 280KW 381CV 2993CC</p> <p>d196mm d40/60mm 4f-d10mm</p>
	<p><b>Z55266</b> NO. 07149136882</p> <p>MOLA DO PAINEL DAS PORTAS</p> <p>BMW X5 (A partir de 2006)</p> <p>F9mm T18mm L14mm H21mm S1-7mm</p>		<p><b>Z55278</b> NO. 51410407983 - 51418224781 - 51430141025</p> <p>MOLA PAINEL RESVESTIMENTO PORTAS</p> <p>BMW X5 (F15, F85) M 50 d (12.2013 - 07.2018) 280kw 381cv 2993cm3 SUV BMW X5 (F15, F85) sDrive 25 d (12.2013 - 07.2015) 160kw 218cv 1995cm3 SUV BMW X5 (F15, F85) sDrive 25 d (08.2015 - 07.2018) 170kw 231cv 1995cm3 SUV BMW X5 (F15, F85) xDrive 25 d (12.2013 - 07.2015) 160kw 218cv 1995cm3 SUV BMW X5 (F15, F85) xDrive 25 d (08.2015 - 07.2018) 170kw 231cv 1995cm3 SUV BMW X5 (F15, F85) xDrive 25 d (04.2...)</p> <p>F-8T-18mm L-14H-21S1-7mm</p>

## BMW X5-(E53)

	<p><b>A1880</b> NO. 26121229726 - 26127507740</p> <p>APOIO DA TRANSMISSÃO</p> <p>BMW X5 (E53) 3.0i (05-2000 A 12-2006) 222CV 2979CC - BMW X5 (E53) 3.0i (05-2000 A 12-2006) 231CV 2979CC - BMW X5 (E53) 4.4i (05-2000 A 12-2003) 286CV 4398CC - BMW X5 (E53) 4.4i (12-2003 A 09-2006) 320CV 4398CC - BMW X5 (E53) 4.6is (02-2002 A 12-2003) 347C</p> <p>190x105x34mm 1f-d30mm</p>		<p><b>A2586</b> NO. 33521097272 - 33526773669</p> <p>APOIO SUPORTE AMORTECEDOR TRÁS ( GASTA 2 UNIDADES )</p> <p>BMW X5 (E53) 3.0 d (De 04.2001 Até 09.2003) 135kW 184cv 2925cm3 SUV - BMW X5 (E53) 3.0 d (De 10.2003 Até 09.2006) 160kW 218cv 2993cm3 SUV - BMW X5 (E53) 3.0 i (De 04.2000 Até 10.2006) 170kW 231cv 2979cm3 SUV - BMW X5 (E53) 4.4 i (De 01.2000 Até 09.2003) 210kW 286cv 4398cm3 SUV - BMW X5 (E53) 4.4 i (De 10.2003 Até 10.2006) 235kW 320cv 4398cm3 SUV - BMW X5 (E53) 4.6 is (De 10.2001 Até 09.2003) 255kW...</p> <p>126x134x48mm 1f-d12mm 3p-d10x22mm</p>
	<p><b>D0022</b> NO. 26111209168 - 26111227420 - 26111227717 - 26111229080 - 26111229360 - 26117511454</p> <p>CARDAN TRANSMISSÃO D135X30MM 6 FUROS 12MM ENTRE FUROS 96MM</p> <p>BMW X5 (E53) 3.0 d 04.2001/09.2003 135KW 184CV 2925CC M57 D30 (306D1) 0005679 - BMW X5 (E53) 3.0 i 04.2000/10.2006 170KW 231CV 2979CC M54 B30 (306S3) 0005678 - BMW X5 (E53) 4.4 i 01.2000/09.2003 210KW 286CV 4398CC M62 B44 (448S2) 0005667 - BMW X5 (E53) 4.6 is 10.2001/09.2003 255KW 347CV 4619CC M62 B46 (468S1) 0005756</p> <p>d132x123x30mm 6f-d12mm</p>		<p><b>F1641A-I</b> NO. 33211229209 - 33211229378 - 33217504705 - 33219067805</p> <p>FOLE DA TRANSMISSÃO JUNTO À CAIXA</p> <p>BMW X5 (E53) 3.0 d 04.2001/09.2003 135KW 184CV 2925CC M57 D30 (306D1) 0005679 - BMW X5 (E53) 3.0 d 10.2003/09.2006 160KW 218CV 2993CC M57 D30 (306D2) 0005ACO, 0005786 - BMW X5 (E53) 3.0 i 04.2000/10.2006 170KW 231CV 2979CC M54 B30 (306S3) 0005678 - BMW X5 (E53) 4.4 i 10.2003/10.2006 235KW 320CV 4398CC N62 B44 A 0005AMX, 0005785 - BMW X5 (E53) 4.6 is 10.2001/09.2003 255KW 347CV 4619CC M62 B46 (468S)...</p> <p>d110x92mm 1f-d106mm 1f-d25mm</p>

	<p><b>F1800-I</b> NO. 33211226033 - 33211226719 - 33211229205 - 33217504703 - 33219067809 - 33219067814 - 33219067895 -</p> <p>FOLE TRANSMISSÃO JUNTO A CAIXA FALANGE D105MM</p> <p>BMW X5 (E53) 3.0i 4X4 - 3.0 TDCR 4X4 - 4.4i V8 4X4 (APOS 2000)</p> <p>d102x94mm 1f-d100mm 1f-d22mm</p>		<p><b>F1834-T</b> NO. 31607507403</p> <p>FOLE DA TRANSMISSÃO JUNTO Á CAIXA</p> <p>BMW X5 (E53) 3.0i 4X4 - 3.0 TDCR 4X4 - 4.4i V8 4X4 (APOS 2000)</p> <p>d100x128mm 1f-d96mm 1f-d27mm</p>
	<p><b>F4345</b> NO. 33211226033 - 33211226264 - 33211229221 - 3321129376 - 33217504704 - 33219067813 - 33219067815</p> <p>FOLE TRANSMISSÃO JUNTO A RODA ( GASTA 2 UNIDADES )</p> <p>BMW X5 (E53) 3.0 d 04.2001/09.2003 135KW 184CV 2925CC M57 D30 (306D1) 0005679 - BMW X5 (E53) 3.0 i 04.2000/10.2006 170KW 231CV 2979CC M54 B30 (306S3) 0005678 - BMW X5 (E53) 4.4 i 01.2000/09.2003 210KW 286CV 4398CC M62 B44 (448S2) 0005667</p> <p>d81x79mm 1f-d22mm-1f-d52mm</p>		<p><b>KU80187</b> NO. 51217035421 - 7035421 - 51217035421</p> <p>KIT COMANDO PUXADORES PORTAS (40,20MM )</p> <p>BMW X5 (E53): 3.0 i 04.2000/10.2006 170KW 231CV 2979CC - BMW X5 (E53): 4.4 i 01.2000/09.2003 210KW 286CV 4398CC - BMW X5 (E53): 4.4 i 10.2003/10.2006 235KW 320CV 4398CC - BMW X5 (E53): 4.6 is 10.2001/09.2003 255KW 347CV 4619CC - BMW X5 (E53): 4.8 is 04.2004/09.2006 265KW 360CV 4799CC - BMW X5 (E53): 3.0 d 04.2001/09.2003 135KW 184CV 2925CC - BMW X5 (E53): 3.0 d 10.2003/09.2006 160KW 218CV 2993CC</p> <p>d13x40mm</p>
	<p><b>KU80190</b> NO. 51217035422 - 7035422</p> <p>KIT COMANDO PUXADORES PORTA DIREITA ( 45,77MM )</p> <p>BMW X5 (E53): 3.0 i 04.2000/10.2006 170KW 231CV 2979CC - BMW X5 (E53): 4.4 i 01.2000/09.2003 210KW 286CV 4398CC - BMW X5 (E53): 4.4 i 10.2003/10.2006 235KW 320CV 4398CC - BMW X5 (E53): 4.6 is 10.2001/09.2003 255KW 347CV 4619CC - BMW X5 (E53): 4.8 is 04.2004/09.2006 265KW 360CV 4799CC - BMW X5 (E53): 3.0 d 04.2001/09.2003 135KW 184CV 2925CC - BMW X5 (E53): 3.0 d 10.2003/09.2006 160KW 218CV 2993CC...</p> <p>d12x46mm</p>		<p><b>KU80194</b> NO. 51217035421 - 7035421</p> <p>KIT COMANDO PUXADORES PORTA ESQUERDA ( 45,77MM )</p> <p>BMW X5 (E53): 3.0 i 04.2000/10.2006 170KW 231CV 2979CC - BMW X5 (E53): 4.4 i 01.2000/09.2003 210KW 286CV 4398CC - BMW X5 (E53): 4.4 i 10.2003/10.2006 235KW 320CV 4398CC - BMW X5 (E53): 4.6 is 10.2001/09.2003 255KW 347CV 4619CC - BMW X5 (E53): 4.8 is 04.2004/09.2006 265KW 360CV 4799CC - BMW X5 (E53): 3.0 d 04.2001/09.2003 135KW 184CV 2925CC - BMW X5 (E53): 3.0 d 10.2003/09.2006 160KW 218CV 2993CC</p> <p>d12x46mm</p>
	<p><b>KUR21999</b> NO. 1f-d24mm 1f-d10mm 1f-d10mm 1f-d19mm</p> <p>KIT DE REPARAÇÃO ALAVANCA DE VELOCIDADES</p> <p>BMW X5 (E53) 3.0 d (De 04.2001 Até 09.2003) 135kW 184cv 2925cm3 SUV - BMW X5 (E53) 3.0 d (De 10.2003 Até 09.2006) 160kW 218cv 2993cm3 SUV - BMW X5 (E53) 3.0 i (De 04.2000 Até 10.2006) 170kW 231cv 2979cm3 SUV -</p> <p>d37x18mm d19x25mm d17x22mm d31x21mm d31x21mm d12x19mm</p>		<p><b>P1042</b> NO. 35211160422</p> <p>CAPA DE PEDAL</p> <p>BMW X5 (E53) 3.0 d 04.2001/09.2003 135KW 184CV 2925CC M57 D30 (306D1) 0005679 - BMW X5 (E53) 3.0 i 04.2000/10.2006 170KW 231CV 2979CC M54 B30 (306S3) 0005678</p> <p>.75x65x40mm</p>
	<p><b>P1055</b> NO. 35211160421</p> <p>CAPA DE PEDAL DO TRAVÃO(VEÍCULOS COM CAIXA AUTOMÁTICA)</p> <p>BMW X5 (E53) 3.0 d 04.2001/09.2003 135KW 184CV 2925CC M57 D30 (306D1) 0005679 - BMW X5 (E53) 3.0 i 04.2000/10.2006 170KW 231CV 2979CC M54 B30 (306S3) 0005678 - BMW X5 (E53) 4.4 i 01.2000/09.2003 210KW 286CV 4398CC M62 B44 (448S2) 0005667 - BMW X5 (E53) 4.4 i 10.2003/10.2006 235KW 320CV 4398CC N62 B44 A 0005AMX 0005785 - BMW X5 (E53) 4.6 is 10.2001Z/09.2003 255KW 347CV 4619CC M62 B46 (468S1) 0005...</p> <p>74x107x42mm</p>		<p><b>R080024</b> NO. 48-56-36-225-27-41-19mm 1f-d6mm 1f</p> <p>TUBO RIGIDO DE REFRIGERAÇÃO</p> <p>BMW X5 (E53) 3.0 i 04.2000/10.2006 170KW 231CV 2979CC M54 B30 (306S3) 0005678</p> <p>B475-14/17mm 48-56-36-225-27-41-19mm 1f-d6mm 1f-d9mm...</p>
	<p><b>R222244</b> NO. 11532248057 - 2248057</p> <p>TUBO SUPERIOR DO RADIADOR COM BOCAL</p> <p>BMW X5 (E53) 3.0 d 04.2001/09.2003 135KW 184CV 2925CC M57 D30 (306D1) 0005679</p> <p>B605-38/38mm 128-96-74-78-151-110mm</p>		<p><b>R8184</b> NO. 32411093130 - 32411095526</p> <p>TUBO DE LIGAÇÃO DA BOMBA HIDRÁULICA DIREÇÃO</p> <p>BMW X5 (E53) 3.0 i 04.2000/10.2006 170KW 231CV 2979CC M54 B30 (306S3) 0005678</p> <p>B360-d16/d16mm</p>
	<p><b>S1271</b> NO. 31106770689 - 31106770690 - 31121092019 - 31121094235 - 31121122462 - 31121124622 - 31121133236 - 31121133237</p> <p>SILENT-BLOC DO BRAÇO DA SUSPENSÃO (FRENTE CENTRO)</p> <p>BMW X5 (E53) 3.0 d 04.2001/09.2003 135KW 184CV 2925CC M57 D30 (306D1) 0005679 - BMW X5 (E53) 3.0 i 04.2000/10.2006 170KW 231CV 2979CC M54 B30 (306S3) 0005678 - BMW X5 (E53) 4.4 i 01.2000/09.2003 210KW 286CV 4398CC M62 B44 (448S2) 0005667 - BMW X5 (E53) 4.4 i 10.2003/10.2006 235KW 320CV 4398CC N62 B44 A 0005AMX ...</p> <p>d46x52mm c40mm 1f-d12mm</p>		<p><b>S1669</b> NO. 33316770454 - 33311093662 - 1093662 - 6770454 - 6Q0423810B - 6Q0423810E - 6Q0423821B - 6X0422810 - 6...</p> <p>SILENT-BLOC DO EIXO SUSPENSÃO DE TRÁS</p> <p>BMW X5 (E53) 3.0 d 04.2001/09.2003 135KW 184CV 2925CC M57 D30 (306D1) 0005679 - BMW X5 (E53) 3.0 i 04.2000/10.2006 170KW 231CV 2979CC M54 B30 (306S3) 0005678 - BMW X5 (E53) 4.4 i 01.2000/09.2003 210KW 286CV 4398CC M62 B44 (448S2) 0005667 - BMW X5 (E53) 4.4 i 10.2003/10.2006 235KW 320CV 4398CC N62 B44 A 0005AMX ...</p> <p>d106x92mm c78mm d95mm 1f-d19mm</p>
	<p><b>U7033K</b> NO. 61671378609 - 64500149356 - 64500301636 - 64501363572 - 64501466019 - 64501468463 - 64508390601</p> <p>ORINGS BOMBA DIREÇÃO ASSITIDA</p> <p>BMW X5 (E53) 3.0 d (04.2001 - 09.2003) 135kw 184cv 2925cm3 SUV          BMW X5 (E53) 3.0 d (10.2003 - 09.2006) 160kw 218cv 2993cm3 SUV          BMW X5 (E53) 3.0 i (04.2000 - 10.2006) 170kw 231cv 2979cm3 SUV          BMW X5 (E53) 4.4 i (01.2000 - 09.2003) 210kw 286cv 4398cm3 SUV          BMW X5 (E53) 4.4 i (10.2003 - 10.2006) 235kw 320cv 4398cm3 SUV          BMW X5 (E53) 4.6 is (10.2001 - 09.2003) 255kw 347cv 4619cm3 SUV          BMW X5 (E53) 4.8 is ...</p> <p>d11x2mm d10x2mm 1f-d7mm 1f-d6mm</p>		<p><b>UAP83244</b> NO. 13537785722</p> <p>ANILHA PROTEÇÃO TÉRMICA INJECTORES</p> <p>BMW X5 (E53) 3.0 d (De 05-2001 Até 12-2003) 135KW 184CV 2925cc Veículo todo-terreno fechado</p> <p>d15x2mm 1f-d7mm</p>



	<p><b>UCRZ1083</b> NO. 31607503538 - 31607505006 - 31607545125 - 31607565314</p> <p>CRUZETA VEIO TRANSMISSÃO TRIPODE D43,20MM/26 DENTES</p> <p>BMW X5 (E53) 3.0 d (De 04.2001 Até 09.2003) 135kW 184cv 2925cm3 SUV - BMW X5 (E53) 3.0 d (De 10.2003 Até 09.2006) 160kW 218cv 2993cm3 SUV - BMW X5 (E53) 3.0 i (De 04.2000 Até 10.2006) 170kW 231cv 2979cm3 SUV - BMW X5 (E53) 4.4 i (De 01.2000 Até 09.2003) 210kW 286cv 4398cm3 SUV - BMW X5 (E53) 4.4 i (De 10.2003 Até 10.2006) 235kW 320cv 4398cm3 SUV - BMW X5 (E53) 4.6 is (De 10.2001 Até 09.2003) 255kW...</p> <p>d43.2mm 26 dentes</p>		<p><b>UFQ23302</b> NO. 21511223302</p> <p>FORQUILHA DA EMBRAIAGEM</p> <p>BMW X5 (E53) 3.0 d 04.2001/09.2003 135KW 184CV 2925CC M57 D30 (306D1) 0005679 - BMW X5 (E53) 3.0 d 10.2003/09.2006 160KW 218CV 2993CC M57 D30 (306D2) 0005ACO 0005786 - BMW X5 (E53) 3.0 i 04.2000/10.2006 170KW 231CV 2979CC M54 B30 (306S3) 0005678</p> <p>252x83x28mm 1f-47x75mm</p>
	<p><b>UMV25110</b> NO. 25111434495 - 25117500299 - 25117503231 - 25117523817 - 25117544524</p> <p>MANETE PUNHO TOPO ALAVANCA MUDANÇAS 5 VELOCIDADES NAPEL F14MM</p> <p>BMW X5 (E53): 3.0 i 04.2000/10.2006 170KW 231CV 2979CC - BMW X5 (E53): 3.0 d 04.2001/09.2003 135KW 184CV 2925CC - BMW X5 (E53): 3.0 d 10.2003/09.2006 160KW 218CV 2993CC</p> <p>d51x91mm 1f-d14mm</p>		<p><b>UMV25111</b> NO. 25111434495 - 25117500299 - 25117503231 - 25117523817 - 25117544524</p> <p>MANETE PUNHO TOPO ALAVANCA MUDANÇAS 6 VELOCIDADES F14MM</p> <p>BMW X5 (E53): 3.0 i 04.2000/10.2006 170KW 231CV 2979CC - BMW X5 (E53): 3.0 d 04.2001/09.2003 135KW 184CV 2925CC - BMW X5 (E53): 3.0 d 10.2003/09.2006 160KW 218CV 2993CC</p> <p>d46x91mm 1f-d14mm</p>
	<p><b>UMV25114</b> NO. 25111434495 - 25117500299 - 25117503231 - 25117523817 - 25117544524</p> <p>MANETE PUNHO TOPO ALAVANCA MUDANÇAS 5 VELOCIDADES F14MM</p> <p>BMW X5 (E53): 3.0 i 04.2000/10.2006 170KW 231CV 2979CC - BMW X5 (E53): 3.0 d 04.2001/09.2003 135KW 184CV 2925CC - BMW X5 (E53): 3.0 d 10.2003/09.2006 160KW 218CV 2993CC</p> <p>d56x94mm 1f-d14mm</p>		<p><b>UTR0812</b> NO. 17110152374 - 17111468076 - 17111712492 - 17111712669 - 17111742231 - 17117639022 - 17119071581</p> <p>TAMPÃO RESERVATÓRIO LIQUIDO REFRIGERAÇÃO</p> <p>BMW X5 (E53) 3.0 i (05.00 A 12.06) 222cv 2979cc Veículo todo-terreno fechado - BMW X5 (E53) 3.0 i (05.00 A 12.06) 231cv 2979cc Veículo todo-terreno fechado - BMW X5 (E53) 4.4 i (05.00 A 12.03) 286cv 4398cc Veículo todo-terreno fechado - BMW X5 (E53) 4.4 i (12.03 A 09.06) 320cv 4398cc Veículo todo-terreno fechado - BMW X5 (E53) 4.6 is (02.02 A 12.03) 347cv 4619cc Veículo todo-terreno fecha...</p> <p>d65x45mm 1f-d52x20mm</p>
	<p><b>UTR0813</b> NO. 17111468077 - 17111712188 - 17111712232 - 17111719167 - 17111742232 - 17112242256 - 17114379048 - 17117639022</p> <p>TAMPÃO RESERVATÓRIO LIQUIDO REFRIGERAÇÃO</p> <p>BMW X5 (E53) 3.0 d (05.01 A 12.03) 184cv 2925cc Veículo todo-terreno fechado - BMW X5 (E53) 3.0 d (12.03 A 12.06) 218cv 2993cc Veículo todo-terreno fechado</p> <p>d66x45mm 1f-d52x20mm</p>		<p><b>W5099</b> NO. 11232247932 - 11237786611 - 11237786611 - 11237793593 - 11238511371</p> <p>POLIE DA CAMBOTA (4+6 PISTAS)</p> <p>BMW X5 (E53) 3.0 d 10.2003/09.2006 160KW 218CV 2993CC M57 D30 (306D2) 0005ACO, 0005786</p> <p>d191mm</p>
	<p><b>W5099-C</b> NO. 11237788611 - 11237793593</p> <p>POLIE DA CAMBOTA (4+6 PISTAS)</p> <p>BMW X5 (E53) 3.0 d 10.2003/09.2006 160KW 218CV 2993CC M57 D30 (306D2) 0005ACO, 0005786</p> <p>d191mm</p>		<p><b>W5169</b> NO. 11231439683 - 11237568345</p> <p>POLIE DA CAMBOTA (4 + 6 PISTAS)</p> <p>BMW X5 (E53) 4.4 i (De 12-2003 Até 09-2006) 235kW 320CV 4398cc Veículo todo-terreno fechado BMW X5 (E53) 4.4 i (De 12-2003 Até 09-2006) 235kW 320CV 4398cc Veículo todo-terreno fechado BMW X5 (E53) 4.8 is (De 04-2004 Até 09-2006) 265kW 360CV 4799cc Veículo todo-terreno fechado BMW X5 (E53) 4.8 is (De 04-2004 Até 09-2006) 265kW 360CV 4799cc Veículo todo-terreno fechado</p> <p>d174/152mm d37mm</p>
	<p><b>W5225</b> NO. 32417787106</p> <p>POLIE DA BOMBA HIDRÁULICA</p> <p>BMW X5 (E53) 3.0 d 10.2003/09.2006 160KW 218CV 2993CC M57 D30 (306D2) 0005ACO 0005786</p> <p>d143x28mm 1f-d30mm 3f-d8mm</p>		<p><b>Z55278</b> NO. 51410407983 - 51418224781 - 51430141025</p> <p>MOLA PAINEL RESVESTIMENTO PORTAS</p> <p>BMW X5 (E53) 3.0 d (04.2001 - 09.2003) 135kw 184cv 2925cm3 SUV BMW X5 (E53) 3.0 d (10.2003 - 09.2006) 160kw 218cv 2993cm3 SUV BMW X5 (E53) 3.0 i (04.2000 - 10.2006) 170kw 231cv 2979cm3 SUV BMW X5 (E53) 4.4 i (01.2000 - 09.2003) 210kw 286cv 4398cm3 SUV BMW X5 (E53) 4.4 i (10.2003 - 10.2006) 235kw 320cv 4398cm3 SUV BMW X5 (E53) 4.6 is (10.2001 - 09.2003) 255kw 347cv 4619cm3 SUV BMW X5 (E53) 4.8 is (...)</p> <p>F-8T-18mm L-14H-21S1-7mm</p>
	<p><b>Z80843</b> NO. 51317064098</p> <p>MOLA DE FIXAÇÃO</p> <p>BMW X5 (Após 2007)</p> <p>40x12x8.5mm</p>		<p><b>Z80849</b> NO. 51411973500 - 99950758240</p> <p>Mola de painel</p> <p>BMW X5 (E53)</p> <p>d18x21mm 1p-d9-13mm</p>



	<p><b>R222250</b> NO. 17127794153 - 7794153</p> <p>TUBO RADIADOR SUPERIOR DIAMETRO 38MM</p> <p>BMW X5 (E70) 3.0 3.0d 02.2007/09.2008 155KW 211CV 2993CC M57 D30 (306D3) 0005AYB 0005AHH 0005BAW 0005BBF - BMW X5 (E70) 3.0 d 12.2006/09.2008 173KW 235CV 2993CC M57 D30 (306D3) 0005AHG 0005BBJ - BMW X5 (E70) 3.0 sd 10.2007/09.2008 210KW 286CV 2993CC M57 D30 (306D5) 0005AJO - BMW X5 (E70) xDrive 30 d 10.2008/03.2010 173KW 235CV 2993CC M57 D30 (306D3) 0005BBJ - BMW X5 (E70) xDrive 35 d 10.2008/07.20...</p> <p>B550-37/37mm 104-66-265-123-142mm</p>		<p><b>S2153</b> NO. 33326770951 - 33326770952 - 33326773632 - 6770951 - 6770952 - 6773632</p> <p>SILENT-BLOC DO BRAÇO SUSPENSÃO TRÁS INTERIOR Á FRENTE</p> <p>BMW X5 (E70) 3.0 sd 10.2007/09.2008 210KW 286CV 2993CC M57 D30 (306D5) 0005AJO - BMW X5 (E70) 3.0 si 10.2006/09.2008 200KW 272CV 2996CC N52 B30 BF N52 B30 AF N52 B30 A 0005AHU - BMW X5 (E70) 4.8 i xDrive 10.2006/09.2008 261KW 355CV 4799CC N62 B48 B 0005AMW 0005AHF - BMW X5 (E70) M 07.2009/07.2013 408KW 555CV 4395CC S63 B44 A 7909AAK - BMW X5 (E70) M 50 d 08.2011/06.2013 280KW 381CV 2993CC N57 D30 ...</p> <p>d51x70mm c50mm-1f-d12mm</p>
	<p><b>UAP81292</b> NO. 13532247156 - 2247156</p> <p>ANILHA PROTEÇÃO TÉRMICA INJECTORES</p> <p>BMW X5 (E70) xDrive 30 d (De 04-2010 Até 07-2013) 180kW 245CV 2993cc Veículo todo-terreno fechado BMW X5 (E70) M 50 d (De 08-2011 Até 06-2013) 280kW 381CV 2993cc Veículo todo-terreno fechado</p> <p>d16x1mm 1f-d7mm</p>		<p><b>UAP81905</b> NO. 13532247156 - 2247156</p> <p>ANILHA PROTEÇÃO TÉRMICA INJECTORES</p> <p>BMW X5 (F15 - F85) sDrive 25 d (De 07-2015 Até .1-20 -) 170kW 231CV 1995cc Veículo todo-terreno fechado BMW X5 (F15 - F85) xDrive 25 d (De 07-2015 Até .1-20 -) 170kW 231CV 1995cc Veículo todo-terreno fechado</p> <p>d14x1mm 1f-d7mm</p>
	<p><b>W5140</b> NO. 11237797996 - 11237800026 - 11238578993 - 11238585220 - 11238651643</p> <p>POLIE DA CAMBOTA 7 PISTAS</p> <p>BMW X5 (E70) xDrive 30 d (09.10 A 06.13) 245cv 2993cc Veículo todo-terreno fechado - BMW X5 (E70) xDrive 40 d (09.10 A 06.13) 306cv 2993cc Veículo todo-terreno fechado</p> <p>d190mm d10mm</p>		<p><b>W5209</b> NO. 11237797996 - 11237800385 - 11238578993 - 11238585220 - 11238586724 - 11238651643</p> <p>POLIE DA CAMBOTA (6 PISTAS)</p> <p>BMW X5 (E70): xDrive 30 d 10.2008/03.2010 173KW 235CV 2993CC - BMW X5 (E70): xDrive 30 d 04.2010/07.2013 180KW 245CV 2993CC</p> <p>d196mm d40/60mm 4f-d10mm</p>
	<p><b>Z55186</b> NO. 07147145753</p> <p>MOLA DE PAINEL</p> <p>BMW X5 (E70) 3.0 3.0d (02.2007 - 09.2008) 155kw 211cv 2993cm3 SUV          BMW X5 (E70) 3.0 d (12.2006 - 09.2008) 173kw 235cv 2993cm3 SUV          BMW X5 (E70) 3.0 sd (10.2007 - 09.2008) 210kw 286cv 2993cm3 SUV          BMW X5 (E70) 3.0 si (10.2006 - 09.2008) 200kw 272cv 2996cm3 SUV          BMW X5 (E70) 4.8 i xDrive (10.2006 - 09.2008) 261kw 355cv 4799cm3 SUV          BMW X5 (E70) M (07.2009 - 07.2013) 408kw 555cv 4395cm3 SUV          BMW X5 (E70) M...</p> <p>d8x 18mm f-d18mm</p>		





BMW X6(E71)

	<p><b>A2593</b> NO. 31336774738 - 31336776391 - 31336788776</p> <p>APOIO SUPORTE AMORTECEDOR FRENTE ( GASTA 2 UNIDADES )</p> <p>BMW X6 (E71, E72) xDrive 30 d (De 04.2008 Até 03.2010) 173kW 235cv 2993cm3 SUV - BMW X6 (E71, E72) xDrive 30 d (De 04.2010 Até 07.2014) 180kW 245cv 2993cm3 SUV - BMW X6 (E71, E72) xDrive 35 d (De 01.2008 Até 03.2010) 210kW 286cv 2993cm3 SUV - BMW X6 (E71, E72) xDrive 35 i (De 01.2008 Até 07.2014) 225kW 306cv 2979cm3 SUV - BMW X6 (E71, E72) xDrive 40 d (De 07.2009 Até 06.2014) 225kW 306cv 2993cm3 S...</p> <p>d144x45mm 1f-d12mm 3p-d8x24mm</p>		<p><b>R222250</b> NO. 17127794153 - 7794153</p> <p>TUBO RADIADOR SUPERIOR DIAMETRO 38MM</p> <p>BMW X6 (E71, E72) xDrive 30 d 04.2008/03.2010 173KW 235CV 2993CC M57 D30 (306D3) 0005BBJ - BMW X6 (E71, E72) xDrive 35 d 01.2008/03.2010 210KW 286CV 2993CC M57 D30 (306D5) 0005AJO</p> <p>B550-37/37mm 104-66-265-123-142mm</p>
	<p><b>S2151</b> NO. 33326770951 - 33326770952</p> <p>SILENT-BLOC DO BRAÇO SUSPENSÃO TRÁS INTERIOR</p> <p>BMW X6 (E71, E72) ActiveHybrid 01.2009/10.2011 357KW 485CV 4395CC N63 B44 A 0005AQC - BMW X6 (E71, E72) M 07.2009/07.2014 408KW 555CV 4395CC S63 B44 A 7909AAK - BMW X6 (E71, E72) M 50 d 08.2011/06.2014 280KW 381CV 2993CC N57 D30 C 0005BIX - BMW X6 (E71, E72) xDrive 30 d 04.2008/03.2010 173KW 235CV 2993CC M57 D30 (306D3) 0005BBJ - BMW X6 (E71, E72) xDrive 30 d 04.2010/07.2014 155KW 211CV 2993CC N57...</p> <p>d51x65mm c50mm-1f-d16mm</p>		<p><b>S2153</b> NO. 33326770951 - 33326770952 - 33326773632 - 6770951 - 6770952 - 6773632</p> <p>SILENT-BLOC DO BRAÇO SUSPENSÃO TRÁS INTERIOR Á FRENTE</p> <p>BMW X6 (E71, E72) ActiveHybrid 01.2009/10.2011 357KW 485CV 4395CC N63 B44 A 0005AQC - BMW X6 (E71, E72) M 07.2009/07.2014 408KW 555CV 4395CC S63 B44 A 7909AAK - BMW X6 (E71, E72) M 50 d 08.2011/06.2014 280KW 381CV 2993CC N57 D30 C 0005BIX - BMW X6 (E71, E72) xDrive 30 d 04.2008/03.2010 173KW 235CV 2993CC M57 D30 (306D3) 0005BBJ - BMW X6 (E71, E72) xDrive 30 d 04.2010/07.2014 155KW 211CV 2993CC N57...</p> <p>d51x70mm c50mm-1f-d12mm</p>
	<p><b>UAP81292</b> NO. 13532247156 - 2247156</p> <p>ANILHA PROTEÇÃO TÉRMICA INJECTORES</p> <p>BMW X6 (E71 - E72) xDrive 35 d (De 01-2008 Até 03-2010) 210kW 286CV 2993cc Veículo todo-terreno fechado BMW X6 (E71 - E72) xDrive 40 d (De 07-2009 Até 06-2014) 225kW 306CV 2993cc Veículo todo-terreno fechado BMW X6 (E71 - E72) M 50 d (De 08-2011 Até 06-2014) 280kW 381CV 2993cc Veículo todo-terreno fechado</p> <p>d16x1mm 1f-d7mm</p>		<p><b>UAP81905</b> NO. 13532247156 - 2247156</p> <p>ANILHA PROTEÇÃO TÉRMICA INJECTORES</p> <p>BMW X6 (E71 - E72) xDrive 35 d (De 01-2008 Até 03-2010) 210kW 286CV 2993cc Veículo todo-terreno fechado BMW X6 (E71 - E72) xDrive 40 d (De 07-2009 Até 06-2014) 225kW 306CV 2993cc Veículo todo-terreno fechado BMW X6 (E71 - E72) M 50 d (De 08-2011 Até 06-2014) 280kW 381CV 2993cc Veículo todo-terreno fechado</p> <p>d14x1mm 1f-d7mm</p>

	<p><b>UAP81905</b> NO. 13532247156 - 2247156</p> <p>ANILHA PROTEÇÃO TÉRMICA INJECTORES</p> <p>BMW X6 (F16 - F86) xDrive 40 d (De 12-2014 Até .1-20 -) 230KW 313CV 2993cc Veículo todo-terreno fechado BMW X6 (F16 - F86) M 50 d (De 08-2014 Até .1-20 -) 280KW 381CV 2993cc Veículo todo-terreno fechado</p> <p>d14x1mm      1f-d7mm</p>		<p><b>UCRZ1083</b> NO. 31607503538 - 31607505006 - 31607545125 - 31607565314</p> <p>CRUZETA VEIO TRANSMISSÃO TRIPODE D43,20MM/26 DENTES</p> <p>BMW X6 (E71, E72) ActiveHybrid (De 01.2009 Até 10.2011) 357KW 485cv 4395cm3 SUV - BMW X6 (E71, E72) ActiveHybrid xDrive (De 01.2009 Até 10.2011) 300kW 408cv 4395cm3 SUV - BMW X6 (E71, E72) M (De 07.2009 Até 07.2014) 408kW 555cv 4395cm3 SUV - BMW X6 (E71, E72) xDrive 30 d (De 04.2008 Até 03.2010) 173kW 235cv 2993cm3 SUV - BMW X6 (E71, E72) xDrive 35 d (De 01.2008 Até 03.2010) 210kW 286cv 2993cm3 SU...</p> <p>d43.2mm      26 dentes</p>
	<p><b>UCRZ1097</b> NO. 26207556020 - 26207593164 - 26207597649 - 26207620521 - 26207629988 - 26208605866 - 26208628043</p> <p>CRUZETA TRANSMISSAO VEIO LONGITUDINAL D24X56MM</p> <p>BMW X6 (E71, E72) ActiveHybrid 01.2009/10.2011 357KW 485CV 4395CC N63 B44 A 0005AQC - BMW X6 (E71, E72) M 07.2009/07.2014 408KW 555CV 4395CC S63 B44 A 7909AAK - BMW X6 (E71, E72) M 50 d 08.2011/06.2014 280KW 381CV 2993CC N57 D30 C 0005BIX - BMW X6 (E71, E72) xDrive 30 d 04.2010/07.2014 155KW 211CV 2993CC N57 D30 A 0005AYH 0005BAW 0005BBF - BMW X6 (E71, E72) xDrive 30 d 04.2010/07.2014 180KW 245CV ...</p> <p>d24mm</p>		<p><b>UTR0848</b> NO. 17117521071</p> <p>TAMPÃO RESERVATÓRIO LIQUIDO REFRIGERAÇÃO</p> <p>BMW X6 (E71, E72) xDrive 30 d (04.09 A 06.14) 245cv 2993cc Veículo todo-terreno fechado - BMW X6 (E71, E72) xDrive 40 d (07.09 A 06.14) 306cv 2993cc Veículo todo-terreno fechado - BMW X6 (E71, E72) M 50 d (08.11 A 06.14) 381cv 2993cc Veículo todo-terreno fechado</p> <p>d88x45mm      1f-d53x25mm</p>
	<p><b>UTR0855</b> NO. 17137516004</p> <p>TAMPÃO RESERVATÓRIO LIQUIDO REFRIGERAÇÃO</p> <p>BMW X6 (E71, E72) M (07.08 A 06.14) 555cv 4395cc Veículo todo-terreno fechado - BMW X6 (E71, E72) xDrive 30 d (07.09 A 06.14) 211cv 2993cc Veículo todo-terreno fechado</p> <p>d88x45mm      1f-d53x25mm</p>		<p><b>W5099</b> NO. 11232247932 - 11237786611 - 11237788611 - 11237793593 - 11238511371</p> <p>POLIE DA CABBOTA (4+6 PISTAS)</p> <p>BMW X6 (E71, E72) xDrive 30 d 04.2008/03.2010 173KW 235CV 2993CC M57 D30 (306D3) 0005BBJ - BMW X6 (E71, E72) xDrive 35 d 01.2008/03.2010 210KW 286CV 2993CC M57 D30 (306D5) 0005AJO</p> <p>d191mm</p>
	<p><b>W5099-C</b> NO. 11237788611 - 11237793593</p> <p>POLIE DA CABBOTA (4+6 PISTAS)</p> <p>BMW X6 (E71, E72) xDrive 30 d 04.2008/03.2010 173KW 235CV 2993CC M57 D30 (306D3) 0005BBJ - BMW X6 (E71, E72) xDrive 35 d 01.2008/03.2010 210KW 286CV 2993CC M57 D30 (306D5) 0005AJO</p> <p>d191mm</p>		<p><b>Z50360</b> NO. 51161881149 - 7703072116 - N10259301</p> <p>MOLA REBITE FIXAÇÃO</p> <p>BMW X6 (E71, E72) M (07.2009 - 07.2014) 408kw 555cv 4395cm3 SUV BMW X6 (E71, E72) xDrive 30 d (04.2010 - 07.2014) 155kw 211cv 2993cm3 SUV BMW X6 (E71, E72) xDrive 30 d (04.2008 - 03.2010) 173kw 235cv 2993cm3 SUV BMW X6 (E71, E72) xDrive 35 d (01.2008 - 03.2010) 210kw 286cv 2993cm3 SUV BMW X6 (E71, E72) xDrive 35 i (01.2008 - 07.2014) 225kw 306cv 2979cm3 SUV BMW X6 (E71, E72) xDrive 40 d (07.2009 - ...)</p> <p>d5.5x 5.5mm      f-d11.5mm</p>
	<p><b>Z55266</b> NO. 07149136882</p> <p>MOLA DO PAINEL DAS PORTAS</p> <p>BMW X6 (A partir de 2007)</p> <p>F9mm T18mm L14mm H21mm S1-7mm</p>		<p><b>Z55278</b> NO. 51410407983 - 51418224781 - 51430141025</p> <p>MOLA PAINEL RESVESTIMENTO PORTAS</p> <p>BMW X6 (E71, E72) ActiveHybrid (01.2009 - 10.2011) 357kw 485cv 4395cm3 SUV BMW X6 (E71, E72) M (07.2009 - 07.2014) 408kw 555cv 4395cm3 SUV BMW X6 (E71, E72) M 50 d (08.2011 - 06.2014) 280kw 381cv 2993cm3 SUV BMW X6 (E71, E72) xDrive 30 d (04.2010 - 07.2014) 155kw 211cv 2993cm3 SUV BMW X6 (E71, E72) xDrive 30 d (04.2008 - 03.2010) 173kw 235cv 2993cm3 SUV BMW X6 (E71, E72) xDrive 30 d (04.2010 - 07....)</p> <p>F-8T-18mm      L-14H-21S1-7mm</p>
	<p><b>Z80843</b> NO. 51317064098</p> <p>MOLA DE FIXAÇÃO</p> <p>BMW X6 (E71)</p> <p>40x12x8.5mm</p>		

## BMW X6(F16 - F86)

	<p><b>E1122</b> NO. 18203404099 - 18207544809 - 18207568777 - 18207791570 - 18207798560</p> <p>ESTICADOR DO ESCAPE PANELA DE TRÁS</p> <p>BMW X6 (F16, F86) xDrive 30 d (De 08.2014 Até 07.2019) 190kW 258cv 2993cm3 SUV -</p> <p>82x50x25mm      2f-d10mm</p>		<p><b>KUBT3023</b> NO. 1f-d39mm(x2) 1f-d48mm(x2) 1f-d5mm</p> <p>KIT BORRACHAS TRAVAO PINÇA TRAS BRENBO 40MM</p> <p>BMW X6 (G06, F96) M50 i xDrive desde 08.2019 390KW 530KW 4395CC N63 B44 D 0005CWZ - BMW X6 (G06, F96) xDrive 30 d 08.2019/07.2020 155KW 211CV 2993CC B57 D30 A 0005CXC - BMW X6 (G06, F96) xDrive 30 d 08.2019/07.2020 183KW 249CV 2993CC B57 D30 A 0005CXB - BMW X6 (G06, F96) xDrive 30 d 08.2019/07.2020 195KW 265CV 2993CC B57 D30 A 0005CXA - BMW X6 (G06, F96) xDrive 40 i desde 08.2019 250KW 340CV 2998C...</p> <p>d59x12mm(x2) d54x3mm(x2) d58mm(x2) 1f-d48mm(x2) 1f-d5mm 1p d10x17mm.</p>
--	---	---	--

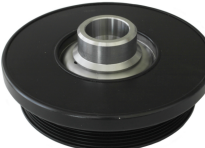
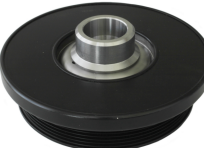
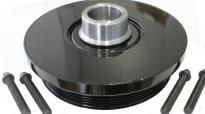
	<p><b>S2151</b> NO. 33326770951 - 33326770952</p> <p>SILENT-BLOC DO BRAÇO SUSPENSÃO TRÁS INTERIOR</p> <p>BMW X6 (F16, F86) M 12.2014/07.2019 423KW 575CV 4395CC S63 B44 B 7909ABL - BMW X6 (F16, F86) M 50 d 08.2014/07.2019 280KW 381CV 2993CC N57 D30 C 0005BYG - BMW X6 (F16, F86) xDrive 30 d 08.2014/07.2019 190KW 258CV 2993CC N57 D30 A 0005BYD - BMW X6 (F16, F86) xDrive 30 d 08.2014/07.2019 204KW 277CV 2993CC N57 D30 A 0005BYE - BMW X6 (F16, F86) xDrive 35 i 08.2014/07.2019 225KW 306CV 2979CC N55 B30 A ...</p> <p>d51x65mm c50mm-1f-d16mm</p>		<p><b>S2153</b> NO. 33326770951 - 33326770952 - 33326773632 - 6770951 - 6770952 - 6773632</p> <p>SILENT-BLOC DO BRAÇO SUSPENSÃO TRÁS INTERIOR À FRENTE</p> <p>BMW X6 (F16, F86) M 12.2014/07.2019 423KW 575CV 4395CC S63 B44 B 7909ABL - BMW X6 (F16, F86) M 50 d 08.2014/07.2019 280KW 381CV 2993CC N57 D30 C 0005BYG - BMW X6 (F16, F86) xDrive 30 d 08.2014/07.2019 190KW 258CV 2993CC N57 D30 A 0005BYD - BMW X6 (F16, F86) xDrive 30 d 08.2014/07.2019 204KW 277CV 2993CC N57 D30 A 0005BYE - BMW X6 (F16, F86) xDrive 35 i 08.2014/07.2019 225KW 306CV 2979CC N55 B30 A ...</p> <p>d51x70mm c50mm-1f-d12mm</p>
	<p><b>UCRZ1083</b> NO. 31607503538 - 31607505006 - 31607545125 - 31607565314</p> <p>CRUZETA VEIO TRANSMISSÃO TRIPODE D43,20MM/26 DENTES</p> <p>BMW X6 (F16, F86) M (De 12.2014 Até 07.2019) 423kW 575cv 4395cm3 SUV - BMW X6 (F16, F86) xDrive 50 i (De 08.2014 Até 07.2019) 330kW 449cv 4395cm3 SUV -</p> <p>d43.2mm 26 dentes</p>		<p><b>UCRZ1097</b> NO. 26207556020 - 26207593164 - 26207597649 - 26207620521 - 26207629988 - 26208605866 - 26208628043</p> <p>CRUZETA TRANSMISSAO VEIO LONGITUDINAL D24X56MM</p> <p>BMW X6 (F16, F86) M 12.2014/07.2019 423KW 575CV 4395CC S63 B44 B 7909ABL - BMW X6 (F16, F86) M 50 d 08.2014/07.2019 280KW 381CV 2993CC N57 D30 C 0005BYG - BMW X6 (F16, F86) xDrive 30 d 08.2014/07.2019 190KW 258CV 2993CC N57 D30 A 0005BYD - BMW X6 (F16, F86) xDrive 30 d 08.2014/07.2019 204KW 277CV 2993CC N57 D30 A 0005BYE - BMW X6 (F16, F86) xDrive 35 i 08.2014/07.2019 225KW 306CV 2979CC N55 B30 A ...</p> <p>d24mm</p>
	<p><b>W5186</b> NO. 11238515002</p> <p>POLIE DA CAMBOTA (6 PISTAS)</p> <p>BMW X6 (F16, F86): xDrive 40 d 12.2014/07.2019 230KW 313CV 2993CC</p> <p>d195/170mm d40mm</p>		<p><b>W5186</b> NO. 11238515002</p> <p>POLIE DA CAMBOTA (6 PISTAS)</p> <p>BMW X6 (F16, F86): xDrive 40 d 12.2014/07.2019 230KW 313CV 2993CC</p> <p>d195/170mm d40mm</p>
	<p><b>W5208</b> NO. 11237797996 - 11238511321 - 11238518985 - 11238578993 - 11238585220 - 11238586724 - 11238651643</p> <p>POLIE DA CAMBOTA (6 pistas)</p> <p>BMW X6 (F16, F86): xDrive 30 d 08.2014/07.2019 190KW 258CV 2993CC - BMW X6 (F16, F86): xDrive 30 d 08.2014/07.2019 204KW 277CV 2993CC - BMW X6 (F16, F86): xDrive 40 d 12.2014/07.2019 230KW 313CV 2993CC</p> <p>d196mm d40/60mm 4f-d10mm</p>		

BMW Z1

	<p><b>D0026</b> NO. 26111204294 - 26111207785 - 26111225624</p> <p>CARDAN TRANSMISSÃO D110X28MM 6 FUROS 10MM ENTRE FUROS 78MM</p> <p>BMW Z1 Roadster 2.5 (06.88 A 06.91) 170cv 2494cc Cabriolet</p> <p>d110x28mm 1f-d40mm 6f-d10mm</p>		<p><b>D0060</b> NO. 32311115090 - 32311115092</p> <p>CARDAN COLUNA DIREÇÃO</p> <p>BMW Z1 Roadster 2.5 06.1988/06.1991 125KW 170CV 2494CC M20 B25 (256K1) 0005484</p> <p>65x65x13mm 4f-d8mm</p>
	<p><b>F0550-I</b> NO. 32111116068 - 32111117426 - 32111117698</p> <p>FOLE DA DIREÇÃO ESQUERDO</p> <p>BMW Z1 Roadster 2.5 06.1988/06.1991 125KW 170CV 2494CC M20 B25 (256K1) 0005484</p> <p>d65x134mm 2f-d53mm</p>		<p><b>F1800-I</b> NO. 33211226033 - 33211226719 - 33211229205 - 33217504703 - 33219067809 - 33219067814 - 33219067895 -</p> <p>FOLE TRANSMISSÃO JUNTO A CAIXA FALANGE D105MM</p> <p>BMW Z1 (E30Z) 2.5i (88 A 91)</p> <p>d102x94mm 1f-d100mm 1f-d22mm</p>
	<p><b>M6028</b> NO. 18111175311</p> <p>JUNTA DE ESCAPE</p> <p>BMW Z1</p> <p>d57x10mm 1f-d47mm</p>		<p><b>UMB84038</b> NO. 07119937331 - 11111276473 - 11111714712</p> <p>TAMPÃO BLOCO MOTOR</p> <p>BMW Z1 Roadster 2.5 (06.88 A 06.91) 170cv 2494cc Cabriolet</p> <p>d-45x12,1mm di-42mm</p>



	<b>Y3239</b>	NO. 36130141574 - 36130141576 - 36131095390 - 36131116717 - 36131117190 - 36131126191		<b>Z80834</b>	NO. 51321938884
	PARAFUSO PERNO RODA CHAVE 17 M12X1,50X50MM ( BASE CONICA ) BMW Z1 Roadster 2.5 06.1988/06.1991 125KW 170CV 2494CC M20 B25 (256K1) 0005484			MOLA DE FIXAÇÃO BMW Z1 Roadster: 2.5 06.1988/06.1991 125KW 170CV 2494CC	
c51mm (ch-17mm)		M12x1x24mm	37x29x12.2mm		

## BMW Z3(E36)

	<b>A1947</b>	NO. 0019811225 - 0029812925 - 0039812325 - 0089814325 - 26121103728 - 26121209590 - 26121225071 - 2612121...		<b>D0022</b>	NO. 26111209168 - 26111227420 - 26111227717 - 26111229080 - 26111229360 - 261117511454
	APOIO DA TRANSMISSÃO BMW Z3 Roadster (E36) 1.8 i CÃ³digo do mot or: M 43184E2 (10.95 A 10.98) 116cv 1796cc Cabriolet - BMW Z3 Roadster (E36) 1.9 i Tipo de carroçaria: Coupé (01.99 A 01.03) 116cv 1895cc Cabriolet - BMW Z3 Roadster (E36) 1.9 i Tipo de carroçaria: Coupé (07.98 A 01.03) 118cv 1895cc Cabriolet - BMW Z3 Roadster (E36) 1.9 i Tipo de carroçaria: Coupé (10.95 A 03.99) 140cv 1895cc Cabriolet - BMW Z3 Roa...			CARDAN TRANSMISSÃO D135X30MM 6 FUIROS 12MM ENTRE FUIROS 96MM BMW Z3 Coupé (E36) 2.8 i 01.1998/05.2000 142KW 193CV 2793CC M52 B28 (286S2) M52 B28 (286S1) 0005647 0005620 - BMW Z3 Coupé (E36) 3.0 i 06.2000/06.2003 170KW 231CV 2979CC M54 B30 (306S3) 0005687 - BMW Z3 Roadster (E36) 2.0 i 04.1999/01.2003 110KW 150CV 1990CC M52 B20 (206S4) 0005651 - BMW Z3 Roadster (E36) 2.2 i 10.2000/06.2002 125KW 170CV 2171CC M54 B22 (226S1) 0005714 - BMW Z3 Roadster (E36) 2.5 ...	
180x100x45mm		1f-d30mm	d132x123x30mm		6f-d12mm
	<b>D0026</b>	NO. 26111204294 - 26111207785 - 26111225624		<b>D0049</b>	NO. 1227410 - 1227869 - 1229516 - 26111227410 - 26111227869 - 26111229516 - 26611227410 - 26611227869
	CARDAN TRANSMISSÃO D110X28MM 6 FUIROS 10MM ENTRE FUIROS 78MM BMW Z3 Roadster (E36) 1.9 i (01.99 A 01.03) 116cv 1895cc Cabriolet - BMW Z3 Roadster (E36) 1.9 i (07.98 A 01.03) 118cv 1895cc Cabriolet - BMW Z3 Roadster (E36) 1.9 i T (10.95 A 03.99) 140cv 1895cc Cabriolet			CARDAN TRANSMISSÃO BMW Z3 Coupé (E36) 2.8 i 01.1998/05.2000 142KW 193CV 2793CC M52 B28 (286S2) M52 B28 (286S1) 0005647 0005620 - BMW Z3 Coupé (E36) 3.0 i 06.2000/06.2003 170KW 231CV 2979CC M54 B30 (306S3) 0005687 - BMW Z3 Roadster (E36) 1.8 i 10.1995/10.1998 85KW 116CV 1796CC M43 B18 (184E2) 0005586 - BMW Z3 Roadster (E36) 1.9 i 11.1995/03.1999 103KW 140CV 1895CC M44 B19 (194S1) 0005587 - BMW Z3 Roadster (E36) 1.9 i...	
d110x28mm		1f-d40mm 6f-d10mm	111x107x32mm		6f-d12mm
	<b>E1110</b>	NO.		<b>F1641A-I</b>	NO. 33211229209 - 33211229378 - 33217504705 - 33219067805
	ESTICADOR DO ESCAPE BMW Z3 (E36) 2.2 i (08.00 A 01.03) 170cv 2171cc Cabriolet - BMW Z3 (E36) 3.0 i (06.00 A 01.03) 231cv 2979cc Cabriolet - BMW Z3 Coupé (E36) 3.0 i (06.00 A 06.03) 231cv 2979cc Coupé			FOLE DA TRANSMISSÃO JUNTO À CAIXA BMW Z3 Coupé (E36) M 02.1998/06.2001 236K2 321CC 3201CC S50 B32 (326S1) S50 B32 (326S3) 7909310 - BMW Z3 Coupé (E36) M 06.2001/06.2003 239KW 325CV 3246CC S54 B32 (326S4) 7909314 - BMW Z3 Roadster (E36) M 3.2 01.1997/06.2000 236KW 321CV 3201CC S50 B32 (326S1) 7909309 - BMW Z3 Roadster (E36) M 3.2 06.2001/01.2003 239KW 325CV 3246CC S54 B32 (326S4) 7909313	
65x64x32mm		2f-d9mm	d110x92mm		1f-d106mm 1f-d25mm
	<b>F1650A-I</b>	NO. 33211209551 - 33211229221 - 33219067815 - 33219067906		<b>F4345</b>	NO. 33211226033 - 33211226264 - 33211229221 - 3321129378 - 33217504704 - 33219067813 - 33219067815
	FOLE DA TRANSMISSÃO JUNTO À CAIXA BMW SÉRIE Z3(E36) 2.8i (1995 A 2003)			FOLE DA TRANSMISSÃO JUNTO À RODA (GASTA 2 UNIDADES ) BMW Z3 Coupé (E36) 2.8 i 01.1998/05.2000 142KW 193CV 2793CC M52 B28 (286S2) M52 B28 (286S1) 0005647 0005620 - BMW Z3 Roadster (E36) 2.2 i 10.2000/06.2002 125KW 170CV 2171CC M54 B22 (226S1) 0005714 - BMW Z3 Roadster (E36) 2.8 i 11.1996/05.2000 142KW 193CV 2793CC M52 B28 (286S1) M52 B28 (286S2) 0005646 0005614	
d110x125mm		1f-d108mm 1f-d25mm	d81x79mm		1f-d22mm-1f-d52mm
	<b>KT0624-I</b>	NO. 31330146239 - 31331094749 - 31336764085		<b>KUR21999</b>	NO. 1f-d24mm 1f-d10mm 1f-d10mm 1f-d19mm
	KIT BATENTE SUSPENSÃO DA FRENTE BMW Z3 Roadster (E36) 2.0 i (De 04-1999 Até 01-2003) 110KW 150CV 1991cc Cabriolet			KIT DE REPARAÇÃO ALAVANCA DE VELOCIDADES BMW Z3 Coupé (E36) 2.8 i (De 01.1998 Até 05.2000) 142KW 193cv 2793cm3 Coupé - BMW Z3 Coupé (E36) 3.0 i (De 06.2000 Até 06.2003) 170KW 231cv 2979cm3 Coupé - BMW Z3 Roadster (E36) 1.8 i (De 10.1995 Até 10.1998) 85KW 116cv 1796cm3 Cabriolet - BMW Z3 Roadster (E36) 1.9 i (De 01.1999 Até 01.2003) 85KW 116cv 1895cm3 Cabriolet - BMW Z3 Roadster (E36) 1.9 i (De 07.1998 Até 01.2003) 87KW 118cv 1895cm3 Cabr...	
d90x190mm		1f-d23mm 1f-d70mm	d37x18mm d19x25mm d17x22mm d31x210mm d31x2610mm d44x190mm d44x15mm		
	<b>P1055</b>	NO. 35211160421		<b>P1059</b>	NO. 1 108 634 - 35211108634
	CAPA DE PEDAL DO TRAVÃO (VEÍCULOS COM CAIXA AUTOMÁTICA) BMW Z3 Coupé (E36) 2.8 i 01.1998/05.2000 142KW 193CV 2793CC M52 B28 (286S2) M52 B28 (286S1) 0005647 0005620 - BMW Z3 Coupé (E36) 3.0 i 06.2000/06.2003 170KW 231CV 2979CC M54 B30 (306S3) 0005687 - BMW Z3 Roadster (E36) 1.9 i 11.1995/03.1999 103KW 140CV 1895CC M44 B19 (194S1) 0005587 - BMW Z3 Roadster (E36) 1.9 i 07.1998/01.2003 87KW 118CV 1895CC M43 B19 (194E1) 0005644 - BMW Z3 Roadster (E36) 2.0 i...			CAPA DE PEDAL DO TRAVÃO BMW Z3 1.8 - 1.9 - 2.0 - 2.2 - 2.8 - M 3.2 (10-1995 A 01-2003)	
74x107x42mm			75x62x12mm		

	<p><b>R080024</b> NO. 48-56-36-225-27-41-19mm 1f-d6mm 1f</p> <p>TUBO RIGIDO DE REFRIGERAÇÃO</p> <p>BMW Z3 Coupé (E36) 2.8 i 01.1998/05.2000 142KW 193CV 2793CC M52 B28 (286S2) M52 B28 (286S1) 0005647 0005620 - BMW Z3 Coupé (E36) 3.0 i 06.2000/06.2003 170KW 231CV 2979CC M54 B30 (306S3) 0005687</p> <p>B475-14/17mm 48-56-36-225-27-41-19mm 1f-d6mm 1f-d6mm</p>		<p><b>R080024</b> NO. 48-56-36-225-27-41-19mm 1f-d6mm 1f</p> <p>TUBO RIGIDO DE REFRIGERAÇÃO</p> <p>BMW Z3 Roadster (E36) 2.0 i 04.1999/01.2003 110KW 150CV 1990CC M52 B20 (206S4) 0005651 - BMW Z3 Roadster (E36) 2.2 i 10.2000/06.2002 125KW 170CV 2171CC M54 B22 (226S1) 0005714 - BMW Z3 Roadster (E36) 2.8 i 11.1996/05.2000 142KW 193CV 2793CC M52 B28 (286S1) M52 B28 (286S2) 0005646 0005614 - BMW Z3 Roadster (E36) 3.0 i 06.2000/01.2003 170KW 231CV 2979CC M54 B30 (306S3) 0005686</p> <p>B475-14/17mm 48-56-36-225-27-41-19mm 1f-d6mm 1f-d6mm</p>
	<p><b>R225953</b> NO. 13541435625</p> <p>TUBO DE ADMISSÃO FILTRO DE AR</p> <p>BMW Z3 Roadster (E36) 2.8 i 11.1996/05.2000 142KW 193CV 2793CC M52 B28 (286S1) M52 B28 (286S2) 0005646 0005614</p> <p>B190-74/77mm 91x140mm ch-d15x20mm</p>		<p><b>R8184</b> NO. 32411093130 - 32411095526</p> <p>TUBO DE LIGAÇÃO DA BOMBA HIDRÁULICA DIREÇÃO</p> <p>BMW Z3 Coupé (E36) 2.8 i 01.1998/05.2000 142KW 193CV 2793CC M52 B28 (286S2) M52 B28 (286S1) 0005647 0005620 - BMW Z3 Coupé (E36) 3.0 i 06.2000/06.2003 170KW 231CV 2979CC M54 B30 (306S3) 0005687 - BMW Z3 Roadster (E36) 2.0 i 04.1999/01.2003 110KW 150CV 1990CC M52 B20 (206S4) 0005651 - BMW Z3 Roadster (E36) 2.2 i 10.2000/06.2002 125KW 170CV 2171CC M54 B22 (226S1) 0005714 - BMW Z3 Roadster (E36) 2.8 ...</p> <p>B360-d16/d16mm</p>
	<p><b>S2061</b> NO. 33171093565 - 33176751808 - 33316769376</p> <p>SILENT-BLOC DO EIXO SUSPENSÃO DE TRÁS</p> <p>BMW Z3 Roadster (E36) 2.0 i (De 04.1999 Até 01.2003) 110kW 150cv 1990cm3 Cabriolet -</p> <p>d68x60mm c55mm 1f-d18mm</p>		<p><b>S2078</b> NO. 33171092516 - 33176770788</p> <p>SILENT-BLOC DA SUSPENSÃO EIXO TRASEIRO CENTRO</p> <p>BMW Z3 Roadster (E36) 2.0 i (De 04.1999 Até 01.2003) 110kW 150cv 1990cm3 Cabriolet -</p> <p>d47x47mm c40mm 1f-d12mm</p>
	<p><b>S2079</b> NO. 33311092517 - 33316770781</p> <p>SILENT-BLOC DA SUSPENSÃO EIXO TRASEIRO AMBOS OS LADOS</p> <p>BMW Z3 Roadster (E36) 2.0 i (De 04.1999 Até 01.2003) 110kW 150cv 1990cm3 Cabriolet -</p> <p>d81x 63mm d74mm 1f-d20mm</p>		<p><b>S2080</b> NO. 33311092516 - 33316757394 - 33316770784</p> <p>SILENT-BLOC DA SUSPENSÃO EIXO TRASEIRO LADO DIREITO</p> <p>BMW Z3 Roadster (E36) 2.0 i (De 04.1999 Até 01.2003) 110kW 150cv 1990cm3 Cabriolet -</p> <p>d81x 63mm d70mm 1f-d12mm</p>
	<p><b>S2081</b> NO. 33311092515 - 33316757393 - 33316770783</p> <p>SILENT-BLOC DA SUSPENSÃO EIXO TRASEIRO LADO ESQUERDO</p> <p>BMW Z3 Roadster (E36) 2.0 i (De 04.1999 Até 01.2003) 110kW 150cv 1990cm3 Cabriolet -</p> <p>d82x 63mm d70mm 1f-d12mm</p>		<p><b>T0621-I</b> NO. 31331124449 - 31331124573 - 31331125215</p> <p>BATENTE SUSPENSÃO FRENTE</p> <p>BMW Z3 (E36) 1.8 i (10.95 A 10.98) 116cv 1796cc Cabriolet - BMW Z3 (E36) 1.9 i (10.95 A 03.99) 140cv 1895cc Cabriolet - BMW Z3 (E36) 2.8 i (04.97 A 06.00) 192cv 2793cc Cabriolet</p> <p>d59x85mm 1f-d26mm 1f-d18mm</p>
	<p><b>U7004</b> NO. 13641286708 - 13641730767</p> <p>ORING DE VÁLVULA INJECTORA (Di 7,52 - De 14,58 - E 3,53)</p> <p>BMW Z3 Coupé (E36) 2.8 i (01.1998 - 05.2000) 142kw 193cv 2793cm3 Coupé BMW Z3 Coupé (E36) M (02.1998 - 06.2001) 236kw 321cv 3201cm3 Coupé BMW Z3 Coupé (E36) M (06.2001 - 06.2003) 239kw 325cv 3246cm3 Coupé</p> <p>d14x3mm 1f-d8mm</p>		<p><b>U7033K</b> NO. 61671378609 - 64500149356 - 64500301636 - 64501363572 - 64501466019 - 64501468463 - 64508390601</p> <p>ORINGS BOMBA DIREÇÃO ASSISTIDA</p> <p>BMW Z3 Coupé (E36) 2.8 i (01.1998 - 05.2000) 142kw 193cv 2793cm3 Coupé BMW Z3 Coupé (E36) 3.0 i (06.2000 - 06.2003) 170kw 231cv 2979cm3 Coupé BMW Z3 Roadster (E36) 1.8 i (10.1995 - 10.1998) 85kw 116cv 1796cm3 Cabriolet BMW Z3 Roadster (E36) 1.9 i (01.1999 - 01.2003) 85kw 116cv 1895cm3 Cabriolet BMW Z3 Roadster (E36) 1.9 i (07.1998 - 01.2003) 8kw 118cv 1895cm3 Cabriolet BMW Z3 Roadster (E36) 1.9 i...</p> <p>d11x2mm d10x2mm 1f-d7mm 1f-d6mm</p>
	<p><b>UFQ23302</b> NO. 21511223302</p> <p>FORQUILHA DA EMBRAIAGEM</p> <p>BMW Z3 Coupé (E36) 2.8 i 01.1998/05.2000 142KW 193CV 2793CC M52 B28 (286S2) M52 B28 (286S1) 0005647 0005620 - BMW Z3 Coupé (E36) 3.0 i 06.2000/06.2003 170KW 231CV 2979CC M54 B30 (306S3) 0005687 - BMW Z3 Roadster (E36) 2.0 i 04.1999/01.2003 110KW 150CV 1990CC M52 B20 (206S4) 0005651 - BMW Z3 Roadster (E36) 2.2 i 10.2000/06.2002 125KW 170CV 2171CC M54 B22 (226S1) 0005714 - BMW Z3 Roadster (E36) 2.5 ...</p> <p>252x83x28mm 1f-47x75mm</p>		<p><b>UFQ23302</b> NO. 21511223302</p> <p>FORQUILHA DA EMBRAIAGEM</p> <p>BMW Z4 Roadster (E85) 2.2 i 10.2003/10.2005 125KW 170CV 2171CC M54 B22 (226S1) 0005790 - BMW Z4 Roadster (E85) 2.5 i 12.2002/12.2005 141KW 192CV 2494CC M54 B25 (256S5) 0005758 - BMW Z4 Roadster (E85) 3.0 i 12.2002/12.2005 170KW 231CV 2979CC M54 B30 (306S3) 0005757</p> <p>252x83x28mm 1f-47x75mm</p>
	<p><b>UMB84029</b> NO. 07119937320 - 11111276472 - 11111717939 - 1717939 - 9937321</p> <p>TAMPÃO BLOCO MOTOR</p> <p>BMW Z3 Roadster (E36) 1.8 i (De 10-1995 Até 10-1998) 85kW 116CV 1796cc Cabriolet BMW Z3 Roadster (E36) 1.9 i (De 01-1999 Até 01-2003) 85kW 116CV 1895cc Cabriolet BMW Z3 Roadster (E36) 1.9 i (De 07-1998 Até 01-2003) 87kW 118CV 1895cc Cabriolet BMW Z3 Roadster (E36) 1.9 i (De 10-1995 Até 03-1999) 103kW 140CV 1895cc Cabriolet</p> <p>d36x10mm di-32mm</p>		<p><b>UMB84038</b> NO. 07119937331 - 11111276473 - 11111714712</p> <p>TAMPÃO BLOCO MOTOR</p> <p>BMW Z3 Roadster (E36) M 3.2 (03.97 A 06.01) 321cv 3201cc Cabriolet - BMW Z3 Roadster (E36) M 3.2 (06.01 A 01.03) 325cv 3246cc Cabriolet - BMW Z3 Coupé (E36) M (02.98 A 06.01) 321cv 3201cc Coupé - BMW Z3 Coupé (E36) M (06.01 A 06.03) 325cv 3246cc Coupé</p> <p>d-45x12,1mm di-42mm</p>

	<p><b>UMV25110</b> NO. 25111434495 - 25117500299 - 25117503231 - 25117523817 - 25117544524</p> <p><b>MANETE PUNHO TOPO ALAVANCA MUDANÇAS 5 VELOCIDADES NAPEL F14MM</b></p> <p>BMW Z3 Roadster (E36): 1.9 i 11.1995/03.1999 103KW 140CV 1895CC - BMW Z3 Roadster (E36): 2.5 i 10.2000/08.2002 141KW 192CV 2494CC - BMW Z3 Roadster (E36): 2.8 i 11.1996/05.2000 142KW 193CV 2793CC - BMW Z3 Roadster (E36): 2.8 i 01.1996/07.2000 143KW 194CV 2793CC - BMW Z3 Roadster (E36): 3.0 i 06.2000/01.2003 170KW 231CV 2979CC - BMW Z3 Coupé (E36): 2.8 i 01.1998/05.2000 142KW 193CV 2793CC - BMW Z3 ...</p> <p>d51x91mm 1f-d14mm</p>		<p><b>UMV25114</b> NO. 25111434495 - 25117500299 - 25117503231 - 25117523817 - 25117544524</p> <p><b>MANETE PUNHO TOPO ALAVANCA MUDANÇAS 5 VELOCIDADES F14MM</b></p> <p>BMW Z3 Roadster (E36): 1.9 i 11.1995/03.1999 103KW 140CV 1895CC - BMW Z3 Roadster (E36): 2.5 i 10.2000/08.2002 141KW 192CV 2494CC - BMW Z3 Roadster (E36): 2.8 i 11.1996/05.2000 142KW 193CV 2793CC - BMW Z3 Roadster (E36): 2.8 i 01.1996/07.2000 143KW 194CV 2793CC - BMW Z3 Roadster (E36): 3.0 i 06.2000/01.2003 170KW 231CV 2979CC - BMW Z3 Coupé (E36): 2.8 i 01.1998/05.2000 142KW 193CV 2793CC - BMW Z3 ...</p> <p>d56x94mm 1f-d14mm</p>
	<p><b>UPV86150</b> NO. 1384859 - 61601384859</p> <p><b>PULVERIZADOR ESGUICHO PARA-BRISAS</b></p> <p>BMW Z3 Coupé (E36) 2.8 i (De 01.1998 Até 05.2000) 142kW 193cv 2793cm3 Coupé - BMW Z3 Coupé (E36) 3.0 i (De 06.2000 Até 06.2003) 170kW 231cv 2979cm3 Coupé - BMW Z3 Coupé (E36) M (De 02.1998 Até 06.2001) 236kW 321cv 3201cm3 Coupé - BMW Z3 Coupé (E36) M (De 06.2001 Até 06.2003) 239kW 325cv 3246cm3 Coupé - BMW Z3 Roadster (E36) 1.8 i (De 10.1995 Até 10.1998) 85kW 116cv 1796cm3 Cabriolet - BMW Z3 Roads...</p> <p>30x20x48mm 1p-d6x38mm</p>		<p><b>UTR0812</b> NO. 17110152374 - 17111468076 - 17111712492 - 17111712669 - 17111742231 - 17117639022 - 17119071581</p> <p><b>TAMPÃO RESERVATÓRIO LIQUIDO REFRIGERAÇÃO</b></p> <p>BMW Z3 Roadster 1.8 i (10.95 A 10.98) 116cv 1796cc Cabriolet - BMW Z3 Roadster 1.9 i (01.99 A 01.03) 116cv 1895cc Cabriolet - BMW Z3 Roadster 1.9 i (07.98 A 01.03) 118cv 1895cc Cabriolet - BMW Z3 Roadster 1.9 i (10.95 A 03.99) 140cv 1895cc Cabriolet - BMW Z3 Roadster 2.0 i (04.99 A 01.03) 150cv 1991cc Cabriolet - BMW Z3 Roadster 2.2 i (08.00 A 01.03) 170cv 2171cc Cabriolet - BMW Z3 Roa...</p> <p>d65x45mm 1f-d52x20mm</p>
	<p><b>Y3239</b> NO. 36130141574 - 36130141576 - 36131095390 - 36131116717 - 36131117190 - 36131126191</p> <p><b>PARAFUSO PERNO RODA CHAVE 17 M12X1,50X50MM ( BASE CONICA )</b></p> <p>BMW Z3 Coupé (E36) 2.8 i 01.1998/05.2000 142KW 193CV 2793CC M52 B28 (286S2) M52 B28 (286S1) 0005647 0005620 - BMW Z3 Coupé (E36) 3.0 i 06.2000/06.2003 170KW 231CV 2979CC M54 B30 (306S3) 0005687 - BMW Z3 Coupé (E36) M 02.1998/06.2001 236KW 321CV 3201CC S50 B32 (326S1) S50 B32 (326S3) 7909310 - BMW Z3 Coupé (E36) M 06.2001/06.2003 239KW 325CV 3246CC S54 B32 (326S4) 7909314</p> <p>c51mm (ch-17mm) M12x1x24mm</p>		<p><b>Y3239</b> NO. 36130141574 - 36130141576 - 36131095390 - 36131116717 - 36131117190 - 36131126191</p> <p><b>PARAFUSO PERNO RODA CHAVE 17 M12X1,50X50MM ( BASE CONICA )</b></p> <p>BMW Z3 Roadster (E36) 1.8 i 10.1995/10.1998 85KW 116CV 1796CC M43 B18 (184E2) 0005586 - BMW Z3 Roadster (E36) 1.9 i 11.1995/03.1999 103KW 140CV 1895CC M44 B19 (194S1) 0005587 - BMW Z3 Roadster (E36) 1.9 i 07.1998/01.2003 87KW 118CV 1895CC M43 B19 (194E1) 0005644 - BMW Z3 Roadster (E36) 1.9 i 01.1999/01.2003 85KW 116CV 1895CC M43 B19 (194E1) 0005645 - BMW Z3 Roadster (E36) 2.0 i 04.1999/01.2003 110...</p> <p>c51mm (ch-17mm) M12x1x24mm</p>
	<p><b>Z80834</b> NO. 51321938884</p> <p><b>MOLA DE FIXAÇÃO</b></p> <p>BMW Z3 Roadster (E36): 1.8 i 10.1995/10.1998 85KW 116CV 1796CC - BMW Z3 Roadster (E36): 1.9 i 01.1999/01.2003 85KW 116CV 1895CC - BMW Z3 Roadster (E36): 1.9 i 07.1998/01.2003 87KW 118CV 1895CC - BMW Z3 Roadster (E36): 1.9 i 11.1995/03.1999 103KW 140CV 1895CC - BMW Z3 Roadster (E36): 2.0 i 04.1999/01.2003 110KW 150CV 1990CC - BMW Z3 Roadster (E36): 2.2 i 10.2000/06.2002 125KW 170CV 2171CC - BMW Z3 ...</p> <p>37x29x12.2mm</p>		<p><b>Z80849</b> NO. 51411973500 - 99950758240</p> <p><b>Mola de painel</b></p> <p>BMW Z3</p> <p>d18x21mm 1p-d9-13mm</p>

## BMW Z4 (E85) - (E86) - (E89) - (G29)

	<p><b>A2569</b> NO. 22316796617</p> <p><b>APOIO DA CAIXA DE VELOCIDADES</b></p> <p>BMW Z4 Roadster (G29) sDrive 20 i (De 11.2018 -) 120kW 163cv 1998cm3 Cabriolet - BMW Z4 Roadster (G29) sDrive 20 i (De 11.2018 -) 145kW 197cv 1998cm3 Cabriolet -</p> <p>74x46x40mm 1p-d7x16mm 1p-d8x31mm</p>		<p><b>D0022</b> NO. 26111209168 - 26111227420 - 26111227717 - 26111229080 - 26111229360 - 26117511454</p> <p><b>CARDAN TRANSMISSÃO D135X30MM 6 FUIROS 12MM ENTRE FUIROS 96MM</b></p> <p>BMW Z4 Coupé (E86) 3.0 si 04.2006/08.2008 195KW 265CV 2996CC N52 B30 A N52 B30 BF 0005AAF - BMW Z4 Roadster (E85) 2.2 i 10.2003/10.2005 125KW 170CV 2171CC M54 B22 (226S1) 0005790 - BMW Z4 Roadster (E85) 2.5 i 12.2002/12.2005 141KW 192CV 2494CC M54 B25 (256S5) 0005758 - BMW Z4 Roadster (E85) 3.0 i 12.2002/12.2005 170KW 231CV 2979CC M54 B30 (306S3) 0005757</p> <p>d132x123x30mm 6f-d12mm</p>
	<p><b>D0049</b> NO. 1227410 - 1227869 - 1229516 - 26111227410 - 26111227869 - 26111229516 - 26611227410 - 26611227869 -</p> <p><b>CARDAN TRANSMISSÃO</b></p> <p>BMW Z4 Roadster (E85) 2.2 i 10.2003/10.2005 125KW 170CV 2171CC M54 B22 (226S1) 0005790 - BMW Z4 Roadster (E85) 2.5 i 12.2002/12.2005 141KW 192CV 2494CC M54 B25 (256S5) 0005758 - BMW Z4 Roadster (E85) 3.0 i 12.2002/12.2005 170KW 231CV 2979CC M54 B30 (306S3) 0005757</p> <p>111x107x32mm 6f-d12mm</p>		<p><b>E1122</b> NO. 18203404099 - 18207544809 - 18207568777 - 18207791570 - 18207798560</p> <p><b>ESTICADOR DO ESCAPE PANELA DE TRÁS</b></p> <p>BMW Z4 Coupé (E86) 3.0 si (De 04.2006 Até 08.2008) 195kW 265cv 2996cm3 Coupé -</p> <p>82x50x25mm 2f-d10mm</p>
	<p><b>E1122</b> NO. 18203404099 - 18207544809 - 18207568777 - 18207791570 - 18207798560</p> <p><b>ESTICADOR DO ESCAPE PANELA DE TRÁS</b></p> <p>BMW Z4 Roadster (E85) 2.5 i (De 09.2005 Até 02.2009) 130kW 177cv 2497cm3 Cabriolet - BMW Z4 Roadster (E85) 2.5 si (De 01.2006 Até 08.2008) 160kW 218cv 2497cm3 Cabriolet - BMW Z4 Roadster (E85) 3.0 si (De 01.2006 Até 08.2008) 195kW 265cv 2996cm3 Cabriolet -</p> <p>82x50x25mm 2f-d10mm</p>		<p><b>F1799-I</b> NO. 33211229593 - 33217529916 - 33217547081</p> <p><b>FOLE TRANSMISSÃO JUNTO A CAIXA FALANGE D105MM</b></p> <p>BMW Z4 (E85) (APÓS 2003) 2.5i - 3.0i</p> <p>d102x100mm 1f-d100mm 1f-d23mm</p>



	<p><b>F1805-I</b> NO. 1094933 - 32131094933 - 32131096465 - 32131096910 - 32211139786</p> <p>FOLE DIREÇÃO ( GASTA 2 UNIDADES )</p> <p>BMW Z4 (E85)</p> <p>d70x175mm 1f-d55mm 1f-d42mm</p>		<p><b>F1805-I</b> NO. 1094933 - 32131094933 - 32131096465 - 32131096910 - 32211139786</p> <p>FOLE DIREÇÃO ( GASTA 2 UNIDADES )</p> <p>BMW Z4 (E86)</p> <p>d70x175mm 1f-d55mm 1f-d42mm</p>
	<p><b>F1846-I</b> NO. 33211229594 - 33217527325 - 33217527326 - 33217529915 - 33217547080</p> <p>FOLE DA TRANSMISSÃO JUNTO À RODA</p> <p>BMW Z4 (E85) 2.5i - 3.0i (APÓS 2003)</p> <p>d80x78mm 1f-d51mm 1f-d31mm</p>		<p><b>KF1385</b> NO. 33211229376</p> <p>KIT DE FOLE DO CARDAN JUNTO À RODA</p> <p>BMW Z4 (E85) (APÓS 2003) 2.5i - 3.0i</p> <p>d80x76mm 1f-d52mm 1f-d22mm</p>
	<p><b>KF1385</b> NO. 33211229376</p> <p>KIT DE FOLE DO CARDAN JUNTO À RODA</p> <p>BMW Z4 (E85) (APÓS 2003) 2.5i - 3.0i</p> <p>d80x76mm 1f-d52mm 1f-d22mm</p>		<p><b>KUBT3023</b> NO. 1f-d39mm(x2) 1f-d48mm(x2) 1f-d55mm</p> <p>KIT BORRACHAS TRAVAO PINÇA TRAS BRENBO 40MM</p> <p>BMW Z4 Roadster (G29) M40 i desde 11.2018 25KW 340CV 2998CC B58 B30 C 0005CTI - BMW Z4 Roadster (G29) sDrive 20 i desde 11.2018 120KW 163CV 1998CC B48 B20 BB46 B20 B 0005CTJ - BMW Z4 Roadster (G29) sDrive 20 i desde 11.2018 145KW 197CV 1998CC B48 B20 BB46 B20 B 0005CTG - BMW Z4 Roadster (G29) sDrive 30 i desde 11.2018 190KW 258CV 1998CC B46 B20 BB48 B20 B 0005CTH</p> <p>d59x12mm(x2) d54x3mm(x2) d59x11mm(x2) 1f-d48mm(x2) 1f-d55mm 1p-d10x17mm</p>
	<p><b>KUBT3027</b> NO. 34103413265 - 34116750151</p> <p>KIT BORRACHAS TRAVAO PINÇA FRENTE ATE/TEVES 57MM</p> <p>BMW Z4 Coupé (E86) 3.0 si 04.2006/08.2008 195KW 265CV 2996CC N52 B30 A N52 B30 BF 0005AAF</p> <p>d70x13mm d66x3mm d14x9mm d14x13mm 1f59mm 1f-d5mm</p>		<p><b>KUBT3027</b> NO. 34103413265 - 34116750151</p> <p>KIT BORRACHAS TRAVAO PINÇA FRENTE ATE/TEVES 57MM</p> <p>BMW Z4 Roadster (E85) 3.0 si 01.2006/08.2008 195KW 265CV 2996CC N52 B30 BF N52 B30 A 0005AAA</p> <p>d70x13mm d66x3mm d14x9mm d14x13mm 1f59mm 1f-d5mm</p>
	<p><b>KUR21999</b> NO. 1f-d24mm 1f-d10mm 1f-d10mm 1f-d19mm</p> <p>KIT DE REPARAÇÃO ALAVANCA DE VELOCIDADES</p> <p>BMW Z4 Coupé (E86) 3.0 si (De 04.2006 Até 08.2008) 195kW 265cv 2996cm3 Coupé -</p> <p>d37x18mm d19x25mm d17x22mm d31x21mm d31x20mm d12x19mm</p>		<p><b>KUR21999</b> NO. 1f-d24mm 1f-d10mm 1f-d10mm 1f-d19mm</p> <p>KIT DE REPARAÇÃO ALAVANCA DE VELOCIDADES</p> <p>BMW Z4 Roadster (E85) 2.0 i (De 03.2005 Até 02.2009) 110kW 150cv 1995cm3 Cabriolet - BMW Z4 Roadster (E85) 2.2 i (De 10.2003 Até 10.2005) 125kW 170cv 2171cm3 Cabriolet - BMW Z4 Roadster (E85) 2.5 i (De 12.2002 Até 12.2005) 141kW 192cv 2494cm3 Cabriolet - BMW Z4 Roadster (E85) 2.5 i (De 09.2005 Até 02.2009) 130kW 177cv 2497cm3 Cabriolet - BMW Z4 Roadster (E85) 2.5 si (De 01.2006 Até 08.2008) 160kW ...</p> <p>d37x18mm d19x25mm d17x22mm d31x21mm d31x20mm d12x19mm</p>
	<p><b>KUR21999</b> NO. 1f-d24mm 1f-d10mm 1f-d10mm 1f-d19mm</p> <p>KIT DE REPARAÇÃO ALAVANCA DE VELOCIDADES</p> <p>BMW Z4 Roadster (E89) sDrive 18 i (De 04.2013 Até 08.2016) 115kW 156cv 1997cm3 Cabriolet - BMW Z4 Roadster (E89) sDrive 20 i (De 09.2011 Até 08.2016) 135kW 184cv 1997cm3 Cabriolet - BMW Z4 Roadster (E89) sDrive 23 i (De 03.2009 Até 08.2011) 150kW 204cv 2497cm3 Cabriolet - BMW Z4 Roadster (E89) sDrive 28 i (De 09.2011 Até 08.2016) 180kW 245cv 1997cm3 Cabriolet - BMW Z4 Roadster (E89) sDrive 30 i (D...</p> <p>d37x18mm d19x25mm d17x22mm d31x21mm d31x20mm d12x19mm</p>		<p><b>P1042</b> NO. 35211160422</p> <p>CAPA DE PEDAL</p> <p>BMW Z4 Roadster (E85) M 01.2006/08.2008 252KW 343CV 3246CC S54 B32 (326S4) 7909AAA</p> <p>.75x65x40mm</p>
	<p><b>P1042</b> NO. 35211160422</p> <p>CAPA DE PEDAL</p> <p>BMW Z4 Coupé (E86) 3.0 si 04.2006/08.2008 195KW 265CV 2996CC N52 B30 A N52 B30 BF 0005AAF - BMW Z4 Coupé (E86) M 04.2006/08.2008 252KW 343CV 3246CC S54 B32 (326S4) 7909AAB</p> <p>75x65x40mm</p>		<p><b>P1042</b> NO. 35211160422</p> <p>CAPA DE PEDAL</p> <p>BMW Z4 Roadster (E89) sDrive 20 i 09.2011/08.2016 135KW 184CV 1997CC N20 B20 A 0005BGX - BMW Z4 Roadster (E89) sDrive 23 i 03.2009/08.2011 150KW 204CV 2497CC N52 B25 A N52 B25 BF 0005AYL 0005AOL - BMW Z4 Roadster (E89) sDrive 28 i 09.2011/08.2016 180KW 245CV 1997CC N20 B20 A 0005BGY - BMW Z4 Roadster (E89) sDrive 30 i 02.2009/08.2011 190KW 258CV 2996CC N52 B30 A N52 B30 B N52 B30 BF 0005AYM 0005AO...</p> <p>75x65x40mm</p>
	<p><b>P1055</b> NO. 35211160421</p> <p>CAPA DE PEDAL DO TRAVÃO (VEÍCULOS COM CAIXA AUTOMÁTICA)</p> <p>BMW Z4 Roadster (E85) 2.2 i 10.2003/10.2005 125KW 170CV 2171CC M54 B22 (226S1) 0005790 - BMW Z4 Roadster (E85) 2.5 i 12.2002/12.2005 141KW 192CV 2494CC M54 B25 (256S5) 0005758 - BMW Z4 Roadster (E85) 3.0 i 12.2002/12.2005 170KW 231CV 2979CC M54 B30 (306S3) 0005757</p> <p>74x107x42mm</p>		<p><b>R080024</b> NO. 48-56-36-225-27-41-19mm 1f-d6mm 1f</p> <p>TUBO RIGIDO DE REFRIGERAÇÃO</p> <p>BMW Z4 Roadster (E85) 2.2 i 10.2003/10.2005 125KW 170CV 2171CC M54 B22 (226S1) 0005790 - BMW Z4 Roadster (E85) 2.5 i 12.2002/12.2005 141KW 192CV 2494CC M54 B25 (256S5) 0005758 - BMW Z4 Roadster (E85) 3.0 i 12.2002/12.2005 170KW 231CV 2979CC M54 B30 (306S3) 0005757</p> <p>B475-14/17mm 48-56-36-225-27-41-19mm 1f-d6mm 1f-d9mm...</p>

	<b>S1635</b> NO. 33306852895 - 33321138722 - 33321140345 - 33326775551 <b>SILENT-BLOC DO BRAÇO SUSPENSÃO DA FRENTE</b> BMW Z4 Roadster (E85) 2.0 i 03.2005/02.2009 110KW 150CV 1995CC N46 B20 B 0005819 0005AAT - BMW Z4 Roadster (E85) 2.2 i 10.2003Z/10.2005 125KW 170CV 2171CC M54 B22 (226S1) 0005790 - BMW Z4 Roadster (E85) 2.5 i 12.2002/12.2005 141KW 192CV 2494CC M54 B25 (256S5) 0005758 - BMW Z4 Roadster (E85) 2.5 i 09.2005/02.2009 130KW 177CV 2497CC N52 B25 A 0005AAB - BMW Z4 Roadster (E85) 2.5 si 09.2005/02.2009 15... d45x57mm c47mm 1f-d12mm		<b>S1635</b> NO. 33306852895 - 33321138722 - 33321140345 - 33326775551 <b>SILENT-BLOC DO BRAÇO SUSPENSÃO DA FRENTE</b> BMW Z4 Roadster (E89) sDrive 18 i 04.2013/08.2016 115KW 156CV 1997CC N20 B20 A 0005BPN - BMW Z4 Roadster (E89) sDrive 20 i 09.2011/08.2016 120KW 163CV 1997CC N20 B20 A 0005BGW - BMW Z4 Roadster (E89) sDrive 20 i 09.2011/08.2016 120KW 163CV 1997CC N20 B20 A 0005BGW - BMW Z4 Roadster (E89) sDrive 20 i 09.2011/08.2016 135KW 184CV 1997CC N20 B20 A 0005BGX - BMW Z4 Roadster (E89) sDrive 23 i 03.2009/08.2011 150KW 204CV 2497CC N52 B25 A N52 B25 BF 0005AYL 0005AOL - BMW Z4 Roadster (E89) sDr... d45x57mm c47mm 1f-d12mm
	<b>S1875</b> NO. 33176760288 - 33176770866 <b>SILENT-BLOC DA CAIXA VELOCIDADES AUTOMÁTICA</b> BMW Z4 Coupé (E86) 3.0 si (De 04.2006 Até 08.2008) 195kW 265cv 2996cm3 Coupé - d69x57mm 1f-11x14mm		<b>S1875</b> NO. 33176760288 - 33176770866 <b>SILENT-BLOC DA CAIXA VELOCIDADES AUTOMÁTICA</b> BMW Z4 Roadster (E85) 2.0 i (De 03.2005 Até 02.2009) 110kW 150cv 1995cm3 Cabriolet - BMW Z4 Roadster (E85) 2.2 i (De 10.2003 Até 10.2005) 125kW 170cv 2171cm3 Cabriolet - BMW Z4 Roadster (E85) 2.5 i (De 12.2002 Até 12.2005) 141kW 192cv 2494cm3 Cabriolet BMW Z4 Roadster (E85) 2.5 i (De 09.2005 Até 02.2009) 130kW 177cv 2497cm3 Cabriolet BMW Z4 Roadster (E85) 2.5 si (De 01.2006 Até 08.2008) 160kW 218c... d69x57mm 1f-11x14mm
	<b>S1959</b> NO. 33321092247 - 33321137571 <b>SILENT-BLOC BRAÇO SUSPENSÃO TRÁS SUPERIOR PARTE INTERIOR</b> BMW Z4 Coupé (E86) 3.0 si (De 04.2006 Até 08.2008) 195kW 265cv 2996cm3 Coupé - BMW Z4 Coupé (E86) M (De 04.2006 Até 08.2008) 252kW 343cv 3246cm3 Coupé - BMW Z4 Coupé (E86) M (De 04.2006 Até 08.2008) 252kW 343cv 3246cm3 Coupé - d35x66mm c42mm 1f-d12mm		<b>S1959</b> NO. 33321092247 - 33321137571 <b>SILENT-BLOC BRAÇO SUSPENSÃO TRÁS SUPERIOR PARTE INTERIOR</b> BMW Z4 Roadster (E85) 2.0 i (De 03.2005 Até 02.2009) 110kW 150cv 1995cm3 Cabriolet - BMW Z4 Roadster (E85) 2.2 i (De 10.2003 Até 10.2005) 125kW 170cv 2171cm3 Cabriolet - BMW Z4 Roadster (E85) 2.5 i (De 12.2002 Até 12.2005) 141kW 192cv 2494cm3 Cabriolet - BMW Z4 Roadster (E85) 2.5 i (De 09.2005 Até 02.2009) 130kW 177cv 2497cm3 Cabriolet - BMW Z4 Roadster (E85) 2.5 si (De 01.2006 Até 08.2008) 160kW ... d35x66mm c42mm 1f-d12mm
	<b>S1959</b> NO. 33321092247 - 33321137571 <b>SILENT-BLOC BRAÇO SUSPENSÃO TRÁS SUPERIOR PARTE INTERIOR</b> BMW Z4 Roadster (E89) sDrive 18 i (De 04.2013 Até 08.2016) 115kW 156cv 1997cm3 Cabriolet - BMW Z4 Roadster (E89) sDrive 20 i (De 09.2011 Até 08.2016) 135kW 184cv 1997cm3 Cabriolet - BMW Z4 Roadster (E89) sDrive 23 i (De 03.2009 Até 08.2011) 150kW 204cv 2497cm3 Cabriolet - BMW Z4 Roadster (E89) sDrive 28 i (De 09.2011 Até 08.2016) 180kW 245cv 1997cm3 Cabriolet - BMW Z4 Roadster (E89) sDrive 30 i (D... d35x66mm c42mm 1f-d12mm		<b>UMB84038</b> NO. 07119937331 - 11111276473 - 11111714712 <b>TAMPÃO BLOCO MOTOR</b> BMW Z4 Roadster (E85) M (03.06 A 02.09) 343cv 3246cc Cabriolet - BMW Z4 Coupé (E86) M (03.06 A 01.09) 343cv 3246cc Coupé d-45x12,1mm di-42mm
	<b>UMV25106</b> NO. 25117503100 - 25117566267 <b>MANETE PUNHO TOPO ALAVANCA MUDANÇAS 5 VELOCIDADES F14MM</b> BMW Z4 Roadster (E85) 2.0 i 03.2005/02.2009 110KW 150CV 1995CC N46 B20 B 0005819 0005AAT 95x45x55mm 1f-d14mm		<b>UMV25107</b> NO. 25117550685 <b>MANETE PUNHO TOPO ALAVANCA MUDANÇAS 6 VELOCIDADES F14MM</b> BMW Z4 Coupé (E86) 3.0 si 04.2006/08.2008 195KW 265CV 2996CC N52 B30 A N52 B30 BF 0005AAF - BMW Z4 Coupé (E86) Z4 Roadster (E85) 2.5 i 09.2005/02.2009 130KW 177CV 2497CC N52 B25 A 0005AAB - BMW Z4 Coupé (E86) 2.5 si 01.2006/08.2008 160KW 218CV 2497CC N52 B25 A 0005AAC - BMW Z4 Coupé (E86) 3.0 i 12.2002/12.2005 170KW 231CV 2979CC M54 B30 (306S3) 0005757 - BMW Z4 Coupé (E86) 3.0 si 01.2006/08.2008 1... 95x45x54mm 1f-d14mm
	<b>UMV25110</b> NO. 25111434495 - 25117500299 - 25117503231 - 25117523817 - 25117544524 <b>MANETE PUNHO TOPO ALAVANCA MUDANÇAS 5 VELOCIDADES NAPEL F14MM</b> BMW Z4 Roadster (E85): 2.2 i 10.2003/10.2005 125KW 170CV 2171CC - BMW Z4 Roadster (E85): 2.5 i 12.2002/12.2005 141KW 192CV 2494CC d51x91mm 1f-d14mm		<b>UMV25111</b> NO. 25111434495 - 25117500299 - 25117503231 - 25117523817 - 25117544524 <b>MANETE PUNHO TOPO ALAVANCA MUDANÇAS 6 VELOCIDADES F14MM</b> BMW Z4 Roadster (E85): 2.2 i 10.2003/10.2005 125KW 170CV 2171CC - BMW Z4 Roadster (E85): 2.5 i 12.2002/12.2005 141KW 192CV 2494CC d46x91mm 1f-d14mm
	<b>UMV25114</b> NO. 25111434495 - 25117500299 - 25117503231 - 25117523817 - 25117544524 <b>MANETE PUNHO TOPO ALAVANCA MUDANÇAS 5 VELOCIDADES F14MM</b> BMW Z4 Roadster (E85): 2.2 i 10.2003/10.2005 125KW 170CV 2171CC - BMW Z4 Roadster (E85): 2.5 i 12.2002/12.2005 141KW 192CV 2494CC d56x94mm 1f-d14mm		<b>UMV25115</b> NO. 25117520201 <b>MANETE PUNHO TOPO ALAVANCA MUDANÇAS 6 VELOCIDADES F14MM</b> BMW Z4 Roadster (E85) 2.5 i (De 09.2005 Até 02.2009) 130KW 177cv 2497cm3 Cabriolet - d48x94mm 1f-d15mm
	<b>UMV25127</b> NO. 25112229442 - 25117566267 - 25117833136 - 25118037305 <b>MANETE PUNHO TOPO ALAVANCA MUDANÇAS 5 VELOCIDADES F14MM</b> BMW Z4 Roadster (E85) 2.0 i (De 03.2005 Até 02.2009) 110kW 150cv 1995cm3 Cabriolet - d46x94mm 1f-d14mm		<b>UMV25128</b> NO. 25117550685 <b>MANETE PUNHO TOPO ALAVANCA MUDANÇAS 6 VELOCIDADES F14MM</b> BMW Z4 Coupé (E86) 3.0 si 04.2006/08.2008 195KW 265CV 2996CC N52 B30 A N52 B30 BF 0005AAF - BMW Z4 Coupé (E86) Z4 Roadster (E85) 2.5 i 09.2005/02.2009 130KW 177CV 2497CC N52 B25 A 0005AAB - BMW Z4 Coupé (E86) 2.5 si 01.2006/08.2008 160KW 218CV 2497CC N52 B25 A 0005AAC - BMW Z4 Coupé (E86) 3.0 i 12.2002/12.2005 170KW 231CV 2979CC M54 B30 (306S3) 0005757 - BMW Z4 Coupé (E86) 3.0 si 01.2006/08.2008 1... 96x46x55mm 1f-d14mm

	<p><b>UMV26826</b> NO. 25111221290 - 25111222280 - 25111434494 - 25111434495</p> <p>MANETE PUNHO TOPO ALAVANCA MUDANÇAS 5 VELOCIDADES F12MM C/LUZ</p> <p>BMW Z4 Roadster (E85): 2.2 i 10.2003/10.2005 125KW 170CV 2171CC - BMW Z4 Roadster (E85): 2.5 i 12.2002/12.2005 141KW 192CV 2494CC</p> <p>54x45x91mm DIAMETRO INTERIOR 12MM</p>		<p><b>UTR0812</b> NO. 17110152374 - 17111468076 - 17111712492 - 17111712669 - 17111742231 - 17117639022 - 17119071581</p> <p>TAMPÃO RESERVATÓRIO LIQUIDO REFRIGERAÇÃO</p> <p>BMW Z4 Roadster 2.0 i (03.05 A 02.09) 150cv 1995cc Cabriolet - BMW Z4 Roadster 2.2 i (10.03 A 10.05) 170cv 2171cc Cabriolet - BMW Z4 Roadster 2.5 i (02.03 A 12.05) 192cv 2494cc Cabriolet - BMW Z4 Roadster 3.0 i (02.03 A 10.05) 231cv 2979cc Cabriolet</p> <p>d65x45mm 1f-d52x20mm</p>
	<p><b>Y3239</b> NO. 36130141574 - 36130141576 - 36131095390 - 36131116717 - 36131117190 - 36131126191</p> <p>PARAFUSO PERNO RODA CHAVE 17 M12X1,50X50MM ( BASE CONICA )</p> <p>BMW Z4 Roadster (E85) 2.0 i 03.2005/02.2009 110KW 150CV 1995CC N46 B20 B 0005819 0005AAT - BMW Z4 Roadster (E85) 2.2 i 10.2003/10.2005 125KW 170CV 2171CC M54 B22 (226S1) 0005790 - BMW Z4 Roadster (E85) 2.5 i 12.2002/12.2005 141KW 192CV 2494CC M54 B25 (256S5) 0005758 - BMW Z4 Roadster (E85) 3.0 i 12.2002/12.2005 170KW 231CV 2979CC M54 B30 (306S3) 0005757 - BMW Z8 Roadster (E52) 4.9 01.2000/12.2003 ...</p> <p>c51mm (ch-17mm) M12x1x24mm</p>		<p><b>Z55186</b> NO. 07147145753</p> <p>MOLA DE PAINEL</p> <p>BMW Z4 Coupé (E86) 3.0 si (04.2006 - 08.2008) 195kw 265cv 2996cm3 Coupé BMW Z4 Coupé (E86) M (04.2006 - 08.2008) 252kw 343cv 3246cm3 Coupé</p> <p>d8x 18mm f-d18mm</p>
	<p><b>Z80834</b> NO. 51321938884</p> <p>MOLA DE FIXAÇÃO</p> <p>BMW Z4 Roadster (E85): 2.0 i 03.2005/02.2009 110KW 150CV 1995CC - BMW Z4 Roadster (E85): 2.2 i 10.2003/10.2005 125KW 170CV 2171CC - BMW Z4 Roadster (E85): 2.5 i 12.2002/12.2005 141KW 192CV 2494CC - BMW Z4 Roadster (E85): 2.5 i 09.2005/02.2009 130KW 177CV 2497CC - BMW Z4 Roadster (E85): 2.5 si 01.2006/08.2008 160KW 218CV 2497CC - BMW Z4 Roadster (E85): 3.0 i 12.2002/12.2005 170KW 231CV 2979CC - BMW...</p> <p>37x29x12.2mm</p>		<p><b>Z80834</b> NO. 51321938884</p> <p>MOLA DE FIXAÇÃO</p> <p>BMW Z4 Coupé (E86): 3.0 si 04.2006/08.2008 195KW 265CV 2996CC - BMW Z4 Coupé (E86): M 04.2006/08.2008 252KW 343CV 3246CC</p> <p>37x29x12.2mm</p>

BMW Z8(E52)

	<p><b>P1042</b> NO. 35211160422</p> <p>CAPA DE PEDAL</p> <p>BMW Z8 Roadster (E52) 4.9 01.2000/12.2003 294KW 400CV 4941CC S62 B50 (508S1) 0005674</p> <p>75x65x40mm</p>		<p><b>P1055</b> NO. 35211160421</p> <p>CAPA DE PEDAL DO TRAVÃO(VEÍCULOS COM CAIXA AUTOMÁTICA)</p> <p>BMW Z8 Roadster (E52) 4.9 01.2000/12.2003 294KW 400CV 4941CC S62 B50 (508S1) 0005674</p> <p>74x107x42mm</p>
	<p><b>U7033K</b> NO. 61671378609 - 64500149356 - 64500301636 - 64501363572 - 64501468019 - 64501468463 - 64508390601</p> <p>ORINGS BOMBA DIREÇÃO ASSITIDA</p> <p>BMW Z8 Roadster (E52) 4.9 (01.2000 - 12.2003) 294kw 400cv 4941cm3 Cabriolet</p> <p>d11x2mm d10x2mm 1f-d7mm 1f-d6mm</p>		<p><b>UFQ23302</b> NO. 21511223302</p> <p>FORQUILHA DA EMBRAIAGEM</p> <p>BMW Z8 Roadster (E52) 4.9 01.2000/12.2003 294KW 400CV 4941CC S62 B50 (508S1) 0005674</p> <p>252x83x28mm 1f-47x75mm</p>
	<p><b>UTR0812</b> NO. 17110152374 - 17111468076 - 17111712492 - 17111712669 - 17111742231 - 17117639022 - 17119071581</p> <p>TAMPÃO RESERVATÓRIO LIQUIDO REFRIGERAÇÃO</p> <p>BMW Z8 Roadster 4.9 (06.00 A 06.03) 400cv 4941cc Cabriolet</p> <p>d65x45mm 1f-d52x20mm</p>		<p><b>Z80849</b> NO. 51411973500 - 51418161527 - 99950758240</p> <p>Mola de painel</p> <p>BMW Z8</p> <p>d18x21mm 1p-d9-13mm</p>