



	E0197	60625029		E0198	60613575
	ESTICADOR DA BARRA ESTABILIZADORA DA FRENTE ALFA ROMEO 145 1.8 ie 16v - 2.0 16v QUADRIFÓGLIO (03-1998 A 01-2001) - 146 1.8 ie 16v TS - 2.0 16V QUADRIFÓGLIO (03-1998 A 01-2001)			ESTICADOR DA BARRA ESTABILIZADORA DE TRÁS ALFA ROMEO 145 1.8 ie 16v (03-1998 A 01-2001) - 2.0 16V QUADRIFÓGLIO (03-1998 A 01-2001) - 1.8 ie 16V (03-1998 A 01-2001) - 2.0 16V QUADRIFÓGLIO (03-1998 A 01-2001)	
	155x36x39mm	2p-d10-21mm		215x42x42mm	2p-d10-22mm
	E1152-C	60570627 - 60809242			
	ESTICADOR DA BARRA ESTABILIZADORA DA FRENTE ALFA ROMEO 145 - 146 TT - 145 - 146 GAMMA 97 TT				
	120x35x32mm	1f-d12mm			



ALFA ROMEO 147

	E0197	60625029		E0198	60613575
	ESTICADOR DA BARRA ESTABILIZADORA DA FRENTE ALFA ROMEO 147 1.6 16V T.SPARK (APÓS 01-2001) - 1.9 JTD (APÓS 06-2001) - 1.9 JTD 16V (APÓS 11-2002) - 2.0 16V T.SPARK (APÓS 01-2001)			ESTICADOR DA BARRA ESTABILIZADORA DA FRENTE ALFA ROMEO 147 1.6 16V T.SPARK (APÓS 01-2001) - 1.9 JTD (APÓS 04-2001) - 1.9 JTD 16V (APÓS 11-2002) - 2.0 16V T.SPARK (APÓS 01-2001)	
	155x36x39mm	2p-d10-21mm		215x42x42mm	2p-d10-22mm



ALFA ROMEO 155

	E1152-C	60570627 - 60809242			
	ESTICADOR DA BARRA ESTABILIZADORA DA FRENTE ALFA ROMEO 155 TT				
	120x35x32mm	1f-d12mm			







ALFA ROMEO 156

	E0197	60625029		E0198	60613575
	ESTICADOR DA BARRA ESTABILIZADORA DA FRENTE ALFA ROMEO 156 1.6 16V T.SPARK (09-1997 A 05-2006) - 1.8 16V T.SPARK (10-2000 A 09-2005) - 1.9 JTD (09-1997 A 09-2005) - 2.0 16V T.SPARK (09-1997 A 10-2000) - 2.0 JTS (03-2002 A 05-2006) - 2.4 JTD (09-1997 A 10-2000) - 2.5 V6 24V (09-1997 A 10-2000)			ESTICADOR DA BARRA ESTABILIZADORA DE TRÁS ALFA ROMEO 156 1.6 16V T.SPARK (09-1997 A 05-2006) - 1.8 16V T.SPARK (10-2000 A 09-2005) - 1.9 JTD (09-1997 A 09-2005) - 2.0 16V T.SPARK (09-1997 A 10-2000) - 2.0 JTS (03-2002 A 05-2006) - 2.4 JTD (09-1997 A 10-2000) - 2.5 V6 24V (09-1997 A 10-2000)	
	155x36x39mm	2p-d10-21mm		215x42x42mm	2p-d10-22mm

ALFA ROMEO 156





	E0199	60628284		E0228	60630757
	ESTICADOR DA BARRA ESTABILIZADORA DE TRÁS LADO ESQUERDO ALFA ROMEO 156 2.4 JTD (10-2000 A 09-2005) - 2.4 JTD SPORTWAGON (10-2000 A 09-2005)			ESTICADOR DA BARRA ESTABILIZADORA DA FRENTE ALFA ROMEO 156 2.4 JTD (10-2000 A 09-2005) - 2.4 JTD SPORTWAGON (10-2000 A 09-2005)	
	125x36x39mm	2p-d10-24mm		180x36x39mm	2p-d10-25mm
	E0229	60628255			
	ESTICADOR DA BARRA ESTABILIZADORA DE TRÁS LADO DIREITO ALFA ROMEO 156 2.4 JTD (10-2000 A 09-2005) - 2.4 JTD SPORTWAGON (10-2000 A 09-2005)				
	126x36x38mm	2p-d10-25mm			

ALFA ROMEO 159



	E0164	50704362		E0165	51795704
	ESTICADOR DA BARRA ESTABILIZADORA DA FRENTE LADO DIREITO ALFA ROMEO 159 TT (APÓS 09-2005)			ESTICADOR DA BARRA ESTABILIZADORA DE TRÁS LADO DIREITO ALFA ROMEO 159 TT (APÓS 09-2005)	
	135x35x35mm	2p-d12-31mm		150x35x35mm	2p-d12-31mm
	E0166	50704361		E0167	50705702
	ESTICADOR DA BARRA ESTABILIZADORA DA FRENTE LADO ESQUERDO ALFA ROMEO 159 TT (APÓS 09-2005)			ESTICADOR DA BARRA ESTABILIZADORA DE TRÁS LADO ESQUERDO ALFA ROMEO 159 TT (APÓS 09-2005)	
	135x35x37mm	2p-d12-30mm		150x35x35mm	2p-d12-31mm
	E0197	60625029		E0198	60613575
	ESTICADOR DA BARRA ESTABILIZADORA DA FRENTE ALFA ROMEO 159 1.9 JTDM 8V (APÓS 09-2005)			ESTICADOR DA BARRA ESTABILIZADORA DE TRÁS ALFA ROMEO 159 1.9 JTDM 8V (APÓS 09-2005)	
	155x36x39mm	2p-d10-21mm		215x42x42mm	2p-d10-22mm

ALFA ROMEO 164



	E0196	60561654 - 60570365			
	ESTICADOR DA BARRA ESTABILIZADORA DA FRENTE ALFA ROMEO 164 2.0 TS (06-1987 A 09-1992) - 3.0 V6(06-1987 A 09-1992) - 2.5 TD (06-1987 A 09-1992)				
	125x34x24mm	1f-d12mm			

	E0199	60628284		E0228	60630757
	ESTICADOR DA BARRA ESTABILIZADORA DE TRÁS LADO ESQUERDO ALFA ROMEO 166 2.0 T.SPARK (09-1998 A 10-2000) - 2.0 V6 (APÓS 09-1998) - 2.4 JTD (09-1998 A 09-2005) - 2.5 V6 24V(09-1998 A 10-2000) - 3.0 V6 24V (09-1998 A 10-2000)			ESTICADOR DA BARRA ESTABILIZADORA DA FRENTE ALFA ROMEO 166 2.0 T.SPARK (09-1998 A 10-2000) - 2.0 V6 (APÓS 09-1998) - 2.4 JTD (09-1998 A 09-2005) - 2.5 V6 24V(09-1998 A 10-2000) - 3.0 V6 24V (09-1998 A 10-2000)	
	125x36x39mm	2p-d10-24mm		180x36x39mm	2p-d10-25mm
	E0229	60628255		E0230	60628295
	ESTICADOR DA BARRA ESTABILIZADORA DE TRÁS LADO DIREITO ALFA ROMEO 166 2.0 T.SPARK (09-1998 A 10-2000) - 2.0 V6 (APÓS 09-1998) - 2.4 JTD (09-1998 A 09-2005) - 2.5 V6 24V(09-1998 A 10-2000) - 3.0 V6 24V (09-1998 A 10-2000)			ESTICADOR DA BARRA ESTABILIZADORA DE TRÁS LADO DIREITO ALFA ROMEO 166 2.0 T.SPARK (09-1998 A 10-2000) - 2.0 V6 (APÓS 09-1998) - 2.4 JTD (09-1998 A 09-2005) - 2.5 V6 24V(09-1998 A 10-2000) - 3.0 V6 24V (09-1998 A 10-2000) - 3.2 V6 24V (APÓS 10-2003)	
	126x36x38mm	2p-d10-25mm		225x42x34mm	2f-d14mm
	E0231	60628294			
	ESTICADOR DA BARRA ESTABILIZADORA DE TRÁS LADO ESQUERDO ALFA ROMEO 2.0 T.SPARK (09-1998 A 10-2000) - 2.0 V6 (APÓS 1998) - 2.4 JTD (09-1998 A 10-2000) - 2.5 V6 24V (09-1998 A 10-2000) - 3.0 V6 24V (09-1998 A 10-2000) - 3.2 V6 24V (APÓS 10-2003)				
	225x42x34mm	2f-d14mm			

ALFA ROMEO SPIDER - GTV - GT

	E0197	60625029		E0198	60613575
	ESTICADOR DA BARRA ESTABILIZADORA DA FRENTE ALFA ROMEO GT 1.8 TS (APÓS 11-2003) - GTV 1.8 16V (APÓS 05-1998) - SPIDER 1.8 16V (05-1998 A 04-2005)			ESTICADOR DA BARRA ESTABILIZADORA DE TRÁS ALFA ROMEO GT 1.8 TS (APÓS 11-2003) - GTV 1.8 16V (APÓS 05-1998) - SPIDER 1.8 16V (05-1998 A 04-2005)	
	155x36x39mm	2p-d10-21mm		215x42x42mm	2p-d10-22mm







AUDI 80 - 90 - 100

	E0090	8A0505466C - 8D0505466		E0091	8A0505465C - 8D0505465
	ESTICADOR DA BARRA ESTABILIZADORA DE TRÁS LADO DIREITO AUDI 80 - 90 TT (QUATTRO) - A4 TT (QUATTRO) DE 1997 A 2001			ESTICADOR DA BARRA ESTABILIZADORA DE TRÁS LADO ESQUERDO AUDI 80 - 90 TT (QUATTRO)	
	265x36x36mm	1p-d10-28mm		265x35x35mm	1p-d10-28mm 1f-d10mm
	T1029	823411313A			
	BATENTE DA BARRA ESTABILIZADORA (CENTRO) AUDI 80 (1973 A 1990)				
	42x39x24mm	1f-d12mm			

AUDI A2

	E0092	6Q0411315C - 6Q0411315F		
	ESTICADOR DA BARRA ESTABILIZADORA DA FRENTE AUDI A2 1.4 16V (Mtr.-Eng AUA - BBY 55KW) - A2 1.4 TDI (Mtr.-Eng. AMF 55KW) - A2 1.6 FSI (Mts.-Eng BAD) APÓS 2000			
	310x36x36mm	2p-d10-23mm		

AUDI A3 - S3

	E0093	1J0411315G		E0094	1J0411315C
	ESTICADOR DA BARRA ESTABILIZADORA DA FRENTE AUDI A3 TT APÓS 1996			ESTICADOR DA BARRA ESTABILIZADORA DA FRENTE AUDI A3 TT APÓS 1996	
	140x35x35mm	1p-d10-25mm 1f-d10mm		145x37x37mm	1p-d10-25mm 1f-d10mm
	E0095	1J0411316D		E0096	1J0411315D
	ESTICADOR DA BARRA ESTABILIZADORA DA FRENTE LADO DIREITO AUDI A3 TT APÓS 1996			ESTICADOR DA BARRA ESTABILIZADORA DA FRENTE LADO ESQUERDO AUDI A3 TT (QUATTRO) APÓS 1996	
	370x40x40mm	2p-d12d35mm		370x40x40mm	1p-d12-35mm
	E0168	1K0505465K		E0169	1K0411315D
	ESTICADOR DA BARRA ESTABILIZADORA DE TRÁS AUDI A3 (MOD. 2003) TT			ESTICADOR DA BARRA ESTABILIZADORA DA FRENTE AUDI A3 (MOD. 2003) TT	
	130x33x35mm	1p-d10-35mm 1f-d10mm		365x35x35mm	2p-d12-26mm
	T1094	1J0411314C			
	BATENTE DA BARRA ESTABILIZADORA DA FRENTE AUDI A3(8L1) 1.6 - 1.8 - 1.8T - 1.8 T QUATTRO - 1.9 Tdi - 1.9 Tdi QUATTRO APÓS 09-96				
	37x36x25mm	1f-d20mm			

AUDI A4

	E0091	8A0505465C - 8D0505465		E0097	4D0411317K
	ESTICADOR DA BARRA ESTABILIZADORA DE TRÁS LADO ESQUERDO AUDI A4 TT (QUATTRO) DE 1997 A 2001			ESTICADOR DA BARRA ESTABILIZADORA DA FRENTE AUDI A4 TT DE 1995 A 1997	
	265x35x35mm	1p-d10-28mm 1f-d10mm		70x30x32mm	2f-d11mm

	E0098	8D0411318D		E0099	8D0411317D
	ESTICADOR DA BARRA ESTABILIZADORA DA FRENTE AUDI A4 TT DE 1997 A 2001			ESTICADOR DA BARRA ESTABILIZADORA DA FRENTE AUDI A4 TT DE 1997 A 2001	
	125x70x37mm	2f-d10mm		130x75x38mm	2f-d10mm
	E0183	8E0411318		E0232	8E0411317
	ESTICADOR DA BARRA ESTABILIZADORA DA FRENTE LADO DIREITO AUDI A4 (MOD.2001) TT (ATÉ 12-2004) - AUDI A4 (MOD.2004) TT (APÓS 11-2004)			ESTICADOR DA BARRA ESTABILIZADORA DA FRENTE LADO ESQUERDO AUDI A4 1.6(11-2000 A 12-2004) - 1.8 T(11-2000 A 12-2004) - 1.8 QUATTRO (09-2001 A 12-2004) - 1.9 Tdi (11-2000 A 12-2004) - 2.0(11-2000 A 12-2005) - 2.0 FSi (07-2002 A 12-2004) - 2.0 TFSi (ATÉ 06-2005) - 2.0 TFSi QUATTRO (ATÉ 11-2004) - 2.4 (9-2001 A 12-2005) - 2.5 TDi (07-2002 A 05-	
	125x70x35mm	1r-d10mm 1f-d11mm		128x64x38mm	1f-d11mm 1f-M10mm

AUDI A6

	E0090	8A0505466C - 8D0505466		E0091	8A0505465C - 8D0505465
	ESTICADOR DA BARRA ESTABILIZADORA DE TRÁS LADO DIREITO AUDI A6 (MOD.97) TT (QUATTRO)			ESTICADOR DA BARRA ESTABILIZADORA DE TRÁS LADO ESQUERDO AUDI A6 (MOD.97) TT (QUATTRO)	
	265x36x36mm	1p-d10-28mm		265x35x35mm	1p-d10-28mm 1f-d10mm
	E0098	8D0411318D		E0099	8D0411317D
	ESTICADOR DA BARRA ESTABILIZADORA DA FRENTE AUDI A6 (MOD.97) TT APÓS 1997			ESTICADOR DA BARRA ESTABILIZADORA DA FRENTE AUDI A6 (MOD.97) TT (APÓS 1997)	
	125x70x37mm	2f-d10mm		130x75x38mm	2f-d10mm

BEDFORD BRAVA - CAMPO

	T1033	8-94459-459-1		
	BATENTE DA BARRA ESTABILIZADORA (CENTRO) BEDFORD BRAVA			
	42x38x38mm	1f-d25mm		

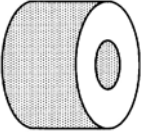
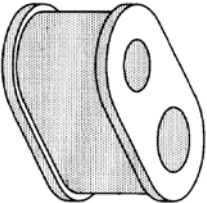
	T0019	8-94223-6990		T0023	8-94223-1570
	BATEANTE DA BARRA ESTABILIZADORA (PONTAS) BEDFORD KBD 25 - 26 - 27 - 47 - BRAVA			BATEANTE DA BARRA ESTABILIZADORA (CENTRO) BEDFORD KBD 25 - 26 - 27 - 47 - BRAVA	
	d38x21mm	1f-d14mm		73x40x35mm	1f-d21mm 1f-d15mm

BEDFORD SETA





	T0044				
	BATEANTE DA BARRA ESTABILIZADORA BEDFORD SETTA				
	41x35x32mm	1f-16mm			

BMW SÉRIE 3(E30)

	E0123	31351091764		E0172	33551126932
	ESTICADOR DA BARRA ESTABILIZADORA DA FRENTE BMW SERIE 3 (E30) TT			ESTICADOR DA BARRA ESTABILIZADORA DE TRÁS BMW SERIE 3 (E30) TT, SERIE 3 (E36) TT (-COMPACT)	
	105x42x29mm	1p-d10x22mm 1f-d8mm		132x32x26mm	2f-d8mm

BMW SÉRIE 3(E36)

	E0083	33551135307		E0123	31351091764
	ESTICADOR DA BARRA ESTABILIZADORA SUSPENSÃO DE TRÁS BMW S3 E36-Z3 COMPACT (DE 1991 ATÉ 1998)			ESTICADOR DA BARRA ESTABILIZADORA DA FRENTE BMW SERIE 3 (E36)	
	93x34x26mm	2f-d8mm		105x42x29mm	1p-d10x22mm 1f-d8mm

	E0122	33551094619		E0124	31351095694
	ESTICADOR DA BARRA ESTABILIZADORA DE TRÁS BMW SERIE 3 E46 TT			ESTICADOR DA BARRA ESTABILIZADORA DA FRENTE BMW SERIE 3 E46 TT	
	125x31x28mm	1f-d8mm		310x36x36mm	2p-d10-23mm
	E0171	31356751080		E0173	31356751079
	ESTICADOR DA BARRA ESTABILIZADORA DE TRÁS LADO DIREITO BMW SERIE 3 (E46) 325 Xi, 330 Xi, 330 XD (APÓS 02/2005)			ESTICADOR DA BARRA ESTABILIZADORA DA FRENTE LADO ESQUERDO BMW SERIE 3 (E46) 325 Xi, 330 Xi, 330 XD (APÓS 02/2005)	
	345x35x35mm	2p-d10-21mm		340x35x35mm	2p-d10-20mm
	E0174	33552282182			
	ESTICADOR DA BARRA ESTABILIZADORA DE TRÁS BMW SERIE 3 (E46) M3 3.2 CABRIOLET / COUPÉ, BMW Z4 2.2, 2.5, 3.0				
	120x31x23mm	1f-d8mm 1f-d7mm			

BMW SÉRIE 5(E28)



	E0125	31351134582		
	ESTICADOR DA BARRA ESTABILIZADORA DA FRENTE BMW SERIE 5 (E28) TT - SERIE 5 (E34) TT			
	280x36x36mm	2p-d10-20mm		

BMW SÉRIE 5(E39)

	E0126	31351091856 - 31351095662		E0127	31351091855 - 31351095661
	ESTICADOR DA BARRA ESTABILIZADORA DA FRENTE LADO DIREITO BMW SERIE 5 (E39) TT			ESTICADOR DA BARRA ESTABILIZADORA DA FRENTE LADO ESQUERDO BMW SERIE 5 (E39) TT	
	280x40x40mm	2p-d10-30mm		275x36x36mm	2p-d10-30mm

CITROËN AX - AXEL

Rafpi, Lda.

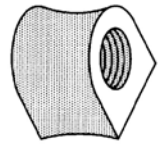
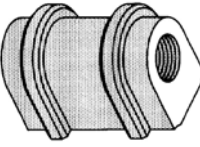

	BB04	5097.27		BB10	95632726
	ABRAÇADEIRA DA BARRA ESTABILIZADORA CITROËN AX			ABRAÇADEIRA DA BARRA ESTABILIZADORA CITROËN AX	
	73x53x28mm	2p-d10-25mm		65x38x30mm	2f-d10mm
	BB11	509734		T0029	96064489 - 96054483
	ABRAÇADEIRA DA BARRA ESTABILIZADORA CITROËN AX 1.4 (1986 ATÉ 1997)			BATENTE DA BARRA ESTABILIZADORA (PONTAS) CITROËN AX 1.4 (DE 1986 ATÉ 1997)	
	85x50x43mm			34x31x25mm	1f-d19mm
	T0030	96054481			
	BATENTE DA BARRA ESTABILIZADORA (CENTRO) CITROËN AX 1.4 (DE 1986 ATÉ 1997)				
	57x41x41mm	1f-d18mm			

CITROËN BERLINGO

	E0143	508734		
	ESTICADOR DA BARRA ESTABILIZADORA DA FRENTE CITROËN BERLINGO TT, XSARA TT, CITROËN ZX TT			
	330x35x35mm	2p-d10-25mm		

CITROËN C1

	E0160			
	ESTICADOR DA BARRA ESTABILIZADORA DA FRENTE CITROËN C1 TT (APÓS 06/2005)			
	100x33x31mm	2p-d8mm		

	KB2067			T0053-P	5094.37 - 91516332
	KIT DA BARRA ESTABILIZADORA (DIÂMETRO 23) CITROËN C15			BATENTE DA BARRA ESTABILIZADORA DA SUSPENSÃO FRENTE FURO 22mm (VERDE) CITROËN C15	
	T0054-P	5094.40 - 91539592		55x38x32mm	1f-d20mm
	BATENTE DA BARRA ESTABILIZADORA DA SUSPENSÃO FRENTE FURO 23mm (AZUL) CITROËN C15				
55x38x32mm		1f-23mm			

CITROËN C2

	E0142	508745			
	ESTICADOR DA BARRA ESTABILIZADORA DA FRENTE CITROËN C2 TT, CITROËN C3 TT				
370x40x40mm		2p-d10-25mm			

CITROËN C5

	E0130	508748			
	ESTICADOR DA BARRA ESTABILIZADORA DA FRENTE CITROËN C5 TT				
355x34x34mm		2p-d12-30mm			

CITROËN EVASION

	E0144	508735			
	ESTICADOR DA BARRA ESTABILIZADORA DA FRENTE CITROËN EVASION TT, JUMPY TT				
120x40x40mm		1p-d12-25mm 1f-d12mm			

CITROËN JUMPER

Rafri, Lda.



	E0089	508737		E0089-C	508737
	ESTICADOR DA BARRA ESTABILIZADORA DA FRENTE CITROËN JUMPER TT (DIESEL) - JUMPER (MOD.2002) 2.0 - JUMPER (MOD. 2002) 2.8 Hdi			ESTICADOR DA BARRA ESTABILIZADORA DA FRENTE CITROËN JUMPER TT (DIESEL) , JUMPER (MOD. 2002) 2.0, 2.8 HDi	
	155x42x35mm	1f-d14mm		155x35x43mm	1f-d14mm 1p-d12-23mm

CITROËN SAXO

	E0131	508740		T0030	96054481
	ESTICADOR DA BARRA ESTABILIZADORA DA FRENTE CITROËN SAXO TT (APÓS 1996) (APÓS CH:08150)			BATENTE DA BARRA ESTABILIZADORA (CENTRO) CITROËN SAXO 1.4 - 1.4VTS - 1.5 (DE 1998 ATÉ 2003)	
	340x40x40mm	2p-d12-35mm		57x41x41mm	1f-d18mm

CITROËN VISA - CITROËN LN - LNA

	BB12			E0145	508732
	ABRAÇADEIRA DA BARRA ESTABILIZADORA CITROËN VISA			ESTICADOR DA BARRA ESTABILIZADORA DA FRENTE CITROËN VISA 1.6 GTI	
	79x52x40mm			350x45x40mm	1p-d10-30mm 1p-d10-24mm
	KB2069			L1008	91500679
	KIT DA BARRA ESTABILIZADORA CITROËN VISA			CASQUILO DA BARRA ESTABILIZADORA CITROËN VISA	
				d21x14mm	1f-d8mm
	T1008	91500679			
	BATENTE DE ESTABILIZADOR CITROËN VISA 0.6 MOTOR V06/665				
	43x38x43mm	1f-d-22mm			

	E0131	508740		E0132	96145457
	ESTICADOR DA BARRA ESTABILIZADORA DA FRENTE CITROËN XANTIA TT (APÓS 1996) (APÓS CH:08150)			ESTICADOR DA BARRA ESTABILIZADORA DA FRENTE CITROËN XANTIA TT (APÓS 1993) (APÓS CH:06614)	
	340x40x40mm	2p-d12-35mm		345x40x40mm	2p-d10-25mm

CITROËN ZX

	BB09	96029014		T1013	509465
	ABRACADEIRA DA BARRA ESTABILIZADORA CITROËN ZX			BATENTE DA BARRA ESTABILIZADORA CITROËN ZX	
	107x50x45mm			50x46x43mm	1f-d21mm
	T1014	96051398			
	BATENTE DA BARRA ESTABILIZADORA CITROËN ZX 1.1 - 1.4i - 1.6i - 1.9D - 1.9TD - 2.0i - 2.0i 16V				
	50x46x45mm	1f-d22mm			

FIAT 124 - 125 - 126 - 127 - 128

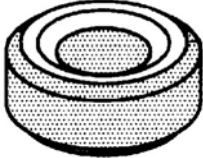
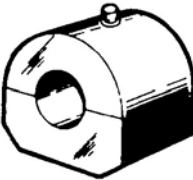
	L1011	4240587 - 4207922		T0002	4233062
	CASQUILHO DO BRAÇO DA SUSPENSÃO (PONTAS DA BARRA ESTABILIZADORA) FIAT 127 - 128 TT			BATENTE CENTRAL DA BARRA ESTABILIZADORA DA SUSPENSÃO FRENTE FIAT 127 TT	
	d34x21mm	1f-d16mm		43x40x32mm	1f-d19mm

FIAT 500 - 600 - 850 - 1100

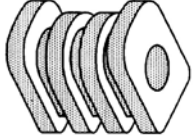
	E0176	50700941		T0009	4132370 - 4101897
	ESTICADOR DA BARRA ESTABILIZADORA DA FRENTE FIAT 500 (MOD.2007) TT			BATENTE CENTRAL DA BARRA ESTABILIZADORA DA SUSPENSÃO FRENTE E TRÁS (SÓ FRENTE NO 850 SPORT) FIAT 850 - 850 S - 850 SPORT	
	320x35x35mm	2p-d10-25mm		40x40x30mm	1f-d14mm

FIAT BRAVA - BRAVO - MAREA



Rapi, Lda.

	E0176	50700941		E1152-C	60809242 - 7601647
	ESTICADOR DA BARRA ESTABILIZADORA DA FRENTE FIAT BRAVO (MOD.2007) TT			ESTICADOR DA BARRA ESTABILIZADORA DA FRENTE FIAT BRAVA - BRAVO TT	
	320x35x35mm	2p-d10-25mm		120x35x32mm	1f-d12mm



FIAT COUPE - BARCHETTA

	E1152-C	60809242 - 7601647		
	ESTICADOR DA BARRA ESTABILIZADORA DA FRENTE FIAT COUPÉ TT			
	120x35x32mm	1f-d12mm		

FIAT DOBLO - SCUDO

	E0144	1317425080 - 1308664080		E0177	46799278
	ESTICADOR DA BARRA ESTABILIZADORA DA FRENTE FIAT SCUDO TT, ULYSSE TT			ESTICADOR DA BARRA ESTABILIZADORA DE TRÁS FIAT DOBLO (2000-2005) TT - DOBLO RESTYLING (2005) TT	
	120x40x40mm	1p-d12-25mm 1f-d12mm		145x25x30mm	2p-d10-21mm
	T1095	7750990			
	BATENTE DA BARRA ESTABILIZADORA DA FRENTE FIAT DOBLO APÓS 2000 1.2 - 1.6(16V) - 1.9D - 1.9 JTD				
	87x31x34mm				

FIAT DUCATO - TALENTO - ULYSSE - 242 - 238

	E0089	1300716080		E0089-C	1300716080
	ESTICADOR DA BARRA ESTABILIZADORA DA FRENTE FIAT DUCATO (MOD.2002) 2.0 Mpi - DUCATO (MOD.2002) 2.8 JTD - DUCATO (MOD.94) TT (DIESEL)			ESTICADOR DA BARRA ESTABILIZADORA DA FRENTE FIAT DUCATO (MOD. 2002) 2.0 MPI, 2.8 JTD, DUCATO (MOD. 1994) TT (DIESEL)	
	155x42x35mm	1f-d14mm		155x35x43mm	1f-d14mm 1p-d12-23mm

	E0161	55700753		
	ESTICADOR DA BARRA ESTABILIZADORA DA FRENTE			
	FIAT GRANDE PUNTO TT (APÓS 10/2005)			
	335x35x35mm	2p-d10-24mm		

FIAT MIRAFIORI - FIAT 131

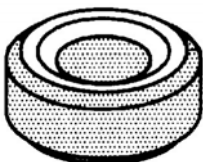
	L1011	4240587 - 4207922		
	CASQUILHO DO BRAÇO DA SUSPENSÃO (PONTAS DA BARRA ESTABILIZADORA)			
	FIAT 131 TT			
	d34x21mm	1f-d16mm		

FIAT PALIO - STRADA

	T1095	7750990		
	BATENTE DA BARRA ESTABILIZADORA DA FRENTE			
	FIAT COMERCIAL STRADA APÓS 06/2001 1.2 (8V) - 1.7 TD - 1.9D - 1.9 JTD			
	87x31x34mm			

FIAT PANDA - YOUNG

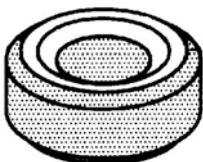
	L1011	4240587 - 4207922		
	CASQUILHO DO BRAÇO DA SUSPENSÃO (PONTAS DA BARRA ESTABILIZADORA)			
	FIAT PANDA			
	d34x21mm	1f-d16mm		

	T1095	7750990		
	BATEENTE DA BARRA ESTABILIZADORA DA FRENTE			
	FIAT PUNTO APÓS 1999 1.9D - 1.9 JTD - 60 (1.2 8V) - 80(1.2 16V) - 130(1.8 16V) - FIAT PUNTO APÓS 2003 1.2 (16V) - 1.2(8V) - 1.3 JTD MJ (70 CV) - 1.4(16V) - 1.8(16V) - 1.9 JTD (85CV) 1.9 JTD MJ (100CV)			
	87x31x34mm			

FIAT STILO - IDEA



	E0176	50700941		
	ESTICADOR DA BARRA ESTABILIZADORA DA FRENTE			
	FIAT STILO 1.2 - 1.6 - 1.8 16V - 2.4 20V - 1.9 JTD			
	320x35x35mm	2p-d10-25mm		

FIAT TEMPRA - REGATA

	E1152-C	60809242 - 7601647		E1152-I	7601647
	ESTICADOR DA BARRA ESTABILIZADORA DA FRENTE				
	FIAT TEMPRA TT				
	120x35x32mm	1f-d12mm		d36x31mm	1f-d12mm 1p-d10-80mm

FIAT TIPO - RITMO

	E1152-C	60809242 - 7601647		E1152-I	7601647
	ESTICADOR DA BARRA ESTABILIZADORA DA FRENTE				
	FIAT TIPO TT				
	120x35x32mm	1f-d12mm		d36x31mm	1f-d12mm 1p-d10-80mm
	L1011	4240587 - 4207922		T1026	7635711
	CASQUILHO DO BRAÇO DA SUSPENSÃO (PONTAS DA BARRA ESTABILIZADORA)				
	FIAT RITMO				
	d34x21mm	1f-d16mm		60x47x47mm	1f-d20mm

	T1062-I	7563151		T1156-I	7603476
	BATEENTE DE ESTABILIZADOR FIAT UNO DIESEL			BATEENTE DA BARRA ESTABILIZADORA FIAT UNO TT	
	36x35x30mm	1f-d17mm		65x35x35mm	1f-d18mm 2p-d8-22mm

FORD CAPRI - CONSUL - GRANADA

	L3043	1481463 - 715K498		L3043	1481463 - 715K498
	CASQUILHO DAS PONTAS DA BARRA ESTABILIZADORA FORD CONSUL			CASQUILHO DAS PONTAS DA BARRA ESTABILIZADORA FORD GRANADA	
	d28x42mm	1f-d10mm		d28x42mm	1f-d10mm

FORD CORTINA - TAUNUS - P100 PICK-UP











	L3015			L3041	6005983 - 743B197AA
	CASQUILHO DA BARRA ESTABILIZADORA FORD CORTINA			CASQUILHO DA BARRA ESTABILIZADORA FORD CORTINA - TAUNUS (DE 1976 A 1992)	
	d48x18mm	1f-d16mm		d50x17mm	1f-d20mm
	L3043	1481463 - 715K498		T0003	204460
	CASQUILHO DAS PONTAS DA BARRA ESTABILIZADORA FORD TAUNUS			BATEENTE DA BARRA ESTABILIZADORA FORD CORTINA - TAUNUS	
	d28x42mm	1f-d10mm		41x39x36mm	1f-d18mm

FORD COUGAR

	T1051	6714195		
	BATEENTE DO CENTRO DA BARRA ESTABILIZADORA (FURO DIÁMETRO 20mm) FORD COUGAR 2.0 16V - 2.5 V6 24V - 2.5 ST200 (DE 1998 A 2001)			
	43x39x30mm	1f-d20mm		

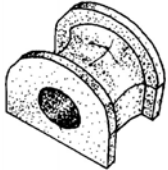

	E0100	1130273 - 1661237		L3004	5021661 - 6107025 - 1652910 - 81AB5K897BA
	ESTICADOR DA BARRA ESTABILIZADORA DA FRENTE FORD ESCORT V - VI TT DE 1990 ATÉ 1992 - ESCORT VI TT DE 1992 ATÉ 1995 - ESCORT VII TT APÓS 1995			CASQUILHO DA BARRA ESTABILIZADORA DA FRENTE FORD ESCORT 0.9 - 1.1 - 1.3 - ESCORT DIESEL 1.6 - 1.8 - ORION 1.3 - 1.4 - 1.6 - ORION DIESEL 1.6 - 1.8	
	275x34x34mm	2p-d10-20mm		d45x20mm	d42mm 1f-d16mm
	T0003	204460		T1050	7102392
	BATENTE DA BARRA ESTABILIZADORA FORD ESCORT			BATENTE DO CENTRO DA BARRA ESTABILIZADORA FORD ESCORT (APÓS 1990) - ORION (APÓS 1991)	
	41x39x36mm	1f-d18mm		39x35x30mm	1f-d15mm

FORD FIESTA - COURIER - FUSION - PUMA

	BB22	1003610		BB23	6788739
	ABRÇAQUEIRA DA BARRA ESTABILIZADORA FORD FIESTA (1996)			ABRÇAQUEIRA DA BARRA ESTABILIZADORA FORD FIESTA (DE 1989 ATÉ 1996) - KA	
	E0100	1130273 - 1661237		E0101	1135077 - 1209035
	ESTICADOR DA BARRA ESTABILIZADORA DA FRENTE FORD FIESTA III TT DE 1989 ATÉ 1995 - FIESTA IV TT APÓS 1996 - PUMA 1.7 - KA 1.3			ESTICADOR DA BARRA ESTABILIZADORA DA FRENTE FORD FIESTA III 1.8 D DE 1989 ATÉ 1995 - FIESTA IV 1.8 D APÓS 1996	
	275x34x34mm	2p-d10-20mm		265x25x25mm	2p-d10-30mm
	E0102	1146150		L3012	6140086 - 1621933
	ESTICADOR DA BARRA ESTABILIZADORA DA FRENTE FORD FIESTA V TT APÓS 11/2001 - FUSION TT			CASQUILHO DA BARRA ESTABILIZADORA FORD FIESTA I 0.9 - 1.1 - 1.3 - 1.6 XR2 (DE 1976 A 1983) - FIESTA II 1.1 - 1.3 - 1.4 - 1.6D - 1.6XR2 (DE 1983 A 1989)	
	320x34x34mm	2p-d10-28mm		d45x15mm	1f-17mm
	T0034	6543416		T1030F11	6046476
	BATENTE DA BARRA ESTABILIZADORA DA SUSPENSÃO TRÁS DIAM. 16mm FORD FIESTA III 1.0 - 1.1 - 1.3 - 1.4 - 1.6 - 1.6i 16V - 1.8 16V - 1.8D (DE 1989 A 2002) - FORD PUMA 1.7 16V (APÓS 03-1997)			BATENTE BARRA ESTABILIZADORA (CENTRO) FORD FIESTA 1.0 - 1.1 - 1.3 - 1.4 - 1.6 - 1.6i 16V - 1.8D (DE 1989 A 1995) - FORD COURIER 1.8D (DE 09-1991 - A 02-1996)	
	41x38x32mm	1f-d16mm		32x32x27mm	1f-d11mm
	T1030F12	1652936		T1030F15	6154572 - 7144201 - 934A037EA
	BATENTE BARRA ESTABILIZADORA (CENTRO) FORD FIESTA III 1.0 - 1.1 - 1.3 - 1.4 - 1.6 - 1.6i 16V - 1.8D (DE 1989 A 1995) - FORD COURIER 1.8D (DE 09-1991 A 02-1996)+F525			BATENTE DA BARRA ESTABILIZADORA FORD FIESTA - MONDEO (APÓS 1996)	
	32x32x27mm	1f-d12mm		32x32x27mm	1f-d15mm

	T1045	1003609 - 96FB5484CA		T1050	7102392
	BATEENTE DA BARRA ESTABILIZADORA FRENTE CENTRO FORD FIESTA IV 1.0i - 1.25i 16V - 1.3i - 1.4i 16V - 1.6 16V SPORT - 1.8D (DE 1995 A 2002) - FORD KA 1.0i - 1.3i (DE 1996 A 2002)			BATEENTE DO CENTRO DA BARRA ESTABILIZADORA FORD FIESTA 1.0 - 1.1 - 1.3 - 1.4 - 1.6 - 1.6i 16V - 1.8 16V - 1.8D (DE 1989 A 1995) - FIESTA IV 1.4i 16V - 1.8D (DE 1995 A 2002) - FORD PUMA 1.7 16V (APÓS 03-1997)	
	39x37x30mm	1f-d15mm		39x35x30mm	1f-d15mm
	T1053F14	6154572		T1111	1152852 - 2S615484DA
	BATEENTE DA BARRA ESTABILIZADORA FORD FIESTA			BATEENTE DA BARRA ESTABILIZADORA DA FRENTE FORD FIESTA V (APÓS 11/01) - FUSION (APÓS 2002)	
	34x31x28mm	1f-d14mm		47x46x38mm	1f-d16.6mm

FORD FOCUS

	E0086	1203093 - 2M515E494AA		E0088	1209035 - 1107068 - 1111769 - YS413B438AB
	ESTICADOR DA BARRA ESTABILIZADORA FORD FOCUS (DAW - DBW) 1.4 16V - 1.6 16V - 1.8 16V - 1.8 Di - 1.8 TDDi - 1.8 TDCi - 2.0 16V - RS - ST 170 10/98 A11/04 - FOCUS COMBI (DNW) 1.4 16V - 1.6 16V - 1.8 16V - 1.8 Di - 1.8 TDDi - 2.0 16V 02/99 A 11/04 - FOCUS TRÊS VOLUMES (DFW) 1.4 16V - 1.6 16V			ESTICADOR DA BARRA ESTABILIZADORA FORD FOCUS (DAW - DBW) 1.4 16V - 1.6 16V - 1.8 16V - 1.8 Di - 1.8 TDDi - 1.8 TDCi - 2.0 16V - RS - ST 170 10/98 A11/04 - FOCUS COMBI (DNW) 1.4 16V - 1.6 16V - 1.8 16V - 1.8 Di - 1.8 TDDi - 1.8 TDCi - 2.0 16V - ST 170 02/99 A 11/04 - FOCUS TRÊS VOLUMES (DFW)	
	d31x95mm	1p-d8-120mm		260x25x20mm	2p-d10-27mm
	E0101	1135077 - 1209035		E0108	1203093
	ESTICADOR DA BARRA ESTABILIZADORA DA FRENTE FORD FOCUS TT			ESTICADOR DA BARRA ESTABILIZADORA DE TRÁS FORD FOCUS TT	
	265x25x25mm	2p-d10-30mm		d31x90mm	1p-d8-110mm
	E0154	4420546 - 2T145C486AD		E0155	4367012 - 2T143B438BA
	ESTICADOR DA BARRA ESTABILIZADORA DE TRÁS FORD CONNECT			ESTICADOR DA BARRA ESTABILIZADORA DA FRENTE FORD CONNECT	
	170x40x40mm	2p-d12-26mm		270x32x37mm	2p-d10-24mm
	E0178	1223792 - 1230909		E0191	1469208 - 1310333 - 3M515C486BE - 3M515C486BC
	ESTICADOR DA BARRA ESTABILIZADORA DA FRENTE FORD FOCUS C-MAX TT - FOCUS II TT			ESTICADOR DA BARRA ESTABILIZADORA DE TRÁS FORD FOCUS MKII (DE 07/2004 A 12/2007) - FOCUS MKIII (APÓS 12/2007) - FOCUS C-MAX (DE 06/2003 A 01/2008) - C-MAX	
	325x30x35mm	2p-d10-22mm		90x50x40mm	1p-d10-287mm 1p-d10-22mm
	L3080	11503258 - 1M5Q5776AA		T1042	1073249 - 98AG4A037BA
	CASQUILHO DA BARRA ESTABILIZADORA DE TRÁS FORD FOCUS APÓS 1998			BATEENTE DA BARRA ESTABILIZADORA (CENTRO DE TRÁS) FORD FOCUS (DE 1998 A 2004)	
	d31x62mm	1f-d8mm		45x46x32mm	1f-d20mm

FORD FOCUS

Rafri, Lda.

	T1075	1073217 - 98AG.5484DA		
	BATENTE DA BARRA ESTABILIZADORA DA FRENTE			
	FORD FOCUS (DE 1998 A 2004)			
	48x48x39mm	1f-d18-19mm		





FORD GALAXY

	E0107	1009591 - 1141774		T1096	1009649
	ESTICADOR DA BARRA ESTABILIZADORA DA FRENTE			BATENTE DA BARRA ESTABILIZADORA DE TRÁS LADO LATERAL	
	FORD GALAXY TT (APÓS 03-195)			FORD GALAXY (DE 1995 A 2000) 1.9 TDi - 2.0 - 2.3 - 2.8	
	245x35x35mm	2p-d12-25mm		d35x30mm	1f-d21mm

FORD KA

	T1055	1035515		
	BATENTE DA BARRA ESTABILIZADORA CENTRO FRENTE			
	FORD KA 1.3i (APÓS 1997)			
	40x37x31mm	1f-d14mm		



FORD MONDEO

	E0087	1219697 - 1117698 - 1S713B438AB		E0103	1106269 - 6960036
	ESTICADOR DA BARRA ESTABILIZADORA			ESTICADOR DA BARRA ESTABILIZADORA DA FRENTE	
	FORD MONDEO III (B5Y) 1.8 16V - 2.0 16V - 2.016V Di - 2.0 16V TDDi - 2.016 TDCi - 2.5 V6 24V - ST 220 APÓS 11/2000 - MONDEO III COMBI (BWY) 1.8 16V - 2.0 16V - 2.0 16V Di - 2.0 16V TDDi - 2.0 16V TDCi - 2.5 V6 24V - ST 220 APÓS 11/2000 - MONDEO III TRÉS			FORD MONDEO I TT (ATÉ 08-1996) - MONDEO II TT (DE 09-1996 ATÉ 11-2000)	
	285x35x35mm	2p-d10-25mm		265x26x26mm	2p-d10-30mm
	E0104	1054209		E0105	1127646
	ESTICADOR DA BARRA ESTABILIZADORA DE TRÁS			ESTICADOR DA BARRA ESTABILIZADORA DA FRENTE	
	FORD MONDEO I TT (ATÉ 08-1996) - MONDEO II TT (DE 09-1996 ATÉ 11-2000)			FORD MONDEO III TT (APÓS 11-2000)	
	120x32x22mm	1p-d10x45mm 1f-d10mm		290x36x36mm	2p-d10-28mm



	E0106	1117800 - 1127648		E0137	7014210
	ESTICADOR DA BARRA ESTABILIZADORA DA FRENTE FORD MONDEO III TT (APÓS 11-2000)			ESTICADOR DA BARRA ESTABILIZADORA DE TRÁS FORD MONDEO I TT ATÉ 08/1996, FORD MONDEO II TT DE 09/1996 ATÉ 11/2000	
	290x40x40mm	2p-d10-23mm		102x30x30mm	1p-d10-30mm 1f-d7mm
	E0157	1219697 - 1S713B438BA		E0158	1130452 - 1S715C486BE
	ESTICADOR DA BARRA ESTABILIZADORA FORD MONDEO (DE 1993 ATÉ 1996)			ESTICADOR DA BARRA ESTABILIZADORA DE TRÁS FORD MONDEO (APÓS 2000)	
	290x40x40mm	2p-d10-24mm		100x35x45x38mm	2p-d10-23mm
	L3042	6915411 - 935C493AC		T1044	6714195 - 93 5484AB
	CASQUILHO DA BARRA ESTABILIZADORA DE TRÁS (PONTAS) FORD MONDEO (DE 1996 A 1998)			BATENTE DA BARRA ESTABILIZADORA CENTRO FRENTE FORD MONDEO (APÓS 1993)	
	d24x26mm	1f-d12mm		43x42x30mm	1f-d20mm
	T1051	6714195		T1090	1124418
	BATENTE DO CENTRO DA BARRA ESTABILIZADORA (FURO DIÂMETRO 20mm) FORD MONDEO 1.6i - 1.6i 16V - 1.8TD - 1.8i - 1.8i 16V - 2.0i - 16V - 2.5TD - 2.5 ST200 (DE 1993 A 2000)			BATENTE DA BARRA ESTABILIZADORA DE TRÁS FORD MONDEO III COMBI (BWY) 2.0 16V TDDi - 2.0 16V TDCi APÓS 11/2000 - MONDEO III TRÊS VOLUMES (B4Y) 1.8 16V - 2.0 16V - 2.0 16V Di - 2.0 16V TDDi - 2.0 16V TDCi - 2.5 V6 24V APÓS 11/2000 - 1.8 Sci APÓS 06/03 - 2.0 TDCi APÓS 10/2001 - ST 220 APÓS 04/02	
	43x39x30mm	1f-d20mm		45x43x40mm	1f-d19mm
	T1091	1118695 - 1307891 - 1116602 - 1S715484AC			
	BATENTE DA BARRA ESTABILIZADORA DA FRENTE FORD MONDEO III(B5Y) 1.8 16V - 2.0 16V - 2.0 16V Di/TDDi/TDCi 2.5 V6 24V - APÓS 11/2000 - 1.8 Sci APÓS 06/03 - ST 220 APÓS 04/02 MONDEO III COMBI (BWY) 1.8 16V - 2.0 16V - 2.0 16V Di/TDDi/TDCi - 2.5 V6 24V APÓS 11/2000 - 1.8 Sci APÓS 06/03 - ST 220 APÓS 4				
	46x47x40mm				

FORD P100

	L3043	1481463 - 715K498		
	CASQUILHO DAS PONTAS DA BARRA ESTABILIZADORA FORD P100			
	d28x42mm	1f-d10mm		





	L3043	1481463 - 715K498		T1051	6714195
	CASQUILHO DAS PONTAS DA BARRA ESTABILIZADORA FORD SIERRA			BATENTE DO CENTRO DA BARRA ESTABILIZADORA (FURO DIÂMETRO 20mm) FORD SCORPIO 2.0i 16V - 2.0i - 2.5TD - 2.9i 24V - 2.9i (DE 1994 A 1998)	
	d28x42mm	1f-d10mm		43x39x30mm	1f-d20mm

FORD TOURNEO - TOURNEO CONNECT

	T1097	2T144A037AC - 4419557		T1098	2T145484BD - 4419559
	BATENTE DA BARRA ESTABILIZADORA DE TRÁS FORD TOURNEO CONNECT (APÓS 2002)			BATENTE DA BARRA ESTABILIZADORA DA FRENTE FORD TOURNEO CONNECT (APÓS 2002)	
	49x46x42mm	1f-d22mm		49x46x42mm	1f-26x21mm

FORD TRANSIT - TRANSIT CONNECT

	E0084	1099259-3736028 - 3933468		E0153	4531299 - YC155C486AE
	ESTICADOR DA BARRA ESTABILIZADORA DA FRENTE FORD TRANSIT (APÓS 1998) - V184 2001			ESTICADOR DA BARRA ESTABILIZADORA DE TRÁS FORD TRANSIT V184 (APÓS 2001)	
	d31x200mm			385x40x42mm	1p-d12-30mm 1f-d12mm
	E0156	1669212 - V92VB5C486AA		L3081	1631619 - 86VB5K498AA
	ESTICADOR DA BARRA ESTABILIZADORA DE TRÁS FORD TRANSIT (DE 1998 ATÉ 2000)			CASQUILHO DA BARRA ESTABILIZADORA FORD TRANSIT TURBO APÓS 1998	
	250x42x40mm	2p-d12-33mm		d27x31mm	d17mm 1f-d10mm
	T0033			T1041	6521812 - 92VB5484BA
	BATENTE DA BARRA ESTABILIZADORA FORD TRANSIT MODERNO (APÓS 86)			BATENTE DA BARRA ESTABILIZADORA (FRENTE CENTRO) FORD TRANSIT M15 - T15	
	40x40x36mm	1f-d16mm		39x39x36mm	1f-d20mm
	T1043	6521811 - 92VB5484AA		T1046	6141942 - 86VB5484-BA
	BATENTE DA BARRA ESTABILIZADORA (CENTRO FRENTE) FORD TRANSIT M12 - T12			BATENTE DA BARRA ESTABILIZADORA TRÁS FORD TRANSIT M15 2.5TD	
	39x39x36mm	1f-d18mm		70x50x58mm	1f-d30mm

	T1046-C	YC15.5486AA		T1074	4041489 - YC15.5484AC
	BATENTE DA BARRA ESTABILIZADORA TRÁS(COMPLETO) FORD TRANSIT M12 - M15 (APÓS 1986) - V184 (2001)			BATENTE DA BARRA ESTABILIZADORA DA FRENTE FORD TRANSIT V184 2001	
	142x64x61mm	1f-d31mm		52x50x36mm	1f-d24mm
	T1089	4041490 - YC155484BD		T1097	2T144A037AC - 4419557
	BATENTE DA BARRA ESTABILIZADORA DE TRÁS FORD TRANSIT V184 APÓS 2000			BATENTE DA BARRA ESTABILIZADORA DE TRÁS FORD TRANSIT CONNECT (APÓS 2002)	
	70x62x50mm	1f-d29mm		49x46x42mm	1f-d22mm
	T1098	2T145484BD - 4419559			
	BATENTE DA BARRA ESTABILIZADORA DA FRENTE FORD TRANSIT CONNECT				
	49x46x42mm	1f-26x21mm			

HYUNDAI GETZ

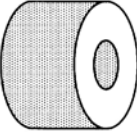

	E0187	548301C000		E0188	548401C000
	ESTICADOR DA BARRA ESTABILIZADORA DA FRENTE LADO ESQUERDO HYUNDAI GETZ TT			ESTICADOR DA BARRA ESTABILIZADORA DA FRENTE LADO DIREITO HYUNDAI GETZ TT	
	230x30x30mm	2p-d10-21mm		230x35x30mm	2p-d10-21mm

ISUZU BRAVA

	E0078	8-94223-156		T0019	9-51631-619-1
	ESTICADOR DAS PONTAS DA BARRA ESTABILIZADORA FRENTE ISUZU BRAVA TFR - KBZ			BATENTE DA BARRA ESTABILIZADORA (PONTAS) ISUZU BRAVA	
	d32x45mm	d25mm		d38-21mm	1f-d14mm

	S1482	8-97021-0550 - 8-94375-105-0		
	SILENT BLOC DA BARRA ESTABILIZADORA LATERAL			
	ISUZU BIGHORN (1992 A 1997)			
	d54x71mm	c55mm 1f-d14mm		

ISUZU KBD KB20 - KBZ

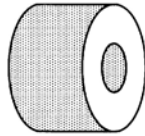
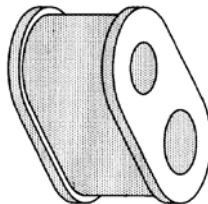
	E0075	9-51779-634-1K		E0078	8-94223-156
	ESTICADOR DE BARRA ESTABILIZADORA			ESTICADOR DAS PONTAS DA BARRA ESTABILIZADORA FRENTE	
	ISUZU KBD 25 - 26 - 27 - 47			ISUZU KBZ	
	d33x185mm	d25mm		d32x45mm	d25mm
	L0176	9-51631-616-0		T0019	9-51631-619-1
	CASQUILHO DA BARRA ESTABILIZADORA			BATENTE DA BARRA ESTABILIZADORA (PONTAS)	
	ISUZU KBD			ISUZU KBD 25 - 26 - 27 - 47	
	d25x16mm	1f-d11mm		d38-21mm	1f-d14mm
	T0023	8-94223-1570			
	BATENTE DA BARRA ESTABILIZADORA				
	ISUZU KBD 26				
	73x40x35mm	1f-d21mm 1f-d15mm			

ISUZU MIDI

	T0044			
	BATENTE DA BARRA ESTABILIZADORA			
	ISUZU MIDI			
	41x35x32mm	1f-16mm		

	S1482	8-97021-0550 - 8-94375-105-0		
	SILENT BLOC DA BARRA ESTABILIZADORA LATERAL			
	ISUZU TROOPER (1992 A 1997)			
	d54x71mm	c55mm 1f-d14mm		

IVECO DAILY

	T0028	8558110		
	BATENTE DA BARRA ESTABILIZADORA			
	IVECO DAILY			
	70x60x57mm	1f-d30mm		

IVECO ZETA

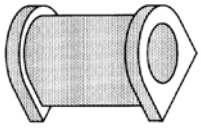
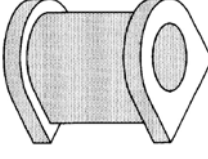

	T0028	8558110		T0031	8588387
	BATENTE DA BARRA ESTABILIZADORA			BATENTE DA BARRA ESTABILIZADORA	
	IVECO ZETA 50.9 - 65.9 - TURBOZETA 60.11 - 65.12 - 79.12			IVECO ZETA 50.9 - 65.9 - TURBOZETA 60.11 - 65.12 - 79.12	
	70x60x57mm	1f-d30mm		55x40x38mm	1f-d25mm
	T0032	8563414			
	BATENTE DA BARRA ESTABILIZADORA				
	IVECO 40NC - 50NC - 55NC - 80NC - 90NC - ZETA 50.9 - 65.9				
	60x52x50mm	1f-d29mm			

LANCIA

	E0144			T1095	7750990
	ESTICADOR DA BARRA ESTABILIZADORA DA FRENTE			BATENTE DA BARRA ESTABILIZADORA DA FRENTE	
	LANCIA - AUTOBIANCHI ZETA TT			LANCIA AUTOBIANCHI Y 1.1 - 1.2 (8V) - 1.2 (16V) - 1.4 (12V 75CV) - 1.4 (12V 80CV)	
	120x40x40mm	1p-d12-25mm 1f-d12mm		87x31x34mm	

LANCIA DEDRA

Papi, Lda.

	E0192	51701045		E1152-C	60570627
	ESTICADOR DA BARRA ESTABILIZADORA DA FRENTE			ESTICADOR DA BARRA ESTABILIZADORA DA FRENTE	
LANCIA DEDRA 1.6 16V - 2.0 16V - 1.9TD			LANCIA DEDRA TT		
	310x31x36mm	2p-d10-25mm		120x35x32mm	1f-d12mm
	T1025	7635714			
	BATENTE DA BARRA ESTABILIZADORA				
LANCIA DEDRA 1.6 IE					
	60x46x40mm	1f-d20mm			

LANCIA DELTA - NOVO DELTA

	E1152-C	60570627			
	ESTICADOR DA BARRA ESTABILIZADORA DA FRENTE				
LANCIA DELTA II TT					
	120x35x32mm	1f-d12mm			

LANCIA LYBRA



	E0192	51701045			
	ESTICADOR DA BARRA ESTABILIZADORA DA FRENTE				
LANCIA LYBRA TT					
	310x31x36mm	2p-d10-25mm			

MAZDA 1.8 - 2.0 - 2.3

	E0236	GJ6A28170A			
	ESTICADOR DA BARRA ESTABILIZADORA DE TRÁS				
MAZDA 1.8 (APÓS 08-2002) - 2.0 - 2.0 Di (APÓS 08-2002) - 2.3 (APÓS 08-2002) - 2.3 AWD (APÓS 11-2002)					
	105x32x32mm	1p-d10-19mm 1f-d10mm			

	E0178	BP4K34170C - BP4K34170D		
	ESTICADOR DA BARRA ESTABILIZADORA DA FRENTE MAZDA 3 TT - 5 TT			
	325x30x35mm	2p-d10-22mm		

MAZDA 6

	E0240	GJ6A34150A		E0241	GJ6A34170A
	ESTICADOR DA BARRA ESTABILIZADORA DA FRENTE LADO DIREITO MAZDA 6 (TODAS MOTORIZAÇÕES)			ESTICADOR DA BARRA ESTABILIZADORA DA FRENTE LADO ESQUERDO MAZDA 6 (TODAS MOTORIZAÇÕES)	
	182x32x32mm	2p-d10-23mm		182x32x32mm	2p-d10-23mm

MAZDA 818

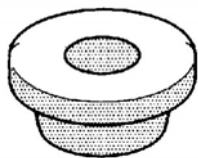
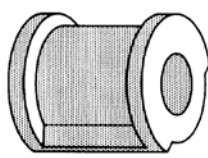
	L0268	856534153		T0008	1881-34-156
	CASQUILHO DE ESTABILIZADOR MAZDA 818			BATENTE DA BARRA ESTABILIZADORA MAZDA 818	
	d40x25mm	d32mm 1f-d16mm		47x44x42mm	1f-d20mm

MAZDA B1200 - B2000 - B2200 - B2500 - B2700 - B3000 - MAGNUM -

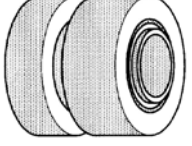
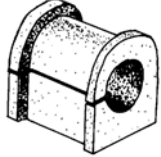

	T1015	UB71-34-156		
	BATENTE DA BARRA ESTABILIZADORA DA FRENTE PARTE DO CENTRO MAZDA B2500			
	36x33x33mm	1f-d24mm		

	T0017	S08334136		T0040	S083-34-156
	BATERIA DA BARRA ESTABILIZADORA			BATERIA DA BARRA ESTABILIZADORA DO CENTRO	
MAZDA E2200			MAZDA E2200		
d48x40mm			41x38x38mm		1f-d19mm

MERCEDES

	L0128			T0012	3093230385
	CASQUILHO DA BARRA ESTABILIZADORA			BATERIA DA BARRA ESTABILIZADORA	
MERCEDES			MERCEDES FURGÃO - 406 - 407 - 408 - 508 - O309B - O309D - 608-613		
d30x22mm		c18mm 1f-d10mm	50x45x48mm		1f-d28mm
	T0013			T1052F13	2013261081
	BATERIA DA BARRA ESTABILIZADORA			BATERIA DA BARRA ESTABILIZADORA	
MERCEDES SÉRIE 115 - SÉRIE 123 (BARRA TORÇÃO)			MERCEDES S201 - 129 - 300SL - 500SL - 190E - 190 2.6 - 190D - 190 TURBO		
72x50x48mm		4f-d5mm	35x28x26mm		1f-d13mm

MERCEDES 190 (W201)

	E0111	1243200289		T1056F18	1243232385 - 1243234985
	ESTICADOR DA BARRA ESTABILIZADORA DE TRÁS			BATERIA DA BARRA ESTABILIZADORA DA FRENTE PARTE LATERAL	
MERCEDES 190 (W201) 2.0 (10-1982 A 10-1984) - 190 (W201) E 2.5-16 (09-1988 A 08-1993) - 190 (W201) E 2.0 (10-1982 A 06-1993) - 190 (W201) E 2.3 (09-1986 A 08-1991) - 190 (W201) E 2.3-16 (09-1985 A 12-1987) - 190 (W201) TURBO D 2.5 (02-1988 A 08-1993) - 190 (W201) 2.0			MERCEDES 190 (W201) E 2.6 (9-1986 A 8-1993)		
230x28x26mm		1p-d10-12mm 1f-d7mm	d48x38mm		d40mm 1f-d18mm
	T1056F22	2013234885			
	BATERIA DAS PONTAS BARRA ESTABILIZADORA FRENTE				
MERCEDES (W201) - 190 /E /D /TD					
d48x37mm		1f-22mm			

	E0112	1243200489		E0113	1233200989
	ESTICADOR DA BARRA ESTABILIZADORA DE TRÁS			ESTICADOR DA BARRA ESTABILIZADORA DE TRÁS	
	MERCEDES 200 T (S124) (01-1986 A 05-1990) - 200 T D (09-1988 A 08-1991) - 200 TE (10-1992 A 06-1993) - 200 TE (09-1988 A 12-1989) - 200 TE (09-1988 A 08-1992)			MERCEDES 200 D (W115) (01-1968 A 01-1977) - 200 (W115) (01-1968 A 01-1977) - 200 T (S123) (11-1980 A 11-1985) - 200 (W123) (06-1980 A 11-1985) - 200 D (W123) (07-1976 A 02-1979) - 200 (W123) (06-1976 A 11-1985)	
230x26x48mm	1p-d10-15mm 1f-d7mm		125x28x22mm	2p-d10-20mm	

MERCEDES 220 (W111) - (W115) - (W123)

	E0112	1243200489		E0113	1233200989
	ESTICADOR DA BARRA ESTABILIZADORA DE TRÁS			ESTICADOR DA BARRA ESTABILIZADORA DE TRÁS	
	MERCEDES 220 TE (S124) (10-1992 A 05-1993)			MERCEDES 220 D (W115) (01-1968 A 01-1977) - 220 D (W123) (01-1976 A 02-1979)	
230x26x48mm	1p-d10-15mm 1f-d7mm		125x28x22mm	2p-d10-20mm	

MERCEDES 230 (W111) - (W114) - (W123) - (C123) - (S123) - (C124) - (W115)

	E0112	1243200489		E0113	1233200989
	ESTICADOR DA BARRA ESTABILIZADORA DE TRÁS			ESTICADOR DA BARRA ESTABILIZADORA DE TRÁS	
	MERCEDES 230 TE (S124) (06-1989 A 08-1992)			MERCEDES 230 C (C123) COUPE (05-1977 A 04-1980) - 230 CE (C123) (04-1980 A 12-1985) - 230 T (S123) (09-1977 A 03-1980) - 230 (W123) (02-1976 A 03-1981) - 230 E (W123) (04-1980 A 12-1985)	
230x26x48mm	1p-d10-15mm 1f-d7mm		125x28x22mm	2p-d10-20mm	

MERCEDES 240 (W115) - (W123) - (S123)

	E0113	1233200989		
	ESTICADOR DA BARRA ESTABILIZADORA DE TRÁS			
	MERCEDES 240 D (W115) (08-1973 A 01-1977) - 240 T D (S123) (03-1979 A 12-1985) - 240 D (W123) (03-1979 A 11-1985)			
125x28x22mm	2p-d10-20mm			

MERCEDES 250 (W111) - (W114) - (W124) - (W123) - (S123)
Rafri, Lda.

	E0112	1243200489		E0113	1233200989
	ESTICADOR DA BARRA ESTABILIZADORA DE TRÁS			ESTICADOR DA BARRA ESTABILIZADORA DE TRÁS	
	MERCEDES 250 T D (S124) (09-1985 A 06-1993) - 250 D (04-1985 A 06-1993)			MERCEDES 250 T (S123) (05-1978 A 10-1979)	
	230x26x48mm	1p-d10-15mm 1f-d7mm		125x28x22mm	2p-d10-20mm



MERCEDES 260 (W124)

	E0112	1243200489		
	ESTICADOR DA BARRA ESTABILIZADORA DE TRÁS			
	MERCEDES 260 TE (S124) (09-1989 A 08-1992) - 260 E (09-1985 A 08-1992)			
	230x26x48mm	1p-d10-15mm 1f-d7mm		

MERCEDES 280 (W111) - (W114) - (W123) - (C123) - (S123)

	E0112	1243200489		E0113	1233200989
	ESTICADOR DA BARRA ESTABILIZADORA DE TRÁS			ESTICADOR DA BARRA ESTABILIZADORA DE TRÁS	
	MERCEDES 280 TE (S124) (10-1992 A 06-1993)			MERCEDES 280 CE (C123) COUPE (09-1977 A 08-1979) - 280 C (C123) (03-1977 A 03-1980) - 280 TE (S123) (09-1977 A 11-1985) - 280 E (W123) (02-1976 A 11-1985) - 280 (W123) 8DE 08-1981 A 07-1985)	
	230x26x48mm	1p-d10-15mm 1f-d7mm		125x28x22mm	2p-d10-20mm

MERCEDES 300 (W123) - (W124) - (C123) - (C124) - (S123) - (S124)

	E0112	1243200489		E0113	1233200989
	ESTICADOR DA BARRA ESTABILIZADORA DE TRÁS			ESTICADOR DA BARRA ESTABILIZADORA DE TRÁS	
	MERCEDES 300 T TURBO D (S124) (01-1989 A 06-1993) - 300 TE-24 (09-1989 A 08-1992) - 300 TE (01-1986 A 08-1992) - 300 TE 4 (09-1986 A 06-1993) - 300 T D (09-1986 A 06-1993)			MERCEDES 300 C (C123) TURBO D (09-1981 A 07-1985) - 300 T D (S123) (09-1977 A 10-1985) - 300 D (W123) (02-1976 A 07-1980)	
	230x26x48mm	1p-d10-15mm 1f-d7mm		125x28x22mm	2p-d10-20mm

	E0114	1683201089 - 1683201189 - 1683200589 - 1683200789		
	ESTICADOR DA BARRA ESTABILIZADORA DA FRENTE			
	MERCEDES CLASSE A (W168) A 190 (03-1999 A 08-2004) - A 170 CDI (07-1998 A 02-2001) - A 160 CDI (07-1998 A 02-2001) - A160 (07-1997 A 08-2004) - A 140 (07-1997 A 08-2004) - A 170 CDI (02-2001 A 08-2004)			
	260x36x36mm	2p-d10mm		



MERCEDES CLASSE C (W202) - (S202) - (W203) - (S203)

	E0111	1243200289		E0135	2033202889	
	ESTICADOR DA BARRA ESTABILIZADORA DE TRÁS			ESTICADOR DA BARRA ESTABILIZADORA DA FRENTE		
	MERCEDES CLASSE C (W202) C 240 (06-1997 A 05-2000) - (W202) C 180 (03-1993 A 05-2000) - (W202) C 250 D (05-1993 A 05-2000) - (W202) C 250 TURBO D (10-1995 A 05-2000) - (W202) C 220 D (08-1993 A 05-2000) - (W202) C 36 AMG (05-1994 A 05-2000) - (W202) C 220 CDI (09-1997 A			MERCEDES CLASSE C TT		
	230x28x26mm	1p-d10-12mm 1f-d7mm		310x40x40mm	2p-d10-30mm	
	T1056F18	1243232385 - 1243234985		T1056F23	2023230285	
	BATENTE DA BARRA ESTABILIZADORA DA FRENTE PARTE LATERAL			BATENTE DA BARRA ESTABILIZADORA DA FRENTE		
	MERCEDES CLASS C (W202) 180 - 180T - 200 - 200D - 200T - 200TK - 200TD - 230 - 230T - 230TK - 240 - 240T - 250D - 250TD - 280 - 280T - 43 AMG			MERCEDES CLASS C(W202) 180 03/93 A 05/00 - 200 - 200D - 220 - 220D - 230 08/93 A 05/00 - CLASS C COMBI (S202) 180 T - 200 T - 200 TD - 220 TD - 230 T 06/96 A06/02 - CLK(C208) 200 06/97 A 06/02		
	d48x38mm	d40mm 1f-d18mm		d52x40mm	d45mm 1f-d23mm	

MERCEDES CLASSE CLK (C208) - (A208) - (C209)

	E0111	1243200289		T1056F18	1243232385 - 1243234985	
	ESTICADOR DA BARRA ESTABILIZADORA DE TRÁS			BATENTE DA BARRA ESTABILIZADORA DA FRENTE PARTE LATERAL		
	MERCEDES CLASSE CLK (C208) 55 AMG (08-1999 A 06-2002) - CLK (C208) 200 (06-1997 A 06-2002) - CLK (C208) 430 (07-1998 A 06-2002) - CLK (C208) 200 KOMPRESSOR (06-1997 A 06-2002) - CLK (C208) 320 (06-1997 A 06-2002) - CLK (C208) 230 KOMPRESSOR (06-1997 A 06-2002) - CLK			MERCEDES CLASS CLK (W208) 230K - 320 - CLK200 - CLK200K		
	230x28x26mm	1p-d10-12mm 1f-d7mm		d48x38mm	d40mm 1f-d18mm	

MERCEDES CLASSE E (W124) - (A124) - (S124) - (W210) - (S210) - (W211)

	E0111	1243200289		E0112	1243200489	
	ESTICADOR DA BARRA ESTABILIZADORA DE TRÁS			ESTICADOR DA BARRA ESTABILIZADORA DE TRÁS		
	MERCEDES CLASSE E (W124) E 200 (06-1993 A 06-1995) - (W124) E 300 TURBO D (06-1993 A 06-1995) - (W124) E 250 TURBO D (06-1993 A 06-1995) - (W124) 300 D (DE07-1993 A 06-1995) - (W124) E 250 D (07-1993 A 06-1995) - E (W210) E 200 KOMPRESSOR (08-2000 A 03-2002) - E (W210) E 430			MERCEDES CLASSE E (W124) E 280 (06-1993 A 06-1995) - E 250 D (07-1993 - 06-1995) - (S124) E 320 T (06-1993 - 06-1996) - E 280 T (06-1993 A 06-1996) - E 300 T TURBO D 4 (06-1993 A 06-1996) - E 220 T (06-1993 - 06-1996) - E 300 T TURBO D (06-1993 A 06-1996) - E 200 T (06-1993 A 06-		
	230x28x26mm	1p-d10-12mm 1f-d7mm		230x26x48mm	1p-d10-15mm 1f-d7mm	

MERCEDES CLASSE E (W124) - (A124) - (S124) - (W210) - (S210) - (W211) *Rafpi, Lda.*

	E0115	2103202289 - 2103203789		E0116	213202189 - 2103203689
	ESTICADOR DA BARRA ESTABILIZADORA DA FRENTE LADO DIREITO MERCEDES CLASSE E (W210) E 230 (06-1995 A 06-1997) - E 200 KOMPRESSOR (08-2000 A 03-2002) - E 300 D (06-1995 A 06-1997) - E 300 TURBO D (12-1996 A 07-1999) - E 430 (06-1997 A 03-2002) - E 200 (06-1995 A 08-2000) - E 50 AMG (02-1996 A 08-1997) - E 320 (06-1997 A 03-2002) - E			ESTICADOR DA BARRA ESTABILIZADORA DA FRENTE LADO ESQUERDO MERCEDES CLASSE E (W210) E 220 D (06-1995 A 07-1999) - E 280 (01-1996 A 06-1997) - E 55AMG (08-1997 A 03-2002) - E 290 TURBO D (03-1996 A 07-1999) - E 250 TURBO D (06-1997 A 07-1999) - E 200 KOMPRESSOR (06-1997 A 03-2002) - E 320 (06-1995 A 06-1997) - E 300 (06-	
	150x40x34mm	1f-d12mm 1f-d14mm		150x41x28mm	1f-d12mm
	E0117	2113200989		E0118	2113201089
	ESTICADOR DA BARRA ESTABILIZADORA DA FRENTE LADO ESQUERDO MERCEDES CLASSE E (W211) E 220 CDI (APÓS 03-2002) - E 240 (APÓS 03-2002) - E 200 KOMPRESSOR (APÓS 11-2002) - E 240 (APÓS 03-2002) - E 55 AMG KOMPRESSOR (APÓS 10-2002) - E 400 CDI (APÓS 02-2003) - E 500 (APÓS 03-2002) - E 200 CDI (APÓS 07-2002) - E 320 (APÓS 03-			ESTICADOR DA BARRA ESTABILIZADORA DA FRENTE LADO DIREITO MERCEDES CLASSE E (W211) E 220 CDI (APÓS 03-2002) - E 240 (APÓS 03-2002) - E 200 KOMPRESSOR (APÓS 11-2002) - E 240 (APÓS 03-2002) - E 55 AMG KOMPRESSOR (APÓS 10-2002) - E 400 CDI (APÓS 02-2003) - E 500 (APÓS 03-2002) - E 200 CDI (APÓS 07-2002) - E 320 (APÓS 03-	
	180x60x35mm	1f-d14mm		180x60x35mm	1f-d14mm
	E0119	2113203389		T1056F18	1243232385 - 1243234985
	ESTICADOR DA BARRA ESTABILIZADORA DE TRÁS MERCEDES CLASSE E (W211) TT			BATENTE DA BARRA ESTABILIZADORA DA FRENTE PARTE LATERAL MERCEDES CLASS E (W210) 280 4 MATIC - 280 T	
	295x31x33mm	1p-d10-18mm		d48x38mm	d40mm 1f-d18mm
	T1056F25	1243233785			
	BATENTE DAS PONTAS BARRA ESTABILIZADORA FRENTE MERCEDES S201 - 190 CLASSE E200 - E200D				
	d48x37mm	1f-d25mm			

MERCEDES CLASSE S (W114) - (W115) - (W116) - (W126) - (W140) - (W220)

	E0113	1233200989			
	ESTICADOR DA BARRA ESTABILIZADORA DE TRÁS MERCEDES CLASSE S (W126) 280 SE (10-1979 A 07-1985) - 420 SE (10-1995 A 06-1991) - S (W126) 260 SE (09-1985 A 06-1991) - S (W126) 380 SE (DE(12-1979 A 08-1986) - S (W126) 300 SE (01-1986 A 06-1991)				
	125x28x22mm	2p-d10-20mm			

MERCEDES CLASSE SL (R107) - (R129) - (R230)



	E0111	1243200289			
	ESTICADOR DA BARRA ESTABILIZADORA DE TRÁS MERCEDES CLASSE SL (R129) 500 (09-1992 A 10-2001) - SL (R129) 280 (05-1998 A 10-2001) - SL (R129) 320 (09-1993 A 10-2001) - SL (R129) 300 SL (03-1989 A 07-1993) - SL (R129) 280 (08-1993 a 10-2001) - SL (R129) 500 (05-1998 a 10-2001) - SL (R129) 600 (07-1992 a 10-2001)				
	230x28x26mm	1p-d10-12mm 1f-d7mm			

	E0111	1243200289		
	ESTICADOR DA BARRA ESTABILIZADORA DE TRÁS			
MERCEDES CLASSE SLK (R170) 230 KOMPRESSOR (09-1996 A 04-2004) - SLK (R170) 200 KOMPRESSOR (10-1996 A 03-2004) - SLK (R170) 200 (09-1996 A 03-2000)				
	230x28x26mm	1p-d10-12mm 1f-d7mm		



MERCEDES SPRINTER (901) - (902) - (903) - (904)

	E0113	1233200989		T1017	2D0498101
	ESTICADOR DA BARRA ESTABILIZADORA DE TRÁS			BATENTE DA BARRA ESTABILIZADORA DA FRENTE	
MERCEDES SPRINTER 2-t (901) (902) (02-1995 A 05-2006) - SPRINTER 2-t (903) (02-1995 A 04-2000) - SPRINTER 4-t (904) (02-1996 A 05-2006)		MERCEDES SPRINTER			
	125x28x22mm	2p-d10-20mm		41x31x30mm	1f-d23mm

MERCEDES CLASSE V

	E0120	6383230268		E0120	6383230268
	ESTICADOR DA BARRA ESTABILIZADORA DA FRENTE LADO DIREITO			ESTICADOR DA BARRA ESTABILIZADORA DA FRENTE LADO DIREITO	
MERCEDES CLASSE V (638) 114 2.3 (12-1996 A 07-2003) - 110 D 203 (03-1997 A 07-2003) - 108 D 2.3 (03-1997 A 07-2003) - 112 CDI 2.2 (03-1990 A 07-2003) - 110 CDI 2.2 (03-1999 A 07-2003) - 108 CDI 2.2 (03-1999 A 07-2003) - 114 2.3 (03-1997 A 07-2003) - 113 2.0 (03-1997 A 07-2003)		MERCEDES CLASSE V (638/2) V 200 (02-1997 A 07-2003) - V 230 (10-1996 A 07-2003) - V 220 CDI (03-1999 A 07-2003)			
	285x36x36mm	2p-d10-25mm		285x36x36mm	2p-d10-25mm
	E0121	6383230368			
	ESTICADOR DA BARRA ESTABILIZADORA DA FRENTE LADO ESQUERDO				
MERCEDES CLASSE V TT					
	280x36x36mm	2p-d10-20mm			

MERCEDES VITO (W638) - (W639) - (M104) - (M111)

	E0121	6383230368		T1078	6383260281
	ESTICADOR DA BARRA ESTABILIZADORA DA FRENTE LADO ESQUERDO			BATENTE DA BARRA ESTABILIZADORA FRENTE(CENTRO)	
MERCEDES CLASSE VITO TT		MERCEDES VITO (638) (APÓS 1996) 2.0 - 2.2CDI - 2.3 - 2.3D - 2.3TD			
	280x36x36mm	2p-d10-20mm		45x53x53mm	1f-d11mm

	T1079	6383230285		
	BATEINTE DA BARRA ESTABILIZADORA FRENTE (PONTAS) MERCEDES VITO (638) (APÓS 1996) 2.0 - 2.2 CDI - 2.3 - 2.3D - 2.3TD			
	45x53x53mm	1f-d23mm		

MITSUBISHI GALANT - ETERNA - SIGMA

	T1065	MB80884 - MB303052		
	BATEINTE DO CENTRO DA BARRA ESTABILIZADORA DA FRENTE MITSUBISHI GALANT - LANCER C11 - C12			
	d116x96mm	1f-d76mm		

MITSUBISHI L200 - STRAKAR - STRADA - FORTE - TRITON

	E0079	MB527168		T0037	MB175804
	ESTICADOR DA BARRA ESTABILIZADORA (PONTAS) MITSUBISHI L200 - E12			BATEINTE DA BARRA ESTABILIZADORA MITSUBISHI L200	
	d34x130mm	d25mm		40x39x36mm	1f-d23mm
	T1021	MB109557		T1038	MR-150767
	BATEINTE DA BARRA ESTABILIZADORA MITSUBISHI L200			BATEINTE DA BARRA ESTABILIZADORA PONTAS FRENTE MITSUBISHI STRADA 4WD - L200 4X4	
	38x38x36mm	1f-d26mm		46x41x39mm	1f-d20mm
	T1061	MB109557		T1110	MR151326
	BATEINTE DO CENTRO DA BARRA ESTABILIZADORA MITSUBISHI L200			BATEINTE DA BARRA ESTABILIZADORA MITSUBISHI STRADA 4WD K77 T 2800 CC	
	39x39x35mm	1f-d23mm		41x40x44mm	1f-d24mm

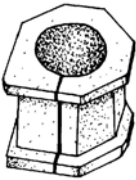
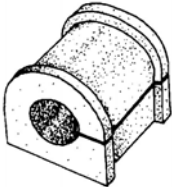

	T0035	MB175581		T0036	MB109557
	BATEENTE DA PONTA DA BARRA ESTABILIZADORA			BATEENTE DO CENTRO DA BARRA ESTABILIZADORA	
MITSUBISHI L300			MITSUBISHI L300		
40x38x38mm		1f-d20mm	42x42x40mm		1f-d18mm

MITSUBISHI PAJERO

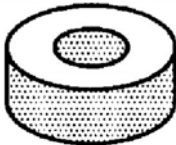

	L3098	MB-584146		T1080F24	MB573784
	CASQUILHO DA BARRA ESTABILIZADORA			BATEENTE DA BARRA ESTABILIZADORA	
MITSUBISHI PAJERO L044, L200 GALLOPER			MITSUBISHI PAJERO		
58x35mm		1f-d23, 8mm	40x46x45mm		1f-d24mm
	T1080F27	MB573783		T1087	MB338596
	BATEENTE DA BARRA ESTABILIZADORA			BATEENTE DA BARRA ESTABILIZADORA DE TRÁS	
MITSUBISHI PAJERO			MITSUBISHI PAJERO V 44W		
40x46x45mm		1f-d27mm	43x41x37mm		1f-d27mm
	T1103	MB-176442		T1105	MR-150094
	BATEENTE DA BARRA ESTABILIZADORA			BATEENTE DA BARRA ESTABILIZADORA	
MITSUBISHI PAJERO L044, L200 GALLOPER			MITSUBISHI PAJERO V44, L200 GALLOPER		
39x41x41mm		1f-d23mm	45x58x54mm		1f-d27mm

NISSAN

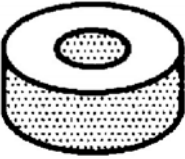

	L0176	56127-25660 - 56112-V10100 - 56112-09490 - 56112-09400		
	CASQUILHO DA BARRA ESTABILIZADORA			
NISSAN				
d25x16mm		1f-d11mm		

	T1028	55149-50A00		T1100	54613-58A00
	BATENTE DA BARRA ESTABILIZADORA DE TRÁS (CENTRO) NISSAN B12 - N13 (DE1986 A 1990) - SUNNY - SENTRA - ALMERA - PULSAR			BATENTE DA BARRA ESTABILIZADORA DA FRENTE NISSAN B12 SUNNY - SENTRA	
	58x57x40mm	1f-d23mm		28x36x41mm	1f-d23mm

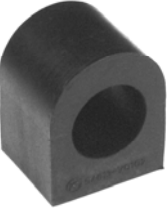
NISSAN CHERRY - DATSUN 100A - DATSUN 120A - DATSUN 120Y -





	L1008	56125-18000		T1102	54613-R0400 - 54613-A0100
	CASQUILO DA BARRA ESTABILIZADORA NISSAN DATSUN 1200 - 100A - 120Y			BATENTE DA BARRA ESTABILIZADORA NISSAN DATSUN 1200	
	d21x14mm	1f-d8mm		32x29x39mm	1f-d21mm
	T1108	54613-V0102			
	BATENTE DA BARRA ESTABILIZADORA NISSAN DATSUN 1200				
	28x34x42mm	1f-d22mm			

NISSAN MICRA - MARCH

	E0184	562614F725		E0185	5626147B01
	ESTICADOR DA BARRA ESTABILIZADORA DA FRENTE NISSAN MICRA K11 TT (1993 A 1997)			ESTICADOR DA BARRA ESTABILIZADORA DE TRÁS NISSAN MICRA K11 TT (1993 A 1997)	
	120x30x35mm	2p-d10-26mm		120x30x30xx	2p-d10-21mm
	E0186	54618AX600			
	ESTICADOR DA BARRA ESTABILIZADORA DA FRENTE NISSAN MICRA K12 TT				
	275x30x35mm	2p-d10-22mm			

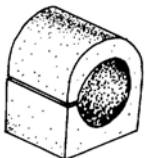

	E0074	54616-B9700K		T0021	54613-14900
	ESTICADOR DE BARRA ESTABILIZADORA NISSAN PICK-UP 720 SD23			BATENTE DA BARRA ESTABILIZADORA NISSAN DATSUN PICK-UP 620 - NISSAN DATSUN PICK-UP 720	
	d33x210mm	d25mm		40x38x32mm	1f-d21mm
	T1106	54613-88G00		T1106	54613-88G00
	BATENTE DA BARRA ESTABILIZADORA DA FRENTE NISSAN PICK-UP 720			BATENTE DA BARRA ESTABILIZADORA DA FRENTE NISSAN SAFARI	
	52x38x37mm	1f-d24mm		52x38x37mm	1f-d24mm

NISSAN PICK-UP (D21) - (D22) - (D23) - BIGM - KING - HARDBODY - NAVARA



	E0190	54618-01G00		T0041	54613-W1410
	ESTICADOR DA BARRA ESTABILIZADORA NISSAN D21 PICK-UP (DE 84 A94)			BATENTE DA BARRA ESTABILIZADORA DO CENTRO NISSAN PICK-UP D21 4x2 e 4x4	
	d34x210mm	d26mm		37x32x28mm	1f-d22mm
	T1084	54613-32G00		T1104	54613-43G00
	BATENTE DA BARRA ESTABILIZADORA DA FRENTE E CENTRO NISSAN D21 4WD			BATENTE DA BARRA ESTABILIZADORA NISSAN D21	
	46x39x38mm	1f-d20mm		53x38x37	1f-d22mm
	T1104	54613-43G00			
	BATENTE DA BARRA ESTABILIZADORA NISSAN KING-CAB				
	53x38x37	1f-d22mm			

NISSAN PRIMERA

	E0150	56261-86J25			
	ESTICADOR DA BARRA ESTABILIZADORA DE TRÁS NISSAN PRIMERA				
	155x38x38mm	2p-d10-27mm			

	L3024	55193-50A00		T1113	54612-60Y00
	CASQUILHO DA BARRA ESTABILIZADORA TRÁS (PONTAS) NISSAN SUNNY B12 - B13 - N13 (DE 1986 A 1990)			BATEENTE DA BARRA ESTABILIZADORA NISSAN SUNNY (B14)	
	d41x34mm	1f-d20mm		47x39x40mm	1f-d27,5mm

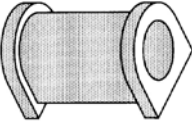

NISSAN TERRANO - X-TRAIL

	T0031	54613-88G00		T1104	54612-43G00
	BATEENTE DA BARRA ESTABILIZADORA NISSAN TERRANO II			BATEENTE DA BARRA ESTABILIZADORA NISSAN TERRANO I WD21 (1986 A 1995)	
	55x40x38mm	1f-d25mm		53x38x37	1f-d22mm

NISSAN URVAN - E23 - E24

	T1085	5461301N00			
	BATEENTE DA BARRA ESTABILIZADORA NISSAN URVAN E24 (1986 2001)				
	47x42x37mm	1f-d24mm			

OPEL ASTRA F



	E0085	350261		E0128	350263
	ESTICADOR DA PONTA BARCA ESTABILIZADORA DA FRENTE (BARRA DE 18MM) OPEL ASTRA (F) 1.4 - 1.4 16v - 1.6 - 1.6 16v - 1.7D - 1.7TD - 1.8 - 1.8 16v - 2.0 - 2.0 16v (1991 ATÉ 1998)			ESTICADOR DA BARRA ESTABILIZADORA DA FRENTE OPEL ASTRA (F) TT	
	110x40x35mm			105x34x34mm	1p-d12-25mm
	E0147	350260			
	ESTICADOR DA BARRA ESTABILIZADORA DA FRENTE OPEL ASTRA (F) TT				
	100x50x35mm	1f-d21mm 1p-d8-28mm			

	E0163	350611			
	ESTICADOR DA BARRA ESTABILIZADORA DA FRENTE				
	OPEL ASTRA (G) TT				
	340x37x37mm	2p-d12-25mm			

OPEL CALIBRA

	E0128	350263		T1049F24	447869 - 0350125	
	ESTICADOR DA BARRA ESTABILIZADORA DA FRENTE			BATENTE DO CENTRO DA BARRA ESTABILIZADORA		
	OPEL CALIBRA (A) 2.0i - 2.0i 16v - 2.0i 16v 4x4 - 2.5i V6			OPEL CALIBRA (A) 2.0i (06-1990 A 09-1997)		
	105x34x34mm	1p-d12-25mm		40x47x40mm	1f-d22mm	

OPEL CAMPO

	E0078	8-94223-156		T1033	8-94459-459-1	
	ESTICADOR DAS PONTAS DA BARRA ESTABILIZADORA FRENTE			BATENTE DA BARRA ESTABILIZADORA (CENTRO)		
	OPEL CAMPO			OPEL CAMPO		
	d32x45mm	d25mm		42x38x38mm	1f-d25mm	

OPEL CORSA A

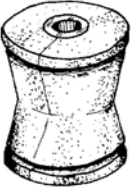
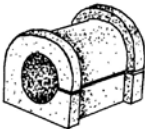
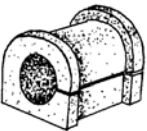
	S1072	402643		T0038F16	90168602 - 350109	
	SILENT-BLOC DO ESTABILIZADOR			BATENTE DE ESTABILIZADOR FURO 17 mm		
	OPEL CORSA A 1.0 - 1.2 - 1.3 - 1.4 - 1.5D - 1.5TD (1982 A 1993)			OPEL CORSA A 1.0 - 1.2 - 1.3 (1982 A 1993)		
	d52x65mm	d39mm 1f-d10mm		40x37x34mm	1f-17mm	
	T0038F19					
	BATENTE DE ESTABILIZADOR FURO 19 mm					
	OPEL CORSA A 1.0 - 1.2 - 1.3 (1982 A 1993)					
	40x37x34mm	1f-19mm				

OPEL CORSA B

Rafri, Lda.

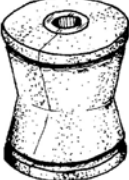
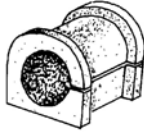
	BB24	350376		S1072	402643
	ABRAÇADEIRA DE BARRA ESTABILIZADORA OPEL CORSA B (APÓS 1993)			SILENT-BLOC DO ESTABILIZADOR OPEL CORSA B 1.0i - 1.2i - 1.4i - 1.5D - 1.5TD - 1.7D (1992 A 2000)	
	73x29x30mm	2p-d8-23mm		d52x65mm	d39mm 1f-d10mm
	T0039	350127 - 90447946			
	BATENTE DO CENTRO DA BARRA ESTABILIZADORA OPEL CORSA B 1.0i - 1.2i - 1.4i - 1.5D - 1.5TD - 1.7D (1993 A 2000)				
	40x37x34mm	1f-d21mm			

OPEL CORSA C

	E0129	350610		T1019	350104
	ESTICADOR DA BARRA ESTABILIZADORA DA FRENTE OPEL CORSA C TT			BATENTE DA BARRA ESTABILIZADORA FRENTE OPEL CORSA C 1.0 - 1.2 (APÓS 2000) (BARRA DE 15mm)	
	285x36x36mm	2p-d12-25mm		45x55x53mm	1f-d15mm

OPEL CORSA

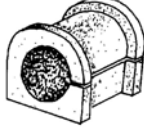
	T0039	350127 - 90447946		
	BATENTE DO CENTRO DA BARRA ESTABILIZADORA OPEL COMBO 1.7D (07-1994 A 10-2001)			
	40x37x34mm	1f-d21mm		

OPEL KADETT (A) - (B) - (C) - (D) - (E)



	E0085	350261		E0128	350263
	ESTICADOR DA PONTA BARCA ESTABILIZADORA DA FRENTE (BARRA DE 18MM) OPEL KADETT (E) 1.4S - 1.7D (1988 A 1994)			ESTICADOR DA BARRA ESTABILIZADORA DA FRENTE OPEL KADETT (E) 1.4S - 1.7D (1989 A 1993)	
	110x40x35mm			105x34x34mm	1p-d12-25mm

	E0147	350260		
	ESTICADOR DA BARRA ESTABILIZADORA DA FRENTE			
OPEL KADETT (E) 1.4S - 1.7D				
100x50x35mm	1f-d21mm 1p-d8-28mm			

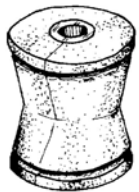
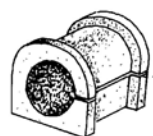
OPEL TIGRA

	S1072	402643		T0039	350127 - 90447946
	SILENT-BLOC DO ESTABILIZADOR			BATENTE DO CENTRO DA BARRA ESTABILIZADORA	
OPEL TIGRA 1.4 16v - 1.6 16v (1994 A 2000)		OPEL TIGRA 1.4i 16v - 1.6i 16v (1994 A 2000)			
d52x65mm	d39mm 1f-d10mm	40x37x34mm	1f-d21mm		

OPEL VECTRA A

	E0085	350261		E0128	350263
	ESTICADOR DA PONTA BARCA ESTABILIZADORA DA FRENTE (BARRA DE 18MM)			ESTICADOR DA BARRA ESTABILIZADORA DA FRENTE	
OPEL VECTRA (A) 1.4S - 1.6i - 1.7D - 1.7TD - 1.8i - 1.8s - 2.0i - 2.0i 16v		OPEL VECTRA A 1.4S - 1.6i - 1.7D - 1.7TD - 1.8 - 1.8S 4x4 - 2.0 - 2.0i 4x4 - 2.5CD - 2.5 V6 (1988 A 1995)			
110x40x35mm		105x34x34mm	1p-d12-25mm		
	T1049F24	90447869 - 350125			
	BATENTE DO CENTRO DA BARRA ESTABILIZADORA				
OPEL VECTRA A 1.4S - 1.6i - 1.7D - 1.7TD - 1.8S - 2.0 - 2.5 V6 (1988 A 1995)					
40x47x40mm	1f-d22mm				

OPEL VECTRA B

	E0129	350610		
	ESTICADOR DA BARRA ESTABILIZADORA DA FRENTE			
OPEL VECTRA B 1.6i - 1.6i 16v - 1.7 TD - 1.8i 16v - 2.0 DI 16v - 2.0 DTI 16v - 2.0i - 2.0i 16v - 2.2DTi 16v - 2.5i V6 - 2.6i V6 (1995 A 2002)				
285x36x36mm	2p-d12-25mm			

OPEL VECTRA

Rafpi, Lda.

	E0147	350260		
	ESTICADOR DA BARRA ESTABILIZADORA DA FRENTE			
	OPEL VECTRA (A) TT			
	100x50x35mm	1f-d21mm 1p-d8-28mm		

OPEL ZAFIRA

	E0163	350611		T1076	350093
	ESTICADOR DA BARRA ESTABILIZADORA DA FRENTE			BATENTE DA BARRA ESTABILIZADORA FRENTE	
	OPEL ZAFIRA TT (1999 A 2005)			OPEL ZAFIRA (APÓS 1999) 1.6 - 1.8 - 2.0 - 2.0 DTI APÓS Y2168372 (BARRA DE 23mm)	
	340x37x37mm	2p-d12-25mm		40x41x36mm	1f-d20mm
	T1077	350140			
	BATENTE DA BARRA ESTABILIZADORA FRENTE				
	OPEL ZAFIRA (APÓS 1999) 1.6 - 1.8 - 2.0 - 2.0 DTI APÓS Y2168371 (BARRA DE 24mm)				
	40x42x35mm	1f-d21mm			

PEUGEOT



	L1041	5181.06		
	CASQUILHO DA BARRA ESTABILIZADORA (TODOS)			
	PEUGEOT			
	d30x20mm	1f-d9mm		

PEUGEOT 104

	BB12			KB2069	
	ABRAÇADEIRA DA BARRA ESTABILIZADORA			KIT DA BARRA ESTABILIZADORA	
	PEUGEOT 104			PEUGEOT 104	
	79x52x40mm				



	T1008			
	BATENTE DE ESTABILIZADOR			
	PEUGEOT 104			
	43x38x43mm	1f-d-22mm		

PEUGEOT 106

	BB10	95632726			BB11	509734	
	ABRAÇADEIRA DA BARRA ESTABILIZADORA				ABRAÇADEIRA DA BARRA ESTABILIZADORA		
	PEUGEOT 106				PEUGEOT 106		
	65x38x30mm	2f-d10mm			85x50x43mm		
	E0131	508740			T0029		
	ESTICADOR DA BARRA ESTABILIZADORA DA FRENTE				BATENTE DA BARRA ESTABILIZADORA		
	PEUGEOT 106 TT APÓS 05-1995 - 406 TT APÓS CH:07664				PEUGEOT 106		
	340x40x40mm	2p-d12-35mm			34x31x25mm	1f-d19mm	
	T1023	5094.57			T1032	509459	
	BATENTE DA BARRA ESTABILIZADORA FURO 21mm				BATENTE BARRA ESTABILIZADORA (FURO 18mm) (PONTAS)		
	PEUGEOT 106				PEUGEOT 106		
	56x41x41mm	1f-d21mm			73x34x33mm	1f-d18mm	
	T1047	509458					
	BATENTE DA BARRA ESTABILIZADORA DA FRENTE						
	PEUGEOT 106						
	54x42x35mm	1f-d19mm					

PEUGEOT 107

	E0160				
	ESTICADOR DA BARRA ESTABILIZADORA DA FRENTE				
	PEUGEOT 107 TT (APÓS 06-2005)				
	100x33x31mm	2p-d8mm			

	BB04	5097.27		E0145	508732
	ABRAÇADEIRA DA BARRA ESTABILIZADORA PEUGEOT 205 - 309			ESTICADOR DA BARRA ESTABILIZADORA DA FRENTE PEUGEOT 205 1.6 - 1.9 Gti	
	73x53x28mm	2p-d10-25mm		350x45x40mm	1p-d10-30mm 1p-d10-24mm
	E0145	508732		KB2065	
	ESTICADOR DA BARRA ESTABILIZADORA DA FRENTE PEUGEOT 309 1.8D - TD - 1.9D - 1.9 GTI			KIT DA BARRA ESTABILIZADORA (DIÂMETRO 20) PEUGEOT 205 - GTi - 309 1.1 - 1.3 - 1.4 - 1.6 DIESEL - 1.7 - 1.9 TURBODIESEL	
	350x45x40mm	1p-d10-30mm 1p-d10-24mm			
	KB2066			KB2067	
	KIT DA BARRA ESTABILIZADORA (DIÂMETRO 22) PEUGEOT 205 GL - GR - GT 954 - 1118 - 1124 - 1294 - 1360 - 1442 - 1580 - 1592 - 309 1.1 - 1.3 - 1.4 - 1.6 DIESEL - 1.7 - 1.9 TURBO DIESEL			KIT DA BARRA ESTABILIZADORA (DIÂMETRO 23) PEUGEOT 205 D - TD - 309 1.1 - 1.3 - 1.4 - 1.6 DIESEL - 1.7 - 1.9 TURBO DIESEL	
	T0052-P	5094.36		T0053-P	5094.37 - 91516332
	BATENTE DA BARRA ESTABILIZADORA DA SUSPENSÃO FRENTE FURO 20mm PEUGEOT 205 GTI - 309 (1.1 - 1.3 - 1.4 - 1.6) - DIESEL - TURBO DIESEL (1.7 - 1.9)			BATENTE DA BARRA ESTABILIZADORA DA SUSPENSÃO FRENTE FURO 22mm (VERDE) PEUGEOT 205 GASOLINA GL - GR - GT - (954 - 118 - 1124 - 1294 - 1360 - 1442 - 1580 - 1592)	
	54x38x32mm	1f-d18mm		55x38x32mm	1f-d20mm
	T0053-P	5094.37 - 91516332		T0054-P	5094.40 - 91539592
	BATENTE DA BARRA ESTABILIZADORA DA SUSPENSÃO FRENTE FURO 22mm (VERDE) PEUGEOT 309 (1.1 - 1.3 - 1.4 - 1.6) - DIESEL - TURBO DIESEL (1.7 - 1.9)			BATENTE DA BARRA ESTABILIZADORA DA SUSPENSÃO FRENTE FURO 23mm (AZUL) PEUGEOT 205 D - TD - 309 (1.1 - 1.3 - 1.4 - 1.6) - DIESEL - TURBO DIESEL (1.7 - 1.9)	
	55x38x32mm	1f-d20mm		55x38x32mm	1f-23mm

PEUGEOT 206

	E0142	508745		
	ESTICADOR DA BARRA ESTABILIZADORA DA FRENTE PEUGEOT 206 TT			
	370x40x40mm	2p-d10-25mm		

	E0180	508754		E0181	508755
	ESTICADOR DA BARRA ESTABILIZADORA DA FRENTE LADO ESQUERDO PEUGEOT 207 1.4 - 1.4 16V - 1.4 HDI (APÓS 02-2006)			ESTICADOR DA BARRA ESTABILIZADORA DA FRENTE LADO DIREITO PEUGEOT 207 1.4 - 1.4 16V - 1.4 HDI (APÓS 02-2006)	
	360x35x35mm	2p-d10-24mm		360x35x35mm	2p-d10-24mm

PEUGEOT 305

	T1022F22	5094.34		
	BATENTE DA BARRA ESTABILIZADORA FURO 22mm PEUGEOT 305			
	60x50x46mm	1f-d22mm		



PEUGEOT 306

	E0140	508742		
	ESTICADOR DA BARRA ESTABILIZADORA DA FRENTE PEUGEOT 306 TT			
	340x40x40mm	2p-d10-27mm		



PEUGEOT 307

	E0133	508750		
	ESTICADOR DA BARRA ESTABILIZADORA DA FRENTE PEUGEOT 307 TT			
	370x40x40mm	2p-d4-25mm		

PEUGEOT 404

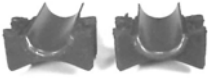

	L0004	5094.01 - 5094.02		T0004		
	CASQUILHO DA BARRA ESTABILIZADORA			BATENTE DA BARRA ESTABILIZADORA		
	PEUGEOT 404 (L - LD - GL - GLD - S.W.)			PEUGEOT 404 FURO 22 M-M		
	d28x18mm	d25mm 1f-d18mm		40x31x24mm	1f-d23mm	

PEUGEOT 405

	E0134	508727		T1022F20	5094.35	
	ESTICADOR DA BARRA ESTABILIZADORA DA FRENTE			BATENTE DA BARRA ESTABILIZADORA		
	PEUGEOT 405 TT			PEUGEOT 405 3305D 1.4		
	200x35x30mm	1f-d12mm 1r-d12mm		58x50x38mm	1f-d20mm	
	T1022F22	5094.34				
	BATENTE DA BARRA ESTABILIZADORA FURO 22mm					
	PEUGEOT 405					
	60x50x46mm	1f-d22mm				

PEUGEOT 406

	E0130	508748		E0136	517838	
	ESTICADOR DA BARRA ESTABILIZADORA DA FRENTE			ESTICADOR DA BARRA ESTABILIZADORA DE TRÁS		
	PEUGEOT 406 TT APÓS CH:07665			PEUGEOT 406 TT		
	355x34x34mm	2p-d12-30mm		200x40x40mm	2p-d10-26mm	
	T1112	517242 - 517238		T1114	517239 - 517243	
	BATENTE DA BARRA ESTABILIZADORA DE TRÁS			BATENTE DA BARRA ESTABILIZADORA DE TRÁS		
	PEUGEOT 406 1.6 (11-1995 A 05-2004) - 1.8 (05-1997 A 10-2004) 1.8 BREAK (05-1997 A 10-2004) - 1.8 (16V) (11-1995 A 05-2004) - 1.8 (16V) BREAK (10-1996 A 10-2004) - 1.9 TD (01-1996 A 05-2004) - 1.9 TD BREAK (10-1996 A 10-2004)			PEUGEOT 406 1.6 - 1.8 - 1.8 BREAK - 1.8 16V - 1.8 16V BREAK - 1.9 TD - 1.9 TD BREAK (1995 A 2004)		
	55x40x46mm	1f-d17-21mm		65x40x46mm	1f-d17/22mm	

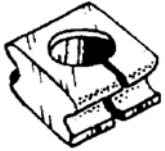
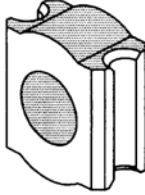
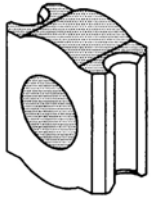
	E0144	508735		L0004	5094.01 - 5094.02
	ESTICADOR DA BARRA ESTABILIZADORA DA FRENTE PEUGEOT 806 TT			CASQUILHO DA BARRA ESTABILIZADORA PEUGEOT 504 (L - LD - GL - GLD - S.W.)	
	120x40x40mm	1p-d12-25mm 1f-d12mm		d28x18mm	d25mm 1f-d18mm
	T0004			T0005	5094.09
	BATENTE DA BARRA ESTABILIZADORA PEUGEOT 504 FURO 22 M-M			BATENTE DA BARRA ESTABILIZADORA PEUGEOT 504	
	40x31x24mm	1f-d23mm		45x44x23mm	1f-d25mm
	T0005	5094.09			
	BATENTE DA BARRA ESTABILIZADORA PEUGEOT 505				
	45x44x23mm	1f-d25mm			

PEUGEOT BOXER

	E0089	508737		E0089-C	508737
	ESTICADOR DA BARRA ESTABILIZADORA DA FRENTE PEUGEOT BOXER TT - BOXER (MOD.2002) 2.0 - BOXER (MOD.2002) 2.8 Hdi			ESTICADOR DA BARRA ESTABILIZADORA DA FRENTE PEUGEOT BOXER TT - BOXER (MOD. 2002) 2.0 - 2.8 HDi	
	155x42x35mm	1f-d14mm		155x35x43mm	1f-d14mm 1p-d12-23mm

PEUGEOT EXPERT - 807 - R4

	E0144	508735			
	ESTICADOR DA BARRA ESTABILIZADORA DA FRENTE PEUGEOT EXPERT TT				
	120x40x40mm	1p-d12-25mm 1f-d12mm			

PEUGEOT J5



Rafri, Lda.

	L3054	4339248		
	CASQUILHO DAS PONTAS DA BARRA ESTABILIZADORA			
	PEUGEOT J5			
	d48x25mm	1f-d21mm		



PEUGEOT PARTNER - RANCH

	E0143	508734		
	ESTICADOR DA BARRA ESTABILIZADORA DA FRENTE			
	PEUGEOT RANCH - PARTNER TT			
	330x35x35mm	2p-d10-25mm		

RENAULT









	KB2069			KB2071	
	KIT DA BARRA ESTABILIZADORA			KIT DA BARRA ESTABILIZADORA (Diâmetro 12mm)	
	RENAULT R14			RENAULT R14 - R6 - F4 - F6	
	T1005				
	BATENTE DE ESTABILIZADOR				
	RENAULT				
	75x38x32mm	1f-d12mm 1f-d13mm			

RENAULT 12

	E0070	7701453465		T1018	7700765935 - 7700503438
	ESTICADOR DE BARRA ESTABILIZADORA			BATENTE DE ESTABILIZADOR	
	RENAULT R12 - R18 (ATÉ 81)			RENAULT R12	
	185x47x42mm	1f-d14mm		42x34x24mm	1f-d14mm

	BB13	7700774895		KB2064	
	ABRAÇADEIRA DA BARRA ESTABILIZADORA RENAULT R19			KIT DA BARRA ESTABILIZADORA (DIÂMETRO 23) RENAULT R19	
65x50x35mm					
	T0042	7700785788		T1006F23	
	BATENTE CENTRAL DA BARRA ESTABILIZADORA DA SUSPENSÃO FRENTE FURO 21mm RENAULT R19 TT - CLIO TT			BATENTE DAS PONTAS DA BARRA ESTABILIZADORA (FURO 23 mm) RENAULT R19 - R21	
55x43x34mm		1f-d18mm	57x46x42mm		1f-d23mm
	T1007	7700771562		T1011	7700784170A
	BATENTE LATERAL DA BARRA ESTABILIZADORA DA SUSPENSÃO FRENTE FURO 21mm RENAULT R19 TT - R21 - TXE - TD			BATENTE DA BARRA ESTABILIZADORA PONTAS RENAULT 19 TT	
68x46x34mm		1f-21mm	59x47x40mm		1f-d20mm

RENAULT R21 - NEVADA





	BB05	7700774027		BB05	7700774027
	ABRAÇADEIRA DA BARRA ESTABILIZADORA RENAULT NEVADA DIESEL			ABRAÇADEIRA DA BARRA ESTABILIZADORA RENAULT R21	
95x45x30mm			95x45x30mm		
	BB06	7700771569 - 7700771568		BB06	7700771569 - 7700771568
	ABRAÇADEIRA DA BARRA ESTABILIZADORA RENAULT NEVADA			ABRAÇADEIRA DA BARRA ESTABILIZADORA RENAULT R21	
74x52x35mm			74x52x35mm		
	BB07	7700771569 - 7700771568		BB07	7700771569 - 7700771568
	ABRAÇADEIRA DA BARRA ESTABILIZADORA RENAULT NEVADA			ABRAÇADEIRA DA BARRA ESTABILIZADORA RENAULT R21	
71x52x33mm			71x52x33mm		
	BB08	7700757109		BB08	7700757109
	ABRAÇADEIRA DA BARRA ESTABILIZADORA RENAULT NEVADA GASOLINA			ABRAÇADEIRA DA BARRA ESTABILIZADORA RENAULT R21	
82x50x30mm			82x50x30mm		

RENAULT R21 - NEVADA

Pafpi, Lda.

	KB2061			KB2062	
KIT DA BARRA ESTABILIZADORA RENAULT 21 - NEVADA GASOLINA			KIT DA BARRA ESTABILIZADORA RENAULT 21 - NEVADA DIESEL		
	T0043	7700769226		T1006F16	7700789412
BATENTE CENTRAL DA BARRA ESTABILIZADORA DA SUSPENSÃO FRENTE RENAULT R21 TXE - TD			BATENTE DAS PONTAS DA BARRA ESTABILIZADORA - FURO 16mm RENAULT R21		
45x45x35mm	1f-d22mm		54x47x41mm	1f-16mm	
	T1006F22	7700760264		T1009	7700774026
BATENTE LATERAL DA BARRA ESTABILIZADORA DA SUSPENSÃO FRENTE FURO 22mm RENAULT R21 TS - GTS - TSE			BATENTE DE ESTABILIZADOR RENAULT 21		
54x47x41mm	1f-d22mm		70x54x46mm	1f-d23mm	
	T1064	7700769226			
BATENTE BARRA ESTABILIZADORA RENAULT 21 NEVADA DIESEL					
45x45x38mm	1f-d22mm				

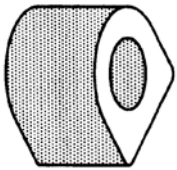
RENAULT 4

	BB02	608132700		KB2057	
ABRACADEIRA DA BARRA ESTABILIZADORA RENAULT R4 - R6			KIT DA BARRA ESTABILIZADORA (Diâmetro 10mm c/ tubo comprido) RENAULT R4 - R6 - F4 - F6		
80x28x25mm					
	KB2070			T0001	6082687
KIT DA BARRA ESTABILIZADORA (Diâmetro 10mm) RENAULT R4 - R6 - F4 - F6			BATENTE DA BARRA ESTABILIZADORA RENAULT R4 - L - TL - GTL - FURGÃO (845 - 1108)		
			30x30x20mm	1f-d16mm	
	T1000	7700687374 - 7702003408		T1004	7702106144
BATENTE DE BARRA ESTABILIZADORA FURO 12 mm RENAULT R4 - L - TL - GTL - FURGÃO (845 - 1108) - R5 TT - R6 TT			BATENTE LATERAL DA BARRA ESTABILIZADORA DA SUSPENSÃO TRÁS (FURO 10mm) RENAULT R4 - L - TL - GTL - FURGÃO (845 - 1108)		
71x39x33mm	1f-d12mm 1f-d10mm		77x39x29mm	1f-d10mm 1f-d10mm	

	BB01	7700680098		BB01	7700680098
	ABRAÇADEIRA DA BARRA ESTABILIZADORA RENAULT R9 - R11 - R19			ABRAÇADEIRA DA BARRA ESTABILIZADORA RENAULT SUPER5	
	79x28x20mm			79x28x20mm	
	BB03	7700680097		BB03	7700680097
	ABRAÇADEIRA DA BARRA ESTABILIZADORA RENAULT R9 - R11 - R19			ABRAÇADEIRA DA BARRA ESTABILIZADORA RENAULT SUPER5	
	74x35x22mm			74x35x22mm	
	KB2063			T0020-A	7700798053
	KIT DA BARRA ESTABILIZADORA (DIÂMETRO 21) RENAULT R9 - R11 - SUPER5			BATENTE DA BARRA ESTABILIZADORA (FURO 20mm) RENAULT R11 - R19	
				40x40x33mm	1f-d20mm
	T1006F23			T1099-I	
	BATENTE DAS PONTAS DA BARRA ESTABILIZADORA (FURO 23 mm) RENAULT SUPER5			BATENTE DE ESTABILIZADOR RENAULT SUPER5 - R9 - 11	
	57x46x42mm	1f-d23mm		45x39x32mm	1f-d21mm

RENAULT CLIO

	BB01	7700680098		BB03	7700680097
	ABRAÇADEIRA DA BARRA ESTABILIZADORA RENAULT CLIO			ABRAÇADEIRA DA BARRA ESTABILIZADORA RENAULT CLIO	
	79x28x20mm			74x35x22mm	
	KB2063			KB2250	
	KIT DA BARRA ESTABILIZADORA (DIÂMETRO 21) RENAULT CLIO			KIT DA BARRA ESTABILIZADORA RENAULT CLIO	
	S1200	7700799404		T1006F22	7700760264
	SILENT-BLOC DA BARRA ESTABILIZADORA RENAULT CLIO			BATENTE LATERAL DA BARRA ESTABILIZADORA DA SUSPENSÃO FRENTE FURO 22mm RENAULT CLIO TT	
	d26x74mm			54x47x41mm	1f-d22mm

	T1006F23			
	BATEMTE DAS PONTAS DA BARRA ESTABILIZADORA (FURO 23 mm) RENAULT CLIO			
	57x46x42mm	1f-d23mm		

RENAULT ESPACE



	E0141	7700805494		
	ESTICADOR DA BARRA ESTABILIZADORA DA FRENTE RENAULT ESPACE TT - LAGUNA I TT			
	370x35x40mm	1p-d10-28mm 1p-d10-30mm		

RENAULT EXPRESS - RAPID



	BB01	7700680098		BB03	7700680097
	ABRACADEIRA DA BARRA ESTABILIZADORA RENAULT EXPRESS			ABRACADEIRA DA BARRA ESTABILIZADORA RENAULT EXPRESS	
	79x28x20mm			74x35x22mm	
	KB2063			T0016	7700760265
	KIT DA BARRA ESTABILIZADORA (DIÁMETRO 21) RENAULT EXPRESS			BATEMTE LATERAL DA BARRA ESTABILIZADORA DA SUSPENSÃO FRENTE FURO 20mm RENAULT EXPRESS	
				58x45x42mm	1f-d18mm
	T0018	7700763934		T0020	7700763934 - 77021444561
	BATEMTE CENTRAL DA BARRA ESTABILIZADORA RENAULT EXPRESS			BATEMTE CENTRAL DA BARRA ESTABILIZADORA DA SUSPENSÃO FRENTE RENAULT EXPRESS (CENTRO - GRANDE)	
	40x35x35mm	1f-d20mm		44x37x33mm	1f-d22mm

	E0162	820002870		
	ESTICADOR DA BARRA ESTABILIZADORA DA FRENTE			
	RENAULT LAGUNA II TT			
	315x35x35mm	2d-d10-25mm		

RENAULT MASTER

	E0138	7700309070		E0139	7700309071
	ESTICADOR DA BARRA ESTABILIZADORA DA FRENTE LADO ESQUERDO			ESTICADOR DA BARRA ESTABILIZADORA DA FRENTE LADO DIREITO	
	RENAULT MASTER I 2.1D - 2.5D - 2.8 DTi DE 1980 (ATÉ 07-1998) - MASTER II 2.1D - 2.5D - 2.8 DTi (APÓS 07-1998)			RENAULT MASTER I 2.1D - 2.5D - 2.8 DTi DE 1980 (ATÉ 07-1998) - MASTER II 2.1D - 2.5D - 2.8 DTi (APÓS 07-1998)	
	160x40x40mm	2p-d10-30mm		160x40x40mm	2p-d10-28mm

RENAULT MEGANE - SCENIC

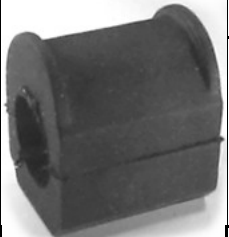





	E0234	8200166159		E0234	8200166159
	ESTICADOR DA BARRA ESTABILIZADORA DA FRENTE			ESTICADOR DA BARRA ESTABILIZADORA DA FRENTE	
	RENAULT MEGANE II 1.4 16V (APÓS 11-2002) - 1.5 Dci (APÓS 11-2002) - 1.6 16V (APÓS 11-2002) - 1.9 Dci (APÓS 11-2002) - 2.0 (APÓS 09-2003) - 2.0 16V (APÓS 11-2002)			RENAULT SCÉNIC II 1.4 (APÓS 06-2003) - 1.5 Dci (APÓS 11-2003) - 1.6 (APÓS 06-2003) - 1.6 16V (APÓS 01-2007) - 1.9 Dci (APÓS 06-2003)	
	310x33x35mm	2p-d10-27mm		310x33x35mm	2p-d10-27mm
	T1048	7700835929			
	BATENTE DO CENTRO DA BARRA ESTABILIZADORA				
	RENAULT MEGANE				
	46x34x42mm	1f-d22mm			

RENAULT MODUS

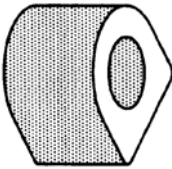
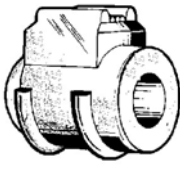

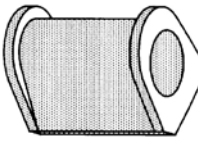
	E0235	8200127308		
	ESTICADOR DA BARRA ESTABILIZADORA DA FRENTE			
	RENAULT MODUS 1.2 (APÓS 12-2004) - 1.4 (APÓS 12-2004) - 1.5 Dci (APÓS 05-2005) - 1.6 (APÓS 12-2004)			
	275x34x33mm	2p-d10-22mm		

RENAULT R5

Rafri, Lda.

	T0001	6082687		T0016	7700760265
	BATENTE DA BARRA ESTABILIZADORA RENAULT R5 TT			BATENTE LATERAL DA BARRA ESTABILIZADORA DA SUSPENSÃO FRENTE FURO 20mm RENAULT R5 - SUPER5 TT	
	30x30x20mm	1f-d16mm		58x45x42mm	1f-d18mm
	T0018	7700763934		T0020	7700763934 - 77021444561
	BATENTE CENTRAL DA BARRA ESTABILIZADORA RENAULT R5 - R9 - SUPER5 - R11			BATENTE CENTRAL DA BARRA ESTABILIZADORA DA SUSPENSÃO FRENTE RENAULT R5 - R9 - R11	
	40x35x35mm	1f-d20mm		44x37x33mm	1f-d22mm
	T1001	7702107985		T1002	7702107984
	BATENTE LATERAL DA BARRA ESTABILIZADORA TRÁS (FURO 10mm) RENAULT R5			BATENTE LATERAL DA BARRA ESTABILIZADORA TRÁS (FURO 10mm) RENAULT R5	
	78x51x39mm	1f-d9mm 1f-d10mm		73x38x51mm	1f-d10mm 1f-d8mm
	T1003	7702106143			
	BATENTE LATERAL DA BARRA ESTABILIZADORA TRÁS (FURO 10mm) RENAULT R5				
	73x38x39mm	1f-d10mm 1f-d8mm			

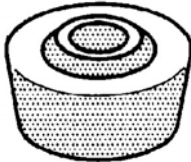
RENAULT TRAFIC

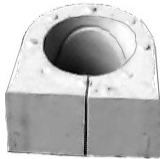
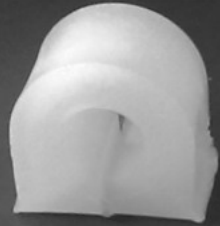
	E0162	8200002870		L1055	
	ESTICADOR DA BARRA ESTABILIZADORA DA FRENTE RENAULT TRAFIC 1.7 - 2.1D - 2.2 (DE 06-1986 ATÉ 10-1997)			CASQUILHO DA BARRA ESTABILIZADORA RENAULT TRAFIC	
	315x35x35mm	2d-d10-25mm		d30x27mm	d26mm 1f-d9mm
	T1010	7700001091		T1012	7700667186
	BATENTE DE ESTABILIZADOR RENAULT TRAFIC			BATENTE CENTRAL DA BARRA ESTABILIZADORA RENAULT TRAFIC	
	90x55x30mm	1f-d21mm 1f-d12mm		41x37x25mm	1f-d26mm
	T1054	7700667182			
	BATENTE DA BARRA ESTABILIZADORA RENAULT TRAFIC				
	38x36x24mm	1f-d16mm			

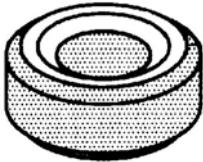
	L1011	HB-15624400 - SE127156244A		
	CASQUILHO DO BRAÇO DA SUSPENSÃO (PONTAS DA BARRA ESTABILIZADORA)			
	SEAT 127 - FURA TT - MARBELLA TT			
	d34x21mm	1f-d16mm		



SEAT ALHAMBRA

	E0107	7M0411317D		T1096	7M0511414A
	ESTICADOR DA BARRA ESTABILIZADORA DA FRENTE			BATENTE DA BARRA ESTABILIZADORA DE TRÁS LADO LATERAL	
	SEAT ALHAMBRA TT			SEAT ALHAMBRA APÓS 1995 1.8T - 2.0 - 2.8 V6 - 1.9 TDI	
	245x35x35mm	2p-d12-25mm		d35x30mm	1f-d21mm

SEAT AROSA

	E0146			E0233	6N0411315A
	ESTICADOR DA BARRA ESTABILIZADORA DA FRENTE			ESTICADOR DA BARRA ESTABILIZADORA DA FRENTE	
	SEAT AROSA 1.4 TDi, 1.7 SDi			SEAT AROSA 1.4 16V (05-1997 A 06-2004)	
	82x30x30mm	1p-d10-18mm 1f-d8mm		97x40x29mm	1f-d18mm

SEAT CORDOBA - MALAGA



	E0072	191411315A		E0092	6Q0411315C - 6Q0411315F
	ESTICADOR DA BARRA ESTABILIZADORA			ESTICADOR DA BARRA ESTABILIZADORA DA FRENTE	
	SEAT CORDOBA			SEAT CORDOBA TT (APÓS 2002)	
	105x40x40mm	1f-d16mm		310x36x36mm	2p-d10-23mm

SEAT IBIZA

Rafri, Lda.

	E0071	191411327		E0072	191411315A
	ESTICADOR DE BARRA ESTABILIZADORA (PONTAS) SEAT IBIZA			ESTICADOR DA BARRA ESTABILIZADORA SEAT IBIZA	
	d40x94mm	1f-d15mm		105x40x40mm	1f-d16mm
	E0092	6Q0411315C - 6Q0411315F			
	ESTICADOR DA BARRA ESTABILIZADORA DA FRENTE SEAT IBIZA II - III TT (APÓS 1993)				
	310x36x36mm	2p-d10-23mm			

SEAT LEON

	E0182	1J0411315H		T1093	1J0411314T - 1J0411314G
	ESTICADOR DA BARRA ESTABILIZADORA DA FRENTE SEAT LEON APÓS (CH:F1M1035001) 1.4 16V - 1.6 - 1.8 20V - 1.8 20V T - APÓS (CH: F1M1035001) - 1.6 16V (APÓS CH:F1M1035001) - 1.9 SDI - 1.9 TDI (90 -110 CV) (APÓS CH:F1M1035001) - 1.9 TDI (150 CV) - TOLEDO II 1.4 16V (APÓS 07 -1999) - 1.6 (04 -1999 A 09 -2000) - 1.6 16V			BATENTE DA BARRA ESTABILIZADORA DA FRENTE SEAT LEON (1M1) 1.4 16V - 1.6 - 1.8 20V - 1.8 20V T - 1.8 20V T4 - 1.9 SDi - 1.9 TDi - APÓS 11 -1999 - 1.6 16V APÓS 09 -2000 - 2.8 CUPRA 4 - APÓS 02 -01 - TOLEDO II (1M2) 1.4 16V - 1.6 - 1.8 20V - 1.9 TDi - 2.3 V5 - APÓS 04 -1999 - 1.6 16V - APÓS 09 -2000	
	150x45x30mm	2f-d10mm		37x36x25mm	1f-d20mm
	T1094	1J0411314C			
	BATENTE DA BARRA ESTABILIZADORA DA FRENTE SEAT LEON (1M1) 1.4 16V - 1.6 - 1.6 16V - 1.8 20V - 1.8 20V T - 1.8 20V T4 - 1.9 SDi - 1.9 TDi - 2.8 CUPRA 4 APÓS 11 -99				
	37x36x25mm	1f-d20mm			

SEAT ALTEA - ALTEA XL - TOLEDO

	E0071	191411327		E0072	191411315A
	ESTICADOR DE BARRA ESTABILIZADORA (PONTAS) SEAT TOLEDO			ESTICADOR DA BARRA ESTABILIZADORA SEAT TOLEDO TDI	
	d40x94mm	1f-d15mm		105x40x40mm	1f-d16mm
	E0168	1K0505465K		E0169	1K0411315D
	ESTICADOR DA BARRA ESTABILIZADORA DE TRÁS SEAT ALTEA TT, LEON TT			ESTICADOR DA BARRA ESTABILIZADORA DA FRENTE SEAT ALTEA TT	
	130x33x35mm	1p-d10-35mm 1f-d10mm		365x35x35mm	2p-d12-26mm

	T1020F17	191411314		
	BATEENTE DA BARRA ESTABILIZADORA			
	SEAT TOLEDO			
	35x35x32mm	1f-d17mm		

SEAT TOLEDO (2)

	T1094	1J0411314C		
	BATEENTE DA BARRA ESTABILIZADORA DA FRENTE			
	SEAT TOLEDO II(1M2) 1.4 16V - 1.6 - 1.6 16V - 1.8 20V - 1.9 TDi - 2.3 V5 - 2.3 V5 20V APÓS 04 -99			
	37x36x25mm	1f-d20mm		

SKODA FABIA

	E0092	6Q0411315C - 6Q0411315F		
	ESTICADOR DA BARRA ESTABILIZADORA DA FRENTE			
	SKODA FABIA TT			
	370x36x36mm	2p-d10-23mm		

SKODA OCTAVIA

	E0095	1J0411316D		E0096	1J0411315D
	ESTICADOR DA BARRA ESTABILIZADORA DA FRENTE LADO DIREITO			ESTICADOR DA BARRA ESTABILIZADORA DA FRENTE LADO ESQUERDO	
	SKODA OCTAVIA TT (QUATTRO) APÓS 11/1999			SKODA OCTAVIA TT (QUATTRO) APÓS 11/1999	
	370x40x40mm	2p-d12d35mm		370x40x40mm	1p-d12-35mm
	E0168	1K0505465K		E0182	1J0411315H
	ESTICADOR DA BARRA ESTABILIZADORA DE TRÁS			ESTICADOR DA BARRA ESTABILIZADORA DA FRENTE	
	SKODA OCTAVIA TT			SKODA OCTAVIA (APÓS CH: F1U1471001 - F1U18438501 - F1U3A006219) - 1.4 16V (APÓS 09/2000) (APÓS CH:F1U1471001 - F1U18438501 - F1U3A006219) (102 CV) - 1.4 - 1.6 (101 CV) - 1.8T - 2.0 (APÓS 01/2001) - (APÓS CH:F1U1471001 - F1U18438501 - F1U3A006219) - 1.6	
	130x33x35mm	1p-d10-35mm 1f-d10mm		150x45x30mm	2f-d10mm

SUZUKI SWIFT

Rafpi, Lda.

	E0237	4242062J00		
	ESTICADOR DA BARAR ESTABILIZADORA DA FRENTE			
	SUZUKI SWIFT III 1.3 (APÓS 02-2005) - 1.3 DDiS (APÓS 08-2005) - 1.5 (APÓS 02-2005)			
	330x34x34mm	2p-d10-23mm		

SUZUKI VITARA

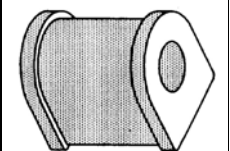
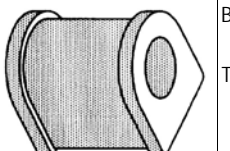

	T1066	46625-80000		
	BATENTE DO CENTRO DA BARRA ESTABILIZADORA DA FRENTE			
	SUZUKI VITARA SJ 410			
	44x39x39mm	1f-d22mm		

TALBOT SIMCA 1100

	T0006			T0007	
	BATENTE DA BARRA ESTABILIZADORA			BATENTE DA BARRA ESTABILIZADORA	
	TALBOT-SIMCA 1100 FURO L8M/M			TALBOT-SIMCA 1100	
	36x36x36mm	1f-d18mm		36x36x36mm	1f-d20mm

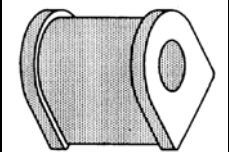
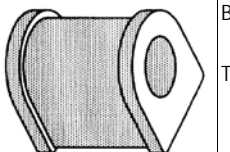
TALBOT HORIZON

	T0006			T0007	
	BATENTE DA BARRA ESTABILIZADORA			BATENTE DA BARRA ESTABILIZADORA	
	TALBOT-SIMCA HORIZON - FURO L8M/M			TALBOT-SIMCA HORIZON	
	36x36x36mm	1f-d18mm		36x36x36mm	1f-d20mm





	E0148	48802-60090		T1101	48815-60070
	ESTICADOR DA BARRA ESTABILIZADORA TOYOTA			BATENTE DA BARRA ESTABILIZADORA DA FRENTE TOYOTA	
	175x32x26mm	d14mm 1p-d8-15mm		40x47x42mm	1f-d29mm

TOYOTA COROLLA - SPRINTER - LEVIN



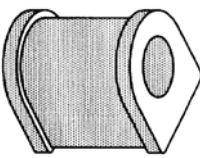
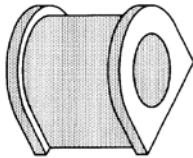

	E0151	48820-33010		E0152	48820-20010
	ESTICADOR DA BARRA ESTABILIZADORA DA FRENTE TOYOTA COROLLA AE101 - EE100			ESTICADOR DA BARRA ESTABILIZADORA DA FRENTE TOYOTA COROLLA EE90 - AE92	
	95x35x35	2p-d10-18mm		103x33x33mm	2p-d10-18mm
	E0159	48820-33010		T0011	48815-12040
	ESTICADOR DA BARRA ESTABILIZADORA DA FRENTE TOYOTA COROLLA (1992 A 1997) - EE101 - AE101 - AE100 - CE100 - AE103 - RAV 4 (1994 A 2000) - FUNCROISER			BATENTE DA BARRA ESTABILIZADORA TOYOTA COROLLA - KE20 - KE25 - E26	
	88x33x33mm	2p-d10-18mm		43x35x32mm	1f-d16mm
	T1027	48818-12160		T1039	48815-20050
	BATENTE DA BARRA ESTABILIZADORA TOYOTA COROLLA			BATENTE DA BARRA ESTABILIZADORA (CENTRO) TOYOTA COROLLA EE80 - CE90	
	36x36x34mm	1f-d14mm		39x39x36mm	1f-d22mm
	T1059	48815-12050		T1083	4881512220
	BATENTE DO CENTRO DA BARRA ESTABILIZADORA FRENTE TOYOTA COROLLA KE30			BATENTE DA BARRA ESTABILIZADORA DA FRENTE TOYOTA COROLLA EE100 - AE101	
	45x40x39mm	1f-d18mm		51x42x44mm	1f-d24mm

TOYOTA DYNA

	T1082	4881536012		
	BATENTE DA BARRA ESTABILIZADORA TOYOTA DYNA JK - BU10			
	43x47x38mm	1f-d22mm		

	E0077	90101-10090K		E0082	48819-26050
	ESTICADOR DA BARRA ESTABILIZADORA TOYOTA HIACE LH50 - LH51 - LH102 - LH112			ESTICADOR DA BARRA ESTABILIZADORA FRENTE TOYOTA HIACE LH112	
	d33x125mm	d25mm		d34x155mm	d25mm
	T0007			T0015	48815-26020
	BATEENTE DA BARRA ESTABILIZADORA (FURO 20mm) TOYOTA HIACE - LH 20			BATEENTE DA BARRA ESTABILIZADORA TOYOTA HIACE LH 50 - HIACE LH 51	
	37x37x36mm	1f-d20mm		45x42x40mm	1f-d26mm
	T0045	48815-26060			
	BATEENTE DA BARRA ESTABILIZADORA TOYOTA HIACE LH102				
	51x48x39mm	1f-d26mm			

TOYOTA HILUX

	E0076	90101-08038K - 48817-30010		E0189	48816-24101
	ESTICADOR DE BARRA ESTABILIZADORA TOYOTA HILUX LN 50 - LN 56 - LN 85 - LN 90			ESTICADOR DA BARRA ESTABILIZADORA TOYOTA HILUX 4X4	
	d33x160mm	d27mm		d33x175mm	d26mm
	T1037	48815-30050		T1040	48815-35060
	BATEENTE DA BARRA ESTABILIZADORA (CENTRO) TOYOTA HILUX LN56 - LAND CRUISER BJ40 - BJ75			BATEENTE BARRA ESTABILIZADORA CENTRO TOYOTA HILUX LN56	
	40x40x36mm	1f-d23mm		39x36x38mm	1f-d25mm
	T1061	48815-14160			
	BATEENTE DO CENTRO DA BARRA ESTABILIZADORA TOYOTA HILUX LN85 - LN86				
	39x39x35mm	1f-d23mm			

	E0149	48802-60030K		T1088	48815-6017D
	ESTICADOR DA BARRA ESTABILIZADORA TOYOTA LAND CRUISER			BATENTE DA BARRA ESTABILIZADORA TOYOTA LAND CRUISER	
	155x32x26mm	d14mm 1p-d8-15mm		48x43x40mm	1f-d30mm
	T1107	48815-42020		T1109	48815-30080
	BATENTE DA BARRA ESTABILIZADORA DA FRENTE TOYOTA RAV4			BATENTE DA BARRA ESTABILIZADORA TOYOTA HDJ80 - FZJ80 - HZJ80	
	39x38x40mm	1f-d24mm		40x39x39mm	1f-d24mm

TOYOTA STARLET - CROWN

	L3014	48817-30010 - 48817-30020		
	CASQUILHO DA BARRA ESTABILIZADORA TOYOTA STARLET EP70 - CROWN LS130			
	d26x20mm	1f-d8mm		







TOYOTA YARIS

	E0175	488200D010		
	ESTICADOR DA BARRA ESTABILIZADORA DA FRENTE TOYOTA YARIS TT (APÓS 2005)			
	395x35x35mm	2p-d12-20mm		



VOLKSWAGEN BEETLE

	E0182	1J0411315H		
	ESTICADOR DA BARRA ESTABILIZADORA DA FRENTE VOLKSWAGEN NEW BEETLE APÓS (CH:F1C1451001) TT			
	150x45x30mm	2f-d10mm		

VOLKSWAGEN BORA



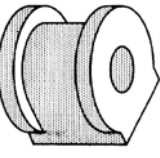

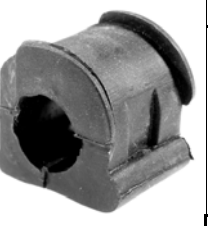
	E0093	1J0411315G		E0094	1J0411315C
	ESTICADOR DA BARRA ESTABILIZADORA DA FRENTE VOLKSWAGEN BORA TT APÓS 08-1997			ESTICADOR DA BARRA ESTABILIZADORA DA FRENTE VOLKSWAGEN BORA TT DE 1997 A 12-2001	
	140x35x35mm	1p-d10-25mm 1f-d10mm		145x37x37mm	1p-d10-25mm 1f-d10mm
	E0095	1J0411316D		E0096	1J0411315D
	ESTICADOR DA BARRA ESTABILIZADORA DA FRENTE LADO DIREITO VOLKSWAGEN BORA TT (QUATTRO) APÓS 2000			ESTICADOR DA BARRA ESTABILIZADORA DA FRENTE LADO ESQUERDO VOLKSWAGEN BORA TT (QUATTRO) APÓS 2000	
	370x40x40mm	2p-d12d35mm		370x40x40mm	1p-d12-35mm
	E0182	1J0411315H		T1093	1J0411314T - 1J0411314G
	ESTICADOR DA BARRA ESTABILIZADORA DA FRENTE VOLKSWAGEN BORA (APÓS CH:F1U1480001) TT			BATENTE DA BARRA ESTABILIZADORA DA FRENTE VOLKSWAGEN BORA (1J2) 1.4 16V - 1.6 - 1.6 16V - 1.6 FSi - 1.8 - 1.8 T - 1.9 SDi - 1.9 TDi - 2.0 - 2.3 V5 (APÓS 10-1998) - BORA COMBI (1J6) 1.4 16V - 1.6 - 1.6 16V - 1.6 FSi - 1.8 1.8 4 MOTION - 1.9 TDi - 1.9 TDi 4 MOTION - 2.0 - 2.0 4 MOTION - 2.3 V5 - 2.8 V6 (APÓS 05-1999)	
	150x45x30mm	2f-d10mm		37x36x25mm	
	T1094	1J0411314C			
	BATENTE DA BARRA ESTABILIZADORA DA FRENTE VOLKSWAGEN BORA (1J2) 1.4 16V - 1.6 - 1.6 16V - 1.6 FSi - 1.8 - 1.8 4 MOTION - 1.8 T - 1.9 SDi - 1.9 TDi - 1.9 TDi 4 MOTION - 2.0 - 2.0 4 MOTION - 2.3 V5 - 2 - 3 V5 4 MOTION - 2.8 V6 4 MOTION - APÓS 10-98 GOLF IV (1J1) 1.4 16V - 1.6 - 1.6 16V - 1.6 FSi - 1.8 - 1.8 4 MOTION - 1.8T - 1.8T GTi -				
	37x36x25mm	1f-d20mm			

VOLKSWAGEN GOLF

	T0022			T1020F17	191411314
	BATENTE DA BARRA ESTABILIZADORA VOLKSWAGEN GOLF			BATENTE DA BARRA ESTABILIZADORA VOLKSWAGEN GOLF	
	38x36x29mm	1f-d14mm			
	T1020-	1H0411314			
	BATENTE DA BARRA ESTABILIZADORA VOLKSWAGEN GOLF				
	34x35x31mm	1f-d18mm			

	E0072	191411315A		
	ESTICADOR DA BARRA ESTABILIZADORA			
	VOLKSWAGEN GOLF III			
	105x40x40mm	1f-d16mm		

VOLKSWAGEN GOLF 4

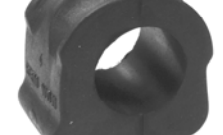

	E0093	1J0411315G		E0094	1J0411315C
	ESTICADOR DA BARRA ESTABILIZADORA DA FRENTE			ESTICADOR DA BARRA ESTABILIZADORA DA FRENTE	
	VOLKSWAGEN GOLF IV TT APÓS 08-1997			VOLKSWAGEN GOLF IV TT DE 08-1997 A 12-2001	
	140x35x35mm	1p-d10-25mm 1f-d10mm		145x37x37mm	1p-d10-25mm 1f-d10mm
	E0095	1J0411316D		E0096	1J0411315D
	ESTICADOR DA BARRA ESTABILIZADORA DA FRENTE LADO DIREITO			ESTICADOR DA BARRA ESTABILIZADORA DA FRENTE LADO ESQUERDO	
	VOLKSWAGEN GOLF IV TT (QUATTRO) APÓS 08-1997			VOLKSWAGEN GOLF IV TT (QUATTRO) APÓS 08-1997	
	370x40x40mm	2p-d12d35mm		370x40x40mm	1p-d12-35mm
	E0182	1J0411315H		T1093	1J0411314T - 1J0411314G
	ESTICADOR DA BARRA ESTABILIZADORA DA FRENTE			BATENTE DA BARRA ESTABILIZADORA DA FRENTE	
	VOLKSWAGEN GOLF IV (APÓS 08-97) TT			VOLKSWAGEN GOLF IV (1J1) 1.4 16V - 1.6 - 1.6 16V - 1.6 FSi - 1.8 - 1.8 4 MOTION - 1.8 T - 1.8T GTi - 1.9 SDi 1.9 TDi - 1.9 TDi 4 MOTION - 2.0 - 2.0 4 MOTION - 2.3 V5 - 2.8 V6 - APÓS 08-1997 - GOLF IV VARIANT (1J5) TT APÓS 05-1999	
	150x45x30mm	2f-d10mm		37x36x25mm	

VOLKSWAGEN GOLF 5 - TOURAN

	E0168	1K0505465K		E0169	1K0411315D
	ESTICADOR DA BARRA ESTABILIZADORA DE TRÁS			ESTICADOR DA BARRA ESTABILIZADORA DA FRENTE	
	VOLKSWAGEN GOLF V TT			VOLKSWAGEN GOLF V TT	
	130x33x35mm	1p-d10-35mm 1f-d10mm		365x35x35mm	2p-d12-26mm

VOLKSWAGEN JETTA

Rafpi, Lda.

	T1020F17	191411314		T1020-	1H0411314
	BATEENTE DA BARRA ESTABILIZADORA VOLKSWAGEN JETTA			BATEENTE DA BARRA ESTABILIZADORA VOLKSWAGEN JETTA	
			34x35x31mm 1f-d18mm		

VOLKSWAGEN JETTA (3)

	E0168	1K0505465K			
	ESTICADOR DA BARRA ESTABILIZADORA DE TRÁS VOLKSWAGEN JETTA (MOD. 3) TT (APÓS 08-2005)				
130x33x35mm 1p-d10-35mm 1f-d10mm					

VOLKSWAGEN LT - LT28 - L35

	T1017	2D0498101			
	BATEENTE DA BARRA ESTABILIZADORA DA FRENTE VOLKSWAGEN L35				
41x31x30mm 1f-d23mm					

VOLKSWAGEN LUPO





	E0146	6E0411315		E0233	6N0411315A
	ESTICADOR DA BARRA ESTABILIZADORA DA FRENTE VOLKSWAGEN LUPO 1.2 TDi - 1.4 TDi - 1.7 SDi			ESTICADOR DA BARRA ESTABILIZADORA DA FRENTE VOLKSWAGEN LUPO 1.0 - 1.4 16V (08-1999 A 07-2005)	
82x30x30mm 1p-d10-18mm 1f-d8mm			97x40x29mm 1f-d18mm		

	E0080	357411315C		E0081	357411315D
	ESTICADOR DA BARRA ESTABILIZADORA VOLKSWAGEN PASSAT (1988 A 1993)			ESTICADOR DA BARRA ESTABILIZADORA VOLKSWAGEN PASSAT (1993 A 1995)	
	105x51x35mm	1fd19mm		105x51x35mm	1f-d21mm
	T1029	823411313A		T1029	823411313A
	BATENTE DA BARRA ESTABILIZADORA (CENTRO) VOLKSWAGEN PASSAT			BATENTE DA BARRA ESTABILIZADORA (CENTRO) VOLKSWAGEN SANTANA	
	42x39x24mm	1f-d12mm		42x39x24mm	1f-d12mm

VOLKSWAGEN PASSAT (1)

	T1086	823411327B		
	BATENTE DA BARRA ESTABILIZADORA DA FRENTE VOLKSWAGEN PASSAT 1 (1978 A 1985) - PASSAT 2 (1988 A 1996)			
	34x24x30mm	1f-d18mm		

VOLKSWAGEN PASSAT (3)

	E0090	8A0505466C - 8D0505466		E0091	8A0505465C - 8D0505465
	ESTICADOR DA BARRA ESTABILIZADORA DE TRÁS LADO DIREITO VOLKSWAGEN PASSAT III TT (QUATTRO) (APÓS 08-1996)			ESTICADOR DA BARRA ESTABILIZADORA DE TRÁS LADO ESQUERDO VOLKSWAGEN PASSAT III TT (QUATTRO) (APÓS 08-1996)	
	265x36x36mm	1p-d10-28mm		265x35x35mm	1p-d10-28mm 1f-d10mm
	E0098	8D0411318D		E0099	8D0411317D
	ESTICADOR DA BARRA ESTABILIZADORA DA FRENTE VOLKSWAGEN PASSAT III TT (APÓS 08-1996)			ESTICADOR DA BARRA ESTABILIZADORA DA FRENTE VOLKSWAGEN PASSAT III TT (APÓS 08-1996)	
	125x70x37mm	2f-d10mm		130x75x38mm	2f-d10mm
	E0168	1K0505465K			
	ESTICADOR DA BARRA ESTABILIZADORA DE TRÁS VOLKSWAGEN PASSAT III TT (APÓS 08-1996)				
	130x33x35mm	1p-d10-35mm 1f-d10mm			

VOLKSWAGEN POLO

Rafri, Lda.

	E0071	191411327		E0073	6N04111315
	ESTICADOR DE BARRA ESTABILIZADORA (PONTAS) VOLKSWAGEN POLO			ESTICADOR DE BARRA ESTABILIZADORA VOLKSWAGEN POLO 4T.T. (1995 A 2000) - 1.0 - 1.3 - 1.4 - 1.4 Tdi - 1.6 - 1.9D - 1.9SDi	
	d40x94mm	1f-d15mm		95x40x40mm	1f-16mm
	T0022			T1016	6N0411314
	BATENTE DA BARRA ESTABILIZADORA VOLKSWAGEN POLO			BATENTE DA BARRA ESTABILIZADORA DA FRENTE VOLKSWAGEN POLO	
	38x36x29mm	1f-d14mm		70x40x35mm	

VOLKSWAGEN POLO (3)

	E0233	6N0411315A		
	ESTICADOR DA BARRA ESTABILIZADORA DA FRENTE VOLKSWAGEN POLO III 1.4 16V (1995 A 2000)			
	97x40x29mm	1f-d18mm		

VOLKSWAGEN POLO (4)

	E0092	6Q0411315C - 6Q0411315F		
	ESTICADOR DA BARRA ESTABILIZADORA DA FRENTE VOLKSWAGEN POLO IV (MOD.2002) TT			
	310x36x36mm	2p-d10-23mm		

VOLKSWAGEN SHARAN



	E0107	7M0411317D		T1096	7M0511414A
	ESTICADOR DA BARRA ESTABILIZADORA DA FRENTE VOLKSWAGEN SHARAN TT			BATENTE DA BARRA ESTABILIZADORA DE TRÁS LADO LATERAL VOLKSWAGEN SHARAN APÓS 1995 - LUPO APÓS 1997	
	245x35x35mm	2p-d12-25mm		d35x30mm	1f-d21mm

	E0168	1K0505465K		E0169	1K0411315D
	ESTICADOR DA BARRA ESTABILIZADORA DE TRÁS VOLKSWAGEN TOURAN TT			ESTICADOR DA BARRA ESTABILIZADORA DA FRENTE VOLKSWAGEN TOURAN TT	
	130x33x35mm	1p-d10-35mm 1f-d10mm		365x35x35mm	2p-d12-26mm

VOLKSWAGEN TRANSPORTER (T2) - (T4) - (5)

	E0109	7D0411049		E0110	701411049B
	ESTICADOR DA BARRA ESTABILIZADORA DA FRENTE VOLKSWAGEN TRANSPORTER T4 TT DE 1991 A 1996			ESTICADOR DA BARRA ESTABILIZADORA DA FRENTE VOLKSWAGEN TRANSPORTER T4 TT DE 1991 A 1996	
	150x41x41mm	1f-d14mm 1f-d18mm		150x42x32mm	1p-d12-25mm 1f-d14mm
	E0179	7H0411317		L3101	7D0411945
	ESTICADOR DA BARRA ESTABILIZADORA DA FRENTE VOLKSWAGEN TRANSPORTER V (APÓS 04-03) TT			CASQUILHO DA BARRA ESTABILIZADORA VOLKSWAGEN TRANSPORTER	
	300x40x40mm	2p-d12-30mm		d40x29mm	d36mm 1f-d24mm 1f-d19mm
	T1092	701411041			
	BATENTE DA BARRA ESTABILIZADORA DA FRENTE PARTE DO CENTRO VOLKSWAGEN TRANSPORTER IV AUTOCARRO (70XB - 70XC - 7DB - 7DW) 1.8 12-90A 07-92 - 1.9 D - 2.0 - 2.4 D APÓS 9-90 - 1.9 TD - 2.4 D SYNCRO - APÓS 10-92 - 2.5 - 2.5 SYNCRO APÓS 11-92 - 2.5 TDi APÓS 9-95 - TRANSPORTERIV CAIXA (70XA) 1.9 D - 2.0 - 2.4 D - APÓS				
	37x37x30mm	1f-d21mm			

VOLKSWAGEN VENTO

	T1020F17	191411314		T1020-	1H0411314
	BATENTE DA BARRA ESTABILIZADORA VOLKSWAGEN VENTO			BATENTE DA BARRA ESTABILIZADORA VOLKSWAGEN VENTO	
				34x35x31mm	1f-d18mm

VOLVO SÉRIES S40 - V40

	E0170	30714466		E0178	8623576
	ESTICADOR DA BARRA ESTABILIZADORA DE TRÁS			ESTICADOR DA BARRA ESTABILIZADORA DA FRENTE	
	VOLVO S40 II TT			VOLVO S40 II TT	
	100x50x40mm	2p-d10-22-30mm		325x30x35mm	2p-d10-22mm

VOLVO SÉRIES-V50

	E0170	30714466		E0178	8623576
	ESTICADOR DA BARRA ESTABILIZADORA DA FRENTE			ESTICADOR DA BARRA ESTABILIZADORA DA FRENTE	
	VOLVO V50 TT			VOLVO V50 TT	
	100x50x40mm	2p-d10-22-30mm		325x30x35mm	2p-d10-22mm