





	M6098 NO. 1418382650 - 1418360A10 - 1418360A11 - 1418382601		Z80779 NO. 09409073085PK
	JUNTA DE ESCAPE SUZUKI TT d59x16mm 1f-d45mm		Mola de fixação SUZUKI (TODOS) d15x21mm 1p-d7-13mm
	Z80780 NO. 09409073255PK		
	Mola de fixação SUZUKI (TODOS) d16x23mm 1p-d9-12mm		

SUZUKI ALTO

	E0018 NO. 17565-15010		F1275-I NO. 44119-70B10 - 44119-84110
	ESTICADOR DE ESCAPE SUZUKI ALTO (APÓS 81) 68x54x25mm NULL		FOLE DA TRANSMISSÃO JUNTO À CAIXA SUZUKI ALTO II 0.8 (1986 A 1993) d67x85mm 1f-d58mm 1f-d18mm
	F1820-I NO. 44119-80E01 - 44119M72F11 - 44119M79F00		M6019 NO. 18302SB2000 - 1418260B00 - 1418278110 - 1418282000
	FOLE DA TRANSMISSÃO JUNTO À CAIXA SUZUKI ALTO IV 1.1i (APÓS 2002) d85x88mm 1f-d73mm 1f-d19mm		JUNTA DE ESCAPE SUZUKI ALTO (APÓS 1986) d51x4mm 1f-d43.6mm

SUZUKI BALENO

	M6008 NO. 141846G00		Z9011 NO. 1449282600
	JUNTA DE ESCAPE SUZUKI BALENO (APÓS 1995) d65x5mm 1f-d50mm		MOLA DE ESCAPE SUZUKI BALENO (APÓS 1995) d23x42mm NULL

	E0018	NO. 17565-15010		E0018	NO. 17565-15010
	ESTICADOR DE ESCAPE SUZUKI CARRY (APÓS 86) - SUPER CARRY (APÓS 85)			ESTICADOR DE ESCAPE SUZUKI SK410 (APÓS 85) - ST 90 - SJ410 (APÓS 82) - SJ413 (84 A 88) - SK408 (86 A 87)	
68x54x25mm		NULL	68x54x25mm		NULL



SUZUKI CULTUS

	F1275-I	NO. 44119-70B10 - 44119-84110		
	FOLE DA TRANSMISSÃO JUNTO À CAIXA SUZUKI CULTUS 1.0 - 1.3 (1983 A 1986)			
d67x85mm		1f-d58mm 1f-d18mm		

SUZUKI FRONTE

	F1236-I	NO. 44119.78010 - 44119.78011		
	FOLE DA TRANSMISSÃO JUNTO À CAIXA SUZUKI FRONTE 550 CH. Nº 201.0 (5-1979 A 8-1980) (E SS30-E SS40)			
d80x77mm		1f-d67mm 1f-d19mm		

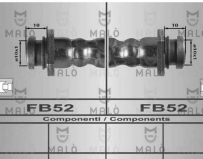

SUZUKI GRAND VITARA

	A1958	NO. 2965083001		A1958	NO. 2965083001
	APOIO TRÁS AUXILIAR CAIXA SUZUKI GRAND VITARA I (FT, HT) 1.6 4x4 (SQ 416) 03.98 - 07.03 69 94 1590 Veículo todoterreno fechado SUZUKI GRAND VITARA I (FT, HT) 2.0 4x4 (TA52, TL52, SQ 420) 03.98 - 07.03 94 128 1995 Veículo todoterreno fechado SUZUKI GRAND VITARA I (FT, HT) 2.5 V6 24V 4x4 (SQ 625) 04.01 - 07.03 116 158 2493 Veículo todoterreno fechado SUZUKI GRAND VITARA I (FT, HT) 2.5 V6 24V 4x4 (TD62, SQ 625) 04.98 - 07.03 106 144 2493 Veículo todoterreno fechado SUZUK...etc.			APOIO TRÁS AUXILIAR CAIXA SUZUKI GRAND VITARA II (JT, TE, TD) 1.6 Tração integral (JB416) 04.05 - 78 106 1586 Veículo todoterreno fechado SUZUKI GRAND VITARA II (JT, TE, TD) 2.0 Tração integral (TD54, JB420) 10.05 - 02.15 103 140 1995 Veículo todoterreno fechado SUZUKI GRAND VITARA II (JT, TE, TD) 2.4 Tração integral (JT424, JB424) 01.09 - 122 166 2393 Veículo todoterreno fechado SUZUKI GRAND VITARA II (JT, TE, TD) 2.4 Tração integral (JB424) 01.09 - 124 16...etc.	
50x39x30mm		2p-d10x20mm	50x39x30mm		2p-d10x20mm
	RT80230	NO. 5157060A30		RT80280	NO. 5156065D00
	TUBO DE TRAVÃO DA FRENTE LH-RH SUZUKI GRAND VITARA I (FT - HT) 1.6 4x4 (SQ 416) (03.98 A 07.03) 94cv 1590cc Veículo todo-terreno - fechado SUZUKI GRAND VITARA I (FT - HT) 2.0 4x4 (SQ 420) (03.98 A 07.03) 128cv 1995cc Veículo todo-terreno fechado - SUZUKI GRAND VITARA I (FT - HT) 2.5 V6 24V 4x4 (SQ 625) (04.98 A 07.03) 144cv 2493cc Veículo todo-terreno fechado - SUZUKI GRAND VITARA I (FT - HT) 2.7 4x4 (JA 627) (09.01 A 07.03) 173cv 2736cc Veículo todo-terreno fechado - ...etc.			TUBO DE TRAVÃO DE TRÁS LH-RH SUZUKI GRAND VITARA I (FT - HT) 1.6 4x4 (SQ 416) (03.98 A 07.03) 94cv 1590cc Veículo todo-terreno fechado - SUZUKI GRAND VITARA I (FT - HT) 2.0 4x4 (SQ 420) (03.98 A 07.03) 128cv 1995cc Veículo todo-terreno fechado - SUZUKI GRAND VITARA I (FT - HT) 2.5 V6 24V 4x4 (SQ 625) (04.98 A 07.03) 144cv 2493cc Veículo todo-terreno fechado - SUZUKI GRAND VITARA I (FT - HT) 2.5 V6 24V 4x4 (SQ 625) (04.01 A 07.03) 158cv 2493cc Veículo todo-terreno fec...etc.	
210mm		FB52 - OR2	257mm		FB52 - FB52



	<p>RT80601 NO. 5154065D00</p> <p>TUBO DE TRAVÃO FRENTE RH</p> <p>SUZUKI GRAND VITARA TT (FT - GT) (APÓS 03-1998)</p> <p>EF305 OR33 Component / Components</p> <p>775mm EF305 - OR33</p>		<p>RT80602 NO. 5155065D00</p> <p>TUBO DE TRAVÃO FRENTE LH</p> <p>SUZUKI GRAND VITARA TT (FT - GT) (APÓS 03-1998)</p> <p>EF304 OR33 Component / Components</p> <p>775mm EF304 - OR33</p>
	<p>RT80691 NO. 5155065J00 - 5155065J00000</p> <p>TUBO DE TRAVÃO DA FRENTE LH</p> <p>SUZUKI GRAND VITARA II (JT - TE - TD) 1.6 Tração integral (JB416) (APÓS 04.05) 106cv 1586cc Veículo todo-terreno fechado - SUZUKI GRAND VITARA II (JT - TE - TD) 2.0 Tração integral (JB420) (10.05 A 02.15) 140cv 1995cc Veículo todo-terreno fechado - SUZUKI GRAND VITARA II (JT - TE - TD) 2.4 Tração integral (JB424) (APÓS 01.09) 166cv 2393cc Veículo todo-terreno fechado - SUZUKI GRAND VITARA II (JT - TE - TD) 2.4 Tração integral ...etc.</p> <p>535mm FB52 - OR203</p>		<p>RT80692 NO. 5154065J00 - 5154065J00000</p> <p>TUBO DE TRAVÃO DA FRENTE LH</p> <p>SUZUKI GRAND VITARA II (JT - TE - TD) 1.6 Tração integral (JB416) (APÓS 04.05) 106cv 1586cc Veículo todo-terreno fechado - SUZUKI GRAND VITARA II (JT - TE - TD) 2.0 Tração integral (JB420) (10.05 A 02.15) 140cv 1995cc Veículo todo-terreno fechado - SUZUKI GRAND VITARA II (JT - TE - TD) 2.4 Tração integral (JB424) (APÓS 01.09) 166cv 2393cc Veículo todo-terreno fechado - SUZUKI GRAND VITARA II (JT - TE - TD) 2.4 Tração integral ...etc.</p> <p>535mm FB52 - OR2</p>
	<p>RT80693 NO. 5158077K00 - 5158077K00000</p> <p>TUBO DE TRAVÃO DE TRÁS LH</p> <p>SUZUKI GRAND VITARA II (JT - TE - TD) 1.6 Tração integral (JB416) (APÓS 04.05) 106cv 1586cc Veículo todo-terreno fechado - SUZUKI GRAND VITARA II (JT - TE - TD) 2.0 Tração integral (JB420) (10.05 A 02.15) 140cv 1995cc Veículo todo-terreno fechado - SUZUKI GRAND VITARA II (JT - TE - TD) 2.4 Tração integral (JB424) (APÓS 01.09) 166cv 2393cc Veículo todo-terreno fechado - SUZUKI GRAND VITARA II (JT - TE - TD) 2.4 Tração integral ...etc.</p> <p>385mm FB52 - OR123</p>		<p>RT80694 NO. 5157077K00 - 5157077K00000</p> <p>TUBO DE TRAVÃO DE TRÁS RH</p> <p>SUZUKI GRAND VITARA II (JT - TE - TD) 1.6 Tração integral (JB416) (APÓS 04.05) 106cv 1586cc Veículo todo-terreno fechado - SUZUKI GRAND VITARA II (JT - TE - TD) 2.0 Tração integral (JB420) (10.05 A 02.15) 140cv 1995cc Veículo todo-terreno fechado - SUZUKI GRAND VITARA II (JT - TE - TD) 2.4 Tração integral (JB424) (APÓS 01.09) 166cv 2393cc Veículo todo-terreno fechado - SUZUKI GRAND VITARA II (JT - TE - TD) 2.4 Tração integral ...etc.</p> <p>385mm FB52 - OR129</p>

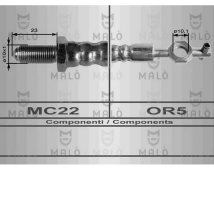
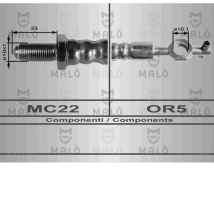
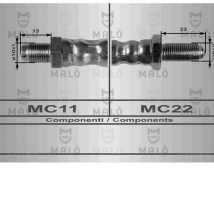
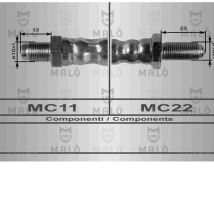
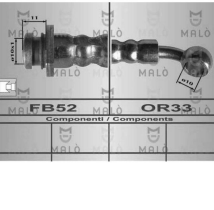





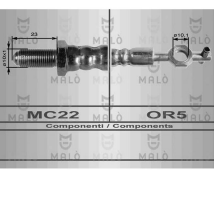
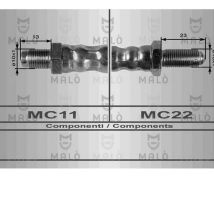
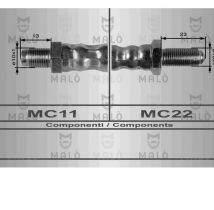

SUZUKI SAMURAI-SJ410-SJ413

	<p>A1485 NO. 42150-61040</p> <p>APOIO BATENTE DA MOLLA DE TRÁS</p> <p>SUZUKI SAMURAI - SJ410</p> <p>82x77x74mm NULL</p>		<p>A1486 NO. 42110-80000</p> <p>APOIO BATENTE DA MOLLA DA FRENTE</p> <p>SUZUKI SAMURAI - SJ410</p> <p>106x46x46mm NULL</p>
	<p>A1586 NO. 11710-80000 - 11710-80010 - 11710-80011 - 11710-76J00 - 45503-49075</p> <p>APOIO DA CAIXA DE VELOCIDADES</p> <p>SUZUKI SAMURAI - VITARA SJ 410 - SJ 413</p> <p>110x85x40mm NULL</p>		<p>A1771 NO. 29610-83001</p> <p>APOIO DO MOTOR PARTE DA FRENTE</p> <p>SUZUKI SAMURAI 1.3 TRACÇÃO INTEGRAL (SJ 413) (APÓS 11-1988) - 1.3 (SJ 413) (APÓS 11-1988)</p> <p>50x50x27mm 2p-d10-22mm</p>
	<p>A1958 NO. 2965083001</p> <p>APOIO TRÁS AUXILIAR CAIXA</p> <p>SUZUKI SAMURAI (SJ) 1.0 Tração integral (SJ 410) (11.88 A 12.04) 45cv 970cc Veículo todo terreno fechado - SUZUKI SAMURAI (SJ) 1.3 Tração integral (SJ 413) (11.88 A 12.04) 70cv 1298cc Veículo todo terreno fechado - SUZUKI SAMURAI (SJ) 1.3 Tração integral (SJ 413) (01.00 A 12.04) 80cv 1298cc Veículo todo terreno fechado - SUZUKI SAMURAI (SJ) 1.3 Tração integral (SJ 413) (11.88 A 12.04) 60cv 1324cc Veículo todo terreno fechad...etc.</p> <p>50x39x30mm 2p-d10x20mm</p>		<p>E0018 NO. 17565-15010</p> <p>ESTICADOR DE ESCAPE</p> <p>SUZUKI SAMURAI (APÓS 88)</p> <p>68x54x25mm NULL</p>
	<p>KM0412 NO. 4146277300K</p> <p>KIT DE BRINÇOS DAS MOLAS TRÁS E FRENTE (COMPOSTO POR 4 CASQUILHOS L3034)</p> <p>SUZUKI SJ410 - SJ413 - SAMURAI</p> <p>110x85x45mm 2p-d10-20mm</p>		<p>L3034 NO. 09305-13002</p> <p>CASQUILHO DAS MOLAS DE TRÁS E FRENTE (PARTE DE TRÁS)</p> <p>SUZUKI SAMURAI</p> <p>d37x32mm c23mm d29mm 1f-d13mm</p>

	<p>L3035 NO. 41331-62020</p> <p>CASQUILHO DAS MOLAS DE TRÁS E DA FRENTE OLHAL FIXO (PARTE DE TRÁS E DA FRENTE) SUZUKI SAMURAI</p>		<p>RT08514 NO. 51540C80150</p> <p>TUBO DE TRAVÃO FRENTE LH-RH</p> <p>SUZUKI SJ410 - SJ413 - SAMURAI - TT (ATÉ 09-1981)</p>
	<p>RT08514 NO. 51540C80150</p> <p>TUBO DE TRAVÃO FRENTE LH-RH</p> <p>SUZUKI SJ410 - SJ413 - SAMURAI - TT (ATÉ 09-1981)</p>		<p>RT08524 NO. 51580B80130 - 51580BB0130 - 5188080130</p> <p>TUBO DE TRAVÃO TRÁS LH-RH</p> <p>SUZUKI SJ410 - SJ413 - SAMURAI - TT (ATÉ 09-1981)</p>
	<p>RT08525 NO. 51570B83030 - 51570BB3030</p> <p>TUBO DE TRAVÃO INTERMÉDIO</p> <p>SUZUKI SJ410 - SJ413 - SAMURAI - TT (ATÉ 09-1981)</p>		<p>RT80229 NO. 5154080151</p> <p>TUBO DE TRAVÃO DA FRENTE LH-RH</p> <p>SUZUKI SJ 413 (OS) 1.3 (09.84 A 08.90) 64cv 1324cc Veículo todo-terreno fechado - SUZUKI SJ 413 (OS) 1.3 (SJ 413) (08.86 A 08.90) 60cv 1324cc Veículo todo-terreno fechado</p>
	<p>Z9011 NO. 1449282600</p> <p>MOLA DE ESCAPE</p> <p>SUZUKI SAMURAI (1988 A 1995) - SWIFT (1984 A 1996) - SJ (1984 A 1988) - SK410 (APÓS 1985)</p>		

SUZUKI SANTANA

	<p>RT08514 NO. 51540C80150</p> <p>TUBO DE TRAVÃO FRENTE LH-RH</p> <p>SUZUKI SANTANA</p>		<p>RT08524 NO. 51580B80130 - 51580BB0130 - 5188080130</p> <p>TUBO DE TRAVÃO TRÁS LH-RH</p> <p>SUZUKI SANTANA</p>
	<p>RT08525 NO. 51570B83030 - 51570BB3030</p> <p>TUBO DE TRAVÃO INTERMÉDIO</p> <p>SUZUKI SANTANA</p>		<p>S1243 NO. 09319-12023</p> <p>SILENT-BLOC MOLAS TRÁS E FRENTE</p> <p>SUZUKI SANTANA SJ413</p>

	A1760	NO. 41710-60B00		A1765	NO. 11620-71C10
	APOIO DA SUSPENSÃO DA FRENTE SUZUKI SWIFT (SF413) 1.3 (09-1991 A 10-1996) - SWIFT II (SF413 - AH35) 1.3 (03-1989 A 12-1991) - SWIFT II (SF416 - AH14) 1.6 (11-1989 A 12-1991) - SWIFT II (SF416 - AJ14) 1.6 4WD (11-1989 A 12-1991) - SWIFT II (SF416 - AH14) - 1.6i (01-1990 A 01-2005) - S			APOIO DO MOTOR LADO ESQUERDO SUZUKI SWIFT (SF413)	
130x70x40mm		1f-d12mm 3p-d8x23mm	100x85x50mm		2f-d10mm 1f-d10.4mm
	E0018	NO. 17565-15010		E0237	NO. 4242062J00
	ESTICADOR DE ESCAPE SUZUKI SWIFT (APÓS 84)			ESTICADOR DA BARRA ESTABILIZADORA DA FRENTE SUZUKI SWIFT III 1.3 (APÓS 02-2005) - 1.3 DDiS (APÓS 08-2005) - 1.5 (APÓS 02-2005)	
68x54x25mm		NULL	330x34x34mm		2p-d10-23mm
	F1273-I	NO. 4411982012 - 4411982350 - 4411982610 - 44119-82013 - 44119-86061		F1275-I	NO. 44119-70B10 - 44119-84110
	FOLE DA TRANSMISSÃO JUNTO À CAIXA SUZUKI SWIFT(1) 1.0 - 1.3 - 1.3i GTi - 1.3i GXi (1983 A 1989) - SWIFT(2) 1.0i - 1.3 - 1.3i GTi - 1.6 - 1.6i - 1.6i 4WD (APÓS 1989)			FOLE DA TRANSMISSÃO JUNTO À CAIXA SUZUKI SWIFT 1.0 (1983 A 1989)	
d82x82mm		1f-d62mm 1f-d20mm	d67x85mm		1f-d58mm 1f-d18mm
	M6019	NO. 18302SB2000 - 1418260B00 - 1418278110 - 1418282000		M6097	NO. 18205538000 - 18212634000
	JUNTA DE ESCAPE SUZUKI SWIFT (1984 A 1996)			JUNTA DE ESCAPE SUZUKI SWIFT (1990 A 1996)	
d51x4mm		1f-d43.6mm	d44x4mm		1f-d36mm
	Z80829	NO. 940907332 - 9046707164 - 71741883			
	NULL SUZUKI SWIFT				
d20x23.5mm		1p-d7.5-10.5mm			

SUZUKI VITARA

	A1485	NO. 42150-61040		A1486	NO. 42110-80000
	APOIO BATENTE DA MOLA DE TRÁS SUZUKI VITARA			APOIO BATENTE DA MOLA DA FRENTE SUZUKI VITARA	
82x77x74mm		NULL	106x46x46mm		NULL
	A1488	NO. 17610-80000 - 11610-80020 - 1161082C00000 - 11610-82C00		A1716	NO. 11910-60A03
	APOIO DO MOTOR FRENTE DIREITO E ESQUERDO SUZUKI VITARA CARIBIAN SJ 413			APOIO DO MOTOR PARTE DE TRÁS SUZUKI VITARA (APÓS 1996)	
110x73x45mm		2p-d10-23mm	90x75x105mm		1f-d12mm

	<p>A1758 NO. 11710-60A01 - 11710-60A00</p> <p>APOIO DO MOTOR PARTE DE TRÁS CAIXA VELOCIDADES</p> <p>SUZUKI VITARA L4 1.6 - 2.0 (1996 A 1998) - SUZUKI GRAND VITARA V6 2.5 - 2.7 (1989 A 1998)</p> <p>120x60x55mm 2f-d10mm</p>		<p>A1772 NO. 11610-58B01 - 11610-58B10</p> <p>APOIO DE MOTOR</p> <p>SUZUKI VITARA 1.6 (07-1988 A 03-1998) - 1.6 16V (07-1990 A 03-1998) - 1.9 D (01-1995 A 03-1998) - 2.0 16V (12-1996 A 03-1998) - 2.0 TD (12-1994 A 03-1998) - 2.0 TD INTERCOOLER (12-1995 A 03-1998) - 2.0 V6 24V (12-1994 A 03-1998) - 2.5 V6 24V (12-1995 A 03)</p> <p>108x65x57mm 2p-d10-26mm</p>
	<p>A1795 NO. 11610-67D00-000 - 11610-65D00-000</p> <p>APOIO DO MOTOR FRENTE LADO DIREITO E ESQUERDO</p> <p>SUZUKI VITARA (ET - TA) (12-1994 A 03-1998) 2.0 V6 24V 136CV (1998cc) TRAÇÃO INTEGRAL</p> <p>130x80x100mm 2p-d10x17mm 1p-d10x31mm</p>		<p>A1858 NO. 41810-60A00 - 41810-60A01 - 4181060A01000 - 4161060A00 - 30005938 - 4181077E00</p> <p>APOIO DO AMORTECEDOR DE TRÁS</p> <p>SUZUKI VITARA (ET - TA) 1.6 (TA - TA01) Tracção integral (07.88 A 03.98) 80CV 1589CC - SUZUKI VITARA (ET - TA) 1.6 (ET) Tracção integral (07.88 A 12.91) 82CV 1589CC - SUZUKI VITARA (ET - TA) 1.6 i 16V (ET - TA02) Tracção integral (07.90 A 03.98) 97CV 1589CC</p> <p>105x35mm 3p-d8x17mm 1f-d17,5mm</p>
	<p>A1950 NO. 11610-60A01 - 1161058B10000 - 11620-58B00 - 11610-51B00</p> <p>APOIO MOTOR FRENTE DIREITO ESQUERDO</p> <p>SUZUKI VITARA (ET, TA) 1.6 Tracção integral (TA, TA01, SE416) N.º de port as: 3 (07.88 A 03.98) 80cv 1590cc Veículo todo-terreno fechado - SUZUKI VITARA (ET, TA) 1.6 Tracção integral (SE 416) N.º de port as: 3 (07.88 A 12.91) 82cv 1589cc Veículo todo-terreno fechado - SUZUKI VITARA (ET, TA) 1.6 i 16V Tracção integral (ET, TA02, SE416) N.º de port as: 3 (07.90 A 03.98) 97cv 1590cc Veículo todo-terreno fechado - SUZUKI...etc.</p> <p>120x75x50mm 1p-d10x25mm 1p-d10x18mm</p>		<p>A1958 NO. 2965083001</p> <p>APOIO TRÁS AUXILIAR CAIXA</p> <p>SUZUKI VITARA (ET, TA) 1.6 Tracção integral (TA, TA01, SE416) (07.88 A 03.98) 80cv 1590cc Veículo todo terreno fechado - SUZUKI VITARA (ET, TA) 1.6 Tracção integral (SE 416) (07.88 A 12.91) 82cv 1589cc Veículo todo terreno fechado - SUZUKI VITARA (ET, TA) 1.6 i 16V Tracção integral (ET, TA02, SE416) (07.90 A 03.98) 97cv 1590cc Veículo todo terreno fechado 2 / 2 - SUZUKI VITARA (ET, TA) 2.0 16V Tracção integral (SV420) (12.96 A 03...etc.</p> <p>50x39x30mm 2p-d10x20mm</p>
	<p>E1072 NO. 14281-58B00</p> <p>ESTICADOR DE ESCAPE</p> <p>SUZUKI VITARA (APÓS 1995)</p> <p>77x55x23mm NULL</p>		<p>KF1636 NO. 44118-67D01</p> <p>KIT DE FOLE DO CARDAN LADO DA RODA</p> <p>SUZUKI VITARA 2.0 TDic - 2.5 Iv6</p> <p>d90x93mm 1f-d80mm 1f-d22mm</p>
	<p>KF1696 NO. 44118-67D01</p> <p>KIT DE FOLE DO CARDAN JUNTO À RODA</p> <p>SUZUKI VITARA 2.0 TDIC (88 A 89) - VITARA 2.5 i</p> <p>d93x87mm 1f-d78mm 1f-d20mm</p>		<p>KF3630 NO.</p> <p>KIT DE FOLE</p> <p>SUZUKI VITARA</p> <p>d60x86mm 1f-d54mm 1f-d18mm</p>
	<p>KF3683 NO. 44118-77E03</p> <p>KIT DE FOLE DO CARDAN LADO DA RODA</p> <p>SUZUKI VITARA (1988 A 1999) 1.6i - 1.9D - 2.0i - 2.0TD - 2.5i</p> <p>d95x90mm 1f-d74mm 1f-d21mm</p>		<p>KM0412 NO. 4146277300K</p> <p>KIT DE BRINCOS DAS MOLAS TRÁS E FRENTE (COMPOSTO POR 4 CASQUILHOS L3034)</p> <p>SUZUKI VITARA</p> <p>110x85x45mm 2p-d10-20mm</p>
	<p>L3034 NO. 09305-13002</p> <p>CASQUILHO DAS MOLAS DE TRÁS E FRENTE (PARTE DE TRÁS)</p> <p>SUZUKI VITARA</p> <p>d37x32mm c23mm d29mm 1f-d13mm</p>		<p>L3035 NO. 41331-62020</p> <p>CASQUILHO DAS MOLAS DE TRÁS E DA FRENTE OLHAL FIXO (PARTE DE TRÁS E DA FRENTE)</p> <p>SUZUKI VITARA</p> <p>d48x34mm c24mm d40mm 1f-d14,5mm</p>
	<p>M6019 NO. 18302SB2000 - 1418260B00 - 1418278110 - 1418282000</p> <p>JUNTA DE ESCAPE</p> <p>SUZUKI VITARA (1988 A 1991)</p> <p>d51x4mm 1f-d43,6mm</p>		<p>M6088 NO. 1418358B01 - 1418358B02</p> <p>JUNTA DE ESCAPE</p> <p>SUZUKI VITARA (APÓS 1995)</p> <p>d68x15mm 1f-d54mm</p>

 <p>FB52 OR28 Component / Components</p>	<p>RT08950 NO. 5154060A31 - 5154085C00</p> <p>TUBO DE TRAVÃO FRENTE RH</p> <p>SUZUKI VITARA TT (1988 (ATÉ 03-1999))</p>	 <p>EF300 OR33 Component / Components</p>	<p>RT08951 NO. 5155060A31 - 5155060A30 - 5155085C00</p> <p>TUBO DE TRAVÃO FRENTE LH-RH</p> <p>SUZUKI VITARA 2.0- 2.0 16V- 2.5 TD (-ABS) (01-1995 A 03-1999)</p>
 <p>EF300 OR33 Component / Components</p>	<p>RT08951 NO. 5155060A31 - 5155060A30 - 5155085C00</p> <p>TUBO DE TRAVÃO FRENTE LH</p> <p>SUZUKI VITARA TT (1988 (ATÉ 03-1999))</p>	 <p>FB52 FB52 Component / Components</p>	<p>RT08952 NO. 5156083031</p> <p>TUBO DE TRAVÃO TRÁS LH-RH</p> <p>SUZUKI VITARA TT (1988 A 03-1999)</p>
	<p>S1243 NO. 09319-12023</p> <p>SILENT-BLOC MOLAS TRÁS E FRENTE</p> <p>SUZUKI VITARA</p>		<p>S1299 NO. 09319-12032</p> <p>SILENT-BLOC DAS MOLAS TRÁS PARTE DA FRENTE</p> <p>SUZUKI VITARA SJ 410</p>
	<p>S1400 NO. 09319-12044 - 0931912044</p> <p>SILENT BLOC DO BRAÇO DA SUSPENSÃO DA FRENTE</p> <p>SUZUKI VITARA SE416</p>		<p>S1401 NO. 09319-14007 - 0931914007</p> <p>SILENT BLOC DO BRAÇO DA SUSPENSÃO DA FRENTE</p> <p>SUZUKI VITARA SE416</p>
	<p>S1490 NO. 09319-12045</p> <p>SILENT BLOC DO BRAÇO DA SUSPENSÃO DA FRENTE</p> <p>SUZUKI VITARA APÓS 1991</p>		<p>T1066 NO. 46625-80000</p> <p>BATENTE DO CENTRO DA BARRA ESTABILIZADORA DA FRENTE</p> <p>SUZUKI VITARA SJ 410</p>
	<p>T1115 NO. 42412-60A00</p> <p>BATENTE DA BARRA ESTABILIZADORA DA FRENTE</p> <p>SUZUKI VITARA (SE 413) - (SE 416) - GRAND VITARA (SV420) - (SV620)</p>		<p>W5001 NO. 0515k9</p> <p>POLIE DA CAMBOTA (5 pistas)</p> <p>SUZUKI VITARA (ET) 1.9 D 68CV (motor XUD9A) (01-1995 A 03-1998) - VITARA (ET) 1.9D 75CV (motor XUD9SD) (08-1996 A 03-1998)</p>
	<p>W5101 NO. 0515.L9 - 0515.T5</p> <p>POLIE DA CAMBOTA</p> <p>SUZUKI VITARA 2.0 HDi</p>		<p>Z9011 NO. 1449282600</p> <p>MOLA DE ESCAPE</p> <p>SUZUKI VITARA (1988 A 1995)</p>

	F1820-I	NO. 44119-80E01 - 44119M72F11 - 44119M79F00		
	FOLE DA TRANSMISSÃO JUNTO Á CAIXA SUZUKI WAGON R+ 1.3i - 1.3i 4WD (APÓS 2000)			
	d85x88mm	1f-d73mm 1f-d19mm		

SUZUKI X-90

	T1115	NO. 42412-60A00
	BATENTE DA BARRA ESTABILIZADORA DA FRENTE SUSUKI X90 SZ416	
	42x42x38mm	34x39mm 1f-d23.5mm