

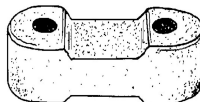



	<p><b>E0002</b> NO. HB-11517500</p> <p>ESTICADOR DE ESCAPE</p> <p>SEAT</p> <p>190x30x15mm NULL</p>		<p><b>F0057-I</b> NO. 4294117 - HB14153100</p> <p>FOLE DO DIFERENCIAL LADO DA CAIXA (F1012)</p> <p>SEAT</p> <p>d95x85mm 1f-d65mm 1f-d23mm</p>
	<p><b>H415</b> NO.</p> <p>PALA ORIGINAL</p> <p>SEAT</p> <p>300x180mm NULL</p>		<p><b>P1030</b> NO. 1H0721173</p> <p>CAPA DO PEDAL DE TRAVÃO</p> <p>SEAT</p> <p>65x54x9mm NULL</p>
	<p><b>Q2011</b> NO. 191253141 - 191253141E</p> <p>UNIÕES DE ESCAPE</p> <p>SEAT</p> <p>90x72x53mm 1f-d46,7mm</p>		<p><b>UMV25711</b> NO. 8L071184</p> <p>MANETE ALAVANCA VELOCIDADES</p> <p>SEAT - ADAPTAVEL TODOS OS MODELOS COM HASTE 12mm</p> <p>110x51x38mm 1pino-d15mm</p>
	<p><b>Z80305</b> NO.</p> <p>Mola de retenção</p> <p>SEAT (TODOS)</p> <p>d10x9.8mm 1p-7.4x6.6-8.8mm 1f-d3mm</p>		<p><b>Z80460</b> NO.</p> <p>Mola de retenção</p> <p>Seat</p> <p>d10.3x10mm 1p-7.5x6.6-9mm 1f-d3mm</p>

SEAT 124-131-132

	<p><b>D0014</b> NO. FA-138705 - 105001530000 - 2101-2202120 - 21012202120 - 2101300095</p> <p>CARDAN DA TRANSMISSÃO</p> <p>SEAT 124 TT - 131 TT</p> <p>140x130x80mm 6f-d12mm</p>		<p><b>E0108-I</b> NO. 2320477 - 54903306</p> <p>ESTICADOR DE ESCAPE</p> <p>SEAT 131 - 132</p> <p>90x35x24mm 2f-d12mm</p>
	<p><b>F1118-I</b> NO. 60760026</p> <p>FOLE DA DIRECÇÃO LADO DIREITO</p> <p>SEAT 131 (DIRECÇÃO ASSISTIDA)</p> <p>d65x210mm 1f-d45mm 1f-d10mm</p>		<p><b>F1119-I</b> NO. 36020065 - 9943835</p> <p>FOLE DA DIRECÇÃO LADO ESQUERDO</p> <p>SEAT 131 (DIRECÇÃO ASSISTIDA)</p> <p>d65x165mm 1f-d46mm 1f-d10mm</p>

	<p><b>A0614-I</b> NO. 4465998</p> <p>SUPORTE DO MOTOR FRENTE E TRÁS</p> <p>SEAT MARBELLA</p> <p>115x90x53mm 1f-12mm</p>		<p><b>A0659-I</b> NO. HB-15413000</p> <p>SUPORTE TRÁS DO MOTOR</p> <p>SEAT 127</p> <p>158x117x88mm 1f-d12mm</p>
	<p><b>A0661-I</b> NO. HB-00452300</p> <p>SUPORTE FRENTE DO MOTOR</p> <p>SEAT 127</p> <p>110x106x90mm 1f-d10mm</p>		<p><b>A0944</b> NO. HB-15410300</p> <p>SUPORTE DO MOTOR</p> <p>SEAT 127</p> <p>140x90x55 NULL</p>
	<p><b>A1001</b> NO. SE138154605A</p> <p>SUPORTE DE MOTOR LADO DA CAIXA</p> <p>SEAT RONDA</p> <p>138x80x48mm 1f-d12mm</p>		<p><b>A1004</b> NO. SE831154205A</p> <p>SUPORTE DE MOTOR FRENTE</p> <p>SEAT RONDA</p> <p>135x85x58mm 1f-d12mm</p>
	<p><b>A1005</b> NO. SE700154205A</p> <p>SUPORTE FRENTE DO MOTOR</p> <p>SEAT RONDA</p> <p>135x80x48mm 1f-d12/15mm</p>		<p><b>A1066</b> NO. SE021156228A - SE02156228A</p> <p>APOIO SUPERIOR DO AMORTECEDOR DIANTEIRO (SEM ROLAMENTO)</p> <p>SEAT MARBELLA 0.8 (08-1986 A 12-1993) - 0.9 (01-1987 A 12-1993) - 0.9 CAT.(01-1990 A 11-1996) - MARBELLA FURGONATO 0.8 (01-1987 A 12-1993) - FURGONATO 0.9 (01-1987 A 12-1993) - FURGONATO 0.9 CAT.(01-1987 A 12-1993)</p> <p>d78x43mm 1f-d20mm</p>
	<p><b>A1066</b> NO. SE021156228A - SE02156228A</p> <p>APOIO SUPERIOR DO AMORTECEDOR DIANTEIRO (SEM ROLAMENTO)</p> <p>SEAT TERRA 1.3 D (03-1990 A 12-1994) - 1.4 D (10-1990 A 12-1995) - TERRA FURGONATO 1.3 D (03-1990 A 02-1992) - FURGONATO 1.4 D (10-1990 A 02-1992)</p> <p>d78x43mm 1f-d20mm</p>		<p><b>A1957</b> NO. 4400895 - 4400905 - 7635775</p> <p>APOIO AMORTECEDOR FRENTE DIREITO ESQUERDO</p> <p>SEAT MARBELLA (28) 0.8 Ano fabric. at é: 03.89, Posição/grau: 1° (08.86 A 12.93) 34cv 843cc Hatchback - SEAT MARBELLA (28) 0.9 Ano fabric. at é: 03.89, Posição/grau: 1° (01.87 A 12.93) 40cv 903cc Hatchback - SEAT MARBELLA Caixa (028A) 0.8 Ano fabric. at é: 03.89, Posição/grau: 1° (01.87 A 12.93) 34cv 843cc Caixa - SEAT MARBELLA Caixa (028A) 0.9 Ano fabric. at é: 03.89, Posição/grau: 1° (01.87 A 12.93) 40cv 903cc Caixa -...etc.</p> <p>120x100x38mm 1f-d12mm 2p-d8x18mm</p>
	<p><b>A1957</b> NO. 4400895 - 4400905 - 7635775</p> <p>APOIO AMORTECEDOR FRENTE DIREITO ESQUERDO</p> <p>SEAT RONDA (022A) 1.2 Posição/grau: 1° (10.84 A 12.86) 60cv 1193cc Hatchback - SEAT RONDA (022A) 1.2 Posição/grau: 1° (08.83 A 05.85) 64cv 1197cc Hatchback - SEAT RONDA (022A) 1.4 Ano fabric. at é: 07.86, Posição/grau: 1° (06.82 A 11.88) 73cv 1438cc Hatchback - SEAT RONDA (022A) 1.5 Posição/grau: 1° (09.84 A 12.86) 85cv 1461cc Hatchback - SEAT RONDA (022A) 1.6 Posição/grau: 1° (08.83 A 09.85) 92cv 1592cc Hatchback - ...etc.</p> <p>120x100x38mm 1f-d12mm 2p-d8x18mm</p>		<p><b>A1957</b> NO. 4400895 - 4400905 - 7635775</p> <p>APOIO AMORTECEDOR FRENTE DIREITO ESQUERDO</p> <p>SEAT TERRA (24) 0.9 Ano fabric. at é: 03.89, Posição/grau: 1° (02.87 A 12.96) 40cv 903cc Combi - SEAT TERRA Caixa (024A) 0.9 Ano fabric. at é: 03.89, Posição/grau: 1° (01.87 A 12.95) 40cv 903cc Caixa</p> <p>120x100x38mm 1f-d12mm 2p-d8x18mm</p>
	<p><b>BE18</b> NO. SE127115112A</p> <p>ABRAÇADEIRA DE ESCAPE CÔNCAVA</p> <p>SEAT FURA (1983 A 1987) - IBIZA (1986 A 1992) - MARBELLA (1987 A 1992) - TERRA (APÓS 1987)</p> <p>99x62x26mm 2p-d8-60mm</p>	 <p>ESC: 1/2</p>	<p><b>C0229</b> NO. 100816 - 4276430</p> <p>BOTÃO DE AFINAÇÃO DE CAPOT (GRANDE)</p> <p>SEAT MARBELLA (28) 0.8 Local de montagem: à frente 25kW 34CV 843cc Hatchback (DE 08-86 ATÉ 12-93)</p> <p>SEAT MARBELLA Caixa (028A) 0.8 Local de montagem: à frente 25kW 34CV 843cc Caixa (DE 01-87 ATÉ 12-93)</p> <p>d18x44mm NULL</p>
 <p>ESC: 1/2</p>	<p><b>C0229</b> NO. SE128559910A - GA-5599100</p> <p>BOTÃO DE AFINAÇÃO DO CAPOT (GRANDE)</p> <p>SEAT MARBELLA (28) 0.8 Local de montagem: à frente 25kW 34CV 843cc Hatchback (DE 08-86 ATÉ 12-93)</p> <p>SEAT MARBELLA Caixa (028A) 0.8 Local de montagem: à frente 25kW 34CV 843cc Caixa (DE 01-87 ATÉ 12-93)</p> <p>d18x44mm NULL</p>	 <p>ESC: 1/2</p>	<p><b>C0229</b> NO. SE128559910A - GA-5599100</p> <p>BOTÃO DE AFINAÇÃO DO CAPOT (GRANDE)</p> <p>SEAT RONDA (022A) 1.2 Local de montagem: à frente 44kW 60CV 1193cc Hatchback (DE 10-84 ATÉ 12-86)</p> <p>SEAT RONDA (022A) 1.2 Local de montagem: à frente 47kW 64CV 1197cc Hatchback (DE 08-83 ATÉ 05-85)</p> <p>SEAT RONDA (022A) 1.4 Local de montagem: à frente 54kW 73CV 1438cc Hatchback (DE 06-82 ATÉ 11-88)</p> <p>SEAT RONDA (022A) 1.5 Local de montagem: à frente 63kW 85CV 1461cc Hatchback (DE 09-84 ATÉ 12-86)</p> <p>SEAT RONDA (022A) 1.6 Local de montagem: à frente 63kW 85CV 1461cc Hatchback (DE 09-84 ATÉ 12-86)</p> <p>SEAT RONDA (022A) 1.6 Local de montagem: à frente 63kW 85CV 1461cc Hatchback (DE 09-84 ATÉ 12-86)</p>

	<p><b>E0001</b> NO. SE127115175A - HB-115175 - 2101-1203047</p> <p>ESTICADOR DE ESCAPE</p> <p>SEAT FURA TT</p> <p>130x32x15mm NULL</p>		<p><b>E0003</b> NO. 04212281 - 04296059 - 04296060 - 04297082 - 04306054 - 04312280</p> <p>ESTICADOR DE ESCAPE</p> <p>SEAT FURA TT - SEAT 124 (76 A 80)</p> <p>80x35x37mm NULL</p>
	<p><b>E0017</b> NO. SE138115503A - RF-115503 - RF138115503A</p> <p>SUPORTE DE ESCAPE</p> <p>SEAT MARBELLA - SEAT RONDA (83 A 87) - SEAT TERRA (APÓS 87)</p> <p>55x45x28mm NULL</p>		<p><b>F0060-I</b> NO. HB-16213200</p> <p>FOLE DA CREMALHEIRA DA DIRECÇÃO DIREITO (F1038)</p> <p>SEAT 127 - RONDA - MALAGA</p> <p>d59x180mm d47mm 1f-d1f-d26mm 1f-d10mm</p>
	<p><b>F0061-I</b> NO. HB-16212101 - HB16213101</p> <p>FOLE DA CREMALHEIRA DA DIRECÇÃO ESQUERDO</p> <p>SEAT 127 - RONDA - MALAGA</p> <p>d59x118mm 1f-d41mm 1f-d10mm</p>		<p><b>F0062-I</b> NO. HB-14153700</p> <p>FOLE DO SEMI-EIXO JUNTO À RODA (F1005)</p> <p>SEAT 127 - PANDA</p> <p>d86x98mm 1f-d74mm 1f-d21mm</p>
	<p><b>F0403-I</b> NO. HF-14153700</p> <p>FOLE DO SEMI-EIXO JUNTO À RODA</p> <p>SEAT FURA</p> <p>d80x80mm 1f-d70mm 1f-d20mm</p>		<p><b>F0481-I</b> NO. HB-14153100</p> <p>FOLE DO SEMI-EIXO JUNTO À RODA (F1012)</p> <p>SEAT 127</p> <p>d100x80mm 1f-d20mm 1f-d75mm</p>
	<p><b>F1057</b> NO. SE-138104311A</p> <p>FOLE DO DEPÓSITO DE GASOLINA</p> <p>SEAT RONDA</p> <p>d73x73mm 2f-d49mm</p>		<p><b>F1128A-I</b> NO. SE128141531A</p> <p>FOLE DO LADO DA CAIXA (COM d25.8mm)</p> <p>SEAT RONDA</p> <p>d95x98mm 1f-d64mm 1f-d25mm</p>
	<p><b>KF1730</b> NO. SE127141537A</p> <p>KIT FOLE DO LADO DA RODA</p> <p>SEAT 127 - 128 - FURA - MARBELLA - RONDA</p> <p>d82x80mm 1f-d20mm 1f-d68mm</p>		<p><b>L0232</b> NO.</p> <p>CASQUILHO DE AMORTECEDORES OLHAL DUPLO</p> <p>SEAT MARBELLA</p> <p>d31x26mm 1f-d16mm</p>
	<p><b>L0419-I</b> NO. HB-16213001 - SE138162130A</p> <p>CASQUILHO DE NYLON CREMALHEIRA DA DIRECÇÃO</p> <p>SEAT 127 - RONDA - MALAGA</p> <p>28x28x18mm 1f-d21mm</p>		<p><b>L1011</b> NO. HB-15624400 - SE127156244A - SE138156244A</p> <p>CASQUILHO DO BRAÇO DA SUSPENSÃO (PONTAS DA BARRA ESTABILIZADORA)</p> <p>SEAT 127 - FURA TT - MARBELLA TT</p> <p>d34x21mm 1f-d16mm</p>
	<p><b>L1064</b> NO.</p> <p>CASQUILHO DE MOLAS (PEQUENO)</p> <p>SEAT TERRA</p> <p>d33x26mm d24mm 1f-d13mm</p>		<p><b>L1066</b> NO.</p> <p>CASQUILHO DE MOLAS (GRANDE)</p> <p>SEAT TERRA</p> <p>d33x61mm d24mm 1f-d10mm</p>

	<p><b>L3006</b> NO. SE132156127A - 4125489</p> <p>CASQUILHO DO BRAÇO DA SUSPENSÃO</p> <p>SEAT MARBELLA TT</p>		<p><b>L3007</b> NO. SE132156126A - 4125492</p> <p>CASQUILHO DO BRAÇO DA SUSPENSÃO</p> <p>SEAT MARBELLA TT</p>
	<p><b>L3009</b> NO. SE138162130A</p> <p>CASQUILHO DA EXTREMIDADE DA CREMALHEIRA DA DIRECÇÃO</p> <p>SEAT FURA TT - IBIZA TT</p>		<p><b>M6042</b> NO. 4152873 - 4166914</p> <p>JUNTA DE ESCAPE</p> <p>SEAT RONDA (1983 A 1984)</p>
	<p><b>M6048</b> NO. SE012006415A - SE012006145B - SE012006422B</p> <p>JUNTA DE ESCAPE</p> <p>SEAT RONDA (1984 A 1987)</p>		<p><b>P0009-R</b> NO. EA-16801301</p> <p>CAPA DE PEDAL TRAVÃO E EMBRAIAGEM</p> <p>SEAT 600 - 850 - RITMO - RONDA - MALAGA</p>
	<p><b>P1013</b> NO. SE138126025A</p> <p>CAPA DE PEDAL DO TRAVÃO E EMBRAIAGEM</p> <p>SEAT MARBELLA TT</p>		<p><b>P1016</b> NO. SE127126025A - 2101-162048</p> <p>CAPA DE PEDAL DO TRAVÃO E EMBRAIAGEM</p> <p>SEAT FURA TT - IBIZA TT - MARBELLA TT</p>
	<p><b>P1018</b> NO. SE021110044A - 4187379</p> <p>CAPA DO PEDAL DO ACELADOR</p> <p>SEAT FURA TT - IBIZA TT - MALAGA GASOLINA</p>		<p><b>P1052</b> NO. FA12602500 - SE127126025A - SE126025A</p> <p>CAPA DE PEDAL DO TRAVÃO E EMBRAIAGEM</p> <p>SEAT FURA - IBIZA FIAT - MARBELLA APÓS 86 850 - 903 - RONDA APÓS 2 - 86 - TERRA 1.3D - 1.4D</p>
	<p><b>R021800</b> NO. SE127117207A - 4229719 - 7634419</p> <p>TUBO INFERIOR DO RADIADOR</p> <p>SEAT FURA TT</p>		<p><b>R021801</b> NO. SE127117224A - 4224720 - 4229720</p> <p>TUBO SUPERIOR DO RADIADOR</p> <p>SEAT FURA TT</p>
	<p><b>R021804</b> NO. 4234102 - 4362764 - 0852770400 - 7700557987 - SE127104011A - HB-10401100</p> <p>TUBO DE LIGAÇÃO AO DEPÓSITO</p> <p>SEAT FURA TT</p>		<p><b>R021812</b> NO. SE020032162A - 4266805 - 4428395 - 7589814 - 13311288284 - 4195157 - 4346493 - 4398756 - 4415176 - 4...</p> <p>TUBO DE LIGAÇÃO DO CARBURADOR AO COLECTOR</p> <p>SEAT FURA TT</p>
	<p><b>R021885</b> NO. SE020032147A - SE020032161A</p> <p>TUBO DO TERMOSTATO</p> <p>SEAT FURA TT - MARBELLA</p>		<p><b>R021908</b> NO. SE141117205B - SE028117205B - SE141117205A</p> <p>TUBO SUPERIOR DE LIGAÇÃO DO TERMOSTATO À BOMBA DE ÁGUA</p> <p>SEAT MARBELLA - PANDA</p>



	<p><b>R8047</b> NO. XO39657310</p> <p>TUBO DE RETORNO DO AQUECIMENTO</p> <p>SEAT TERRA DIESEL</p>		<p><b>R8048</b> NO. SE021119501A</p> <p>TUBO DO AR FRIO</p> <p>SEAT RITMO - RONDA</p>
	<p><b>RT08353</b> NO. 5959715 - SE141744400B</p> <p>TUBO DE TRAVÃO FRENTE LH-RH</p> <p>SEAT MARBELLA (28) 0.8 (08 NCA) 34CV (08-1986 A 12-1993) - 0.9 (08 NCB) 44CV (07-1997 A 10-1998) - 0.9 (09 NCA - 100 GL 7000) 40CV (01-1987 A 12-1993) - 0.9 Cat. (08 NCB) 41CV (11-1996 A 10-1998) - 0.9 Cat.(09 NCB - 100 GL 7000) 40CV (01-1990 A 11-1996) - MAR</p>		<p><b>RT08353</b> NO. 5959715 - SE141744400B</p> <p>TUBO DE TRAVÃO FRENTE LH-RH</p> <p>SEAT PANDA (141A) 0.9 (100 GL 3000) 42CV (10-1980 A 12-1986)</p>
	<p><b>RT08353</b> NO. 5959715 - SE141744400B</p> <p>TUBO DE TRAVÃO FRENTE LH-RH</p> <p>SEAT TERRA (24) 0.9 (09 NCA) 40CV (02-1987 A 12-1996) - 0.9 Cat. 09 NCB 40CV (02-1992 A 12-1994) - 1.3 D (MN) 45CV (03-1990 A 12-1994) - 1.4 D (1 W) 48CV (10-1990 A 12-1995) - TERRA Furgonato (024A) 0.9 (09 NCA) 40CV (01-1987 A 12-1995) - 0.9 Cat.(09 NCB)</p>		<p><b>S1022</b> NO. SE127160112A</p> <p>SILENT-BLOC SUPERIOR DO AMORTECEDOR TRÁS</p> <p>SEAT FURA TT - IBIZA TT - MALAGA TT</p>
	<p><b>S1595</b> NO. 50511650 - 50521486 - 51783056 - 51783057</p> <p>SILENT-BLOC BRAÇO SUPERIOR FRENTE</p> <p>SEAT PANDA (141A) 0.9 (10.80 A 12.86) 42cv 903cc Hatchback</p>		<p><b>S1595</b> NO. 50511650 - 50521486 - 51783056 - 51783057</p> <p>SILENT-BLOC BRAÇO SUPERIOR FRENTE</p> <p>SEAT TERRA Caixa (024A) 0.9 (01.87 A 12.95) 29 40 903 Caixa SEAT TERRA Caixa (024A) 0.9 Cat 01.90 - 12.95 29 40 903 Caixa</p>
	<p><b>T002-E</b> NO.</p> <p>BATENTE DE ESCAPE</p> <p>SEAT FURA (83-87)</p>		<p><b>U0091-I</b> NO. SE020030136A - 60807644 - 4102056 - 2101-3003074 - EA-030113600</p> <p>VEDAÇÃO DA VARETA DO ÓLEO</p> <p>SEAT FURA TT - MARBELLA</p>

SEAT ALHAMBRA

	<p><b>A1937-C</b> NO. 1J0412249 - 1J0412331 - 1J0412331B - 1J0412331BS</p> <p>APOIO DO AMORTECEDOR</p> <p>SEAT ALHAMBRA (7V8_ 7V9) 1.8 T 20V Posição/grau: 1 ° (10.97 A 03.10) 150cv 1781cc Veículo multiuso - SEAT ALHAMBRA (7V8, 7V9) 2.0 i Posição/grau: 1 ° (04.96 A 03.10) 115cv 1984cc Veículo multiuso - SEAT ALHAMBRA (7V8, 7V9) 2.8 V6 Posição/grau: 1 ° (06.00 A 03.10) 204cv 2792cc Veículo multiuso - SEAT ALHAMBRA (7V8, 7V9) 2.8 V6 4motion Posição/grau: 1 ° (06.00 A 03.10) 204cv 2792cc Veículo multiuso - SEAT ALHAMBRA (7V8, 7V9)...etc.</p>		<p><b>E0107</b> NO. 7M0411317D - 7M0411317 - 1M215489AA - 7M3411317</p> <p>ESTICADOR DA BARRA ESTABILIZADORA DA FRENTE</p> <p>SEAT ALHAMBRA TT</p>
	<p><b>F1308-I</b> NO. 441407285A</p> <p>FOLE JUNTO À RODA</p> <p>SEAT ALHAMBRA</p>		<p><b>F1669-I</b> NO. 7M0422831B</p> <p>FOLE DA DIRECÇÃO ASSISTIDA LADO DIREITO E ESQUERDO</p> <p>SEAT ALHAMBRA</p>







	<p><b>F1825-I</b> NO. 1J0498201G - 7M3498201 - 7M3498201A - 8E0498201B</p> <p>FOLE DA TRANSMISSÃO JUNTO À CAIXA</p> <p>SEAT ALHAMBRA 1.8i T 20V - 1.9 TDi - 1.9 TDi PD - 1.9 TDi PD 4 - 2.0i - 2.8i VR6 - 2.8i VR6 4 (APÓS 1996)</p> <p>d95x120mm 1f-d80mm 1f-d23mm</p>		<p><b>KF1473-T</b> NO. 701498203A</p> <p>KIT DE FOLE DO CARDAN JUNTO À RODA</p> <p>SEAT ALHAMBRA 1.8i T 20V - 1.9 TDi - 2.0i - 2.8i VR6 (APÓS 1996)</p> <p>d110x150mm 1f-d98mm 1f-d29mm</p>
	<p><b>KF2539-T</b> NO. 701498203A - 7M0407285A - 7M0498203 - 7M0498203A</p> <p>KIT DE FOLE DO CARDAN JUNTO À RODA</p> <p>SEAT ALHAMBRA 1.8 T 20V - 1.9 TDi - 1.9 TDi PD - 1.9 TDi TD 4 - 2.0i - 2.8i VR6 - 2.8i VR6 4 (APÓS 1996)</p> <p>d110x150mm 1f-d98mm 1f-d30mm</p>		<p><b>KF8020-T</b> NO. 701498203A</p> <p>KIT DE FOLE DO CARDAN JUNTO À RODA</p> <p>SEAT ALHAMBRA 1.8i T 20V - 1.9 TDi - 2.0i - 2.8i VR6 (APÓS 1996)</p> <p>d110x150mm 1f-d98mm 1f-d29mm</p>
	<p><b>KL2763</b> NO. 028103638G - 028103665 - 028103937</p> <p>KIT CASQUILHOS REPARAÇÃO CAIXA FILTRO OLEO</p> <p>SEAT ALHAMBRA (7V8, 7V9) 1.8 T 20V (10.97 A 03.10) 150cv 1781cc Veículo multiuso - SEAT ALHAMBRA (7V8, 7V9) 2.0 i (04.96 A 03.10) 115cv 1984cc Veículo multiuso - SEAT ALHAMBRA (7V8, 7V9) 2.8 V6 (06.00 A 03.10) 204cv 2792cc Veículo multiuso - SEAT ALHAMBRA (7V8, 7V9) 2.8 V6 4motion (06.00 A 03.10) 204cv 2792cc Veículo multiuso - SEAT ALHAMBRA (7V8, 7V9) 1.9 TDI (04.96 A 03.10) 90cv 1896cc Veículo multiuso - SEAT ALHAMBRA (7V8, 7V9) ...etc.</p> <p>d28x19mm 1f-d9mm</p>		<p><b>M6013</b> NO. 357253137A</p> <p>JUNTA DE ESCAPE</p> <p>SEAT ALHAMBRA (APÓS 1996) - CORDOBA (1993 A 1996) - IBIZA (1993 A 1996) - TOLEDO (APÓS 1991)</p> <p>d80x14.8mm 1f-d56mm</p>
	<p><b>M6109</b> NO. 026129589A - 028129589B - 056129589A</p> <p>JUNTA DE ESCAPE</p> <p>SEAT ALHAMBRA (APÓS 04 -96)</p> <p>82x41mm 1f-38/27mm</p>		<p><b>R221912</b> NO.</p> <p>TUBO DE LIGAÇÃO DO AR AO TURBO</p> <p>SEAT ALHAMBRA (7V8 - 7V9) 1.9 TDI (08.96 - 06.00) 110cv 1896cc Veículo multiuso - SEAT IBIZA II (6K1) 1.9 TDI (08.96 - 08.99) 90cv 1896cc Hatchback - SEAT IBIZA II (6K1) 1.9 TDI (02.97 - 08.99) 110cv 1896cc Hatchback - SEAT IBIZA III (6K1) 1.9 TDI (08.99 -</p> <p>B55-50/50mm 55mm</p>
	<p><b>RT08924</b> NO. 7M0611701D</p> <p>TUBO DE TRAVÃO FRENTE LH-RH</p> <p>SEAT ALHAMBRA TT (APÓS 04-1996)</p> <p>500mm FB54 - MCL</p>		<p><b>RT80244</b> NO. 7335770 - 95VW2282AD - 7M0611775C - 7M0611775E</p> <p>TUBO DE TRAVÃO TRÁS LH-RH</p> <p>SEAT ALHAMBRA TT (APÓS 04-1996)</p> <p>400mm F - FB54</p>
	<p><b>RT80258</b> NO. 7M3611701B</p> <p>TUBO DE TRAVÃO FRENTE LH-RH</p> <p>SEAT ALHAMBRA TT (APÓS 04-2000)</p> <p>480mm F5 - FB24</p>		<p><b>S1365</b> NO. 7M0501541</p> <p>SILENT-BLOC DO BRAÇO DA SUSPENSÃO DA FRENTE</p> <p>SEAT ALHAMBRA 1.8T - 1.9 TDI - 2.0 - 2.8 V6</p> <p>d38x60mm d35mm 1f-d14mm</p>
	<p><b>S1367</b> NO. 7M0407181A</p> <p>SILENT-BLOC DO BRAÇO DA SUSPENSÃO DA FRENTE</p> <p>SEAT ALHAMBRA 1.8T - 1.9 TDI - 2.0 - 2.8 V6</p> <p>d60x50mm c28mm 1f-d18mm</p>		<p><b>T0637-I</b> NO. 1K0412303 B</p> <p>BATENTE SUSPENSÃO FRENTE</p> <p>SEAT ALHAMBRA (710 - 711) 1.4 TSI para fabricante: Avus Motorsport - Chassis: para veículos com chassis desportivo - para número PR: G03 (APÓS 06.10) 150cv 1390cc Veículo multiuso - SEAT ALHAMBRA (710 - 711) 1.4 TSI para fabricante: Avus Motorsport - Chassis: para veículos com chassis desportivo - para número PR: G03 (APÓS 05.15) 150cv 1395cc Veículo multiuso - SEAT ALHAMBRA (710 - 711) 1.8 TSI para fabricante: Avus Motorsport - Chassis...etc.</p> <p>d61x70mm 1f-d27mm 1f-d22mm</p>
	<p><b>T1096</b> NO. 7M0511414A</p> <p>BATENTE DA BARRA ESTABILIZADORA DE TRÁS LADO LATERAL</p> <p>SEAT ALHAMBRA APÓS 1995 1.8T - 2.0 - 2.8 V6 - 1.9 TDi</p> <p>d35x30mm 1f-d21mm</p>		<p><b>W5005</b> NO. 38105243</p> <p>POLIE DA CAMBOTA (6 pistas)</p> <p>SEAT ALHAMBRA 1.9 TDi (APÓS 04-1996)</p> <p>d138.8mm d30mm</p>

	<p><b>W5006</b> NO. 06A105243E - 06B105243F - 06A195255K</p> <p>POLIE DA CAMBOTA (6 pistas)</p> <p>SEAT ALHAMBRA (APÓS 1996) - ALTEA (APÓS 2004) - CORDOBA (APÓS 2003) - IBIZA IV (APÓS 2003) - LEON (APÓS 1999) - TOLEDO (APÓS 1999)</p> <p>d138.5mm d30mm</p>		<p><b>W5008</b> NO. 028105243T - 028105243G - 028105243H - 028105243K - 028105243R</p> <p>POLIE DA CAMBOTA (6 pistas)</p> <p>SEAT ALHAMBRA 1.9 TD - TDI (APÓS 04-1996) - IBIZA - CORDOBA (1993 -1999 TT DIESEL) - TOLEDO I 1.9 D - TD - TDI (ATÉ 03-1999) - INCA (1.9 D - DSI (APÓS 11-95)</p> <p>d155.5mm d30mm</p>
	<p><b>W5122</b> NO. 038105243M - 038105243L</p> <p>POLIE DA CAMBOTA (6 PISTAS)</p> <p>SEAT - ALHAMBRA (710 - 711) - 2.0 TDI (APÓS 05.11) 115cv 1968cc Veículo multiuso - SEAT - ALHAMBRA (710 - 711) - 2.0 TDI (06.10 - 05.11) 136cv 1968cc Veículo multiuso - SEAT - ALHAMBRA (710 - 711) - 2.0 TDI (APÓS 06.10) 140cv 1968cc Veículo multiuso - SEAT -</p> <p>d143mm d29.5mm</p>		<p><b>Z80285</b> NO. 251823717</p> <p>Mola de fixação</p> <p>Seat Alhambra (DE 1997 A 2009) - Toledo (DE 1992 A 1999)</p> <p>13x5x10mm 1p-d5-8mm</p>
	<p><b>Z80672</b> NO. 1H0823397</p> <p>Mola de fixação</p> <p>Seat Alhambra (DE 1997 A 200)</p> <p>20x15x33.8mm 1p-7x7-10mm</p>		

SEAT ALTEA-ALTEA XL-TOLEDO

	<p><b>A1025</b> NO. 191199402 - 191199402A - 191199402B - 191199402C</p> <p>SUPORTE DE MOTOR ESQUERDO (CAIXA DE VELOCIDADES)</p> <p>SEAT TOLEDO</p> <p>145x82x76mm 1r-d9mm</p>		<p><b>A1108-B</b> NO. 191199279E</p> <p>SUPORTE DO MOTOR</p> <p>SEAT TOLEDO</p> <p>130x120x113mm 1p-d10-22mm 1r-d10mm</p>
	<p><b>A1177</b> NO. 1H0199609B - 1H0199609D - 1H0199609E - 1H0199609F - 1H0199609J</p> <p>APOIO DE MOTOR DO LADO DIREITO (C/ CARÇAÇA)</p> <p>SEAT TOLEDO</p> <p>150x125x110mm d85mm d83mm 1r-d9mm</p>		<p><b>A1178</b> NO. 1H0199262E - 1H0199262F - 1H0199262G</p> <p>APOIO DE MOTOR FRENTE (S/ CARÇAÇA)</p> <p>SEAT TOLEDO</p> <p>d105x135mm d75mm 2r-d10mm</p>
	<p><b>A1393-C</b> NO. 191412331-A - 357412331-A</p> <p>APOIO DO AMORTECEDOR DA FRENTE (COM ROLAMENTO)</p> <p>SEAT TOLEDO</p> <p>d97x50mm 1f-d14mm</p>		<p><b>A1921</b> NO. 1K0253059BT - 1K0253059DF - 1K0253059HB - 1K0253144AE - 1K0254500Q</p> <p>APOIO DO ESCAPE</p> <p>SEAT ALTEA (5P1) 1.6 N.º peças nec.: 1 - Código do motor: BSE - N.º chas. até: 5P-7- 021 500 - ou: - N.º peças nec.: 1 - Código do motor: BSF - N.º chas. até: 5P-7-021 500 (APÓS 03.04) 102cv 1595cc Veículo multiuso - SEAT ALTEA (5P1) 2.0 FSI N.º peças nec.: 1 - N.º chas. até: 5P-7-021 500 (05.04 A 03.09) 150cv 1984cc Veículo multiuso - SEAT ALTEA (5P1) 2.0 TFSI (04.06 A 05.09) 200cv 1984cc Veículo multiuso</p> <p>280x50x40mm 2f-d9mm 2f-d12mm</p>
	<p><b>E0071</b> NO. 191411327 - 191411315 - 191411315B</p> <p>ESTICADOR DE BARRA ESTABILIZADORA (PONTAS)</p> <p>SEAT TOLEDO</p> <p>d40x94mm 1f-d15mm</p>		<p><b>E0072</b> NO. 191411315A</p> <p>ESTICADOR DA BARRA ESTABILIZADORA</p> <p>SEAT TOLEDO TDI</p> <p>105x40x40mm 1f-d16mm</p>

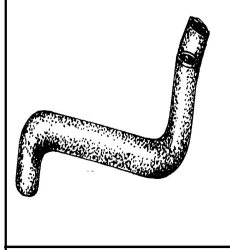
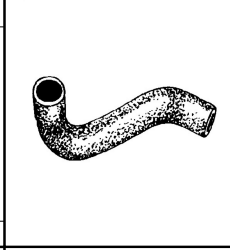
	<p><b>E0168</b> NO. 1K0505465K - 1K0505465C - 1J0505465J</p> <p>ESTICADOR DA BARRA ESTABILIZADORA DE TRÁS</p> <p>SEAT ALTEA TT - LEON TT</p> <p>130x33x35mm 1p-d10-35mm 1f-d10mm</p>		<p><b>E0169</b> NO. 1K0411315D - 1K0411315B - 1K0411315G - 1K0411315K - 1K0411315N - 1K0411315P - 1K0411315R - 50411315...</p> <p>ESTICADOR DA BARRA ESTABILIZADORA DA FRENTE</p> <p>SEAT ALTEA TT</p> <p>365x35x35mm 2p-d12-26mm</p>
	<p><b>E1062</b> NO. 8A0253147A - 893253147E</p> <p>ESTICADOR DE ESCAPE</p> <p>SEAT TOLEDO (APÓS 1991)</p> <p>71x48x38mm NULL</p>		<p><b>E1089</b> NO. 8E0253147 - 4B0253144H - 4B0253144K - 8E0253144L - 8E0253144N - 8D0253144Q - 8D0253144D - 8D0253144M...</p> <p>ESTICADOR DE ESCAPE</p> <p>SEAT TOLEDO (APÓS 04 -1999)</p> <p>150x100x40mm NULL</p>
	<p><b>E1091</b> NO. 6X0253144B - 1J0253144L - 1J0253144K</p> <p>ESTICADOR DE ESCAPE</p> <p>SEAT TOLEDO (APÓS 03 -2000)</p> <p>148x70x50mm NULL</p>		<p><b>F1057-I</b> NO. 191498201D - 321498201A - 321498201D - 443498201</p> <p>FOLE DA TRANSMISSÃO JUNTO À CAIXA</p> <p>SEAT TOLEDO 1.9D (91 A 99)</p> <p>d91x83mm 1f-d82mm 1f-d21mm</p>
	<p><b>F1088-I</b> NO. 191422831</p> <p>FOLE DA DIRECÇÃO ESQUERDO E DIREITO</p> <p>SEAT TOLEDO</p> <p>d60x195mm 1f-d45mm 1f-d10mm</p>		<p><b>F1121-I</b> NO. 191498201C - 191407283A - 1J0498201</p> <p>FOLE JUNTO À CAIXA LADO ESQUERDO</p> <p>SEAT TOLEDO 1.8-2.0-16V (ATÉ 1994) - IBIZA 1.8-2.0-16V-TD (ATÉ 1994)</p> <p>d103x120mm 1f-d18mm</p>
	<p><b>F1122-I</b> NO. 191407283</p> <p>FOLE JUNTO À CAIXA LADO DIREITO</p> <p>SEAT TOLEDO 1.8-2.0-16V (ATÉ 1994) - IBIZA 1.8-2.0-16V-TD (ATÉ 1994)</p> <p>d103x113mm 1f-d35mm 1f-d22mm</p>		<p><b>F1123-I</b> NO. 191419831</p> <p>FOLE DA DIRECÇÃO ASSISTIDA DIREITO E ESQUERDO</p> <p>SEAT TOLEDO 1.6 - 1.8</p> <p>d64x107mm 1f-d42mm 1f-d25mm</p>
	<p><b>F4012</b> NO. 1H071115AC22</p> <p>FOLE DA ALAVANCA DE VELOCIDADES</p> <p>SEAT TOLEDO</p> <p>180x140x140mm NULL</p>		<p><b>F4050</b> NO. 1K0423831A</p> <p>FOLE DA DIRECÇÃO LADO ESQUERDO E DIREITO</p> <p>SEAT ALTEA (APÓS 2004) 1.6i - 1.9 TDi PD - 2.0 TDi PD 16V - 2.0i FSi 16V</p> <p>d60x190mm 1f-d48mm 1f-d16mm</p>
	<p><b>F9003-I</b> NO. 171407285E</p> <p>FOLE DO LADO DA RODA</p> <p>SEAT TOLEDO</p> <p>d98x108mm 1f-d78mm 1f-d25mm</p>		<p><b>F9048H-I</b> NO. 5M0498203SK - 5M0498203</p> <p>FOLE DO CARDAN LADO DA RODA</p> <p>SEAT ALTEA (5P1) - 1.8 TFSI Veículo multiuso 1798cc 160CV (APÓS 01-2007) - 1.6 TDi Veículo multiuso 1598cc 105CV (APÓS 10-2009)</p> <p>d98x116mm 1f-d26mm 1f-d95mm</p>
	<p><b>F9048H-I</b> NO. 5M0498203SK - 5M0498203</p> <p>FOLE DO CARDAN LADO DA RODA</p> <p>SEAT ALTEA XL (5P5 - 5P8) - 1.8 TFSI Veículo multiuso 1798cc 160CV (APÓS 01-2007) - 1.6 TDi Veículo multiuso 1598cc 105CV (APÓS 10-2009)</p> <p>d98x116mm 1f-d26mm 1f-d95mm</p>		<p><b>KF1172-T</b> NO. 1H0407283A - 1H0407285A - 1H0407285B - 1H0498203 - 1H0498203A - 1H0498285A - 6Q0498203A</p> <p>KIT DE FOLE DO CARDAN JUNTO À RODA</p> <p>SEAT ALTEA 1.6i - 1.9 TDi PD - 2.0i FSi 16V (APÓS 2004)</p> <p>d115x130mm 1f-d85mm 1f-d26mm</p>

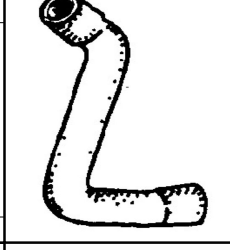
	<p><b>KF1172-T</b> NO. 1H0407283A - 1H0407285A - 1H0407285B - 1H0498203 - 1H0498203A - 1H0498285A - 6Q0498203A</p> <p><i>KIT DE FOLE DO CARDAN JUNTO À RODA</i></p> <p>SEAT TOLEDO I 1.6i - 1.6i 16V - 1.8i - 1.8i 20V - 1.8i T 20VT - 1.9 TDI - 2.0i - 2.0i 16V - 2.3i VR5 - 2.3i VR5 20V (APÓS 1991 A 1999) - TOLEDO II 1.6i - 1.8i - 1.8 iT - 1.9 TDi - 2.3i (APÓS 1999)</p> <p>d115x130mm 1f-d85mm 1f-d26mm</p>		<p><b>KF2965-T</b> NO. 1K0498203A - 1J0407285A - 8N0498203 - 8N0498203A</p> <p><i>KIT DE FOLE DO CARDAN JUNTO À RODA</i></p> <p>SEAT ALTEA (APÓS 2004) 2.0TDi PD 16V</p> <p>d110x120mm 1f-d97mm 1f-d29mm</p>
	<p><b>KL2763</b> NO. 028103638G - 028103665 - 028103937</p> <p><i>KIT CASQUILHOS REPARAÇÃO CAIXA FILTRO OLEO</i></p> <p>SEAT ALTEA (5P1) 1.9 TDI (A Partir de 04.04) 105cv 1896cc Veículo multiuso - SEAT ALTEA (5P1) 2.0 TDI (03.04 A 05.09) 136cv 1968cc Veículo multiuso - SEAT ALTEA (5P1) 2.0 TDI (A Partir de 11.05) 140cv 1968cc Veículo multiuso - SEAT ALTEA (5P1) 2.0 TDI (A Partir de 03.06) 170cv 1968cc Veículo multiuso</p> <p>d28x19mm 1f-d9mm</p>		<p><b>M6016</b> NO. 357253137</p> <p><i>JUNTA DE ESCAPE</i></p> <p>SEAT TOLEDO (1991 A 1995)</p> <p>d66.7x16mm 1f-d45.5mm</p>
	<p><b>M6109</b> NO. 026129589A - 028129589B - 056129589A</p> <p><i>JUNTA DE ESCAPE</i></p> <p>SEAT TOLEDO (APÓS 05 -91)</p> <p>82x41mm 1f-38/27mm</p>		<p><b>M6502</b> NO. 050129761A - 050129761B</p> <p><i>JUNTA DO CARBURADOR</i></p> <p>SEAT TOLEDO</p> <p>145x111x26mm NULL</p>
	<p><b>R220635</b> NO.</p> <p><i>TUBO DE LIGAÇÃO DA BOMBA DE ÁGUA AO TERMOSTATO</i></p> <p>SEAT TOLEDO (1.6 - 1.8)</p> <p>B290-d23/23mm 85-110-60-45-60mm</p>		<p><b>R220638</b> NO. 068121053AB - 068121053P - 068121053S</p> <p><i>TUBO DE LIGAÇÃO DA BOMBA DE ÁGUA AO TERMOSTATO</i></p> <p>SEAT TOLEDO 1.9D</p> <p>B310-d25/25mm d14mm 60-135-60-70mm 80-70mm</p>
	<p><b>R220642</b> NO. 191121101D - 191151101F - 191151101S</p> <p><i>TUBO DE RADIADOR SUPERIOR</i></p> <p>SEAT TOLEDO (1.6 - 1.8)</p> <p>B365-d32/30mm 80-190-100-50mm</p>		<p><b>R220643</b> NO. 191121051F</p> <p><i>TUBO DE RADIADOR INFERIOR</i></p> <p>SEAT TOLEDO (1.6 - 1.8)</p> <p>B225-d31/31mm 80-135-65mm</p>
	<p><b>R220645</b> NO. 191121051G - 191121051P</p> <p><i>TUBO DE RADIADOR INFERIOR (AR CONDICIONADO)</i></p> <p>SEAT TOLEDO (1.8 - 2.0) DIESEL (1.9)</p> <p>B240-d34/34mm 80-110-120-80mm</p>		<p><b>R220733</b> NO. 027121063 - 068121063M</p> <p><i>TUBO DE LIGAÇÃO DA BOMBA DE ÁGUA AO TUBO RÍGIDO</i></p> <p>SEAT TOLEDO TT</p> <p>B110-d23/19mm 45-35-35mm</p>
	<p><b>R220738</b> NO. 027121053B</p> <p><i>TUBO DE LIGAÇÃO DA BOMBA DE ÁGUA AO COLECTOR</i></p> <p>SEAT TOLEDO 2.0</p> <p>B220-d24/24mm d14mm 190-20-65mm 120mm</p>		<p><b>R221851</b> NO. 1L0121051A</p> <p><i>TUBO INFERIOR DO RADIADOR</i></p> <p>SEAT TOLEDO (1.8 IE)</p> <p>B230-D30/30mm 70-135-80mm</p>
	<p><b>R221870</b> NO. 1K0145832B</p> <p><i>TUBO DE LIGAÇÃO DO AR AO TURBO</i></p> <p>SEAT ALTEA (5P1) 2.0 TFSI (04.06 - 05.09) 200cv 1984cc Veículo multiuso - SEAT ALTEA (5P1) 1.9 TDI (APÓS 04.04) 105cv 1896cc Veículo multiuso - SEAT ALTEA XL (5P5 - 5P8) 2.0 TFSI 4x4 (06.07 - 05.09) 200cv 1984cc Veículo multiuso - SEAT ALTEA XL (5P5 - 5P8) 1</p> <p>B280-50/53mm 150-90-100mm</p>		<p><b>R221914</b> NO.</p> <p><i>TUBO DE LIGAÇÃO DO AR AO TURBO</i></p> <p>SEAT ALTEA (5P1) 1.9 TDI (APÓS 04.04) 105cv 1896cc Veículo multiuso - SEAT ALTEA (5P1) 2.0 TDI (03.04 - 05.09) 136cv 1968cc Veículo multiuso - SEAT ALTEA (5P1) 2.0 TDI (APÓS 11.05) 140cv 1968cc Veículo multiuso - SEAT ALTEA (5P1) 2.0 TDI (APÓS 03.06) 170c</p> <p>B280-50/53mm 240-120mm</p>



	<b>R8074</b> NO. 027103217D TUBO DO DESVAPORIZADOR SEAT TOLEDO 1.8 16 VÁLVULAS B405-d30-17mm d7mm 45-115-100-55-100-50mm 70mm		<b>R8075</b> NO. 1L0121101B - 1L0121101G TUBO SUPERIOR DO RADIADOR SEAT TOLEDO 1.6 C - AR CONDICIONADO - 1.8 C - AR CONDICIONADO - 2.0 D - TD B405-d32/32mm d10mm 70-255-150mm 820mm
	<b>RT80160</b> NO. 1K0611701B - 1K0611701 TUBO DE TRAVÃO FRENTE LH-RH SEAT ALTEA TT (APÓS 03-2004) - LEON (MOD 2005) TT (APÓS 09-2005) - TOLEDO III TT (APÓS 10-2004) 525mm FB62 - OR22		<b>RT80161</b> NO. 1K0611775C - 1K0611775A TUBO DE TRAVÃO TRÁS LH-RH SEAT ALTEA TT (APÓS 03-2004) - LEON (MOD 2005) TT 8APÓS 09-2005) - TOLEDO III TT (APÓS 10-2004) 257mm FB62 - FB62
	<b>S1117</b> NO. 191407182 - 357407182 SILENT-BLOC BRAÇO DA SUSPENSÃO FRENTE SEAT TOLEDO TT d36x54mm d33mm 1f-d12mm		<b>S1272</b> NO. 191501541 SILENT-BLOC DO BRAÇO DA SUSPENSÃO TRASEIRA 44mm SEAT TOLEDO (APÓS 1994) d71x40mm d44mm 1f-d12mm
	<b>S1361</b> NO. 1J0199429 SILENT-BLOC DO SEMI-EIXO DA FRENTE SEAT TOLEDO 2 APÓS 99 1.6 - 1.8 - 1.9 TDI - 2.3 d64x31mm d50mm 1f-d18mm		<b>S1362</b> NO. 1J0501541C SILENT-BLOC DA SUSPENSÃO DE TRÁS SEAT TOLEDO 2 APÓS 1999 1.6 - 1.8 - 1.9 TDI - 2.3 d81x90mm d72mm
	<b>S1366</b> NO. 1H0501541A SILENT-BLOC DA SUSPENSÃO DE TRÁS SEAT TOLEDO 1 APÓS 1994 1.6 - 1.6 IE - 1.8 - 1.8 16V - 1.8 IE - 1.9D - 1.9 TD - 1.9 TDI - 2.0 89x72x90mm d57mm 1f-d12mm		<b>S1377</b> NO. 1J0407181 SILENT-BLOC DO BRAÇO DA SUSPENSÃO DA FRENTE PARTE DE TRÁS SEAT TOLEDO 2 1.8 - 1.9 TDi - 2.3 d60.5x41mm c24mm 1f-d13mm
	<b>T0601-I</b> NO. 171412303C BATENTE SUPERIOR DA SUSPENSÃO FRENTE SEAT TOLEDO TT (SISTEMA VOLKSWAGEN) d53x95mm 1f-d22mm 1f-d18mm		<b>T0602-I</b> NO. 191512131 - 191512131B BATENTE DA SUSPENSÃO (TRÁS) SEAT TOLEDO TT (SISTEMA VOLKSWAGEN) d55x142mm 1f-d10mm 1f-d14mm
	<b>T0637-I</b> NO. 1K0412303 B BATENTE SUSPENSÃO FRENTE SEAT ALTEA (5P1) 1.2 TSI para número PR: G02 - para número PR: G53 - para número PR: G07 - para número PR: G54 - para número PR: G52 - para número PR: G55 (APÓS 04.10) 105cv 1197cc Veículo multiuso - SEAT ALTEA (5P1) 1.4 16V para número PR: G02 - para número PR: G53 - para número PR: G07 - para número PR: G54 - para número PR: G52 - para número PR: G55 (APÓS 05.06) 86cv 1390cc Veículo multiuso 2/6 - SEAT ALTEA (5P1) 1.4 TSI para...etc. d61x70mm 1f-d27mm 1f-d22mm		<b>T0702-I</b> NO. 1K0412303H BATENTE SUSPENSÃO DA FRENTE SEAT ALTEA (5P1) 1.2 TSI (APÓS 04.10) 105cv 1197cc Veículo multiuso - SEAT ALTEA (5P1) 1.4 TSI (APÓS 11.07) 125cv 1390cc Veículo multiuso - SEAT ALTEA (5P1) 1.6 (APÓS 03.04) 102cv 1595cc Veículo multiuso - SEAT ALTEA (5P1) 1.6 LPG (APÓS 09.09) 102cv 1595cc Veículo multiuso - SEAT ALTEA (5P1) 1.8 TFSI (APÓS 01.07) 160cv 1798cc Veículo multiuso - SEAT ALTEA (5P1) 1.6 TDI (APÓS 11.10) 90cv 1598cc Veículo multiuso - SEAT ALTEA (5P1)...etc. d50x93mm 1f-d27mm 1f-d25mm
	<b>T1020F17</b> NO. 191411314 BATENTE DA BARRA ESTABILIZADORA SEAT TOLEDO 35x35x32mm 1f-d17mm		<b>U0008</b> NO. 191513425 COÇO PLÁSTICO DA SUSPENSÃO DA FRENTE (COMPLEMENTO DO T0601-I E T0602-I) SEAT TOLEDO TT (SISTEMA VOLKSWAGEN) d65x90mm 1f-d61mm 1f-d48mm



	<b>U0009</b>	NO. 191412135 - 357412135		<b>W5048</b>	NO. 03G105243 - 03G105243C - 03G105243E	
	COPOS SUSPENSÃO DA FRENTE (COMPLEMENTO DO T0601A-I) SEAT TOLEDO TT			POLIE DA CAMBOTA (6 PISTAS)		SEAT ALTEA 1.9 TDi (APÓS 04-2004) - Mtr BJB - BKC (77Kw) - ALTEA 2.0 TDi (APÓS 03-2004) - Mtr AZV - BKD (103Kw) - CORDOBA 1.9 TDi (APÓS 09-2002) - Mtr ATD - ASZ (74-96Kw) - INCA 1.9 SDi (APÓS 11-1995) - Mtr AEY - AYQ (64CV) - INCA 1.9 TDi (APÓS 06-1996) -
d75x94mm		1f-d71mm 1f-d53mm	d143mm		d30mm	
	<b>W5122</b>	NO. 038105243M - 038105243L		<b>Z80791</b>	NO. 8Z0868243	
	POLIE DA CAMBOTA (6 PISTAS)			Mola de painel		SEAT TOLEDO
SEAT - ALTEA (5P1) - 1.6 TDi (APÓS 11.10) 90cv 1598cc Veículo multiuso - SEAT - ALTEA (5P1) - 1.6 TDi (APÓS 10.09) 105cv 1598cc Veículo multiuso - SEAT - ALTEA (5P1) - 2.0 TDi 16V Código do motor: CFHC (APÓS 03.04) 140cv 1968cc Veículo multiuso - SEAT - A		d143mm	d29,5mm	d21x22mm		1p-d10.5-13mm





SEAT AROSA

	<b>E0146</b>	NO.		<b>E0233</b>	NO. 6N0411315A	
	ESTICADOR DA BARRA ESTABILIZADORA DA FRENTE			ESTICADOR DA BARRA ESTABILIZADORA DA FRENTE		SEAT AROSA 1.4 16V (05-1997 A 06-2004)
SEAT AROSA 1.4 TDi - 1.7 SDi		82x30x30mm	1p-d10-18mm 1f-d8mm	97x40x29mm		1f-d18mm
	<b>E1091</b>	NO. 6X0253144B - 1J0253144L - 1J0253144K		<b>F1725-I</b>	NO. 6N0422831	
	ESTICADOR DE ESCAPE			FOLE DA DIRECÇÃO ASSISTIDA DIREITO E ESQUERDO		SEAT AROSA
SEAT AROSA (APÓS 05-1997)		148x70x50mm	NULL	d59x210mm		1f-d43mm 1f-d10mm
	<b>F1824-I</b>	NO. 1J0498201B - 1J0498201D		<b>F4106</b>	NO. 357413175A	
	FOLE DA TRANSMISSÃO JUNTO À CAIXA			FOLE AMORTECEDORES FRENTE		SEAT AROSA (6H) 1.0 (05.97 A 06.04) 50cv 999cc Hatchback - SEAT AROSA (6H) 1.4 (05.97 A 06.04) 60cv 1390cc Hatchback - SEAT AROSA (6H) 1.4 16V (01.00 A 06.04) 100cv 1390cc Hatchback - SEAT AROSA (6H) 1.4 TDi (01.00 A 06.04) 75cv 1422cc Hatchback - SEAT AROSA (6H) 1.7 SDi (08.97 A 06.04) 60cv 1716cc Hatchback
SEAT AROSA 1.4 TDi PD R3 (APÓS 1997) - CORDOBA III 1.4 TDi PD R3 - 1.9 TDi PD (APÓS 2002) - IBIZA IV 1.4 TDi PD R3 - 1.9 TDi PD (APÓS 2002) - LEON 1.6i - 1.6i 16V - 1.8i 20V - 1.8i T 20V - 1.9 TDi (APÓS 1999) - TOLEDO II 1.6i - 1.6i 16V - 1.8i 20V - 1.8i		d85x110mm	1f-d70mm 1f-d21mm	d80x210mm		1f-d20mm 1f-d73mm
	<b>F4106</b>	NO. 357413175A		<b>KF1174-T</b>	NO. 171498203 - 191407285 - 191407285E - 191407285F - 191407285G - 191498203C - 191498203D - 191598203 - ...	
	FOLE AMORTECEDORES FRENTE			KIT DE FOLE DO CARDAN JUNTO À RODA		SEAT AROSA 1.0i - 1.4i - 1.4i 16V - 1.7 SDi (APÓS 1997) - CORDOBA I 1.0i - 1.4i - 1.4i 16V - 1.6i - 1.8i T CUPRA 20V - 1.9D - 1.9 SDi - 1.9 TDi (1993 A 1999) - IBIZA II 1.0i - 1.0i 16V - 1.4i - 1.4i 16V - 1.6i - 1.8i T CUPRA 20V - 1.9D - 1.9 SDi - 1.9 TDi
SEAT Mii (KF1) 1.0 (A Partir de 10.11) 60cv 999cc Hatchback - SEAT Mii (KF1) 1.0 EcoFuel (A Partir de 11.12) 68cv 999cc Hatchback - SEAT Mii (KF1) 1.0 (A Partir de 10.11) 75cv 999cc Hatchback		d80x210mm	1f-d20mm 1f-d73mm	d105x115mm		1f-d80mm 1f-d26mm
	<b>KF1181-T</b>	NO. 3B0498203A - 4A0498203C - 6X0498203 - 8D0498099C - 8D0498203A - 8E0498203		<b>KL2763</b>	NO. 028103638G - 028103665 - 028103937	
	KIT DE FOLE DO CARDAN JUNTO À RODA			KIT CASQUILHOS REPARAÇÃO CAIXA FILTRO OLEO		SEAT AROSA (6H) 1.0 (10.98 A 01.01) 50cv 997cc Hatchback - SEAT AROSA (6H) 1.0 (05.97 A 06.04) 50cv 999cc Hatchback - SEAT AROSA (6H) 1.4 (05.97 A 06.04) 60cv 1390cc Hatchback - SEAT AROSA (6H) 1.4 16V (01.00 A 06.04) 100cv 1390cc Hatchback - SEAT AROSA (6H) 1.4 TDi (01.00 A 06.04) 75cv 1422cc Hatchback - SEAT AROSA (6H) 1.7 SDi (08.97 A 06.04) 60cv 1716cc Hatchback
SEAT AROSA 1.4 TDi PD R3 (APÓS 1997)		d100x120mm	1f-d85mm 1f-d26mm	d28x19mm		1f-d9mm

## SEAT AROSA

	<p><b>KT0508</b> NO. 1H0412303B</p> <p>KIT BATENTE AMORTECEDORES FRENTE</p> <p>SEAT AROSA (6H) 1.0 (05.97 A 06.04) 50cv 999cc Hatchback - SEAT AROSA (6H) 1.4 (05.97 A 06.04) 60cv 1390cc Hatchback - SEAT AROSA (6H) 1.4 TDI (01.00 A 06.04) 75cv 1422cc Hatchback - SEAT AROSA (6H) 1.7 SDI (08.97 A 06.04) 60cv 1716cc Hatchback</p> <p>d80x210mm / d50x53mm 1f-d20mm 1f-d73mm / 1f-d18mm 1f-d23mm</p>		<p><b>M6109</b> NO. 026129589A - 028129589B - 056129589A</p> <p>JUNTA DE ESCAPE</p> <p>SEAT AROSA (APÓS 08-1997)</p> <p>82x41mm 1f-38/27mm</p>
	<p><b>RT08903</b> NO. 1J0611775 - 6X0611775</p> <p>TUBO DE TRAVÃO TRÁS LH-RH</p> <p>SEAT AROSA 1.0 - 1.4 - 1.4 TDI - 1.7 SDI (APÓS 1997)</p> <p>165mm FB49 - FB49</p>		<p><b>RT08966</b> NO. 6N0611701 - 6N0611701A - 6N0611701AB - 6N0611701B</p> <p>TUBO DE TRAVÃO FRENTE LH-RH</p> <p>SEAT AROSA 1.0 - 1.4 - 1.4 TDI - 1.7 SDI (APÓS 1997)</p> <p>380mm F7 - OR22</p>
	<p><b>S1363</b> NO. 6N0501541D</p> <p>SILENT-BLOC DA SUSPENSÃO DE TRÁS</p> <p>SEAT AROSA 1.0 - 1.2TDI - 1.4 - 1.4 TDI - 1.7 SDI - CORDOBA 1.4 (06-1994 A 06-1999) - 1.6 (10-1993 A 06-1999) - 1.8 (10-1993 A 06-1999) - 1.9 SDI (8-1996 A 06-1999) - 1.9 TD 75CV (10-1993 A 08-1996) - IBIZA 1.0 - 1.3 - 1.4 - 1.6 - 1.8 - 1.9D - 1.9SDI - 1.</p> <p>d66x58mm d58mm 1f-d10mm</p>		<p><b>T0632-I</b> NO. 1H0412303 B</p> <p>BATENTE SUSPENSÃO FRENTE</p> <p>SEAT AROSA (6H) 1.0 (05.97 A 06.04) 50cv 999cc Hatchback - SEAT AROSA (6H) 1.4 N.º chas. at é: 1J-Y-360000 (05.97 A 06.04) 60cv 1390cc Hatchback - SEAT AROSA (6H) 1.4 16V (01.00 A 06.04) 100cv 1390cc Hatchback - SEAT AROSA (6H) 1.4 TDI (01.00 A 06.04) 75cv 1422cc Hatchback - SEAT AROSA (6H) 1.7 SDI (08.97 A 06.04) 60cv 1716cc Hatchback</p> <p>d49x64mm 1f-d18mm 1f-d22mm</p>
	<p><b>UMV25722</b> NO. 1J071113</p> <p>MANETE ALAVANCA VELOCIDADES</p> <p>SEAT-ADAPTAVEL AOS MODELOS AROSA/LEON/TOLEDO</p> <p>120x48x34mm 1pino-d18mm</p>		<p><b>W5050</b> NO. 028105243AC - 028105243AA</p> <p>POLIE DA CAMBOTA (5 PISTAS)</p> <p>SEAT AROSA 1.7 SDi APÓS 08 -1997 - Mtr AKU (60CV)</p> <p>d161mm d30mm</p>
	<p><b>W5124</b> NO. 045105243C - 045105243 - 045105143D</p> <p>POLIE DA CAMBOTA (6 PISTAS)</p> <p>SEAT - AROSA (6H) - 1.4 TDI (01.00 - 06.04) 75cv 1422cc Hatchback</p> <p>d142mm d29,5mm</p>		

## SEAT CORDOBA-MALAGA

	<p><b>A1001</b> NO. SE138154605A</p> <p>SUPORTE DE MOTOR LADO DA CAIXA</p> <p>SEAT MALAGA DIESEL</p> <p>138x80x48mm 1f-d12mm</p>		<p><b>A1003</b> NO. SE022154805B - XO 5920938 - SE138154605B - SE022154805A</p> <p>SUPORTE DO MOTOR</p> <p>SEAT MALAGA DIESEL - MALAGA GASOLINA</p> <p>130x80x65mm 1f-d12mm</p>
	<p><b>A1004</b> NO. SE831154205A</p> <p>SUPORTE DE MOTOR FRENTE</p> <p>SEAT MALAGA-S. PORCHE</p> <p>135x85x58mm 1f-d12mm</p>		<p><b>A1005</b> NO. SE700154205A</p> <p>SUPORTE FRENTE DO MOTOR</p> <p>SEAT MALAGA DIESEL</p> <p>135x80x48mm 1f-d12/15mm</p>

	<p><b>A1025</b> NO. 191199402 - 191199402A - 191199402B - 191199402C</p> <p>SUPORTE DE MOTOR ESQUERDO (CAIXA DE VELOCIDADES) SEAT CORDOBA</p>		<p><b>A1066</b> NO. SE021156228A - SE02156228A</p> <p>APOIO SUPERIOR DO AMORTECEDOR DIANTEIRO (SEM ROLAMENTO) SEAT MALAGA 1.2 (11-1984 A 12-1993) - 1.2 i (12-1989 A 12-1993) - 1.5 (05-1985 A 12-1993) - 1.5 i (01-1987 A 12-1993) - 1.5 i CAT. (10-1986 A 12-1993) - 1.7 D (05-1985 A 12-1993)</p>
	<p><b>A1072</b> NO. 191412329 - 191412331</p> <p>SUPORTE DO AMORTECEDOR DA SUSPENSÃO FRENTE SEAT CORDOBA TT</p>		<p><b>A1177</b> NO. 1H0199609B - 1H0199609D - 1H0199609E - 1H0199609F - 1H0199609J</p> <p>APOIO DE MOTOR DO LADO DIREITO (C/ CARÇAÇA) SEAT CORDOBA</p>
	<p><b>A1178</b> NO. 1H0199262E - 1H0199262F - 1H0199262G</p> <p>APOIO DE MOTOR FRENTE (S/ CARÇAÇA) SEAT CORDOBA</p>		<p><b>A1937-C</b> NO. 1J0412249 - 1J0412331 - 1J0412331B - 1J0412331BS</p> <p>APOIO DO AMORTECEDOR</p> <p>SEAT CORDOBA (6K1_ 6K2) 1.0 i Posição/grau: 1 ° (09.96 A 06.99) 50cv 999cc três volumes - SEAT CORDOBA (6K1, 6K2) 1.4 i Ano fabric. a partir de: 10.95, Código do mot or: ABD, Código do mot or: AEX, Código do mot or: AKV, Código do mot or: APQ, Posição/grau: 1 ° (06.94 A 06.99) 60cv 1390cc três volumes - SEAT CORDOBA (6K1, 6K2) 1.4 i 16V Posição/grau: 1 ° (09.96 A 06.99) 101cv 1390cc três volumes - SEAT CORDOBA (6K1, 6K2) 1.6...etc.</p>
	<p><b>A1957</b> NO. 4400895 - 4400905 - 7635775</p> <p>APOIO AMORTECEDOR FRENTE DIREITO ESQUERDO</p> <p>SEAT MALAGA (023A) 1.2 Ano fabric. at é: 03.89, Posição/grau: 1 ° (05.85 A 12.93) 60cv 1193cc três volumes - SEAT MALAGA (023A) 1.5 Ano fabric. at é: 03.89, Posição/grau: 1 ° (05.85 A 12.93) 85cv 1461cc três volumes - SEAT MALAGA (023A) 1.5 i Cat Ano fabric. at é: 03.89, Posição/grau: 1 ° (10.86 A 12.93) 90cv 1461cc três volumes - SEAT MALAGA (023A) 1.5 i Ano fabric. at é: 03.89, Posição/grau: 1 ° (01.87 A 12.93) 100cv 1...etc.</p>	 <p>ESC: 1/2</p>	<p><b>C0229</b> NO. SE128559910A - GA-5599100</p> <p>BOTÃO DE AFINAÇÃO DO CAPOT</p> <p>SEAT MALAGA (023A) 1.2 Local de montagem: à frente 44kW 60CV 1193cc três volumes (DE 05-85 ATÉ 12-93) SEAT MALAGA (023A) 1.2 i Local de montagem: à frente 52kW 71CV 1193cc três volumes (DE 12-89 ATÉ 12-93) SEAT MALAGA (023A) 1.5 Local de montagem: à frente 63kW 85CV 1461cc três volumes (DE 05-85 ATÉ 12-93) SEAT MALAGA (023A) 1.5 i Local de montagem: à frente 74kW 100CV 1461cc três volumes (DE 01-87 ATÉ 12-93) SEAT MALAGA (023A) (...etc.)</p>
	<p><b>E0015</b> NO. SE021115504A</p> <p>ESTICADOR DE ESCAPE SEAT MALAGA TT</p>		<p><b>E0017</b> NO. SE138115503A - RF-115503 - RF138115503A</p> <p>SUPORTE DE ESCAPE SEAT MALAGA TT</p>
	<p><b>E0072</b> NO. 191411315A</p> <p>ESTICADOR DA BARRA ESTABILIZADORA SEAT CORDOBA</p>		<p><b>E0092</b> NO. 6Q0411315C - 6Q0411315F - 6Q0411315A - 6Q0411315B - 6Q0411315D - 6Q0411315E - 6Q0411315G - 6Q0411315H</p> <p>ESTICADOR DA BARRA ESTABILIZADORA DA FRENTE SEAT CORDOBA TT (APÓS 2002)</p>
	<p><b>E1090</b> NO. 6Q0253144G - 6X0253144G</p> <p>ESTICADOR DE ESCAPE SEAT CORDOBA (APÓS 01-2003)</p>		<p><b>F0514-I</b> NO. SE127141537A</p> <p>FOLE DO SEMI-EIXO JUNTO À RODA SEAT MALAGA</p>
	<p><b>F1057</b> NO. SE-138104311A</p> <p>FOLE DO DEPÓSITO DE GASOLINA SEAT MALAGA</p>		<p><b>F1088-I</b> NO. 191422831</p> <p>FOLE DA DIREÇÃO ESQUERDO E DIREITO SEAT CORDOBA</p>

	<p><b>F1128A-I</b> NO. SE128141531A</p> <p>FOLE DO LADO DA CAIXA (COM d25.8mm)</p> <p>SEAT MALAGA</p> <p>d95x98mm 1f-d64mm 1f-d25mm</p>		<p><b>F1185-I</b> NO. 191498201 - 191498201B - 191498201C - 191498202C - 1J0498201C - 321407282 - 321498201 - 357498201A</p> <p>FOLE DA TRANSMISSÃO JUNTO À CAIXA</p> <p>SEAT CORDOBA I 1.4i - 1.6i - 1.8i - 1.8i 16V - 1.8i T CUPRA 20V - 1.9 SDi - 1.9 TD - 1.9 TDi - 2.0i - 2.0i 16V (1993 A 1999) - CORDOBA II 1.8i T - 1.9 TDi - 1.9 SDi (1999 A 2002) - IBIZA II 1.4i - 1.6i - 1.8i - 1.8i 16V - 1.9 SDi - 1.9 TD - 1.9 TDi - 2.0i</p> <p>d102x120mm 1f-d54mm 1f-d29mm</p>
	<p><b>F1831-I</b> NO. 1H0422831B - 357422831A</p> <p>FOLE DA DIREÇÃO LADO DIREITO E ESQUERDO</p> <p>SEAT CORDOBA I 1.4i - 1.4i 16V - 1.6i - 1.8i - 1.8i 16V - 1.8i T CUPRA 20V - 1.9D - 1.9 SDi - 1.9 TD - 1.9 TDi - 2.0i - 2.0i 16V (1993 A 1999) - CORDOBA II 1.4i - 1.6i - 1.8i T - 1.9 TDi - 1.9 SDi (1999 A 2002) - IBIZA II 1.0i - 1.4i - 1.4i 16V - 1.6i - 1</p> <p>d70x200mm 1f-d44mm 1f-d10mm</p>		<p><b>F1841-I</b> NO. 6E0498201 - 6Q0498201C</p> <p>FOLE DA TRANSMISSÃO JUNTO À CAIXA</p> <p>SEAT CORDOBA III 1.4i 16V (APÓS 2002)</p> <p>d80x100mm 1f-d65mm 1f-d20mm</p>
	<p><b>F4102</b> NO. 6K0711115G</p> <p>FOLE ALAVANCA VELOCIDADES</p> <p>SEAT CORDOBA (6K1, 6K2) 1.0 i (09.96 A 06.99) 50cv 999cc três volumes - SEAT CORDOBA (6K1, 6K2) 1.4 i (06.94 A 06.99) 60cv 1390cc três volumes - SEAT CORDOBA (6K1, 6K2) 1.4 i 16V (09.96 A 06.99) 101cv 1390cc três volumes - SEAT CORDOBA (6K1, 6K2) 1.6 i (05.94 A 06.99) 75cv 1595cc três volumes - SEAT CORDOBA (6K1, 6K2) 1.6 i (02.93 A 06.99) 75cv 1598cc três volumes - SEAT CORDOBA (6K1, 6K2) 1.6 i (07.96 A 10.99) 101cv 1595cc três volumes - etc.</p> <p>160x200mm 1f-d18mm 1f-d100mm</p>		<p><b>F4111</b> NO. 6K0711115</p> <p>FOLE ALAVANCA VELOCIDADES</p> <p>SEAT CORDOBA (6K1, 6K2) 1.0 i (09.96 A 06.99) 50cv 999cc três volumes - SEAT CORDOBA (6K1, 6K2) 1.4 i (06.94 A 06.99) 60cv 1390cc três volumes - SEAT CORDOBA (6K1, 6K2) 1.4 i 16V (09.96 A 06.99) 101cv 1390cc três volumes - SEAT CORDOBA (6K1, 6K2) 1.6 i (05.94 A 06.99) 75cv 1595cc três volumes - SEAT CORDOBA (6K1, 6K2) 1.6 i (02.93 A 06.99) 75cv 1598cc três volumes - SEAT CORDOBA (6K1, 6K2) 1.6 i (07.96 A 10.99) 101cv 1595cc três volumes - etc.</p> <p>190x130mm 1f-d22mm 1f-d110mm</p>
	<p><b>KF1172-T</b> NO. 1H0407283A - 1H0407285A - 1H0407285B - 1H0498203 - 1H0498203A - 1H0498285A - 6Q0498203A</p> <p>KIT DE FOLE DO CARDAN JUNTO À RODA</p> <p>SEAT CORDOBA I 1.4 TDi PD R3 - 1.4i - 1.4i 16V - 1.6i - 1.8i - 1.8i 16V - 1.8i T CUPRA 20V - 1.9 SDi - 1.9 TD - 1.9 TDi - 1.9 TDi PD - 2.0i - 2.0i 16V (1993 A 1999) - CORDOBA II 1.4i - 1.6i - 1.8i T - 1.9 TDi - 1.9 SDi (1999 A 2002) - CORDOBA III 1.4i -</p> <p>d115x130mm 1f-d85mm 1f-d26mm</p>		<p><b>KF1182-T</b> NO. 1J0498203A - 3B0498203B - 6Q0498203B - 8N0498203</p> <p>KIT DE FOLE DO CARDAN JUNTO À RODA</p> <p>SEAT CORDOBA III (APÓS 2002) 1.9 TDI PD</p> <p>d113x121mm 1f-d99mm 1f-d29mm</p>
	<p><b>KF1791-T</b> NO. 6Q0498203</p> <p>KIT DE FOLE DO CARDAN JUNTO À RODA</p> <p>SEAT CORDOBA III 1.2i - 1.4i 16V - 1.6i - 1.9 SDi - 2.0i 8V (APÓS 2002)</p> <p>d100x120mm 1f-d85mm 1f-d26mm</p>		<p><b>KL2763</b> NO. 028103638G - 028103665 - 028103937</p> <p>KIT CASQUILHOS REPARAÇÃO CAIXA FILTRO OLEO</p> <p>SEAT CORDOBA (6K2) 1.0 (06.99 A 10.02) 50cv 999cc três volumes - SEAT CORDOBA (6K2) 1.4 (06.99 A 10.02) 60cv 1390cc três volumes - SEAT CORDOBA (6K2) 1.4 16V (05.00 A 10.02) 75cv 1390cc três volumes - SEAT CORDOBA (6K2) 1.4 16V (02.00 A 10.02) 100cv 1390cc três volumes - SEAT CORDOBA (6K2) 1.6 (06.99 A 10.02) 75cv 1598cc três volumes - SEAT CORDOBA (6K2) 1.6 (06.99 A 10.02) 101cv 1595cc três volumes - SEAT CORDOBA (6K2) 1.8 T 20...etc.</p> <p>d28x19mm 1f-d9mm</p>
	<p><b>L3006</b> NO. SE132156127A - 4125489</p> <p>CASQUILHO DO BRAÇO DA SUSPENSÃO</p> <p>SEAT MALAGA GASOLINA</p> <p>d55x32mm 1f-d23mm</p>		<p><b>L3007</b> NO. SE132156126A - 4125492</p> <p>CASQUILHO DO BRAÇO DA SUSPENSÃO</p> <p>SEAT MALAGA GASOLINA</p> <p>d55x26mm 1f-d23mm</p>
	<p><b>M6016</b> NO. 357253137</p> <p>JUNTA DE ESCAPE</p> <p>SEAT CORDOBA (1993 A 1996)</p> <p>d66.7x16mm 1f-d45.5mm</p>		<p><b>M6048</b> NO. SE012006415A - SE012006145B - SE012006422B</p> <p>JUNTA DE ESCAPE</p> <p>SEAT MALAGA (1985 A 1992)</p> <p>135x72mm 2f-d41mm</p>
	<p><b>M6072</b> NO. 036253115 - 036253115A - 191253115B - 191253115H - 861253115A</p> <p>JUNTA DE ESCAPE</p> <p>SEAT CORDOBA (1993 A 1994)</p> <p>125x70mm 2f-d40mm</p>		<p><b>M6109</b> NO. 026129589A - 028129589B - 056129589A</p> <p>JUNTA DE ESCAPE</p> <p>SEAT CORDOBA (APÓS 02-1993)</p> <p>82x41mm 1f-38/27mm</p>



	<p><b>M6501</b> NO. 030129765D</p> <p>JUNTA DE CARBURADOR</p> <p>SEAT CORDOBA</p> <p>140x93x20mm 4p-d6-71mm</p>		<p><b>M6502</b> NO. 050129761A - 050129761B</p> <p>JUNTA DO CARBURADOR</p> <p>SEAT CORDOBA</p> <p>145x111x26mm NULL</p>
	<p><b>M6504</b> NO. 052129765 - 05212976JA</p> <p>JUNTA DO CARBURADOR</p> <p>SEAT CORDOBA</p> <p>140x110x17mm 4p-d6-65mm</p>		<p><b>P1013</b> NO. SE138126025A</p> <p>CAPA DE PEDAL DO TRAVÃO E EMBRAIAGEM</p> <p>SEAT MALAGA TT</p> <p>80x48x8mm NULL</p>
	<p><b>P1017</b> NO. 321721173</p> <p>CAPA DE PEDAL DO TRAVÃO E EMBRAIAGEM</p> <p>SEAT CORDOBA</p> <p>67x55x10mm NULL</p>		<p><b>R220700</b> NO. 021117207A - SE021117207A</p> <p>TUBO INFERIOR DO RADIADOR</p> <p>SEAT MALAGA</p> <p>B385-d34/34mm 70-175-120-50mm</p>
	<p><b>R220701</b> NO. SE021117205C - SE021117205</p> <p>TUBO SUPERIOR DE LIGAÇÃO DO TERMOSTATO AO RADIADOR</p> <p>SEAT MALAGA GASOLINA (1.2 - 1.5)</p> <p>B465-d32/32mm 100-90-205-80-50mm</p>		<p><b>R220704</b> NO. SE021117205E</p> <p>TUBO DE RADIADOR SUPERIOR</p> <p>SEAT MALAGA GASOLINA (1.2 - 1.5)</p> <p>NULL NULL</p>
	<p><b>R220706</b> NO. SE021117207C</p> <p>TUBO INFERIOR DO RADIADOR</p> <p>SEAT MALAGA DIESEL</p> <p>B505-d33-33mm 55-140-160-110-90mm</p>		<p><b>R220707</b> NO. SE021117205A</p> <p>TUBO DE RADIADOR SUPERIOR</p> <p>SEAT MALAGA DIESEL</p> <p>B390-d34/34mm 90-260-90mm</p>
	<p><b>R220710</b> NO. SE022104311A</p> <p>TUBO DE SAÍDA DE GASOLINA</p> <p>SEAT MALAGA TT</p> <p>B185-d50/50mm 45-95-45mm</p>		<p><b>R221800</b> NO. 6K0121101</p> <p>TUBO SUPERIOR DO RADIADOR</p> <p>SEAT CORDOBA 1.0 - 1.3 - 1.4 - 1.6</p> <p>B400-34/34mm 80-105-160-65-80mm</p>
	<p><b>R221801</b> NO. 6K0121051</p> <p>TUBO INFERIOR DO RADIADOR</p> <p>SEAT CORDOBA 1.0 - 1.3 - 1.4 - 1.6</p> <p>B415-d33/33mm 140-270-80mm</p>		<p><b>R221825</b> NO. 6Q0145832G - 6Q01145832J</p> <p>TUBO ADMISSÃO FILTRO DE AR</p> <p>SEAT CORDOBA (6L2) 1.4 TDI (05.05 A 11.09) 70cv 1422cc três volumes - SEAT CORDOBA (6L2) 1.4 TDI (10.02 A 12.05) 75cv 1422cc três volumes - SEAT CORDOBA (6L2) 1.4 TDI (06.05 A 11.09) 80cv 1422cc três volumes</p> <p>B170-47/47mm 110-110mm</p>
	<p><b>R221826</b> NO. 6Q0145828A - 6Q01475828P</p> <p>TUBO ADMISSÃO FILTRO DE AR</p> <p>SEAT CORDOBA (6L2) 1.4 TDI (10.02 A 12.05) 75cv 1422cc três volumes</p> <p>B280-34/38mm 80-180-80mm</p>		<p><b>R221906</b> NO.</p> <p>TUBO DE ADMISSÃO DO FILTRO DE AR</p> <p>SEAT CORDOBA (6K2) 1.9 TDI (06.99 - 10.02) 90cv 1896cc três volumes - SEAT CORDOBA Vario (6K5) 1.9 TDI (06.99 - 12.02) 90cv 1896cc Combi - SEAT IBIZA III (6K1) 1.9 TDI (08.99 - 02.02) 90cv 1896cc Hatchback - SEAT INCA (6K9) 1.9 TDI (09.96 - 06.03) 90cv 18</p> <p>B210-32/34mm 80-140-40mm</p>

	<b>RT08551</b> NO. 1H0611701 TUBO DE TRAVÃO FRENTE LH-RH SEAT CORDOBA TT (APÓS 02-1993)		<b>RT08643</b> NO. 1H0611775 TUBO DE TRAVÃO TRÁS LH-RH SEAT CORDOBA TT (02-1993 A 05-1999)
	<b>RT08903</b> NO. 1J0611775 - 6X0611775 TUBO DE TRAVÃO TRÁS LH-RH SEAT CORDOBA TT (APÓS 06 -1996)		<b>S1117</b> NO. 191407182 - 357407182 SILENT-BLOC BRAÇO DA SUSPENSÃO FRENTE SEAT CORDOBA
	<b>T0001</b> NO. SE138157020A BATENTE INFERIOR DA SUSPENSÃO TRÁS SEAT MALAGA TT		<b>T0634-I</b> NO. 6N0412303 A BATENTE SUSPENSÃO FRENTE SEAT CORDOBA Vario (6K5) 1.4 i (09.96 A 06.99) 60cv 1390cc Combi - SEAT CORDOBA (6K2) 1.0 (06.99 A 10.02) 50cv 999cc três volumes - SEAT CORDOBA (6K2) 1.4 (06.99 A 10.02) 60cv 1390cc três volumes - SEAT CORDOBA (6K2) 1.4 16V (05.00 A 10.02) 75cv 1390cc três volumes - SEAT CORDOBA (6K2) 1.4 16V (02.00 A 10.02) 100cv 1390cc três volumes - SEAT CORDOBA (6K2) 1.6 (06.99 A 10.02) 75cv 1598cc três volumes - SEAT CORDOBA (6K2) 1.6 (06.99 A 10...etc.
	<b>T1132</b> NO. 6Q0411314N - 6Q0411314R BATENTE DA BARRA ESTABILIZADORA DA FRENTE SEAT CORDOBA(6L2) 1.2 AZQ 64CV (10-2002 A 06-2006) - 1.2 12V BXV 70CV (05-2006 A 11-2009) - 1.4 16V AUB 100CV (10-2002 A 11-2009) - 1.4 16V BBY 75CV (09-2002 A 12-2007) - 1.4 16V BXW 86CV (05-2006 A 11-2009) - 1.4 TDI AMF 75CV (10-2002 A 12-2005) - 1.4 TD		<b>W5005</b> NO. 38105243 POLIE DA CAMBOTA (6 pistas) SEAT CORDOBA
	<b>W5039</b> NO. SK038105243K POLIE DA CAMBOTA (6 PISTAS) SEAT CORDOBA APÓS 1999 DTD		<b>W5122</b> NO. 038105243M - 038105243L POLIE DA CAMBOTA (6 PISTAS) SEAT - CORDOBA (6L2) - 1.9 SDI (09.02 - 11.09) 64cv 1896cc três volumes
	<b>W5124</b> NO. 045105243C - 045105243 - 045105143D POLIE DA CAMBOTA (6 PISTAS) SEAT - CORDOBA (6L2) - 1.4 TDI (05.05 - 11.09) 70cv 1422cc três volumes - SEAT - CORDOBA (6L2) - 1.4 TDI (10.02 - 12.05) 75cv 1422cc três volumes - SEAT - CORDOBA (6L2) - 1.4 TDI (06.05 - 11.09) 80cv 1422cc três volumes		<b>Z80774</b> NO. 6K0868243C Mola de painel SEAT CORDOBA













## SEAT EXEO



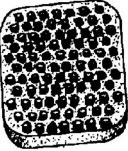

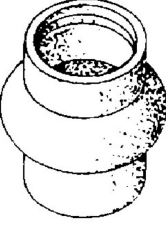

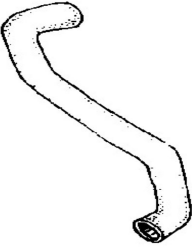
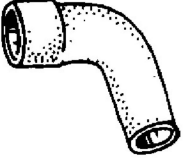
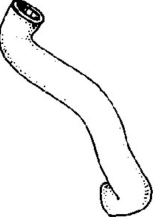

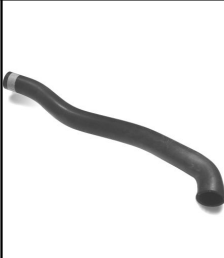
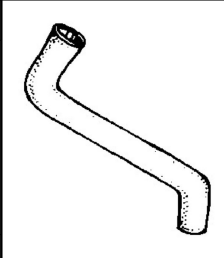

	<b>W5122</b> NO. 038105243M - 038105243L POLIE DA CAMBOTA (6 PISTAS) SEAT - EXEO (3R2) - 2.0 TDI Código do motor: CJCC (APÓS 12.08) 120cv 1968cc três volumes - SEAT - EXEO (3R2) - 2.0 TDI Código do motor: CJCA (APÓS 12.08) 143cv 1968cc três volumes SEAT - EXEO (3R2) - 2.0 TDI Código do motor: CGLB (APÓS 02.09) 170cv 1968cc		
d143mm	d29,5mm		

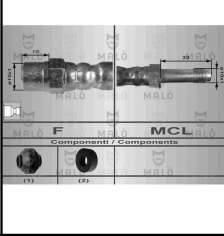
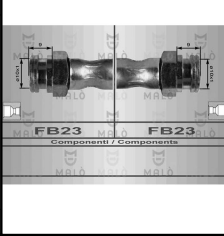
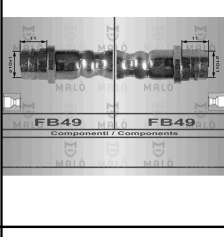

	<p><b>A1001</b> NO. SE138154605A</p> <p>SUPORTE DE MOTOR LADO DA CAIXA</p> <p>SEAT IBIZA TT</p> <p>138x80x48mm 1f-d12mm</p>		<p><b>A1001</b> NO. SE138154605A</p> <p>SUPORTE DE MOTOR LADO DA CAIXA</p> <p>SEAT IBIZA TT</p> <p>138x80x48mm 1f-d12mm</p>
	<p><b>A1003</b> NO. SE022154805B - XO 5920938 - SE138154605B - SE022154805A</p> <p>SUPORTE DO MOTOR</p> <p>SEAT IBIZA TT</p> <p>130x80x65mm 1f-d12mm</p>		<p><b>A1004</b> NO. SE831154205A</p> <p>SUPORTE DE MOTOR FRENTE</p> <p>SEAT IBIZA (1.2 - 1.5)</p> <p>135x85x58mm 1f-d12mm</p>
	<p><b>A1005</b> NO. SE700154205A</p> <p>SUPORTE FRENTE DO MOTOR</p> <p>SEAT IBIZA - IBIZA DIESEL</p> <p>135x80x48mm 1f-d12/15mm</p>		<p><b>A1025</b> NO. 191199402 - 191199402A - 191199402B - 191199402C</p> <p>SUPORTE DE MOTOR ESQUERDO (CAIXA DE VELOCIDADES)</p> <p>SEAT IBIZA</p> <p>145x82x76mm 1r-d9mm</p>
	<p><b>A1072</b> NO. 191412329 - 191412331</p> <p>SUPORTE DO AMORTECEDOR DA SUSPENSÃO FRENTE</p> <p>SEAT IBIZA</p> <p>d125x53mm 1f-d13mm</p>		<p><b>A1177</b> NO. 1H0199609B - 1H0199609D - 1H0199609E - 1H0199609F - 1H0199609J</p> <p>APOIO DE MOTOR DO LADO DIREITO (C/ CARÇAÇA)</p> <p>SEAT IBIZA</p> <p>150x125x110mm d85mm d83mm 1r-d9mm</p>
	<p><b>A1178</b> NO. 1H0199262E - 1H0199262F - 1H0199262G</p> <p>APOIO DE MOTOR FRENTE (S/ CARÇAÇA)</p> <p>SEAT IBIZA</p> <p>d105x135mm d75mm 2r-d10mm</p>		<p><b>E0015</b> NO. SE021115504A</p> <p>ESTICADOR DE ESCAPE</p> <p>SEAT IBIZA 1200 - 1500 L - GL - GLX - CLX - SXI INJECTION - 1700 LD - GLD DIESEL (APÓS 89)</p> <p>87x31x26.5mm NULL</p>
	<p><b>E0017</b> NO. SE138115503A - RF-115503 - RF138115503A</p> <p>SUPORTE DE ESCAPE</p> <p>SEAT IBIZA TT</p> <p>55x45x28mm NULL</p>		<p><b>E0071</b> NO. 191411327 - 191411315 - 191411315B</p> <p>ESTICADOR DE BARRA ESTABILIZADORA (PONTAS)</p> <p>SEAT IBIZA</p> <p>d40x94mm 1f-d15mm</p>
	<p><b>E0072</b> NO. 191411315A</p> <p>ESTICADOR DA BARRA ESTABILIZADORA</p> <p>SEAT IBIZA</p> <p>105x40x40mm 1f-d16mm</p>		<p><b>E0092</b> NO. 6Q0411315C - 6Q0411315F - 6Q0411315A - 6Q0411315B - 6Q0411315D - 6Q0411315E - 6Q0411315G - 6Q0411315H - 6Q0411315J</p> <p>ESTICADOR DA BARRA ESTABILIZADORA DA FRENTE</p> <p>SEAT IBIZA II - III TT (APÓS 1993)</p> <p>310x36x36mm 2p-d10-23mm</p>
	<p><b>E1090</b> NO. 6Q0253144G - 6X0253144G</p> <p>ESTICADOR DE ESCAPE</p> <p>SEAT IBIZA (APÓS 01-2002)</p> <p>130x90x45mm NULL</p>		<p><b>F0060-I</b> NO. HB-16213200</p> <p>FOLE DA CREMALHEIRA DA DIREÇÃO DIREITO (F1038)</p> <p>SEAT IBIZA</p> <p>d59x180mm d47mm 1f-d1f-d26mm 1f-d10mm</p>

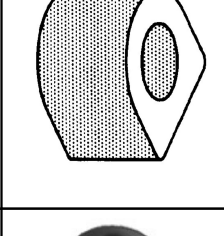
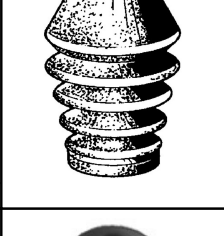

	<p><b>F0061-I</b> NO. HB-16212101 - HB16213101</p> <p>FOLE DA CREMALHEIRA DA DIRECÇÃO ESQUERDO</p> <p>SEAT IBIZA</p> <p>d59x118mm 1f-d41mm 1f-d10mm</p>		<p><b>F0514-I</b> NO. SE127141537A</p> <p>FOLE DO SEMI-EIXO JUNTO À RODA</p> <p>SEAT IBIZA TT</p> <p>d86x82mm 1f-d71mm 1f-d20mm</p>
	<p><b>F1057</b> NO. SE-138104311A</p> <p>FOLE DO DEPÓSITO DE GASOLINA</p> <p>SEAT IBIZA</p> <p>d73x73mm 2f-d49mm</p>		<p><b>F1060</b> NO. SE128141531A</p> <p>FOLE DA TRANSMISSÃO JUNTO À CAIXA DE VELOCIDADES</p> <p>SEAT IBIZA</p> <p>d93x88mm 1f-d72mm 1f-d30mm</p>
	<p><b>F1123-I</b> NO. 191419831</p> <p>FOLE DA DIRECÇÃO ASSISTIDA DIREITO E ESQUERDO</p> <p>SEAT IBIZA (APÓS 6-1993)</p> <p>d64x107mm 1f-d42mm 1f-d25mm</p>		<p><b>F1128A-I</b> NO. SE128141531A</p> <p>FOLE DO LADO DA CAIXA (COM d25.8mm)</p> <p>SEAT IBIZA</p> <p>d95x98mm 1f-d64mm 1f-d25mm</p>
	<p><b>F1841-I</b> NO. 6E0498201 - 6Q0498201C</p> <p>FOLE DA TRANSMISSÃO JUNTO À CAIXA</p> <p>SEAT IBIZA IV 1.4i 16V (APÓS 2002)</p> <p>d80x100mm 1f-d65mm 1f-d20mm</p>		<p><b>F4002</b> NO. XO39667470</p> <p>FOLE DA ALAVANCA DE VELOCIDADES</p> <p>SEAT IBIZA</p> <p>140x115x110mm 1f-115x90mm 1f-d24mm</p>
	<p><b>KF1172-T</b> NO. 1H0407283A - 1H0407285A - 1H0407285B - 1H0498203 - 1H0498203A - 1H0498285A - 6Q0498203A</p> <p>KIT DE FOLE DO CARDAN JUNTO À RODA</p> <p>SEAT IBIZA II 1.0i - 1.2i - 1.4 TDi PD R3 - 1.4i - 1.4i 16V - 1.6i - 1.8i - 1.8i 16V - 1.8i T CUPRA 20V - 1.9 SDi - 1.9 TD - 1.9 TDi - 1.9 TDi PD - 2.0i (APÓS 1993 A 1999) - IBIZA III 1.0i - 1.4i - 1.6i - 1.8 i.T - 1.9 TDi - 1.9 SDi (1999 A 2002) - IBIZA</p> <p>d115x130mm 1f-d85mm 1f-d26mm</p>		<p><b>KF1182-T</b> NO. 1J0498203A - 3B0498203B - 6Q0498203B - 8N0498203</p> <p>KIT DE FOLE DO CARDAN JUNTO À RODA</p> <p>SEAT IBIZA IV (APÓS 2002) 1.9 TDI PD</p> <p>d113x121mm 1f-d99mm 1f-d29mm</p>
	<p><b>KF1791-T</b> NO. 6Q0498203</p> <p>KIT DE FOLE DO CARDAN JUNTO À RODA</p> <p>SEAT IBIZA IV 1.4i 16V - 1.6i - 2.0i R4 8V (APÓS 2002)</p> <p>d100x120mm 1f-d85mm 1f-d26mm</p>		<p><b>KL0780A-I</b> NO.</p> <p>KIT REPARAÇÃO DA ALAVANCA À CAIXA</p> <p>SEAT IBIZA (1º MODELO)</p> <p>NULL NULL</p>
	<p><b>L0419-I</b> NO. HB-16213001 - SE138162130A</p> <p>CASQUILHO DE NYLON CREMALHEIRA DA DIRECÇÃO</p> <p>SEAT IBIZA</p> <p>28x28x18mm 1f-d21mm</p>		<p><b>L1001</b> NO. SE138156137A</p> <p>CASQUILHO DO BRAÇO DA SUSPENSÃO FRENTE</p> <p>SEAT IBIZA TT</p> <p>d30x39mm d25mm 1f-d9mm</p>
	<p><b>L1022</b> NO. 4227114</p> <p>CASQUILHO DO AMORTECEDOR TRASEIRO</p> <p>SEAT IBIZA</p> <p>d43x20mm 1f-12mm</p>		<p><b>L3006</b> NO. SE132156127A - 4125489</p> <p>CASQUILHO DO BRAÇO DA SUSPENSÃO</p> <p>SEAT IBIZA TT (EXCP. 0.9)</p> <p>d55x32mm 1f-d23mm</p>

	<p><b>M6016</b> NO. 357253137</p> <p>JUNTA DE ESCAPE</p> <p>SEAT IBIZA (1993 A 1996)</p> <p>d66.7x16mm 1f-d45.5mm</p>		<p><b>M6048</b> NO. SE012006415A - SE012006145B - SE012006422B</p> <p>JUNTA DE ESCAPE</p> <p>SEAT IBIZA (1984 A 1993)</p> <p>135x72mm 2f-d41mm</p>
	<p><b>M6072</b> NO. 036253115 - 036253115A - 191253115B - 191253115H - 861253115A</p> <p>JUNTA DE ESCAPE</p> <p>SEAT IBIZA (1993 A 1996)</p> <p>125x70mm 2f-d40mm</p>		<p><b>M6109</b> NO. 026129589A - 028129589B - 056129589A</p> <p>JUNTA DE ESCAPE</p> <p>SEAT IBIZA (APÓS 03-1993)</p> <p>82x41mm 1f-38/27mm</p>
	<p><b>M6501</b> NO. 030129765D</p> <p>JUNTA DE CARBURADOR</p> <p>SEAT IBIZA</p> <p>140x93x20mm 4p-d6-71mm</p>		<p><b>M6502</b> NO. 050129761A - 050129761B</p> <p>JUNTA DO CARBURADOR</p> <p>SEAT IBIZA</p> <p>145x111x26mm NULL</p>
	<p><b>M6504</b> NO. 052129765 - 05212976JA</p> <p>JUNTA DO CARBURADOR</p> <p>SEAT IBIZA</p> <p>140x110x17mm 4p-d6-65mm</p>		<p><b>P0009-R</b> NO. EA-16801301</p> <p>CAPA DE PEDAL TRAVÃO E EMBRAIAGEM</p> <p>SEAT IBIZA</p> <p>63x50x12mm NULL</p>
	<p><b>P1013</b> NO. SE138126025A</p> <p>CAPA DE PEDAL DO TRAVÃO E EMBRAIAGEM</p> <p>SEAT IBIZA TT</p> <p>80x48x8mm NULL</p>		<p><b>P1017</b> NO. 321721173</p> <p>CAPA DE PEDAL DO TRAVÃO E EMBRAIAGEM</p> <p>SEAT IBIZA</p> <p>67x55x10mm NULL</p>
	<p><b>R021872</b> NO. SE138104311A - 4382001</p> <p>TUBO DO DEPÓSITO DE GASOLINA</p> <p>SEAT IBIZA TT</p> <p>B70-d50/50mm 70mm</p>		<p><b>R220700</b> NO. 021117207A - SE021117207A</p> <p>TUBO INFERIOR DO RADIADOR</p> <p>SEAT IBIZA</p> <p>B385-d34/34mm 70-175-120-50mm</p>
	<p><b>R220701</b> NO. SE021117205C - SE021117205</p> <p>TUBO SUPERIOR DE LIGAÇÃO DO TERMOSTATO AO RADIADOR</p> <p>SEAT IBIZA (1.2 - 1.5)</p> <p>B465-d32/32mm 100-90-205-80-50mm</p>		<p><b>R220702</b> NO. SE021032170B</p> <p>TUBO DE LIGAÇÃO À BOMBA DE ÁGUA</p> <p>SEAT IBIZA (1.2 - 1.5)</p> <p>B140-d38/38mm 95-60mm</p>
	<p><b>R220704</b> NO. SE021117205E</p> <p>TUBO DE RADIADOR SUPERIOR</p> <p>SEAT IBIZA (1.2 - 1.5)</p> <p>NULL NULL</p>		<p><b>R220705</b> NO. SE021117207B</p> <p>TUBO DE RADIADOR INFERIOR</p> <p>SEAT IBIZA (0.9)</p> <p>B175-d28/28mm 60-55-65mm</p>

	<b>R220706</b> NO. SE021117207C TUBO INFERIOR DO RADIADOR SEAT IBIZA (FIAT) 1 - 7 DIESEL		<b>R220707</b> NO. SE021117205A TUBO DE RADIADOR SUPERIOR SEAT IBIZA DIESEL (1.7)
	B505-d33-33mm 55-140-160-110-90mm		B390-d34/34mm 90-260-90mm
	<b>R221800</b> NO. 6K0121101 TUBO SUPERIOR DO RADIADOR SEAT IBIZA		<b>R221801</b> NO. 6K0121051 TUBO INFERIOR DO RADIADOR SEAT IBIZA
	B400-34/34mm 80-105-160-65-80mm		B415-d33/33mm 140-270-80mm
	<b>R221808</b> NO. 6K0121051B TUBO DE RADIADOR INFERIOR SEAT IBIZA 2.0 DIESEL		<b>R8048</b> NO. SE021119501A TUBO DO AR FRIO SEAT IBIZA
	B315-d32/32mm 100-130-160mm		B350-d44/63mm 50-130-90-110-55mm
	<b>RT08551</b> NO. 1H0611701 TUBO DE TRAVÃO FRENTE LH-RH SEAT IBIZA II - III TT (APÓS 03-1993)		<b>RT08643</b> NO. 1H0611775 TUBO DE TRAVÃO TRÁS LH-RH SEAT IBIZA II - III TT (03-1993 A 08-1999)
	485mm F - MCL		160mm FB23 - FB23
	<b>RT08903</b> NO. 1J0611775 - 6X0611775 TUBO DE TRAVÃO TRÁS LH-RH SEAT IBIZA II-III (APÓS 1993) - TT (APÓS 09 -1999)		<b>S1077</b> NO. SE138156532A - 4404622 - 4386632 SILENT-BLOC DO BRAÇO DA SUSPENSÃO TRÁS SEAT IBIZA TT
	165mm FB49 - FB49		d40x43mm d30mm 1f-d12.5mm
	<b>S1117</b> NO. 191407182 - 357407182 SILENT-BLOC BRAÇO DA SUSPENSÃO FRENTE SEAT IBIZA		<b>S1144</b> NO. 6Q0407183A SILENT-BLOC DO BRAÇO DA SUSPENSÃO DA FRENTE SEAT IBIZA APÓS 2002
	d36x54mm d33mm 1f-d12mm		d71x51mm d64mm 1f-d18mm
	<b>T0001</b> NO. SE138157020A BATENTE INFERIOR DA SUSPENSÃO TRÁS SEAT IBIZA TT		<b>T0601-I</b> NO. 171412303C BATENTE SUPERIOR DA SUSPENSÃO FRENTE SEAT IBIZA
	30x30x20mm 1f-d16mm		d53x95mm 1f-d22mm 1f-d18mm
	<b>T0602-I</b> NO. 191512131 - 191512131B BATENTE DA SUSPENSÃO (TRÁS) SEAT IBIZA		<b>T0602-I</b> NO. 191512131 - 191512131B BATENTE DA SUSPENSÃO (TRÁS) SEAT IBIZA
	d55x142mm 1f-d10mm1f-d14mm		d55x142mm 1f-d10mm1f-d14mm

	<b>W5005</b>	NO. 38105243		<b>W5039</b>	NO. SK038105243K
	POLIE DA CAMBOTA (6 pistas) SEAT IBIZA II			POLIE DA CAMBOTA (6 PISTAS) SEAT IBIZA	
d138.8mm		d30mm	d138mm		d30mm
	<b>Z29990</b>	NO. 4B0867276A		<b>Z80774</b>	NO. 6K0868243C
	Mola de friso SEAT IBIZA			Mola de painel SEAT IBIZA	
16x3x10mm		NULL	d22x23mm		1p-d8.5-11.6mm
	<b>Z80791</b>	NO. 8Z0868243			
	Mola de painel SEAT IBIZA				
d21x22mm		1p-d10.5-13mm			



SEAT IBIZA (1)

	<b>A1066</b>	NO. SE021156228A - SE02156228A		<b>A1957</b>	NO. 4400895 - 4400905 - 7635775
	APOIO SUPERIOR DO AMORTECEDOR DIANTEIRO (SEM ROLAMENTO) SEAT IBIZA I 0.9 (08-1986 A 05-1993) - 1.2 (11-1984 A 12-1993) - 1.2 i (01-1989 A 05-1993) - 1.5 (11-1984 A 05-1993) - 1.5 i (10-1986 A 05-1993) - 1.5 i CAT. (10-1986 A 05-1993) - 1.7 (01-1991 A 05-1993) - 1.7 D (06-1984 A 05-1993)			APOIO AMORTECEDOR FRENTE DIREITO ESQUERDO SEAT IBIZA I (021A) 1.2 Ano fabric. at é: 07.86, Posição/grau: 1 ° (11.84 A 12.93) 60cv 1193cc Hatchback - SEAT IBIZA I (021A) 1.2 Ano fabric. at é: 07.86, Posição/grau: 1 ° (11.84 A 12.93) 63cv 1193cc Hatchback - SEAT IBIZA I (021A) 1.5 Ano fabric. at é: 07.86, Posição/grau: 1 ° (11.84 A 05.93) 85cv 1461cc Hatchback - SEAT IBIZA I (021A) 1.7 D Ano fabric. at é: 07.86, Posição/grau: 1 ° (06.84 A 05.93) 54cv 1714cc Hatchback	
d78x43mm		1f-d20mm	120x100x38mm		1f-d12mm 2p-d8x18mm
 ESC: 1/2	<b>C0229</b>	NO. SE128559910A - GA-5599100			
	BOTÃO DE AFINAÇÃO DO CAPOT (GRANDE) SEAT IBIZA I (021A) 0.9 Local de montagem: à frente 32kW 44CV 903cc Hatchback (DE 08-86 ATÉ 05-93) SEAT IBIZA I (021A) 1.2 i Local de montagem: à frente 52kW 71CV 1193cc Hatchback (DE 01-89 ATÉ 05-93) SEAT IBIZA I (021A) 1.5 i Local de montagem: à frente 74kW 100CV 1461cc Hatchback (DE 10-86 ATÉ 05-93)				
d18x44mm		NULL			



SEAT IBIZA (2)

	<b>A1937-C</b>	NO. 1J0412249 - 1J0412331 - 1J0412331B - 1J0412331BS		<b>F4102</b>	NO. 6K0711115G
	APOIO DO AMORTECEDOR SEAT IBIZA II (6K1) 1.0 i Posição/grau: 1 ° (09.96 A 08.99) 50cv 999cc Hatchback - SEAT IBIZA II (6K1) 1.0 Ano fabric. a partir de: 10.95 - Posição/grau: 1 ° (03.93 A 09.96) 45cv 1043cc Hatchback - SEAT IBIZA II (6K1) 1.3 i (03.93 A 08.99) 54cv 1272cc Hatchback - SEAT IBIZA II (6K1) 1.4 i (09.93 A 08.99) 60cv 1390cc Hatchback - SEAT IBIZA II (6K1) 1.4 i Ano fabric. a partir de: 10.95, Código do motor: ABD, Código do motor: AEX, Código do motor: AKV, Código do motor: APQ, Posição/grau: 1 ° (09...etc.			FOLE ALAVANCA VELOCIDADES SEAT IBIZA II (6K1) 1.0 i (09.96 A 08.99) 50cv 999cc Hatchback - SEAT IBIZA II (6K1) 1.0 (03.93 A 09.96) 45cv 1043cc Hatchback - SEAT IBIZA II (6K1) 1.3 i (03.93 A 08.99) 54cv 1272cc Hatchback - SEAT IBIZA II (6K1) 1.4 i (09.93 A 08.99) 60cv 1390cc Hatchback - SEAT IBIZA II (6K1) 1.4 i (09.94 A 08.99) 101cv 1390cc Hatchback - SEAT IBIZA II (6K1) 1.6 i (09.94 A 06.99) 75cv 1595cc Hatchback - SEAT IBIZA II (6K1) 1.6 i (04.96 A 08.99...etc.	
d82x55mm		1f-d14mm	160x200mm		1f-d18mm 1f-d100mm

## SEAT IBIZA (2)

	<b>F4111</b> NO. 6K0711115		<b>KL2763</b> NO. 028103638G - 028103665 - 028103937
	FOLE ALAVANCA VELOCIDADES SEAT IBIZA II (6K1) 1.0 i (09.96 A 08.99) 50cv 999cc Hatchback - SEAT IBIZA II (6K1) 1.0 (03.93 A 09.96) 45cv 1043cc Hatchback - SEAT IBIZA II (6K1) 1.3 i (03.93 A 08.99) 54cv 1272cc Hatchback - SEAT IBIZA II (6K1) 1.4 i (09.93 A 08.99) 60cv 1390cc Hatchback - SEAT IBIZA II (6K1) 1.4 i 16V (06.97 A 08.99) 101cv 1390cc Hatchback - SEAT IBIZA II (6K1) 1.6 i (09.94 A 06.99) 75cv 1595cc Hatchback - SEAT IBIZA II (6K1) 1.6 i (04.96 A 08.99)...etc.		KIT CASQUILHOS REPARAÇÃO CAIXA FILTRO OLEO SEAT IBIZA II (6K1) 1.0 i (09.96 A 08.99) 50cv 999cc Hatchback - SEAT IBIZA II (6K1) 1.0 (03.93 A 09.96) 45cv 1043cc Hatchback - SEAT IBIZA II (6K1) 1.3 i (03.93 A 08.99) 54cv 1272cc Hatchback - SEAT IBIZA II (6K1) 1.4 i (09.93 A 08.99) 60cv 1390cc Hatchback 2 / 3 - SEAT IBIZA II (6K1) 1.4 i 16V (06.97 A 08.99) 101cv 1390cc Hatchback - SEAT IBIZA II (6K1) 1.6 i (09.94 A 06.99) 75cv 1595cc Hatchback - SEAT IBIZA II (6K1) 1...etc.
	190x130mm 1f-d22mm 1f-d110mm		d28x19mm 1f-d9mm
	<b>T0634-I</b> NO. 6N0412303 A		
	BATENTE SUSPENSÃO FRENTE SEAT IBIZA II (6K1) 1.4 i 16V (06.97 A 08.99) 101cv 1390cc Hatchback - SEAT IBIZA III (6K1) 1.0 (08.99 A 02.02) 50cv 999cc Hatchback - SEAT IBIZA III (6K1) 1.4 (08.99 A 02.02) 60cv 1390cc Hatchback - SEAT IBIZA III (6K1) 1.4 16V (05.00 A 02.02) 75cv 1390cc Hatchback - SEAT IBIZA III (6K1) 1.4 16V (08.99 A 02.02) 100cv 1390cc Hatchback - SEAT IBIZA III (6K1) 1.6 (08.99 A 02.02) 75cv 1598cc Hatchback - SEAT IBIZA III (6K1) 1.6 (08.99 A 02.02)...etc.		
	d61x66mm 1f-d27mm 1f-d24mm		

## SEAT IBIZA (3)

	<b>A1937-C</b> NO. 1J0412249 - 1J0412331 - 1J0412331B - 1J0412331BS		<b>KL2763</b> NO. 028103638G - 028103665 - 028103937
	APOIO DO AMORTECEDOR SEAT IBIZA III (6K1) 1.6 (08.99 A 02.02) 75cv 1598cc Hatchback		KIT CASQUILHOS REPARAÇÃO CAIXA FILTRO OLEO SEAT IBIZA III (6K1) 1.0 (08.99 A 02.02) 50cv 999cc Hatchback - SEAT IBIZA III (6K1) 1.4 (08.99 A 02.02) 60cv 1390cc Hatchback - SEAT IBIZA III (6K1) 1.4 16V (05.00 A 02.02) 75cv 1390cc Hatchback - SEAT IBIZA III (6K1) 1.4 16V (08.99 A 02.02) 100cv 1390cc Hatchback - SEAT IBIZA III (6K1) 1.6 (08.99 A 02.02) 75cv 1598cc Hatchback - SEAT IBIZA III (6K1) 1.6 (08.99 A 02.02) 101cv 1595cc Hatchback - SEAT IBIZA...etc.
	d82x55mm 1f-d14mm		d28x19mm 1f-d9mm

## SEAT IBIZA (4)

	<b>E0269-M</b> NO. 6Q0199851A - 6Q0199851AS - 6Q0199851T		<b>KL2763</b> NO. 028103638G - 028103665 - 028103937
	ESTICADOR MOTOR TRÁS SEAT IBIZA IV (6L1) 1.9 SDI Tipo de caixa de velocidades: Caixa de velocidades manual (02.02 A 12.05) 64cv 1896cc Hatchback		KIT CASQUILHOS REPARAÇÃO CAIXA FILTRO OLEO SEAT IBIZA IV (6L1) 1.4 TDI (05.05 A 11.09) 70cv 1422cc Hatchback - SEAT IBIZA IV (6L1) 1.4 TDI (05.02 A 12.05) 75cv 1422cc Hatchback - SEAT IBIZA IV (6L1) 1.4 TDI (06.05 A 11.09) 80cv 1422cc Hatchback - SEAT IBIZA IV (6L1) 1.9 TDI (02.02 A 11.09) 100cv 1896cc Hatchback - SEAT IBIZA IV (6L1) 1.9 TDI (02.02 A 11.09) 131cv 1896cc Hatchback
	370x90x40mm 2f-12x10mm 2f-d10mm		d28x19mm 1f-d9mm
	<b>R221825</b> NO. 6Q0145832G - 6Q01145832J		<b>R221826</b> NO. 6Q0145828A - 6Q01475828P
	TUBO ADMISSÃO FILTRO DE AR SEAT IBIZA IV (6L1) 1.4 TDI (05.05 A 11.09) 70cv 1422cc Hatchback - SEAT IBIZA IV (6L1) 1.4 TDI (05.02 A 12.05) 75cv 1422cc Hatchback - SEAT IBIZA IV (6L1) 1.4 TDI (06.05 A 11.09) 80cv 1422cc Hatchback		TUBO ADMISSÃO FILTRO DE AR SEAT IBIZA IV (6L1) 1.4 TDI (05.02 A 12.05) 75cv 1422cc Hatchback
	B170-47/47mm 110-110mm		B280-34/38mm 80-180-80mm
	<b>T1132</b> NO. 6Q0411314N - 6Q0411314R		<b>W5122</b> NO. 038105243M - 038105243L
	BATENTE DA BARRA ESTABILIZADORA DA FRENTE SEAT IBIZA IV (6L1) 1.2 AZQ 64CV (02-2002 A 06-2006) - 1.2 BBM 60CV (06-2007 A 05-2008) - 1.2 12V BXV 70CV (05-2006 A 11-2009) - 1.4 16V AUB - BBZ 100CV (02-2002 A 11-2009) - 1.4 16V BBY 75CV (02-2002 A 12-2007) - 1.4 16V BXW 86CV (05-2006 A 11-2009) - 1.4		POLIE DA CAMBOTA (6 PISTAS) SEAT - IBIZA IV (6L1) - 1.9 SDI (02.02 - 12.05) 64cv 1896cc Hatchback
	35x38x34mm 30x32x24mm 1f-d18mm		d143mm d29,5mm









	<b>W5124</b>	NO. 045105243C - 045105243 - 045105143D		
	<p><i>POLIE DA CAMBOTA (6 PISTAS)</i></p> <p>SEAT - IBIZA IV (6L1) - 1.4 TDI (05.05 - 11.09) 70cv 1422cc Hatchback - SEAT - IBIZA IV (6L1) - 1.4 TDI N.º chas. a partir de: 6L-2-000 001 (05.02 - 12.05) 75cv 1422cc Hatchback - SEAT - IBIZA IV (6L1) - 1.4 TDI (06.05 - 11.09) 80cv 1422cc Hatchback</p>			
	d142mm	d29,5mm		

SEAT IBIZA (5)

	<b>F4106</b>	NO. 357413175A		<b>T0632-I</b>	NO. 1H0412303 B
	<p><i>FOLIE AMORTECEDORES FRENTE</i></p> <p>SEAT IBIZA V (6J5, 6P1) 1.2 TSI (A Partir de 08.12) 86cv 1197cc Hatchback - SEAT IBIZA V (6J5, 6P1) 1.2 TSI (A Partir de 09.10) 105cv 1197cc Hatchback - SEAT IBIZA V (6J5, 6P1) 1.2 (A Partir de 07.09) 60cv 1198cc Hatchback - SEAT IBIZA V (6J5, 6P1) 1.2 (A Partir de 03.08) 70cv 1198cc Hatchback - SEAT IBIZA V (6J5, 6P1) 1.4 (A Partir de 03.08) 85cv 1390cc Hatchback - SEAT IBIZA V (6J5, 6P1) 1.4 TSI (A Partir de 06.09) 150cv 1390cc Hatch...etc.</p>			<p><i>BATENTE SUSPENSÃO FRENTE</i></p> <p>SEAT IBIZA V (6J5 - 6P1) 1.2 TSI (APÓS 08.12) 86cv 1197cc Hatchback - SEAT IBIZA V (6J5 - 6P1) 1.2 TSI (APÓS 09.10) 105cv 1197cc Hatchback - SEAT IBIZA V (6J5 - 6P1) 1.2 (APÓS 07.09) 60cv 1198cc Hatchback - SEAT IBIZA V (6J5 - 6P1) 1.2 (APÓS 03.08) 70cv 1198cc Hatchback - SEAT IBIZA V (6J5 - 6P1) 1.4 (APÓS 03.08) 85cv 1390cc Hatchback - SEAT IBIZA V (6J5 - 6P1) 1.4 TSI (APÓS 06.09) 150cv 1390cc Hatchback - SEAT IBIZA V (6J5 - 6P1) 1.6...etc.</p>	
	d80x210mm	1f-d20mm 1f-d73mm		d49x64mm	1f-d18mm 1f-d22mm
	<b>T0633-I</b>	NO. 6Q0512131 C		<b>T0638-I</b>	NO. 1J0412303
	<p><i>BATENTE SUSPENSÃO FRENTE</i></p> <p>SEAT IBIZA V (6J5 - 6P1) 1.2 TSI (APÓS 09.10) 105cv 1197cc Hatchback - SEAT IBIZA V (6J5 - 6P1) 1.2 (APÓS 07.09) 60cv 1198cc Hatchback - SEAT IBIZA V (6J5 - 6P1) 1.2 (APÓS 03.08) 70cv 1198cc Hatchback - SEAT IBIZA V (6J5 - 6P1) 1.4 (APÓS 03.08) 85cv 1390cc Hatchback - SEAT IBIZA V (6J5 - 6P1) 1.4 TSI (APÓS 06.09) 150cv 1390cc Hatchback - SEAT IBIZA V (6J5 - 6P1) 1.6 (APÓS 05.08) 105cv 1598cc Hatchback - SEAT IBIZA V (6J5 - 6P1) 1.2 TD...etc.</p>			<p><i>BATENTE SUSPENSÃO DA FRENTE</i></p> <p>SEAT IBIZA V (6J5 - 6P1) 1.2 TSI (APÓS 08.12) 86cv 1197cc Hatchback - SEAT IBIZA V (6J5 - 6P1) 1.2 TSI (APÓS 09.10) 105cv 1197cc Hatchback - SEAT IBIZA V (6J5 - 6P1) 1.2 (APÓS 07.09) 60cv 1198cc Hatchback - SEAT IBIZA V (6J5 - 6P1) 1.2 (APÓS 03.08) 70cv 1198cc Hatchback - SEAT IBIZA V (6J5 - 6P1) 1.4 (APÓS 03.08) 85cv 1390cc Hatchback - SEAT IBIZA V (6J5 - 6P1) 1.4 TSI (APÓS 06.09) 150cv 1390cc Hatchback - SEAT IBIZA V (6J5 - 6P1) 1.6...etc.</p>	
	d58x126mm	1f-d17mm 1f-d17mm		d58x53mm	1f-d26mm 1f-d22mm
	<b>W5122</b>	NO. 038105243M - 038105243L		<b>W5124</b>	NO. 045105243C - 045105243 - 045105143D
	<p><i>POLIE DA CAMBOTA (6 PISTAS)</i></p> <p>SEAT - IBIZA V (6J5 - 6P5) - 1.2 TDI (APÓS 05.10) 75cv 1199cc Hatchback - SEAT - IBIZA V (6J5 - 6P5) - 1.6 TDI N.º chas. a partir de: 6J-A-076 980 (APÓS 05.09) 90cv 1598cc Hatchback - SEAT - IBIZA V (6J5 - 6P5) - 1.6 TDI Código do motor: CAYC - N.º chas. a pa</p>			<p><i>POLIE DA CAMBOTA (6 PISTAS)</i></p> <p>SEAT - IBIZA V SPORTCOUPE (6J1 - 6P1) - 1.4 TDI (07.08 - 06.10) 80cv 1422cc Coupé</p>	
	d143mm	d29,5mm		d142mm	d29,5mm

SEAT INCA

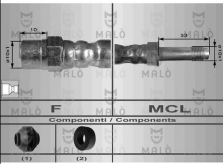
	<b>A1937-C</b>	NO. 1J0412249 - 1J0412331 - 1J0412331B - 1J0412331BS		<b>KL2763</b>	NO. 028103638G - 028103665 - 028103937
	<p><i>APOIO DO AMORTECEDOR</i></p> <p>SEAT INCA (6 K9) 1.4 i Posição/grau: 1 ° (11.95 A 06.03) 60cv 1390cc Caixa - SEAT INCA (6 K9) 1.4 16 V Posição / grau : 1 ° (04.00 A 06.03) 75cv 1390cc Caixa - SEAT INCA (6 K9) 1.6 i Posição/grau: 1 ° (11.95 A 05.98) 75cv 1595cc Caixa SEAT INCA (6 K9) 1.6 i Posição/grau: 1 ° (06.97 A 09.00) 75cv 1598cc Caixa - SEAT INCA (6 K9) 1.7 D Posição / grau : 1 ° (09.96 A 06.03) 57cv 1716cc Caixa - SEAT INCA (6 K9) 1.9 D Posição /...etc.</p>			<p><i>KIT CASQUILHOS REPARAÇÃO CAIXA FILTRO OLEO</i></p> <p>SEAT INCA (6 K9) 1.4 i 1.95 - 0.6.0.3.4.4.6.0.1.3.9.0 C a i x a S E AT IN CA (6 K 9) 1.4 1 6 V 0.4.0.0 - 0.6.0.3.5.5.7.5.1.3.9.0 C a i x a S E AT IN CA (6 K 9) 1.6 i 1.9.5 - 0.5.9.8.5.5.7.5.1.5.9.8 C a i x a S E AT IN CA (6 K 9) 1.6 i 0.6.9.7 - 0.9.0.0.5.5.7.5.1.5.9.8 C a i x a S E AT IN CA (6 K 9) 1.7 D 0.9.9.6 - 0.6.0.3.4.2.5.7.1.7.1.6 C a i x a S E AT IN CA (6 K 9) 1.9 D 1.1.9.5 - 0.6.0.3.4.7.6.4.1.8.9.6 C a i x a S E AT IN CA (6 ...etc.</p>	
	d82x55mm	1f-d14mm		d28x19mm	1f-d9mm
	<b>M6109</b>	NO. 026129589A - 028129589B - 056129589A		<b>M6501</b>	NO. 030129765D
	<p><i>JUNTA DE ESCAPE</i></p> <p>SEAT INCA (APÓS 11 - 95)</p>			<p><i>JUNTA DE CARBURADOR</i></p> <p>SEAT INCA</p>	
	82x41mm	1f-38/27mm		140x93x20mm	4p-d6-71mm

	<b>M6504</b>	NO. 052129765 - 05212976JA		<b>RT08551</b>	NO. 1H0611701
	JUNTA DO CARBURADOR SEAT INCA			TUBO DE TRAVÃO FRENTE LH-RH SEAT INCA TT (APÓS 11-1995)	
	140x110x17mm	4p-d6-65mm		485mm	F - MCL
	<b>W5005</b>	NO. 38105243			
	POLIE DA CAMBOTA (6 pistas) SEAT INCA 1.9 SDi (APÓS 11-1995) - 1.9 TDi (APÓS 09-1996)				
	d138.8mm	d30mm			

## SEAT LEON

	<b>A1921</b>	NO. 1K0253059BT - 1K0253059DF - 1K0253059HB - 1K0253144AE - 1K0254500Q		<b>E0182</b>	NO. 1J0411315H
	APOIO DO ESCAPE SEAT LEON (1P1) 1.6 N.º peças nec.: 1 - Código do motor: BSE - N.º chas. at é: 1P-7- 034 500 - ou: - N.º peças nec.: 1 - Código do motor: BSF - N.º chas. at é: 1P-7-034 500 - ou: - N.º peças nec.: 1 - Código do motor: CCSA - N.º chas. at é: 1P-7-034 500 (07.05 A 12.12) 102cv 1595cc Hatchback - SEAT LEON (1P1) 2.0 FSI N.º peças nec.: 1 - N.º chas. até: 1P-7-034 500 (07.05 A 05.10) 150cv 1984cc Hatchback - SEAT LEON (1P1) 2.0 T...etc.			ESTICADOR DA BARRA ESTABILIZADORA DA FRENTE SEAT LEON APÓS (CH:F1M1035001) 1.4 16V - 1.6 - 1.8 20V - 1.8 20V T - APÓS (CH: F1M1035001) - 1.6 16V (APÓS CH:F1M1035001) - 1.9 SDI - 1.9 TDI (90 -110 CV) (APÓS CH:F1M1035001) - 1.9 TDI (150 CV) - TOLEDO II 1.4 16V (APÓS 07 -1999) - 1.6 (04 -1999 A 09 -20	
	280x50x40mm	2f-d9mm 2f-d12mm		150x45x30mm	2f-d10mm
	<b>E1089</b>	NO. 8E0253147 - 4B0253144H - 4B0253144K - 8E0253144L - 8E0253144N - 8D0253144Q - 8D0253144D - 8D0253144M...		<b>E1091</b>	NO. 6X0253144B - 1J0253144L - 1J0253144K
	ESTICADOR DE ESCAPE SEAT LEON (APÓS 11 -1999)			ESTICADOR DE ESCAPE SEAT LEON (APÓS 03 -2000)	
	150x100x40mm	NULL		148x70x50mm	NULL
	<b>F0799B-I</b>	NO. 1J0498201E - 3D0598201 - 7M0407283 - 7M0498201 - 7M0498201A - 7M0498202 - 8E0498201A - 8N0498201A		<b>F4106</b>	NO. 357413175A
	FOLE DA TRANSMISSÃO JUNTO À CAIXA SEAT LEON 1.8i T CUPRA R - 1.9 TDi PD - 2.8i T CUPRA VR6 4 (APÓS 1999)			FOLE AMORTECEDORES FRENTE SEAT LEON (1M1) 1.4 16V (11.99 A 06.06) 75cv 1390cc Hatchback - SEAT LEON (1M1) 1.6 (11.99 A 06.06) 100cv 1595cc Hatchback - SEAT LEON (1M1) 1.6 (10.05 A 06.06) 102cv 1595cc Hatchback - SEAT LEON (1M1) 1.6 16 V (09.00 A 06.06) 105cv 1598cc Hatchback - SEAT LEON (1M1) 1.8 20V (11.99 A 06.06) 125cv 1781cc Hatchback - SEAT LEON (1M1) 1.8 20V T (11.99 A 06.06) 180cv 1781cc Hatchback - SEAT LEON (1M1) 1.8 20V T 4 (11.99 A 06.06) 180cv 178...etc.	
	d80x100mm	1f-d58mm 1f-d23mm		d80x210mm	1f-d20mm 1f-d73mm
	<b>F4109</b>	NO. 1J0711113		<b>F9048H-I</b>	NO. 5M0498203SK - 5M0498203
	FOLE ALAVANCA VELOCIDADES (COM MANETE) SEAT LEON (1M1) 1.4 16V (11.99 A 06.06) 75cv 1390cc Hatchback - SEAT LEON (1M1) 1.6 (11.99 A 06.06) 100cv 1595cc Hatchback - SEAT LEON (1M1) 1.6 (10.05 A 06.06) 102cv 1595cc Hatchback - SEAT LEON (1M1) 1.6 16 V (09.00 A 06.06) 105cv 1598cc Hatchback - SEAT LEON (1M1) 1.8 20V (11.99 A 06.06) 125cv 1781cc Hatchback - SEAT LEON (1M1) 1.8 20V T (11.99 A 06.06) 180cv 1781cc Hatchback - SEAT LEON (1M1) 1.8 20V T 4 (11.99 A 06.06) 180cv 178...etc.			FOLE DO CARDAN LADO DA RODA SEAT LEON (1P1) - 1.8 TSI Hatchback 1798cc 160CV (APÓS 06-2007) - 1.6 TDI Hatchback 1598cc 105CV (APÓS 02-2010) - SEAT LEON (5F1) 1.2 TSI Hatchback 1197cc 105CV (APÓS 01-2013) - 1.4 TSI Hatchback 1395cc 122CV (APÓS 11-2012) - 1.4 TSI Hatchback 1395CC 140	
	220x160x125mm	1f-140x105mm		d98x116mm	1f-d26mm 1f-d95mm
	<b>KF1172-T</b>	NO. 1H0407283A - 1H0407285A - 1H0407285B - 1H0498203 - 1H0498203A - 1H0498285A - 6Q0498203A		<b>KF1182-T</b>	NO. 1J0498203A - 3B0498203B - 6Q0498203B - 8N0498203
	KIT DE FOLE DO CARDAN JUNTO À RODA SEAT LEON 1.6i - 1.6i 16V - 1.8i 20V - 1.8i T 20V - 1.9 TDi (APÓS 1999)			KIT DE FOLE DO CARDAN JUNTO À RODA SEAT LEON (APÓS 1999) 1.8i T Cupra R - 1.9 TDi PD - 2.8i T Cupra VR6 4	
	d115x130mm	1f-d85mm 1f-d26mm		d113x121mm	1f-d99mm 1f-d29mm

	<p><b>KL2763</b> NO. 028103638G - 028103665 - 028103937</p> <p><b>KIT CASQUILHOS REPARAÇÃO CAIXA FILTRO OLEO</b></p> <p>SEAT LEON ( 1 M 1 ) 1.4 16 V (11.99 A 06.06) 75cv 1390cc Hatchback - SEAT LEON (1 M 1) 1.6 (11.99 A 06.06) 100cv 1595cc Hatchback - SEAT LEON ( 1 M 1 ) 1.6 (10.05 A 06.06) 102cv 1595cc Hatchback - SEAT LEON ( 1 M 1 ) 1.6 16 V (09.00 A 06.06) 105cv 1598cc Hatchback - SEAT LEON ( 1 M 1 ) 1.8 20 V 11.99 A 06.06) 125cv 1781cc Hatchback - SEAT LEON ( 1 M 1 ) 1.8 20 V T (11.99 A 06.06) 180cv 1781cc Hatchback - SEAT LEON (1 M 1) 1.8 20 V T ...etc.</p> <p>d28x19mm 1f-d9mm</p>		<p><b>M6109</b> NO. 026129589A - 028129589B - 056129589A</p> <p><b>JUNTA DE ESCAPE</b></p> <p>SEAT LEON (APÓS 11 -99)</p> <p>82x41mm 1f-38/27mm</p>
	<p><b>R221907</b> NO. 1J0145838B</p> <p><b>TUBO DE ADMISSÃO DO FILTRO DE AR</b></p> <p>SEAT LEON (1M1) 1.9 TDI (11.99 - 06.06) 90cv 1896cc Hatchback - SEAT LEON (1M1) 1.9 TDI (11.99 - 06.06) 110cv 1896cc Hatchback - SEAT TOLEDO II (1M2) 1.9 TDI (03.99 - 07.04) 90cv 1896cc três volumes - SEAT TOLEDO II (1M2) 1.9 TDI (10.98 - 07.04) 110cv 189</p> <p>B190-48/48mm 100-50-120mm</p>		<p><b>RT08616</b> NO. 1J0611701</p> <p><b>TUBO DE TRAVÃO FRENTE LH-RH</b></p> <p>SEAT LEON TT (APÓS 10-1999)</p> <p>435mm FB49 - OR22</p>
	<p><b>RT08903</b> NO. 1J0611775 - 6X0611775</p> <p><b>TUBO DE TRAVÃO TRÁS LH-RH</b></p> <p>SEAT LEON TT (APÓS 10 -1999)</p> <p>165mm FB49 - FB49</p>		<p><b>RT80623</b> NO. 1J0611764K</p> <p><b>TUBO DE TRAVÃO TRÁS RH</b></p> <p>SEAT LEON (1M1) 1.4 16V (11-1999 A 06-2006) - 1.6 (11-1999 A 06-2006) - 1.6 16V (09-2000 A 06-2006) - 1.8 20V (11-1999 A 2006) - 1.8 20V T (11-1999 A 2006) - 1.8 20V T4 811-1999 A 2006) - 1.8T CUPRA R (07-2003 A06-2006) - 1.8 TURBO 4X4 (05-2002 A 05-2003)</p> <p>805mm NULL</p>
	<p><b>T0632-I</b> NO. 1H0412303 B</p> <p><b>BATENTE SUSPENSÃO FRENTE</b></p> <p>SEAT LEON (1M1) 1.4 16V (11.99 A 06.06) 75cv 1390cc Hatchback - SEAT LEON (1M1) 1.6 (11.99 A 06.06) 100cv 1595cc Hatchback - SEAT LEON (1M1) 1.6 16 V (09.00 A 06.06) 105cv 1598cc Hatchback - SEAT LEON (1M1) 1.8 20V (11.99 A 06.06) 125cv 1781cc Hatchback 2/2 - SEAT LEON (1M1) 1.8 20V (11.99 A 06.06) 125cv 1781cc Hatchback - SEAT LEON (1M1) 1.8 20V T (11.99 A 06.06) 180cv 1781cc Hatchback - SEAT LEON (1M1) 1.8 T Cupra R (02.02 A 06.06) 209cv...etc.</p> <p>d49x64mm 1f-d18mm 1f-d22mm</p>		<p><b>T0637-I</b> NO. 1K0412303 B</p> <p><b>BATENTE SUSPENSÃO FRENTE</b></p> <p>SEAT LEON (1P1) 1.2 TSI para número PR: G39 - para número PR: G53 - para número PR: G40 - para número PR: G61 - para número PR: G52 - para número PR: G62 (02.10 A 12.12) 105cv 1197cc Hatchback - SEAT LEON (1P1) 1.4 16V para número PR: G39 - para número PR: G53 - para número PR: G40 - para número PR: G61 - para número PR: G52 - para número PR: G62 (06.06 A 12.12) 86cv 1390cc Hatchback - SEAT LEON (1P1) 1.4 TSI para número PR: G39 - ...etc.</p> <p>d61x70mm 1f-d27mm 1f-d22mm</p>
	<p><b>T0638-I</b> NO. 1J0412303</p> <p><b>BATENTE SUSPENSÃO DA FRENTE</b></p> <p>SEAT LEON (1M1) 1.4 16V (11.99 A 06.06) 75cv 1390cc Hatchback - SEAT LEON (1M1) 1.6 (11.99 A 06.06) 100cv 1595cc Hatchback - SEAT LEON (1M1) 1.6 (10.05 A 06.06) 102cv 1595cc Hatchback - SEAT LEON (1M1) 1.6 16 V (09.00 A 06.06) 105cv 1598cc Hatchback - SEAT LEON (1M1) 1.8 20V (11.99 A 06.06) 125cv 1781cc Hatchback - SEAT LEON (1M1) 1.8 20V T (11.99 A 06.06) 180cv 1781cc Hatchback - SEAT LEON (1M1) 1.8 20V T4 (11.99 A 06.06) 180cv 1781cc Hat...etc.</p> <p>d58x53mm 1f-d26mm 1f-d22mm</p>		<p><b>T0701-I</b> NO. 1J0512131C</p> <p><b>BATENTE SUSPENSÃO DA FRENTE</b></p> <p>SEAT LEON (1M1) 1.4 16V (11.99 A 06.06) 75cv 1390cc Hatchback - SEAT LEON (1M1) 1.6 (11.99 A 06.06) 100cv 1595cc Hatchback - SEAT LEON (1M1) 1.6 (10.05 A 06.06) 102cv 1595cc Hatchback - SEAT LEON (1M1) 1.6 16 V (09.00 A 06.06) 105cv 1598cc Hatchback - SEAT LEON (1M1) 1.8 20V (11.99 A 06.06) 125cv 1781cc Hatchback - SEAT LEON (1M1) 1.8 20V T (11.99 A 06.06) 180cv 1781cc Hatchback - SEAT LEON (1M1) 1.8 20V T 4 11.99 A 06.06) 180cv 1781cc Hat...etc.</p> <p>d58x147mm 1f-d16mm 1f-d15mm</p>
	<p><b>T1093</b> NO. 1J0411314T - 1J0411314G</p> <p><b>BATENTE DA BARRA ESTABILIZADORA DA FRENTE</b></p> <p>SEAT LEON (1M1) 1.4 16V - 1.6 - 1.8 20V - 1.8 20V T - 1.8 20V T4 - 1.9 SDi - 1.9 TDi - APÓS 11 -1999 - 1.6 16V APÓS 09 -2000 - 2.8 CUPRA 4 - APÓS 02 -01 - TOLEDO II (1M2) 1.4 16V - 1.6 - 1.8 20V - 1.9 TDi - 2.3 V5 - APÓS 04 -1999 - 1.6 16V - APÓS 09 -2000</p> <p>37x36x25mm 1f-d20mm</p>		<p><b>T1094</b> NO. 1J0411314C</p> <p><b>BATENTE DA BARRA ESTABILIZADORA DA FRENTE</b></p> <p>SEAT LEON (1M1) 1.4 16V - 1.6 - 1.6 16V - 1.8 20V - 1.8 20V T - 1.8 20V T4 - 1.9 SDi - 1.9 TDi - 2.8 CUPRA 4 APÓS 11 -99</p> <p>37x36x25mm 1f-d20mm</p>
	<p><b>T1148</b> NO. 1J0411314M - 1J0411314N - 1J0411314RS1 - 1J0411314R - 8N0411314B</p> <p><b>BATENTE DA BARRA ESTABILIZADORA DA FRENTE</b></p> <p>SEAT LEON (1M1) 1.4 16V Hatchback (11-1999 A 06-2006) 75CV 1390CC - SEAT LEON (1M1) 1.6 Hatchback (11-1999 A 06-2006) 100CV 1595CC - SEAT LEON (1M1) 1.6 16V Hatchback (09-2000 A 06-2006) 105CV 1598CC - SEAT LEON (1M1) 1.8 20V Hatchback (11-1999 A 06-2006)</p> <p>38x37x26mm 36x25x20mm</p>		<p><b>W5005</b> NO. 38105243</p> <p><b>POLIE DA CAMBOTA (6 pistas)</b></p> <p>SEAT LEON</p> <p>d138.8mm d30mm</p>
	<p><b>W5039</b> NO. SK038105243K</p> <p><b>POLIE DA CAMBOTA (6 PISTAS)</b></p> <p>SEAT LEON</p> <p>d138mm d30mm</p>		<p><b>W5122</b> NO. 038105243M - 038105243L</p> <p><b>POLIE DA CAMBOTA (6 PISTAS)</b></p> <p>SEAT - LEON (1P1) - 1.6 TDI (11.10 - 12.12) 90cv 1598cc Hatchback - SEAT - LEON (1P1) - 1.6 TDI (02.10 - 12.12) 105cv 1598cc Hatchback - SEAT - LEON (1P1) - 2.0 TDI 16V Código do motor: CFHC - CLCB (07.05 - 12.12) 140cv 1968cc Hatchback - SEAT - LEON (1P1)</p> <p>d143mm d29,5mm</p>

	<b>Z80791</b>	NO. 8Z0868243		
	Mola de painel SEAT LEON			
	d21x22mm	1p-d10.5-13mm		

## SEAT OCTAVIA

	<b>W5048</b>	NO. 03G105243 - 03G105243C - 03G105243E - 038105243E		
	POLIE DA CABBOTA (6 PISTAS) SEAT OCTAVIA (MOD 2004) 1.9 TDi APÓS 06 -2004 - Mtr BJB - BKC (105CV)			
	d143mm	d30mm		

## SEAT TOLEDO (1)

	<b>A1937-C</b>	NO. 1J0412249 - 1J0412331 - 1J0412331B - 1J0412331BS		<b>F4106</b>	NO. 357413175A
	APOIO DO AMORTECEDOR SEAT TOLEDO I (1L) 1.6 i Ano fabric. a partir de : 09.95 _ Posição / grau : 1 ° (05.91 A 03.99) 73cv 1595cc Hatchback - SEAT TOLEDO I (1L) 1.6 i Ano fabric. a partir de : 09.95 , Posição / grau : 1 ° (01.93 A 03.99) 75cv 1595cc Hatchback - SEAT TOLEDO I (1L) 1.6 i Posição/grau: 1 ° (11.96 A 03.99) 101cv 1595cc Hatchback - SEAT TOLEDO I (1L) 1.8 i Ano fabric. a partir de : 09.95 , Posição / grau : 1 ° (05.91 A 12.96) 88cv 17...etc.			FOLE AMORTECEDORES FRENTE SEAT TOLEDO I (1L) 1.6 i (11.96 A 03.99) 101cv 1595cc Hatchback - SEAT TOLEDO I (1L) 1.9 TDI (11.96 A 03.99) 110cv 1896cc Hatchback	
	d82x55mm	1f-d14mm		d80x210mm	1f-d20mm 1f-d73mm
	<b>F4107</b>	NO. 1L0711115C		<b>KL2763</b>	NO. 028103638G - 028103665 - 028103937
	FOLE ALAVANCA VELOCIDADES SEAT TOLEDO I (1L) 1.6 i (05.91 A 12.93) 71cv 1595cc Hatchback - SEAT TOLEDO I (1L) 1.6 i (05.91 A 03.99) 73cv 1595cc Hatchback - SEAT TOLEDO I (1L) 1.6 i (01.93 A 03.99) 75cv 1595cc Hatchback - SEAT TOLEDO I (1L) 1.6 i (11.96 A 03.99) 101cv 1595cc Hatchback - SEAT TOLEDO I (1L) 1.8 i (05.91 A 12.96) 88cv 1781cc Hatchback - SEAT TOLEDO I (1L) 1.8 i (11.93 A 12.96) 90cv 1781cc Hatchback - SEAT TOLEDO I (1L) 1.8 16V (05.91 A 03.99) 125...etc.			KIT CASQUILHOS REPARAÇÃO CAIXA FILTRO OLEO SEAT TOLEDO I (1L) 1.6 i (05.91 A 12.93) 71cv 1595cc Hatchback - SEAT TOLEDO I (1L) 1.6 i (05.91 A 03.99) 73cv 1595cc Hatchback - SEAT TOLEDO I (1L) 1.6 i (01.93 A 03.99) 75cv 1595cc Hatchback - SEAT TOLEDO I (1L) 1.6 i (11.96 A 03.99) 101cv 1595cc Hatchback - SEAT TOLEDO I (1L) 1.8 i (05.91 A 12.96) 88cv 1781cc Hatchback - SEAT TOLEDO I (1L) 1.8 i (11.93 A 12.96) 90cv 1781cc Hatchback - SEAT TOLEDO I (1L) 1.8 16V (05.91 A 03.99) 12...etc.	
	230x110mm	1f-d17mm 1f-d90mm		d28x19mm	1f-d9mm

## SEAT TOLEDO (2)

	<b>A1954</b>	NO. 1J0253144A		<b>F0799B-I</b>	NO. 1J0498201E - 3D0598201 - 7M0407283 - 7M0498201 - 7M0498201A - 7M0498202 - 8E0498201A - 8N0498201A
	APOIO DO ESCAPE SEAT TOLEDO II (1M2) 1.6 Local de mont agem: Painela de escape traseira (10.98 A 07.04) 100cv 1595cc três volumes - SEAT TOLEDO II (1M2) 1.8 20V Local de mont agem: Painela de escape traseira (10.98 A 07.04) 125cv 1781cc três volumes - SEAT TOLEDO II (1M2) 2.3 V5 Local de mont agem: Painela de escape traseira (10.98 A 11.00) 150cv 2324cc três volumes - SEAT TOLEDO II (1M2) 1.9 TDI Local de mont agem: Painela de escape traseira (03.99 A 07.04...etc.			FOLE DA TRANSMISSÃO JUNTO À CAIXA SEAT TOLEDO II 1.9 TDi PD (APÓS 1999)	
	160x115x90mm	2f-15x10mm 2f-d5mm 1f-d12mm		d80x100mm	1f-d58mm 1f-d23mm





	<p><b>F1790-I</b> NO. 1J0422831 - 1J0422831B - 8N0422831</p> <p>FOLE DA DIRECÇÃO ASSISTIDA DIREITO E ESQUERDO</p> <p>SEAT TOLEDO II - LEON</p> <p>d60x185mm 1f-d48mm 1f-d18mm</p>		<p><b>F4106</b> NO. 357413175A</p> <p>FOLE AMORTECEDORES FRENTE</p> <p>SEAT TOLEDO II (1M2) 1.6 (10.98 A 07.04) 100cv 1595cc três volumes - SEAT TOLEDO II (1M2) 1.6 16V (06.00 A 05.06) 105cv 1598cc três volumes - SEAT TOLEDO II (1M2) 1.8 20V (10.98 A 07.04) 125cv 1781cc três volumes - SEAT TOLEDO II (1M2) 1.8 20VT (09.00 A 07.04) 180cv 1781cc três volumes - SEAT TOLEDO II (1M2) 2.3 V5 (10.98 A 11.00) 150cv 2324cc três volumes - SEAT TOLEDO II (1M2) 2.3 V5 20V (09.00 A 11.03) 170cv 2324cc três volumes...etc.</p> <p>d80x210mm 1f-d20mm 1f-d73mm</p>
	<p><b>F4109</b> NO. 1J0711113</p> <p>FOLE ALAVANCA VELOCIDADES (COM MANETE)</p> <p>SEAT TOLEDO II (1M2) 1.4 16V (01.00 A 05.02) 75cv 1390cc três volumes - SEAT TOLEDO II (1M2) 1.6 (10.98 A 07.04) 100cv 1595cc três volumes - SEAT TOLEDO II (1M2) 1.6 16V (06.00 A 05.06) 105cv 1598cc três volumes - SEAT TOLEDO II (1M2) 1.8 20V (10.98 A 07.04) 125cv 1781cc três volumes - SEAT TOLEDO II (1M2) 1.8 20VT (09.00 A 07.04) 180cv 1781cc três volumes - SEAT TOLEDO II (1M2) 2.3 V5 (10.98 A 11.00) 150cv 2324cc três volumes - ...etc.</p> <p>220x160x125mm 1f-140x105mm</p>		<p><b>KF1182-T</b> NO. 1J0498203A - 3B0498203B - 6Q0498203</p> <p>KIT DE FOLE DO CARDAN JUNTO À RODA</p> <p>SEAT TOLEDO II (APÓS 1999) 1.9 TDI PD</p> <p>d113x121mm 1f-d99mm 1f-d29mm</p>
	<p><b>KL2763</b> NO. 028103638G - 028103665 - 028103937</p> <p>KIT CASQUILHOS REPARAÇÃO CAIXA FILTRO OLEO</p> <p>SEAT TOLEDO II (1M2) 1.9 TDI (03.99 A 07.04) 90cv 1896cc três volumes - SEAT TOLEDO II (1M2) 1.9 TDI (10.98 A 07.04) 110cv 1896cc três volumes - SEAT TOLEDO II (1M2) 1.9 TDI (05.03 A 05.06) 130cv 1896cc três volumes - SEAT TOLEDO II (1M2) 1.9 TDI (10.00 A 07.04) 150cv 1896cc três volumes</p> <p>d28x19mm 1f-d9mm</p>		<p><b>KT0508</b> NO. 1H0412303B</p> <p>KIT BATENTE AMORTECEDORES FRENTE</p> <p>SEAT TOLEDO II (1M2) 1.6 (10.98 A 07.04) 100cv 1595cc três volumes - SEAT TOLEDO II (1M2) 1.8 20V (10.98 A 07.04) 125cv 1781cc três volumes - SEAT TOLEDO II (1M2) 2.3 V5 (10.98 A 11.00) 150cv 2324cc três volumes - SEAT TOLEDO II (1M2) 1.9 TDI (03.99 A 07.04) 90cv 1896cc três volumes - SEAT TOLEDO II (1M2) 1.9 TDI (10.98 A 07.04) 110cv 1896cc três volumes - SEAT TOLEDO II (1M2) 1.9 TDI (05.03 A 05.06) 130cv 1896cc três volumes - ...etc.</p> <p>d80x210mm / d50x53mm 1f-d20mm 1f-d73mm / 1f-d18mm 1f-d23mm</p>
	<p><b>RT08616</b> NO. 1J0611701</p> <p>TUBO DE TRAVÃO FRENTE LH-RH</p> <p>SEAT TOLEDO II TT (APÓS 04-1999)</p> <p>435mm FB49 - OR22</p>		<p><b>RT08903</b> NO. 1J0611775 - 6X0611775</p> <p>TUBO DE TRAVÃO TRÁS LH-RH</p> <p>SEAT TOLEDO II TT (APÓS 04 -1999)</p> <p>165mm FB49 - FB49</p>
	<p><b>RT80623</b> NO. 1J0611764K</p> <p>TUBO DE TRAVÃO TRÁS RH</p> <p>SEAT TOLEDO II (1M2) 1.4 16V (07-1999 A 05-2006) - 1.6 (04-1999 A 05-2006) - 1.6 16V (09-2000 A 05-2006) - 1.8 4 RUOTE MOTRICI (05-2002 A 10-2005) - 1.8 20V (04-1999 A 05-2006) - 1.8 20 VT (05-2001 A 05-2006) - 1.9 SDi (11-1999 A 06-2004) - 1.9 TDi (04-199</p> <p>805mm NULL</p>		<p><b>T0632-I</b> NO. 1H0412303 B</p> <p>BATENTE SUSPENSÃO FRENTE</p> <p>SEAT TOLEDO II (1M2) 1.4 16V (01.00 A 05.02) 75cv 1390cc três volumes - SEAT TOLEDO II (1M2) 1.6 (10.98 A 07.04) 100cv 1595cc três volumes - SEAT TOLEDO II (1M2) 1.6 16V (06.00 A 05.06) 105cv 1598cc três volumes - SEAT TOLEDO II (1M2) 1.8 20V (10.98 A 07.04) 125cv 1781cc três volumes - SEAT TOLEDO II (1M2) 1.8 20VT (09.00 A 07.04) 180cv 1781cc três volumes - SEAT TOLEDO II (1M2) 2.3 V5 (10.98 A 11.00) 150cv 2324cc três volumes - SEAT ...etc.</p> <p>d49x64mm 1f-d18mm 1f-d22mm</p>
	<p><b>T0638-I</b> NO. 1J0412303</p> <p>BATENTE SUSPENSÃO DA FRENTE</p> <p>SEAT TOLEDO II (1M2) 1.6 (10.98 A 07.04) 100cv 1595cc três volumes - SEAT TOLEDO II (1M2) 1.6 16V (06.00 A 05.06) 105cv 1598cc três volumes</p> <p>d58x53mm 1f-d26mm 1f-d22mm</p>		<p><b>T0701-I</b> NO. 1J0512131C</p> <p>BATENTE SUSPENSÃO DA FRENTE</p> <p>SEAT TOLEDO II (1M2) 1.4 16V (01.00 A 05.02) 75cv 1390cc três volumes - SEAT TOLEDO II (1M2) 1.6 (10.98 A 07.04) 100cv 1595cc três volumes - SEAT TOLEDO II (1M2) 1.6 16V (06.00 A 05.06) 105cv 1598cc três volumes - SEAT TOLEDO II (1M2) 1.8 20V (10.98 A 07.04) 125cv 1781cc três volumes - SEAT TOLEDO II (1M2) 1.8 20VT (09.00 A 07.04) 180cv 1781cc três volumes - SEAT TOLEDO II (1M2) 2.3 V5 (10.98 A 11.00) 150cv 2324cc três volumes - SEAT ...etc.</p> <p>d58x147mm 1f-d16mm 1f-d15mm</p>
	<p><b>T1094</b> NO. 1J0411314C</p> <p>BATENTE DA BARRA ESTABILIZADORA DA FRENTE</p> <p>SEAT TOLEDO II(1M2) 1.4 16V - 1.6 - 1.6 16V - 1.8 20V - 1.9 TDi - 2.3 V5 - 2.3 V5 20V APÓS 04 -99</p> <p>37x36x25mm 1f-d20mm</p>		<p><b>W5005</b> NO. 38105243</p> <p>POLIE DA CAMBOTA (6 pistas)</p> <p>SEAT TOLEDO II TT (APÓS 1999)</p> <p>d138.8mm d30mm</p>
	<p><b>W5048</b> NO. 03G105243 - 03G105243C - 03G105243E - 038105243E</p> <p>POLIE DA CAMBOTA (6 PISTAS)</p> <p>SEAT TOLEDO II 1.9 TDi APÓS 05 -2003 - Mtr ASZ (130CV) APÓS MOTOR 435001 - TOLEDO II 1.9 TDi APÓS 04 -1999 - Mtr AGR - ALH - AHF - ASV (90-110CV)</p> <p>d143mm d30mm</p>		

## SEAT TOLEDO (3)

	<p><b>A1921</b> NO. 1K0253059BT - 1K0253059DF - 1K0253059HB - 1K0253144AE - 1K0254500Q</p> <p><b>APOIO DO ESCAPE</b></p> <p>SEAT TOLEDO III (5P2) 1.6 N.º peças nec.: 1 - Código do motor: BSE - N.º chas. até: 5P-7-021 500 - ou: - N.º peças nec.: 1 - Código do motor: BSF - N.º chas. até: 5P-7-021 500 (10.04 A 05.09) 102cv 1595cc Veículo multiuso - SEAT TOLEDO III (5P2) 2.0 FSI N.º peças nec.: 1 - N.º chas. até: 5P-7-021 500 (10.04 A 05.09) 150cv 1984cc Veículo multiuso - SEAT TOLEDO III (5P2) 2.0 TFSI N.º peças nec.: 1 - N.º chas. até: 5P-7-021 500...etc.</p> <p>280x50x40mm 2f-d9mm 2f-d12mm</p>		<p><b>T0637-I</b> NO. 1K0412303 B</p> <p><b>BATENTE SUSPENSÃO FRENTE</b></p> <p>SEAT TOLEDO III (5P2) 1.4 16V (05.06 A 05.09) 86cv 1390cc Veículo multiuso - SEAT TOLEDO III (5P2) 1.6 (10.04 A 05.09) 102cv 1595cc Veículo multiuso - SEAT TOLEDO III (5P2) 1.8 TFSI (01.07 A 05.09) 160cv 1798cc Veículo multiuso - SEAT TOLEDO III (5P2) 2.0 FSI (10.04 A 05.09) 150cv 1984cc Veículo multiuso - SEAT TOLEDO III (5P2) 2.0 TFSI (11.05 A 05.09) 200cv 1984cc Veículo multiuso - SEAT TOLEDO III (5P2) 1.9 TDI (10.04 A 05.09) 105cv ...etc.</p> <p>d61x70mm 1f-d27mm 1f-d22mm</p>
	<p><b>T0702-I</b> NO. 1K0412303H</p> <p><b>BATENTE SUSPENSÃO DA FRENTE</b></p> <p>SEAT TOLEDO III (5P2) 1.6 (10.04 A 05.09) 102cv 1595cc Veículo multiuso - SEAT TOLEDO III (5P2) 1.8 TFSI (01.07 A 05.09) 160cv 1798cc Veículo multiuso - SEAT TOLEDO III (5P2) 2.0 FSI (10.04 A 05.09) 150cv 1984cc Veículo multiuso - SEAT TOLEDO III (5P2) 1.9 TDI (10.04 A 05.09) 105cv 1896cc Veículo multiuso - SEAT TOLEDO III (5P2) 2.0 TDI 16V (04.04 A 05.09) 140cv 1968cc Veículo multiuso - SEAT TOLEDO III (5P2) 2.0 TDI (01.06 A 05.09) 17...etc.</p> <p>d50x93mm 1f-d27mm 1f-d25mm</p>		<p><b>W5048</b> NO. 03G105243 - 03G105243C - 03G105243E - 038105243E</p> <p><b>POLIE DA CAMBOTA (6 PISTAS)</b></p> <p>SEAT TOLEDO III 1.9 TDi APÓS 10 -2004 - Mtr BJB - BKC (105CV) - TOLEDO III 2.0 TDi APÓS 10 -2004 - Mtr BKD (140CV)</p> <p>d143mm d30mm</p>

## SEAT TOLEDO (4)

	<p><b>F4106</b> NO. 357413175A</p> <p><b>FOLE AMORTECEDORES FRENTE</b></p> <p>SEAT TOLEDO IV (KG3) 1.2 (A Partir de 07.12) 75cv 1198cc Hatchback - SEAT TOLEDO IV (KG3) 1.2 TSI (A Partir de 07.12) 86cv 1197cc Hatchback - SEAT TOLEDO IV (KG3) 1.2 TSI (A Partir de 07.12) 105cv 1197cc Hatchback - SEAT TOLEDO IV (KG3) 1.4 TSI (A Partir de 07.12) 122cv 1390cc Hatchback - SEAT TOLEDO IV (KG3) 1.6 (A Partir de 07.13) 105cv 1598cc Hatchback - SEAT TOLEDO IV (KG3) 1.6 TDI (A Partir de 06.13) 90cv 1598cc Hatchback - SEAT ...etc.</p> <p>d80x210mm 1f-d20mm 1f-d73mm</p>		<p><b>T0632-I</b> NO. 1H0412303 B</p> <p><b>BATENTE SUSPENSÃO FRENTE</b></p> <p>SEAT TOLEDO IV (KG3) 1.2 (APÓS 07.12) 75cv 1198cc Hatchback - SEAT TOLEDO IV (KG3) 1.2 TSI (APÓS 07.12) 86cv 1197cc Hatchback - SEAT TOLEDO IV (KG3) 1.2 TSI (APÓS 07.12) 105cv 1197cc Hatchback - SEAT TOLEDO IV (KG3) 1.4 TSI (APÓS 07.12) 122cv 1390cc Hatchback - SEAT TOLEDO IV (KG3) 1.6 (APÓS 07.13) 105cv 1598cc Hatchback - SEAT TOLEDO IV (KG3) 1.6 TDI (APÓS 06.13) 90cv 1598cc Hatchback - SEAT TOLEDO IV (KG3) 1.6 TDI (APÓS 07.12) 1...etc.</p> <p>d49x64mm 1f-d18mm 1f-d22mm</p>
	<p><b>W5122</b> NO. 038105243M - 038105243L</p> <p><b>POLIE DA CAMBOTA (6 PISTAS)</b></p> <p>SEAT - TOLEDO IV (KG3) - 1.6 TDI (APÓS 06.13) 90cv 1598cc Hatchback - SEAT - TOLEDO IV (KG3) - 1.6 TDI (APÓS 07.12) 105cv 1598cc Hatchback</p> <p>d143mm d29,5mm</p>		