

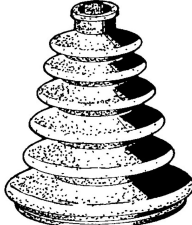







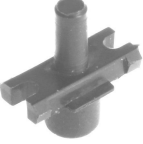

	<b>T0617-I</b> NO. 540503701R		<b>T0617-I</b> NO. 540503701R
	<b>BATENTE SUSPENSÃO FRENTE</b> RENAULT CAPTUR (J5_) 0.9 TCe 90 (APÓS 06.13) 90cv 898cc Hatchback - RENAULT CAPTUR (J5_) 1.2 TCe 120 (APÓS 01.16) 118cv 1197cc Hatchback - RENAULT CAPTUR (J5_) 1.2 TCe 120 (APÓS 06.13) 120cv 1197cc Hatchback - RENAULT CAPTUR (J5_) 1.5 dCi 90 (APÓS 06.13) 90cv 1461cc Hatchback - RENAULT CAPTUR (J5_) 1.5 dCi 110 (APÓS 01.15) 110cv 1461cc Hatchback		<b>BATENTE SUSPENSÃO FRENTE</b> RENAULT CLIO IV (BH_) 0.9 TCe 90 (APÓS 11.12) 90cv 898cc Hatchback - RENAULT CLIO IV (BH_) 1.2 16V (APÓS 11.12) 73cv 1149cc Hatchback - RENAULT CLIO IV (BH_) 1.2 TCe 120 (APÓS 03.13) 120cv 1197cc Hatchback - RENAULT CLIO IV (BH_) 1.6 RS (APÓS 03.13) 200cv 1618cc Hatchback - RENAULT CLIO IV (BH_) 1.5 dCi 75 (APÓS 11.12) 75cv 1461cc Hatchback - RENAULT CLIO IV (BH_) 1.5 dCi 90 (APÓS 11.12) 90cv 1461cc Hatchback - RENAULT CLIO IV Grandto...etc.
	d51x80mm 1f-d24mm 1f-d17mm		d51x80mm 1f-d24mm 1f-d17mm
	<b>T0617-I</b> NO. 540503701R		<b>T0617-I</b> NO. 540503701R
	<b>BATENTE SUSPENSÃO FRENTE</b> RENAULT CLIO IV (BH_) 0.9 TCe 90 (APÓS 11.12) 90cv 898cc Hatchback - RENAULT CLIO IV (BH_) 1.2 16V (APÓS 11.12) 73cv 1149cc Hatchback - RENAULT CLIO IV (BH_) 1.2 TCe 120 (APÓS 03.13) 120cv 1197cc Hatchback - RENAULT CLIO IV (BH_) 1.6 RS (APÓS 03.13) 200cv 1618cc Hatchback - RENAULT CLIO IV (BH_) 1.5 dCi 75 (APÓS 11.12) 75cv 1461cc Hatchback - RENAULT CLIO IV (BH_) 1.5 dCi 90 (APÓS 11.12) 90cv 1461cc Hatchback - RENAULT CLIO IV Grandto...etc.		<b>BATENTE SUSPENSÃO FRENTE</b> RENAULT ZOE (BFM_) ZOE (APÓS 06.12) 65cv 88cc Hatchback
	d51x80mm 1f-d24mm 1f-d17mm		d51x80mm 1f-d24mm 1f-d17mm



RENAULT

	<b>BE16</b> NO. 5433461		<b>BE17</b> NO. 75420467 - 5420467
	<b>ABRAÇADEIRA DE ESCAPE CÔNCAVA 66mm</b> RENAULT R15 (1976 A 1981) - R17 (1976 A 1981)		<b>ABRAÇADEIRA DE ESCAPE CÔNCAVA 49mm</b> RENAULT ESTAFE TT
	116x64x16mm 66mm		86x48x15mm 49mm
	<b>E0224-M</b> NO. 7700825794		<b>E1013</b> NO. 7700632015
	<b>ESTICADOR DO MOTOR PARTE DE TRÁS</b> RENAULT 2.0 16V (06-1995 A 03-2001) 2.0 16V (06-1995 A 03-2001) - 2.2 D (11-1993 A 03-2001) - 2.2 DT (03-1996 A 03-2001) - 3.0 (11-1993 A 03-2001) - 3.0 24V (03-1997 A 03-2001)		<b>ESTICADOR DE ESCAPE</b> RENAULT R14 (1976) - R18 (1976) - R20 (1976) - R25 - R30
	121x64x61mm 1f-d14mm 2f-d16-15mm		d64x13mm 1f-d41mm
	<b>F0366-I</b> NO. 7701450617		<b>F0901A2I</b> NO. 7701464141
	<b>FOLE DO SEMI-EIXO JUNTO À CAIXA DE VELOCIDADES (diam. 79mm)</b> RENAULT R15 - R16 - R17 - R18 - FUEGO		<b>FOLE DO SEMI-EIXO LADO DA CAIXA C/ ROLAMENTO d23.8mm</b> RENAULT
	d98x96mm 1f-d79 1f-d18mm		d115x78mm 1f-d87mm 1f-d23.8mm
	<b>F1087-I</b> NO. 7701201128		<b>G0029</b> NO.
	<b>FOLE DA TRANSMISSÃO LADO DA CAIXA</b> RENAULT ALPINE 1.4 TURBO		<b>GUARDA VENTO - PORTA C/ABA LATERAL</b> RENAULT
	d82x116 1f-d64mm 1f-d18mm		NULL NULL
	<b>H135</b> NO.		<b>KB2069</b> NO.
	<b>PALA</b> RENAULT		<b>KIT DA BARRA ESTABILIZADORA</b> RENAULT R14
	600x300mm NULL		NULL NULL

	<b>KB2071</b> NO. KIT DA BARRA ESTABILIZADORA (Diâmetro 12mm) RENAULT R14 - R6 - F4 - F6 NULL NULL		<b>KF2534</b> NO. KIT DE FOLE RENAULT LOBRO d95x128mm 1f-d80mm 1f-d26mm
	<b>KF2590</b> NO. KIT DE FOLE DO CARDAN JUNTO À RODA RENAULT 20 2.0 - 2.2 (1975 A 1983) d105x150mm 1f-d86mm 1f-d30mm		<b>KF2590</b> NO. KIT DE FOLE DO CARDAN JUNTO À RODA RENAULT 30 2.1 TD - 2.6 - 2.6 TS - 2.6 TX (1975 A 1986) d105x150mm 1f-d86mm 1f-d30mm
	<b>MT6700</b> NO. JUNTA DE TERMOSTATO RENAULT 14 (GASOLINA-DIESEL) d52x2mm 1f-d43mm		<b>N4021</b> NO. ANEL DE ESCAPE RENAULT 14 - R18 - R20 - 30 - FUEGO d60x14mm 1f-d33mm
	<b>R220343</b> NO. 7700589953 TUBO DE RADIADOR SUPERIOR RENAULT R14 TT B515-d34/34mm 70-90-110-150-80-60mm		<b>R220358</b> NO. 7700628625 - 13879200 TUBO DO AQUECIMENTO RENAULT R14 TT B420-d30/30mm 85-200-100-90mm
	<b>R220458</b> NO. 7700628625 TUBO DO AQUECIMENTO RENAULT R14 TT B350-d15/15mm 180-80-190-115-65-75-55mm		<b>R220459</b> NO. 7700628623 TUBO DO AQUECIMENTO RENAULT R14 TT B465-d17/17mm 85-220-70-100-75mm
	<b>R220461</b> NO. 7700625645 TUBO DO AQUECIMENTO RENAULT R14 TT B380-d18/18mm 105-220-245mm		<b>S1504</b> NO. 23000529701 SILENT BLOC DAS MOLAS DA FRENTE RENAULT MIDLANDS (CAMIÃO) d52x95mm d43x66mm 1f-d10mm
	<b>T1005</b> NO. BATENTE DE ESTABILIZADOR RENAULT 75x38x32mm 1f-d12mm 1f-d13mm		<b>UBV8011</b> NO. BOMBA VACUO (KIT REPARAÇÃO MODELO INCLINADO) (LARG. 51mm) RENAULT (DIESEL) 41x51mm 2f-d5mm
	<b>UBV8013</b> NO. BOMBA VACUO (KIT REPARAÇÃO NOVO MODELO) (LARG. 51mm) RENAULT (DIESEL) 51x51mm 2f-d5mm		<b>UBV8014</b> NO. BOMBA VACUO (KIT REPARAÇÃO) (NOVO MODELO) RENAULT (DIESEL) d105x2mm 9f-d5mm







	<b>Z03477</b> NO.		<b>Z10892</b> NO. 698681 - 14570180 - 7703079072 - A0009957644
	Mola de fixação Renault		Mola de fixação RENAULT (TODOS)
	13x8.3x4.8mm NULL		22x8.4x26mm 1f-17mm
	<b>Z80280</b> NO.		<b>Z80452</b> NO.
	Mola de friso Renault		Mola de fixação Renault
	12x6.5x13mm 1p-d5-4.6mm		16x15x6mm NULL
	<b>Z80470</b> NO. 164361 - 7703072177		<b>Z80534</b> NO.
	Mola de fixação RENAULT (TODOS)		Mola de retenção Renault
	d5x45mm NULL		16.5x10x15.4mm 1p-13x7.6-13.4mm 1f-d4.5mm
	<b>Z80579</b> NO. 14569880		<b>Z80757</b> NO. 7703079338 - 6992H3
	Mola de fixação RENAULT (TODOS)		Mola de painel RENAULT (TODOS)
	19.6x8x20mm 1f-11mm		47.5x10x45.5mm 1p-d8-9mm
	<b>Z80787</b> NO. 1039463 - 8E0825267		<b>Z80804</b> NO. 7701408860
	Mola de fixação RENAULT (TODOS)		MOLA DE FRISO LATERAL PORTA RENAULT RENAULT
	d20x34mm 1p-d8.5-21mm		28x10x6mm NULL
	<b>Z80839</b> NO. 6001549265		
	Mola de painel RENAULT LOGAN		
	d18x20.8mm 1p-d9-13.8mm		

RENAULT 10

	<b>R220311</b> NO. 7700503302		<b>R220311</b> NO. 7700503302
	TUBO INFERIOR DO RADIADOR RENAULT 10 (119_) 1.1 (05.66 A 10.72) 45cv 1108cc três volumes - RENAULT 10 (119_) 1.3 (07.69 A 10.72) 48cv 1289cc três volumes		TUBO INFERIOR DO RADIADOR RENAULT 8 (113_) 1.0 (11.62 A 10.72) 39cv 980cc três volumes - RENAULT 8 (113_) 1.1 (11.62 A 10.72) 45cv 1108cc três volumes
	B240-d32/32mm 90-80-80140mm		B240-d32/32mm 90-80-80140mm

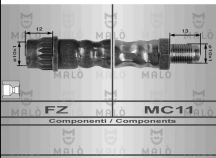
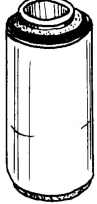
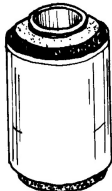
	<p><b>A0808-10</b> NO. 7700523095 - 0855649200</p> <p>SUPORTE DE ESCAPE (PERNO 10mm)</p> <p>RENAULT R12 TT</p>		<p><b>A0808-8</b> NO. 7700565762</p> <p>SUPORTE DE ESCAPE (PERNO 8mm)</p> <p>RENAULT R12 TT</p>
	<p><b>A0813</b> NO. 8300608 - 7700575465</p> <p>SUPORTE DA CAIXA</p> <p>RENAULT R12 TT</p>		<p><b>A1151</b> NO. 7700506311</p> <p>SUPORTE TRASEIRO DO MOTOR</p> <p>RENAULT R12</p>
	<p><b>A1156</b> NO. 7700504590</p> <p>SUPORTE DIANTEIRO DO MOTOR</p> <p>RENAULT R12</p>		<p><b>E0070</b> NO. 7701453465 - 7700504548</p> <p>ESTICADOR DE BARRA ESTABILIZADORA</p> <p>RENAULT R12 - R18 (ATÉ 81)</p>
	<p><b>F0380-I</b> NO. 7701457538 - 7701200694</p> <p>FOLE SEMI-EIXO DOLADO DA RODA(DIAM. 86mm EIXO 20mm) (F1010)</p> <p>RENAULT R12 - R15 - R17 (23 mm) - R14 (20mm) - R18 TS GTS (1978 A 1981) - R20 - FUEGO GTS</p>		<p><b>F0380A-I</b> NO. 7701457533 - 7701200694</p> <p>FOLE DO SEMI-EIXO JUNTO À RODA</p> <p>RENAULT R12 - R15 - R17 (23 mm) - R14 (20mm) - R18 TS GTS (1978 A 1981) - R20 - FUEGO GTS</p>
	<p><b>F1087-I</b> NO. 7701201128</p> <p>FOLE DA TRANSMISSÃO LADO DA CAIXA</p> <p>RENAULT R12 1.3 - R18 1650CC - FUEGO</p>		<p><b>L3000</b> NO. 7700547187</p> <p>CASQUILHO DO TIRANTE DA ARTICULAÇÃO</p> <p>RENAULT R12</p>
	<p><b>L3003</b> NO. 0854629300 - 7702105447 - 0855590000 - 77021348974 - 7701348973</p> <p>CASQUILHO DA DIREÇÃO INFERIOR</p> <p>RENAULT R12 BREAK</p>		<p><b>N1204</b> NO.</p> <p>ANEL DE ESCAPE</p> <p>RENAULT R12 - R14 - R18 - R20</p>
	<p><b>N2331</b> NO. 7700518505 - 7703065102</p> <p>ANEL ESCAPE</p> <p>RENAULT R12 (1970 A 1980) - R18 (1977 A 1986)</p>		<p><b>R0717</b> NO.</p> <p>TUBO SUPERIOR DO RADIADOR</p> <p>RENAULT 12</p>
	<p><b>R0718</b> NO.</p> <p>TUBO INFERIOR DO RADIADOR</p> <p>RENAULT R12</p>		<p><b>R220340</b> NO. 7700521706 - 7700537797 - 7700521704</p> <p>TUBO DE RADIADOR SUPERIOR</p> <p>RENAULT R12 TT - R15 TL</p>







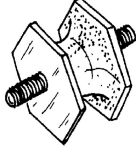



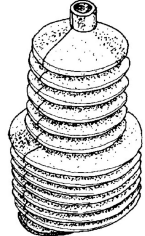

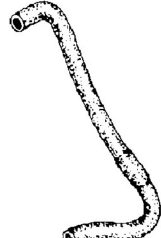
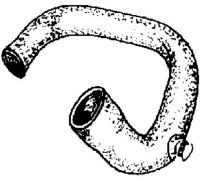

	<p><b>R220341</b> NO. 7700517359 - 7700537799</p> <p>TUBO DE RADIADOR INFERIOR</p> <p>RENAULT R12 TT - R15 TL</p> <p>B180-d35/35mm 90-80-50mm</p>		<p><b>R220455</b> NO. 7700516244</p> <p>TUBO DO AQUECIMENTO</p> <p>RENAULT R12</p> <p>B270-d17/17mm 235-210-85-410-160-80mm</p>
	<p><b>RT08496</b> NO. 7704003887 - 7704003949</p> <p>TUBO DE TRAVÃO FRENTE LH-RH</p> <p>RENAULT 12 1.3 (10-1969 A 08-1980) - 1.3 TS (08-1972 A 08-1980) - 1.4 (08-1976 A 05-1979) - 1.6 GORDINI (08-1970 A 12-1974)</p> <p>270mm FZ - MC11</p>		<p><b>S1084</b> NO. 7702107331 - 7700514110 - 7701348038 - 7701348039 - 7705040000</p> <p>SILENT-BLOC TRAPÉZIO SUPERIOR DA SUSPENSÃO FRENTE</p> <p>RENAULT R12 TT</p> <p>d27x51mm c43mm 1f-d14mm</p>
	<p><b>S1085</b> NO. 7700514109 - 7700660462 - 7700683789 - 7701348040 - 7704001599 - 7704001600 - 7704001601</p> <p>SILENT-BLOC TRAPÉZIO INFERIOR</p> <p>RENAULT R12 TT</p> <p>d32x46mm c38mm 1f-d14mm</p>		<p><b>S1201</b> NO. 7700525816 - 7700535085</p> <p>SILENT-BLOC DO SUPORTE LATERAL DO MOTOR</p> <p>RENAULT R12</p> <p>d34x28mm c25mm 1f-d9.5mm</p>
	<p><b>S1524</b> NO. 7700553704 - 7701348048</p> <p>SILENT BLOC DA SUSPENSÃO DE TRÁS</p> <p>RENAULT 12 1.3 (1170) (07-1975 A 04-1980) 50CV 1289CC - RENAULT 13 1.3 (1170) (10-1969 A 08-1980) 54CV 1289CC - RENAULT 12 1.3 TS (1177-1337) (08-1972 A 08-1980) 60CV 1289CC - RENAULT 12 1.6 GORDINI (1173) (08-1970 A 12-1974) 113CV 1565CC - RENAULT 12 VAR</p> <p>d52x32mm c28mm 1f-d10mm</p>		<p><b>T1018</b> NO. 7700765935 - 7700503438</p> <p>BATENTE DE ESTABILIZADOR</p> <p>RENAULT R12</p> <p>42x34x24mm 1f-d14mm</p>
	<p><b>Z80247</b> NO. 14188380</p> <p>Mola de painel</p> <p>RENAULT 12</p> <p>d16x18.6mm 1p-d7.5-12.6mm</p>		

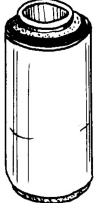
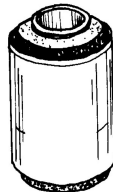
RENAULT 16







	<p><b>A0808-10</b> NO. 7700523095 - 0855649200</p> <p>SUPORTE DE ESCAPE (PERNO 10mm)</p> <p>RENAULT R16 TT</p> <p>48x42x27mm 2p-d10-18mm</p>		
---	--	--	--

	<b>A0808-10</b> NO. 7700523095 - 0855649200 SUPORTE DE ESCAPE (PERNO 10mm) RENAULT R18 48x42x27mm 2p-d10-18mm		<b>A0808-8</b> NO. 7700565762 SUPORTE DE ESCAPE (PERNO 8mm) RENAULT R18 TT 48x42x27mm 2p-d8-18mm
	<b>A0813</b> NO. 8300608 - 7700575465 SUPORTE DA CAIXA RENAULT R18 TT 33x22x18mm 2p-d6-19mm		<b>A1000</b> NO. 7700692341 - 7701349504 SUPORTE DE MOTOR CENTRAL CAIXA 5 VEL. RENAULT R18 GTX 182x163x50mm NULL
	<b>A1152</b> NO. 7704000769 SUPORTE ESQUERDO DO MOTOR RENAULT R18 DIESEL - R18 GTX - FUEGO 140x120x70mm 1p-d10-27mm		<b>A1153</b> NO. 7704000829 SUPORTE DIANTEIRO DO MOTOR RENAULT R18 DIESEL - R18 GTX - FUEGO 74x54x50mm 1f-d10mm 2p-d8-22mm
	<b>A1154</b> NO. 7704000622 SUPORTE DO MOTOR RENAULT R18 52x48x38mm 2p-d8-22mm		<b>A1155</b> NO. 7700629061 SUPORTE DO MOTOR RENAULT R18 62x53x48mm 1f-d8mm 1p-d8-23mm
	<b>A1157</b> NO. 7704000622 SUPORTE DE MOTOR RENAULT R18 130x120x120mm NULL		<b>A1158</b> NO. 7704000469 SUPORTE DIANTEIRO DO MOTOR RENAULT R18 GTX 94x83x73mm 2p-d10-23mm
	<b>A1159</b> NO. 7704000777 SUPORTE DE MOTOR RENAULT R18 - ESPACE 110x87x65mm 1p-d10-19mm		<b>A1281</b> NO. 7704000767 APOIO SUPERIOR DIREITO DO MOTOR RENAULT 18 GTX - 18 DIESEL - FUEGO d65x48mm 2p-d10mm
	<b>E0018</b> NO. ESTICADOR DE ESCAPE RENAULT R18 TT - R20 68x54x25mm NULL		<b>E1001</b> NO. 7700655644 - 7704001364 SUPORTE DE ESCAPE RENAULT R18 TT - R20 TT - FUEGO TT d63x23mm NULL
	<b>F0510-I</b> NO. 7700653459 FOLE DA DIRECÇÃO RENAULT R18 TL - GTL - TS - GTS - FUEGO - R20 d72x160mm 1f-d10mm 1f-d40mm		<b>F0572-I</b> NO. 7701348568 - 7701348694 FOLE DO SEMI-EIXO JUNTO À RODA DIREITO RENAULT R18 - R21 d93x117mm 1f-d81mm 1f-d30mm



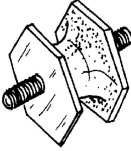
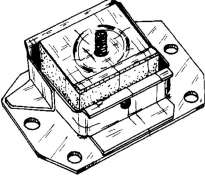
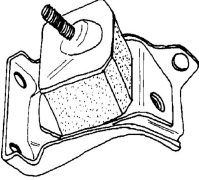
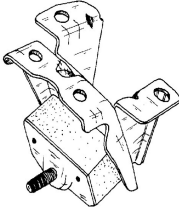



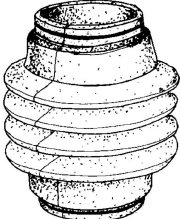
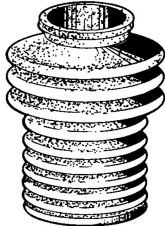

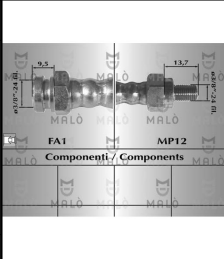
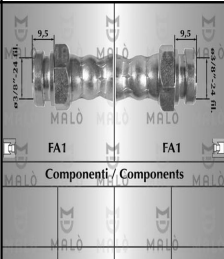
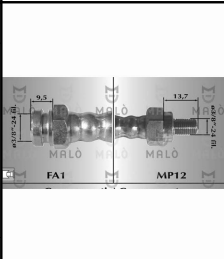
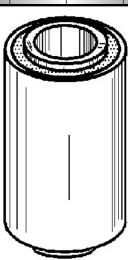

	<p><b>F0830-1I</b> NO.</p> <p>FOLE DA TRANSMISSÃO JUNTO À CAIXA</p> <p>RENAULT R18 1.6T (10-1982 A 07-1986)</p> <p>d90x113mm 1f-d24mm 1f-d73mm</p>		<p><b>F1108-I</b> NO. 7700706007 - 7700781095</p> <p>FOLE DA DIREÇÃO ASSISTIDA+G1485</p> <p>RENAULT R18 - R19 - R20 - 25</p> <p>d74x140mm 1f-d40mm 1f-d9mm</p>
	<p><b>R220367</b> NO. 7700633528</p> <p>TUBO DE RADIADOR</p> <p>RENAULT R18</p> <p>B130-d20/20mm 65-70mm</p>		<p><b>R220368</b> NO. 7700633530 - 7704001360</p> <p>TUBO DE CHAUFAGEM</p> <p>RENAULT R18 TT</p> <p>B350-d17/17mm 75-220-95-80-70mm</p>
	<p><b>R220462</b> NO. 7700651584 - 7704001346</p> <p>TUBO DE RADIADOR SUPERIOR C/ RESPIRO</p> <p>RENAULT R18 GTS</p> <p>B170-d41/41mm 120-140-170-95mm</p>		<p><b>R220600</b> NO. 7704001347</p> <p>TUBO DE RADIADOR SUPERIOR C/ RESPIRO</p> <p>RENAULT R18 GTS</p> <p>B225-d32/32mm 120-180-195-110mm</p>
	<p><b>R220601</b> NO. 7704001409</p> <p>TUBO DE RADIADOR SUPERIOR</p> <p>RENAULT R18 DIESEL</p> <p>B280-d36/36mm 60-80-50-75-40mm</p>		<p><b>R220602</b> NO. 7704001338</p> <p>TUBO DE RADIADOR INFERIOR</p> <p>RENAULT R18 DIESEL</p> <p>B285-d30/30mm 50-60-70-155-70mm</p>
	<p><b>S1084</b> NO. 7702107331 - 7700514110 - 7701348038 - 7701348039 - 7705040000</p> <p>SILENT-BLOC TRAPÉZIO SUPERIOR DA SUSPENSÃO FRENTE</p> <p>RENAULT R18 GASOLINA TT</p> <p>d27x51mm c43mm 1f-d14mm</p>		<p><b>S1085</b> NO. 7700514109 - 7700660462 - 7700683789 - 7701348040 - 7704001599 - 7704001600 - 7704001601</p> <p>SILENT-BLOC TRAPÉZIO INFERIOR</p> <p>RENAULT R18</p> <p>d32x46mm c38mm 1f-d14mm</p>
	<p><b>S1090</b> NO. 7704001281</p> <p>SILENT-BLOC DO BRAÇO INFERIOR DA SUSPENSÃO FRENTE</p> <p>RENAULT R18 DIESEL</p> <p>d36x53mm c38mm 1f-d14mm</p>		<p><b>S1116</b> NO. 7700612542</p> <p>SILENT-BLOC DO ALTERNADOR</p> <p>RENAULT R18</p> <p>d30x25mm d25mm 1f-d8mm</p>
	<p><b>UBV8010</b> NO. 068198821A</p> <p>BOMBA VACUO (KIT REPARAÇÃO)</p> <p>RENAULT 18 (DIESEL)</p> <p>d102x1mm 9f-d5mm</p>		<p><b>W5020</b> NO. 7700853470</p> <p>POLIE DA CAMBOTA (2 pistas)</p> <p>RENAULT R18 DIESEL</p> <p>d142mm d15mm</p>
	<p><b>W5061</b> NO. 7700853774</p> <p>POLIE DA CAMBOTA (2 PISTAS)</p> <p>RENAULT 18</p> <p>d117/133mm d15mm</p>		<p><b>Z80474</b> NO. 7703077068</p> <p>Mola de painel</p> <p>RENAULT 18</p> <p>d18.5x13.5mm 1p-d7-12mm</p>

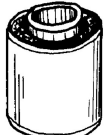
	<b>Z80500</b>	NO. 7703077066		
	Mola de painel RENAULT 18			
	d12.4x20mm	1p-d6.5-18mm		

## RENAULT 4

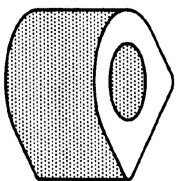
	<b>A0583</b>	NO. 0 - 0094535900 - 0854851400 - 7704002509 - 7700511170 - 7700558542 - 7701348802		<b>A0703</b>	NO. 8243734 - 8558634 - 7700500113 - 7702108305 - 0855863400
	SUPORTE DE ESCAPE RENAULT R4 - L - TL - GTL - FURGÃO (845 - 1108)			SUPORTE DO BRAÇO OSCILANTE RENAULT R4 - L - TL - GTL - FURGÃO (845 - 1108) - R6 TT	
	27x27x23mm	2p-d6-13mm		75x50x35mm	1f-d12mm
	<b>A0808-10</b>	NO. 7700523095 - 0855649200		<b>A0958</b>	NO. 7700546313 - 7702006764
	SUPORTE DE ESCAPE (PERNO 10mm) RENAULT R4 - L - TL - GTL - FURGÃO (845 - 1108) - R6 TT			SUPORTE TRÁS DA CAIXA DE VELOCIDADES RENAULT R4 - L - TL - GTL - FURGÃO (845 - 1108) - R6 TT	
	48x42x27mm	2p-d10-18mm		125x95x32mm	1p-d8-14mm
	<b>A0989-I</b>	NO. 7700527555 - 7700527557 - 7700527603		<b>A0990-I</b>	NO. 7700528173 - 7700556353 - 7700674446
	SUPORTE FRENTE DO MOTOR ESQUERDO RENAULT R4 GTL - R6 TL (1.1)			SUPORTE FRENTE DIREITO DO MOTOR RENAULT R4 GTL - R5 TT - R6 TL (1.1)	
	110x98x70mm	1p-d8-23mm 1f-d8mm		100x92x90mm	1p-d8-23mm
	<b>BB02</b>	NO. 608132700		<b>D0002</b>	NO. 7700509257 - 7701348067 - 7704001919 - 7700545821 - 06020035 - 06020037
	ABRAÇADEIRA DA BARRA ESTABILIZADORA RENAULT R4 - R6			JUNTA DE CARDAN DA DIRECÇÃO RENAULT R4 (L - TL - GTL)	
	80x28x25mm	NULL		51x32x32mm	2f-d8mm
	<b>D3604</b>	NO. 7700549015 - 7704002058 - 7700244291		<b>D3604-C</b>	NO. 7700549015 - 7704002058 - 7700244291
	JUNTA CARDAN DA DIRECÇÃO RENAULT R4 (L - TL - GTL)			JUNTA CARDAN DA DIRECÇÃO COM PORCAS E PARAFUSOS RENAULT R4 (L - TL - GTL)	
	d75x12mm	4f-d8mm		d75x12mm	4f-d8mm
	<b>F0089</b>	NO. 7701000986		<b>F0257-I</b>	NO. 7700509294 - 7700554294
	FOLE DA TRANSMISSÃO RENAULT R4L ANTIGA			FOLE DA CREMALHEIRA DA DIRECÇÃO ESQ. E DIR. RENAULT R4 TT (1962 A 1979) - R5 - L (845) - TL(956) - GTL(1108) - LS - TS(1289) (ATE 6-1979) - R6 TT -(APÓS 69 a 1979) - VAUS 4(APÓS 1971)	
	d105x122mm	2f-d55mm		d68x103mm	1f-d32mm 1f-d25mm

	<p><b>F0366-I</b> NO. 7701450617</p> <p>FOLE DO SEMI-EIXO JUNTO À CAIXA DE VELOCIDADES (diam. 79mm)</p> <p>RENAULT R4 - L - TL - GTL - FURGÃO (845 - 1108) + VAN (67)</p> <p>d98x96mm 1f-d79 1f-d18mm</p>		<p><b>F0367-I</b> NO. 7701457538</p> <p>FOLE DO SEMI-EIXO DO DIFERENCIAL JUNTO À RODA (DIAM. 76mm)</p> <p>RENAULT R4 - L - TL - GTL - FURGÃO (845 - 1108) + VAN (67)</p> <p>d81x95mm 1f-d76mm 1f-d18mm</p>
	<p><b>F0499-I</b> NO. 7700656569</p> <p>FOLE DA CREMALHEIRA DA DIREÇÃO ESQ. E DIR.</p> <p>RENAULT R4 - L - TL - GTL - FURGÃO (845 - 1108)(APÓS 7-79) - R5 - L-(845) - TL - (956) - GTL(1108) - LS - TS (1289)(APÓS 7-79) - R6(APÓS 7-79) - R14</p> <p>d71x160mm d59mm 1f-d36mm 1f-d11mm</p>		<p><b>F1008</b> NO. 7701457538</p> <p>FOLE DO SEMI-EIXO JUNTO À RODA (VER 367-I)</p> <p>RENAULT R4 TT -R4 VAN (1967)</p> <p>d81x95mm 1f-d76mm 1f-d18mm</p>
	<p><b>F1009</b> NO. 7701455702</p> <p>FOLE DO CARDAN JUNTO À CAIXA (DIAM. 62mm)</p> <p>RENAULT R4 - L - TL - GTL - FURGÃO (845 - 1108) - R6 TT</p> <p>d81x100mm 1f-d62mm 1f-d16mm</p>		<p><b>F1052</b> NO. 7700532414 - 7700623055</p> <p>FOLE DA ALAVANCA DE VELOCIDADES</p> <p>RENAULT R4 - L - TL - GTL - FURGÃO (845 - 1108)</p> <p>d42x17mm 1f-d16mm 1f-d15mm</p>
	<p><b>KB2057</b> NO.</p> <p>KIT DA BARRA ESTABILIZADORA (Diâmetro 10mm c/ tubo comprido)</p> <p>RENAULT R4 - R6 - F4 - F6</p> <p>NULL NULL</p>		<p><b>KB2070</b> NO.</p> <p>KIT DA BARRA ESTABILIZADORA (Diâmetro 10mm)</p> <p>RENAULT R4 - R6 - F4 - F6</p> <p>NULL NULL</p>
	<p><b>KF2500</b> NO. 7701457538</p> <p>FOLE DO LADO DA RODA</p> <p>RENAULT R4 - R5 - R6 - RODEO - R4 CARGO F4 - F6</p> <p>d82x100mm 1f-d17mm 1f-d68mm</p>		<p><b>L3002</b> NO. 855590000</p> <p>CASQUILHO SUPERIOR DA DIREÇÃO</p> <p>RENAULT R4 - R5 - R6 - R12</p> <p>d35x19mm 1f-d18mm</p>
	<p><b>R220305</b> NO. 7700628621</p> <p>TUBO DE ÁGUA PARA O AQUECIMENTO(APÓS 11/75)</p> <p>RENAULT R4 - L - TL</p> <p>B390-d16/19mm 55-85-210-85-45mm</p>		<p><b>R220312</b> NO. 8577289 - 7700550928 - 0857728900 - 3554542 - 5554542 - 7700509949 - 7700528616</p> <p>TUBO DE RADIADOR SUPERIOR</p> <p>RENAULT R4 - L - TL - R6</p> <p>B165-d42/30mm 95-110mm</p>
	<p><b>R220313</b> NO. 8577301 - 7700513446 - 0353860700 - 0857730100</p> <p>TUBO DE RADIADOR INFERIOR</p> <p>RENAULT R4 - L - TL - R6</p> <p>B170-d34/34mm 60-115-70mm</p>		<p><b>R220571</b> NO. 7700581084</p> <p>TUBO DE RADIADOR INFERIOR</p> <p>RENAULT R4 GTL</p> <p>B410-d32/32mm 210-200-80-90mm</p>
	<p><b>R220572</b> NO. 7700695524</p> <p>TUBO DO RADIADOR PERMUTADOR DE CALOR</p> <p>RENAULT 4 (112) 0.8 (1123) (07-1971 A 12-1988) 34CV 845CC - RENAULT 4 CAIXA (R21 R23) 0.8 (2106) (09-1966 A 12-1988) 34CV 845CC</p> <p>B500-16/18mm 100-140-380-90mm</p>		<p><b>R220573</b> NO. 7700695527</p> <p>TUBO DE ENVIO DE ÁGUA AO AQUECIMENTO</p> <p>RENAULT R4 GTL</p> <p>B570-d18/16mm 60-80-190-60-230mm</p>

	<p><b>R220581</b> NO. 7700580937 - 7700564985 - 7700619479</p> <p>TUBO DE RADIADOR SUPERIOR</p> <p>RENAULT R4 GTL - R5 TS</p>		<p><b>RT08096</b> NO. 7701000239 - 7701348799 - 7701349268 - 7701365330 - 7701454835 - 7701582523 - 84140390 - 8422177 - 8...</p> <p>TUBO DE TRAVÃO FRENTE LH-RH</p> <p>RENAULT 4 0.8 (839 706) 27CV (01-1981 A 09-1982) - 0.8 (1123) (800 - 800 705) 26CV (10-1962 A 09-1983) - 0.8 (1123) (800 01) 34CV (09-1971 A 12-1988) - 0.8 (1123) (800 705 - B1B 707) 29CV (10-1983 A 10-1988) - 1.1 (1128 - S 128) (688 712 - C1E 714 - C1E 719) 34CV</p>
	<p><b>RT08097</b> NO. 7700540425 - 7700554958 - 7700619240 - 7701348773 - 7701540425 - 7704001957 - 7704001958 - 84140180 ...</p> <p>TUBO DE TRAVÃO TRÁS LH-RH</p> <p>RENAULT 4 (112) 0.8 (839 706) 27CV (01-1981 A 09-1982) - 0.8 (1123) (800 - 800 705) 26CV (10-1962 A 09-1983) - 0.8 (1123) (800 01) 34CV (09-1971 A 12-1988) - 0.8 (1123) (800 705 - B1B 707) 29CV (10-1983 A 10-1988) - 1.0 (689 710) 42CV (12-1985 A 06-1993) - 1.</p>		<p><b>RT08309</b> NO. 7700545267 - 7700627933 - 7700641119 - 7701348800 - 7701454836 - 7704001925 - 8414040</p> <p>TUBO DE TRAVÃO FRENTE LH-RH</p> <p>RENAULT 4 0.8 (09-1971 A 12-1988) - 1.0 (12-1985 A 06-1993) - 1.1 (06-1978 A 06-1990) - FURGONATO 0.8 (09-1966 A 07-1989) - FURGONATO 1.0 (06-1987 A 12-1993) - FURGONATO 1.1 (10-1976 A 07-1989)</p>
	<p><b>S1021</b> NO. 8545885 - 8558426 - 7701348454</p> <p>SILENT-BLOC DO BRAÇO INFERIOR DA SUSPENSÃO FRENTE</p> <p>RENAULT R4 (L - GL - GTL)</p>		<p><b>S1035</b> NO. 8546375 - 7700509247 - 7702042315 - 0854637500 - 7700639572</p> <p>SILENT-BLOC DA EXTREMIDADE DA CREMALHEIRA DA DIRECÇÃO</p> <p>RENAULT R4 (L-TL-GTL)</p>
	<p><b>S1087</b> NO. 7700104152 - 7700518392 - 7700518856</p> <p>SILENT-BLOC DO BRAÇO SUPERIOR DA SUSPENSÃO FRENTE</p> <p>RENAULT R4 (L - TL - GTL) - R6 TT</p>		<p><b>S1137</b> NO. 854586400</p> <p>SILENT-BLOC DO BRAÇO DA SUSPENSÃO TRASEIRO</p> <p>RENAULT R4</p>
	<p><b>S1165</b> NO. 7700626057</p> <p>SILENT-BLOC DA SUSPENSÃO TRASEIRA</p> <p>RENAULT R4</p>		<p><b>S1166</b> NO. 854586300</p> <p>SILENT-BLOC INFERIOR DO BRAÇO DA SUSPENSÃO TRASEIRA</p> <p>RENAULT R4</p>
	<p><b>T0001</b> NO. 6082687 - 608268700 - 0608268700</p> <p>BATENTE DA BARRA ESTABILIZADORA</p> <p>RENAULT R4 - L - TL - GTL - FURGÃO (845 - 1108)</p>		<p><b>T1000</b> NO. 7700687374 - 7702003408 - 7702106143</p> <p>BATENTE DE BARRA ESTABILIZADORA FURO 12 mm</p> <p>RENAULT R4 - L - TL - GTL - FURGÃO (845 - 1108) - R5 TT - R6 TT</p>
	<p><b>T1004</b> NO. 7702106144</p> <p>BATENTE LATERAL DA BARRA ESTABILIZADORA DA SUSPENSÃO TRÁS (FURO 10mm)</p> <p>RENAULT R4 - L - TL - GTL - FURGÃO (845 - 1108)</p>		<p><b>T1149</b> NO. 7700687374 - 7702003408 - 7702107985</p> <p>BATENTE DA BARRA ESTABILIZADORA DA FRENTE</p> <p>RENAULT 4 (112_) 0.8 (1123) Local de montagem: Eixo traseiro (10.62 A 09.83) 26cv 845cc Combi - RENAULT 4 (112_) 0.8 (1123) Local de montagem: Eixo traseiro (10.83 A 10.88) 29cv 845cc Combi - RENAULT 4 (112_) 0.8 (1123) Local de montagem: Eixo traseiro (09.71 A 12.88) 34cv 845cc Combi - RENAULT 4 (112_) 1.0 (112C) Local de montagem: Eixo traseiro (06.87 A 06.93) 34cv 956cc Combi - RENAULT 4 (112_) 1.1 (1128 - S128) Local de montagem: Eixo tra...etc.</p>

	<p><b>C1005</b> NO. 0607121100 - 0607408300</p> <p>BOTÃO BATENTE DO CAPÔT</p> <p>RENAULT 4L</p> <p>22x20x19xx NULL</p>		<p><b>F1087-I</b> NO. 7701201128</p> <p>FOLE DA TRANSMISSÃO LADO DA CAIXA</p> <p>RENAULT 4L</p> <p>d82x116 1f-d64mm 1f-d18mm</p>
	<p><b>P0080</b> NO. 555501300 - 0555501300</p> <p>CAPA DE PEDAL TRAVÃO E EMBRAIAGEM</p> <p>RENAULT 4L ANTIGA</p> <p>55x44x11mm NULL</p>		<p><b>P0083</b> NO. 555501200 - 0555501200</p> <p>CAPA DE PEDAL ACELARADOR</p> <p>RENAULT 4L ANTIGA</p> <p>47x40x11mm NULL</p>
	<p><b>U7012</b> NO. 7701348489 - 7700562487 - 7701348490 - 0830059000</p> <p>ESCUDETES FRENTE E TRÁS</p> <p>RENAULT 4L</p> <p>145x64x49mm 1p-d8-25mm</p>		<p><b>U7013</b> NO.</p> <p>CANTOS MALA DIREITO E ESQUERDO (JOGO)</p> <p>RENAULT 4L</p> <p>130x55x28mm NULL</p>
	<p><b>U7015</b> NO. 0854733600 - 0870334000 - 7701004610</p> <p>VEDAÇÃO DOS FAROLINS DE TRÁS</p> <p>RENAULT 4L</p> <p>210x95x75x6mm NULL</p>		<p><b>Z80474</b> NO. 7703077068</p> <p>Mola de painel</p> <p>RENAULT 4L</p> <p>d18.5x13.5mm 1p-d7-12mm</p>









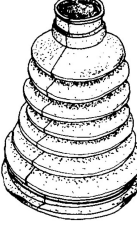
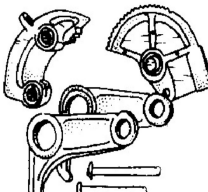

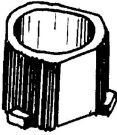
RENAULT 5-9-11-SUPER 5



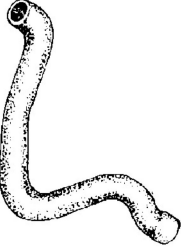

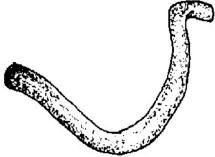
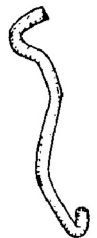
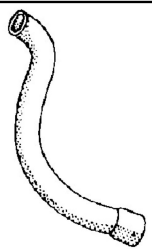
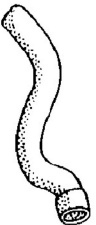

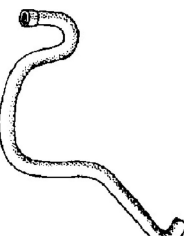

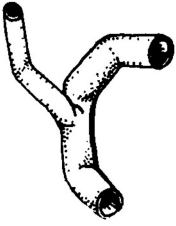
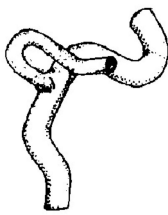
	<p><b>A0013</b> NO. 7700760488 - 7700760510 - 7700765935 - 7704001317</p> <p>SUPORTE TRÁS DO MOTOR</p> <p>RENAULT SUPER5 (GASOLINA) - R9 - R11TT</p> <p>145x100x64mm 1p-d10-30mm</p>		<p><b>A0291</b> NO. 7700770480</p> <p>SUPORTE FRENTE DIREITO DO MOTOR</p> <p>RENAULT SUPER5 DIESEL TT</p> <p>90x55x52mm NULL</p>
	<p><b>A0331</b> NO. 7700770307</p> <p>SUPORTE FRENTE ESQUERDO DO MOTOR</p> <p>RENAULT SUPER5 DIESEL TT</p> <p>60x53x40mm 2p-d8-22mm 1p-d10-70mm</p>		<p><b>A0985</b> NO. 7700762721 - 7700763206 - 7704001319</p> <p>SUPORTE FRENTE DIREITO DO MOTOR (LADO DA DISTRIBUIÇÃO)</p> <p>RENAULT R9 - R11 TT - SUPER5 (GASOLINA)</p> <p>126x63x58mm 1p-d10-28mm</p>
	<p><b>A0986</b> NO. 7700763207 - 7704001320</p> <p>SUPORTE FRENTE DO MOTOR ESQUERDO</p> <p>RENAULT R9 - R11 TT - SUPER5</p> <p>113x80x51mm 1p-d10-27mm</p>		<p><b>A1035</b> NO. 7700770479</p> <p>SUPORTE DE MOTOR FRENTE ESQUERDO</p> <p>RENAULT SUPER5 DIESEL TT</p> <p>118x135x60mm 1f-d12mm</p>

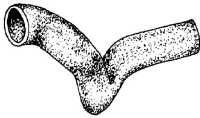

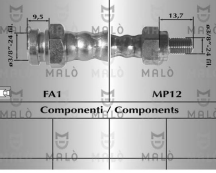
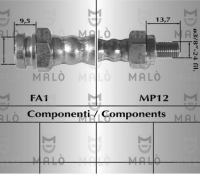
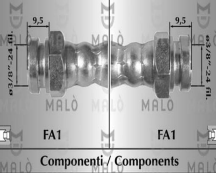
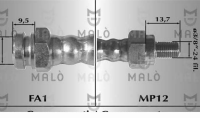
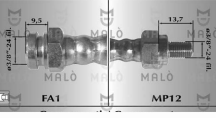
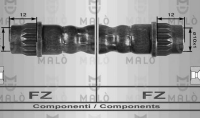
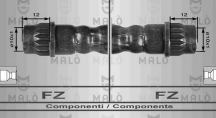
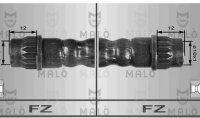

	<b>A1077</b> NO. 770075531 SUPORTE FRENTE ESQUERDO DO MOTOR RENAULT SUPER5 GASOLINA TT - R9 - R11 115x95x50mm 1p-d10-29mm		<b>A1262</b> NO. 7700560571 SUPORTE DO AMORTECEDOR DA FRENTE RENAULT 9 - 11 170x150x50mm 1f-d14mm 2r-d8mm
	<b>BB01</b> NO. 7700680098 ABRAÇADEIRA DA BARRA ESTABILIZADORA RENAULT R9 - R11 - R19 79x28x20mm NULL		<b>BB01</b> NO. 7700680098 ABRAÇADEIRA DA BARRA ESTABILIZADORA RENAULT SUPER5 79x28x20mm NULL
	<b>BB03</b> NO. 7700680097 ABRAÇADEIRA DA BARRA ESTABILIZADORA RENAULT R9 - R11 - R19 74x35x22mm NULL		<b>BB03</b> NO. 7700680097 ABRAÇADEIRA DA BARRA ESTABILIZADORA RENAULT SUPER5 74x35x22mm NULL
	<b>D0015</b> NO. 7700687433 - 7701349339 - 7700691031 - 7700705138 JUNTA DE CARDAN DA DIRECÇÃO RENAULT SUPER5 C - SC - TC - R9 - R11 43x32x32mm 2f-d8mm		<b>E0015</b> NO. 7700686449 - 7700795220 ESTICADOR DE ESCAPE RENAULT SUPER5 C - SC - TC 87x31x26.5mm NULL
	<b>E0025</b> NO. 71747801 SUPORTE DE ESCAPE RENAULT R9 (1981 A 1989) - R11 TT (1983 A 1989) 54x33x27mm NULL		<b>E0027</b> NO. 7700779356 ESTICADOR DE ESCAPE RENAULT SUPER5 - (APÓS 87) 51x27x27mm NULL
	<b>F0502-I</b> NO. 7700678649 FOLE DA CREMALHEIRA DA DIRECÇÃO ESQ. E DIR. RENAULT R9 - R11 (EXCP. GTE TURBO) d59x160mm 1f-d28mm 1f-d10mm		<b>F0823-I</b> NO. 7701463766 FOLE JUNTO À RODA RENAULT SUPER5 GT TURBO - R9 - R11 TURBO d100x130mm 1f-d80mm 1f-d28mm
	<b>F0827-1I</b> NO. FOLE DE TRANSMISSÃO DIREITO LADO DA CAIXA (PARA TRANSMISSÕES REPARADAS) RENAULT R9 - R9 TURBO - R11 - R18 - R20 - FUEGO - R21 - R25 d96x112mm 1f-d78mm 1f-d32mm		<b>F0827-1I</b> NO. FOLE DE TRANSMISSÃO DIREITO LADO DA CAIXA (PARA TRANSMISSÕES REPARADAS) RENAULT SUPER5 GT TURBO d96x112mm 1f-d78mm 1f-d32mm
	<b>F0899-I</b> NO. 7701462101 FOLE DO LADO DA CAIXA (SEMI-EIXO DIREITO d35mm) RENAULT SUPER5 d92x115mm 1f-d80mm 1f-d27mm		<b>F0901A1I</b> NO. 7701463955 - 7701464582 FOLE DO SEMI-EIXO LADO DA CAIXA C/ ROLAMENTO d22.8mm RENAULT SUPER5 GT TURBO d115x78mm 1f-d87mm 1f-d22.8mm

	<p><b>F1065</b> NO. 7701466120</p> <p>FOLE DO CARDAN JUNTO À RODA</p> <p>RENAULT R9 - R11 - R19</p> <p>d108x130mm 1f-d88mm 1f-d25mm</p>		<p><b>F1065</b> NO. 7701466120</p> <p>FOLE DO CARDAN JUNTO À RODA</p> <p>RENAULT SUPER5</p> <p>d108x130mm 1f-d88mm 1f-d25mm</p>
	<p><b>F1066</b> NO. 7701466120</p> <p>FOLE DA TRANSMISSÃO JUNTO À RODA</p> <p>RENAULT SUPER5</p> <p>d91x122mm 1f-d83mm 1f-d34mm</p>		<p><b>F1071</b> NO. 7701465489 - 7701466122 - 7701034800 - 7701467125</p> <p>FOLE DO SEMI-EIXO DO DIFERENCIAL LADO DA RODA</p> <p>RENAULT SUPER5 GT TURBO</p> <p>d92x135mm 1f-d86mm 1f-d26mm</p>
	<p><b>F1089-I</b> NO.</p> <p>FOLE DA TRANSMISSÃO LADO DA RODA</p> <p>RENAULT SUPER5</p> <p>d93x110mm 1f-d80mm 1f-d22mm</p>		<p><b>F1325-I</b> NO. 7701201233 - 7701202350</p> <p>FOLE DA TRANSMISSÃO JUNTO À CAIXA</p> <p>RENAULT R11 1.1 - 1.4 - 1.4i T TURBO - 1.6 D - 1.7 (1983 A 1988)</p> <p>d81x113mm 1f-d63mm 1f-d27mm</p>
	<p><b>F1325-I</b> NO. 7701201233 - 7701202350</p> <p>FOLE DA TRANSMISSÃO JUNTO À CAIXA</p> <p>RENAULT R9 1.1 - 1.2 - 1.4 - 1.4 AUTOM. - 1.4i T TURBO - 1.6 D - 1.7 (1981 A 1989)</p> <p>d81x113mm 1f-d63mm 1f-d27mm</p>		<p><b>F1325-I</b> NO. 7701201233 - 7701202350</p> <p>FOLE DA TRANSMISSÃO JUNTO À CAIXA</p> <p>RENAULT SUPER 5 1.2 - 1.4 - 1.6 D - 1.7 (1985 A 1996)</p> <p>d81x113mm 1f-d63mm 1f-d27mm</p>
	<p><b>H536</b> NO.</p> <p>PALA ORIGINAL</p> <p>RENAULT SUPER5</p> <p>340x210mm NULL</p>		<p><b>KB2063</b> NO.</p> <p>KIT DA BARRA ESTABILIZADORA (DIÂMETRO 21)</p> <p>RENAULT R9 - R11 - SUPER5</p> <p>NULL NULL</p>
	<p><b>KF2540</b> NO. 7701348568 - 7701348694</p> <p>FOLE DO LADO DA RODA</p> <p>RENAULT R11 - R25 - R16 shaft 35 mm - R18 - FUEGO</p> <p>d94x115mm 1f-d28mm 1f-d74mm</p>		<p><b>KF2560</b> NO. 7701463643</p> <p>FOLE DO LADO DA RODA</p> <p>RENAULT R9 - R11</p> <p>d87x83mm 1f-d20mm 1f-d75mm</p>
	<p><b>KF2599-T</b> NO. 7701465489 - 7701466122</p> <p>FOLE DO LADO DA RODA</p> <p>RENAULT SUPER5 GE86 - R9 - R11 - R5 - SUPER5 GT TURBO - R9 - R11 - R19 - R21 - R25</p> <p>d97x143mm 1f-d33mm 1f-d82mm</p>		<p><b>KL0769A-I</b> NO. 7700649299</p> <p>KIT DE CASQUILHOS DA ALAVANCA DE VELOCIDADES</p> <p>RENAULT SUPER5</p> <p>NULL NULL</p>
	<p><b>KL1072-I</b> NO.</p> <p>KIT DE REPARAÇÃO DA CREMALHEIRA DA EMBRAIAGEM</p> <p>RENAULT SUPER5 - R9 - R11</p> <p>NULL NULL</p>		<p><b>KL1101-I</b> NO. 7700679621</p> <p>KIT DA CREMALHEIRA DA EMBRAIAGEM</p> <p>RENAULT SUPER5</p> <p>NULL NULL</p>

	<p><b>L0919-I</b> NO.</p> <p>CASQUILHO DE NYLON DA CREMALHEIRA DA DIRECÇÃO RENAULT R9 - 11</p> <p>33x33x18mm 1f-d20mm</p>		<p><b>P1015</b> NO. 7700680836</p> <p>CAPA DE PEDAL DO TRAVÃO E EMBRAIAGEM RENAULT SUPER5 TT - R9 - R11 - R19 TT</p> <p>60x50x12mm NULL</p>
	<p><b>R220590</b> NO. 7700760872 - 7704001275</p> <p>TUBO DE RADIADOR SUPERIOR C/ RESPIRO RENAULT R9 - R11 GASOLINA (1.1 - 1.4)</p> <p>B380-d38/30mm 80-155-135-85mm</p>		<p><b>R220591</b> NO. 7704001277 - 7700773175 - 7704001279</p> <p>TUBO DE RADIADOR INFERIOR RENAULT R9 - R11 GASOLINA (1.1 - 1.4)</p> <p>B405-d38/38mm 75-35-100-145-140mm</p>
	<p><b>R220592</b> NO. 7704002500</p> <p>TUBO DE RADIADOR SUPERIOR RENAULT R9 DIESEL TT</p> <p>B490-d32/32mm 75-120-100-50-120-60-70mm</p>		<p><b>R220594</b> NO. 7704001326</p> <p>TUBO DE RETORNO DA ÁGUA DO AQUECIMENTO RENAULT R9 - R11 (1.1 - 1.4)</p> <p>B310-d16/18mm 45-55-220-280-330-65mm</p>
	<p><b>R220596</b> NO. 7700773178 - 7704002497</p> <p>TUBO DE AQUECIMENTO RENAULT SUPER5 - R9</p> <p>B275-d19/17mm 40-85-65-80-45mm</p>		<p><b>R220598</b> NO. 7700757553</p> <p>TUBO DE RADIADOR SUPERIOR RENAULT R9 DIESEL - R11 DIESEL</p> <p>B400-d30/30mm 70-175-135-85-120-85mm</p>
	<p><b>R220659</b> NO. 7700726562</p> <p>TUBO DE LIGAÇÃO DO CARBURADOR DE CORPO DUPLO À BOMBA RENAULT SUPER5 - R9 - R11</p> <p>B340-d12/12mm 65-60-65-150-90-40mm</p>		<p><b>R220660</b> NO. 7700751785</p> <p>TUBO DE RADIADOR SUPERIOR RENAULT SUPER5 DIESEL - TD - GTD</p> <p>B315-d32/32mm 55-170-145mm</p>
	<p><b>R220663</b> NO. 7700752184 - 7700781076</p> <p>TUBO DE RADIADOR INFERIOR RENAULT SUPER5 TL - GTL - GTS - SL - TC</p> <p>B360-d29/29mm 65-80-95-65-80-55mm</p>		<p><b>R220668</b> NO. 7700762034</p> <p>TUBO DE LIGAÇÃO DO AQUECIMENTO À BOMBA DE ÁGUA RENAULT SUPER5 TL - GTL - GTS - SL - TC</p> <p>B620-d17/17mm 55-80-215-180-190-155-55-40mm</p>
	<p><b>R220669</b> NO. 7700707107</p> <p>TUBO DE ÁGUA DA BOMBA AO CARBURADOR RENAULT SUPER5 TS - GTS - TSE - R9 - R11 TSE</p> <p>B390-d11/11mm 65-55-45-80-50-70-50-.95-40mm</p>		<p><b>R220670</b> NO. 7700779910</p> <p>TUBO DE LIGAÇÃO DA BOMBA DE ÁGUA AO AQUECIMENTO RENAULT SUPER5 DIESEL TD</p> <p>B225-d19/20mm 50-100-60-55mm</p>
	<p><b>R221640</b> NO. 7700759170</p> <p>TUBO DE RADIADOR INFERIOR 3 VIAS S/ AR COND. RENAULT R11 DIESEL - R9</p> <p>B255-d32/32mm 65-155-65mm + ch d18mm 90-90mm</p>		<p><b>R221643</b> NO. 7700760869 - 7700758465</p> <p>TUBO DE RADIADOR INFERIOR 3 VIAS RENAULT R11 TXE</p> <p>B275-d32/32mm 90-105-115-55-70mm + ch d17mm 85-65-130-110mm</p>

	<p><b>R2421</b> NO.</p> <p>TUBO INFERIOR DO RADIADOR</p> <p>RENAULT SUPER5</p> <p>B375-d38/32mm 50-90-70-110-120mm</p>		<p><b>R8062</b> NO. 7700808729</p> <p>TUBO DO ARREFECIMENTO</p> <p>RENAULT 9</p> <p>B545-d19/16mm d10mm 125-170-150-90-55-80mm 65-175-110-60mm</p>
	<p><b>RF5008</b> NO. 7700856932 - 7700866559</p> <p>TUBO DE FERRO RADIADOR</p> <p>RENAULT R9</p> <p>B260-d18/18mm 90-70-170mm+B265-d14/14mm-55-105-1</p>		<p><b>RT08096</b> NO. 7701000239 - 7701348799 - 7701349268 - 7701365330 - 7701454835 - 7701582523 - 84140390 - 8422177 - 8...</p> <p>TUBO DE TRAVÃO FRENTE LH-RH</p> <p>RENAULT 5 0.8 (1221 - 1391) (800 710) 37CV (01-1982 A 12-1984) - 0.8 (1221 - 1391 - 1220) (800 710) 35CV (10-1972 A 08-1984) - 1.0 (1222 - 1392) (689 710) 44CV (01-1972 A 12-1985) - 1.1 (1227 - 1397) (688 713 - C1E 726) 45CV (09-1980 A 12-1985) - 1.3 (1224 - 139</p> <p>500mm FA1 - MP12</p>
	<p><b>RT08096</b> NO. 7701000239 - 7701348799 - 7701349268 - 7701365330 - 7701454835 - 7701582523 - 84140390 - 8422177 - 8...</p> <p>TUBO DE TRAVÃO FRENTE LH-RH</p> <p>RENAULT 5 Furgonato 0.8 (2381) (800710) 35CV (10-1972 A 08-1984) - 1.0 (2382) (689 710) 44CV (01-1972 A 12-1985) - 1.1 (688 713 - C1E 726) 45CV (09-1980 A 12-1985)</p> <p>500mm FA1 - MP12</p>		<p><b>RT08097</b> NO. 7700540425 - 7700554958 - 7700619240 - 7701348773 - 7701540425 - 7704001957 - 7704001958 - 84140180 ...</p> <p>TUBO DE TRAVÃO TRÁS LH-RH</p> <p>RENAULT 5 (122_) 0.8 (1221 - 1391) (800 710) 37CV (01-1982 A 12-1984) - 0.8 (1221 - 1391 - 1220)(800 710) 35CV (10-1972 A 08-1984) - 1.0 (1222 - 1392) (689 710) 44CV (01-1972 A 12-1985) - 1.1 (1227 - 1397) (688 712 - C1E 726) 45CV (09-1980 A 12-1985) - 1.3 (122</p> <p>270mm FA1 - FA1</p>
	<p><b>RT08309</b> NO. 7700545267 - 7700627933 - 7700641119 - 7701348800 - 7701454836 - 7704001925 - 8414040</p> <p>TUBO DE TRAVÃO FRENTE LH-RH</p> <p>RENAULT 5 0.8 (10-1972 A 12-1984) - 1.0 (01-1972 A 12-1985) - 1.1 (09-1980 A 12-1985) - 1.3 (09-1975 A 09-1984) - 1.3 AUTOMATIK (06-1979 A 09-1984) - 1.4 (01-1982 A 12-1985) - 1.4 ALPINE A5 (09-1977 A 09-1981) - 1.4 ALPINE TURBO (10-1981 A 01-1985) - 1.4</p> <p>460mm FB9 - MP12</p>		<p><b>RT08309</b> NO. 7700545267 - 7700627933 - 7700641119 - 7701348800 - 7701454836 - 7704001925 - 8414040</p> <p>TUBO DE TRAVÃO FRENTE LH-RH</p> <p>RENAULT 5 FURGONATO 0.8 (10-1972 A 08-1984) - FURGONATO 1.0 (01-1972 A 12-1985) - FURGONATO 1.1 (09-1980 A 12-1985)</p> <p>460mm FB9 - MP12</p>
	<p><b>RT08446</b> NO. 7700804814 - 7704003922</p> <p>TUBO DE TRAVÃO TRÁS LH-RH</p> <p>RENAULT R11 1.1 - 1.2 - 1.4 - 1.4 TURBO - 1.6D - 1.7 (1983 A 1988)</p> <p>285mm FZ - FZ</p>		<p><b>RT08446</b> NO. 7700804814 - 7704003922</p> <p>TUBO DE TRAVÃO TRÁS LH-RH</p> <p>RENAULT R9 1.1 (1981 A 1987)</p> <p>285mm FZ - FZ</p>
	<p><b>RT08501</b> NO. 7701349305 - 7704001950 - 7704003549 - 7700541132 - 7704003931</p> <p>TUBO DE TRAVÃO TRÁS LH-RH</p> <p>RENAULT R9 1.1 - 1.2 - 1.4 (LC422) - L42C) - R11 (B-C-S372 - B-C 37C) - 1.6D (1981 A 1988) - 1.7 (R11 B-C 37F-D-N) (APOS 12-1987)</p> <p>270mm FZ - FZ</p>		<p><b>S1060</b> NO. 7700762574 - 7704000681</p> <p>SILENT-BLOC DO BRAÇO INFERIOR DA SUSPENSÃO FRENTE</p> <p>RENAULT SUPER5 - R9 - R11</p> <p>d32x46mm c36mm 1f-d12mm</p>
	<p><b>S1060-A</b> NO. 7700762574 - 7704000681</p> <p>SILENT-BLOC DO BRAÇO INFERIOR DA SUSPENSÃO FRENTE</p> <p>RENAULT SUPER5 - R9 - R11</p> <p>d32x46mm c36mm 1f-d12mm</p>		<p><b>S1105</b> NO. 7704003844</p> <p>SILENT-BLOC FRENTE DO BRAÇO DA SUSPENSÃO TRÁS</p> <p>RENAULT SUPER5 - CLIO</p> <p>d72x28mm c28mm 1f-d43mm</p>
	<p><b>S1120</b> NO.</p> <p>SILENT-BLOC DA SUSPENSÃO TRASEIRA</p> <p>RENAULT R9 - R11</p> <p>d72x36mm c36mm 1f-d43mm</p>		<p><b>S1531</b> NO. 7700531821 - 7700586284</p> <p>SILENT BLOC DO BRAÇO DA SUSPENSÃO DE TRÁS PARTE INFERIOR</p> <p>RENAULT - 5 (122) - 0.8 (1221 - 1391) (01.82 - 12.84) 37cv 845cc - RENAULT - 5 (122) - 1.0 (1222 - 1392) (01.72 - 12.85) 44cv 956cc - RENAULT - 5 (122) - 1.1 (1227 - 1397) (09.80 - 12.85) 45cv 1108cc - RENAULT - 5 (122) - 1.3 (1225) (09.76 - 09.79) 42cv 1289</p> <p>d55x33mm c27,5mm 1f-d37mm</p>



	<b>T0020-A</b> NO. 7700798053 BATENTE DA BARRA ESTABILIZADORA (FURO 20mm) RENAULT R11 - R19 40x40x33mm 1f-d20mm		<b>T1006F23</b> NO. 7700760264 BATENTE DAS PONTAS DA BARRA ESTABILIZADORA (FURO 23 mm) RENAULT SUPER5 57x46x42mm 1f-d23mm
	<b>T1099-I</b> NO. 7700693154 BATENTE DE ESTABILIZADOR RENAULT SUPER5 - R9 - 11 45x39x32mm 1f-d21mm		<b>T1149</b> NO. 7700687374 - 7702003408 - 7702107985 BATENTE DA BARRA ESTABILIZADORA DA FRENTE RENAULT 5 (122_) 0.8 (1221 - 1391) Local de montagem: Eixo traseiro (01.82 A 12.84) 37cv 845cc Hatchback - RENAULT 5 (122_) 1.0 (1222 - 1392) Local de montagem: Eixo traseiro (01.72 A 12.85) 44cv 956cc Hatchback - RENAULT 5 (122_) 1.1 (1227 - 1397) Local de montagem: Eixo traseiro (09.80 A 12.85) 45cv 1108cc Hatchback - RENAULT 5 (122_) 1.3 (1225) Local de montagem: Eixo traseiro (09.76 A 09.79) 42cv 1289cc Hatchback - RENAULT 5 (122_) 1.3 (1...etc. 73x38x51mm 2f-d12mm
	<b>T1149</b> NO. 7700687374 - 7702003408 - 7702107985 BATENTE DA BARRA ESTABILIZADORA DA FRENTE RENAULT SUPER 5 (B/C40_) 1.0 (B/C/400) Local de montagem: Eixo traseiro (10.84 A 10.88) 41 956 Hatchback RENAULT SUPER 5 (B/C40_) 1.1 (B/C/401 - B/C40H) Local de montagem: Eixo traseiro 01.86 - 03.95 33 45 1108 Hatchback RENAULT SUPER 5 (B/C40_) 1.1 (B/C/401) Local de montagem: Eixo traseiro 10.84 - 10.88 34 46 1108 Hatchback RENAULT SUPER 5 (B/C40_) 1.2 (B/C40F) 01.87 - 08.90 40 55 1237 Hatchback 2 / 2 RENAULT SUPER 5 (B/C40_) 1.2 (B/C40F) Loca...etc. 73x38x51mm 2f-d12mm		<b>U0303</b> NO. 6001009755 - 7700757324 ANILHA DA SUSPENSÃO RENAULT SUPER5 d97x35mm 1f-d53mm
	<b>W5000</b> NO. 8200386445 - 7700112999 - 7700724249 - 7700107145 - 7700864763 - 8200545437 - 8200689705 - 770073990... POLIE DA CAMBOTA (6 pistas) RENAULT R9 - R11 (1.6-mot.F8Q) d132mm d12.6mm		<b>W5071</b> NO. 7700856673 POLIE DA CAMBOTA (6 PISTAS) RENAULT 9 - RENAULT 11 d132mm d12.6mm
	<b>Z10508</b> NO. 7701397195 Mola de fixação RENAULT SUPER5 d16.5x16.7mm 1p-d8-18.8mm 1f-d7.5mm		<b>Z80444</b> NO. 60593404 Mola de friso RENAULT SUPER5 NULL NULL
	<b>Z80444</b> NO. 60593404 Mola de friso RENAULT 11 NULL NULL		<b>Z80473</b> NO. 7703077193 Mola de painel RENAULT SUPER5 d21x24mm 1p-d7-14mm
	<b>Z80474</b> NO. 7703077068 Mola de painel RENAULT 11 d18.5x13.5mm 1p-d7-12mm		<b>Z80475</b> NO. 7703077109 Mola de painel RENAULT SUPER5 d12.5x19mm 1p-7x7-17mm
	<b>Z80475</b> NO. 7703077109 Mola de painel RENAULT 9 d12.5x19mm 1p-7x7-17mm		<b>Z80576</b> NO. Mola de friso Renault R5 38x22x6.6mm NULL

	<b>Z80583</b> NO. 7703077117		<b>Z80608</b> NO. 7703077225 - 7518N8
	Mola de painel RENAULT SUPER5 d20x15.5mm 1p-d7.5-13.5mm		Mola de painel RENAULT SUPER5 d35x25mm 1p-d10.7-22.5mm
	<b>Z80633</b> NO. 7703081054		
	Mola de painel RENAULT SUPER5 d30x17mm 1p-d9.7-15mm		

RENAULT AVANTIME

	<b>E0238-M</b> NO. 6025403418		<b>F1701K3I</b> NO. 7701470910
	ESTICADOR DO MOTOR PARTE DE TRÁS RENAULT AVANTIME 2.2 Dci (05-2002 A 05-2003) 170x61x52mm 2f-d14mm		FOLE DA TRANSMISSÃO JUNTO À CAIXA RENAULT AVANTIME 2.0i T - 2.2 DCi - 3.0i (1991 A 2003) d85x200mm 1f-d75mm 1f-d25mm
	<b>F1827-I</b> NO. 7701207566		<b>KF2539-T</b> NO. 7701470155
	FOLE DA TRANSMISSÃO JUNTO À CAIXA RENAULT AVANTIME 2.0i T 16V - 2.2 DCi - 3.0i V6 (2001 A 2003) d115x85mm 1f-d73mm 1f-d42mm		KIT DE FOLE DO CARDAN JUNTO À RODA RENAULT AVANTIME 2.0i T 16V - 2.2 DCi - 3.0i V6 (2001 A 2003) d110x150mm 1f-d98mm 1f-d30mm
	<b>U7010</b> NO. 8200059541		<b>W5083</b> NO. 8200207435 - 8200162582 - 8200664350 - 8200555549 - 8200802666 - 8200458171 - 8200097903
	TENSORES CORREIA ALTERNADOR RENAULT AVANTIME 1.9 DTi (F9Q) d34x130mm 2f-d8mm		POLIE DA CAMBOTA (7 PISTAS) RENAULT - AVANTIME (DE0_) - 2.2 dCi (DE01) Veiculo multiuso 150CV 2188cc (05-2002 A 05-2003) d152/162mm d30/58mm

RENAULT CLIO (1)

	<b>E0223-M</b> NO. 7700432026 - 8200399539 - 8200432026		<b>E0226-M</b> NO. 7700414827 - 7700840288
	ESTICADOR DO MOTOR RENAULT CLIO I 1.4 (CAIXA AUTOMÁTICA)(01-1991 A 09-1998) - 1.8 (08-1994 A 09-1998) 165x64x46mm 1f-d12mm 1f-d10mm		ESTICADOR DO MOTOR PARTE DE TRÁS RENAULT CLIO I 1.4 (01-1991 A 09-1998) - 1.8 (01-1991 A 09-1998) 170x82x45mm 2f-d10mm

## RENAULT CLIO (1)

	<b>F1329-I</b> NO. 7701472212 - 7701466349 - 7701470299 <i>FOLE DA TRANSMISSÃO JUNTO À CAIXA</i> RENAULT CLIO I 1.1i - 1.2 - 1.2i - 1.4i - 1.6i - 1.8i - 1.8i RSi - 1.9D - 2.0i SPORT 16V (1990-1998)		<b>KF2527-T</b> NO. 7701036821 <i>KIT DE FOLE DO CARDAN JUNTO À RODA</i> RENAULT CLIO I 1.4i - 1.7 - 1.8i RSi (1990 A 1998)
	d86x102mm 1f-d73mm 1f-d26mm		d95x130mm 1f-d78mm 1f-d23mm
	<b>KF2528-T</b> NO. 7701469411 - 7701469021 <i>KIT DE FOLE DO CARDAN JUNTO À RODA</i> RENAULT CLIO I 1.9D - 2.0i WILLIAMS (1990 A 1998)		<b>R220577</b> NO. 7700857014 <i>TUBO DE LIGAÇÃO DO AR DE SOBREALIMENTAÇÃO</i> RENAULT CLIO I (B/C57_ - 5/357_) 1.9 D (01.97 a 09.98) 54cv 1870cc Hatchback - RENAULT CLIO I (B/C57_ - 5/357_) 1.9 D (B/C/S576 - B/C/S57L) (01.91 A 09.98) 64cv 1870cc Hatchback
	d90x140mm 1f-d80mm 1f-d25mm		B340-d65/70mm 200-190-120mm
	<b>R223163</b> NO. 7700412082 <i>TUBO DO PERMUTADOR DE CALOR DO AQUECIMENTO</i> RENAULT CLIO I 1.9 D HATCHBACK 54CV (01-1997 A 09-1998) - 1.9 D HATCHBACK 64CV (01-1991 A 09-1998)		<b>RT08446</b> NO. 7700804814 - 7704003922 <i>TUBO DE TRAVÃO TRÁS LH-RH</i> RENAULT CLIO (1) 1.1 - 1.2 - 1.4 - 1.8 - 1.8RSi - 1.9D (1990 A 1998)
	B110-d18/15mm B340-18/15mm 160-230-140-60-40-50mm 110-120-1		285mm FZ - FZ
	<b>RT08496</b> NO. 7704003887 - 7704003949 <i>TUBO DE TRAVÃO FRENTE LH-RH</i> RENAULT CLIO I 1.1 (01-1991 A 09-1998) - 1.2 (-----) - 1.4 (01-1991 A 09-1998) - 1.7 (01-1991 A 12-1993) - 1.8 (01-1991 A 09-1998) - 1.8 16V (01-1991 A 03-1996) - 1.8 RSi (01-1993 A 09-1998) - 1.9 D (01-1991 A 09-1998) - FURGONATO 1.1 (01-1991 A 09-1998)		<b>RT08637</b> NO. 7700416273 <i>TUBO DE TRAVÃO TRÁS LH-RH</i> RENAULT CLIO I TT (01-1991 A 09-1998)
	270mm FZ - MC11		190mm FZ2 - FZ2
	<b>W5000</b> NO. 8200386445 - 7700112999 - 7700724249 - 7700107145 - 7700864763 - 8200545437 - 8200689705 - 770073990... <i>POLIE DA CAMBOTA (6 pistas)</i> RENAULT CLIO I		<b>Z80533</b> NO. 7543023 - 7703081019 - 9759904480 <i>Mola de retenção</i> RENAULT CLIO (1) (Após 1990)
	d132mm d12.6mm		10x17x10mm 1p-7.2x14-9mm 1f-d4.2mm
	<b>Z80600</b> NO. 7701408846 <i>Mola de friso</i> RENAULT CLIO (1)		<b>Z80657</b> NO. 7703077300 <i>Mola de friso</i> RENAULT CLIO (1)
	34x30x10mm NULL		34.5x16.8x6.8mm NULL

## RENAULT CLIO (2)-THALIA

	<b>A1471</b> NO. 7700434370 <i>SUPOORTE MOTOR DIREITO</i> RENAULT CLIO II 98 - 1.4 - 1.6 - 1.9		<b>A1523</b> NO. 7700424342 <i>APOIO DO ESCAPE PARTE DO MEIO</i> RENAULT CLIO II 1.4 16V - 1.6 16V - 1.9D - DTI
	170x110x110mm 1p-d10-30mm		160x100x61mm NULL













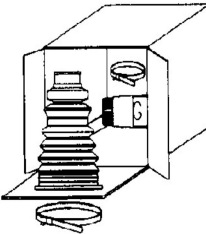
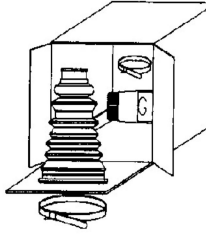



	<p><b>E0219-M</b> NO. 8200151995</p> <p>ESTICADOR DO MOTOR PARTE DE TRÁS</p> <p>RENAULT CLIO II 1.4 16V - 1.5 DCi - 1.6 16V</p> <p>250x80x50mm 1f-d14mm 1f-d12mm</p>		<p><b>E0225-M</b> NO. 7700415095</p> <p>ESTICADOR DO MOTOR PARTE DE TRÁS</p> <p>RENAULT CLIO II 1.4 (09-1998 A 05-2005) - 1.6 (09-1998 A 05-2005)</p> <p>158x60x46mm 2f-d10mm</p>
	<p><b>E0250-M</b> NO. 8200155207 - 8200175102</p> <p>ESTICADOR DO MOTOR PARTE DE TRÁS</p> <p>RENAULT CLIO II 1.2 (BB0A - BB0F - BB10 - BB1K - BB28 - BB2D - BB2H - CB0A..) (D7F 720 - D7F 726 - D7F 746) 58CV (APÓS 09-1998) - 1.2 16V (BB05 - BB0W - BB11 - BB27 - BB2T - BB2U - BB2V - CB05..) (D4F 706 - D4F 712) 75CV (APÓS 06-2001) - 1.4 (B/CB0C) (K7J 710) 75CV (APÓS</p> <p>240x80x46mm 1f-d12mm 1f-d14mm</p>		<p><b>E1083</b> NO. 7700424341 - 7700424340</p> <p>ESTICADOR DE ESCAPE (PARTE DE TRÁS)</p> <p>RENAULT CLIO II 1.2 - 1.4 - 1.6 16V - 1.9D (APÓS 1998)</p> <p>74x52x45mm NULL</p>
	<p><b>F1329-I</b> NO. 7701472212 - 7701466349 - 7701470299</p> <p>FOLE DA TRANSMISSÃO JUNTO À CAIXA</p> <p>RENAULT CLIO II 1.2i - 1.4i - 1.6i - 2.0i (APÓS 1998)</p> <p>d86x102mm 1f-d73mm 1f-d26mm</p>		<p><b>F1687-I</b> NO. 7701469486 - 7701469487</p> <p>FOLE DA DIRECÇÃO ASSISTIDA DIREITO E ESQUERDO</p> <p>RENAULT CLIO II (APÓS 1998)</p> <p>d75x175mm d57mm 1f-d41mm 1f-d11mm</p>
	<p><b>KF9015</b> NO. 6001548164 - 7701209255</p> <p>KIT DE FOLE DO CARDAN JUNTO À CAIXA</p> <p>RENAULT - CLIO II (BB0/1/2_ - CB0/1/2_) - 1.5 dCi (B/CB3M) (APÓS 06.05) 64cv 1461cc - RENAULT - CLIO II (BB0/1/2_ - CB0/1/2_) - 1.5 dCi (B/C2J) (APÓS 08.04) 68cv 1461cc - RENAULT - CLIO II (BB0/1/2_ - CB0/1/2_) - 1.5 dCi (B/CB3N) (APÓS 02.07) 84cv 1461cc - R</p> <p>d86x104mm 1f-d76mm 1f-d25mm</p>		<p><b>P1050</b> NO. 7700416724</p> <p>CAPA DE PEDAL DO TRAVÃO E EMBRAIAGEM</p> <p>RENAULT CLIO II APÓS 98 1.2 - 1.4 - 1.6 - 1.6 16V - 1.9D</p> <p>75x48x10mm NULL</p>
	<p><b>P1069</b> NO. 7700416723</p> <p>CAPA DE PEDAL DO TRAVÃO</p> <p>RENAULT CLIO II (BB0-1-2 CB0-1-2) 1.9 D (B-CB0E) (09-1998 A 05-2005) 64CV 1870CC - RENAULT CLIO II (BB0-1-2 CB0-1-2) 1.9 DTI (B-CB0U) (12-1999 A 05-2005) 80CV 1870CC - RENAULT CLIO II CAIXA (SB0-1-2) 1.9 D (SB0E) (APÓS 09-1998) 64CV 1870CC</p> <p>75x73x10mm NULL</p>		<p><b>Q2009</b> NO.</p> <p>UNIÃO DE ESCAPE 48/45x80mm</p> <p>RENAULT - CLIO II (BB0/1/2_ - CB0/1/2_) - 1.4 16V (B/CB0L) (10.99 - 09.04) 95cv 1390cc Hatchback - RENAULT - CLIO II (BB0/1/2_ - CB0/1/2_) - 1.4 16V (B/CB0P) (APÓS 08.00) 98cv 1390cc Hatchback - RENAULT - CLIO II (BB0/1/2_ - CB0/1/2_) - 1.6 (B/CB0D) (09.98)</p> <p>80x77x55mm 1f-d45/48mm</p>
	<p><b>RT08636</b> NO. 7700423975</p> <p>TUBO DE TRAVÃO FRENTE LH-RH</p> <p>RENAULT CLIO II (APÓS 09-1998)</p> <p>345mm FZ - MC11</p>		<p><b>RT08637</b> NO. 7700416273</p> <p>TUBO DE TRAVÃO TRÁS LH-RH</p> <p>RENAULT CLIO II TT (APÓS 09-1998)</p> <p>190mm FZ2 - FZ2</p>
	<p><b>S1300</b> NO. 7700424399</p> <p>SILENT-BLOC DO BRAÇO SUSPENSÃO DA FRENTE</p> <p>RENAULT CLIO II (APÓS 1998)</p> <p>d59x46mm d45mm 1f-14x15mm</p>		<p><b>S1450</b> NO. 7700429441 - 7700839316 - 8200042594</p> <p>SILENT- BLOC DA SUSPENSÃO DE TRÁS</p> <p>RENAULT CLIO II 1.1(APÓS 09-1998) - 1.2(APÓS 09-1998) - 1.2 16V (APÓS 06-2001) - 1.4(09-1998 A 05-2005) - 1.4 16V(APÓS 10-1999) - 1.5 DCi(APÓS 06-2001) - 1.6(09-1998 A 05-2005) - 1.6 16V(APÓS 09-1998) - 1.9D(09-1998 A 05-2005) - 1.9 DTi(02-2000 A 05-2005)</p> <p>d65x73mm d45mm 1f-d10mm</p>
	<p><b>W5017</b> NO. 7700115309 - 7700110329 - 7700113018 - 8200689702 - 4418147 - 93192606 - 4402569 - 9110569</p> <p>POLIE DA CABBOTA (6 pistas)</p> <p>RENAULT CLIO II</p> <p>d132mm d12.6mm</p>		<p><b>W5019</b> NO. 12303-00Q0J - 12303-00QAU - 12303-00QBA - 12303AY600 - 12303-BN700 - 8200392697</p> <p>POLIE DA CABBOTA (5 pistas)</p> <p>RENAULT CLIO II 1.4 - 1.6 (APÓS 09-1998) - 2.0 16V (APÓS 02-2000) - 1.5 DCI (APÓS 16-2001)</p> <p>d152.3mm d26mm</p>







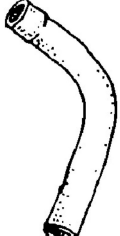
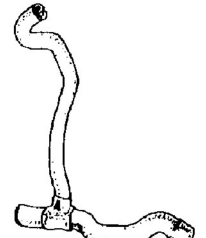



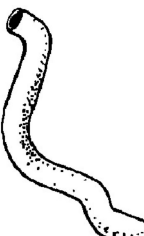
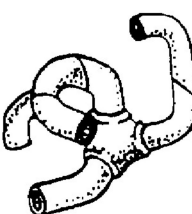



	<b>W5037</b> NO. 7700105707 POLIE DA BOMBA DA DIRECÇÃO (6 PISTAS) RENAULT CLIO II d98mm d29mm		<b>W5065</b> NO. 8200029592 - 8200972496 - 8200036888 - 8200113340 POLIE DA CAMBOTA (3 + 4 PISTAS) RENAULT CLIO II d125/149/156mm d20mm
	<b>W5067</b> NO. 7700105321 - 7700101242 - 8200313231 - 8200392683 - 8000544153 - 7700105788 - 8200044050 - 820055764... POLIE DA CAMBOTA (6 PISTAS) RENAULT CLIO II d133mm d26mm		<b>W5071</b> NO. 7700856673 POLIE DA CAMBOTA (6 PISTAS) RENAULT CLIO II d132mm d12.6mm
	<b>W5076</b> NO. 8200386460 - 7700116269 POLIE DA CAMBOTA (6 PISTAS) RENAULT CLIO II 2.0 16V d122.9mm d28.6mm		<b>W5077</b> NO. 8200392683 POLIE DA CAMBOTA (6 PISTAS) RENAULT CLIO II d133.6mm d26mm
	<b>W5108</b> NO. 8200392697 POLIE DA CAMBOTA (5 PISTAS) RENAULT CLIO II 1.4 16V (B/CB0P)(K4J 710 - K4J 711 - K4J 712) 98CV (APÓS 08-2000) - 1.5 dCi(K9K 712) 100CV (APÓS 01-2004) - 1.5 dCi (B/CB07) (K9K 700 - K9K 704) 65CV (APÓS 06-2001) - 1.5 dCi (B/CB08)(K9K 702) 82CV (APÓS 06-2001) - 1.5 dCi (B/CB3M) (K9K 740) NULL d153.4mm 1f-d26mm		<b>W5108</b> NO. 8200392697 POLIE DA CAMBOTA (5 PISTAS) RENAULT THALIA 1.5 dCi(K9K 700) 65CV (APÓS 04-2002) - 1.5 dCi(K9K 700) 68CV (APÓS 02-2003) - 1.5 dCi(K9K 702) 82CV (APÓS 06-2001) - 1.5 dCi(K9K 740) 64CV (APÓS 06-2005) NULL d153.4mm 1f-d26mm
	<b>W5132</b> NO. 7700875328 - 6001547643 POLIE DA BOMBA DA DIRECÇÃO (6 PISTAS) RENAULT CLIO II (BB0/1/2_ - CB0/1/2_) 1.9 D (B/CB0E) Hatchback (09-1998 A 05-2005) 64CV 1870CC - RENAULT CLIO II (BB0/1/2_ - CB0/1/2_) 1.9 D (B/CB0J) Hatchback (02-2000 A 05-2001) 65CV 1870CC - RENAULT CLIO II (BB0/1/2_ - CB0/1/2_) 1.9 dTi (B/CB0U) Hatchback d93mm 1f-d29mm		<b>Z80658</b> NO. 7703077362 Mola de friso RENAULT CLIO (2) 27.3x22x17.5mm 1p-d7.5-7.5mm
	<b>Z80722</b> NO. 7703077438 Mola de friso RENAULT CLIO (2) 35.5x20x10mm NULL		<b>Z80815</b> NO. 7703072360 - 0151500QAB NULL RENAULT CLIO (2) d18x26mm 1p-d8.5-14mm
	<b>Z80837</b> NO. 7703077434 Mola de painel RENAULT CLIO (2) d15.3x20.5mm 1p-d8-14mm		<b>Z80838</b> NO. 6991.Y8 - 7703077468 - 7703077469 - 8201112162 Mola RENAULT CLIO (2) d17x18.5mm 1p-d7.5-10.5mm

	<p><b>A1814</b> NO. 8200114739</p> <p>APOIO DO ESCAPE PARTE DE TRÁS</p> <p>RENAULT - CLIO III (BR0/1 - CR0/1) - 1.2 16V (BR0R - BR1D - BR1L - CR0R) (APÓS 06.05) 65cv 1149cc - RENAULT - CLIO III (BR0/1 - CR0/1) - 1.2 16V (BR02 - BR0J - BR11 - CR02 - CR0J - CR11) (APÓS 06.05) 75cv 1149cc - RENAULT - CLIO III (BR0/1 - CR0/1) - 1.2 16V Hi-Flex</p> <p>110x130x55mm NULL</p>		<p><b>E0242-M</b> NO. 8200338385</p> <p>ESTICADOR DO MOTOR CENTRO INFERIOR</p> <p>RENAULT CLIO III 1.4 16V 98CV (K4J 780) (APÓS 06-2005) - 1.5 Dci 64CV (K9K 752) (APÓS 06-2005) - 1.5 Dci 65CV (K9K 752) (APÓS 05-2005) - 1.5 Dci 75CV (K9K 770) (APÓS 08-2010) - 1.5 Dci 88CV (K9K 770) (APÓS 08-2010) - 1.5 Dci 106CV (K9K 764) (APÓS 06-2005)</p> <p>270x90x52mm 1f-d12mm 1f-d13.8mm</p>
	<p><b>RT80212</b> NO. 8200129954 - 8200597210</p> <p>TUBO DE TRAVÃO FRENTE LH-RH</p> <p>RENAULT CLIO III TT (APÓS 06-2005)</p> <p>480mm FZ - MC11</p>		<p><b>S1515</b> NO. 8200742906</p> <p>SILENT BLOC DA SUSPENSÃO DE TRÁS PARTE DA FRENTE</p> <p>RENAULT CLIO III 1.2 16V (D4F 764) 78 (APÓS 06-2005) - 1.2 16V (D4F 786) 103CV (APÓS 09-2010) - 1.2 16V (BR02 - BR0J - BR11 - CR02 - CR0J - CR11) (D4F 740) 75CV (APÓS 07-2008) - 1.2 16V (BR02 - BR0J - BR11 - CR02 - CR0J - CR11) (D4F 740) 75CV (APÓS 06-2005) - 1.2</p> <p>d53x80mm c55mm d40.5mm 1f-d16.8mm</p>
	<p><b>T0617-I</b> NO. 540503701R</p> <p>BATENTE SUSPENSÃO FRENTE</p> <p>RENAULT CLIO III (BR0/1 - CR0/1) 1.2 16V (APÓS 09.10) 103cv 1149cc Hatchback - RENAULT CLIO III (BR0/1 - CR0/1) 1.6 16V GT (BR10 - CR10) (APÓS 06.09) 128cv 1598cc Hatchback - RENAULT CLIO III (BR0/1 - CR0/1) 1.5 dCi (APÓS 08.10) 75cv 1461cc Hatchback</p> <p>d51x80mm 1f-d24mm 1f-d17mm</p>		<p><b>T0617-I</b> NO. 540503701R</p> <p>BATENTE SUSPENSÃO FRENTE</p> <p>RENAULT CLIO III (BR0/1 - CR0/1) 1.2 16V (APÓS 09.10) 103cv 1149cc Hatchback - RENAULT CLIO III (BR0/1 - CR0/1) 1.6 16V GT (BR10 - CR10) (APÓS 06.09) 128cv 1598cc Hatchback - RENAULT CLIO III (BR0/1 - CR0/1) 1.5 dCi (APÓS 08.10) 75cv 1461cc Hatchback - RENAULT CLIO Grandtour (KR0/1_) 1.2 16V (KR02 - KR0J) (APÓS 02.08) 75cv 1149cc - Combi RENAULT CLIO Grandtour (KR0/1_) 1.2 16V (KR0E) (APÓS 02.08) 78cv 1149cc</p> <p>d51x80mm 1f-d24mm 1f-d17mm</p>
	<p><b>W5106</b> NO. 8200477938 - 8200511194 - 8200185800 - 8200184103</p> <p>POLIE DA CAMBOTA (6 PISTAS)</p> <p>RENAULT CLIO III 1.5 Dci (BR17 - CR17) (K9K 766) 86CV (APÓS 06-2005)</p> <p>d155/151mm d26mm</p>		<p><b>W5108</b> NO. 8200392697</p> <p>POLIE DA CAMBOTA (5 PISTAS)</p> <p>RENAULT CLIO III 1.4 16V(K4J 780) 98CV (APÓS 06-2005) - 1.5 dCi(K9K 752) 64CV (APÓS 06-2005) - 1.5 dCi(K9K 752) 65CV (APÓS 05-2005) - 1.5 dCi(K9K 770) 75CV (APÓS 08-2010) - 1.5 dCi(K9K 770) 88CV (APÓS 08-2010) - 1.5 dCi (BROH - CR0H)(K9K 764) 106CV (</p> <p>NULL d153.4mm 1f-d26mm</p>
	<p><b>W5111</b> NO. 8200352613 - 8200552236 - 8200699517 - 8200544135 - 8200687605 - 8200395313 - 7700105788 - 820004405...</p> <p>POLIE DA CAMBOTA(6 PISTAS)</p> <p>RENAULT CLIO III (BR0-1 - CR0-1) 1.5 dCi (BR17 - CR17) (K9K 766) 86CV (APÓS 06-2005)</p> <p>d155-151mm d26mm</p>		<p><b>W5137</b> NO. 8200687605 - 8200699517 - 8200352613 - 8200395313 - 8200544135 - 8200552236 - 8200687605 - 820069951...</p> <p>POLIE DA CAMBOTA 6 PISTAS</p> <p>RENAULT CLIO III (BR0/1 - CR0/1) 1.2 16V Código do motor: K9K.7.74 (APÓS 06.05) 78cv 1149cc Hatchback - RENAULT CLIO III (BR0/1 - CR0/1) 1.4 16V Código do motor: K4J.7.80 - Variante de equipamento: +AC (APÓS 06.05) 98cv 1390cc Hatchback - RENAULT CLIO III (BR0/1 - CR0/1) 1.6 16V (BR09 - BR0T - CR09 - CR0T) Código do motor: K4M.8.02 - Variante de equipamento: +AC - Código do motor: K4M.8.04 (APÓS 06.05) 88cv 1598cc Hatchback - RENAULT CL...etc.</p> <p>d155mm d26mm</p>
	<p><b>Z80683</b> NO. 7701047661</p> <p>Mola de friso</p> <p>RENAULT CLIO (3)</p> <p>23x21x20mm 1p-d8-12mm</p>		<p><b>Z80825</b> NO.</p> <p>Mola</p> <p>Renault Clio III</p> <p>12x7x10.6mm 1p-6x4.5-8.5mm</p>
	<p><b>Z80837</b> NO. 7703077434</p> <p>Mola</p> <p>Renault Clio III</p> <p>d15.3x20.5mm 1p-d8-14mm</p>		<p><b>Z80838</b> NO. 6991.Y8 - 7703077468 - 7703077469 - 8201112162</p> <p>Mola</p> <p>RENAULT CLIO (3)</p> <p>d17x18.5mm 1p-d7.5-10.5mm</p>

	<b>A1033</b> NO. 7700801543 SUPORTE FRENTE ESQUERDO DO MOTOR RENAULT CLIO 100x72x52mm 1p-d10-30mm 1p-d10-26mm		<b>A1034</b> NO. 7700804163 - 7702253382 SUPORTE TRÁS CENTRAL DO MOTOR RENAULT CLIO 165x155x120mm 1f-d11mm
	<b>A1075</b> NO. 7700785949 SUPORTE FRENTE DIREITO DO MOTOR RENAULT CLIO 115x85x80mm 2p-d10-27mm 1p-d10-30mm		<b>A1161-H</b> NO. 7700795689 SUPORTE MOTOR DIREITO (HIDRÁULICO) RENAULT CLIO 175x135x120mm 1p-d10-30mm
	<b>A1200</b> NO. 7700795689 APOIO ESQUERDO DO MOTOR RENAULT CLIO DIESEL 138x104x37mm 1f-d12mm		<b>A1479</b> NO. 7700827436 APOIO SUPERIOR DO AMORTECEDOR SUSPENSÃO DA FRENTE RENAULT CLIO DIESEL 1.9 d96x40mm 1f-d28mm
	<b>A1479-C</b> NO. 7700827436S APOIO DO AMORTECEDOR DA FRENTE(COM ROLAMENTO) RENAULT CLIO 1 1.7 - 1.8 - 1.8 16V - 1.8 RSi - 1.9 D - 2.0i 16V d97x40mm 1f-d32mm 1f-d16mm		<b>A1519</b> NO. 7700415087 APOIO DO MOTOR FRENTE LADO DIREITO RENAULT CLIO 2 (APÓS 1998) 170x100x80mm 1f-d12mm
	<b>A1531</b> NO. 7700424339 APOIO DE ESCAPE (PARTE DE TRÁS) RENAULT CLIO (APÓS 2000) 217x95x85mm NULL		<b>A1599</b> NO. 8200267625 - 8200253037 - 7700436286 APOIO DO MOTOR LADO DIREITO RENAULT CLIO 2 1.5 DCi - 1.9 Dti 175x135x90mm 1p-d10-32mm
	<b>A1705</b> NO. 7700435270 APOIO DE ESCAPE RENAULT CLIO (APÓS 09-1998) - THALIA (APÓS 08-2000) 120x100x80mm NULL		<b>BB01</b> NO. 7700680098 ABRAÇADEIRA DA BARRA ESTABILIZADORA RENAULT CLIO 79x28x20mm NULL
	<b>BB03</b> NO. 7700680097 ABRAÇADEIRA DA BARRA ESTABILIZADORA RENAULT CLIO 74x35x22mm NULL		<b>BE25</b> NO. 7701458595 - 7701450595 ABRAÇADEIRA DE ESCAPE CÔNCAVA (58 mm) RENAULT CLIO (APÓS 1990) 95x60x20mm 2p-d8mm
	<b>D0015</b> NO. 7700687433 - 7701349339 - 7700691031 - 7700705138 JUNTA DE CARDAN DA DIRECÇÃO RENAULT CLIO 43x32x32mm 2f-d8mm		<b>E0027</b> NO. 7700779356 ESTICADOR DE ESCAPE RENAULT CLIO (APÓS 90) 51x27x27mm NULL

	<p><b>E0037</b> NO. 7700785798</p> <p>SUPOORTE DE ESCAPE</p> <p>RENAULT CLIO TT</p> <p>50x50x28mm NULL</p>		<p><b>E0200-M</b> NO. 7700411638</p> <p>ESTICADOR DA SUSPENSÃO DO MOTOR (CAIXA)</p> <p>RENAULT CLIO - CLIO DIESEL</p> <p>165x66x46mm 2f-d10mm</p>
	<p><b>E0201-M</b> NO. 7700800522</p> <p>ESTICADOR DA SUSPENSÃO DO MOTOR (CAIXA)</p> <p>RENAULT CLIO ALUMINIUM GASOLINA</p> <p>165x67x46mm 2f-d10mm</p>		<p><b>E0202-M</b> NO. 7700849715</p> <p>ESTICADOR DO MOTOR TRÁS</p> <p>RENAULT CLIO 1.2 (APÓS 1998)</p> <p>168x81x45mm 1f-d10mm 1f-d10mm</p>
	<p><b>E0205-M</b> NO. 7700428936</p> <p>ESTICADOR DO MOTOR PARTE TRÁS</p> <p>RENAULT CLIO 2 1.9D (APÓS 1998)</p> <p>160x60x46mm 2f-d10mm</p>		<p><b>E1068</b> NO. 0560804 - 09191205 - 560804 - 9191205</p> <p>ESTICADOR DE ESCAPE</p> <p>RENAULT CLIO (1996 A 1998)</p> <p>52x28x28mm NULL</p>
	<p><b>F0906-I</b> NO. 7700745663</p> <p>FOLE DO LADO DA RODA (JUNTA d90mm EIXO d25mm)</p> <p>RENAULT CLIO</p> <p>d103x83mm 1f-d80mm 1f-d22mm</p>		<p><b>F1065</b> NO. 7701466120</p> <p>FOLE DO CARDAN JUNTO À RODA</p> <p>RENAULT CLIO</p> <p>d108x130mm 1f-d88mm 1f-d25mm</p>
	<p><b>F1066</b> NO. 7701466120</p> <p>FOLE DA TRANSMISSÃO JUNTO À RODA</p> <p>RENAULT CLIO GASOLINA</p> <p>d91x122mm 1f-d83mm 1f-d34mm</p>		<p><b>F1071</b> NO. 7701465489 - 7701466122 - 7701034800 - 7701467125</p> <p>FOLE DO SEMI-EIXO DO DIFERENCIAL LADO DA RODA</p> <p>RENAULT CLIO</p> <p>d92x135mm 1f-d86mm 1f-d26mm</p>
	<p><b>F1089-I</b> NO.</p> <p>FOLE DA TRANSMISSÃO LADO DA RODA</p> <p>RENAULT CLIO</p> <p>d93x110mm 1f-d80mm 1f-d22mm</p>		<p><b>F1108-I</b> NO. 7700706007 - 7700781095</p> <p>FOLE DA DIREÇÃO ASSISTIDA+G1485</p> <p>RENAULT CLIO</p> <p>d74x140mm 1f-d40mm 1f-d9mm</p>
	<p><b>F1571-I</b> NO. 7700802667</p> <p>FOLE AMORTECEDORES DA FRENTE</p> <p>RENAULT CLIO</p> <p>d58x195mm d44mm 1f-d56mm 1f-d19mm</p>		<p><b>H546</b> NO.</p> <p>PALA ORIGINAL</p> <p>RENAULT CLIO</p> <p>255x205mm NULL</p>
	<p><b>KB2063</b> NO.</p> <p>KIT DA BARRA ESTABILIZADORA (DIÂMETRO 21)</p> <p>RENAULT CLIO</p> <p>NULL NULL</p>		<p><b>KB2250</b> NO.</p> <p>KIT DA BARRA ESTABILIZADORA</p> <p>RENAULT CLIO</p> <p>NULL NULL</p>

	<p><b>KF2531-T</b> NO. 7701466120</p> <p>FOLE DO LADO DA RODA</p> <p>RENAULT CLIO</p> <p>d90x140mm 1f-d33mm 1f-d70mm</p>		<p><b>KF2599-T</b> NO. 7701465489 - 7701466122</p> <p>FOLE DO LADO DA RODA</p> <p>RENAULT CLIO</p> <p>d97x143mm 1f-d33mm 1f-d82mm</p>
	<p><b>KL0008</b> NO. 770078304 - 7700662571</p> <p>KIT DE CASQUILHOS DA DIRECÇÃO ASSISTIDA</p> <p>RENAULT CLIO</p> <p>d61x49mm 1f-d47mm</p>		<p><b>L3010</b> NO. 7704000926</p> <p>CASQUILHO DA EXTREMIDADE DA CREMALHEIRA DA DIRECÇÃO</p> <p>RENAULT CLIO TT</p> <p>33x31x18mm 1f-d20mm</p>
	<p><b>M6000</b> NO. 7700797807</p> <p>JUNTA DE ESCAPE</p> <p>RENAULT CLIO</p> <p>d67x11.5mm 1f-d52mm</p>		<p><b>M6051</b> NO. 7700766353 - 7700782519 - 6025308326 - 7700766355 - 3445663 - 3458510</p> <p>JUNTA DE ESCAPE</p> <p>RENAULT CLIO (1990 A 1992)</p> <p>d89x12.2mm 1f-d74.5mm</p>
	<p><b>M6053</b> NO. 7700774367</p> <p>JUNTA DE ESCAPE</p> <p>RENAULT CLIO (APÓS 1990)</p> <p>105x75mm 1f-d55mm</p>		<p><b>M6503</b> NO. 7700852033</p> <p>JUNTA DO CARBORADOR</p> <p>RENAULT CLIO</p> <p>128x128x20mm NULL</p>
	<p><b>MT6700</b> NO.</p> <p>JUNTA DE TERMOSTATO</p> <p>RENAULT CLIO 1.2 - 1.4 - 1.7 - 1.8i 16v</p> <p>d52x2mm 1f-d43mm</p>		<p><b>P1015</b> NO. 7700680836</p> <p>CAPA DE PEDAL DO TRAVÃO E EMBRAIAGEM</p> <p>RENAULT CLIO TT</p> <p>60x50x12mm NULL</p>
	<p><b>Q2009</b> NO.</p> <p>UNIÃO DE ESCAPE 48/45x80mm</p> <p>RENAULT - CLIO Grandtour (KR0/1_) - 1.2 16V (KR02 - KR0J) (APÓS 02.08) 75cv 1149cc Combi - RENAULT - CLIO Grandtour (KR0/1_) - 1.2 16V (KR0E) (APÓS 02.08) 78cv 1149cc Combi - RENAULT - CLIO Grandtour (KR0/1_) - 1.2 16V (KR0P) (APÓS 02.08) 101cv 1149cc Com</p> <p>80x77x55mm 1f-d45/48mm</p>		<p><b>R221600</b> NO. 7700801058 - 6006003616</p> <p>TUBO SUPERIOR DE ENTRADA DE ÁGUA DO RADIADOR</p> <p>RENAULT CLIO (1.1)</p> <p>B340-d30/38mm 105-110-125-80mm</p>
	<p><b>R221602</b> NO. 7700801059</p> <p>TUBO INFERIOR DE SAÍDA DE ÁGUA DO RADIADOR</p> <p>RENAULT CLIO (1.1 - 1.2)</p> <p>B445-d31/38mm 60-50-65-155-165-100mm</p>		<p><b>R221605</b> NO. 7700801054</p> <p>TUBO DE RADIADOR SUPERIOR</p> <p>RENAULT CLIO (1.2 - 1.4)</p> <p>B265-d32/32mm 145-185mm</p>
	<p><b>R221606</b> NO. 7700801055 - 7700815153</p> <p>TUBO DE RADIADOR INFERIOR 3VIAS</p> <p>RENAULT CLIO (1.2 - 1.4)</p> <p>NULL NULL</p>		<p><b>R221607</b> NO. 7700801056</p> <p>TUBO DE LIGAÇÃO AO DEPÓSITO DE ARREFECIMENTO</p> <p>RENAULT CLIO 1.2 - 1.4</p> <p>B490-d27/27mm - d10mm 135-140-145-160-65-70mm 60-165-165-80-85mm</p>

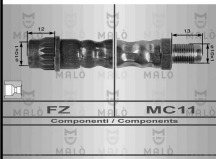
	<p><b>R221620</b> NO. 7700801073 - 7700824034</p> <p>TUBO DE RADIADOR SUPERIOR C/ SANGRADOR</p> <p>RENAULT CLIO DIESEL</p> <p>B470-d31/31mm 80-250-150-30-50mm</p>		<p><b>R221621</b> NO. 7700801067</p> <p>TUBO DE RADIADOR INFERIOR 4 VIAS</p> <p>RENAULT CLIO DIESEL</p> <p>NULL NULL</p>
	<p><b>R221622</b> NO. 7700801072</p> <p>TUBO DE LIGAÇÃO AO DEPÓSITO DE ARREFECIMENTO</p> <p>RENAULT CLIO DIESEL</p> <p>B205-d16/16mm 160-75-110mm + ch-d15mm 165mm</p>		<p><b>R221623</b> NO. 7700847054</p> <p>TUBO SUPERIOR DO RADIADOR</p> <p>RENAULT CLIO 2 1.4 16V - 1.6 16V</p> <p>B355-d30/30mm 100-110-90-80-60mm</p>
	<p><b>RF5001</b> NO. 7700859465 - 7700859759</p> <p>TUBO DE FERRO RADIADOR</p> <p>RENAULT CLIO 1.2 - 1.4</p> <p>B400-d27/28mm 290-110mm+ch70-d13mm</p>		<p><b>RF5002</b> NO. 7700858911</p> <p>TUBO DE FERRO RADIADOR</p> <p>RENAULT CLIO (COM CATALIZADOR)</p> <p>B315-d17/17mm 50-185-75-65mm+ch110-d14mm</p>
	<p><b>RF5003</b> NO. 7700860371</p> <p>TUBO DE FERRO RADIADOR</p> <p>RENAULT CLIO F-2N</p> <p>B415-d18/18mm 85-275-120+B385-d13/13mm-100-255-65</p>		<p><b>RF5004</b> NO. 7700864993</p> <p>TUBO DE FERRO RADIADOR</p> <p>RENAULT CLIO (MOTOR DIESEL F-8Q)</p> <p>B420-d17/17mm 70-55-70-80-65-50-150-50mm+B240-d13/13mm-65</p>
	<p><b>RF5005</b> NO. 7700860386</p> <p>TUBO DE FERRO RADIADOR</p> <p>RENAULT CLIO (MOTOR DIESEL F-8Q)</p> <p>B455-d17/17mm 70-200-65-200-50mm+ch105-d14mm+ch</p>		<p><b>RF5006</b> NO. 7700859379</p> <p>TUBO DE FERRO RADIADOR</p> <p>RENAULT CLIO (MOTOR DIESEL F-8Q) SEM AR CONDICIONADO</p> <p>B325-d17/17mm 60-270-45-80mm</p>
	<p><b>RF5007</b> NO. 7700742245 - 7700860374</p> <p>TUBO DE FERRO RADIADOR</p> <p>RENAULT CLIO (MOTOR F2 TXE) COM AR CONDICIONADO</p> <p>B325-d17/17mm 65-265-65-80mm+B260-d13/13mm-255-5</p>		<p><b>RF5008</b> NO. 7700856932 - 7700866559</p> <p>TUBO DE FERRO RADIADOR</p> <p>RENAULT CLIO (MOTOR 1.7)</p> <p>B260-d18/18mm 90-70-170mm+B265-d14/14mm-55-105-100-45-55</p>
	<p><b>RF5010</b> NO. 7700873508</p> <p>TUBO DE FERRO RADIADOR</p> <p>RENAULT CLIO DIESEL</p> <p>B410-d17/17mm 185-50-75-95-50-60-55mm+B240-d13/13</p>		<p><b>RF5014</b> NO.</p> <p>TUBO DE FERRO RADIADOR</p> <p>RENAULT CLIO 1.9 DIESEL</p> <p>B420-d18/18mm 165-70-75-100-70-70mm</p>
	<p><b>RF5015</b> NO. 7700875497</p> <p>TUBO DE FERRO RADIADOR</p> <p>RENAULT CLIO 1.9 DIESEL</p> <p>B405-d17/17mm 55-65-75-90-70-60-160mm+ch60-d13mm</p>		<p><b>RT08445</b> NO. 7700804356 - 7700824736</p> <p>TUBO DE TRAVÃO FRENTE LH-RH</p> <p>RENAULT CLIO TT (01-1991 A 09-1998)</p> <p>267mm FZ - MC11</p>



	<b>S1102</b> NO. 7700799065D - 7700799064 SILENT-BLOC DO TRAPÉZIO DIREITO RENAULT CLIO TT d42x46mm d40mm 1f-d12mm		<b>S1103</b> NO. 7700799065 SILENT-BLOC TRÁS DO TRAPÉZIO DA SUSPENSÃO FRENTE RENAULT CLIO TT d40x46mm c35mm 1f-d12mm
	<b>S1188</b> NO. 7700224699 SILENT-BLOC DO EIXO TRASEIRO RENAULT CLIO d77x28mm c28mm 1f-d43mm		<b>S1188-A</b> NO. 7700224699 SILENT-BLOC DO EIXO TRASEIRO RENAULT CLIO d77x28mm c28mm 1f-d43mm
	<b>S1200</b> NO. 7700799404 SILENT-BLOC DA BARRA ESTABILIZADORA RENAULT CLIO d26x74mm NULL		<b>T0617-I</b> NO. 540503701R BATENTE SUSPENSÃO FRENTE RENAULT CLIO Grandtour (KR0/1_) 1.2 16V (KR02 - KR0J) (APÓS 02.08) 75cv 1149cc - Combi RENAULT CLIO Grandtour (KR0/1_) 1.2 16V (KR0E) (APÓS 02.08) 78cv 1149cc - Combi RENAULT CLIO Grandtour (KR0/1_) 1.2 16V (KR0P) (APÓS 02.08) 101cv 1149cc - Combi RENAULT CLIO Grandtour (KR0/1_) 1.6 16V (KR0B) 02.08 - 82 112 1598 Combi RENAULT CLIO Grandtour (KR0/1_) 1.6 16V (KR10) (APÓS 11.08) 128cv 1598cc - Combi RENAULT CLIO Grandtour (KR0/1_) 1.5 dCi ...etc. d51x80mm 1f-d24mm 1f-d17mm
	<b>T0617-I</b> NO. 540503701R BATENTE SUSPENSÃO FRENTE RENAULT CLIO Grandtour (KR0/1_) 1.2 16V (KR02 - KR0J) (APÓS 02.08) 75cv 1149cc - Combi RENAULT CLIO Grandtour (KR0/1_) 1.2 16V (KR0E) (APÓS 02.08) 78cv 1149cc - Combi RENAULT CLIO Grandtour (KR0/1_) 1.2 16V (KR0P) (APÓS 02.08) 101cv 1149cc - Combi RENAULT CLIO Grandtour (KR0/1_) 1.6 16V (KR0B) 02.08 - 82 112 1598 Combi RENAULT CLIO Grandtour (KR0/1_) 1.6 16V (KR10) (APÓS 11.08) 128cv 1598cc - Combi RENAULT CLIO Grandtour (KR0/1_) 1.5 dCi ...etc. d51x80mm 1f-d24mm 1f-d17mm		<b>T1006F22</b> NO. 7700760265 BATENTE LATERAL DA BARRA ESTABILIZADORA DA SUSPENSÃO FRENTE FURO 22mm RENAULT CLIO TT 54x47x41mm 1f-d22mm
	<b>T1006F23</b> NO. 7700760264 BATENTE DAS PONTAS DA BARRA ESTABILIZADORA (FURO 23 mm) RENAULT CLIO 57x46x42mm 1f-d23mm		<b>U1001</b> NO. 7700788381 LIMITADOR DE APOIO RENAULT CLIO 170x86x86mm NULL
	<b>U7010</b> NO. 8200059541 TENSORES CORREIA ALTERNADOR RENAULT CLIO 1.4 - 1.4 16V (K4J) (APÓS 1998) d34x130mm 2f-d8mm		<b>W5108</b> NO. 8200392697 POLIE DA CAMBOTA (5 PISTAS) RENAULT GRANDTOUR 1.4 16V(K4J 780) 98CV (APÓS 02-2010) - 1.5 dCi(K9K 770) 75CV (APÓS 08-2010) - 1.5 dCi(K9K 772) 88CV (APÓS 08-2010) - 1.5 dCi (KR0F)(K9K 766) 86CV (APÓS 02-2008) - 1.5 dCi (KR0G)(K9K 768) 68CV (APÓS 02-2008) - 1.5 dCi (KR0H)(K9K 764) NULL d153.4mm 1f-d26mm
	<b>W5137</b> NO. 8200687605 - 8200699517 - 8200352613 - 8200395313 - 8200544135 - 8200552236 - 8200687605 - 820069951... POLIE DA CAMBOTA 6 PISTAS RENAULT CLIO Grandtour (KR0/1_) 1.4 16V Código do motor: K4J.7.80 - Variante de equipamento: +AC (APÓS 02.10) 98cv 1390cc Combi - RENAULT CLIO Grandtour (KR0/1_) 1.6 16V (KR0B) Código do motor: K4M.8.00 - Variante de equipamento: +AC - Código do motor: K4M.8.01 (APÓS 02.08) 112cv 1598cc Combi - RENAULT CLIO Grandtour (KR0/1_) 1.6 16V (KR10) Código do motor: K4M.8.62 - Variante de equipamento: +AC (APÓS 11.08) 128cv 1598cc Combi - RENAULT...etc. d155mm d26mm		<b>Z80310</b> NO. 7703079652 Mola de fixação RENAULT CLIO 16x11x14mm 1p-d5.3-5mm
	<b>Z80474</b> NO. 7703077068 Mola de painel RENAULT CLIO d18.5x13.5mm 1p-d7-12mm		<b>Z80498</b> NO. 82386320101C Mola de painel RENAULT CLIO d15.5x19.5mm 1p-d7-17.5mm

	<b>Z80583</b> NO. 7703077117		<b>Z80601</b> NO.
	Mola de painel RENAULT CLIO		Mola de friso RENAULT CLIO
	d20x15.5mm 1p-d7.5-13.5mm		34x25x9mm NULL
	<b>Z80603</b> NO. 7703077256		<b>Z80608</b> NO. 7703077225 - 7518N8
	Mola de friso RENAULT CLIO		Mola de painel RENAULT CLIO
	18.6x13x9.5mm NULL		d35x25mm 1p-d10.7-22.5mm
	<b>Z80629</b> NO. 7703077250		<b>Z80633</b> NO. 7703081054
	Mola de painel RENAULT CLIO		Mola de painel RENAULT CLIO
	d15x19mm 1p-d8.5-12.5mm		d30x17mm 1p-d9.7-15mm
	<b>Z80671</b> NO. 7703081190		<b>Z80737</b> NO. 7703077435
	Mola de fixação RENAULT CLIO		Mola de painel RENAULT CLIO
	d10x12mm 1p-d8-10mm 1f-d5.5mm		d35.5x25.5mm 1p-d12.5-22.5mm

RENAULT SPACE

	<b>A0808-8</b> NO. 7700565762		<b>A1152</b> NO. 7704000769
	SUPORTE DE ESCAPE (PERNO 8mm) RENAULT SPACE TT		SUPORTE ESQUERDO DO MOTOR RENAULT SPACE
	48x42x27mm 2p-d8-18mm		140x120x70mm 1p-d10-27mm
	<b>A1153</b> NO. 7704000829		<b>A1281</b> NO. 7704000767
	SUPORTE DIANTEIRO DO MOTOR RENAULT SPACE		APOIO SUPERIOR DIREITO DO MOTOR RENAULT SPACE
	74x54x50mm 1f-d10mm 2p-d8-22mm		d65x48mm 2p-d10mm
	<b>E0015</b> NO. 7700686449 - 7700795220		<b>E0025</b> NO. 4371804 - 4371803 - 2T144A084AA
	ESTICADOR DE ESCAPE RENAULT SPACE TT		SUPORTE DE ESCAPE RENAULT SPACE (APÓS 1988)
	87x31x26.5mm NULL		54x33x27mm NULL

	<b>E0141</b> NO. 7700805494 ESTICADOR DA BARRA ESTABILIZADORA DA FRENTE RENAULT ESPACE TT - LAGUNA I TT 370x35x40mm 1p-d10-28mm 1p-d10-30mm		<b>E1013</b> NO. 7700632015 ESTICADOR DE ESCAPE RENAULT ESPACE d64x13mm 1f-d41mm
	<b>F0827-1I</b> NO. FOLE DE TRANSMISSÃO DIREITO LADO DA CAIXA (PARA TRANSMISSÕES REPARADAS) RENAULT ESPACE d96x112mm 1f-d78mm 1f-d32mm		<b>F0830-1I</b> NO. 7701349696 - 7701349841 - 7701464758 - 7701466172 FOLE DA TRANSMISSÃO JUNTO À CAIXA RENAULT ESPACE (2) 2.1 TD - 2.2i 4X4 - 2.8i V6 (1991 A 1996) d90x113mm 1f-d24mm 1f-d73mm
	<b>F0830-1I</b> NO. 7701349696 - 7701349841 - 7701464758 - 7701466172 FOLE DA TRANSMISSÃO JUNTO À CAIXA RENAULT ESPACE (1) 2.0 - 2.1 TD - 2.2 - 2.2 QUADRA (1984 A 1990) d90x113mm 1f-d24mm 1f-d73mm		<b>F0830-1I</b> NO. 7701349696 - 7701349841 - 7701464758 - 7701466172 FOLE DA TRANSMISSÃO JUNTO À CAIXA RENAULT ESPACE (3) 1.9 DTi - 2.0i - 2.0i 16V - 2.2 DT 12V - 3.0i V6 (1996 A 2002) d90x113mm 1f-d24mm 1f-d73mm
	<b>F1329-I</b> NO. 7701472212 - 7701466349 - 7701470299 FOLE DA TRANSMISSÃO JUNTO À CAIXA RENAULT ESPACE II 2.8i V6 - 3.0i V6 (1991 A 1996) d86x102mm 1f-d73mm 1f-d26mm		<b>F1329-I</b> NO. 7701472212 - 7701466349 - 7701470299 FOLE DA TRANSMISSÃO JUNTO À CAIXA RENAULT ESPACE III 3.0i (1996 A 2002) d86x102mm 1f-d73mm 1f-d26mm
	<b>F1827-I</b> NO. 7701207566 FOLE DA TRANSMISSÃO JUNTO À CAIXA RENAULT ESPACE III 2.2 DCi (1996 A 2002) d115x85mm 1f-d73mm 1f-d42mm		<b>KF2534</b> NO. KIT DE FOLE RENAULT ESPACE d95x128mm 1f-d80mm 1f-d26mm
	<b>M6052</b> NO. 7700781679 - 7700782520 - 8932001367 - 8933000112 JUNTA DE ESCAPE RENAULT ESPACE d67x13.8mm 1f-d49.6mm		<b>P1015</b> NO. 7700680836 CAPA DE PEDAL DO TRAVÃO E EMBRAIAGEM RENAULT ESPACE TT 60x50x12mm NULL
	<b>RT08992</b> NO. 7700845510 TUBO DE TRAVÃO FRENTE LH-RH RENAULT ESPACE TT (APÓS 01-1991) 420mm FZ - MC11		<b>U7010</b> NO. 8200059541 TENSORES CORREIA ALTERNADOR RENAULT ESPACE 1.9 DTi (F9Q) d34x130mm 2f-d8mm
	<b>UBV8010</b> NO. 068198821A BOMBA VACUO (KIT REPARAÇÃO) RENAULT ESPACE (DIESEL) d102x1mm 9f-d5mm		<b>W5032</b> NO. 7700853469 POLIE DA CAMBOTA (1 PISTA) RENAULT ESPACE 2.1D - 2.1TD MOTORES J85 (740) (786) d118mm d15mm

	<b>W5038</b> NO. 8200802664 - 8200051126 - 8200213058 - 8200207436 - 8200664348 - 8200195546 - 8200555547 - 820046808...		<b>W5061</b> NO. 7700853774
	POLIE DA CAMBOTA (6 PISTAS) RENAULT ESPACE 2.2 DCi (APÓS 2002) d148mm d30mm		POLIE DA CAMBOTA (2 PISTAS) RENAULT ESPACE d117/133mm d15mm
	<b>W5068</b> NO. 7700115766 - 8200386446 - 7700113776 - 8200386451 - 8200079183 - 8200689705 - 7700739905 - 4413749 - ...		<b>W5074</b> NO. 8200523072 - 8200457775 - 8200268426 - 8200297936 - 8200376911 - 8200188832 - 8200457779 - 820029793...
	POLIE DA CAMBOTA (6 PISTAS) RENAULT ESPACE d151/155mm d12.6mm		POLIE DA CAMBOTA (7 PISTAS) RENAULT ESPACE 1.9 DCi (APÓS 2001) d150.9mm d24.6mm
	<b>Z80474</b> NO. 7703077068		<b>Z80608</b> NO. 7703077225 - 7518N8
	Mola de painel RENAULT ESPACE d18.5x13.5mm 1p-d7-12mm		Mola de painel RENAULT ESPACE d35x25mm 1p-d10.7-22.5mm
	<b>Z80671</b> NO. 7703081190		<b>Z80737</b> NO. 7703077435
	Mola de fixação RENAULT ESPACE d10x12mm 1p-d8-10mm 1f-d5.5mm		Mola de painel RENAULT ESPACE d35.5x25.5mm 1p-d12.5-22.5mm





RENAULT ESPACE (2)

	<b>F1701K3I</b> NO. 7701470910		<b>KF2529-T</b> NO. 7701469021
	FOLE DA TRANSMISSÃO JUNTO À CAIXA RENAULT ESPACE II 2.2 DCi (1996 A 2002) d85x200mm 1f-d75mm 1f-d25mm		KIT DE FOLE DO CARDAN JUNTO À RODA RENAULT ESPACE II 1.9 DTi - 2.0i - 2.0i 16V - 2.1 TD - 2.2 DT 12V - 2.2i 4X4 - 2.8i V6 - 3.0i V6 (1991 A 1996) - ESPACE III 1.9 DTi - 2.0i - 2.2 DT - 3.0i (1996 A 2002) d110x140mm 1f-d88mm 1f-d27mm
	<b>S1561</b> NO. 7700824709		<b>S1562</b> NO. 7700826216
	SILENTBLOC DO SUBCHASSIS DIANTEIRO PARTE DE TRÁS RENAULT ESPACE II (J/S63_) 2.0 (J636) (01.91 A 10.96) 103cv 1995cc Veículo multiuso - RENAULT ESPACE II (J/S63_) 2.2 (J/S637 - J63G) (01.91 A 10.96) 108cv 2165cc Veículo multiuso - RENAULT ESPACE II (J/S63_) 2.2 4x4 (J/S637 - J63G) (03.91 A 12.96) 108cv 2165cc Veículo multiuso - RENAULT ESPACE II (J/S63_) 2.8 V6 (J638 - J63J) (01.91 A 10.96) 150cv 2849cc Veículo multiuso - RENAULT ESPACE II (J/S63_) 2.1 TD (J633 - J634 - J/S635 - J/S63D) ...etc. d50x61mm c46mm d40mm 1f-d12mm		SILENTBLOC DO SUBCHASSIS DIANTEIRO PARA A FRENTE RENAULT ESPACE II (J/S63_) 2.0 (J636) Local de montagem: Eixo dianteiro - Tipo de apoio: Apoio de borracha-metal - Local de montagem: à frente (01.91 A 10.96) 103cv 1995cc Veículo multiuso - RENAULT ESPACE II (J/S63_) 2.2 (J/S637 - J63G) Local de montagem: Eixo dianteiro - Tipo de apoio: Apoio de borracha-metal - Local de montagem: à frente (01.91 A 10.96) 108cv 2165cc Veículo multiuso - RENAULT ESPACE II (J/S63_) 2.2 4x4 (J/S637 - J63G) Lo., etc. d50x83mm c54mm d40mm 1f-d13,5mm

## RENAULT ESPACE (3)

	<b>E0224-M</b> NO. 7700825794 ESTICADOR DO MOTOR PARTE DE TRÁS RENAULT ESPACE III 3.0 V6 24V(10-1998 A 10-2002)		<b>E0227-M</b> NO. 6025304389 ESTICADOR DO MOTOR PARTE DE TRÁS RENAULT ESPACE III 1.9 DTi (02-1999 A 10-2002) - 2.0 (11-1996 A 10-2000) - 2.0(16V) (10-1998 A 10-2002)
121x64x61mm	1f-d14mm 2f-d16-15mm	225x59x45mm	2f-d10mm
	<b>E0238-M</b> NO. 6025403418 ESTICADOR DO MOTOR PARTE DE TRÁS RENAULT ESPACE III 1.9 DTi (02-1999 A 10-2002) - 2.0 (11-1996 A 10-2002) - 2.2 DCi (10-2000 A 10-2002) - 3.0 V6 24V (10-1998 A 10-2002)		<b>E0239-M</b> NO. 7700411189 ESTICADOR DO MOTOR PARTE DE TRÁS RENAULT ESPACE III 2.2 12V TD (11-1996 A 10-2000) - 2.2 DCi (10-2000 A 10-2002) - 3.0 V6 24V (10-1998 A 10-2002)
170x61x52mm	2f-d14mm	187x60x61mm	2f-d14mm
	<b>KF2539-T</b> NO. 7701470155 KIT DE FOLE DO CARDAN JUNTO À RODA RENAULT ESPACE III 2.2 DCi (1996 A 2002)		<b>S1561</b> NO. 7700824709 SILENTBLOC DO SUBCHASSIS DIANTEIRO PARTE DE TRÁS RENAULT ESPACE III (JE0_) 2.0 (JE0A) (11.96 A 10.00) 114cv 1998cc Veículo multiuso - RENAULT ESPACE III (JE0_) 2.0 (09.01 A 10.02) 139cv 1998cc Veículo multiuso - RENAULT ESPACE III (JE0_) 2.0 16V (JE0N - JE0L - JE02) (10.98 A 10.02) 140cv 1998cc Veículo multiuso - RENAULT ESPACE III (JE0_) 3.0 (JE0D) (11.96 A 10.98) 167cv 2963cc Veículo multiuso - RENAULT ESPACE III (JE0_) 3.0 V6 24V (JEOG - JEOB) (10.98 A 10.02) 190cv 2946cc Veículo m...etc.
d110x150mm	1f-d98mm 1f-d30mm	d50x61mm	c46mm d40mm 1f-d12mm
	<b>S1562</b> NO. 7700826216 SILENTBLOC DO SUBCHASSIS DIANTEIRO PARA A FRENTE RENAULT ESPACE III (JE0_) 2.0 (JE0A) Local de montagem: Eixo dianteiro - Tipo de apoio: Apoio de borracha-metal - Local de montagem: à frente (11.96 A 10.00) 114cv 1998cc Veículo multiuso - RENAULT ESPACE III (JE0_) 2.0 Local de montagem: Eixo dianteiro - Tipo de apoio: Apoio de borracha-metal - Local de montagem: à frente (09.01 A 10.02) 139cv 1998cc Veículo multiuso - RENAULT ESPACE III (JE0_) 2.0 16V (JE0N - JE0L - JE02) Local de mont ag...etc.		<b>W5046</b> NO. 7700104292 POLIE DA CAMBOTA (6 PISTAS) RENAULT ESPACE III 2.2 TD Mtr G8T714-716 (113CV) (11-1996 A 10-2000)
d50x83mm	c54mm d40mm 1f-d13,5mm	d140mm	d14,5mm
	<b>W5083</b> NO. 8200207435 - 8200162582 - 8200664350 - 8200555549 - 8200802666 - 8200458171 - 8200097903 POLIE DA CAMBOTA (7 PISTAS) RENAULT - ESPACE III (JE0_) - 2.2 dCi (JE0K) Veículo multiuso 130CV 2188cc (10-2000 A 10-2002) - ESPACE IV (JK0 - 1_) - 2.2 dCi (KJ07) Veículo multiuso 139CV 2188cc (APOS 02-2006) - 2.2 dCi (JK0H) Veículo multiuso 150CV 2188cc (APOS 11-2002)		
d152/162mm	d30/58mm		



## RENAULT ESPACE (4)

	<b>A1782</b> NO. 8200052028 - 8200181590 APOIO DO MOTOR FRENTE LADO DIREITO RENAULT ESPACE IV 3.0 dCi (JKOJ - JKOV) P9X 701 177CV (APOS 11-2002) - 3.0 dCi (JKOY) P9X 715 181CV (APOS 01-2006) - 3.5 V6 (JKOF - JKOP) V4Y 711 241CV (APOS 11-2002)		<b>A1945</b> NO. 180691 - 1348993080 APOIO CAIXA VELOCIDADES RENAULT ESPACE IV (JK0/1_) 3.5 V6 (JK00, JK0F, JK0P, JK0S, JK0W) (A Partir de 11.02) 241cv 3498cc Veículo multiuso - RENAULT ESPACE IV (JK0/1_) 1.9 dCi (JK0U) (04.03 A 02.05) 116cv 1870cc Veículo multiuso - RENAULT ESPACE IV (JK0/1_) 1.9 dCi (JK0U, JK0G) (A Partir de 11.02) 120cv 1870cc Veículo multiuso - RENAULT ESPACE IV (JK0/1_) 2.2 dCi (JK07) (A Partir de 02.06) 139cv 2188cc Veículo multiuso - RENAULT ESPACE IV (JK0/1_) 2.2 dCi (J...etc.
180x130x120mm	1p-d10-32mm 3f-d10,5mm	150x105x50mm	4f-d16mm 3f-d14mm 3r-d12mm
	<b>A1955</b> NO. 8200047018 APOIO DO ESCAPE RENAULT ESPACE IV (JK0/1_) 2.0 (JK09) (A Partir de 11.02) 136cv 1998cc Veículo multiuso - RENAULT ESPACE IV (JK0/1_) 2.0 (JK0A, JK1D, JK0N) (A Partir de 04.05) 170cv 1998cc Veículo multiuso		<b>E0218-M</b> NO. 8200250743 ESTICADOR DO MOTOR PARTE LATERAL RENAULT ESPACE IV
130x75x75mm	1p-d5x30mm	230x75x55mm	1f-12x18mm 1r-d12mm





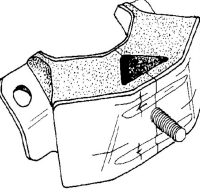
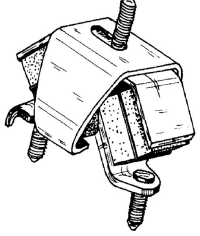
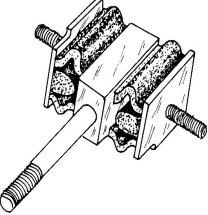
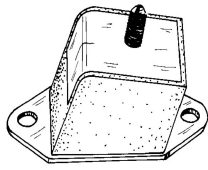
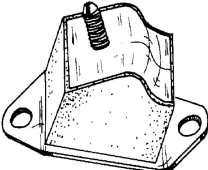







	<p><b>Q2009</b> NO.</p> <p>UNIÃO DE ESCAPE 48/45x80mm</p> <p>RENAULT - ESPACE IV (JK0/1_) - 2.0 (JK09) (APÓS 11.02) 136cv 1998cc Veículo multiuso</p> <p>80x77x55mm 1f-d45/48mm</p>		<p><b>S1502</b> NO. 8200125534 - 8200302003</p> <p>SILENT BLOC DE REPARAÇÃO SUSPENSÃO DO MOTOR</p> <p>RENAULT ESPACE IV 1.9 DCi (JKOU - JKOG) F9Q 680 - F9Q 820 - F9Q 826 120CV (APÓS 11-2002)</p> <p>d60x48mm d51mm 1f-d12mm</p>
	<p><b>S1575</b> NO. 8200002868</p> <p>SILENTBLOC DO BRAÇO DA SUSPENSÃO DA FRENTE</p> <p>RENAULT ESPACE IV (JK0/1_) 2.0 (JK09) (APÓS 11.02) 136cv 1998cc Veículo multiuso - RENAULT ESPACE IV (JK0/1_) 2.0 Turbo (JK0A - JK0B - JK0N) (APÓS 11.02) 163cv 1998cc Veículo multiuso - RENAULT ESPACE IV (JK0/1_) 3.5 V6 (JK00 - JK0F - JK0P - JK0S - JK0W) (APÓS 11.02) 241cv 3498cc Veículo multiuso - RENAULT ESPACE IV (JK0/1_) 1.9 dCi (JK0U - JK0G) (APÓS 11.02) 120cv 1870cc Veículo multiuso - RENAULT ESPACE IV (JK0/1_) 2.2 dCi (JK0H) (...etc.</p> <p>d55x50mm c31mm 1f-d18mm</p>		<p><b>W5088</b> NO. 8200523061</p> <p>POLIE DA CAMBOTA (6 PISTAS)</p> <p>RENAULT ESPACE IV 1.9 DCi (APÓS 11-2002)</p> <p>d151mm d24.5mm</p>
	<p><b>W5089</b> NO. 8200276840 - 8200297935 - 8200451073 - 8200523068 - 8200817574 - 8200297835 - 8200619927 - 820038647...</p> <p>POLIE DA CAMBOTA (7 PISTAS)</p> <p>RENAULT MOTOR 2.0 16V (F4R) ESPACE IV</p> <p>d151mm d24.5mm</p>		<p><b>W5121</b> NO. 8200767762 - 8200361247 - 12303-00Q0A - 4449456 - 4431160 - 93198633 - 04431160 - 12303-00Q1D - 9316...</p> <p>POLIE DA CAMBOTA (7 PISTAS)</p> <p>RENAULT - ESPACE IV (JK0/1_) - 2.0 dCi (JK01 - JK02 - JK1J - JK1K) Código do motor: M9R 740 - M9R 750 - M9R 815 (APÓS 01.06) 150cv 1995cc Veículo multiuso - RENAULT - ESPACE IV (JK0/1_) - 2.0 dCi (JK03 - JK04) Código do motor: M9R 760 - M9R 761 - M9R 762 - M9R 76</p> <p>d155/157mm 31x38mm</p>
	<p><b>Z80838</b> NO. 6991.Y8 - 7703077468 - 7703077469 - 8201112162</p> <p>Mola</p> <p>RENAULT ESPACE (4)</p> <p>d17x18.5mm 1p-d7.5-10.5mm</p>		<p><b>Z80840</b> NO. 7703072352</p> <p>Rebite</p> <p>RENAULT ESPACE (4)</p> <p>d17x18mm 1p-d6.2-10mm</p>

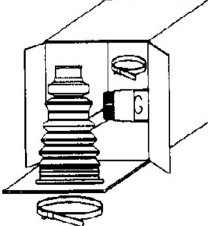
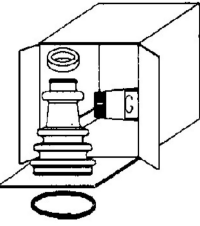
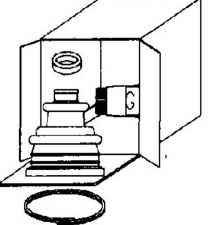









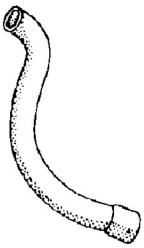
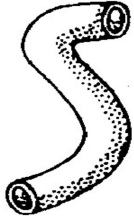

RENAULT EXPRESS-RAPID

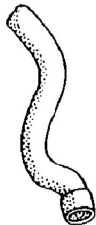

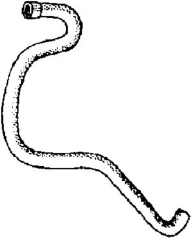

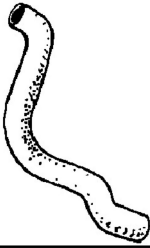
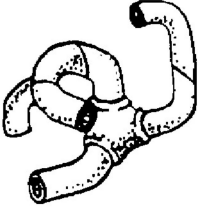





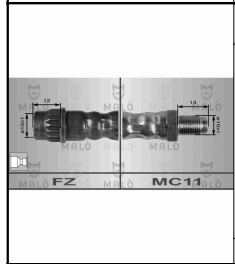
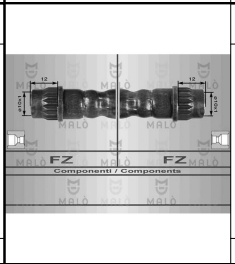

	<p><b>A0013</b> NO. 7700760488 - 7700760510 - 7700765935 - 7704001317</p> <p>SUPORTE TRÁS DO MOTOR</p> <p>RENAULT EXPRESS</p> <p>145x100x64mm 1p-d10-30mm</p>		<p><b>A0291</b> NO. 7700770480</p> <p>SUPORTE FRENTE DIREITO DO MOTOR</p> <p>RENAULT EXPRESS DIESEL</p> <p>90x55x52mm NULL</p>
	<p><b>A0331</b> NO. 7700770307</p> <p>SUPORTE FRENTE ESQUERDO DO MOTOR</p> <p>RENAULT EXPRESS DIESEL</p> <p>60x53x40mm 2p-d8-22mm 1p-d10-70mm</p>		<p><b>A0985</b> NO. 7700762721 - 7700763206 - 7704001319</p> <p>SUPORTE FRENTE DIREITO DO MOTOR (LADO DA DISTRIBUIÇÃO)</p> <p>RENAULT EXPRESS GASOLINA</p> <p>126x63x58mm 1p-d10-28mm</p>
	<p><b>A0986</b> NO. 7700763207 - 7704001320</p> <p>SUPORTE FRENTE DO MOTOR ESQUERDO</p> <p>RENAULT EXPRESS GASOLINA</p> <p>113x80x51mm 1p-d10-27mm</p>		<p><b>A1035</b> NO. 7700770479</p> <p>SUPORTE DE MOTOR FRENTE ESQUERDO</p> <p>RENAULT EXPRESS DIESEL</p> <p>118x135x60mm 1f-d12mm</p>

	<b>A1077</b> NO. 770075531 SUPORTE FRENTE ESQUERDO DO MOTOR RENAULT EXPRESS GASOLINA 115x95x50mm 1p-d10-29mm		<b>A1161</b> NO. 7700795685 SUPORTE DO MOTOR FRENTE DIREITO RENAULT EXPRESS D 175x130x115mm 1p-d10-25mm
	<b>A1161-H</b> NO. 7700795689 SUPORTE MOTOR DIREITO (HIDRÁULICO) RENAULT EXPRESS D 175x135x120mm 1p-d10-30mm		<b>A1200</b> NO. 7700795689 APOIO ESQUERDO DO MOTOR RENAULT EXPRESS DIESEL 138x104x37mm 1f-d12mm
	<b>A1550</b> NO. 7700805122 - 7700818994 APOIO DO MOTOR FRENTE DIREITO RENAULT EXPRESS 1.9 D (APÓS 92) 170x150x115mm NULL		<b>BB01</b> NO. 7700680098 ABRAÇADEIRA DA BARRA ESTABILIZADORA RENAULT EXPRESS 79x28x20mm NULL
	<b>BB03</b> NO. 7700680097 ABRAÇADEIRA DA BARRA ESTABILIZADORA RENAULT EXPRESS 74x35x22mm NULL		<b>BE25</b> NO. 7701458595 - 7701450595 ABRAÇADEIRA DE ESCAPE CÔNCAVA (58 mm) RENAULT EXPRESS (1987 A 1991) - RAPID (APÓS 1987) 95x60x20mm 2p-d8mm
	<b>D0015</b> NO. 7700687433 - 7701349339 - 7700691031 - 7700705138 JUNTA DE CARDAN DA DIRECÇÃO RENAULT EXPRESS 43x32x32mm 2f-d8mm		<b>E0015</b> NO. 7700686449 - 7700795220 ESTICADOR DE ESCAPE RENAULT EXPRESS 87x31x26.5mm NULL
	<b>E0025</b> NO. 0443832171 - 443832171 SUPORTE DE ESCAPE RENAULT EXPRESS RENAULT 54x33x27mm NULL		<b>E0027</b> NO. 7700779356 ESTICADOR DE ESCAPE RENAULT EXPRESS (APÓS 87) 51x27x27mm NULL
	<b>E0200-M</b> NO. 7700411638 ESTICADOR DA SUSPENSÃO DO MOTOR (CAIXA) RENAULT EXPRESS 165x66x46mm 2f-d10mm		<b>F1065</b> NO. 7701466120 FOLE DO CARDAN JUNTO À RODA RENAULT EXPRESS d108x130mm 1f-d88mm 1f-d25mm
	<b>F1066</b> NO. 7701466120 FOLE DA TRANSMISSÃO JUNTO À RODA RENAULT EXPRESS d91x122mm 1f-d83mm 1f-d34mm		<b>F1089-I</b> NO. FOLE DA TRANSMISSÃO LADO DA RODA RENAULT EXPRESS d93x110mm 1f-d80mm 1f-d22mm

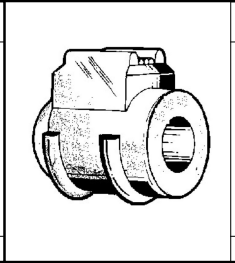
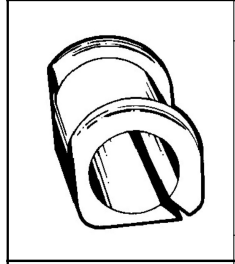
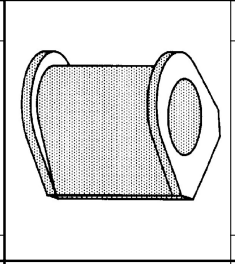



	<p><b>F1325-I</b> NO. 7701201233 - 7701202350</p> <p>FOLE DA TRANSMISSÃO JUNTO À CAIXA</p> <p>RENAULT EXPRESS 1.0 - 1.1 - 1.4 (APÓS 1991)</p> <p>d81x113mm 1f-d63mm 1f-d27mm</p>		<p><b>F1329-I</b> NO. 7701472212 - 7701466349 - 7701470299</p> <p>FOLE DA TRANSMISSÃO JUNTO À CAIXA</p> <p>RENAULT EXPRESS 1.2 (1985 A 1998)</p> <p>d86x102mm 1f-d73mm 1f-d26mm</p>
	<p><b>KB2063</b> NO.</p> <p>KIT DA BARRA ESTABILIZADORA (DIÂMETRO 21)</p> <p>RENAULT EXPRESS</p> <p>NULL NULL</p>		<p><b>KF2528-T</b> NO. 7701469411 - 7701469021</p> <p>KIT DE FOLE DO CARDAN JUNTO À RODA</p> <p>RENAULT EXPRESS 1.2i - 1.9D (APÓS 1998)</p> <p>d90x140mm 1f-d80mm 1f-d25mm</p>
	<p><b>KF2531-T</b> NO. 7701466120</p> <p>FOLE DO LADO DA RODA</p> <p>RENAULT EXPRESS</p> <p>d90x140mm 1f-d33mm 1f-d70mm</p>		<p><b>KF2540</b> NO. 7701348568 - 7701348694</p> <p>FOLE DO LADO DA RODA</p> <p>RENAULT EXPRESS 1.1 1.6 D</p> <p>d94x115mm 1f-d28mm 1f-d74mm</p>
	<p><b>KF2560</b> NO. 7701463643</p> <p>FOLE DO LADO DA RODA</p> <p>RENAULT EXPRESS 1.1 - 1.6 D</p> <p>d87x83mm 1f-d20mm 1f-d75mm</p>		<p><b>KF2599-T</b> NO. 7701465489 - 7701466122</p> <p>FOLE DO LADO DA RODA</p> <p>RENAULT EXPRESS 1.1 - 1.6 D</p> <p>d97x143mm 1f-d33mm 1f-d82mm</p>
	<p><b>L3010</b> NO. 7704000926</p> <p>CASQUILHO DA EXTREMIDADE DA CREMALHEIRA DA DIRECÇÃO</p> <p>RENAULT EXPRESS</p> <p>33x31x18mm 1f-d20mm</p>		<p><b>M6000</b> NO. 7700797807</p> <p>JUNTA DE ESCAPE</p> <p>RENAULT EXPRESS</p> <p>d67x11.5mm 1f-d52mm</p>
	<p><b>M6052</b> NO. 7700781679 - 7700782520 - 8932001367 - 8933000112</p> <p>JUNTA DE ESCAPE</p> <p>RENAULT EXPRESS (1987 A 1996)</p> <p>d67x13.8mm 1f-d49.6mm</p>		<p><b>M6052</b> NO. 7700781679 - 7700782520 - 8932001367 - 8933000112</p> <p>JUNTA DE ESCAPE</p> <p>RENAULT RAPID (1986 A 1991) - EXPRESS (1987 A 1996)</p> <p>d67x13.8mm 1f-d49.6mm</p>
	<p><b>M6053</b> NO. 7700774367</p> <p>JUNTA DE ESCAPE</p> <p>RENAULT RAPID (APÓS 1988)</p> <p>105x75mm 1f-d55mm</p>		<p><b>M6503</b> NO. 7700852033</p> <p>JUNTA DO CARBORADOR</p> <p>RENAULT EXPRESS - ENERGY</p> <p>128x128x20mm NULL</p>
	<p><b>P1015</b> NO. 7700680836</p> <p>CAPA DE PEDAL DO TRAVÃO E EMBRAIAGEM</p> <p>RENAULT EXPRESS</p> <p>60x50x12mm NULL</p>		<p><b>R220577</b> NO. 7700857014</p> <p>TUBO DE LIGAÇÃO DO AR DE SOBREALIMENTAÇÃO</p> <p>RENAULT RAPID Caixa (F40_ - G40_) 1.9 D (F40R) (09.94 A 03.98) 54cv 1870cc Caixa</p> <p>B340-d65/70mm 200-190-120mm</p>

	<b>R220596</b> NO. 7700773178 - 7704002497 TUBO DE AQUECIMENTO RENAULT EXPRESS DIESEL		<b>R220658</b> NO. 7700762033 TUBO DO AQUECIMENTO RENAULT EXPRESS
B275-d19/17mm	40-85-65-80-45mm	B350-d18/18mm	80-80-240-195-335-60-75mm
	<b>R220659</b> NO. 7700726562 TUBO DE LIGAÇÃO DO CARBURADOR DE CORPO DUPLO À BOMBA RENAULT EXPRESS		<b>R220660</b> NO. 7700751785 TUBO DE RADIADOR SUPERIOR RENAULT EXPRESS DIESEL
B340-d12/12mm	65-60-65-150-90-40mm	B315-d32/32mm	55-170-145mm
	<b>R220661</b> NO. 7700751786 TUBO DE RADIADOR INFERIOR RENAULT EXPRESS DIESEL		<b>R220662</b> NO. 7700762342 TUBO DE RADIADOR SUPERIOR C/ RESPIRO RENAULT EXPRESS GASOLINA
B170-d30/30mm	60-125-115mm	B330-d40/40mm	95-100-80-115mm
	<b>R220663</b> NO. 7700752184 - 7700781076 TUBO DE RADIADOR INFERIOR RENAULT EXPRESS GASOLINA		<b>R220668</b> NO. 7700762034 TUBO DE LIGAÇÃO DO AQUECIMENTO À BOMBA DE ÁGUA RENAULT EXPRESS GASOLINA
B360-d29/29mm	65-80-95-65-80-55mm	B620-d17/17mm	55-80-215-180-190-155-55-40mm
	<b>R220669</b> NO. 7700707107 TUBO DE ÁGUA DA BOMBA AO CARBURADOR RENAULT EXPRESS GASOLINA		<b>R220671</b> NO. 7700781397 TUBO DE LIGAÇÃO AO DEPÓSITO RENAULT EXPRESS
B390-d11/11mm	65-55-45-80-50-70-50-.95-40mm	B365-d20/22mm	80-335-140-110-90mm
	<b>R220672</b> NO. 7702147740 TUBO DE LIGAÇÃO DO DEPÓSITO AO AQUECIMENTO RENAULT EXPRESS		<b>R221620</b> NO. 7700801073 - 7700824034 TUBO DE RADIADOR SUPERIOR C/ SANGRADOR RENAULT EXPRESS 1.9 DIESEL
B565-d18/24mm	65-65-145-125-135-135-80mm	B470-d31/31mm	80-250-150-30-50mm
	<b>R221621</b> NO. 7700801067 TUBO DE RADIADOR INFERIOR 4 VIAS RENAULT EXPRESS 1.9 DIESEL		<b>R8049</b> NO. 6006000781 TUBO DE LIGAÇÃO DA BOMBA DE ÁGUA RENAULT EXPRESS 1.6 D
NULL	NULL	B320-d20/17mm d16mm	50-100-65-165mm 65-140-115-55mm
	<b>R8139</b> NO. 7700773179 TUBO PERMUTADOR AQUECIMENTO RENAULT RAPID Caixa (F40_, G40_) 1.6 D (F404) (03.86 A 08.98) 55cv 1596cc Caixa - RENAULT SUPER 5 (B/C40_) 1.6 D (B/C/404) (08.85 A 12.96) 55cv 1596cc Hatchback		<b>RF5001</b> NO. 7700859465 - 7700859759 TUBO DE FERRO RADIADOR RENAULT EXPRESS 1.4 (COM JUNTA TÓRICA)
B280-18/18mm	80-90-140mm	B400-d27/28mm	290-110mm+ch70-d13mm

	<p><b>RF5004</b> NO. 7700864993</p> <p>TUBO DE FERRO RADIADOR</p> <p>RENAULT EXPRESS</p> <p>B420-d17/17mm 70-55-70-80-65-50-150-50mm+B240-d13</p>		<p><b>RF5005</b> NO. 7700860386</p> <p>TUBO DE FERRO RADIADOR</p> <p>RENAULT EXPRESS</p> <p>B455-d17/17mm 70-200-65-200-50mm+ch105-d14mm+ch30-d14mm</p>
	<p><b>RF5014</b> NO.</p> <p>TUBO DE FERRO RADIADOR</p> <p>RENAULT EXPRESS 1.9 DIESEL</p> <p>B420-d18/18mm165-70-75-80-70-70mm</p>		<p><b>RF5015</b> NO. 7700875497</p> <p>TUBO DE FERRO RADIADOR</p> <p>RENAULT EXPRESS 1.9 DIESEL</p> <p>B405-d17/17mm 55-65-75-90-70-60-160mm+ch60-d13mm</p>
	<p><b>RT08443</b> NO. 7700308909 - 7704003913 - 8427528 - 8200958352 - 7701069538 - 8200778628 - 7704003763 - 82427528</p> <p>TUBO DE TRAVÃO FRENTE LH-RH</p> <p>RENAULT - RAPID Caixa (F40_ - G40_) 1.0 (02.86 - 05.92) 37cv 949cc - RENAULT - RAPID Caixa (F40_ - G40_) 1.1 (F40H) (06.87 - 09.91) 45cv 1108cc - RENAULT - RAPID Caixa (F40_ - G40_) 1.1 (F401) (07.85 - 04.95) 45cv 1108cc - RENAULT - RAPID Caixa (F40_ - G40_)</p> <p>330mm FZ - MC11</p>		<p><b>RT08501</b> NO. 7701349305 - 7704001950 - 7704003549 - 7700541132 - 7704003931</p> <p>TUBO DE TRAVÃO TRÁS LH-RH</p> <p>RENAULT EXPRESS TT (APÓS 1986)</p> <p>270mm FZ - FZ</p>
	<p><b>S1060</b> NO. 7700762574 - 7704000681</p> <p>SILENT-BLOC DO BRAÇO INFERIOR DA SUSPENSÃO FRENTE</p> <p>RENAULT EXPRESS</p> <p>d32x46mm c36mm 1f-d12mm</p>		<p><b>T0016</b> NO. 7700760265</p> <p>BATENTE LATERAL DA BARRA ESTABILIZADORA DA SUSPENSÃO FRENTE FURO 20mm</p> <p>RENAULT EXPRESS</p> <p>58x45x42mm 1f-d18mm</p>
	<p><b>T0018</b> NO. 7700763934</p> <p>BATENTE CENTRAL DA BARRA ESTABILIZADORA</p> <p>RENAULT EXPRESS</p> <p>40x35x35mm 1f-d20mm</p>		<p><b>T0020</b> NO. 7700763934 - 77021444561</p> <p>BATENTE CENTRAL DA BARRA ESTABILIZADORA DA SUSPENSÃO FRENTE</p> <p>RENAULT EXPRESS (CENTRO - GRANDE)</p> <p>44x37x33mm 1f-d22mm</p>
	<p><b>U0303</b> NO. 60011009755 - 7700757324</p> <p>ANILHA DA SUSPENSÃO</p> <p>RENAULT EXPRESS</p> <p>d97x35mm 1f-d53mm</p>		<p><b>U1001</b> NO. 7700788381</p> <p>LIMITADOR DE APOIO</p> <p>RENAULT EXPRESS</p> <p>170x86x86mm NULL</p>
	<p><b>W5000</b> NO. 8200386445 - 7700112999 - 7700724249 - 7700107145 - 7700864763 - 8200545437 - 8200689705 - 770073990...</p> <p>POLIE DA CAMBOTA (6 pistas)</p> <p>RENAULT EXPRESS (1.9 D mot. F8Q)</p> <p>d132mm d12.6mm</p>		<p><b>W5071</b> NO. 7700856673</p> <p>POLIE DA CAMBOTA (6 PISTAS)</p> <p>RENAULT EXPRESS</p> <p>d132mm d12.6mm</p>
	<p><b>Z80473</b> NO. 7703077193</p> <p>Mola de painel</p> <p>RENAULT EXPRESS</p> <p>d21x24mm 1p-d7-14mm</p>		<p><b>Z80576</b> NO.</p> <p>Mola de friso</p> <p>Renault Express</p> <p>38x22x6.6mm NULL</p>

	<b>Z80608</b>	NO. 7703077225 - 7518N8		
	<i>Mola de painel</i> RENAULT EXPRESS			
	d35x25mm	1p-d10.7-22.5mm		

## RENAULT FLUENCE

	<b>A1934</b>	NO. 8200105505		<b>W5108</b>	NO. 8200392697
	<i>APOIO DO BATENTE DE ENCOSTO DO ESCAPE</i> RENAULT FLUENCE (L30_) 1.5 dCi (L30S) (a Partir de 02.10) 90cv 1461cc três volumes - RENAULT FLUENCE (L30_) 1.5 dCi (L30B) (A partir de 02.10) 106cv 1461cc três volumes - RENAULT FLUENCE (L30_) 1.5 dCi (L30D_ L30L) (A Partir de 02.10) 110cv 1461cc três volumes				<i>POLIE DA CAMBOTA (5 PISTAS)</i> RENAULT FLUENCE 1.5 dCi (L30A)(K9K 830) 86CV (APÓS 02-2010) - 1.5 dCi (L30B)(K9K 832) 106CV (APÓS 06-2005) - 1.5 dCi (L30D - L30L)(K9K 836) 110CV (APÓS 02-2010) - 1.5 dCi (L30S)(K9K 834) 90CV (APÓS 02-2010) - 1.6 16V (L301 - L30F - L30P - L30R)(K4M 838)
	60x60x55mm	2f-17x7mm		NULL	d153.4mm 1f-d26mm
	<b>W5137</b>	NO. 8200687605 - 8200699517 - 8200352613 - 8200395313 - 8200544135 - 8200552236 - 8200687605 - 820069951...			
	<i>POLIE DA CAMBOTA 6 PISTAS</i> RENAULT FLUENCE (L30_) 1.6 16V (L301 - L30F - L30P - L30R) Código do motor: K4M.8.39 - Variante de equipamento: >11/10 - Código do motor: K4M.8.38 (APÓS 02.10) 110cv 1598cc três volumes - RENAULT FLUENCE (L30_) 1.5 dCi (L30A) Código do motor: K9K.8.30 - Variante de equipamento: >11/10 - Código do motor: K9K.8.42 - Código do motor: K9K.8.38 (APÓS 02.10) 86cv 1461cc três volumes - RENAULT FLUENCE (L30_) 1.5 dCi (L30S) Código do motor: K9...etc.				
	d155mm	d26mm			

## RENAULT FUEGO



	<b>F0830-1I</b>	NO. 7701349696 - 7701349841 - 7701464758 - 7701466172		<b>F1325-I</b>	NO. 7701201233 - 7701202350
	<i>FOLE DA TRANSMISSÃO JUNTO À CAIXA</i> RENAULT FUEGO 1.6 i T TURBO - 2.0 - 2.1 TD (1980 A 1985)				<i>FOLE DA TRANSMISSÃO JUNTO À CAIXA</i> RENAULT FUEGO 1.6 (1980 A 1985)
	d90x113mm	1f-d24mm 1f-d73mm		d81x113mm	1f-d63mm 1f-d27mm
	<b>Z80500</b>	NO. 7703077066			
	<i>Mola de painel</i> RENAULT FUEGO				
	d12.4x20mm	1p-d6.5-18mm			

	<b>E0218-M</b>	NO. 8200250743		
	ESTICADOR DO MOTOR PARTE LATERAL RENAULT GRAND ESPACE 1.9 DCi - 2.2 Dci			
	230x75x55mm	1f-12x18mm 1r-d12mm		

RENAULT GRAND SCENIC

	<b>RT80213</b>	NO. 8200234737 - 8200333851		<b>S1487</b>	NO. 8200242025
	TUBO DE TRAVÃO FRENTE RH RENAULT GRAND SCÉNIC II 1.5 DCi (APÓS 04-2004) - 1.6 (APÓS 04-2004) - 1.9 DCi (APÓS 04-2004) - 2.0 (APÓS 04-2004) - MEGANE II 1.4 16V (APÓS 11-2002) - 1.5 DCi (APÓS 11-2002) - 1.6 16V (APÓS 11-2002) - 1.9 DCi (APÓS 11-2002) - 2.0 16V (APÓS 11-2002) - 2.0				SILENT BLOC DO BRAÇO DA SUSPENSÃO DA FRENTE RENAULT GRAND SCÉNIC II 1.5 DCi (APÓS 04-2004) - 1.6 (APÓS 04-2004) - 1.9 DCi (APÓS 04-2004) - 2.0 (APÓS 04-2004)
	457mm	FZ - MC11		d43x48mm	d33mm 1f-d12mm
	<b>S1488</b>	NO. 8200041166		<b>W5108</b>	NO. 8200392697
	SILENT BLOC DO BRAÇO DA SUSPENSÃO DA FRENTE RENAULT GRAND SCÉNIC II 1.5 DCi (APÓS 04-2004) - 1.6 (APÓS 04-2004) - 1.9 DCi (APÓS 04-2004) - 2.0 (APÓS 04-2004)				POLIE DA CAMBOTA (5 PISTAS) RENAULT GRAND SCÉNIC II 1.5 dCi (JM02 - JM13)(K9K 728) 101CV (APÓS 04-2004) - 1.6(K4M 761) 113CV (APÓS 04-2004)
	d58x53mm	c30mm 1f-d12mm		NULL	d153.4mm 1f-d26mm
	<b>W5137</b>	NO. 8200687605 - 8200699517 - 8200352613 - 8200395313 - 8200544135 - 8200552236 - 8200687605 - 820069951...		<b>W5137</b>	NO. 8200687605 - 8200699517 - 8200352613 - 8200395313 - 8200544135 - 8200552236 - 8200687605 - 820069951...
	POLIE DA CAMBOTA 6 PISTAS RENAULT GRAND SCÉNIC II (JM0/1_) 1.6 Código do motor: K4M.8.12 (APÓS 04.04) 113cv 1598cc Veículo multiuso				POLIE DA CAMBOTA 6 PISTAS RENAULT GRAND SCÉNIC III (JZ0/1_) 1.6 16V (JZ0U) Código do motor: K4M.8.66 - Código do motor: K4M.8.58 (APÓS 02.09) 109cv 1598cc Veículo multiuso 5/5 - RENAULT GRAND SCÉNIC III (JZ0/1_) 1.5 dCi Ano fabric. até: 01.11 - Código do motor: K9K.8.30 - Variante de equipamento: >01/11 (APÓS 04.09) 86cv 1461cc Veículo multiuso - RENAULT GRAND SCÉNIC III (JZ0/1_) 1.5 dCi Ano fabric. até: 01.11 - Código do motor: K9K.8.32 - Variante de equip...etc.
	d155mm	d26mm		d155mm	d26mm

RENAULT KANGOO

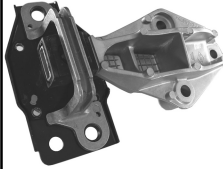
	<b>A1471</b>	NO. 7700434370		<b>A1519</b>	NO. 7700415087
	SUPORTE MOTOR DIREITO RENAULT KANGOO 1.4 - 1.6 - 1.9D - Dti				APOIO DO MOTOR FRENTE LADO DIREITO RENAULT KANGOO 1.2 (APÓS 1997)
	170x110x110mm	1p-d10-30mm		170x100x80mm	1f-d12mm
	<b>A1599</b>	NO. 8200267625 - 8200253037 - 7700436286		<b>A1813</b>	NO. 8200902956 - 8200325283
	APOIO DO MOTOR LADO DIREITO RENAULT KANGOO 1.5 Dci (APÓS 12-2001) - KANGOO 1.9 DCi 4X4 (APÓS 10-2001)				APOIO DO MOTOR LADO DIREITO SUPERIOR RENAULT - KANGOO / GRAND KANGOO (KW0/1_) - 1.5 dCi (KW0C - KW0F) (APÓS 02.08) 103cv 1461cc Veículo multiuso - RENAULT - KANGOO / GRAND KANGOO (KW0/1_) - 1.5 dCi (APÓS 02.08) 106cv 1461cc Veículo multiuso - RENAULT - KANGOO Express (FW0/1_) - 1.5 dCi (FW0F)
	175x135x90mm	1p-d10-32mm		280x190X120mm	NULL



	<p><b>A1872</b> NO. 8200058705 - 8200149811 - 8200144401</p> <p><b>APOIO DA TRANSMISSÃO</b></p> <p>RENAULT KANGOO (KC0/1) 1.6 16V 4x4 (KC0P - KC0S - KC0L) (APÓS 10-2001) 95CV 1598CC - RENAULT KANGOO (KC0/1) 1.9 dCi 4x4 (KC0V) (APÓS 10-2001) 80CV 1870CC - RENAULT KANGOO (KC0/1) 1.9 dCi 4x4 (APÓS 10-2003) 84CV 1870CC - RENAULT KANGOO Express (FC0/1_) 1.6 1</p> <p>155x105x51mm 1f-d30mm</p>		<p><b>D0025</b> NO. 7701209352</p> <p><b>CARDAN EQUILIBRADOR DO VEIO DE TRANSMISSÃO</b></p> <p>RENAULT KANGOO (KC0/1_) 1.6 16V 4x4 (KC0P - KC0S - KC0L) (APÓS 10.01) 95cv 1598cc Veículo multiuso - RENAULT KANGOO (KC0/1_) 1.9 dCi 4x4 (KC0V) (APÓS 10.01) 80cv 1870cc Veículo multiuso - RENAULT KANGOO (KC0/1_) 1.9 dCi 4x4 (APÓS 10.03) 84cv 1870cc Veículo multiuso</p> <p>d170x50mm d127mm 3f-d5mm 3f-d12mm 1f-d57mm</p>
	<p><b>D0025</b> NO. 7701209352</p> <p><b>CARDAN EQUILIBRADOR DO VEIO DE TRANSMISSÃO</b></p> <p>RENAULT KANGOO Express (FC0/1_) 1.6 16V 4x4 (FC0L - FC0P - FC0S) (APÓS 10.01) 95cv 1598cc Caixa - RENAULT KANGOO Express (FC0/1_) 1.9 dCi 4x4 (FC0V) (APÓS 10.01) 80cv 1870cc Caixa - RENAULT KANGOO Express (FC0/1_) 1.9 dCi 4x4 (FC0V) (APÓS 07.03) 84cv 1870cc Caixa</p> <p>d170x50mm d127mm 3f-d5mm 3f-d12mm 1f-d57mm</p>		<p><b>E0202-M</b> NO. 7700849715</p> <p><b>ESTICADOR DO MOTOR TRÁS</b></p> <p>RENAULT KANGOO (APÓS 1998)</p> <p>168x81x45mm 1f-d10mm 1f-d10mm</p>
	<p><b>E0205-M</b> NO. 7700428936</p> <p><b>ESTICADOR DO MOTOR PARTE TRÁS</b></p> <p>RENAULT KANGOO 1.9D (APÓS 1997)</p> <p>160x60x46mm 2f-d10mm</p>		<p><b>E0250-M</b> NO. 8200155207 - 8200175102</p> <p><b>ESTICADOR DO MOTOR PARTE DE TRÁS</b></p> <p>RENAULT KANGOO 1.2 (KC0A - KC0K - KC0F - KC01) (D7F 710 - D7F 720 - D7F 722 - D7F 726 - D7F 744 - D7F 746) 58CV (APÓS 08-1997) - 1.2 16V (KC03 - KC05 - KC06 - KC0T - KC0W) (D4F 712 - D4F 714 - D4F 716) 75CV (APÓS 06-2001) - 1.5 Dci (K9K 704) 57CV (APÓS 07-2003) - 1.5 D</p> <p>240x80x46mm 1f-d12mm 1f-d14mm</p>
	<p><b>E0250-M</b> NO. 8200155207 - 8200175102</p> <p><b>ESTICADOR DO MOTOR PARTE DE TRÁS</b></p> <p>RENAULT KANGOO Express 1.2 (FC01 - FC0A - FC0F) (D7K 710 - D7F 720 - D7F 722 - D7F 726 - D7F 744 - D7F 746) 58CV (APÓS 08-1997) - 1.2 16V (FC05) (D4F 712 - D4F 714) 75CV (APÓS 10-2001) - 1.5 Dci (K9K 704) 61CV (APÓS 10-2005) - 1.5 Dci (FC07 - FC1R) (K9K 700) 65CV</p> <p>240x80x46mm 1f-d12mm 1f-d14mm</p>		<p><b>E1093</b> NO. 7700434978</p> <p><b>ESTICADOR DE ESCAPE</b></p> <p>RENAULT KANGOO (APÓS 10-2001)</p> <p>d65x45mm 1f-d12.6mm</p>
	<p><b>E1112</b> NO. 8200505926 - 8200530560</p> <p><b>APOIO DO ESCAPE</b></p> <p>RENAULT KANGOO / GRAND KANGOO (KW0/1_) 1.5 dCi (KW0B) (APÓS 02.08) 86cv 1461cc Veículo multiuso</p> <p>60x40x40mm 2f-d12mm</p>		<p><b>F1329-I</b> NO. 7701472212 - 7701466349 - 7701470299</p> <p><b>FOLE DA TRANSMISSÃO JUNTO À CAIXA</b></p> <p>RENAULT KANGOO 1.2i - 1.4i 1.9 D (APÓS 1998)</p> <p>d86x102mm 1f-d73mm 1f-d26mm</p>
	<p><b>KF2528-T</b> NO. 7701469411 - 7701469021</p> <p><b>KIT DE FOLE DO CARDAN JUNTO À RODA</b></p> <p>RENAULT KANGOO 1.2i (APÓS 1998)</p> <p>d90x140mm 1f-d80mm 1f-d25mm</p>		<p><b>KT0501</b> NO. 8200591288 - 8200839707</p> <p><b>KIT DE BATENTE SUSPENSÃO FRENTE</b></p> <p>RENAULT KANGOO / GRAND KANGOO (KW0/1_) 1.6 (KW00 - KW0Y) (APÓS 02.08) 87cv 1598cc Veículo multiuso - RENAULT KANGOO/GRAND KANGOO (KW0/1_) 1.6 16V (KW0D) (APÓS 02.08) 106cv 1598cc Veículo multiuso RENAULT KANGOO/GRAND KANGOO (KW0/1_) 1.6 16V Hi-Flex (APÓS 02.08) 106cv 1598cc Veículo multiuso - RENAULT KANGOO / GRAND KANGOO (KW0/1_) 1.5 dCi (KW0A) (APÓS 02.08) 68cv 1461cc Veículo multiuso - RENAULT KANGOO/GRAND KANGOO (KW0/1_) 1.5 dCi (KW0B) (APÓS 02.08) 86cv 1461cc Veículo multiuso - etc.</p> <p>1f-d20mm 1f-d53mm</p>
	<p><b>P1050</b> NO. 7700416724</p> <p><b>CAPA DE PEDAL DO TRAVÃO E EMBRAIAGEM</b></p> <p>RENAULT KANGOO 1.2 - 1.4 - 1.9D - 1.9 TD</p> <p>75x48x10mm NULL</p>		<p><b>P1069</b> NO. 7700416723</p> <p><b>CAPA DE PEDAL DO TRAVÃO</b></p> <p>RENAULT KANGOO (KC0-1) 1.2 (KC0A-KC0K-KC0F-KC01) (APÓS 08-1997) 58CV 1149CC - RENAULT KANGOO (KC0-1) 1.4 (KC0C-KC0H-KC0B-KC0M) (APÓS 08-1997) 75CV 1390CC - RENAULT KANGOO (KC0-1) D 55 1.9 (KC0D) (APÓS 08-1997) 54CV 1870CC - RENAULT KANGOO (KC0-1) D65 1.9</p> <p>75x73x10mm NULL</p>
	<p><b>Q2009</b> NO.</p> <p><b>UNIÃO DE ESCAPE 48/45x80mm</b></p> <p>RENAULT - KANGOO (KC0/1_) - 1.2 16V (KC05 - KC06 - KC03 - KC0T - KC0W - KC1D) (APÓS 06.01) 75cv 1149cc Veículo multiuso - RENAULT - KANGOO (KC0/1_) - 1.4 (KC0C - KC0H - KC0B - KC0M) (APÓS 08.97) 75cv 1390cc Veículo multiuso - RENAULT - KANGOO (KC0/1_) - 1.6 16V</p> <p>80x77x55mm 1f-d45/48mm</p>		<p><b>R223181</b> NO. 7700834895 - 8200126264 - 7700414122</p> <p><b>TUBO INFERIOR DO RADIADOR</b></p> <p>RENAULT KANGOO (KC0-1_) - D 55 1.9 (KC0D) Veículo multiuso 54CV (1870cc)(APÓS 08-1997) - D 65 1.9 (KC0E - KC02 - KC0J - KC0N) Veículo multiuso 64CV (1870cc)(APÓS 08-1997) - KANGOO Rapid (FC0-1_) - D 55 1.9 (FC0D) CAIXA 54CV (1870cc)(APÓS 08-1997) - D 65</p> <p>B590-27/30mm 100-130-220-160-100mm+ch 600-d16mm+ch300-d15</p>

	<p><b>RT08942</b> NO. 7700313596 - 7700314792 - 46201-00QOE</p> <p>TUBO DE TRAVÃO FRENTE RH - TRÁS LH</p> <p>RENAULT KANGOO TT (APÓS 03-1998)</p>		<p><b>RT08943</b> NO. 7700312022 - 7700310117 - 7700314792 - 7700304968 - 7700313596 - 8200679271 - 8671017429 - 46201-00Q...</p> <p>TUBO DE TRAVÃO FRENTE LH</p> <p>RENAULT KANGOO TT (APÓS 03-1998)</p>
	<p>357mm FZ - MC11</p>		<p>360mm FZ - MC11</p>
	<p><b>RT08944</b> NO. 7700304969 - 46211-00QAA</p> <p>TUBO DE TRAVÃO TRÁS RH</p> <p>RENAULT KANGOO TT APÓS 03-1998</p>		<p><b>S1156</b> NO. 95FB5C485AA - 7320351 - 6944655</p> <p>SILENT-BLOC DA SUSPENSÃO DE TRÁS</p> <p>RENAULT KANGOO 1.2(16V) - 1.4 - 1.5DCi - 1.6(16V) - 1.9D - 1.9 DTi - 1.9DCi 4X4</p>
	<p>215mm FZ - FZ</p>		<p>d72x74mm d40mm 1f-d32mm</p>
	<p><b>S1300</b> NO. 7700424399</p> <p>SILENT-BLOC DO BRAÇO SUSPENSÃO DA FRENTE</p> <p>RENAULT KANGOO (APÓS 1998)</p>		<p><b>S1520</b> NO. 7700436707</p> <p>SILENT BLOC DO EIXO TRASEIRO</p> <p>RENAULT KANGOO (KC0-1 _ ) 1.6 16V 4X4 (KC0P - KC0S - KC0L)(K4M 750 - K4M 752 - K4M 753) 95CV (APÓS 10-2001) - 1.9 dCi 4X4 (F9Q 790) 84CV (APÓS 10-2003) - 1.9 dCi 4X4 (KC0V)(F9Q 782 - F9Q 790) 80CV (APÓS 10-2001)</p>
	<p>d59x46mm d45mm 1f-14x15mm</p>		<p>d49x60mm c43mm d40mm 1f-d12.5</p>
	<p><b>S1593</b> NO. 7700301255 - 7700301720</p> <p>SILENT-BLOC SUSPENSÃO EIXO TRASEIRO</p> <p>RENAULT KANGOO (KC0/1 _ ) 1.2 (KC0A, KC0K, KC0F, KC0I) (A Partir de 08.97) 58cv 1149cc Veiculo multiuso - RENAULT KANGOO (KC0/1 _ ) 1.2 16V (KC0S, KC06, KC03, KC0T, KC0W, KC1D) (A Partir de 06.01) 75cv 1149cc Veiculo multiuso - RENAULT KANGOO (KC0/1 _ ) 1.4 (KC0C, KC0H, KC0B, KC0M) (A Partir de 08.97) 75cv 1390cc Veiculo multiuso - RENAULT KANGOO (KC0/1 _ ) 1.6 16V (A Partir de 06.01) 95cv 1598cc Veiculo multiuso - RENAULT KANGOO (KC0/1 _ ) 1....etc.</p>		<p><b>U7010</b> NO. 8200059541</p> <p>TENSORES CORREIA ALTERNADOR</p> <p>RENAULT KANGOO 1.9 Dti</p>
	<p>d72x75mm c28mm d40mm 1f-d34mm</p>		<p>d34x130mm 2f-d8mm</p>
	<p><b>U7010</b> NO. 8200059541</p> <p>TENSORES CORREIA ALTERNADOR</p> <p>RENAULT KANGOO 1.9 Dti</p>		<p><b>W5000</b> NO. 8200386445 - 7700112999 - 7700724249 - 7700107145 - 7700864763 - 8200545437 - 8200689705 - 770073990...</p> <p>POLIE DA CAMBOTA (6 pistas)</p> <p>RENAULT KANGOO</p>
	<p>d34x130mm 2f-d8mm</p>		<p>d132mm d12.6mm</p>
	<p><b>W5017</b> NO. 7700115309 - 7700110329 - 7700113018 - 8200689702 - 4418147 - 93192606 - 4402569 - 9110569</p> <p>POLIE DA CAMBOTA (6 pistas)</p> <p>RENAULT KANGOO</p>		<p><b>W5019</b> NO. 12303-00QJ - 12303-00QAU - 12303-00QBA - 12303AY600 - 12303-BN700 - 8200392697</p> <p>POLIE DA CAMBOTA (5 pistas)</p> <p>RENAULT KANGOO TT (APÓS 2003)</p>
	<p>d132mm d12.6mm</p>		<p>d152.3mm d26mm</p>
	<p><b>W5071</b> NO. 7700856673</p> <p>POLIE DA CAMBOTA (6 PISTAS)</p> <p>RENAULT KANGOO</p>		<p><b>W5077</b> NO. 8200392683</p> <p>POLIE DA CAMBOTA (6 PISTAS)</p> <p>RENAULT KANGOO</p>
	<p>d132mm d12.6mm</p>		<p>d133.6mm d26mm</p>
	<p><b>W5106</b> NO. 8200477938 - 8200511194 - 8200185800 - 8200184103</p> <p>POLIE DA CAMBOTA (6 PISTAS)</p> <p>RENAULT KANGOO-GRAND KANGOO 1.5 Dci (KW0A) (K9K 800) 68CV (APÓS 02-2008)</p>		<p><b>W5108</b> NO. 8200392697</p> <p>POLIE DA CAMBOTA (5 PISTAS)</p> <p>RENAULT KANGOO - GRAND KANGOO 1.5 dCi (KW0A)(K9K 800) 68CV (APÓS 02-2008) - 1.5 dCi (KW0B)(K9K 802) 86CV (APÓS 02-2008) - 1.5 dCi (KW0C - KW0F)(K9K 804) 103CV (APÓS 02-2008) - 1.6 16V Hi-Flex(K4M 850) 106CV (APÓS 02-2008) - 1.6 16V (KW0D)(K4M 830) 10</p>
	<p>d155/151mm d26mm</p>		<p>NULL d153.4mm 1f-d26mm</p>



## RENAULT KANGOO

	<b>W5108</b> NO. 8200392697 POLIE DA CAMBOTA (5 PISTAS) RENAULT KANGOO BE BOP 1.5 dCi(K9K804) 110CV (APÓS 06-2009) - 1.5 dCi (KW0F)(K9K 806) 103CV (APÓS 02-2009) - 1.5 dCi (KW0G)(K9K 808) 90CV (APÓS 06-2009) - 1.5 dCi 75(K9K 802) 75CV (APÓS 09-2010) - 1.6 (KW0D)(K4M 830) 106CV (APÓS 02-2009)		<b>W5108</b> NO. 8200392697 POLIE DA CAMBOTA (5 PISTAS) RENAULT KANGOO Express 1.5 dCi K9K 704 45 61CV (APÓS 10-2005) - 1.5 dCi (FC07 - FC1R) K9K 700 48 65CV (APÓS 12-2001) - 1.5 dCi (FC08 - FC09) K9K 702 - K9K 710 60 82CV (APÓS 04-2003) - 1.5 dCi (FC1E) K9K 714 50 68CV (APÓS 06-2005) - 1.5 dCi (FC1G) K9K 718 62 8
NULL	d153.4mm 1f-d26mm	NULL	d153.4mm 1f-d26mm
	<b>W5111</b> NO. 8200352613 - 8200552236 - 8200699517 - 8200544135 - 8200687605 - 8200395313 - 7700105788 - 820004405... POLIE DA CAMBOTA(6 PISTAS) RENAULT KANGOO - GRAND KANGOO (KW0-1_) 1.5 dCi (KWOC - KWOF) (K9K 804) 103CV (APÓS 02-2008)		<b>W5111</b> NO. 8200352613 - 8200552236 - 8200699517 - 8200544135 - 8200687605 - 8200395313 - 7700105788 - 820004405... POLIE DA CAMBOTA(6 PISTAS) RENAULT KANGOO Express (FW0-1_) 1.5 dCi (FW0F) (K9K 806) 103CV (APÓS 02-2008)
d155-151mm	d26mm	d155-151mm	d26mm
	<b>W5137</b> NO. 8200687605 - 8200699517 - 8200352613 - 8200395313 - 8200544135 - 8200552236 - 8200687605 - 820069951... POLIE DA CAMBOTA 6 PISTAS RENAULT KANGOO/GRAND KANGOO (KW0/1_) 1.6 16V (KW0D) Código do motor: K4M.8.30 - Variante de equipamento: +AC - Código do motor: K4M.8.31 (APÓS 02.08) 106cv 1598cc Veículo multiuso 2/5 - RENAULT KANGOO/GRAND KANGOO (KW0/1_) 1.6 16V Hi-Flex Código do motor: K4M.8.34 - Variante de equipamento: +AC (APÓS 02.08) 106cv 1598cc Veículo multiuso - RENAULT KANGOO/GRAND KANGOO (KW0/1_) 1.5 dCi (KWOC - KWOF) Código do motor: K9K.8.06/F - Variante d...etc.		<b>Z80737</b> NO. 7703077435 Mola de painel RENAULT KANGOO
d155mm	d26mm	d35.5x25.5mm	1p-d12.5-22.5mm
	<b>Z80758</b> NO. 500326896 - 7703077421 Mola de friso RENAULT KANGOO		<b>Z80808</b> NO. 699786 - 7701044547 - 9619769080 Mola de fixação RENAULT KANGOO
d20x16.5mm	1p-8x8-6.5mm	NULL	NULL
	<b>Z80837</b> NO. 7703077434 Mola de painel RENAULT KANGOO		<b>Z80838</b> NO. 6991.Y8 - 7703077468 - 7703077469 - 8201112162 Mola RENAULT KANGOO
d15.3x20.5mm	1p-d8-14mm	d17x18.5mm	1p-d7.5-10.5mm

## RENAULT KOLEOS

	<b>W5121</b> NO. 8200767762 - 8200361247 - 12303-00QA - 4449456 - 4431160 - 93198633 - 04431160 - 12303-00Q1D - 9316... POLIE DA CAMBOTA (7 PISTAS) RENAULT - KOLEOS (HY_) - 2.0 dCi (HY0K) Código do mot or: M9R 855 - M9R 856 - M9R 865 - M9R 866 - M9R 862 (APÓS 09.08) 150cv 1995cc Veículo todoterreno fechado - RENAULT - KOLEOS (HY_) - 2.0 dCi 4x4 (HY0K) Código do mot or: M9R 832 - M9R 855 - M9R 856 - M9R 865 -		
d155/157mm	31x38mm		

	<p><b>E0249-M</b> NO. 7700817782</p> <p>ESTICADOR DO MOTOR PARTE DE TRÁS</p> <p>RENAULT LAGUNA I 1.8 90CV (F3P 720 - F3P 724) (11-1993 A 03-2001) - 1.8 90CV (F3P 670 - F3P 678) (08-1995 A 03-2001) - 1.8 94CV (F3P 720 - F3P 724) (08-1995 A 03-2001) - 1.8 16V 120CV (F4P 760) (04-1998 A 03-2001) - 1.8i 125CV (MOTOR GENERICO) (07-1995 A 04-199)</p> <p>220x75x40mm 1f-d10mm 1f-d12mm</p>		<p><b>KF2529-T</b> NO. 7701469021</p> <p>KIT DE FOLE DO CARDAN JUNTO À RODA</p> <p>RENAULT LAGUNA I 1.6i 16V - 1.8i - 1.8i 16V - 1.9 DTi - 2.0i - 2.0i 16V - 2.2D - 2.2 DT - 3.0i V6 (1993 A 2001)</p> <p>d110x140mm 1f-d88mm 1f-d27mm</p>
	<p><b>KF2532-T</b> NO.</p> <p>KIT DE FOLE DO CARDAN LADO DA RODA</p> <p>RENAULT LAGUNA I 1.8i 16V - AXLE LOBRO GKN - BREAK 07-98 A 11-00 - 1.8i 8V - BREAK - BREAK GRAND TOUR 01-94 A 11-00 - 2.0i 16V - AUT.BREAK 09-95 A 07-98 - 2.2D COMERCIAL STANDARD APOS 07-98</p> <p>d94x138mm 1f-d24mm 1f-d82mm</p>		<p><b>KF2532BT</b> NO. 7701034800</p> <p>KIT DE FOLE DO CARDAN JUNTO À RODA</p> <p>RENAULT LAGUNA I 1.8i - 1.8i 16V - 2.0i - 2.0i 16V - 2.2D (1993 A 2001) - SAFRANE I 2.0i - 2.1 DT - 2.2i (1992 A 1996)</p> <p>d105x150mm 1f-d85mm 1f-d23mm</p>
	<p><b>KF2539-T</b> NO. 7701470155</p> <p>KIT DE FOLE DO CARDAN JUNTO À RODA</p> <p>RENAULT LAGUNA I 2.0i - 3.0i V6 (1993 A 2001)</p> <p>d110x150mm 1f-d98mm 1f-d30mm</p>		<p><b>R223447</b> NO. 7700417717</p> <p>TUBO PERMUTADOR DE CALOR DO AQUECIMENTO</p> <p>RENAULT LAGUNA I (B56_ - 556_) 1.8 (B56A/B) (11.93 A 03.01) 90cv 1794cc Hatchback - RENAULT LAGUNA I (B56_ - 556_) 1.8 (B56S/T/0) (08.95 A 03.01) 90cv 1783cc Hatchback</p> <p>B500-d18/18/18/7mm NULL</p>
	<p><b>S1561</b> NO. 7700824709</p> <p>SILENTBLOC DO SUBCHASSIS DIANTEIRO PARTE DE TRÁS</p> <p>RENAULT LAGUNA I (B56_ - 556_) 1.6 16V (B568 - B561) (11.97 A 03.01) 107cv 1598cc Hatchback - RENAULT LAGUNA I (B56_ - 556_) 1.8 (B56A/B) (11.93 A 03.01) 90cv 1794cc Hatchback - RENAULT LAGUNA I (B56_ - 556_) 1.8 (B56S/T/0) (08.95 A 03.01) 90cv 1783cc Hatchback - RENAULT LAGUNA I (B56_ - 556_) 1.8 (06.95 A 02.01) 94cv 1783cc Hatchback - RENAULT LAGUNA I (B56_ - 556_) 1.8 (06.95 A 06.98) 95cv 1794cc Hatchback - RENAULT LAGUNA I (B56_ - 556_) ...etc.</p> <p>d50x61mm c46mm d40mm 1f-d12mm</p>		<p><b>S1561</b> NO. 7700824709</p> <p>SILENTBLOC DO SUBCHASSIS DIANTEIRO PARTE DE TRÁS</p> <p>RENAULT LAGUNA I Grandtour (K56_) 1.6 16V (K568) (11.97 A 03.01) 107cv 1598cc Combi - RENAULT LAGUNA I Grandtour (K56_) 1.8 (K56S/T/0) (09.95 A 03.01) 90cv 1783cc Combi - RENAULT LAGUNA I Grandtour (K56_) 1.8 (K56Z) (09.95 A 03.01) 94cv 1794cc Combi - RENAULT LAGUNA I Grandtour (K56_) 1.8 16V (K563 - K564) (04.98 A 03.01) 120cv 1783cc Combi - RENAULT LAGUNA I Grandtour (K56_) 2.0 (K56C/H) (09.95 A 03.01) 113cv 1998cc Combi - RENAULT LAGUNA I...etc.</p> <p>d50x61mm c46mm d40mm 1f-d12mm</p>
	<p><b>S1562</b> NO. 7700826216</p> <p>SILENTBLOC DO SUBCHASSIS DIANTEIRO PARA A FRENTE</p> <p>RENAULT LAGUNA I (B56_ - 556_) 1.6 16V (B568 - B561) Local de montagem: Eixo dianteiro - Tipo de apoio: Apoio de borracha-metal - Local de montagem: à frente (11.97 A 03.01) 107cv 1598cc Hatchback - RENAULT LAGUNA I (B56_ - 556_) 1.8 (B56A/B) Local de montagem: Eixo dianteiro - Tipo de apoio: Apoio de borracha-metal - Local de montagem: à frente (11.93 A 03.01) 90cv 1794cc Hatchback 2/3 - RENAULT LAGUNA I (B56_ - 556_) 1.8 (B56S/T/0) Local de...etc.</p> <p>d50x83mm c54mm d40mm 1f-d13,5mm</p>		<p><b>S1562</b> NO. 7700826216</p> <p>SILENTBLOC DO SUBCHASSIS DIANTEIRO PARA A FRENTE</p> <p>RENAULT LAGUNA I Grandtour (K56_) 1.6 16V (K568) Local de montagem: Eixo dianteiro - Tipo de apoio: Apoio de borracha-metal - Local de montagem: à frente (11.97 A 03.01) 107cv 1598cc Combi - RENAULT LAGUNA I Grandtour (K56_) 1.8 (K56S/T/0) Local de montagem: Eixo dianteiro - Tipo de apoio: Apoio de borracha-metal - Local de montagem: à frente (09.95 A 03.01) 90cv 1783cc Combi - RENAULT LAGUNA I Grandtour (K56_) 1.8 (K56Z) Local de montagem: E...etc.</p> <p>d50x83mm c54mm d40mm 1f-d13,5mm</p>
	<p><b>UBV8010</b> NO. 068198821A</p> <p>BOMBA VACUO (KIT REPARAÇÃO)</p> <p>RENAULT LAGUNA I (DIESEL)</p> <p>d102x1mm 9f-d5mm</p>		<p><b>W5002</b> NO. 7700858731</p> <p>POLIE DA CAMBOTA (6 pistas)</p> <p>RENAULT LAGUNA I</p> <p>d136.9mm d15mm</p>
	<p><b>W5017</b> NO. 7700115309 - 7700110329 - 7700113018 - 8200689702 - 4418147 - 93192606 - 4402569 - 9110569</p> <p>POLIE DA CAMBOTA (6 pistas)</p> <p>RENAULT LAGUNA I</p> <p>d132mm d12.6mm</p>		<p><b>W5046</b> NO. 7700104292</p> <p>POLIE DA CAMBOTA (6 PISTAS)</p> <p>RENAULT LAGUNA I 2.2D Mtr G8T752-794 (83CV) (11-1993 A 03-2001) - LAGUNA I 2.2 TD Mtr G8T760 (113CV) (03-1996 A 03-2001)</p> <p>d140mm d14.5mm</p>
	<p><b>W5059</b> NO. 7431275801</p> <p>POLIE DA CAMBOTA (6 PISTAS)</p> <p>RENAULT LAGUNA I</p> <p>d143/149mm d23mm</p>		<p><b>W5062</b> NO. 7700109260 - 8200458960 - 7700738072 - 7700747282 - 8200689705 - 7700739905</p> <p>POLIE DA CAMBOTA (6 PISTAS)</p> <p>RENAULT LAGUNA I</p> <p>d122mm d12.6mm</p>

	<p><b>A1707</b> NO. 8200017025</p> <p>APOIO DE ESCAPE</p> <p>RENAULT LAGUNA II (APÓS 2001)</p> <p>114x75x50mm 1p-d6-28mm</p>		<p><b>A1782</b> NO. 8200052028 - 8200181590</p> <p>APOIO DO MOTOR FRENTE LADO DIREITO</p> <p>RENAULT LAGUNA II 2.0 dCi (BG1S) M9R 760 173CV (APÓS 01-2006) - 2.2 dCi G9T 600 140CV (APÓS 05-2005)</p> <p>180x130x120mm 1p-d10-32mm 3f-d10.5mm</p>
	<p><b>A1945</b> NO. 180691 - 1348993080</p> <p>APOIO CAIXA VELOCIDADES</p> <p>RENAULT LAGUNA II (BG0/1_) 3.0 V6 24V (BG01, BG02, BG0D, BG0Y) (A Partir de 03.01) 207cv 2946cc Hatchback - RENAULT LAGUNA II (BG0/1_) 1.9 dCi (BG0R) (A Partir de 10.01) 100cv 1870cc Hatchback - RENAULT LAGUNA II (BG0/1_) 2.2 dCi (A Partir de 05.05) 140cv 2188cc Hatchback - RENAULT LAGUNA II (BG0/1_) 2.2 dCi (BG0F) (A Partir de 10.01) 150cv 2188cc Hatchback - RENAULT LAGUNA II Grandtour (KG0/1_) 3.0 V6 24V (KG0D) (A Partir de 03.01) 207c...etc.</p> <p>150x105x50mm 1f-d16mm 3f-d14mm 3r-d12mm</p>		<p><b>E0162</b> NO. 8200002870 - 54616-00QAC - 4408904 - 91167000</p> <p>ESTICADOR DA BARRA ESTABILIZADORA DA FRENTE</p> <p>RENAULT LAGUNA II TT</p> <p>315x35x35mm 2d-d10-25mm</p>
	<p><b>E0218-M</b> NO. 8200250743</p> <p>ESTICADOR DO MOTOR PARTE LATERAL</p> <p>RENAULT LAGUNA II 1.9 Dci - 2.2 DCi</p> <p>230x75x55mm 1f-12x18mm 1r-d12mm</p>		<p><b>KS0806</b> NO. 7700415488 - 7700416271 - 7701209534 - 8200427868</p> <p>KIT SILENT-BLOC SUSPENSÃO EIXO TRASEIRO</p> <p>RENAULT LAGUNA II (BG0/1_) 1.6 16V (BG0A, BG0L) Ano fabric. at é: 12.07 (A Partir de 03.01) 107cv 1598cc Hatchback - RENAULT LAGUNA II (BG0/1_) 1.6 16V (BG1G, BG1H) Ano fabric. at é: 12.07, (A Partir de 02.05) 112cv 1598cc Hatchback - RENAULT LAGUNA II (BG0/1_) 1.8 16V (BG06, BG0J, BG0M) Ano fabric. at é: 12.07 (A Partir de 03.01) 116cv 1783cc Hatchback - RENAULT LAGUNA II (BG0/1_) 1.8 16V (BG0B, BG0M) Ano fabric. at é: 12.07 (A Partir...etc.</p> <p>105x80x75mm 1f-d14mm 1f-21x14mm</p>
	<p><b>Q2009</b> NO.</p> <p>UNIÃO DE ESCAPE 48/45x80mm</p> <p>RENAULT - LAGUNA II (BG0/1_) - 1.6 16V (BG0A - BG0L) (APÓS 03.01) 107cv 1598cc Hatchback - RENAULT - LAGUNA II (BG0/1_) - 1.6 16V (BG1G - BG1H) (APÓS 02.05) 112cv 1598cc Hatchback - RENAULT - LAGUNA II (BG0/1_) - 1.8 16V (BG06 - BG0J - BG0M) (APÓS 03.01) 116</p> <p>80x77x55mm 1f-d45/48mm</p>		<p><b>RT80009</b> NO. 7701050070</p> <p>TUBO DE TRAVÃO FRENTE LH-RH</p> <p>RENAULT LAGUNA II TT APÓS 03-2001</p> <p>410mm FB60 - FB60</p>
	<p><b>RT80010</b> NO. 7701050073</p> <p>TUBO DE TRAVÃO TRÁS LH-RH</p> <p>RENAULT LAGUNA II TT APÓS 03-2001</p> <p>210mm FB60 - FZ</p>		<p><b>S1502</b> NO. 8200125534 - 8200302003</p> <p>SILENT BLOC DE REPARAÇÃO SUSPENSÃO DO MOTOR</p> <p>RENAULT LAGUNA II 1.9 DCi F9Q 718 107CV (APÓS 3-2001) - 1.9 DCi (BG0E) F9Q 752 105CV (APÓS 06-2001) - 1.9 DCi (BG0G) F9Q 670 - F9Q 674 120CV (APÓS 03-2001) - 1.9 DCi (BG0R) F9Q 754 100CV (APÓS 10-2001)</p> <p>d60x48mm d51mm 1f-d12mm</p>
	<p><b>S1575</b> NO. 8200002868</p> <p>SILENTBLOC DO BRAÇO DA SUSPENSÃO DA FRENTE</p> <p>RENAULT LAGUNA II (BG0/1_) 1.6 16V (BG0A - BG0L) (APÓS 03.01) 107cv 1598cc Hatchback - RENAULT LAGUNA II (BG0/1_) 1.8 16V (BG06 - BG0J - BG0M) (APÓS 03.01) 116cv 1783cc Hatchback - RENAULT LAGUNA II (BG0/1_) 1.8 16V (BG0B - BG0M) (APÓS 03.01) 120cv 1783cc Hatchback - RENAULT LAGUNA II (BG0/1_) 1.8 16V (BG0B - BG0C - BG0J - BG0M - BG0V) (APÓS 03.01) 121cv 1783cc Hatchback - RENAULT LAGUNA II (BG0/1_) 2.0 16V (BG00 - BG0K - BG0P - BG0W) (AP...etc.</p> <p>d55x50mm c31mm 1f-d18mm</p>		<p><b>UEF51100</b> NO. 8200071846</p> <p>TUBO FLEXIVEL DE ESCAPE</p> <p>RENAULT LAGUNA II 1.6 16V 107CV (APÓS 03-2001) - 1.8 16V 116CV (APÓS 03-2001) - 1.8 16V 120CV (APÓS 03-2001) - 1.8 16V 121CV (APÓS 03-2001) - LAGUNA II GRANDTOUR 1.6 16V 107CV (APÓS 03-2001) - 1.8 16V 116CV (APÓS 03-2001) - 1.8 16V 120CV (APÓS 03-2001) -</p> <p>120x125x135mm 1f-d50mm c/100mm</p>
	<p><b>W5038</b> NO. 8200802664 - 8200051126 - 8200213058 - 8200207436 - 8200664348 - 8200195546 - 8200555547 - 820046808...</p> <p>POLIE DA CAMBOTA (6 PISTAS)</p> <p>RENAULT LAGUNA II 2.2 DCi</p> <p>d148mm d30mm</p>		<p><b>W5083</b> NO. 8200207435 - 8200162582 - 8200664350 - 8200555549 - 8200802666 - 8200458171 - 8200097903</p> <p>POLIE DA CAMBOTA (7 PISTAS)</p> <p>RENAULT - LAGUNA II (BG0 - 1_) - 2.2 dCi Hatchback 140CV 2188cc (APÓS 05-2005) - 2.2 dCi (BG0F) Hatchback 150CV 2188cc (APÓS 10-2001) - LAGUNA II GRANDTOUR (KG0 - 1_) - 2.2 dCi Combi 140CV 2188cc - 2.2 dCi (KG0F) 150CV 2188cc (APÓS 10-2001)</p> <p>d152/162mm d30/58mm</p>
	<p><b>W5089</b> NO. 8200276840 - 8200297935 - 8200451073 - 8200523068 - 8200817574 - 8200297835 - 8200619927 - 820038647...</p> <p>POLIE DA CAMBOTA (7 PISTAS)</p> <p>RENAULT MOTOR 2.0 16V (F4R) - LAGUNA II</p> <p>d151mm d24.5mm</p>		<p><b>W5111</b> NO. 8200352613 - 8200552236 - 8200699517 - 8200544135 - 8200687605 - 8200395313 - 7700105788 - 820004405...</p> <p>POLIE DA CAMBOTA (6 PISTAS)</p> <p>RENAULT LAGUNA II (BT0-1) 1.5 dCi (BT00 - BT0A - BT0T - BT1J) (K9K 780) 110CV (APÓS 10-2007)</p> <p>d155-151mm d26mm</p>

	<b>W5121</b> NO. 8200767762 - 8200361247 - 12303-00Q0A - 4449456 - 4431160 - 93198633 - 04431160 - 12303-00Q1D - 9316...		<b>W5128</b> NO. 8200268426 - 8200297936 - 8200376911 - 8200457775 - 8200523072 - 8200097903 - 8200608653 - 820018883...						
	<b>POLIE DA CAMBOTA (7 PISTAS)</b> RENAULT - LAGUNA II (BG0/1_) - 2.0 dCi (BG1T) Código do mot or: M9R 740 (APÓS 08.05) 150cv 1995cc Hatchback - RENAULT - LAGUNA II (BG0/1_) - 2.0 dCi (BG14 - BG1S) Código do mot or: M9R 760 (APÓS 01.06) 173cv 1995cc Hatchback - RENAULT - LAGUNA II Grandtour		<b>POLIE DA CAMBOTA (7 PISTAS)</b> RENAULT LAGUNA II (BG0/1_) 1.9 dCi (BG1A - BG1W) Hatchback (APÓS 01-2005) 110CV 1870CC - RENAULT LAGUNA II (BG0/1_) 1.9 dCi (BG08 - BG0G) Hatchback (APÓS 03-2001) 120CV 1870CC - RENAULT LAGUNA II (BG0/1_) 1.9 dCi (BG1A - BG1V) Hatchback (APÓS 05-2005) 130CV						
d155/157mm		31x38mm		d155mm		1f-d25mm			
	<b>W5137</b> NO. 8200687605 - 8200699517 - 8200352613 - 8200395313 - 8200544135 - 8200552236 - 8200687605 - 820069951...								
	<b>POLIE DA CAMBOTA 6 PISTAS</b> RENAULT LAGUNA II (BG0/1_) 1.6 16V (BG0A - BG0L) Código do motor: K4M.7.18 (APÓS 03.01) 107cv 1598cc Hatchback - RENAULT LAGUNA II (BG0/1_) 1.6 16V (BG1G - BG1H) Código do motor: K4M.7.16 (APÓS 02.05) 112cv 1598cc Hatchback - RENAULT LAGUNA II Grandtour (KG0/1_) 1.6 16V Código do motor: K4M.7.18 - Código do motor: K4M.7.16 (APÓS 02.05) 112cv 1598cc Combi - RENAULT LAGUNA III (BT0/1) 1.6 16V (BT04 - BT0D - BT0U) Código do motor: K4M.8.2...etc.								
d155mm		d26mm							

RENAULT LAGUNA 3

	<b>W5121</b> NO. 8200767762 - 8200361247 - 12303-00Q0A - 4449456 - 4431160 - 93198633 - 04431160 - 12303-00Q1D - 9316...								
	<b>POLIE DA CAMBOTA (7 PISTAS)</b> RENAULT - LAGUNA III (BT0/1) - 2.0 dCi (BT08 - BT0K - BT0J - BT14 - BT1A - BT1D) Código do mot or: M9R 802 - M9R 742 - M9R 744 (APÓS 10.07) 131cv 1995cc Hatchback - RENAULT - LAGUNA III (BT0/1) - 2.0 dCi (BT01 - BT09 - BT12 - BT1S) Código do motor: M9R 802 - M9R 805								
d155/157mm		31x38mm							

RENAULT LAGUNA-LAGUNA GRANDTOUR

	<b>A1067</b> NO. 7700818371		<b>A1353</b> NO. 7700423007E				
	<b>SUPORTE DO MOTOR</b> RENAULT LAGUNA		<b>SUPORTE DE MOTOR DIREITO</b> RENAULT LAGUNA				
160x90x39mm		1f-d12mm		170x160x160mm		NULL	
	<b>A1472</b> NO. 7700414099		<b>A1782</b> NO. 8200052028 - 8200181590				
	<b>SUPORTE MOTOR DIREITO</b> RENAULT LAGUNA DIESEL		<b>APOIO DO MOTOR FRENTE LADO DIREITO</b> RENAULT LAGUNA GRANDTOUR 2.0 dCi (KG1S) M9R 760 173CV (APÓS 01-2006) - 2.0 dCi (KG1T) M9R 740 150CV (APÓS 08-2005) - 2.2 dCi G9T 600 140CV (APÓS 05-2005) - 2.2 dCi (KGOF) G9T 702 150CV (APÓS 10-2001)				
170x145x90mm		1p-d10-32mm		180x130x120mm		1p-d10-32mm 3f-d10.5mm	
	<b>BE25</b> NO. 7701458595 - 7701450595		<b>E0210-M</b> NO. 7700422529				
	<b>ABRAÇADEIRA DE ESCAPE CÔNCAVA (58 mm)</b> RENAULT LAGUNA (APÓS 1994)		<b>ESTICADOR DO MOTOR PARTE TRÁS</b> RENAULT LAGUNA 1.6 16V - 1.8 16V - 1.9 TDI (APÓS 1994-2001)				
95x60x20mm		2p-d8mm		210x68x50mm		2f-d12mm	



	<p><b>E0239-M</b> NO. 7700411189</p> <p>ESTICADOR DO MOTOR PARTE DE TRÁS</p> <p>RENAULT LAGUNA 1.9 DCi (09-1999 A 03-2001) - 2.2 DT (03-1996 A 03-2001) - 3.0 (11-1993 A 03-2001) - 3.0 24V (03-1997 A 03-2001)</p> <p>187x60x61mm 2f-d14mm</p>		<p><b>E0239-M</b> NO. 7700411189</p> <p>ESTICADOR DO MOTOR PARTE DE TRÁS</p> <p>RENAULT LAGUNA GRANDTOUR 1.9 DCi (09-1999 A 03-2001) - 2.2 DT (03-1996 A 03-2001) - 3.0 (02-1996 A 03-2001) - 3.0 24V (03-1997 A 03-2001)</p> <p>187x60x61mm 2f-d14mm</p>
	<p><b>E0249-M</b> NO. 7700817782</p> <p>ESTICADOR DO MOTOR PARTE DE TRÁS</p> <p>RENAULT LAGUNA GRANDTOUR 1.8 90CV (F3P 670 - F3P 678) (09-1995 A 03-2001) - 1.8 94CV (F3P 720 - F3P 724) (09-1995 A 03-2001) - 1.8 16V 120CV (F4P 760) (04-1998 A 03-2001) - 2.0 114CV (F3R 768) (10-1998 A 01-2001) - 2.0 113CV (F3R 722 - F3R 723) (09-1995 A 03-2001)</p> <p>220x75x40mm 1f-d10mm 1f-d12mm</p>		<p><b>E1067</b> NO. 6001547908</p> <p>ESTICADOR DE ESCAPE</p> <p>RENAULT LAGUNA (APÓS 1994)</p> <p>55x42x36mm NULL</p>
	<p><b>F0830-1I</b> NO. 7701349696 - 7701349841 - 7701464758 - 7701466172</p> <p>FOLE DA TRANSMISSÃO JUNTO À CAIXA</p> <p>RENAULT LAGUNA (1) 1.8i - 1.8i 16V - 2.0i - 2.0i 16V (1993 A 2001)</p> <p>d90x113mm 1f-d24mm 1f-d73mm</p>		<p><b>F0901A4I</b> NO. 7701466083 - 7701466983</p> <p>FOLE TRANSMISSÃO ESQUERDA LADO DA CAIXA C/ ROLAMENTO 28mm</p> <p>RENAULT LAGUNA</p> <p>d115x90mm 1f-d88mm 1f-d28mm</p>
	<p><b>F1089-I</b> NO.</p> <p>FOLE DA TRANSMISSÃO LADO DA RODA</p> <p>RENAULT LAGUNA</p> <p>d93x110mm 1f-d80mm 1f-d22mm</p>		<p><b>F1329-I</b> NO. 7701472212 - 7701466349 - 7701470299</p> <p>FOLE DA TRANSMISSÃO JUNTO À CAIXA</p> <p>RENAULT LAGUNA   2.2 DT - 3.0i V6 (1996 A 2001)</p> <p>d86x102mm 1f-d73mm 1f-d26mm</p>
	<p><b>F1827A-I</b> NO. 7701468573 - 7701470566</p> <p>FOLE DA TRANSMISSÃO JUNTO À CAIXA</p> <p>RENAULT LAGUNA   1.6 16V - 1.8i - 1.8i 16V - 1.9 Dti - 2.0i - 2.0i 16V - 2.2 D - 2.2 DT (1993 A 2001)</p> <p>d115x85mm 1f-d81mm 1f-d27.8mm</p>		<p><b>KF2532</b> NO. 7701034800 - 7701467125</p> <p>FOLE DO LADO DA RODA</p> <p>RENAULT LAGUNA S</p> <p>d94x138mm 1f-d24mm 1f-d82mm</p>
	<p><b>KF2534</b> NO.</p> <p>KIT DE FOLE</p> <p>RENAULT LAGUNA</p> <p>d95x128mm 1f-d80mm 1f-d26mm</p>		<p><b>M6051</b> NO. 7700766353 - 7700782519 - 6025308326 - 7700766355 - 3445663 - 3458510</p> <p>JUNTA DE ESCAPE</p> <p>RENAULT LAGUNA (APÓS 1994)</p> <p>d89x12.2mm 1f-d74.5mm</p>
	<p><b>M6076</b> NO. 7700823540</p> <p>JUNTA DE ESCAPE</p> <p>RENAULT LAGUNA (APÓS 1994)</p> <p>120x80mm 1f-d60mm</p>		<p><b>RF5003</b> NO. 7700860371</p> <p>TUBO DE FERRO RADIADOR</p> <p>RENAULT LAGUNA 1.8</p> <p>B415-d18/18mm 85-275-120+B385-d13/13mm-100-255-65-65mm</p>
	<p><b>S1216</b> NO. 7700822503</p> <p>SILENT-BLOC CENTRAL DO BRAÇO DA SUSPENSÃO FRENTE</p> <p>RENAULT LAGUNA</p> <p>d55x55mm c31mm 1f-d18mm</p>		<p><b>S1217</b> NO. 7700824042</p> <p>SILENT-BLOC EXTERIOR DA SUSPENSÃO DA FRENTE</p> <p>RENAULT LAGUNA</p> <p>d58x55mm c30mm 1f-d11.5mm</p>

	<p><b>S1500</b> NO. 7700825795</p> <p>SILENT BLOC DO TIRANTE SUSPENSÃO MOTOR</p> <p>RENAULT LAGUNA GRANDTOUR 2.0 F3R 768 114CV (10-1998 A 01-2001) - 2.0 (K56C/H) F3R 722 - F3R 723 113CV (09-1995 A 03-2001) - 2.0 16V (A56A/B) F4R 780 140CV (09-1999 A 03-2001) - 2.0 16V (K56D/M) N7Q 700 - N7Q 704 139CV (09-1995 A 03-2001) - 2.2 D (K56F/2 - S56F</p> <p>d72x48mm c31mm 1f-d14mm</p>		<p><b>U7010</b> NO. 8200059541</p> <p>TENSORES CORREIA ALTERNADOR</p> <p>RENAULT LAGUNA 1.9 DTi - 2.0 16V (N7Q)</p> <p>d34x130mm 2f-d8mm</p>
	<p><b>W5037</b> NO. 7700105707</p> <p>POLIE DA BOMBA DA DIRECÇÃO (6 PISTAS)</p> <p>RENAULT LAGUNA APÓS 1994</p> <p>d98mm d29mm</p>		<p><b>W5067</b> NO. 7700105321 - 7700101242 - 8200313231 - 8200392683 - 8000544153 - 7700105788 - 8200044050 - 820055764...</p> <p>POLIE DA CAMBOTA (6 PISTAS)</p> <p>RENAULT LAGUNA</p> <p>d133mm d26mm</p>
	<p><b>W5068</b> NO. 7700115766 - 8200386446 - 7700113776 - 8200386451 - 8200079183 - 8200689705 - 7700739905 - 4413749 - ...</p> <p>POLIE DA CAMBOTA (6 PISTAS)</p> <p>RENAULT LAGUNA</p> <p>d151/155mm d12.6mm</p>		<p><b>W5077</b> NO. 8200392683</p> <p>POLIE DA CAMBOTA (6 PISTAS)</p> <p>RENAULT LAGUNA III</p> <p>d133.6mm d26mm</p>
	<p><b>W5121</b> NO. 8200767762 - 8200361247 - 12303-00Q0A - 4449456 - 4431160 - 93198633 - 04431160 - 12303-00Q1D - 9316...</p> <p>POLIE DA CAMBOTA (7 PISTAS)</p> <p>RENAULT - LAGUNA Coupé (DT0/1) - 2.0 dCi (DT01 - DT09 - DT12 - DT1D) Código do mot or: M9R 802 - M9R 805 - M9R 814 (APÓS 09.08) 150cv 1995cc Coupé - RENAULT - LAGUNA Coupé (DT0/1) - 2.0 dCi Código do mot or: M9R 800 - M9R 809 - M9R 815 (APÓS 09.08) 173cv 1995cc</p> <p>d155/157mm 31x38mm</p>		<p><b>Z10508</b> NO. 7701397195</p> <p>Mola de fixação</p> <p>RENAULT LAGUNA</p> <p>d16.5x16.7mm 1p-d8-18.8mm 1f-d7.5mm</p>
	<p><b>Z80474</b> NO. 7703077068</p> <p>Mola de painel</p> <p>RENAULT LAGUNA</p> <p>d18.5x13.5mm 1p-d7-12mm</p>		<p><b>Z80533</b> NO. 7543023 - 7703081019 - 9759904480</p> <p>Mola de retenção</p> <p>RENAULT LAGUNA</p> <p>10x17x10mm 1p-7.2x14-9mm 1f-d4.2mm</p>
	<p><b>Z80583</b> NO. 7703077117</p> <p>Mola de painel</p> <p>RENAULT LAGUNA</p> <p>d20x15.5mm 1p-d7.5-13.5mm</p>		<p><b>Z80603</b> NO. 7703077256</p> <p>Mola de friso</p> <p>RENAULT LAGUNA</p> <p>18.6x13x9.5mm NULL</p>
	<p><b>Z80608</b> NO. 7703077225 - 7518N8</p> <p>Mola de painel</p> <p>RENAULT LAGUNA</p> <p>d35x25mm 1p-d10.7-22.5mm</p>		<p><b>Z80627</b> NO. 7703077345</p> <p>Mola de painel</p> <p>RENAULT LAGUNA</p> <p>d15x18.5mm 1p-d7.5-12.5mm</p>
	<p><b>Z80629</b> NO. 7703077250</p> <p>Mola de painel</p> <p>RENAULT LAGUNA</p> <p>d15x19mm 1p-d8.5-12.5mm</p>		<p><b>Z80633</b> NO. 7703081054</p> <p>Mola de painel</p> <p>RENAULT LAGUNA</p> <p>d30x17mm 1p-d9.7-15mm</p>

	<b>Z80671</b>	NO. 7703081190		<b>Z80737</b>	NO. 7703077435
	Mola de fixação RENAULT LAGUNA			Mola de painel RENAULT LAGUNA	
d10x12mm		1p-d8-10mm 1f-d5.5mm	d35.5x25.5mm		1p-d12.5-22.5mm
	<b>Z80808</b>	NO. 699786 - 7701044547 - 9619769080		<b>Z80815</b>	NO. 7703072360 - 0151500QAB
	Mola de fixação RENAULT LAGUNA			NULL RENAULT LAGUNA	
NULL		NULL	d18x26mm		1p-d8.5-14mm

## RENAULT LOGAN

	<b>W5108</b>	NO. 8200392697		
	POLIE DA CAMBOTA (5 PISTAS) RENAULT LOGAN 1.5 dCi(K9K 792) 68CV (APÓS 04-2007) - 1.5 dCi(K9K 796) 86CV (APÓS 02-2008) - 1.6(K4M 690) 105CV (APÓS 04-2007) - RENAULT LOGAN STATION WAGON (KS) 1.5 dCi(K9K 792) 68CV (APÓS 04-2007) - 1.5 dCi(K9K 796) 86CV (APÓS 02-2008) - 1.6 (K4M 6			
NULL		d153.4mm 1f-d26mm		

## RENAULT MASTER

	<b>A0808-8</b>	NO. 7700565762		<b>A1816</b>	NO. 7700745357
	SUPORTE DE ESCAPE (PERNO 8mm) RENAULT MASTER			APOIO DO MOTOR FRENTE LADO DIREITO RENAULT - MASTER I Autocarro (T_) - 28-35 2.0 (10.86 - 07.98) 79cv 1995cc Autocarro - RENAULT - MASTER I Autocarro (T_) - 28-35 2.0 (08.80 - 09.86) 80cv 1995cc Autocarro - RENAULT - MASTER I Autocarro (T_) - 30 2 - 2 (08.80 - 07.98) 91cv 2165cc Autocarro	
48x42x27mm		2p-d8-18mm	76x75x62mm		2p-d10x30mm
	<b>A1816</b>	NO. 7700745357		<b>BE25</b>	NO. 7701458595 - 7701450595
	APOIO DO MOTOR FRENTE LADO DIREITO RENAULT - MASTER II Autocarro (JD) - 1.9 dTi (APÓS 09.00) 80cv 1870cc Autocarro - RENAULT - MASTER II Autocarro (JD) - 1.9 dCi 80 (APÓS 11.01) 82cv 1870cc Autocarro - RENAULT - MASTER II Autocarro (JD) - 2.2 dCi 90 (APÓS 09.00) 90cv 2188cc Autocarro - REN			ABRAÇADEIRA DE ESCAPE CÔNCAVA (58 mm) RENAULT MASTER	
76x75x62mm		2p-d10x30mm	95x60x20mm		2p-d8mm
	<b>E0138</b>	NO. 7700309070 - 7700302165 - 54616-00QAB - 4500198 - 9160498		<b>E0139</b>	NO. 7700309071 - 7700307343 - 54618-00QAA - 4500199 - 9160499
	ESTICADOR DA BARRA ESTABILIZADORA DA FRENTE LADO ESQUERDO RENAULT MASTER I 2.1D - 2.5D - 2.8 DTi (1980 (ATÉ 07-1998) - MASTER II 2.1D - 2.5D - 2.8 DTi (APÓS 07-1998)			ESTICADOR DA BARRA ESTABILIZADORA DA FRENTE LADO DIREITO RENAULT MASTER I 2.1D - 2.5D - 2.8 DTi (1980 (ATÉ 07-1998) - MASTER II 2.1D - 2.5D - 2.8 DTi (APÓS 07-1998)	
160x40x40mm		2p-d10-30mm	160x40x40mm		2p-d10-28mm



	<p><b>E0241-M</b> NO. 7700308756</p> <p>ESTICADOR DO MOTOR PARTE DE TRÁS</p> <p>RENAULT MASTER I (28.35) 2.0 - (28.35) 2.1D - (30) 2.2 - (28.35) 2.4D - (28.35) 2.5D - (28.35) 2.5TD (1980 A 1998) - MASTER II 1.9 DTi - 1.9 DCi 80 - 2.2DCi 90 - 2.5D - 2.5DCi 120 - 2.8DTi (1998 A 09-2003) - MASTER III 2.5 DCi 100 (APOS 10-2003)</p> <p>141x80x55mm 2f-d12mm</p>		<p><b>E0248-M</b> NO. 8200027176</p> <p>ESTICADOR DO MOTOR PARTE TRÁS</p> <p>RENAULT MASTER II Autobus 1.9 Dci 80 (F9Q 772) 82CV (APOS 11-2001) - 1.9 Dti (F9Q 770) 80CV (APOS 09-2000) - 2.2 Dci 90 (G9T 722) 90CV (APOS 09-2000) - 2.5 Dci 120 (G9U 720 - G9U 754) 115CV (APOS 10-2001) - RENAULT MASTER II Furgonato 1.9 Dci 80 (F9Q 772)</p> <p>150x80x94mm 2f-d12mm</p>
	<p><b>E1013</b> NO. 7700632015</p> <p>ESTICADOR DE ESCAPE</p> <p>RENAULT MASTER</p> <p>d64x13mm 1f-d41mm</p>		<p><b>F0830-11</b> NO. 7701349696 - 7701349841 - 7701464758 - 7701466172</p> <p>FOLE DA TRANSMISSÃO JUNTO À CAIXA</p> <p>RENAULT MASTER (1) 2.0 28-35 (08-1980 A 10-1986)</p> <p>d90x113mm 1f-d24mm 1f-d73mm</p>
	<p><b>F1113-I</b> NO. 7701013275</p> <p>FOLE DO LADO DA RODA (JUNTA d98mm)</p> <p>RENAULT MASTER</p> <p>d108x150mm 1f-d25mm 1f-d85mm</p>		<p><b>F1701K3I</b> NO. 7701470910</p> <p>FOLE DA TRANSMISSÃO JUNTO À CAIXA</p> <p>RENAULT MASTER II 1.9 DCi - 2.2 DCi - 2.5 DCi - 2.5D - 2.8 DTi (APOS 1998)</p> <p>d85x200mm 1f-d75mm 1f-d25mm</p>
	<p><b>F1817-I</b> NO. 7701201654</p> <p>FOLE DA TRANSMISSÃO JUNTO À CAIXA</p> <p>RENAULT MASTER I 2.0 (28-35) - 2.1 D (28-35) - 2.2 (30) - 2.4 D (28-35) - 2.5 D (28-35) - 2.5 TD (28-35) - 2.5 TD (35) (1980 A 1998)</p> <p>d98x119mm 1f-d81mm 1f-d26mm</p>		<p><b>F1827A-I</b> NO. 7701468573 - 7701470566</p> <p>FOLE DA TRANSMISSÃO JUNTO À CAIXA</p> <p>RENAULT MASTER II 1.9 DCi - 2.2 DCi - 2.5 Dci (APOS 1998)</p> <p>d115x85mm 1f-d81mm 1f-d27.8mm</p>
	<p><b>KF2539-T</b> NO. 7701470155</p> <p>KIT DE FOLE DO CARDAN JUNTO À RODA</p> <p>RENAULT MASTER II 2.5D - 2.8 DTi (APOS 1998)</p> <p>d110x150mm 1f-d98mm 1f-d30mm</p>		<p><b>KF2590</b> NO.</p> <p>KIT DE FOLE DO CARDAN JUNTO À RODA</p> <p>RENAULT MASTER I 2.0 28-35 - 2.0D 28-35 2.1 - 2.2 30 - 2.4D 28-35 - 2.5D - 2.5D 28-35 - 2.5 TD 28-35 - 2.8 DTi (1980 A 1998) - MASTER II 2.5D - 2.8 DTi (APOS 1998)</p> <p>d105x150mm 1f-d86mm 1f-d30mm</p>
	<p><b>KS0805</b> NO. 8200024453 - 7700302151</p> <p>KIT DE SILENT BLOCS DA SUSPENSÃO DE LÂMINAS DE TRÁS</p> <p>RENAULT MASTER II Autocarro (JD) 1.9 dTi (A Partir de 09.00) 80cv 1870cc Autocarro - RENAULT MASTER II Autocarro (JD) 1.9 dCi 80 (A Partir de 11.01) 82cv 1870cc Autocarro - RENAULT MASTER II Autocarro (JD) 2.2 dCi 90 (A Partir de 09.00) 90cv 2188cc Autocarro - RENAULT MASTER II Autocarro (JD) 2.5 dCi 120 (A Partir de 10.01) 115cv 2463cc Autocarro - RENAULT MASTER II Autocarro (JD) 2.5 dCi (A Partir de 08.06) 120cv 2464cc Autocarro - RE...etc.</p> <p>d45x77mm d40x63mm 1f-d16mm</p>		<p><b>M6052</b> NO. 7700781679 - 7700782520 - 8932001367 - 8933000112</p> <p>JUNTA DE ESCAPE</p> <p>RENAULT MASTER (APOS 1981)</p> <p>d67x13.8mm 1f-d49.6mm</p>
	<p><b>M6088</b> NO. 7700785283 - 7700779464</p> <p>JUNTA DE ESCAPE</p> <p>RENAULT MASTER (APOS 1981)</p> <p>d68x15mm 1f-d54mm</p>		<p><b>RT08946</b> NO. 5000388495 - 7700309009</p> <p>TUBO DE TRAVÃO FRENTE LH-RH</p> <p>RENAULT MASTER I (ENTRE 1980 E 07-98) - MASTER II (APOS 07-98) 2.0 - 2.4 D - 2.5D - 2.5TD (T28-T30-T35)</p> <p>500mm FB23 - MC11</p>
	<p><b>RT08947</b> NO. 5000388496</p> <p>TUBO DE TRAVÃO TRÁS LH-RH</p> <p>RENAULT MASTER I (ENTRE 1980 E 07-98) - MASTER II (APOS 07-98) 2.0 - 2.4 D - 2.5D - 2.5TD (T28-T30-T35)</p> <p>345mm FB23 - MC11</p>		<p><b>RT80206</b> NO. 5010422007 - 46201-00QAH</p> <p>TUBO DE TRAVÃO FRENTE LH-RH</p> <p>RENAULT MASTER II TT (APOS 07-1998)</p> <p>582mm FZ - MC11</p>

	<p><b>RT80208</b> NO. 7700309823 - 46204-00QAA - 7700302387</p> <p>TUBO DE TRAVÃO CENTRAL</p> <p>RENAULT MASTER II TT (APÓS 07-1998)</p>		<p><b>RT80211</b> NO. 8200086894 - 46201-00QAE - 46204-00QAE</p> <p>TUBO DE TRAVÃO TRÁS LH-RH (COM DISCO)</p> <p>RENAULT MASTER II TT (APÓS 07-1998)</p>
	<p><b>RT80384</b> NO. 7700302380</p> <p>TUBO DE TRAVÃO FRENTE LH-RH</p> <p>RENAULT MASTER II TT (07-1998 A 08-2003)</p>		<p><b>RT80385</b> NO. 7700302379</p> <p>TUBO DE TRAVÃO FRENTE LH-RH</p> <p>RENAULT MASTER II TT (07-1998 A 08-2003)</p>
	<p><b>RT80587</b> NO. 4403643 - 8200057462 - 46201-00QAD</p> <p>TUBO DE TRAVÃO DA FRENTE LH-RH</p> <p>RENAULT MASTER II Caixa (FD) 1.9 dTi (APÓS 09.00) 80cv 1870cc Caixa - RENAULT MASTER II Caixa (FD) 1.9 dCi 80 (APÓS 11.01) 82cv 1870cc Caixa - RENAULT MASTER II Caixa (FD) 2.2 dCi 90 (APÓS 09.00) 90cv 2188cc Caixa - RENAULT MASTER II Caixa (FD) 2.5 dCi 120 (APÓS 10.01) 115cv 2463cc Caixa - RENAULT MASTER II Camião de plataforma/chassis (ED/HD/UD) 2.2 dCi 90 (APÓS 09.00) 90cv 2188cc Camião de plataforma/chassis - RENAULT MASTER II Cami...etc.</p>		<p><b>RT80588</b> NO. 4403645 - 8200057460 - 46201-00QAC</p> <p>TUBO DE TRAVÃO DA FRENTE</p> <p>RENAULT MASTER II Caixa (FD) 1.9 dTi (APÓS 09.00) 80cv 1870 Caixa - RENAULT MASTER II Caixa (FD) 1.9 dCi 80 (APÓS 11.01) 82cv 1870cc Caixa - RENAULT MASTER II Caixa (FD) 2.2 dCi 90 (APÓS 09.00) 90cv 2188cc Caixa - RENAULT MASTER II Caixa (FD) 2.5 dCi 120 (APÓS 10.01) 115cv 2463cc Caixa - RENAULT MASTER II Camião de plataforma/chassis (ED/HD/UD) 2.2 dCi 90 (APÓS 09.00) 90cv 2188cc Camião de plataforma/chassis - RENAULT MASTER II Camião...etc.</p>
	<p><b>T0616-I</b> NO. 552400038R - 552402008R</p> <p>BATENTE SUSPENSÃO DE TRÁS</p> <p>RENAULT MASTER IV (APÓS 2010)</p>		<p><b>T0619-I</b> NO. 552400039R - 8200663205</p> <p>BATENTE DA SUSPENSÃO DE TRÁS</p> <p>RENAULT MASTER III</p>
	<p><b>T0620-I</b> NO. 552400022R</p> <p>BATENTE DA SUSPENSÃO DE TRÁS</p> <p>RENAULT MASTER III</p>		<p><b>U7010</b> NO. 8200059541</p> <p>TENSORES CORREIA ALTERNADOR</p> <p>RENAULT MASTER 1.9 Dti</p>
	<p><b>W5032</b> NO. 7700853469</p> <p>POLIE DA CAMBOTA (1 PISTA)</p> <p>RENAULT MASTER 2.1D - 2.1TD MOTORES J85 (740) (786)</p>		<p><b>W5038</b> NO. 8200802664 - 8200051126 - 8200213058 - 8200207436 - 8200664348 - 8200195546 - 8200555547 - 820046808...</p> <p>POLIE DA CAMBOTA (6 PISTAS)</p> <p>RENAULT MASTER FDOU ENG: G9U754</p>
	<p><b>W5061</b> NO. 7700853774</p> <p>POLIE DA CAMBOTA (2 PISTAS)</p> <p>RENAULT MASTER</p>		<p><b>W5083</b> NO. 8200207435 - 8200162582 - 8200664350 - 8200555549 - 8200802666 - 8200458171 - 8200097903</p> <p>POLIE DA CAMBOTA (7 PISTAS)</p> <p>RENAULT - MASTER II Autocarro (JD) - 2.2 dCi 90 90CV 2188cc (APÓS 09-2000) - 2.5 dCi 114CV 2464cc (APÓS 01-2004) - 2.5 dCi 120 115CV 2463cc (APÓS 10-2001) - 2.5 dCi 120CV 2464cc (APÓS 08-2006) - 2.5 dCi 146CV 2464cc (APÓS 08-2006) - MASTER II Caixa (FD)</p>
	<p><b>W5095</b> NO. 8200267867</p> <p>POLIE DA CAMBOTA (7 PISTAS)</p> <p>RENAULT MASTER II 2.5 DCi (120) MT G9U754 - MT G9U720 (APÓS 10-2001)</p>		<p><b>W5129</b> NO. 8200111785</p> <p>POLIE DA BOMBA DA DIREÇÃO (7 PISTAS)</p> <p>RENAULT MASTER II Autocarro (JD) 2.5 dCi (APÓS 08-2006) 120CV 2464CC - Autocarro RENAULT MASTER II Autocarro (JD) 2.5 dCi (APÓS 08-2006) 146CV 2464CC Autocarro RENAULT MASTER II Caixa (FD) 2.5 dCi (APÓS 08-2006) 120CV 2464CC - RENAULT MASTER II Caixa (FD)</p>

	<p><b>W5133</b> NO. 8200805671</p> <p><i>POLIE DA CAMBOTA (7 PISTAS)</i></p> <p>RENAULT MASTER III Autocarro (JV) 2.3 dCi 100 FWD (JV0A - JV0B) (APÓS 02.11) 101cv 2299cc Autocarro - RENAULT MASTER III Autocarro (JV) 2.3 dCi 125 FWD (JV0C - JV0D - JV0H) (APÓS 02.11) 125cv 2299cc Autocarro - RENAULT MASTER III Autocarro (JV) 2.3 dCi 145 F</p> <p>d151mm 1f-38/31mm</p>		<p><b>Z80497</b> NO. 251867299</p> <p><i>Mola de painel</i></p> <p>Renault Master II</p> <p>d18x15mm 1p-d10-13mm</p>
	<p><b>Z80608</b> NO. 7703077225 - 7518N8</p> <p><i>Mola de painel</i></p> <p>RENAULT MASTER</p> <p>d35x25mm 1p-d10.7-22.5mm</p>		<p><b>Z80629</b> NO. 7703077250</p> <p><i>Mola de painel</i></p> <p>RENAULT MASTER</p> <p>d15x19mm 1p-d8.5-12.5mm</p>
	<p><b>Z80670</b> NO. 7703077341</p> <p><i>Mola de friso</i></p> <p>RENAULT MASTER</p> <p>33x10x8mm NULL</p>		<p><b>Z80671</b> NO. 7703081190</p> <p><i>Mola de fixação</i></p> <p>RENAULT MASTER</p> <p>d10x12mm 1p-d8-10mm 1f-d5.5mm</p>
	<p><b>Z80758</b> NO. 500326896 - 7703077421</p> <p><i>Mola de friso</i></p> <p>RENAULT MASTER</p> <p>d20x16.5mm 1p-8x8-6.5mm</p>		<p><b>Z80808</b> NO. 699786 - 7701044547 - 9619769080</p> <p><i>Mola de fixação</i></p> <p>RENAULT MASTER</p> <p>NULL NULL</p>
	<p><b>Z80838</b> NO. 6991.Y8 - 7703077468 - 7703077469 - 8201112162</p> <p><i>Mola</i></p> <p>RENAULT MASTER (Após 2010)</p> <p>d17x18.5mm 1p-d7.5-10.5mm</p>		

RENAULT MEGANE (1)

	<p><b>F0830-1I</b> NO. 7701349696 - 7701349841 - 7701464758 - 7701466172</p> <p><i>FOLE DA TRANSMISSÃO JUNTO À CAIXA</i></p> <p>RENAULT MEGANE (1) 1.6 (APÓS 1996)</p> <p>d90x113mm 1f-d24mm 1f-d73mm</p>		<p><b>F1329-I</b> NO. 7701472212 - 7701466349 - 7701470299</p> <p><i>FOLE DA TRANSMISSÃO JUNTO À CAIXA</i></p> <p>RENAULT MEGANE I 1.4i - 1.4i e - 1.4i ECO - 1.9 D ECO (1996 A 2008)</p> <p>d86x102mm 1f-d73mm 1f-d26mm</p>
	<p><b>F1827A-I</b> NO. 7701468573 - 7701470566</p> <p><i>FOLE DA TRANSMISSÃO JUNTO À CAIXA</i></p> <p>RENAULT MEGANE I 1.9 D - 1.9 DT - 1.9 DTi - 2.0 IDE 16V - 2.0i - 2.0i 16V (1996 A 2003)</p> <p>d115x85mm 1f-d81mm 1f-d27.8mm</p>		<p><b>KF2528-T</b> NO. 7701469411 - 7701469021</p> <p><i>KIT DE FOLE DO CARDAN JUNTO À RODA</i></p> <p>RENAULT MEGANE I 1.6i E (1996 A 2003)</p> <p>d90x140mm 1f-d80mm 1f-d25mm</p>

## RENAULT MEGANE (1)

	<p><b>KF2529-T</b> NO. 7701469021</p> <p><i>KIT DE FOLE DO CARDAN JUNTO À RODA</i></p> <p>RENAULT MEGANE I 1.6i 16V - 1.9 DT - 1.9 DTi - 2.0 iDE 16V - 2.0i - 2.0i 16V (1996 A 2003) - MEGANE I SCENIC 1.9 DT - 2.0i (1997 A 1999)</p>		<p><b>P1069</b> NO. 7700416723</p> <p><i>CAPA DE PEDAL DO TRAVÃO</i></p> <p>RENAULT MEGANE I GRANDTOUR (KA0-1) 1.9 DTI (KA1U) (02-2001 A 08-2003) 80CV 1870CC</p>
	<p><b>Q2009</b> NO.</p> <p><i>UNIÃO DE ESCAPE 48/45x80mm</i></p> <p>RENAULT - MEGANE I (BA0/1_) - 1.4 16V (BA0D - BA1H - BA0W - BA10) (03.99 - 08.03) 95cv 1390cc Hatchback - RENAULT - MEGANE I (BA0/1_) - 1.6 16V (BA11 - BA04 - BA0B - BA1J) (03.99 - 08.03) 107cv 1598cc Hatchback - RENAULT - MEGANE I Classic (LA0/1_) - 1.4 16V (</p>		<p>75x73x10mm NULL</p>
	<p>d110x140mm 1f-d88mm 1f-d27mm</p>		<p>80x77x55mm 1f-d45/48mm</p>



## RENAULT MEGANE (2)

	<p><b>A1695</b> NO. 8200338381 - 8200549237 - 8200549046</p> <p><i>APOIO DO MOTOR PARTE DA FRENTE DIREITO</i></p> <p>RENAULT MEGANE II 1.9 DCi (APÓS 11-02) - MEGANE II 2.0 (APÓS 11-02) - SCENIC II 1.9 DCi (APÓS 06-03) - SCENIC II 2.0 (APÓS 06-03)</p>		<p><b>A1706</b> NO. 8200035447 - 8200168187</p> <p><i>APOIO DE ESCAPE</i></p> <p>RENAULT MEGANE II (APÓS 11-02) TT - SCÉNIC II (APÓS 06-03)</p>
	<p><b>A1791</b> NO. 8200310006 - 8200035448</p> <p><i>APOIO DE ESCAPE</i></p> <p>RENAULT MEGANE II (BM0/1_ - CM0/1_) 1.4 16V (BM0B - CM0B) (APÓS 11-2002) 1.5 dCi (BM0F - CM0F) (APÓS 11-2002) - 1.6 16V (BM0C - CM0C) (APÓS 11-2002) - 1.9 dCi (BM0G - CM0G) (APÓS 11-2002) - 2.0 16V (BM0U - CM0U) (APÓS 11-2002)</p>		<p><b>A1813</b> NO. 8200902956 - 8200325283</p> <p><i>APOIO DO MOTOR LADO DIREITO SUPERIOR</i></p> <p>RENAULT - MEGANE II (BM0/1_ - CM0/1_) - 1.5 dCi (01.07 A 02.08) 103cv 1461cc Hatchback - RENAULT - MEGANE II (BM0/1_ - CM0/1_) - 1.5 dCi (05.05 A 06.08) 106cv 1461cc Hatchback - RENAULT - MEGANE II três volumes (LM0/1_) - 1.5 dCi (01.07 A 76) 103cv 1461cc</p>
	<p><b>A1934</b> NO. 8200105505</p> <p><i>APOIO DO BATENTE DE ENCOSTO DO ESCAPE</i></p> <p>RENAULT MEGANE II (BM0/1_ - CM0/1_) 1.5 dCi (BM0F, CM0F) (11.02 A 02.08) 82cv 1461cc Hatchback - RENAULT MEGANE II (BM0/1_ - CM0/1_) 1.5 dCi (05.05 A 02.08) 86cv 1461cc Hatchback - RENAULT MEGANE II (BM0/1_ - CM0/1_) 1.5 dCi (10.03 A 03.06) 101cv 1461cc Hatchback - RENAULT MEGANE II (BM0/1_ - CM0/1_) 1.5 dCi (01.07 A 02.08) 103cv 1461cc Hatchback - RENAULT MEGANE II (BM0/1_ - CM0/1_) 1.5 dCi (05.05 A 06.08) 106cv 1461cc Hatchback - RENAULT MEGANE...etc.</p>		<p><b>E0242-M</b> NO. 8200338385</p> <p><i>ESTICADOR DO MOTOR CENTRO INFERIOR</i></p> <p>RENAULT MEGANE II 1.5 Dci 101CV (K9K 728) (APÓS 10-2003) - RENAULT MEGANE II STATION WAGON 1.5 Dci 101CV (K9K 728) (APÓS 02-2004) - RENAULT MEGANE II TRE VOLUMI 1.5 Dci 101CV (K9K 728) (APÓS 02-2004)</p>
	<p><b>E0245-M</b> NO. 8200042454</p> <p><i>ESTICADOR DO MOTOR CENTRO INFERIOR</i></p> <p>RENAULT MEGANE II 1.5 Dci 106CV (K9K 732) (APÓS 05-2005) - RENAULT MEGANE II COUPÉ - CABRIOLET 1.5 Dci 106CV (K9K 732) (APÓS 03-2006) - RENAULT MEGANE II STATION WAGON 1.5 Dci 106CV (K9K 732) (APÓS 05-2005) - RENAULT MEGANE II TRE VOLUMI 1.5 Dci 106CV (K9</p>		<p><b>F4095</b> NO. 8200040073</p> <p><i>FOLE AMORTECEDORES FRENTE</i></p> <p>RENAULT MEGANE II (BM0/1_ - CM0/1_) 1.4 16V (10.03 A 02.08) 82cv 1390cc Hatchback - RENAULT MEGANE II (BM0/1_ - CM0/1_) 1.4 16V (BM0B, CM0B) (11.02 A 02.08) 98cv 1390cc Hatchback - RENAULT MEGANE II (BM0/1_ - CM0/1_) 1.6 (06.05 A 02.08) 105cv 1598cc Hatchback - RENAULT MEGANE II (BM0/1_ - CM0/1_) 1.6 Flex-Fuel (01.07 A 02.08) 105cv 1598cc Hatchback - RENAULT MEGANE II (BM0/1_ - CM0/1_) 1.6 16V (01.06 A 06.08) 112cv 1598cc Hatchback - RENAULT...etc.</p>
	<p><b>F9051H-I</b> NO. 7701209252</p> <p><i>FOLE DO CARDAN LADO DA RODA</i></p> <p>RENAULT MEGANE II (BM0/1_ - CM0/1_) 1.5 dCi (K9K 732 - K9K 734) 106CV (APÓS 05-2005) - 1.5 dCi (K9K 734) 103CV (APÓS 01-2007) - 1.9 dCi (F9Q 803 - F9Q 816) 131CV (APÓS 05-2005) - 2.0 (F4R 774) 230CV (APÓS 08-2006)</p>		<p><b>Q2009</b> NO.</p> <p><i>UNIÃO DE ESCAPE 48/45x80mm</i></p> <p>RENAULT - MEGANE II (BM0/1_ - CM0/1_) - 1.4 16V (BM0B - CM0B) (11.02 - 02.08) 98cv 1390cc Hatchback - RENAULT - MEGANE II (BM0/1_ - CM0/1_) - 1.6 (06.05 - 02.08) 105cv 1598cc Hatchback - RENAULT - MEGANE II (BM0/1_ - CM0/1_) - 1.6 16V (01.06 - 06.08) 112CV 1</p>
	<p>d95x120mm 1f-d27mm 1f-d81mm</p>		<p>80x77x55mm 1f-d45/48mm</p>



	<p><b>RT80213</b> NO. 8200234737 - 8200333851</p> <p>TUBO DE TRAVÃO FRENTE RH</p> <p>RENAULT MEGANE II COUPÉ - CABRIOLET 1.5 DCi (APÓS 03-2006) - 1.6 (APÓS 09-2003) - 1.9 DCi (APÓS 09-2003) - 2.0 (APÓS 09-2003) - 2.0 16V TURBO (APÓS 05-2004) - 2.0 DCi (APÓS 09-2005) - MEGANE II STATION WAGON 1.4 (APÓS 08-2003) - 1.5 DCi (APÓS 08-2003) - 1</p>		<p><b>RT80213</b> NO. 8200234737 - 8200333851</p> <p>TUBO DE TRAVÃO FRENTE RH</p> <p>RENAULT MEGANE II TRE VOLUMI 1.4 (APÓS 09-2003) - 1.5 DCi (APÓS 09-2003) - 1.6 (APÓS 09-2003) - 1.9 DCi (APÓS 09-2003) - 2.0 (APÓS 09-2003)</p>
	<p><b>S1487</b> NO. 8200242025</p> <p>SILENT BLOC DO BRAÇO DA SUSPENSÃO DA FRENTE</p> <p>RENAULT MEGANE II 1.4 16V (11-2002 A 10-2003) - 1.5 DCi (11-2002 A 05-2005) - 1.6 16V (APÓS 11-2002) - 1.9 DCi (11-2002 A 03-2004) - 2.0 16V (11-2002 A 05-2004) - 2.0 RENAULT SPORT (APÓS 05-2004) - MEGANE II COUPÉ-CABRIOLET 1.6 (APÓS 09-2003) - 1.9 DCi (A</p>		<p><b>S1487</b> NO. 8200242025</p> <p>SILENT BLOC DO BRAÇO DA SUSPENSÃO DA FRENTE</p> <p>RENAULT MEGANE II STATION WAGON 1.4 (APÓS 08-2003) - 1.5 DCi (08-2003 A 05-2005) - 1.6 (APÓS 08-2003) - 1.9 DCi (08-2003 A 03-2004) - 2.0 (APÓS 08-2003)</p>
	<p><b>S1488</b> NO. 8200041166</p> <p>SILENT BLOC DO BRAÇO DA SUSPENSÃO DA FRENTE</p> <p>RENAULT MEGANE II 1.4 16V (11-2002 A 10-2003) - 1.5 DCi (11-2002 A 05-2005) - 1.6 16V (APÓS 11-2002) - 1.9 DCi (11-2002 A 03-2004) - 2.0 16V (APÓS 11-2002) - 2.0 16V TURBO (APÓS 05-2004) - MEGANE II COUPÉ -CABRIOLET 1.6 (APÓS 09-2003) - 1.9 DCi (APÓS 09-2</p>		<p><b>S1488</b> NO. 8200041166</p> <p>SILENT BLOC DO BRAÇO DA SUSPENSÃO DA FRENTE</p> <p>RENAULT MEGANE II STATION WAGON 1.4 (APÓS 08-2003) - 1.5 DCi (08-2003 A 05-2005) - 1.6 (08-2003) - 1.9 DCi (08-2003 A 03-2004) - 2.0 (08-2003) - MEGANE II TRE VOLUMI 1.4 (APÓS 09-2003) - 1.5 DCi (09-2003 A 05-2005) - 1.6 (APÓS 09-2003) - 1.9 DCi (09-2003)</p>
	<p><b>S1515</b> NO. 8200742906</p> <p>SILENT BLOC DA SUSPENSÃO DE TRÁS PARTE DA FRENTE</p> <p>RENAULT MEGANE II (BM0-1_ - CM0-1_) 1.4 16V (K4J 732) 82CV (APÓS 10-2003) - 1.4 16V (BM0B - CM0B) (K4J 730) 98CV (APÓS 11-2002) - 1.5 dCi (K9K 724) 86CV (APÓS 05-2005) - 1.5 dCi (K9K 728) 101CV (APÓS 10-2003) - 1.5 dCi (K9K 732) 106CV (APÓS 05-2005) - 1.5 d</p>		<p><b>UEF51120</b> NO. 8200105517</p> <p>TUBO FLEXIVEL DE ESCAPE</p> <p>RENAULT MEGANE II 1.4 16V 82CV (APÓS 10-2003) - 1.6 16V 113CV (APÓS 11-2002) - MEGANE II TRÊS VOLUMES 1.4 82CV (APÓS 09-2003) - 1.6 113CV (APÓS 09-2003) - MEGANE II COMBI 1.6 113CV (APÓS 08-2003) - COUPÉ-CABRIOLET 1.6 113CV (APÓS 09-2003)</p>
	<p><b>W5019</b> NO. 12303-00QJ - 12303-00QAU - 12303-00QBA - 12303AY600 - 12303-BN700 - 8200392697</p> <p>POLIE DA CAMBOTA (5 PISTAS)</p> <p>RENAULT MEGANE II 1.4 - 1.6 - 2.0 (APÓS 2002) 16V (APÓS 06-2003)</p>		<p><b>W5074</b> NO. 8200523072 - 8200457775 - 8200268426 - 8200297936 - 8200376911 - 8200188832 - 8200457779 - 820029793...</p> <p>POLIE DA CAMBOTA (7 PISTAS)</p> <p>RENAULT MEGANE II 1.9 DCi (APÓS 2002)</p>
	<p><b>W5089</b> NO. 8200276840 - 8200297935 - 8200451073 - 8200523068 - 82000817574 - 8200297835 - 8200619927 - 820039647...</p> <p>POLIE DA CAMBOTA (7 PISTAS)</p> <p>RENAULT MOTOR 2.0 16V (F4R) MEGANE II</p>		<p><b>W5106</b> NO. 8200477938 - 8200511194 - 8200185800 - 8200184103</p> <p>POLIE DA CAMBOTA (6 PISTAS)</p> <p>RENAULT MEGANE II 1.4 16V (BM0B - CM0B) (K4J 730) 98CV (APÓS 11-2002) - 1.5 DCi (K9K 724) 86CV (APÓS 05-2005)</p>
	<p><b>W5108</b> NO. 8200392697</p> <p>POLIE DA CAMBOTA (5 PISTAS)</p> <p>RENAULT MEGANE II 1.4 16V (K4J 732) 82CV (APÓS 10-2003) - 1.4 16V (BM0B - CM0B) (K4J 730) 98CV (APÓS 11-2002) - 1.5 dCi (K9K 724) 86CV (APÓS 05-2005) - 1.5 dCi K9K 728 74 101CV (APÓS 10-2003) - 1.5 DCi (K9K 734) 103CV (APÓS 01-2007) - 1.5 dCi (BM0F - CM0F)</p>		<p><b>W5108</b> NO. 8200392697</p> <p>POLIE DA CAMBOTA (5 PISTAS)</p> <p>RENAULT MEGANE II Tre volumi 1.4 (K4K 730) 98CV (APÓS 09-2003) - 1.4 (K4J 732) 82CV (APÓS 09-2003) - 1.5 dCi (K9K 722) 82CV (APÓS 09-2003) - 1.5 dCi (K9K 724) 86CV (APÓS 05-2005) - 1.5 dCi (K9K 728) 101CV (APÓS 02-2004) - 1.5 dCi (K9K 734) 103CV (APÓS 01</p>
	<p><b>W5111</b> NO. 8200352613 - 8200552236 - 8200699517 - 8200544135 - 8200687605 - 8200395313 - 7700105788 - 820004405...</p> <p>POLIE DA CAMBOTA (6 PISTAS)</p> <p>RENAULT MEGANE II (BM0-1_ - CM0-1_) 1.5 dCi (K9K 724) 86CV (APÓS 05-2005)</p>		<p><b>W5121</b> NO. 8200767762 - 8200361247 - 12303-00Q0A - 4449456 - 4431160 - 93198633 - 04431160 - 12303-00Q1D - 9316...</p> <p>POLIE DA CAMBOTA (7 PISTAS)</p> <p>RENAULT - MEGANE II (BM0/1_ - CM0/1_) - 2.0 dCi (BM1K - CM1K) Código do mot or: M9R 700 - M9R 722 (09.05 - 02.08) 150cv 1995cc Hatchback - R E N A U L T - M E G A N E II (B M 0 / 1 _ - C M 0 / 1 _ ) - 2.0 d Ci Código do mot or: M9R 724 (0 1.0 7 - 0 2.0 8) 1</p>

## RENAULT MEGANE (2)

	<b>W5137</b>	NO. 8200687605 - 8200699517 - 8200352613 - 8200395313 - 8200544135 - 8200552236 - 8200687605 - 820069951...		<b>Z80838</b>	NO. 6991_Y8 - 7703077468 - 7703077469 - 8201112162
	POLIE DA CAMBOTA 6 PISTAS			Mola	
RENAULT MEGANE II (BM0/1_ - CM0/1_) 1.6 Código do motor: K4M.7.64 - Código do motor: K4M.7.88 (06.05 A 02.08) 105cv 1598cc Hatchback - RENAULT MEGANE II (BM0/1_ - CM0/1_) 1.6 Flex-Fuel Código do motor: K4M.8.56 - Variante e de equipamento: +AC (01.07 A 02.08) 105cv 1598cc Hatchback RENAULT MEGANE II (BM0/1_ - CM0/1_) 1.6 16V Código do motor: K4M.8.12 - Variante e de equipamento: +AC - Código do motor: K4M.8.13 (01.06 A 06.08) 112cv 1598cc H...etc.		RENAULT MEGANE (2)			
d155mm		d26mm		d17x18.5mm	1p-d7.5-10.5mm

## RENAULT MEGANE 3

	<b>A1934</b>	NO. 8200105505		<b>A1939</b>	NO. 112100019R
	APOIO DO BATENTE DE ENCOSTO DO ESCAPE			APOIO DE MOTOR LADO DIREITO	
RENAULT MEGANE III Hatchback (BZ0_) 1.5 dCi (BZ0C) (A Partir de 11.08) 90cv 1461cc Hatchback - RENAULT MEGANE III Hatchback (BZ0_) 1.5 dCi (A partir de 02.09) 106cv 1461cc Hatchback - RENAULT MEGANE III Hatchback (BZ0_) 1.5 dCi (BZ09_ BZ0D) (A Partir de 02.09) 110cv 1461cc Hatchback - RENAULT MEGANE III Hatchback (BZ0_) 1.9 dCi (BZ0N, BZ0J) (A Partir de 11.08) 131cv 1870cc Hatchback - RENAULT MEGANE III Grandtour (KZ0/1) 1.5 dCi (KZ0C, KZ...etc.		RENAULT MEGANE III Hatchback (BZ0_) 1.5 dCi (BZ0C) (A Partir de 11.08) 90cv 1461cc Hatchback - RENAULT MEGANE III Grandtour (KZ0/1) 1.5 dCi (KZ0C, KZ1A) (A Partir de 05.09) 90cv 1461cc Combi - RENAULT MEGANE III Coupé (DZ0/1_) 1.5 dCi (DZ0C, DZ1A) (A Partir de 11.08) 90cv 1461cc Coupé			
60x60x55mm		2f-17x7mm		230x260x145mm	3f-16mm 2f-13mm 1f-13x11mm
	<b>W5108</b>	NO. 8200392697		<b>W5121</b>	NO. 8200767762 - 8200361247 - 12303-00Q0A - 4449456 - 4431160 - 93198633 - 04431160 - 12303-00Q1D - 9316...
	POLIE DA CAMBOTA (5 PISTAS)			POLIE DA CAMBOTA (7 PISTAS)	
RENAULT MEGANE III 2 volumi - coda spiovente 1.5 dCi(K9K 830) 86CV (APÓS 12-2009) - 1.5 dCi (B70C)(K9K H 834) 90CV (APÓS 11-2008) - 1.5 dCi (BZ0D)(K9K 836) 110CV (APÓS 02-2009) - 1.6 16V Bifuel (BZ03)(K4M 866) 110CV (APÓS 11-2008) - RENAULT MEGANE II		RENAULT - MEGANE III Hatchback (BZ0_) - 2.0 dCi (BZ0Y) Códigomotor: M9R615 (APÓS 10.10) 150cv 1995cc Hatchback - RENAULT - MEGANE III Hatchback (BZ0_) - 2.0 dCi (BZ0L) Códigomotor: M9R610 (APÓS 04.09) 160cv 1995cc Hatchback - RENAULT - MEGANE III H			
NULL		d153.4mm 1f-d26mm		d155/157mm	31x38mm
	<b>W5137</b>	NO. 8200687605 - 8200699517 - 8200352613 - 8200395313 - 8200544135 - 8200552236 - 8200687605 - 820069951...		<b>Z80838</b>	NO. 6991_Y8 - 7703077468 - 7703077469 - 8201112162
	POLIE DA CAMBOTA 6 PISTAS			Mola	
RENAULT MEGANE III Hatchback (BZ0_) 1.6 16V (BZ0H) Código do motor: K4M.8.48 (APÓS 11.08) 101cv 1598cc Hatchback - RENAULT MEGANE III Hatchback (BZ0_) 1.6 16V (BZ1B - BZ1H) Código do motor: K4M.8.58 (APÓS 11.08) 110cv 1598cc Hatchback - RENAULT MEGANE III Hatchback (BZ0_) 1.6 16V Bifuel (BZ03) Código do motor: K4M.8.66 (APÓS 11.08) 110cv 1598cc Hatchback - RENAULT MEGANE III Hatchback (BZ0_) 1.5 dCi Código do motor: K9K.8.32 - Variante ...etc.		RENAULT MEGANE (3)			
d155mm		d26mm		d17x18.5mm	1p-d7.5-10.5mm

## RENAULT MEGANE CC MEGANE 3

	<b>W5121</b>	NO. 8200767762 - 8200361247 - 12303-00Q0A - 4449456 - 4431160 - 93198633 - 04431160 - 12303-00Q1D - 9316...		<b>W5137</b>	NO. 8200687605 - 8200699517 - 8200352613 - 8200395313 - 8200544135 - 8200552236 - 8200687605 - 820069951...
	POLIE DA CAMBOTA (7 PISTAS)			POLIE DA CAMBOTA 6 PISTAS	
RENAULT - MEGANE CC (EZ0/1_) - 2.0 dCi (EZ0L) Código do motor: M9R 610 (APÓS 06.10) 160cv 1995cc Cabriolet		RENAULT MEGANE CC (EZ0/1_) 1.6 16V (EZ0U - EZ1U) Código do motor: K4M.8.66 - Código do motor: K4M.8.58 (APÓS 06.10) 110cv 1598cc Cabriolet 4/5 - RENAULT MEGANE CC (EZ0/1_) 1.5 dCi (EZ09 - EZ1G - EZ0D) Código do motor: K9K.8.32 - Código do motor: K9K.8.37 - Código do motor: K9K.8.36/F - Variante de equipamento: +ALTR - Código do motor: K9K.8.36 (APÓS 06.10) 110cv 1461cc Cabriolet			
d155/157mm		31x38mm		d155mm	d26mm

	<p><b>A1075</b> NO. 7700785949</p> <p>SUPORTE FRENTE DIREITO DO MOTOR</p> <p>RENAULT MEGANE 1.4</p> <p>115x85x80mm 2p-d10-27mm 1p-d10-30mm</p>		<p><b>A1391</b> NO. 7700832257 - 7700832256</p> <p>APOIO DE MOTOR DIREITO (HIDRÁULICO)</p> <p>RENAULT MEGANE DIESEL</p> <p>170x140x120mm 1p-d10-30mm</p>
	<p><b>A1391-H</b> NO. 7700832257 - 7700832256</p> <p>APOIO DE MOTOR DIREITO (HIDRÁULICO)</p> <p>RENAULT MEGANE DIESEL</p> <p>175x150x120mm 1p-d10-30mm</p>		<p><b>A1551</b> NO. 7700425757 - 7700437391</p> <p>APOIO DO MOTOR FRENTE DIREITO</p> <p>RENAULT MEGANE 1.4 - 1.4 16V - 1.6 16V (APÓS 95) - MEGANE CLASSIC 1.4 - 1.4 16V - 1.6 16V (APÓS 96) - MEGANE COUPE 1.4 16V - 1.6 16V (APÓS 96) - MEGANE SCENIC 1.4 16V - 1.6 16V (APÓS 96)</p> <p>170x140x105mm NULL</p>
	<p><b>A1600</b> NO. 8200267624 - 8200185696 - 7700436287</p> <p>APOIO DO MOTOR LADO DIREITO</p> <p>RENAULT MEGANE SCENIC 1 1.9 DCi - 1.9 DTi (APÓS 2001)</p> <p>170x150x85mm 1p-d10-32mm</p>		<p><b>A1791</b> NO. 8200310006 - 8200035448</p> <p>APOIO DE ESCAPE</p> <p>RENAULT SCÉNIC II (JM0/1_) 1.6 (JM0C - JM0J - JM1B) (APÓS 06-2003) - 2.0 (JM05 - JM0U - JM1N - JM1U - JM2V) (APÓS 06-2003)</p> <p>100x100x70mm NULL</p>
	<p><b>BE25</b> NO.</p> <p>ABRAÇADEIRA DE ESCAPE CÔNCAVA (58 mm)</p> <p>RENAULT MEGANE (APÓS 1995)</p> <p>95x60x20mm 2p-d8mm</p>		<p><b>D0025</b> NO. 7701209352</p> <p>CARDAN EQUILIBRADOR DO VEIO DE TRANSMISSÃO</p> <p>RENAULT SCÉNIC I (JA0/1_) 2.0 16V RX4 (06.00 A 08.03) 139cv 1998cc Veículo multiuso - RENAULT SCÉNIC I (JA0/1_) 1.9 dCi RX4 (12.02 A 08.03) 101cv 1870cc Veículo multiuso - RENAULT SCÉNIC I (JA0/1_) 1.9 dCi RX4 (11.00 A 08.03) 102cv 1870cc Veículo multiuso</p> <p>d170x50mm d127mm 3f-d5mm 3f-d12mm 1f-d57mm</p>
	<p><b>E0202-M</b> NO. 7700849715</p> <p>ESTICADOR DO MOTOR TRÁS</p> <p>RENAULT MEGANE (APÓS 1998)</p> <p>168x81x45mm 1f-d10mm 1f-d10mm</p>		<p><b>E0204-M</b> NO. 7700832264</p> <p>ESTICADOR MOTOR</p> <p>RENAULT MEGANE DIESEL</p> <p>170x55x45mm 2f-d9.5mm</p>
	<p><b>E0206-M</b> NO. 8200100116</p> <p>ESTICADOR PARTE DE TRÁS DO MOTOR</p> <p>RENAULT MEGANE SCENIC (APÓS 1996) 16V - 1.9DTi - MEGANE (APÓS1995) 1.9DTi</p> <p>240x70x45mm 1f-d14mm 1f-d12mm</p>		<p><b>E0209-M</b> NO. 8200117837 - 8200171178 - 7700437854 - 7700432032 - 6001543360</p> <p>ESTICADOR DO MOTOR PARTE TRÁS</p> <p>RENAULT MEGANE 1.4 16V (APÓS 11-99) - 1.6 16V (APÓS 11-99) - MEGANE SCENIC 1.4 16V (APÓS 96)</p> <p>230x55x45mm 1f-d13mm 1f-d12mm</p>
	<p><b>E0217-M</b> NO. 8200014933 - 6001549205</p> <p>ESTICADOR DO MOTOR CENTRAL INFERIOR</p> <p>RENAULT MEGANE 2 1.4i - 1.6i - MEGANE SCENIC 2 (APÓS 07-2003) 1.4i - 1.6i</p> <p>270x90x60mm 2f-d13mm</p>		<p><b>E0223-M</b> NO. 7700432026 - 8200399539 - 8200432026</p> <p>ESTICADOR DO MOTOR</p> <p>RENAULT MEGANE CABRIOLET 2.0 (16V)(10-1996 A 11-1999) - 2.0i (APÓS 03-1999) - 2.0i (CAIXA AUTOMÁTICA)(APÓS 03-1999) - 2.0(CAIXA AUTOMÁTICA)(APÓS 04-1997)</p> <p>165x64x46mm 1f-d12mm 1f-d10mm</p>
	<p><b>E0223-M</b> NO. 7700432026 - 8200399539 - 8200432026</p> <p>ESTICADOR DO MOTOR</p> <p>RENAULT MEGANE CLASSIC 1.9 Dti (CAIXA AUTOMÁTICA)(03-1997 A 02-2001) - 1.9 Dci (CAIXA AUTOMÁTICA)(APÓS 02-2001) - 2.0i (CAIXA AUTOMÁTICA) (APÓS 09-1996)</p> <p>165x64x46mm 1f-d12mm 1f-d10mm</p>		<p><b>E0223-M</b> NO. 7700432026 - 8200399539 - 8200432026</p> <p>ESTICADOR DO MOTOR</p> <p>RENAULT MEGANE COACH 1.9 Dti (CAIXA AUTOMÁTICA)(03-1997 A 02-2001) - 2.0i(CAIXA AUTOMÁTICA)(APÓS 03-1996) - 2.0(16V)(03-1996 A 11-1999)</p> <p>165x64x46mm 1f-d12mm 1f-d10mm</p>



	<b>E0223-M</b> NO. 7700432026 - 8200399539 - 8200432026 ESTICADOR DO MOTOR RENAULT MEGANE GRANDTOUR 1.9 Dci(CAIXA AUTOMÁTICA) (APÓS 02-2001) - 1.9 Dti (03-1999 A 02-2001) 165x64x46mm 1f-d12mm 1f-d10mm		<b>E0223-M</b> NO. 7700432026 - 8200399539 - 8200432026 ESTICADOR DO MOTOR RENAULT MEGANE I 1.4 E (APÓS 01-1996) - 1.4 (16V)(APÓS 03-1999) - 1.6 E (01-1996 A 03-1999) - 1.6(16V) (APÓS 03-1999) 1.9 Dci (CAIXA AUTOMÁTICA) (APÓS 02-2001) - 1.9DTi (03-1997 A 02-2001) - 1.9D (APÓS 01-1996) - 2.0i (APÓS 01-1996) - 2.0(16V) (APÓS 07-19)           165x64x46mm 1f-d12mm 1f-d10mm
	<b>E0223-M</b> NO. 7700432026 - 8200399539 - 8200432026 ESTICADOR DO MOTOR RENAULT MEGANE SCENIC 1.6i (CAIXA AUTOMÁTICA)(01-1997 A 09-1999) - 1.9 Dti (CAIXA AUTOMÁTICA)(04-1997 A 09-1999) - 2.0i (CAIXA AUTOMÁTICA) (01-1997 A 09-1999) 165x64x46mm 1f-d12mm 1f-d10mm		<b>E0225-M</b> NO. 7700415095 ESTICADOR DO MOTOR PARTE DE TRÁS RENAULT MEGANE CLASSIC 1.4 (APÓS 09-1996) 158x60x46mm 2f-d10mm
	<b>E0225-M</b> NO. 7700415095 ESTICADOR DO MOTOR PARTE DE TRÁS RENAULT GRANDTOUR 1.4 (APÓS 03-1999) 158x60x46mm 2f-d10mm		<b>E0225-M</b> NO. 7700415095 ESTICADOR DO MOTOR PARTE DE TRÁS RENAULT MEGANE I 1.4 (APÓS 01-1996) 158x60x46mm 2f-d10mm
	<b>E0226-M</b> NO. 7700414827 - 7700840288 ESTICADOR DO MOTOR PARTE DE TRÁS RENAULT MEGANE CABRIOLET 2.0 (APÓS 04-1997) - 2.0i (APÓS 03-1999) 170x82x45mm 2f-d10mm		<b>E0226-M</b> NO. 7700414827 - 7700840288 ESTICADOR DO MOTOR PARTE DE TRÁS RENAULT MEGANE CLASSIC 1.9 DTi (03-1997 A 02-2001) - 2.0i (APÓS 03-1996) 170x82x45mm 2f-d10mm
	<b>E0226-M</b> NO. 7700414827 - 7700840288 ESTICADOR DO MOTOR PARTE DE TRÁS RENAULT MEGANE COACH 1.9 DTi (03-1997 A 02-2001) - 2.0i (APÓS 03-1996) 170x82x45mm 2f-d10mm		<b>E0226-M</b> NO. 7700414827 - 7700840288 ESTICADOR DO MOTOR PARTE DE TRÁS RENAULT MEGANE SCENIC 2.0i (01-1997 A 09-1999) 170x82x45mm 2f-d10mm
	<b>E0234</b> NO. 8200166159 ESTICADOR DA BARRA ESTABILIZADORA DA FRENTE RENAULT MEGANE II 1.4 16V (APÓS 11-2002) - 1.5 Dci (APÓS 11-2002) - 1.6 16V (APÓS 11-2002) - 1.9 Dci (APÓS 11-2002) - 2.0 (APÓS 09-2003) - 2.0 16V (APÓS 11-2002) 310x33x35mm 2p-d10-27mm		<b>E0234</b> NO. 8200166159 ESTICADOR DA BARRA ESTABILIZADORA DA FRENTE RENAULT SCÉNIC II 1.4 (APÓS 06-2003) - 1.5 Dci (APÓS 11-2003) - 1.6 (APÓS 06-2003) - 1.6 16V (APÓS 01-2007) - 1.9 Dci (APÓS 06-2003) 310x33x35mm 2p-d10-27mm
	<b>E0240-M</b> NO. 8200084942 ESTICADOR DO MOTOR RENAULT SCÉNIC 1.9 DCi RX4 - 2.0 16V RXR (2000 A 2003) 267x47x81mm 1f-d12mm 1f-d10mm		<b>E0246-M</b> NO. 8200042453 ESTICADOR DO MOTOR CENTRO INFERIOR RENAULT MEGANE II 1.5 Dci 82CV (K9K 722) (APÓS 11-2002) 265x90x52mm 1f-d12mm 1f-d13mm
	<b>E1061</b> NO. 1J0412249 - 1J0412331 - 1J0412331B - 1J0412331BS ESTICADOR DE ESCAPE RENAULT MEGANE (1995 A 1997) 51x48x29mm 1f-d10mm		<b>E1065</b> NO. 7700412282 ESTICADOR DE ESCAPE RENAULT MEGANE (1995 A 1997) 92 30 25mm NULL

	<p><b>E1093</b> NO. 7700434978</p> <p>ESTICADOR DE ESCAPE</p> <p>RENAULT MAGANE (09-1998 A 02-2001) - SCENIC (APÓS 2000) 1.9 Dci 4X4 - 2.0 16V 4X4</p> <p>d65x45mm 1f-d12.6mm</p>		<p><b>F1687-I</b> NO. 7701469486 - 7701469487</p> <p>FOLE DA DIREÇÃO ASSISTIDA DIREITO E ESQUERDO</p> <p>RENAULT MEGANE (APÓS 1998)</p> <p>d75x175mm d57mm 1f-d41mm 1f-d11mm</p>
	<p><b>F1827A-I</b> NO. 7701468573 - 7701470566</p> <p>FOLE DA TRANSMISSÃO JUNTO À CAIXA</p> <p>RENAULT SCÊNIC I 1.9 DCi - 1.9 DTi - 2.0i 16V (APÓS 1999)</p> <p>d115x85mm 1f-d81mm 1f-d27.8mm</p>		<p><b>KF2529-T</b> NO. 7701469021</p> <p>KIT DE FOLE DO CARDAN JUNTO À RODA</p> <p>RENAULT SCENIC I 1.9 TDi - 2.0i 16V (APÓS 1999)</p> <p>d110x140mm 1f-d88mm 1f-d27mm</p>
	<p><b>KF2538-T</b> NO.</p> <p>KIT DE FOLE</p> <p>RENAULT MEGANE</p> <p>d88x130mm 1f-d78mm 1f-d35mm</p>		<p><b>KL0008</b> NO. 770078304 - 7700662571</p> <p>KIT DE CASQUILHOS DA DIREÇÃO ASSISTIDA</p> <p>RENAULT MEGANE</p> <p>d61x49mm 1f-d47mm</p>
	<p><b>M6076</b> NO. 7700823540</p> <p>JUNTA DE ESCAPE</p> <p>RENAULT MEGANE (APÓS 1996)</p> <p>120x80mm 1f-d60mm</p>		<p><b>Q2009</b> NO.</p> <p>UNIÃO DE ESCAPE 48/45x80mm</p> <p>RENAULT - SCÊNIC II (JM0/1_) - 1.4 (JM0B - JM0H - JM1A) (APÓS 06.03) 98cv 1390cc Veículo multiuso - RENAULT - SCÊNIC II (JM0/1_) - 1.6 16V (JM1R) (APÓS 10.05) 112cv 1598cc Veículo multiuso - RENAULT - SCÊNIC II (JM0/1_) - 1.6 (JM0C - JM0J - JM1B) (APÓS 06.03)</p> <p>80x77x55mm 1f-d45/48mm</p>
	<p><b>R8063</b> NO. 7702255624 - 7700437651</p> <p>TUBO DO ARREFECIMENTO</p> <p>RENAULT MEGANE</p> <p>B475-d17/17mm 70-80-35-130-75-70-65-120mm</p>		<p><b>R8064</b> NO. 7700829998 - 7700436889</p> <p>TUBO SUPERIOR DO RADIADOR</p> <p>RENAULT MEGANE 1.9 TDi - 1.9 TD - 2.0</p> <p>B480-d30/30mm 105-160-150-125mm</p>
	<p><b>R8065</b> NO. 7700793249 - 7700790231</p> <p>TUBO SUPERIOR DO RADIADOR</p> <p>RENAULT MEGANE</p> <p>B370-d35/31mm 80-130-140-80mm</p>		<p><b>R8066</b> NO. 7700418255 - 7700829986</p> <p>TUBO SUPERIOR DO RADIADOR</p> <p>RENAULT MEGANE 1.4 - 1.6 - (APÓS 1997)</p> <p>B350-d32/32mm 120-100-80-105mm</p>
	<p><b>R8067</b> NO. 7700878100 - 7700273943 - 7700829993</p> <p>TUBO DO ARREFECIMENTO</p> <p>RENAULT MEGANE - SCENIC 1.4 - 1.6 (APÓS 1996)</p> <p>B520-d20/20mm 50-105-175-60-65-130mm</p>		<p><b>R8068</b> NO. 7700025345 - 6001025345</p> <p>TUBO DO ARREFECIMENTO</p> <p>RENAULT MEGANE</p> <p>B390-d25/25mm 55-60-100-80-80-80mm</p>
	<p><b>RF5011</b> NO. 7700870330</p> <p>TUBO DE FERRO RADIADOR</p> <p>RENAULT MEGANE 1.6 (MOTORES K7M 702-703) COM JUNTA TÓNICA</p> <p>B365-d26/28mm 335-90mm+ch75-d13mm+ch45-d17mm</p>		<p><b>RT08495</b> NO. 7700834863 - 7704003961</p> <p>TUBO DE TRAVÃO TRÁS LH-RH</p> <p>RENAULT MEGANE - SCENIC - TT (APÓS 01-1996)</p> <p>280mm FZ - FZ</p>

	<b>RT08633</b> NO. 7700840390 TUBO DE TRAVÃO FRENTE LH-RH RENAULT MEGANE - SCENIC - TT (APÓS 01-1996)		<b>RT80213</b> NO. 8200234737 - 8200333851 TUBO DE TRAVÃO FRENTE RH RENAULT SCENIC II 1.4 (APÓS 06-2003) - 1.5 DCi (APÓS 06-2003) - 1.6 (APÓS 06-2003) - 1.9 DCi (APÓS 06-2003) - 2.0 (APÓS 06-2003) - 2.0 16V TURBO (APÓS 05-2004) - 2.0 DCi (APÓS 09-2005)
	<b>S1336</b> NO. 7700789477 SILENT-BLOC DA SUSPENSÃO DA FRENTE (PARTE DE TRÁS E FRENTE) RENAULT MEGANE SCENIC 2.0 16V (APÓS 1995)		<b>S1487</b> NO. 8200242025 SILENT BLOC DO BRAÇO DA SUSPENSÃO DA FRENTE RENAULT SCÉNIC II 1.4 (APÓS 06-2003) - 1.5 DCi (06-2003 A 11-2003) - 1.6 (APÓS 06-2003) - 1.9 DCi (APÓS 06-2003) - 2.0 (APÓS 06-2003) - 2.0 16V TURBO (APÓS 05-2004)
	<b>S1488</b> NO. 8200041166 SILENT BLOC DO BRAÇO DA SUSPENSÃO DA FRENTE RENAULT SCÉNIC II 1.4 (APÓS 06-2003) - 1.5 DCi (06-2003 A 11-2003) - 1.6 (APÓS 06-2003) - 1.9 DCi (APÓS 06-2003) - 2.0 (APÓS 06-2003) - 2.0 16V TURBO (APÓS 05-2004)		<b>S1520</b> NO. 7700436707 SILENT BLOC DO EIXO TRASEIRO RENAULT SCÉNIC I (JA0-1_) 1.9 dCi RX4 (F9Q 740) 102CV (11-2000 A 08-2003) - 2.0 16V RX4 (F4R 744 - F4R 746) 139CV (06-2000 A 08-2003)
	<b>T0615-I</b> NO. 6030227 BATENTE DA SUSPENSÃO DA FRENTE RENAULT MEGANE		<b>T1048</b> NO. 7700835929 BATENTE DO CENTRO DA BARRA ESTABILIZADORA RENAULT MEGANE
	<b>U7010</b> NO. 8200059541 TENSORES CORREIA ALTERNADOR RENAULT MEGANE 1.9 TD		<b>UEF51120</b> NO. 8200105517 TUBO FLEXIVEL DE ESCAPE RENAULT SCÉNIC II 1.6 113CV (APÓS 06-2003)
	<b>W5000</b> NO. 8200386445 - 7700112999 - 7700724249 - 7700107145 - 7700864763 - 8200545437 - 8200689705 - 770073990... POLIE DA CAMBOTA (6 pistas) RENAULT MEGANE - SCENIC		<b>W5017</b> NO. 7700115309 - 7700110329 - 7700113018 - 8200689702 - 4418147 - 93192606 - 4402569 - 9110569 POLIE DA CAMBOTA (6 pistas) RENAULT MEGANE - SCENIC - 1.9 DTI - mot F9Q
	<b>W5019</b> NO. 12303-00Q0J - 12303-00QAU - 12303-00QBA - 12303AY600 - 12303-BN700 - 8200392697 POLIE DA CAMBOTA (5 pistas) RENAULT SCENIC II 1.5 Dci - 1.6 16V (APÓS 06-2003)		<b>W5037</b> NO. 7700105707 POLIE DA BOMBA DA DIRECÇÃO (6 PISTAS) RENAULT MEGANE APÓS 1996 - SCENIC APÓS 1997
	<b>W5060</b> NO. 7700863215 POLIE DA CAMBOTA (6 PISTAS) RENAULT MEGANE		<b>W5062</b> NO. 7700109260 - 8200458960 - 7700738072 - 7700747282 - 8200689705 - 7700739905 POLIE DA CAMBOTA (6 PISTAS) RENAULT MEGANE

	<p><b>W5062</b> NO. 7700109260 - 8200458960 - 7700738072 - 7700747282 - 8200689705 - 7700739905</p> <p>POLIE DA CAMBOTA (6 PISTAS)</p> <p>RENAULT SCENIC</p> <p>d122mm d12.6mm</p>		<p><b>W5067</b> NO. 7700105321 - 7700101242 - 8200313231 - 8200392683 - 8000544153 - 7700105788 - 8200044050 - 820055764...</p> <p>POLIE DA CAMBOTA (6 PISTAS)</p> <p>RENAULT MEGANE</p> <p>d133mm d26mm</p>
	<p><b>W5067</b> NO. 7700105321 - 7700101242 - 8200313231 - 8200392683 - 8000544153 - 7700105788 - 8200044050 - 820055764...</p> <p>POLIE DA CAMBOTA (6 PISTAS)</p> <p>RENAULT SCENIC</p> <p>d133mm d26mm</p>		<p><b>W5068</b> NO. 7700115766 - 8200386446 - 7700113776 - 8200386451 - 8200079183 - 8200689705 - 7700739905 - 4413749 - ...</p> <p>POLIE DA CAMBOTA (6 PISTAS)</p> <p>RENAULT MEGANE</p> <p>d151/155mm d12.6mm</p>
	<p><b>W5071</b> NO. 7700856673</p> <p>POLIE DA CAMBOTA (6 PISTAS)</p> <p>RENAULT MEGANE - SCENIC 1.9 Dci</p> <p>d132mm d12.6mm</p>		<p><b>W5075</b> NO. 8200386453 - 8200072415 - 7700108401</p> <p>POLIE DA CAMBOTA (5 PISTAS)</p> <p>RENAULT MEGANE - SCENIC 5.0 16V (F4R)</p> <p>d122.9mm d28.6mm</p>
	<p><b>W5077</b> NO. 8200392683</p> <p>POLIE DA CAMBOTA (6 PISTAS)</p> <p>RENAULT SCENIC II - MEGANE IIII</p> <p>d133.6mm d26mm</p>		<p><b>W5088</b> NO. 8200523061</p> <p>POLIE DA CAMBOTA (6 PISTAS)</p> <p>RENAULT GRAND SCENIC 1.9 DCI APÓS 04-2004 - MEGANE II 1.9 DCI APÓS 03-2004 - SCENIC II 1.9 DCI APÓS 06-2003</p> <p>d151mm d24.5mm</p>
	<p><b>W5108</b> NO. 8200392697</p> <p>POLIE DA CAMBOTA (5 PISTAS)</p> <p>RENAULT SCÉNIC II 1.4 (JM0B - JM0H - JM1A)(K4J 730) 98CV (APÓS 06-2003) - 1.5 dCi (JM02 - JM13)(K9K 728) 101CV (APÓS 11-2003) - 1.5 dCi (JM0F)(K9K 722) 82CV (APÓS 06-2003) - 1.5 dCi (JM1F)(K9K 724) 86CV (APÓS 05-2005) - 1.6 (JM0C - JM0J - JM1B)(K4M 761 - K4</p> <p>NULL d153.4mm 1f-d26mm</p>		<p><b>Z80474</b> NO. 7703077068</p> <p>Mola de painel</p> <p>RENAULT MEGANE</p> <p>d18.5x13.5mm 1p-d7-12mm</p>
	<p><b>Z80533</b> NO. 7543023 - 7703081019 - 9759904480</p> <p>Mola de retenção</p> <p>RENAULT MEGANE</p> <p>10x17x10mm 1p-7.2x14-9mm 1f-d4.2mm</p>		<p><b>Z80583</b> NO. 7703077117</p> <p>Mola de painel</p> <p>RENAULT MEGANE</p> <p>d20x15.5mm 1p-d7.5-13.5mm</p>
	<p><b>Z80608</b> NO. 7703077225 - 7518N8</p> <p>Mola de painel</p> <p>RENAULT MEGANE</p> <p>d35x25mm 1p-d10.7-22.5mm</p>		<p><b>Z80629</b> NO. 7703077250</p> <p>Mola de painel</p> <p>RENAULT MEGANE</p> <p>d15x19mm 1p-d8.5-12.5mm</p>
	<p><b>Z80670</b> NO. 7703077341</p> <p>Mola de friso</p> <p>RENAULT MEGANE</p> <p>33x10x8mm NULL</p>		<p><b>Z80671</b> NO. 7703081190</p> <p>Mola de fixação</p> <p>RENAULT MEGANE</p> <p>d10x12mm 1p-d8-10mm 1f-d5.5mm</p>

	<b>Z80691</b> NO. 7701040837 Mola de friso RENAULT MEGANE		<b>Z80737</b> NO. 7703077435 Mola de painel RENAULT SCENIC
	NULL NULL		d35.5x25.5mm 1p-d12.5-22.5mm
	<b>Z80737</b> NO. 7703077435 Mola de painel RENAULT MEGANE		<b>Z80754</b> NO. 6991S6 Mola de painel RENAULT SCENIC
	d35.5x25.5mm 1p-d12.5-22.5mm		d18x18mm 1p-10.5x7.8-10mm
	<b>Z80838</b> NO. 6991.Y8 - 7703077468 - 7703077469 - 8201112162 Mola RENAULT SCENIC		
	d17x18.5mm 1p-d7.5-10.5mm		

## RENAULT MODUS

	<b>E0235</b> NO. 8200127308 - 8200605381 - 54618-AX600 ESTICADOR DA BARRA ESTABILIZADORA DA FRENTE RENAULT MODUS 1.2 (APÓS 12-2004) - 1.4 (APÓS 12-2004) - 1.5 Dci (APÓS 05-2005) - 1.6 (APÓS 12-2004)		<b>E0242-M</b> NO. 8200338385 ESTICADOR DO MOTOR CENTRO INFERIOR RENAULT MODUS - GRAND MODUS 1.2 16V Hi-Flex 75CV (D4F 740) (APÓS 10-2008) - 1.4 98CV (K4J 770) (APÓS 12-2004) - 1.5 Dci 82CV (K9K 750) (APÓS 09-2004) - 1.5 Dci 65CV (K9K 752) (APÓS 12-2004) - 1.5 Dci 86CV (K9K 760) (APÓS 12-2004) - 1.5 Dci 68CV (K9K 762)
	275x34x33mm 2p-d10-22mm		270x90x52mm 1f-d12mm 1f-d13.8mm
	<b>RT80212</b> NO. 8200129954 - 8200597210 TUBO DE TRAVÃO FRENTE LH-RH RENAULT MODUS TT (APÓS 12-2004)		<b>S1515</b> NO. 8200742906 SILENT BLOC DA SUSPENSÃO DE TRÁS PARTE DA FRENTE RENAULT MODUS - GRAND MODUS (F/JP0_) 1.2 (D4F 786) 103CV (APÓS 04-2011) - 1.2 (FP0C - FP0K - FP0P) (D4F 740) 65CV (APÓS 05-2005) - 1.2 (JP0C - JP0K - FP0C - FP0K - FP0P - JP0P - JP0T) (D4F 740) 75CV (APÓS 12-2004) - 1.2 (JP0S) (D4F 764) 78CV (APÓS 12-2004) - 1.2 1
	480mm FZ - MC11		d53x80mm c55mm d40,5mm 1f-d16,8mm
	<b>T0617-I</b> NO. 540503701R BATENTE SUSPENSÃO FRENTE RENAULT MODUS / GRAND MODUS (F/JP0_) 1.2 (FP0C - FP0K - FP0P) (APÓS 05.05) 65cv 1149cc Hatchback - RENAULT MODUS / GRAND MODUS (F/JP0_) 1.2 16V Hi-Flex (APÓS 10.08) 75cv 1149cc Hatchback - RENAULT MODUS / GRAND MODUS (F/JP0_) 1.2 (JP0S) (APÓS 12.04) 78cv 1149cc Hatchback - RENAULT MODUS / GRAND MODUS (F/JP0_) 1.2 (APÓS 04.11) 103cv 1149cc Hatchback - RENAULT MODUS / GRAND MODUS (F/JP0_) 1.4 (JP01 - JP0J) (APÓS 12.04) 98cv 1390cc Hatchba...etc.		<b>T0617-I</b> NO. 540503701R BATENTE SUSPENSÃO FRENTE RENAULT MODUS / GRAND MODUS (F/JP0_) 1.2 (FP0C - FP0K - FP0P) (APÓS 05.05) 65cv 1149cc Hatchback - RENAULT MODUS / GRAND MODUS (F/JP0_) 1.2 16V Hi-Flex (APÓS 10.08) 75cv 1149cc Hatchback - RENAULT MODUS / GRAND MODUS (F/JP0_) 1.2 (JP0S) (APÓS 12.04) 78cv 1149cc Hatchback - RENAULT MODUS / GRAND MODUS (F/JP0_) 1.2 (APÓS 04.11) 103cv 1149cc Hatchback - RENAULT MODUS / GRAND MODUS (F/JP0_) 1.4 (JP01 - JP0J) (APÓS 12.04) 98cv 1390cc Hatchba...etc.
	d51x80mm 1f-d24mm 1f-d17mm		d51x80mm 1f-d24mm 1f-d17mm
	<b>W5019</b> NO. 12303-00Q0J - 12303-00QAU - 12303-00QBA - 12303AY600 - 12303-BN700 - 8200392697 POLIE DA CABBOTA (5 pistas) RENAULT MODUS 1.4 16V - 1.5 Dci - 1.6 16V (APÓS 12-2004)		<b>W5106</b> NO. 8200477938 - 8200511194 - 8200185800 - 8200184103 POLIE DA CABBOTA (6 PISTAS) RENAULT MODUS-GRAND MODUS 1.4 (JP01 - JP0J) (K4J 770) 98CV (APÓS 12-2004) - 1.5 dCi (FP0F - JP0F) (K9K 760) 86CV (APÓS 12-2004) - 1.6 (JP03 - JP0B - JP0U - JP0Y - JP1G) (K4M 790 - K4M 800) 112CV (APÓS 12-2004) - 1.6 (JP0L - JP0V) (K4M 794) 88CV (APÓS 12-2004)
	d152.3mm d26mm		d155/151mm d26mm















	<b>W5108</b>	NO. 8200392697		<b>W5111</b>	NO. 8200352613 - 8200552236 - 8200699517 - 8200544135 - 8200687605 - 8200395313 - 7700105788 - 820004405...
	POLIE DA CAMBOTA (5 PISTAS)			POLIE DA CAMBOTA(6 PISTAS)	
RENAULT MODUS - GRAND MODUS 1.2(D4F 786) 103CV (APÓS 04-2011) - 1.2 (JP0C - JP0K - FP0C - FP0K - FP0P - JP0P - JP0T)(D4F 740) 75CV (APÓS 12-2004) - 1.2 (JP0S)(D4F 764) 78CV (APÓS 12-2004) - 1.2 16V Hi-Flex(D4F 740) 75CV (APÓS 10-2008) - 1.2 16V (JP0W)(D4F			RENAULT MODUS - GRAND MODUS (F-JP0_) 1.5 dCi (JP0G - JP0H) (K9K 764) 106CV (APÓS 05-2005)		
NULL		d153.4mm 1f-d26mm	d155-151mm		d26mm
	<b>W5137</b>	NO. 8200687605 - 8200699517 - 8200352613 - 8200395313 - 8200544135 - 8200552236 - 8200687605 - 820069951...			
	POLIE DA CAMBOTA 6 PISTAS				
RENAULT MODUS/GRAND MODUS (F/JP0_) 1.4 (JP01 - JP0J) Código do motor: K4J.7.80 - Variante de equipamento: +AC - Código do motor: K4J.7.70 (APÓS 12.04) 98cv 1390cc Hatchback - RENAULT MODUS/GRAND MODUS (F/JP0_) 1.6 (JP0L - JP0V) Código do motor: K4M.7.94 - Variante de equipamento: +AC (APÓS 12.04) 88cv 1598cc Hatchback - RENAULT MODUS/GRAND MODUS (F/JP0_) 1.6 (JP03 - JP0B - JP0U - JP0Y - JP1G) Ano fabric. a partir de: 03.08 - Código do mot...etc.					
d155mm		d26mm			



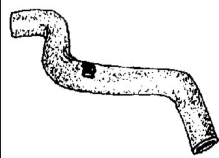
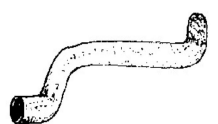
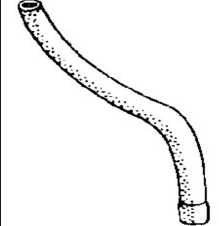

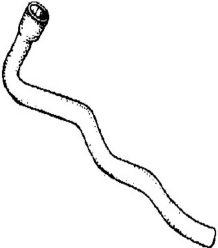
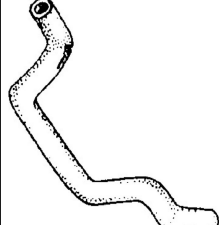





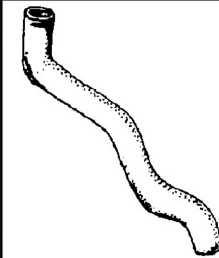

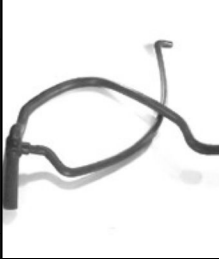

RENAULT R19

	<b>A1033</b>	NO. 7700801543		<b>A1034</b>	NO. 7700804163 - 7702253382
	SUPORTE FRENTE ESQUERDO DO MOTOR			SUPORTE TRÁS CENTRAL DO MOTOR	
RENAULT R19 TT (EXCP. DIESEL)			RENAULT R19 TT (EXCP. DIESEL)		
100x72x52mm		1p-d10-30mm 1p-d10-26mm	165x155x120mm		1f-d11mm
	<b>A1075</b>	NO. 7700785949		<b>A1171</b>	NO. 7700802927 - 7700788383
	SUPORTE FRENTE DIREITO DO MOTOR			SUPORTE DIREITO DO MOTOR	
RENAULT R19 TT (EXCP. DIESEL)			RENAULT R19 DIESEL		
115x85x80mm		2p-d10-27mm 1p-d10-30mm	150x92x85mm		1p-d10-29mm
	<b>A1199</b>	NO. 7700788318		<b>A1325</b>	NO. 7702224432 - 7700835254
	APOIO ESQUERDO DO MOTOR			SUPORTE DO AMORTECEDOR DA FRENTE	
RENAULT R19 DIESEL			RENAULT R19		
123x70x48mm		1f-d12mm	190x156x55mm		1f-d15mm
	<b>BB13</b>	NO. 7700774895		<b>BE22</b>	NO.
	ABRAÇADEIRA DA BARRA ESTABILIZADORA			ABRAÇADEIRA ESCAPE	
RENAULT R19			RENAULT R19		
65x50x35mm		NULL	96x100x18mm		1p-d10-75mm
	<b>BE25</b>	NO. 7701458595 - 7701450595		<b>E0037</b>	NO. 7700785798
	ABRAÇADEIRA DE ESCAPE CÔNCAVA (58 mm)			SUPORTE DE ESCAPE	
RENAULT R19 (1994 A 1996)			RENAULT R19		
95x60x20mm		2p-d8mm	50x50x28mm		NULL

	<b>E0200-M</b> NO. 7700411638 ESTICADOR DA SUSPENSÃO DO MOTOR (CAIXA) RENAULT R19 - R19 DIESEL 165x66x46mm 2f-d10mm		<b>F0906-I</b> NO. 7700745663 FOLE DO LADO DA RODA (JUNTA d90mm EIXO d25mm) RENAULT R19 d103x83mm 1f-d80mm 1f-d22mm
	<b>F1066</b> NO. 7701466120 FOLE DA TRANSMISSÃO JUNTO À RODA RENAULT R19 d91x122mm 1f-d83mm 1f-d34mm		<b>F1069</b> NO. 7701465489 FOLE DO CARDAN JUNTO À RODA RENAULT 19 d95x150mm 1f-d90mm 1f-d35mm
	<b>F1089-I</b> NO. FOLE DA TRANSMISSÃO LADO DA RODA RENAULT 19 1.4 - 1.7 - 1.8 -1.9 DIESEL (APÓS 9-1988) d93x110mm 1f-d80mm 1f-d22mm		<b>F1329-I</b> NO. 7701472212 - 7701466349 - 7701470299 FOLE DA TRANSMISSÃO JUNTO À CAIXA RENAULT 19 I 1.4 - 1.8 - 1.8i - 1.8i 16V - 1.9 D (1988 A 1992) d86x102mm 1f-d73mm 1f-d26mm
	<b>F1329-II</b> NO. 7701472212 - 7701466349 - 7701470299 FOLE DA TRANSMISSÃO JUNTO À CAIXA RENAULT 19 II 1.8 - 1.8i - 1.9 D (1991 A 1996) d86x102mm 1f-d73mm 1f-d26mm		<b>H537</b> NO. PALA ORIGINAL RENAULT R19 250x200mm NULL
	<b>KB2064</b> NO. KIT DA BARRA ESTABILIZADORA (DIÂMETRO 23) RENAULT R19 NULL NULL		<b>KF2529-T</b> NO. 7701469021 KIT DE FOLE DO CARDAN JUNTO À RODA RENAULT 19 I 1.4 - 1.4i - 1.7 - 1.7 L53F - 1.7i - 1.8 16V - 1.8i - 1.8i 16V - 1.9D - 1.9 DT - 1.9 TD - 1.9 TD L53K (1988 A 1992) - RENAULT 19 II 1.4i - 1.7i - 1.8i - 1.9D - 1.9 DT (1991 A 1996) d110x140mm 1f-d88mm 1f-d27mm
	<b>KF2531-T</b> NO. 7701466120 FOLE DO LADO DA RODA RENAULT R19 TS - GTS - TSE - RT 1.4 - 1.7 I d90x140mm 1f-d33mm 1f-d70mm		<b>KF2532</b> NO. 7701034800 - 7701467125 FOLE DO LADO DA RODA RENAULT R19 d94x138mm 1f-d24mm 1f-d82mm
	<b>KF2534</b> NO. KIT DE FOLE RENAULT R19 d95x128mm 1f-d80mm 1f-d26mm		<b>KF2560</b> NO. 7701463643 FOLE DO LADO DA RODA RENAULT R19 TR - GRT - TRE d87x83mm 1f-d20mm 1f-d75mm
	<b>KL0008</b> NO. 770078304 - 7700662571 KIT DE CASQUILHOS DA DIRECÇÃO ASSISTIDA RENAULT 19 d61x49mm 1f-d47mm		<b>M6000</b> NO. 7700797807 JUNTA DE ESCAPE RENAULT R19 d67x11.5mm 1f-d52mm



	<p><b>M6051</b> NO. 7700766353 - 7700782519 - 6025308326 - 7700766355 - 3445663 - 3458510</p> <p>JUNTA DE ESCAPE</p> <p>RENAULT R19 (1988 A 1996)</p> <p>d89x12.2mm 1f-d74.5mm</p>		<p><b>M6052</b> NO. 7700781679 - 7700782520 - 8932001367 - 8933000112</p> <p>JUNTA DE ESCAPE</p> <p>RENAULT R19 (1986 A 1996)</p> <p>d67x13.8mm 1f-d49.6mm</p>
	<p><b>M6053</b> NO. 7700774367</p> <p>JUNTA DE ESCAPE</p> <p>RENAULT R19 (APÓS 1988)</p> <p>105x75mm 1f-d55mm</p>		<p><b>M6503</b> NO. 7700852033</p> <p>JUNTA DO CARBORADOR</p> <p>RENAULT 19</p> <p>128x128x20mm NULL</p>
	<p><b>MT6700</b> NO.</p> <p>JUNTA DE TERMOSTATO</p> <p>RENAULT R19 1.9 D - R19 1.2 1.8i - 16V - R19 1.7</p> <p>d52x2mm 1f-d43mm</p>		<p><b>R220676</b> NO. 7700790240</p> <p>TUBO INFERIOR DO RADIADOR</p> <p>RENAULT R19 1378cc - 1278cc</p> <p>B400-d33/40mm 115-180-110-80mm</p>
	<p><b>R220677</b> NO. 7700790231 - 7700793619</p> <p>TUBO DE RADIADOR SUPERIOR C/ RESPIRO</p> <p>RENAULT R19 TS - GTS</p> <p>B380-d33/33mm 70-110-95-95-95mm</p>		<p><b>R220678</b> NO. 7700790234 - 7700793617</p> <p>TUBO DE RADIADOR INFERIOR C/ PROTECÇÃO DE BORRACHA</p> <p>RENAULT R19 TS - GTS</p> <p>B350-d30/30mm 60-100-210-70mm</p>
	<p><b>R220679</b> NO. 7700787606</p> <p>TUBO DE RADIADOR SUPERIOR</p> <p>RENAULT R19 GTX - TSE - TXE - GTE</p> <p>B425-d33/33mm 85-60-70-50-165-70mm</p>		<p><b>R220680</b> NO. 7700795305 - 7700796216</p> <p>TUBO DE RADIADOR INFERIOR 3 VIAS</p> <p>RENAULT R19 GTX - TSE - TXE - GTE-TD - GTD - TDE</p> <p>B320-d30/30mm 240-130-75/d17mm 60-60-60-70mm</p>
	<p><b>R220681</b> NO. 7700790238 - 7700793247</p> <p>TUBO DE RADIADOR SUPERIOR C/ PROTECÇÃO</p> <p>RENAULT R19-TD - GTD - TDE</p> <p>B460-d33/33mm 120-95-140-150-75mm</p>		<p><b>R220683</b> NO. 7700790237</p> <p>TUBO DO AQUECIMENTO</p> <p>RENAULT R19-TS - GTS</p> <p>B475-d17/17mm 80-150-140-60-60-65mm</p>
	<p><b>R220684</b> NO. 7700787607</p> <p>TUBO DO AQUECIMENTO</p> <p>RENAULT R19-TS - GTS</p> <p>B390-d24/24mm 50-70-100-90-65-120mm</p>		<p><b>R220686</b> NO. 7700791142</p> <p>TUBO DE LIGAÇÃO DO TERMOSTATO AO DEPÓSITO DE ARREFECIMENTO</p> <p>RENAULT 19 TS - GTS - TSE - 1.4</p> <p>B355-d10/10mm 50-260-80mm</p>
	<p><b>R221652</b> NO. 7700739814</p> <p>TUBO PARA CARBURADOR MONOCORPO</p> <p>RENAULT 19 TSE - CLIO 1.2</p> <p>B150-d13/11mm 50-90-65-65mm</p>		<p><b>R221653</b> NO. 7700745411 - 7705026798</p> <p>TUBO DE ARREFECIMENTO DO ÓLEO</p> <p>RENAULT R19 (1.4 ENERGY)</p> <p>B50-d17-d17mm 50-50-50mm</p>

	<b>R221654</b> NO. 7700739813 TUBO PARA CARBURADOR MONOCOROPO RENAULT R19 - CLIO (1.2) B195-d13/7mm 75-220-45mm		<b>R221657</b> NO. 7700792372 TUBO DE LIGAÇÃO AO DEPÓSITO RENAULT R19 (1.4) B405-d21/21mm 65-105-110-80-85mm
	<b>R8050</b> NO. 7702253170 TUBO INFERIOR DO RADIADOR RENAULT 19 B425-d32/39mm d25mm 80-155-120-85-75mm 370-265-60mm		<b>R8051</b> NO. 7702253169 - 7702218573 TUBO DE LIGAÇÃO AO DEPÓSITO DE ARREFECIMENTO RENAULT 19 B530-d17/17mm d10mm 80-90-80-75-210-285-75-60mm 60-60-660-50mm
	<b>R8052</b> NO. 7700794159 TUBO INFERIOR DO RADIADOR RENAULT 19 D S- AR CONDICIONADO B75-d32/29mm d19mm 120-145-65/75-165-55mm 105mm		<b>R8053</b> NO. 7700795304 TUBO INFERIOR DO RADIADOR RENAULT 19 GTX - TXE - TXI (1.7-1.8) AIRE C- AR CONDICIONADO B70-d30/30mm d17mm 45-45-80-90-200-75mm 130mm
	<b>R8054</b> NO. 7700271097 - 7700795303 TUBO INFERIOR DO RADIADOR RENAULT 19 (1.8) AIRE C- AR CONDICIONADO B125-d32/30mm d12mm 50-40-65-85-145-55-45-50mm 130mm		<b>R8055</b> NO. 7700795657 TUBO DE LIGAÇÃO AO DEPÓSITO DO ARREFECIMENTO RENAULT 19 DIESEL B435-d24/24mm B255-d115-115mm 125-115mm 155-90-50mm
	<b>R8141</b> NO. 7700832756 TUBO PERMUTADOR AQUECIMENTO RENAULT 19 I Chamade (L53_) 1.9 TD (L53K) (09.90 A 04.92) 92cv 1870cc três volumes B240-14/20mm 120-80-80-50mm 1ch-d17mm 50-80-70mm		<b>R8141</b> NO. 7700832756 TUBO PERMUTADOR AQUECIMENTO RENAULT 19 II (B/C53_) 1.9 dT (B/C53T) (04.92 A 12.95) 90cv 1870cc Hatchback - RENAULT 19 II Chamade (L53_) 1.9 dT (L53T) (04.92 A 12.95) 90cv 1870cc três volumes B240-14/20mm 120-80-80-50mm 1ch-d17mm 50-80-70mm
	<b>RF5000</b> NO. 7700859397 TUBO DE FERRO RADIADOR RENAULT 19 MOTOR E6J TSE - E7J 700 - 1.4i - (COM JUNTA TÓRICA) B365-d27/27mm 310-90mm+ch70-d13mm+ch45-d16mm		<b>RF5003</b> NO. 7700860371 TUBO DE FERRO RADIADOR RENAULT R19 B415-d18/18mm 85-275-120+B385-d13/13mm-100-255-65-65mm
	<b>RF5004</b> NO. 7700864993 TUBO DE FERRO RADIADOR RENAULT R19 B420-d17/17mm 70-55-70-80-65-50-150-50mm+B240-d13		<b>RF5005</b> NO. 7700860386 TUBO DE FERRO RADIADOR RENAULT R19 B455-d17/17mm 70-200-65-200-50mm+ch105-d14mm+ch30-d14mm
	<b>RF5006</b> NO. 7700859379 TUBO DE FERRO RADIADOR RENAULT R19 B325-d17/17mm 60-270-45-80mm		<b>RF5007</b> NO. 7700742245 - 7700860374 TUBO DE FERRO RADIADOR RENAULT R19 B325-d17/17mm 65-265-65-80mm+B260-d13/13mm-255-55mm+ch35-



	<p><b>RF5009</b> NO. 7700860376</p> <p>TUBO DE FERRO RADIADOR</p> <p>RENAULT R19 DIESEL</p>		<p><b>RT08494</b> NO. 7704003958 - 6025307608</p> <p>TUBO DE TRAVAO FRENTE LH-RH</p> <p>RENAULT R19 (COM ABS) 1.2 (01-1988 A 12-1995) 1.4 (01-1988 A 12-1995) 1.7 (09-1988 A 12-1995) - 1.8 (04-1992 A 06-1996) - 1.8 16V (06-1989 A 06-1996) - 1.9D (09-1988 A 12-1995) - 1.9DT (04-1992 A 12-1995)</p>
	<p><b>RT08495</b> NO. 7700834863 - 7704003961</p> <p>TUBO DE TRAVÃO TRÁS LH-RH</p> <p>RENAULT R19 TT (1988 A 1996)</p>		<p><b>RT08501</b> NO. 7701349305 - 7704001950 - 7704003549 - 7700541132 - 7704003931</p> <p>TUBO DE TRAVÃO TRÁS LH-RH</p> <p>RENAULT R19 TT (1988 ATÉ1996)</p>
	<p><b>RT08637</b> NO. 7700416273</p> <p>TUBO DE TRAVÃO TRÁS LH-RH</p> <p>RENAULT R19 TT (1988 A 1992)</p>		<p><b>S1102</b> NO. 7700799065D - 7700799064</p> <p>SILENT-BLOC DO TRAPÉZIO DIREITO</p> <p>RENAULT R19 TT</p>
	<p><b>S1103</b> NO. 7700799065</p> <p>SILENT-BLOC TRÁS DO TRAPÉZIO DA SUSPENSÃO FRENTE</p> <p>RENAULT R19 TT</p>		<p><b>S1124</b> NO. 7700789478</p> <p>SILENT-BLOC DA SUSPENSÃO DIANTEIRA</p> <p>RENAULT R19</p>
	<p><b>S1225</b> NO. 7700776733</p> <p>SILENT-BLOC DO EIXO TRASEIRO</p> <p>RENAULT R19</p>		<p><b>S1225-A</b> NO. 7700776733</p> <p>SILENT-BLOC DO EIXO TRASEIRO</p> <p>RENAULT R19</p>
	<p><b>T0042</b> NO. 7700785788</p> <p>BATENTE CENTRAL DA BARRA ESTABILIZADORA DA SUSPENSÃO FRENTE FURO 21mm</p> <p>RENAULT R19 TT - CLIO TT</p>		<p><b>T1006F23</b> NO. 7700760264</p> <p>BATENTE DAS PONTAS DA BARRA ESTABILIZADORA (FURO 23 mm)</p> <p>RENAULT R19 - R21</p>
	<p><b>T1007</b> NO. 7700771562</p> <p>BATENTE LATERAL DA BARRA ESTABILIZADORA DA SUSPENSÃO FRENTE FURO 21mm</p> <p>RENAULT R19 TT - R21 - TXE - TD</p>		<p><b>T1011</b> NO. 7700784170A</p> <p>BATENTE DA BARRA ESTABILIZADORA PONTAS</p> <p>RENAULT 19 TT</p>
	<p><b>U1001</b> NO. 7700788381</p> <p>LIMITADOR DE APOIO</p> <p>RENAULT R19</p>		<p><b>W5000</b> NO. 8200386445 - 7700112999 - 7700724249 - 7700107145 - 7700864763 - 8200545437 - 8200689705 - 770073990...</p> <p>POLIE DA CAMBOTA (6 pistas)</p> <p>RENAULT R19</p>

## RENAULT R19

Rafpi, Lda.



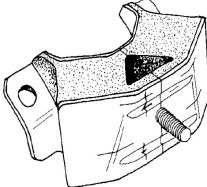
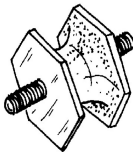
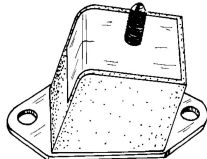
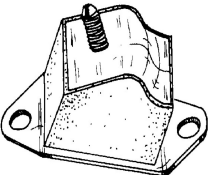
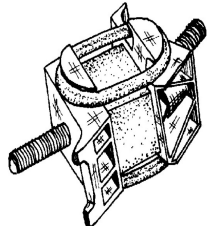





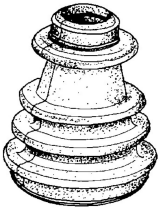
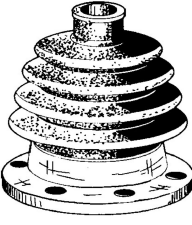

	<b>W5071</b>	NO. 7700856673		<b>Z80474</b>	NO. 7703077068
	POLIE DA CAMBOTA (6 PISTAS) RENAULT 19			Mola de painel RENAULT R19	
	d132mm	d12.6mm		d18.5x13.5mm	1p-d7-12mm
	<b>Z80475</b>	NO. 7703077109		<b>Z80583</b>	NO. 7703077117
	Mola de painel RENAULT R19			Mola de painel RENAULT R19	
	d12.5x19mm	1p-7x7-17mm		d20x15.5mm	1p-d7.5-13.5mm
	<b>Z80603</b>	NO. 7703077256		<b>Z80629</b>	NO. 7703077250
	Mola de friso RENAULT R19			Mola de painel RENAULT R19	
	18.6x13x9.5mm	NULL		d15x19mm	1p-d8.5-12.5mm
	<b>Z80633</b>	NO. 7703081054			
	Mola de painel RENAULT R19				
	d30x17mm	1p-d9.7-15mm			





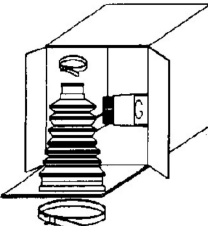
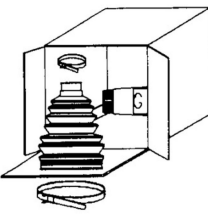
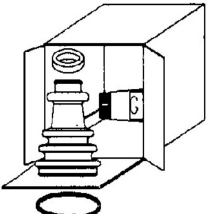







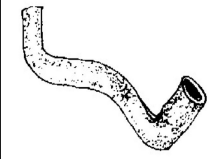

## RENAULT R21-NEVADA

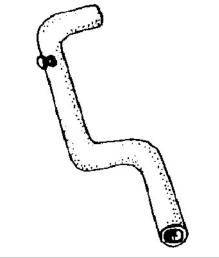
	<b>A0013</b>	NO. 7700760488 - 7700760510 - 7700765935 - 7704001317		<b>A0808-8</b>	NO. 7700565762
	SUPORTE TRÁS DO MOTOR RENAULT R21 TS - GTS - TSE			SUPORTE DE ESCAPE (PERNO 8mm) RENAULT R21	
	145x100x64mm	1p-d10-30mm		48x42x27mm	2p-d8-18mm
	<b>A0985</b>	NO. 7700762721 - 7700763206 - 7704001319		<b>A0986</b>	NO. 7700763207 - 7704001320
	SUPORTE FRENTE DIREITO DO MOTOR (LADO DA DISTRIBUIÇÃO) RENAULT R21 TS - GTS - TSE			SUPORTE FRENTE DO MOTOR ESQUERDO RENAULT R21 TS - GTS - TSE	
	126x63x58mm	1p-d10-28mm		113x80x51mm	1p-d10-27mm
	<b>A0998</b>	NO. 7700766126		<b>A1061</b>	NO. 7700769719
	SUPORTE DE MOTOR RENAULT R21 TXE - DIESEL			SUPORTE FRENTE ESQUERDO DO MOTOR RENAULT R21 TXE - TD - GTD	
	83x75x65mm	2p-d10-35mm		120x100x65mm	1p-d10-40mm 1p-d10-35mm

	<p><b>A1062</b> NO. 7700769720</p> <p>SUPORTE FRENTE DIREITO DO MOTOR</p> <p>RENAULT R21 TXE - TD - GTD</p> <p>120x96x62mm 2p-d10-35mm 1f-23mm</p>		<p><b>A1071</b> NO. 7700765935</p> <p>SUPORTE DO MOTOR LADO DA CAIXA</p> <p>RENAULT R21 GTS</p> <p>143x115x60mm 1p-d10-25mm</p>
	<p><b>A1077</b> NO. 770075531</p> <p>SUPORTE FRENTE ESQUERDO DO MOTOR</p> <p>RENAULT R21</p> <p>115x95x50mm 1p-d10-29mm</p>		<p><b>A1193</b> NO. 7700757691</p> <p>SUPORTE DO AMORTECEDOR DA FRENTE</p> <p>RENAULT 21</p> <p>147x147x40mm 1f-d15mm 4f-d6mm</p>
	<p><b>BB05</b> NO. 7700774027</p> <p>ABRAÇADEIRA DA BARRA ESTABILIZADORA</p> <p>RENAULT NEVADA DIESEL</p> <p>95x45x30mm NULL</p>		<p><b>BB05</b> NO. 7700774027</p> <p>ABRAÇADEIRA DA BARRA ESTABILIZADORA</p> <p>RENAULT R21</p> <p>95x45x30mm NULL</p>
	<p><b>BB06</b> NO. 7700771569 - 7700771568</p> <p>ABRAÇADEIRA DA BARRA ESTABILIZADORA</p> <p>RENAULT NEVADA</p> <p>74x52x35mm NULL</p>		<p><b>BB06</b> NO. 7700771569 - 7700771568</p> <p>ABRAÇADEIRA DA BARRA ESTABILIZADORA</p> <p>RENAULT R21</p> <p>74x52x35mm NULL</p>
	<p><b>BB07</b> NO. 7700771569 - 7700771568</p> <p>ABRAÇADEIRA DA BARRA ESTABILIZADORA</p> <p>RENAULT NEVADA</p> <p>71x52x33mm NULL</p>		<p><b>BB07</b> NO. 7700771569 - 7700771568</p> <p>ABRAÇADEIRA DA BARRA ESTABILIZADORA</p> <p>RENAULT R21</p> <p>71x52x33mm NULL</p>
	<p><b>BB08</b> NO. 7700757109</p> <p>ABRAÇADEIRA DA BARRA ESTABILIZADORA</p> <p>RENAULT NEVADA GASOLINA</p> <p>82x50x30mm NULL</p>		<p><b>BB08</b> NO. 7700757109</p> <p>ABRAÇADEIRA DA BARRA ESTABILIZADORA</p> <p>RENAULT R21</p> <p>82x50x30mm NULL</p>
	<p><b>D0015</b> NO. 7700687433 - 7701349339 - 7700691031 - 7700705138</p> <p>JUNTA DE CARDAN DA DIRECÇÃO</p> <p>RENAULT R21</p> <p>43x32x32mm 2f-d8mm</p>		<p><b>E0025</b> NO. 1030879 - 95VB7L583AB</p> <p>SUPORTE DE ESCAPE</p> <p>RENAULT R21 TT (APÓS 1986)</p> <p>54x33x27mm NULL</p>
	<p><b>E0027</b> NO. 7700779356</p> <p>ESTICADOR DE ESCAPE</p> <p>RENAULT R21 - (APÓS 89)</p> <p>51x27x27mm NULL</p>		<p><b>F0502-I</b> NO. 7700678649</p> <p>FOLE DA CREMALHEIRA DA DIRECÇÃO ESQ. E DIR.</p> <p>RENAULT R21</p> <p>d59x160mm 1f-d28mm 1f-d10mm</p>

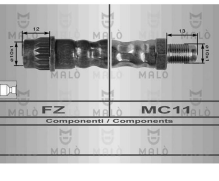

	<p><b>F0572-1I</b> NO. 7701348568</p> <p>FOLE DO LADO DA RODA (UM SÓ ANEL INTERNO DE ENCAIXE)</p> <p>RENAULT R21 - R18 TL - GTL - DIESEL - TURBODIESEL - FUEGO TL - GTL - TX - GTX</p>		<p><b>F0715-I</b> NO. 113501149</p> <p>FOLE DO SEMI-EIXO JUNTO À CAIXA DE VELOCIDADES</p> <p>RENAULT R21 AUTOMATIC</p>
	<p><b>F0830-1I</b> NO. 7701349696 - 7701349841 - 7701464758 - 7701466172</p> <p>FOLE DA TRANSMISSÃO JUNTO À CAIXA</p> <p>RENAULT R21 2.0 - 2.0i - 2.0iT - 2.0i T 4X4 - 2.1D - 2.1 D 4X4 - 2.1TD - 2.2 - 2.2i 4X4 (1986 A 1995)</p>		<p><b>F0901-I</b> NO.</p> <p>FOLE DO SEMI-EIXO ESQ. LADO DA CAIXA</p> <p>RENAULT R21</p>
	<p><b>F0906-I</b> NO. 7700745663</p> <p>FOLE DO LADO DA RODA (JUNTA d90mm EIXO d25mm)</p> <p>RENAULT R21</p>		<p><b>F1089-I</b> NO.</p> <p>FOLE DA TRANSMISSÃO LADO DA RODA</p> <p>RENAULT 21 1.7 - 2.0 - 2.2 (APÓS 1986)</p>
	<p><b>H536</b> NO.</p> <p>PALA ORIGINAL</p> <p>RENAULT R21</p>		<p><b>KB2061</b> NO.</p> <p>KIT DA BARRA ESTABILIZADORA</p> <p>RENAULT 21 - NEVADA GASOLINA</p>
	<p><b>KB2062</b> NO.</p> <p>KIT DA BARRA ESTABILIZADORA</p> <p>RENAULT 21 - NEVADA DIESEL</p>		<p><b>KF2532</b> NO. 7701034800 - 7701467125</p> <p>FOLE DO LADO DA RODA</p> <p>RENAULT R21</p>
	<p><b>KF2534</b> NO.</p> <p>KIT DE FOLE</p> <p>RENAULT R21 - R26</p>		<p><b>KF2540</b> NO. 7701348568 - 7701348694</p> <p>FOLE DO LADO DA RODA</p> <p>RENAULT R21 - TL - GTL - TS - GTS - NEVADA</p>
	<p><b>KL0008</b> NO. 770078304 - 7700662571</p> <p>KIT DE CASQUILHOS DA DIRECÇÃO ASSISTIDA</p> <p>RENAULT 21 GTS</p>		<p><b>M6051</b> NO. 7700766353 - 7700782519 - 6025308326 - 7700766355 - 3445663 - 3458510</p> <p>JUNTA DE ESCAPE</p> <p>RENAULT R21 (1986 A 1995)</p>
	<p><b>M6052</b> NO. 7700781679 - 7700782520 - 8932001367 - 8933000112</p> <p>JUNTA DE ESCAPE</p> <p>RENAULT R21 (1986 A 1994)</p>		<p><b>M6053</b> NO. 7700774367</p> <p>JUNTA DE ESCAPE</p> <p>RENAULT R21 (APÓS 1988)</p>

	<p><b>M6088</b> NO. 7700785283 - 7700779464</p> <p>JUNTA DE ESCAPE</p> <p>RENAULT R21 (1987 A 1993)</p> <p>d68x15mm 1f-d54mm</p>		<p><b>M6088</b> NO. 7700785283 - 7700779464</p> <p>JUNTA DE ESCAPE</p> <p>RENAULT R21 (1987 A 1993)</p> <p>d68x15mm 1f-d54mm</p>
	<p><b>MT6700</b> NO.</p> <p>JUNTA DE TERMOSTATO</p> <p>RENAULT R21 1.7</p> <p>d52x2mm 1f-d43mm</p>		<p><b>R220692</b> NO. 7700766112</p> <p>TUBO DE RADIADOR SUPERIOR C/ RESPIRO</p> <p>RENAULT R21 TD - GTD</p> <p>B315-d40/40mm 90-70-100-95mm</p>
	<p><b>R220693</b> NO. 7700765108</p> <p>TUBO DE RADIADOR INFERIOR</p> <p>RENAULT R21 TXE - TD - GTD</p> <p>B305-d33/36mm 80-14-11-90mm</p>		<p><b>R220694</b> NO. 7700764563 - 7700783013</p> <p>TUBO DE RADIADOR SUPERIOR C/ RESPIRO</p> <p>RENAULT R21 TXE - TD - GTD</p> <p>B320-d33/33mm 95-100-75-95mm</p>
	<p><b>R220698</b> NO. 7700745665 - 7700851815</p> <p>TUBO DE LIGAÇÃO DA BOMBA (TELA S/ SILICONE)</p> <p>RENAULT R21 TXE DIESEL</p> <p>B110-d23/23mm 60-60mm</p>		<p><b>R221665</b> NO. 7700767138</p> <p>TUBO DO AQUECIMENTO (C/ RESPIRO)</p> <p>RENAULT R21 TXE DIESEL</p> <p>B340-d20/20mm 75-150-100-145mm</p>
	<p><b>R8056</b> NO. 7702225699</p> <p>TUBO SUPERIOR DO RADIADOR</p> <p>RENAULT 21 MANAGER</p> <p>B630-d32/32mm 135-55-220-330-75mm</p>		<p><b>R8057</b> NO.</p> <p>TUBO INFERIOR DO RADIADOR</p> <p>RENAULT 21</p> <p>B230-d32/32mm B230-d20/20mm 105-255-175-235-70mm 170-60-55mm 280mm</p>
	<p><b>R8058</b> NO. 7700796602</p> <p>TUBO DO ARREFECIMENTO</p> <p>RENAULT 21</p> <p>B300-d19/19mm B230-d20/20mm 130-65mm 70-145-65mm</p>		<p><b>R8059</b> NO. 7702252701</p> <p>TUBO DO ARREFECIMENTO</p> <p>RENAULT 21 GTS (APÓS 1989)</p> <p>B685-d22/20mm B335-d20/20mm 325-265-45mm 80-165-320-140-100mm</p>
	<p><b>R8060</b> NO. 7700791573</p> <p>TUBO DO ARREFECIMENTO</p> <p>RENAULT 21</p> <p>B370-d19/22mm B370-d20/20mm 195-115-195-95mm 80-150-205-80</p>		<p><b>R8061</b> NO. 7702147988</p> <p>TUBO DO ARREFECIMENTO</p> <p>RENAULT 21 DIESEL (ATÉ 1992)</p> <p>B390-d20/20mm d14mm 65-150-100-140mm 80-200-205-95mm</p>
	<p><b>RF5003</b> NO. 7700860371</p> <p>TUBO DE FERRO RADIADOR</p> <p>RENAULT R21 - R21 GTS APÓS 1990</p> <p>B415-d18/18mm 85-275-120+B385-d13/13mm-100-255-65</p>		<p><b>RT08494</b> NO. 7704003958 - 6025307608</p> <p>TUBO DE TRAVÃO TRÁS LH-RH</p> <p>RENAULT R21 (COM ABS) 1.4 (06-1988 A 10-1993) - 1.7 (1986 A 1995) - 1.9D (06-1986 A 08-1994) - 2.0 (03-1986 A 10-1993) - 2.1D (1986 A 1995) - 2.1 TD (1986 A 1995)</p> <p>290mm FZ - MC11</p>







	<p><b>RT08496</b> NO. 7704003887 - 7704003949</p> <p>TUBO DE TRAVÃO FRENTE LH-RH</p> <p>RENAULT 21 1.4 (09-1989 A 05-1993) - 1.7 (09-1989 A 06-1994) - 1.9 D (09-1989 A 10-1993) - 2.2 (09-1989 A 06-1994)</p>		<p><b>RT08496</b> NO. 7704003887 - 7704003949</p> <p>TUBO DE TRAVÃO FRENTE LH-RH</p> <p>RENAULT 21 FURGONATO 1.7 (06-1986 A 04-1995) - 1.9 D (06-1986 A 08-1994)</p>
	<p><b>RT08496</b> NO. 7704003887 - 7704003949</p> <p>TUBO DE TRAVÃO FRENTE LH-RH</p> <p>RENAULT 21 STATION WAGON 1.7 (06-1986 A 04-1989) - 1.9 D (03-1986 A 08-1994)</p>		<p><b>RT08496</b> NO. 7704003887 - 7704003949</p> <p>TUBO DE TRAVÃO FRENTE LH-RH</p> <p>RENAULT 21 TRE VOLUMI 1.4 (06-1988 A 10-1993) - 1.7 (03-1986 A 10-1993)</p>
	<p><b>S1091</b> NO. 7700754515 - 7700785937</p> <p>SILENT-BLOC FRENTE DO BRAÇO INFERIOR DA SUSPENSÃO FRENTE</p> <p>RENAULT R21 TXE - TD - GTD</p>		<p><b>S1092</b> NO. 7700772687</p> <p>SILENT-BLOC TRÁS DO BRAÇO INFERIOR DA SUSPENSÃO FRENTE</p> <p>RENAULT R21 - D TD</p>
	<p><b>S1103</b> NO. 7700799065</p> <p>SILENT-BLOC TRÁS DO TRAPÉZIO DA SUSPENSÃO FRENTE</p> <p>RENAULT R21</p>		<p><b>S1147</b> NO. 7700767686</p> <p>SILENT-BLOC DIANTEIRO PONTE DO MOTOR</p> <p>RENAULT R21</p>
	<p><b>S1148</b> NO. 770767684</p> <p>SILENT-BLOC TRÁS PONTE MOTOR</p> <p>RENAULT R21</p>		<p><b>T0043</b> NO. 7700769226</p> <p>BATENTE CENTRAL DA BARRA ESTABILIZADORA DA SUSPENSÃO FRENTE</p> <p>RENAULT R21 TXE - TD</p>
	<p><b>T1006F16</b> NO. 7700789412</p> <p>BATENTE DAS PONTAS DA BARRA ESTABILIZADORA - FURO 16mm</p> <p>RENAULT R21</p>		<p><b>T1006F22</b> NO. 7700760265</p> <p>BATENTE LATERAL DA BARRA ESTABILIZADORA DA SUSPENSÃO FRENTE FURO 22mm</p> <p>RENAULT R21 TS - GTS - TSE</p>
	<p><b>T1009</b> NO. 7700774026</p> <p>BATENTE DE ESTABILIZADOR</p> <p>RENAULT 21</p>		<p><b>T1064</b> NO. 7700769226</p> <p>BATENTE BARRA ESTABILIZADORA</p> <p>RENAULT 21 NEVADA DIESEL</p>
	<p><b>W5020</b> NO. 7700853470</p> <p>POLIE DA CAMBOTA (2 pistas)</p> <p>RENAULT R21 DIESEL</p>		<p><b>W5032</b> NO. 7700853469</p> <p>POLIE DA CAMBOTA (1 PISTA)</p> <p>RENAULT R21 2.1D - 2.1TD MOTORES J85 (740) (786)</p>

	<b>W5061</b> NO. 7700853774		<b>Z10508</b> NO. 7701397195
	POLIE DA CAMBOTA (2 PISTAS) RENAULT 21 (-A-C)		Mola de fixação RENAULT R21
d117/133mm d15mm		d16.5x16.7mm 1p-d8-18.8mm 1f-d7.5mm	
	<b>Z80258</b> NO. 7703077006		<b>Z80475</b> NO. 7703077109
	Mola de friso RENAULT R21		Mola de painel RENAULT R21
15x11x17mm 1p-d6-6mm		d12.5x19mm 1p-7x7-17mm	
	<b>Z80627</b> NO. 7703077345		<b>Z80629</b> NO. 7703077250
	Mola de painel RENAULT NEVADA		Mola de painel RENAULT NEVADA
d15x18.5mm 1p-d7.5-12.5mm		d15x19mm 1p-d8.5-12.5mm	





RENAULT R25

	<b>A0808-8</b> NO. 7700565762		<b>A0973</b> NO. MB620050
	SUPORTE DE ESCAPE (PERNO 8mm) RENAULT R25 TT		SUPORTE DE ESCAPE RENAULT R25
48x42x27mm 2p-d8-18mm		30x27x24mm 2p-d6-14mm	
	<b>BE25</b> NO. 7701458595 - 7701450595		<b>D0015</b> NO. 7700687433 - 7701349339 - 7700691031 - 7700705138
	ABRAÇADEIRA DE ESCAPE CÔNCAVA (58 mm) RENAULT R25 (1994 A 1996)		JUNTA DE CARDAN DA DIRECÇÃO RENAULT R25
95x60x20mm 2p-d8mm		43x32x32mm 2f-d8mm	
	<b>E0015</b> NO. 7700686449 - 7700795220		<b>F0572-11</b> NO. 7701348568
	ESTICADOR DE ESCAPE RENAULT R25 - R9 TT - R11 TT R21 TT		FOLE DO LADO DA RODA (UM SÓ ANEL INTERNO DE ENCAIXE) RENAULT R25 TURBO DIESEL
87x31x26.5mm NULL		d93x117mm 1f-d81mm 1f-d30mm	
	<b>F0830-11</b> NO. 7701349696 - 7701349841 - 7701464758 - 7701466172		<b>F0906-I</b> NO. 7700745663
	FOLE DA TRANSMISSÃO JUNTO À CAIXA RENAULT R25 2.0 - 2.0 12V - 2.1 D - 2.1 TD - 2.2 - 2.4i T V6 - 2.7i INJEÇÃO V6 - 2.8i INJEÇÃO V6 - 2.8 V6 (1984 A 1993)		FOLE DO LADO DA RODA (JUNTA d90mm EIXO d25mm) RENAULT R25 - R30
d90x113mm 1f-d24mm 1f-d73mm		d103x83mm 1f-d80mm 1f-d22mm	

## RENAULT R25



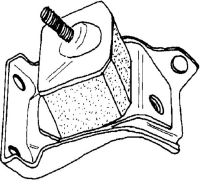
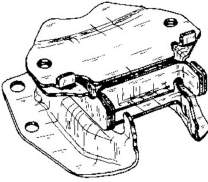





	<b>F1329-I</b> NO. 7701472212 - 7701466349 - 7701470299 FOLE DA TRANSMISSÃO JUNTO À CAIXA RENAULT 25 2.4i T V6 - 2.5i T V6 - 2.7i INJECTION V6 - 2.8i INJECTION V6 (1984 A 1993) d86x102mm 1f-d73mm 1f-d26mm		<b>P1021</b> NO. 7700765318 CAPA DE PEDAL DO TRAVÃO E EMBRAIAGEM RENAULT R25 - R21 73x57x10mm NULL
	<b>Z80258</b> NO. 7703077006 Mola de friso RENAULT R25 15x11x17mm 1p-d6-6mm		<b>Z80474</b> NO. 7703077068 Mola de painel RENAULT R25 d18.5x13.5mm 1p-d7-12mm
	<b>Z80500</b> NO. 7703077066 Mola de painel RENAULT R25 d12.4x20mm 1p-d6.5-18mm		<b>Z80583</b> NO. 7703077117 Mola de painel RENAULT R25 d20x15.5mm 1p-d7.5-13.5mm
	<b>Z80633</b> NO. 7703081054 Mola de painel RENAULT R25 d30x17mm 1p-d9.7-15mm		



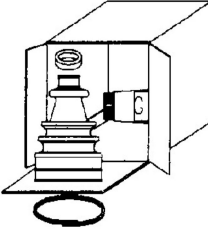
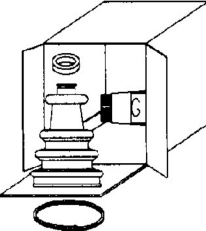
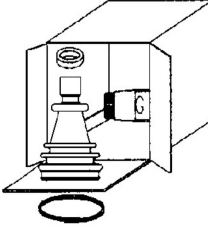
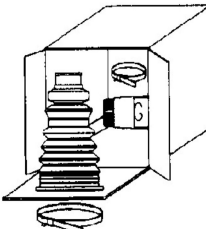
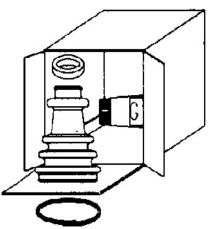
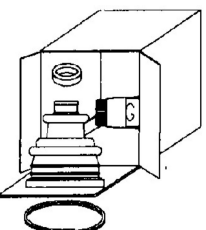
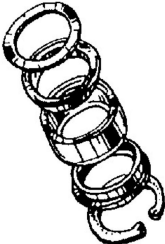







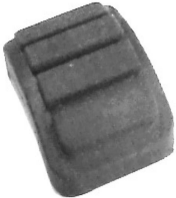



## RENAULT R5







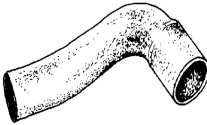

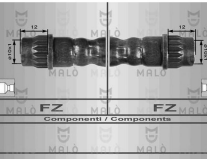
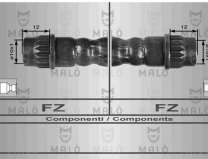

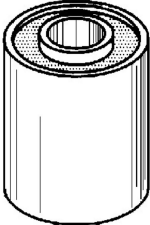
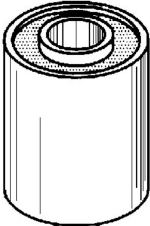
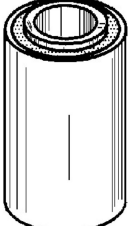
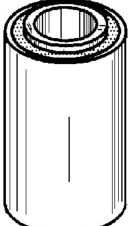
	<b>A0583</b> NO. 0 - 0094535900 - 0854851400 - 7704002509 - 7700511170 - 7700558542 - 7701348802 SUPORTE DE ESCAPE RENAULT R5 - L(845) - TL(956) - GTL(1108) - LS - TS(1289) 27x27x23mm 2p-d6-13mm		<b>A0703</b> NO. 8243734 - 8558634 - 7700500113 - 7702108305 - 0855863400 SUPORTE DO BRAÇO OSCILANTE RENAULT R5 TT 75x50x35mm 1f-d12mm
	<b>A0973</b> NO. 31607529204 SUPORTE DE ESCAPE RENAULT R5 - SUPER5 TT 30x27x24mm 2p-d6-14mm		<b>A0989-I</b> NO. 7700527555 - 7700527557 - 7700527603 SUPORTE FRENTE DO MOTOR ESQUERDO RENAULT R5 TT 110x98x70mm 1p-d8-23mm 1f-d8mm
	<b>A0992-I</b> NO. 7700533443 - 7700533444 SUPORTE DA CAIXA DE VELOCIDADES RENAULT R5 TT 134x126x64mm NULL		<b>A1000</b> NO. 7700692341 - 7701349504 SUPORTE DE MOTOR CENTRAL CAIXA 5 VEL. RENAULT R5 - SUPER5 TT 182x163x50mm NULL

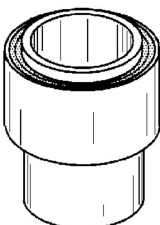

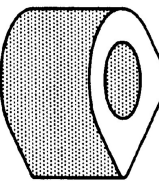
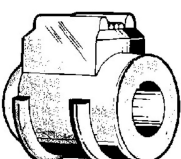
	<p><b>D0002</b> NO. 7700509257 - 7701348067 - 7704001919 - 7700545821 - 06020035 - 06020037</p> <p><i>JUNTA DE CARDAN DA DIRECÇÃO</i></p> <p>RENAULT R5 - L(845) - TL(956) - GTL(1086) - LS - TS(1289) - R6 TT - R12 TT - R18 - FUEGO</p> <p>51x32x32mm 2f-d8mm</p>		<p><b>D3604</b> NO. 7700549015 - 7704002058 - 7700244291</p> <p><i>JUNTA CARDAN DA DIRECÇÃO</i></p> <p>RENAULT R5 - L(845) - TL(956) - GTL(1086) - LS - TS(1289) - R6 TT - R12 TT - R9 - R11 TT - R18 TT - R20 TT - FUEGO</p> <p>d75x12mm 4f-d8mm</p>
	<p><b>D3604-C</b> NO. 7700549015 - 7704002058 - 7700244291</p> <p><i>JUNTA CARDAN DA DIRECÇÃO COM PORCAS E PARAFUSOS</i></p> <p>RENAULT R5 - L(845) - TL(956) - GTL(1086) - LS - TS(1289) - R6 TT - R12 TT - R9 - R11 TT - R18 TT - R20 TT - FUEGO</p> <p>d75x12mm 4f-d8mm</p>		<p><b>E0025</b> NO. 8200024453 - 7700302151</p> <p><i>SUPORTE DE ESCAPE</i></p> <p>RENAULT R5 TT (1985)</p> <p>54x33x27mm NULL</p>
	<p><b>F0366-I</b> NO. 7701450617</p> <p><i>FOLE DO SEMI-EIXO JUNTO À CAIXA DE VELOCIDADES (diam. 79mm)</i></p> <p>RENAULT R5 - L(845) - TL(956) - GTL(1108) - LS - TS(1289) (1972 a 1984) - SUPER5 C - SC - TC</p> <p>d98x96mm 1f-d79 1f-d18mm</p>		<p><b>F0367-I</b> NO. 7701457538</p> <p><i>FOLE DO SEMI-EIXO DO DIFERENCIAL JUNTO À RODA (DIAM. 76mm)</i></p> <p>RENAULT R5 - L-(845) - TL - (956) - GTL-(1108) - LS - TS(1289)(excepto ALPINE (72 a 84) SUPER5 C - SC - TC - R6 TT - R14</p> <p>d81x95mm 1f-d76mm 1f-d18mm</p>
	<p><b>F0380-I</b> NO. 7701457538 - 7701200694</p> <p><i>FOLE SEMI-EIXO DOLADO DA RODA(DIAM. 86mm EIXO 20mm) (F1010)</i></p> <p>RENAULT R5 ALPINE - ALPINE TURBO</p> <p>d94x117mm 1f-d22mm 1f-d80mm</p>		<p><b>F0380A-I</b> NO. 7701457533 - 7701200694</p> <p><i>FOLE DO SEMI-EIXO JUNTO À RODA</i></p> <p>RENAULT R5 ALPINE - ALPINE TURBO</p> <p>d94x137mm 1f-d27mm 1f-d80mm</p>
	<p><b>F0502-I</b> NO. 7700678649</p> <p><i>FOLE DA CREMALHEIRA DA DIRECÇÃO ESQ. E DIR.</i></p> <p>RENAULT R5 - SUPER5 TT</p> <p>d59x160mm 1f-d28mm 1f-d10mm</p>		<p><b>F0572-1I</b> NO. 7701348568</p> <p><i>FOLE DO LADO DA RODA (UM SÓ ANEL INTERNO DE ENCAIXE)</i></p> <p>RENAULT R5 SUPER5 1.1 - R9 - R11</p> <p>d93x117mm 1f-d81mm 1f-d30mm</p>
	<p><b>F0572-I</b> NO. 7701348568 - 7701348694</p> <p><i>FOLE DO SEMI-EIXO JUNTO À RODA DIREITO</i></p> <p>RENAULT R5 TT (EXCP. R5 (85) - SUPER5 TT (EXCP. GT TURBO 86mm EIXO 35mm) - R9 - R11</p> <p>d93x117mm 1f-d81mm 1f-d30mm</p>		<p><b>F0825-I</b> NO. 7700678649 - 7700781097</p> <p><i>FOLE DO SEMI-EIXO JUNTO À RODA LADO DREITO</i></p> <p>RENAULT R5 - SUPER5 (EXCPT. GT TURBO DIAM. 76mm)</p> <p>d89x84mm 1f-d75mm 1f-d22mm</p>
	<p><b>F0827-I</b> NO. 770075831</p> <p><i>FOLE DO SEMI-EIXO JUNTO À CAIXA DE VELOCIDADES DIREITO</i></p> <p>RENAULT R5 - SUPER5 - R9 - R11 - R21</p> <p>d95x108mm 1f-d77mm 1f-d31mm</p>		<p><b>F0901-I</b> NO.</p> <p><i>FOLE DO SEMI-EIXO ESQ. LADO DA CAIXA</i></p> <p>RENAULT R5 SUPER5 - R9 - R11</p> <p>d115x78mm 1f-d87mm 1f-d30mm</p>
	<p><b>F0901A3I</b> NO. 7701462100 - 7701462308 - 7701466083 - 7701466983 - 7701468575 - 7701468576 - 7701470567 - 3287.84 - ...</p> <p><i>FOLE DO SEMI-EIXO LADO DA CAIXA C/ ROLAMENTO d25.8mm</i></p> <p>RENAULT R5 - SUPER5 - R9 - R11</p> <p>d115x78mm 1f-d87mm 1f-d25.8mm</p>		<p><b>F1008</b> NO. 7701457538</p> <p><i>FOLE DO SEMI-EIXO JUNTO À RODA (VER 367-I)</i></p> <p>RENAULT R5 TT (excepto ALPINE (72 a 84)</p> <p>d81x95mm 1f-d76mm 1f-d18mm</p>

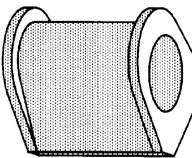





	<p><b>F1052</b> NO. 7700532414 - 7700623055</p> <p>FOLE DA ALAVANCA DE VELOCIDADES</p> <p>RENAULT R5 TT - R6 TT</p> <p>d42x17mm 1f-d16mm 1f-d15mm</p>		<p><b>F1087-I</b> NO. 7701201128</p> <p>FOLE DA TRANSMISSÃO LADO DA CAIXA</p> <p>RENAULT R5</p> <p>d82x116 1f-d64mm 1f-d18mm</p>
	<p><b>H534</b> NO.</p> <p>PALA ORIGINAL</p> <p>RENAULT R5</p> <p>295x195mm NULL</p>		<p><b>KF2501</b> NO. 7701200922</p> <p>FOLE DO LADO DA RODA</p> <p>RENAULT GE 81 - R5</p> <p>d84x110mm 1f-d20mm 1f-d74mm</p>
	<p><b>KF2510</b> NO. 7701455096 - 7701457539 - 9403293748 - 3293.41 - 13617800</p> <p>FOLE DO LADO DA RODA</p> <p>RENAULT R5 ALPINE - ALPINE TURBO - R12 - R14 - R15 - R16 - R17 - R - 18 - R20</p> <p>d93x116mm 1f-d20mm 1f-d76mm</p>		<p><b>KF2530</b> NO. 7701200694</p> <p>FOLE DO LADO DA RODA</p> <p>RENAULT R5 GE 86 D40 - R5 ALPINE - ALPINE TURBO - R12 - R14 - R15 - R16 - R17 1982 on R20 TL - GTL - Automatic</p> <p>d94x135mm 1f-d23mm 1f-d78mm</p>
	<p><b>KF2531-T</b> NO. 7701466120</p> <p>FOLE DO LADO DA RODA</p> <p>RENAULT R5 - SUPER5 GT TURBO</p> <p>d90x140mm 1f-d33mm 1f-d70mm</p>		<p><b>KF2540</b> NO. 7701348568 - 7701348694</p> <p>FOLE DO LADO DA RODA</p> <p>RENAULT R5 SUPER5 GTX - TX - TXE - GTR - SL - TL - GTL - SR - TR</p> <p>d94x115mm 1f-d28mm 1f-d74mm</p>
	<p><b>KF2560</b> NO. 7701463643</p> <p>FOLE DO LADO DA RODA</p> <p>RENAULT R5 SUPER5</p> <p>d87x83mm 1f-d20mm 1f-d75mm</p>		<p><b>KL0001-I</b> NO. 7701455251</p> <p>KIT DE CASQUILHOS DA DIRECÇÃO</p> <p>RENAULT R5 TT - R6 TT</p> <p>NULL NULL</p>
	<p><b>KL0769-I</b> NO. 7700560542</p> <p>KIT DE CASQUILHOS DA ALAVANCA DE VELOCIDADES</p> <p>RENAULT R5</p> <p>NULL NULL</p>		<p><b>L3001</b> NO. 7702105447</p> <p>CASQUILHO INFERIOR DA DIRECÇÃO</p> <p>RENAULT R5 - R6 - R12</p> <p>d36-20mm 1f-d18mm</p>
	<p><b>L3010</b> NO. 7704000926</p> <p>CASQUILHO DA EXTREMIDADE DA CREMALHEIRA DA DIRECÇÃO</p> <p>RENAULT R5 TT - R19 - R21 TT</p> <p>33x31x18mm 1f-d20mm</p>		<p><b>M6051</b> NO. 7700766353 - 7700782519 - 6025308326 - 7700766355 - 3445663 - 3458510</p> <p>JUNTA DE ESCAPE</p> <p>RENAULT R5 (1987 A 1990) - R9 (1986 A 1989)</p> <p>d89x12.2mm 1f-d74.5mm</p>
	<p><b>M6081</b> NO. 6000057158</p> <p>JUNTA DE ESCAPE</p> <p>RENAULT R5 (1976 A 1984)</p> <p>86x52mm 1f-d38mm</p>		<p><b>P0008-R</b> NO. 7700569868</p> <p>CAPA DE PEDAL TRAVÃO E EMBRAIAGEM</p> <p>RENAULT R5 - R10 - R12</p> <p>68x45x12mm NULL</p>

	<p><b>P1009</b> NO. 7700569868 - 7700651623 - 6060908 - 7700651523</p> <p>CAPA DE PEDAL DO TRAVÃO E EMBRAIAGEM</p> <p>RENAULT R5 - L(845) - TL(956) - GTL(1108) - LS-TS(1289) - R6 TT</p> <p>65x42x10mm NULL</p>		<p><b>R220302</b> NO. 7700533153</p> <p>TUBO DO AQUECIMENTO</p> <p>RENAULT R5 TL</p> <p>B240-d16/18mm 35-185-190-120-160-220-80-85mm</p>
	<p><b>R220303</b> NO. 7700541590</p> <p>TUBO DO AQUECIMENTO</p> <p>RENAULT R5 TL</p> <p>B150-d16/19mm 50-140-140-100-190-160-60-130-60mm</p>		<p><b>R220319</b> NO. 7700556107 - 7700676121 - 7700676955 - 7700781498</p> <p>TUBO DE RADIADOR SUPERIOR</p> <p>RENAULT R5 TL - GTL</p> <p>B510-d42/30mm 100-120-260-105mm</p>
	<p><b>R220320</b> NO. 7700533016 - 7700766870</p> <p>TUBO DE RADIADOR INFERIOR</p> <p>RENAULT R5 TL - GTL - TS - ALPINE</p> <p>B450-d30/30mm 90-170-120-80-175mm</p>		<p><b>R220583</b> NO. 7700545016</p> <p>TUBO DE LIGAÇÃO DA BOMBA DE ÁGUA AO COLECTOR</p> <p>RENAULT R5 TL - TS</p> <p>B95-d12/12mm 45-40-35mm</p>
	<p><b>R220584</b> NO. 7700545017</p> <p>TUBO DE LIGAÇÃO DO COLECTOR À BOMBA DE ÁGUA</p> <p>RENAULT R5 TL - TS</p> <p>B225-d10/10mm 55-200-50mm</p>		<p><b>R220585</b> NO. 7700581920 - 7700676091 - 7701020225 - 7700540591 - 7700711495</p> <p>TUBO DE ENVIO DE ÁGUA AO AQUECIMENTO</p> <p>RENAULT R5 TL - GTL - TS - ALPINE</p> <p>B510-d17/19mm 95-210-385-160mm</p>
	<p><b>R220586</b> NO. 7700581919 - 7700676029</p> <p>TUBO DE RETORNO DE ÁGUA DO AQUECIMENTO</p> <p>RENAULT R5 TL - GTL - TS - ALPINE</p> <p>B600-d18/18mm 90-70-410-230-55mm</p>		<p><b>R220588</b> NO. 7700560402</p> <p>TUBO DE LIGAÇÃO DA BOMBA AO COLECTOR</p> <p>RENAULT R5 TS</p> <p>B215-d12/12mm 45-75-60-65mm</p>
	<p><b>R220589</b> NO. 7700578606</p> <p>TUBO DE LIGAÇÃO DA BOMBA AO COLECTOR</p> <p>RENAULT R5 TS</p> <p>B205-d9/9mm 45-55-80-40-30mm</p>		<p><b>R2347</b> NO.</p> <p>TUBO DA CHUFAGE</p> <p>RENAULT R5</p> <p>B210-d11/11mm 50-35-45-115-50mm</p>
	<p><b>R2431</b> NO. 7700532664 - M220318</p> <p>TUBO SUPERIOR DO RADIADOR</p> <p>RENAULT R5</p> <p>B205-d31/40mm 70-95-90mm</p>		<p><b>R2433</b> NO. 7700532663 - M220317</p> <p>TUBO INFERIOR DO RADIADOR</p> <p>RENAULT R5</p> <p>B265-d30/30mm 55-170-65mm</p>
	<p><b>RT08501</b> NO. 7701349305 - 7704001950 - 7704003549 - 7700541132 - 7704003931</p> <p>TUBO DE TRAVÃO TRÁS LH-RH</p> <p>RENAULT R5 SUPER 1.4 GT TURBO (APÓS 1985)</p> <p>270mm FZ - FZ</p>		<p><b>RT08501</b> NO. 7701349305 - 7704001950 - 7704003549 - 7700541132 - 7704003931</p> <p>TUBO DE TRAVÃO TRÁS LH</p> <p>RENAULT R5 SUPER TT (EXCEPTO 1.4 GT TURBO) (APÓS 1985)</p> <p>270mm FZ - FZ</p>

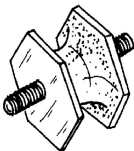
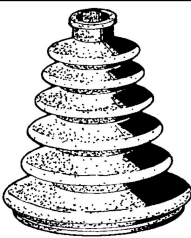
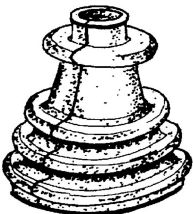
	<p><b>S0006</b> NO. 7700542251 - 7700542611 - 7701348037</p> <p>SILENT-BLOC DO BRAÇO SUPERIOR DA SUSPENSÃO FRENTE RENAULT R5 - L(845) - TL (956) - GTL (1108) - LS - TS (1289)</p> <p>d26x36mm c23mm 1f-d12mm</p>		<p><b>S1020</b> NO. 7700533100 - 7700574081 - 7701349773</p> <p>SILENT-BLOC DO BRAÇO INFERIOR DA SUSPENSÃO TRÁS RENAULT R5 - L(845) - TL (956) - GTL (1108) - LS - TS (1289)</p> <p>d34x45mm c40mm 1f-d14mm</p>
	<p><b>S1020-A</b> NO. 7700533100 - 7700574081 - 7701349773</p> <p>SILENT-BLOC DO BRAÇO INFERIOR DA SUSPENSÃO TRÁS RENAULT R5 - L(845) - TL (956) - GTL (1108) - LS - TS (1289)</p> <p>d34x45mm c40mm 1f-d14mm</p>		<p><b>S1021</b> NO. 8545885 - 8558426 - 7701348454</p> <p>SILENT-BLOC DO BRAÇO INFERIOR DA SUSPENSÃO FRENTE RENAULT R5 - L(845) - TL (956) - GTL (1108) - LS - TS (1289) - R6 TT</p> <p>d27x45mm c40mm 1f-d14mm</p>
	<p><b>S1021-A</b> NO. 8545885 - 8558426 - 7701348454 - 0854885000 - 0845588500 - 0854588500</p> <p>SILENT-BLOC DO BRAÇO INFERIOR DA SUSPENSÃO FRENTE RENAULT R5 - L(845) - TL (956) - GTL (1108) - LS - TS (1289) - R6 TT</p> <p>d27x45mm c40mm 1f-d14mm</p>		<p><b>S1035</b> NO. 8546375 - 7700509247 - 7702042315 - 0854637500 - 7700639572</p> <p>SILENT-BLOC DA EXTREMIDADE DA CREMALHEIRA DA DIRECÇÃO RENAULT R5 - L(845) - TL (956) - GTL (1108) - LS - TS (1289)</p> <p>d28x27mm c20mm 1f-d10mm</p>
	<p><b>S1045</b> NO. 7700531796</p> <p>SILENT-BLOC SUSPENSÃO TRÁS RENAULT R5</p> <p>d55x58mm d43mm 1f-d37.3mm</p>		<p><b>S1116</b> NO. 7700612542</p> <p>SILENT-BLOC DO ALTERNADOR RENAULT R5 - R9 - R11</p> <p>d30x25mm d25mm 1f-d8mm</p>
	<p><b>T0001</b> NO. 6082687 - 608268700 - 0608268700</p> <p>BATENTE DA BARRA ESTABILIZADORA RENAULT R5 TT</p> <p>30x30x20mm 1f-d16mm</p>		<p><b>T0016</b> NO. 7700760265</p> <p>BATENTE LATERAL DA BARRA ESTABILIZADORA DA SUSPENSÃO FRENTE FURO 20mm RENAULT R5 - SUPER5 TT</p> <p>58x45x42mm 1f-d18mm</p>
	<p><b>T0018</b> NO. 7700763934</p> <p>BATENTE CENTRAL DA BARRA ESTABILIZADORA RENAULT R5 - R9 - SUPER5 - R11</p> <p>40x35x35mm 1f-d20mm</p>		<p><b>T0020</b> NO. 7700763934 - 77021444561</p> <p>BATENTE CENTRAL DA BARRA ESTABILIZADORA DA SUSPENSÃO FRENTE RENAULT R5 - R9 - R11</p> <p>44x37x33mm 1f-d22mm</p>
	<p><b>T1001</b> NO. 7700693866</p> <p>BATENTE LATERAL DA BARRA ESTABILIZADORA TRÁS (FURO 10mm) RENAULT R5</p> <p>78x51x39mm 1f-d9mm 1f-d10mm</p>		<p><b>T1002</b> NO. 7702107984 - 7700693865</p> <p>BATENTE LATERAL DA BARRA ESTABILIZADORA TRÁS (FURO 10mm) RENAULT R5</p> <p>73x38x51mm 1f-d10mm 1f-d8mm</p>
	<p><b>T1003</b> NO. 7702106143</p> <p>BATENTE LATERAL DA BARRA ESTABILIZADORA TRÁS (FURO 10mm) RENAULT R5</p> <p>73x38x39mm 1f-d10mm 1f-d8mm</p>		<p><b>Z80258</b> NO. 7703077006</p> <p>Mola de friso RENAULT R5</p> <p>15x11x17mm 1p-d6-6mm</p>

	<b>Z80444</b> NO. 60593404		<b>Z80474</b> NO. 7703077068
	Mola de friso RENAULT R5		Mola de painel RENAULT R5
	NULL NULL		d18.5x13.5mm 1p-d7-12mm
	<b>Z80500</b> NO. 7703077066		<b>Z80633</b> NO. 7703081054
	Mola de painel RENAULT R5		Mola de painel RENAULT R5
	d12.4x20mm 1p-d6.5-18mm		d30x17mm 1p-d9.7-15mm

RENAULT R6-R6 TL

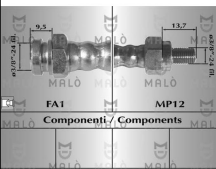
	<b>A0583</b> NO. 0094535900 - 0854851400 - 7704002509 - 7700511170 - 7700558542 - 7701348802		<b>A0808-8</b> NO. 7700565762
	SUPPORTE DE ESCAPE RENAULT R6 TT		SUPPORTE DE ESCAPE (PERNO 8mm) RENAULT R6 TT - R15 - R17 - R20 TT - FUEGO TT
	27x27x23mm 2p-d6-13mm		48x42x27mm 2p-d8-18mm
	<b>F0366-I</b> NO. 7701450617		<b>F1008</b> NO. 7701457538
	FOLE DO SEMI-EIXO JUNTO Á CAIXA DE VELOCIDADES (diam. 79mm) RENAULT R6 TT - R12 (1969 A 1981)		FOLE DO SEMI-EIXO JUNTO Á RODA (VER 367-I) RENAULT R6 TT (69 a 79) - R14
	d98x96mm 1f-d79 1f-d18mm		d81x95mm 1f-d76mm 1f-d18mm
	<b>R220314</b> NO. 7700531003 - 7700520063		<b>R220315</b> NO. 7700531005 - 0832987200 - 832087200
	TUBO DE RADIADOR SUPERIOR RENAULT R6 TL		TUBO DE RADIADOR INFERIOR RENAULT R6 TL
	B550-d42/42mm 90-405-50-75mm		B465-d33/33mm 65-55-200-190-85mm
	<b>R220452</b> NO. 7700523868 - 7700535798		<b>R220453</b> NO. 7700523867
	TUBO DE LIGAÇÃO DO AQUECIMENTO À BOMBA RENAULT R6 TL		TUBO DE LIGAÇÃO DA BOMBA AO AQUECIMENTO RENAULT R6 TL
	B520-d18/18mm 70-260-295-70mm		B580-d19/19mm 95-295-280-270mm
	<b>R8018</b> NO. 7700534928		<b>RT08096</b> NO. 7701000239 - 7701348799 - 7701349268 - 7701365330 - 7701454835 - 7701582523 - 84140390 - 8422177 - 8...
	TUBO DE CHAUFAGEM DE ADMISSÃO AO COLECTOR RENAULT R6 2ª SÉRIE		TUBO DE TRAVÃO FRENTE LH-RH RENAULT 6 0.8 (800.02) 34CV (10-1969 A 04-1980)
	B95-d10/10mm 40-25-50mm		500mm FA1 - MP12



	<b>RT08309</b> NO. 7700545267 - 7700627933 - 7700641119 - 7701348800 - 7701454836 - 7704001925 - 8414040 <b>TUBO DE TRAVÃO FRENTE LH-RH</b> RENAULT 6 0.8 (10-1969 A 04-1980) - 1.1 (08-1970 A 04-1987)		<b>S1035</b> NO. 8546375 - 7700509247 - 7702042315 - 0854637500 - 7700639572 <b>SILENT-BLOC DA EXTREMIDADE DA CREMALHEIRA DA DIRECÇÃO</b> RENAULT R6 TT - R12 TT - R18
	460mm		FB9 - MP12
	<b>S1035-A</b> NO. 8546375 - 7700509247 - 7702042315 - 0854637500 - 7700639572 <b>SILENT-BLOC DA EXTREMIDADE DA CREMALHEIRA DA DIRECÇÃO</b> RENAULT R6 TT - R12 TT - R18		<b>T1149</b> NO. 7700687374 - 7702003408 - 7702107985 <b>BATENTE DA BARRA ESTABILIZADORA DA FRENTE</b> RENAULT 6 (118_) 1.1 Local de montagem: Eixo traseiro (07.71 A 04.80) 48cv 1108cc Hatchback
	d28x27mm		c20mm 1f-d10mm

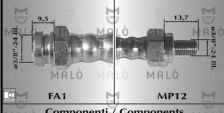
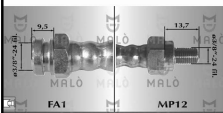

## RENAULT RODEO

	<b>RT08096</b> NO. 7701000239 - 7701348799 - 7701349268 - 7701365330 - 7701454835 - 7701582523 - 84140390 - 8422177 - 8... <b>TUBO DE TRAVÃO FRENTE LH-RH</b> RENAULT RODEO 4 0.8 (800 01) 34CV (08-1971 A 11-1981) - RODEO 6 0.8 (800.02) 34CV (05-1970 A 08-1973) - 1.1 (688.10) 48CV (08-1973 A 11-1981)		<b>RT08309</b> NO. 7700545267 - 7700627933 - 7700641119 - 7701348800 - 7701454836 - 7704001925 - 8414040 <b>TUBO DE TRAVÃO FRENTE LH-RH</b> RENAULT RODEO 4 0.8 (08-1971 A 11-1981) - RODEO 6 1.1 (08-1973 A 11-1981) - RODEO 5 1.1 (11-1981 A 12-1987)
	500mm		FA1 - MP12



## RENAULT SAFRANE

	<b>BE25</b> NO. 7701458595 - 7701450595 <b>ABRAÇADEIRA DE ESCAPE CÔNCAVA (58 mm)</b> RENAULT SAFRANE (1992 A 1996)		<b>E1067</b> NO. 55185382 <b>ESTICADOR DE ESCAPE</b> RENAULT SAFRANE (1992 A 1996)
	95x60x20mm		2p-d8mm
	<b>F0901A4I</b> NO. 7701466083 - 7701466983 <b>FOLE TRANSMISSÃO ESQUERDA LADO DA CAIXA C/ ROLAMENTO 28mm</b> RENAULT SAFRANE		<b>F1089-I</b> NO. <b>FOLE DA TRANSMISSÃO LADO DA RODA</b> RENAULT SAFRANE
	d115x90mm		1f-d88mm 1f-d28mm
	<b>F1329-I</b> NO. 7701472212 - 7701466349 - 7701470299 <b>FOLE DA TRANSMISSÃO JUNTO À CAIXA</b> RENAULT SAFRANE I 2.0i - 2.1 DT - 2.2i - 2.5 DT(1992 A 1996)		<b>F1687-I</b> NO. 7701469486 - 7701469487 <b>FOLE DA DIRECÇÃO ASSISTIDA DIREITO E ESQUERDO</b> RENAULT SAFRANE (APÓS 1998)
	d86x102mm		1f-d73mm 1f-d26mm

	<p><b>KF2529-T</b> NO. 7701469021</p> <p><i>KIT DE FOLE DO CARDAN JUNTO À RODA</i></p> <p>RENAULT SAFRANE I 2.0i - 2.1 DT - 2.2i - 2.5 DT - 3.0i Bi-T BACCARA 4X4 - 3.0i V6 (1992 A 1996)</p> <p>d110x140mm 1f-d88mm 1f-d27mm</p>		<p><b>KF2532</b> NO. 7701034800 - 7701467125</p> <p><i>FOLE DO LADO DA RODA</i></p> <p>RENAULT SAFRANE RN - RT 2.0 - 2.2 inj. - SAFRANE TURBO D 2.1 I</p> <p>d94x138mm 1f-d24mm 1f-d82mm</p>
	<p><b>KF2532-T</b> NO.</p> <p><i>KIT DE FOLE DO CARDAN LADO DA RODA</i></p> <p>RENAULT SAFRANE I 2.0i - 2.0i AUT. 03-95 A 10-96 - 2.1TD 10-92 A 10-96 - 2.2i 10-92 A 10-96</p> <p>d94x138mm 1f-d24mm 1f-d82mm</p>		<p><b>KF2534</b> NO.</p> <p><i>KIT DE FOLE</i></p> <p>RENAULT SAFRANE</p> <p>d95x128mm 1f-d80mm 1f-d26mm</p>
	<p><b>KF2539-T</b> NO. 7701470155</p> <p><i>KIT DE FOLE DO CARDAN JUNTO À RODA</i></p> <p>RENAULT SAFRANE II 2.0i 16V - 2.2 DT - 2.5i 20V - 2.9i 24V - 3.0i V6 (1996 A 2000)</p> <p>d110x150mm 1f-d98mm 1f-d30mm</p>		<p><b>M6051</b> NO. 7700766353 - 7700782519 - 6025308326 - 7700766355 - 3445663 - 3458510</p> <p><i>JUNTA DE ESCAPE</i></p> <p>RENAULT SAFRANE (1992 A 1996)</p> <p>d89x12.2mm 1f-d74.5mm</p>
	<p><b>M6076</b> NO. 7700823540</p> <p><i>JUNTA DE ESCAPE</i></p> <p>RENAULT SAFRANE (1992 A 1996)</p> <p>120x80mm 1f-d60mm</p>		<p><b>W5002</b> NO. 7700858731</p> <p><i>POLIE DA CAMBOTA (6 pistas)</i></p> <p>RENAULT SAFRANE (2.2 D mot. G8T)</p> <p>d136.9mm d15mm</p>
	<p><b>W5059</b> NO. 7431275801</p> <p><i>POLIE DA CAMBOTA (6 PISTAS)</i></p> <p>RENAULT SAFRANE</p> <p>d143/149mm d23mm</p>		<p><b>Z80474</b> NO. 7703077068</p> <p><i>Mola de painel</i></p> <p>RENAULT SAFRANE</p> <p>d18.5x13.5mm 1p-d7-12mm</p>
	<p><b>Z80533</b> NO. 7543023 - 7703081019 - 9759904480</p> <p><i>Mola de retenção</i></p> <p>RENAULT SAFRANE</p> <p>10x17x10mm 1p-7.2x14-9mm 1f-d4.2mm</p>		<p><b>Z80583</b> NO. 7703077117</p> <p><i>Mola de painel</i></p> <p>RENAULT SAFRANE</p> <p>d20x15.5mm 1p-d7.5-13.5mm</p>
	<p><b>Z80603</b> NO. 7703077256</p> <p><i>Mola de friso</i></p> <p>RENAULT SAFRANE</p> <p>18.6x13x9.5mm NULL</p>		<p><b>Z80608</b> NO. 7703077225 - 7518N8</p> <p><i>Mola de painel</i></p> <p>RENAULT SAFRANE</p> <p>d35x25mm 1p-d10.7-22.5mm</p>
	<p><b>Z80627</b> NO. 7703077345</p> <p><i>Mola de painel</i></p> <p>RENAULT SAFRANE</p> <p>d15x18.5mm 1p-d7.5-12.5mm</p>		<p><b>Z80629</b> NO. 7703077250</p> <p><i>Mola de painel</i></p> <p>RENAULT SAFRANE</p> <p>d15x19mm 1p-d8.5-12.5mm</p>

	<b>Z80633</b>	NO. 7703081054		<b>Z80671</b>	NO. 7703081190
	Mola de painel RENAULT SAFRANE			Mola de fixação RENAULT SAFRANE	
d30x17mm		1p-d9.7-15mm	d10x12mm		1p-d8-10mm 1f-d5.5mm

## RENAULT SCENIC II

	<b>A1934</b>	NO. 8200105505		<b>W5121</b>	NO. 8200767762 - 8200361247 - 12303-00Q0A - 4449456 - 4431160 - 93198633 - 04431160 - 12303-00Q1D - 9316...
	APOIO DO BATENTE DE ENCOSTO DO ESCAPE RENAULT SCÉNIC II (JM0/1_) 1.5 dCi (JM1F) (A Partir de 05.05) 86cv 1461cc Veículo multiuso - RENAULT SCÉNIC II (JM0/1_) 1.5 dCi (JM16) (A Partir de 01.07) 103cv 1461cc Veículo multiuso - RENAULT SCÉNIC II (JM0/1_) 1.5 dCi (JM1E) (A Partir de 05.05) 106cv 1461cc Veículo multiuso - RENAULT SCÉNIC II (JM0/1_) 1.9 dCi (JM15) (A Partir de 05.05) 110cv 1870cc Veículo multiuso - RENAULT SCÉNIC II (JM0/1_) 1.9 dCi (JM0G, JM12, JM1G, JM2C...etc. 60x60x55mm			POLIE DA CAMBOTA (7 PISTAS) RENAULT - SCÉNIC II (JM0/1_) - 2.0 dCi (JM1K) Código do mot or: M9R 700 - M9R 721 - M9R 722 (APÓS 09.05) 150cv 1995cc Veículo multiuso - RENAULT - GRAND SCÉNIC II (JM0/1_) - 2.0 dCi (JM1K) Código do mot or: M9R 700 - M9R 721 - M9R 722 (APÓS 09.05) 150cv 1995c	
	<b>W5137</b>	NO. 8200687605 - 8200699517 - 8200352613 - 8200395313 - 8200544135 - 8200552236 - 8200687605 - 820069951...			
	POLIE DA CAMBOTA 6 PISTAS RENAULT SCÉNIC II (JM0/1_) 1.4 (JM0B - JM0H - JM1A) Código do motor: K4J.7.40 (APÓS 06.03) 98cv 1390cc Veículo multiuso - RENAULT SCÉNIC II (JM0/1_) 1.6 16V (JM1R) Código do motor: K4M.8.12 - Código do motor: K4M.8.13 - Variante de equipamento: +AC (APÓS 10.05) 112cv 1598cc Veículo multiuso - RENAULT SCÉNIC II (JM0/1_) 1.6 (JM0C - JM0J - JM1B) Código do motor: K4M.7.61 (APÓS 06.03) 113cv 1598cc Veículo multiuso - RENAULT SCÉNIC I...etc. d155mm			d26mm	

## RENAULT SCENIC III

	<b>W5121</b>	NO. 8200767762 - 8200361247 - 12303-00Q0A - 4449456 - 4431160 - 93198633 - 04431160 - 12303-00Q1D - 9316...		<b>W5137</b>	NO. 8200687605 - 8200699517 - 8200352613 - 8200395313 - 8200544135 - 8200552236 - 8200687605 - 820069951...
	POLIE DA CAMBOTA (7 PISTAS) RENAULT - SCÉNIC III (JZ0/1_) - 2.0 dCi (JZ0Y) Código do mot or: M9R 615 (APÓS 02.09) 150cv 1995cc Veículo multiuso - RENAULT - SCÉNIC III (JZ0/1_) - 2.0 dCi (JZ0L) Código do mot or: M9R 610 (APÓS 04.09) 160cv 1995cc Veículo multiuso - RENAULT - GRAND SCÉ			POLIE DA CAMBOTA 6 PISTAS RENAULT SCÉNIC III (JZ0/1_) 1.6 16V (JZ0U) Código do motor: K4M.8.58 (APÓS 02.09) 110cv 1598cc Veículo multiuso - RENAULT SCÉNIC III (JZ0/1_) 1.6 E85 (JZ03) Código do motor: K4M.8.66 (APÓS 02.09) 110cv 1598cc Veículo multiuso - RENAULT SCÉNIC III (JZ0/1_) 1.5 dCi Código do motor: K9K.8.30 (APÓS 04.09) 86cv 1461cc Veículo multiuso - RENAULT SCÉNIC III (JZ0/1_) 1.5 dCi Código do motor: K9K.8.46 (APÓS 11.10) 95cv 1461cc Veículo m...etc.	
d155/157mm		31x38mm	d155mm		d26mm













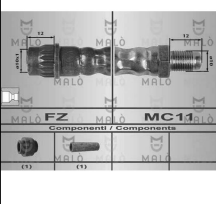
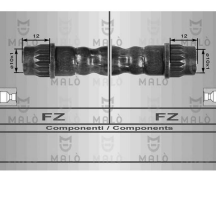
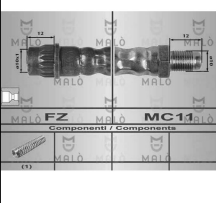

## RENAULT SPIDER

	<b>KF2529-T</b>	NO. 7701469021		
	KIT DE FOLE DO CARDAN JUNTO À RODA RENAULT SPORT SPIDER 2.0i 16V (1995 A 1999)			
d110x140mm		1f-d88mm 1f-d27mm		

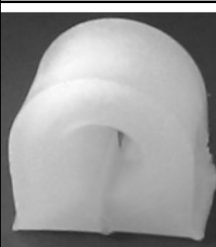
	<p><b>A1105</b> NO. 7700702890</p> <p>SUPORTE DA CAIXA DE VELOCIDADES</p> <p>RENAULT TRAFIC</p> <p>135x82x60mm 1f-d12mm</p>		<p><b>A1106</b> NO. 7700697879</p> <p>SUPORTE DO MOTOR</p> <p>RENAULT TRAFIC</p> <p>120x90x45mm 1p-d10-30mm</p>
	<p><b>A1107</b> NO. 7700745290</p> <p>SUPORTE DIREITO E ESQUERDO DO MOTOR</p> <p>RENAULT TRAFIC NOVA</p> <p>120x105x55mm 1p-d10-20mm</p>		<p><b>A1169</b> NO. 7700734718</p> <p>SUPORTE DO AMORTECEDOR</p> <p>RENAULT TRAFIC</p> <p>d175x50mm 5p-d7-20mm</p>
	<p><b>E0015</b> NO. 7700686449 - 7700795220</p> <p>ESTICADOR DE ESCAPE</p> <p>RENAULT TRAFIC</p> <p>87x31x26.5mm NULL</p>		<p><b>E0162</b> NO. 8200002870 - 54616-00QAC - 4408904 - 91167000</p> <p>ESTICADOR DA BARRA ESTABILIZADORA DA FRENTE</p> <p>RENAULT TRAFIC 1.7 - 2.1D - 2.2 (06-1986 A 10-1997)</p> <p>315x35x35mm 2d-d10-25mm</p>
	<p><b>E1001</b> NO. 7700655644 - 7704001364</p> <p>SUPORTE DE ESCAPE</p> <p>RENAULT TRAFIC</p> <p>d63x23mm NULL</p>		<p><b>E1013</b> NO. 7700632015</p> <p>ESTICADOR DE ESCAPE</p> <p>RENAULT TRAFIC</p> <p>d64x13mm 1f-d41mm</p>
	<p><b>E1117</b> NO. 2065100QAB</p> <p>ESTICADOR DO ESCAPE</p> <p>RENAULT TRAFIC II Autocarro (JL) 2.0 16V (A Partir de 08.06) 117cv 1998cc Autocarro - RENAULT TRAFIC II Autocarro (JL) 2.0 (JL0A) (A Partir de 03.01) 120cv 1998cc Autocarro - RENAULT TRAFIC II Autocarro (JL) 1.9 dCi 80 (JL0B) (A Partir de 03.01) 82cv 1870cc Autocarro - RENAULT TRAFIC II Autocarro (JL) 1.9 dCi 100 (JL0C) (A Partir de 03.01) 101cv 1870cc Autocarro - RENAULT TRAFIC II Autocarro (JL) 2.0 dCi 90 (JL0H) (A Partir de 08.06) 90...etc.</p> <p>68x40x38mm 2f-d12mm</p>		<p><b>F0663-I</b> NO. 7700680852</p> <p>FOLE DA DIRECÇÃO (F1062)</p> <p>RENAULT TRAFIC</p> <p>d65x200mm 1f-d10mm 1f-d32mm</p>
	<p><b>F0827-11</b> NO.</p> <p>FOLE DE TRANSMISSÃO DIREITO LADO DA CAIXA (PARA TRANSMISSÕES REPARADAS)</p> <p>RENAULT TRAFFIC</p> <p>d96x112mm 1f-d78mm 1f-d32mm</p>		<p><b>F0830-11</b> NO. 7701349696 - 7701349841 - 7701464758 - 7701468172</p> <p>FOLE DA TRANSMISSÃO JUNTO À CAIXA</p> <p>RENAULT TRAFIC 1.4 - 1.6 - 1.6 4X4 - 1.7 - 1.7i - 2.0 - 2.0 4X4 - 2.1 D - 2.1 D 4X4 - 2.2 - 2.2 4X4 - 2.5 D - 2.5 D 4X4 (1980 A 2001)</p> <p>d90x113mm 1f-d24mm 1f-d73mm</p>
	<p><b>F1061</b> NO. 7700774566</p> <p>FOLE DA DIRECÇÃO ESQUERDO E DIREITO (VIAT. C/ DIR. ASSIST.)</p> <p>RENAULT TRAFIC</p> <p>d73x100mm 1f-d39mm 1f-d10mm</p>		<p><b>F1063</b> NO.</p> <p>FOLE DA TRANSMISSÃO JUNTO À RODA</p> <p>RENAULT TRAFIC</p> <p>d100x126mm 1f-d82mm 1f-d23mm</p>
	<p><b>F1067</b> NO. 7701464758</p> <p>FOLE DO SEMI-EIXO JUNTO À CAIXA DE VELOCIDADES</p> <p>RENAULT TRAFIC - MASTER</p> <p>d90x110mm 1f-d72mm 1f-d23mm</p>		<p><b>F1070</b> NO.</p> <p>FOLE DO SEMI-EIXO JUNTO À CAIXA DE VELOCIDADES</p> <p>RENAULT TRAFIC (TODAS)</p> <p>d86x103mm 1f-d72mm 1f-d25mm</p>



	<p><b>F1072</b> NO. 7701013275</p> <p>FOLE DO SEMI-EIXO JUNTO À RODA</p> <p>RENAULT TRAFIC MODERNA</p> <p>d102x127mm 1f-d92mm 1f-d25mm</p>		<p><b>F1113-I</b> NO. 7701013275</p> <p>FOLE DO LADO DA RODA (JUNTA d98mm)</p> <p>RENAULT TRAFIC</p> <p>d108x150mm 1f-d25mm 1f-d85mm</p>
	<p><b>F1329-I</b> NO. 7701472212 - 7701466349 - 7701470299</p> <p>FOLE DA TRANSMISSÃO JUNTO À CAIXA</p> <p>RENAULT TRAFIC 1.9 D - 2.5 D (1989 A 2001)</p> <p>d86x102mm 1f-d73mm 1f-d26mm</p>		<p><b>F1701K3I</b> NO. 7701470910</p> <p>FOLE DA TRANSMISSÃO JUNTO À CAIXA</p> <p>RENAULT TRAFIC 1.9 DCi - 2.0i (APÓS 2001)</p> <p>d85x200mm 1f-d75mm 1f-d25mm</p>
	<p><b>F1827A-I</b> NO. 7701468573 - 7701470566</p> <p>FOLE DA TRANSMISSÃO JUNTO À CAIXA</p> <p>RENAULT TRAFIC 1.9 DCi - 2.0i</p> <p>d115x85mm 1f-d81mm 1f-d27.8mm</p>		<p><b>KF2362-T</b> NO. 7701473176</p> <p>KIT DE FOLE DO CARDAN JUNTO À RODA</p> <p>RENAULT TRAFIC (APÓS 2001) 1.9DCi - 2.0i</p> <p>d104x130mm 1f-d91mm 1f-d27mm</p>
	<p><b>KF2597</b> NO. 7701201810</p> <p>FOLE DO LADO DA RODA</p> <p>RENAULT TRAFIC GE98</p> <p>d108x128mm 1f-d25mm 1f-d64mm</p>		<p><b>KF2598</b> NO. 7701202237</p> <p>FOLE DO LADO DA RODA</p> <p>RENAULT TRAFIC GE92</p> <p>d99x122mm 1f-d23mm 1f-d82mm</p>
	<p><b>L1055</b> NO. 7700611100</p> <p>CASQUILHO DA BARRA ESTABILIZADORA</p> <p>RENAULT TRAFIC</p> <p>d30x27mm d26mm 1f-d9mm</p>		<p><b>L1080</b> NO. 7704001921</p> <p>CASQUILHO DE MOLAS DE TRÁS</p> <p>RENAULT TRAFIC</p> <p>d37x48mm d33mm 1f-d18mm</p>
	<p><b>M6052</b> NO. 7700781679 - 7700782520 - 8932001367 - 8933000112</p> <p>JUNTA DE ESCAPE</p> <p>RENAULT TRAFIC (APÓS 1989)</p> <p>d67x13.8mm 1f-d49.6mm</p>		<p><b>M6053</b> NO. 7700774367</p> <p>JUNTA DE ESCAPE</p> <p>RENAULT TRAFIC (APÓS 1988)</p> <p>105x75mm 1f-d55mm</p>
	<p><b>R220610</b> NO. 7700672946 - 7700727551</p> <p>TUBO DE RADIADOR SUPERIOR</p> <p>RENAULT TRAFIC DIESEL</p> <p>B250-d37/31mm 80-160-65mm</p>		<p><b>R220611</b> NO. 7700672945</p> <p>TUBO DE RADIADOR INFERIOR</p> <p>RENAULT TRAFIC DIESEL</p> <p>B160-d30/30mm 110-45-50mm</p>
	<p><b>R220612</b> NO. 7700667476</p> <p>TUBO INFERIOR DE LIGAÇÃO DA BOMBA DE ÁGUA AO RADIADOR</p> <p>RENAULT TRAFIC DIESEL</p> <p>B145-d37/31mm 65-70-50mm</p>		<p><b>R220613</b> NO. 7700720227</p> <p>TUBO DE AQUECIMENTO (FRENTE)</p> <p>RENAULT TRAFIC</p> <p>B340-d17/21mm 90-80-100-150-160-60mm</p>



	<p><b>R220614</b> NO. 7700720228</p> <p>TUBO DO AQUECIMENTO (FRENTE)</p> <p>RENAULT TRAFIC DIESEL</p>		<p><b>R220615</b> NO. 7700708441 - 522344800</p> <p>TUBO DO AQUECIMENTO (FRENTE)</p> <p>RENAULT TRAFIC DIESEL</p>
	<p><b>RT80200</b> NO. 8200003478 - 8200404264</p> <p>TUBO DE TRAVÃO FRENTE LH-RH</p> <p>RENAULT TRAFIC (MOD.2001) APÓS 03-2001</p>		<p><b>RT80201</b> NO. 8200003480</p> <p>TUBO DE TRAVÃO TRÁS LH-RH</p> <p>RENAULT TRAFIC (MOD.2001) APÓS 03-2001</p>
	<p><b>RT80252</b> NO. 8200003481</p> <p>TUBO DE TRAVÃO TRÁS LH-RH</p> <p>RENAULT TRAFIC II TT (APÓS 08-2001)</p>		<p><b>S1116</b> NO. 7700612542</p> <p>SILENT-BLOC DO ALTERNADOR</p> <p>RENAULT TRAFIC</p>
	<p><b>S1118</b> NO. 7700730733</p> <p>SILENT-BLOC DA SUSPENSÃO TRÁS</p> <p>RENAULT TRAFIC</p>		<p><b>S1330</b> NO. 7701349064</p> <p>SILENT-BLOC DO BRAÇO SUSPENSÃO FRENTE</p> <p>RENAULT TRAFIC BASE (1980 A 1997)</p>
	<p><b>T1010</b> NO. 7700001091</p> <p>BATENTE DE ESTABILIZADOR</p> <p>RENAULT TRAFIC</p>		<p><b>T1012</b> NO. 7700667186</p> <p>BATENTE CENTRAL DA BARRA ESTABILIZADORA</p> <p>RENAULT TRAFIC</p>
	<p><b>T1054</b> NO. 7700667182</p> <p>BATENTE DA BARRA ESTABILIZADORA</p> <p>RENAULT TRAFIC</p>		<p><b>T1081</b> NO. 7700667184</p> <p>BATENTE DA BARRA ESTABILIZADORA DA FRENTE (Furo 22.4mm)</p> <p>RENAULT TRAFIC</p>
	<p><b>U7010</b> NO. 8200059541</p> <p>TENSORES CORREIA ALTERNADOR</p> <p>RENAULT TRAFIC DCi</p>		<p><b>W5032</b> NO. 7700853469</p> <p>POLIE DA CAMBOTA (1 PISTA)</p> <p>RENAULT TRAFIC 2.1D - 2.1TD MOTORES J85 (740) (786)</p>
	<p><b>W5038</b> NO. 8200802664 - 8200051126 - 8200213058 - 8200207436 - 8200664348 - 8200196546 - 8200555547 - 820046808...</p> <p>POLIE DA CAMBOTA (6 PISTAS)</p> <p>RENAULT TRAFIC 2001</p>		<p><b>W5061</b> NO. 7700853774</p> <p>POLIE DA CAMBOTA (2 PISTAS)</p> <p>RENAULT TRAFIC</p>

	<b>W5068</b> NO. 7700115766 - 8200386446 - 7700113776 - 8200386451 - 8200079183 - 8200689705 - 7700739905 - 4413749 - ... POLIE DA CAMBOTA (6 PISTAS) RENAULT TRAFIC d151/155mm d12.6mm		<b>W5071</b> NO. 7700856673 POLIE DA CAMBOTA (6 PISTAS) RENAULT TRAFIC 1.9 DCi d132mm d12.6mm
	<b>W5083</b> NO. 8200207435 - 8200162582 - 8200664350 - 8200555549 - 8200802666 - 8200458171 - 8200097903 POLIE DA CAMBOTA (7 PISTAS) RENAULT - TRAFIC II Autocarro (JL) - 2.5 dCi 115 114CV 2464cc (APÓS 02-2008) - 2.5 dCi 135 (JL0D) 135CV 2464cc (APÓS 05-2003) - 2.5 dCi 145 (JL0J) 146CV 2464cc (APÓS 08-2006) - TRAFIC II Caixa (FL) - 2.5 dCi 135 (FL0D) 135CV 2464cc (APÓS 05-2003) - 2.5 d d152/162mm d30/58mm		<b>W5121</b> NO. 8200767762 - 8200361247 - 12303-0000A - 4449456 - 4431160 - 93198633 - 04431160 - 12303-00Q1D - 9316... POLIE DA CAMBOTA (7 PISTAS) RENAULT - TRAFIC II Autocarro (JL) - 2.0 dCi 90 (JL0H) Código do mot or: M9R 782 (APÓS 08.06) 90cv 1995cc Autocarro - RENAULT - TRAFIC II Autocarro (JL) - 2.0 dCi 115 (JL0H) Código do mot or: M9R 780 - M9R 782 - M9R 786 - M9R 692 - M9R 630 (APÓS 08.06) 114cv d155/157mm 31x38mm
	<b>Z80583</b> NO. 7703077117 Mola de painel RENAULT TRAFIC d20x15.5mm 1p-d7.5-13.5mm		<b>Z80671</b> NO. 7703081190 Mola de fixação RENAULT TRAFIC d10x12mm 1p-d8-10mm 1f-d5.5mm
	<b>Z80825</b> NO. Mola Renault Trafic II 12x7x10.6mm 1p-6x4.5-8.5mm		<b>Z80837</b> NO. 7703077434 Mola de painel RENAULT TRAFIC (2) d15.3x20.5mm 1p-d8-14mm
	<b>Z80840</b> NO. 7703072352 Rebite RENAULT TRAFIC (2) d17x18mm 1p-d6.2-10mm		

## RENAULT TWINGO

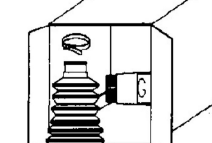
	<b>BE25</b> NO. 7701458595 - 7701450595 ABRAÇADEIRA DE ESCAPE CÔNCAVA (58 mm) RENAULT TWINGO (APÓS 1993) 95x60x20mm 2p-d8mm		<b>F1089-I</b> NO. FOLE DA TRANSMISSÃO LADO DA RODA RENAULT TWINGO 1.3 (APÓS 1994) d93x110mm 1f-d80mm 1f-d22mm
	<b>F1329-I</b> NO. 7701472212 - 7701466349 - 7701470299 FOLE DA TRANSMISSÃO JUNTO À CAIXA RENAULT TWINGO 1.2i (APÓS 2003) d86x102mm 1f-d73mm 1f-d26mm		<b>KF2532</b> NO. 7701034800 - 7701467125 FOLE DO LADO DA RODA RENAULT TWINGO d94x138mm 1f-d24mm 1f-d82mm

	<p><b>RT08445</b> NO. 7700804356 - 7700824736</p> <p>TUBO DE TRAVÃO FRENTE LH-RH</p> <p>RENAULT TWINGO TT (APÓS 1993)</p>		<p><b>RT08496</b> NO. 7704003887 - 7704003949</p> <p>TUBO DE TRAVÃO FRENTE LH-RH</p> <p>RENAULT TWINGO 1.2 (APÓS 03-1993) - 1.2 16V (APÓS 08-2004) - FURGONATO 1.2 (APÓS 03-1993)</p>
	<p>267mm FZ - MC11</p>		<p>270mm FZ - MC11</p>
	<p><b>RT08501</b> NO. 7701349305 - 7704001950 - 7704003549 - 7700541132 - 7704003931</p> <p>TUBO DE TRAVÃO TRÁS LH-RH</p> <p>RENAULT TWINGO TT (ATÉ 04-1996)</p>		<p><b>S1130</b> NO. 7700819929</p> <p>SILENT-BLOC ESQUERDO DO BRAÇO DE SUSPENSÃO FRENTE</p> <p>RENAULT TWINGO</p>
	<p>270mm FZ - FZ</p>		<p>d36x46mm c34mm 1f-d12mm</p>
	<p><b>S1132</b> NO. 7700831364</p> <p>SILENT-BLOC DIREITO DO BRAÇO DA SUSPENSÃO FRENTE</p> <p>RENAULT TWINGO</p>		<p><b>W5106</b> NO. 8200477938 - 8200511194 - 8200185800 - 8200184103</p> <p>POLIE DA CAMBOTA (6 PISTAS)</p> <p>RENAULT TWINGO 1.5 dCi (CN0E) (K9K 740) 64CV (APÓS 03-2007)</p>
	<p>d49x46mm d38mm 1f-d12mm</p>		<p>d155/151mm d26mm</p>
	<p><b>W5108</b> NO. 8200392697</p> <p>POLIE DA CAMBOTA (5 PISTAS)</p> <p>RENAULT TWINGO 1.5 dCi (CN0E)(K9K 740) 64CV (APÓS 03-2007) - 1.5 dCi (CN0U)(K9K 718) 84CV (APÓS 04-2008) - 1.5 dCi(K9K 820) 75CV (APÓS 10-2010) - 1.5 dCi 90(K9K 830) 86CV (APÓS 10-2010) - 1.6 RS (CN0N - CN0R - CN0S)(K4M 854) 133CV (APÓS 05-2008)</p>		<p><b>W5111</b> NO. 8200352613 - 8200552236 - 8200699517 - 8200544135 - 8200687605 - 8200395313 - 7700105788 - 820004405...</p> <p>POLIE DA CAMBOTA(6 PISTAS)</p> <p>RENAULT TWINGO (CN0_) 1.6 RS (CN0N - CN0R - CN0S) (K4M 854) 133CV (APÓS 05-2008)</p>
	<p>NULL d153.4mm 1f-d26mm</p>		<p>d155-151mm d26mm</p>
	<p><b>Z80474</b> NO. 7703077068</p> <p>Mola de painel</p> <p>RENAULT TWINGO</p>		<p><b>Z80608</b> NO. 7703077225 - 7518N8</p> <p>Mola de painel</p> <p>RENAULT TWINGO</p>
	<p>d18.5x13.5mm 1p-d7-12mm</p>		<p>d35x25mm 1p-d10.7-22.5mm</p>
	<p><b>Z80629</b> NO. 7703077250</p> <p>Mola de painel</p> <p>RENAULT TWINGO</p>		<p><b>Z80633</b> NO. 7703081054</p> <p>Mola de painel</p> <p>RENAULT TWINGO</p>
	<p>d15x19mm 1p-d8.5-12.5mm</p>		<p>d30x17mm 1p-d9.7-15mm</p>
	<p><b>Z80670</b> NO. 7703077341</p> <p>Mola de friso</p> <p>RENAULT TWINGO</p>		<p><b>Z80671</b> NO. 7703081190</p> <p>Mola de fixação</p> <p>RENAULT TWINGO</p>
	<p>33x10x8mm NULL</p>		<p>d10x12mm 1p-d8-10mm 1f-d5.5mm</p>
	<p><b>Z80737</b> NO. 7703077435</p> <p>Mola de painel</p> <p>RENAULT TWINGO</p>		<p><b>Z80815</b> NO. 7703072360 - 0151500QAB</p> <p>NULL</p> <p>RENAULT TWINGO</p>
	<p>d35.5x25.5mm 1p-d12.5-22.5mm</p>		<p>d18x26mm 1p-d8.5-14mm</p>

	<b>Z80838</b>	NO. 6991.Y8 - 7703077468 - 7703077469 - 8201112162		
	Mola RENAULT TWINGO			
	d17x18.5mm	1p-d7.5-10.5mm		

## RENAULT VEL SATIS

	<b>A1782</b>	NO. 8200052028 - 8200181590		<b>F1701K3I</b>	NO. 7701470910
	APOIO DO MOTOR FRENTE LADO DIREITO RENAULT - VEL SATIS 3.5 V6 (BJOR - BJOV - BJOU) 241 CV (APÓS 06-2002) - 2.0 dCi (BJO3) 150CV (APÓS 08-2005) - 2.0 dCi 8BJO3 - BJOB) 173CV (APÓS 01-2006) - 2.2 dCi (BJOH) 116CV (APÓS 04-2004) - 2.2 dCi (BJOE - BJOF - BJOG - BJOH) 140CV (APÓS 09-2004) - 2.2 dCi (				FOLE DA TRANSMISSÃO JUNTO À CAIXA RENAULT VELSATIS 2.0i T (APÓS 2002)
	180x130x120mm	1p-d10-32mm 3f-d10.5mm		d85x200mm	1f-d75mm 1f-d25mm
	<b>F1827-I</b>	NO. 7701207566		<b>KF1686-T</b>	NO. 7701473176
	FOLE DA TRANSMISSÃO JUNTO À CAIXA RENAULT VELSATIS 2.0i T 16V - 2.2 DCi (APÓS 2002)				KIT DE FOLE DO CARDAN JUNTO À RODA RENAULT VELSATIS 2.0iT - 2.2 Dci - 3.5i (APÓS 2002)
	d115x85mm	1f-d73mm 1f-d42mm		d105x130mm	1f-d90mm 1f-d27mm
	<b>W5083</b>	NO. 8200207435 - 8200162582 - 8200664350 - 8200555549 - 8200802666 - 8200458171 - 8200097903		<b>Z80815</b>	NO. 7703072360 - 0151500QAB
	POLIE DA CAMBOTA (7 PISTAS) RENAULT - VEL SATIS (BJO_) - 2.2 dCi (BJOH) Veículo multiuso 116CV 2188cc (APÓS 04-2004) - 2.2 dCi (BJOE - BJOF - BJOG - BJOH) veículo multiuso 140CV 2188cc (APÓS 09-2004) - 2.2 dCi (BJOE - BJOF) Veículo multiuso 150CV 2188cc (APÓS 06-2002)				NULL RENAULT VELSATIS
	d152/162mm	d30/58mm		d18x26mm	1p-d8.5-14mm