









| | | | |
|---|---|--|--|
|  | <p>E0013 NO. 852715 - 852716 - 852720</p> <p>ESTICADOR DE ESCAPE</p> <p>OPEL COMMODORE C (APÓS 78)</p> <p>66x56x13mm NULL</p> |  | <p>F1041-20 NO.</p> <p>FOLE DA ALAVANCA DE VELOCIDADES</p> <p>OPEL</p> <p>d150x80mm 1f-d20mm</p> |
|  | <p>L0218 NO.</p> <p>CASQUILHO</p> <p>OPEL</p> <p>d32x34mm d27mm 1f-d15mm</p> |  | <p>N2002 NO. 1719466 - 113E5381B - 030540081</p> <p>ANEL DE ESCAPE</p> <p>OPEL 1900 GT</p> <p>d43x12mm 1f-d19mm</p> |
|  | <p>T0001-E NO. 856516 - 856521</p> <p>BATENTE DE ESCAPE</p> <p>OPEL COMMODORE C (1978 A 1983) - SENATOR - MONZA (1978 A 1987)</p> <p>NULL NULL</p> |  | <p>U0007 NO.</p> <p>TAPA-FURO</p> <p>OPEL</p> <p>d45mm e1mm d40mm</p> |
|  | <p>Z00531 NO. 1470998 - 207217563 - N0154322</p> <p>Mola porca rápida</p> <p>OPEL (TODOS)</p> <p>24.6x16.2x5.5mm 1f-d6.3mm</p> |  | <p>Z00538 NO. 2072077</p> <p>Mola porca rápida</p> <p>Opel</p> <p>21x13x4mm 1f-d5.5mm</p> |
|  | <p>Z10502 NO.</p> <p>Mola de fixação</p> <p>OPEL (TODOS)</p> <p>d12x11mm 1p-d4.8-12.4mm 1f-d3mm</p> |  | <p>Z80470 NO. 164361 - 7703072177</p> <p>Mola de fixação</p> <p>OPEL (TODOS)</p> <p>d5x45mm NULL</p> |
|  | <p>Z80488 NO. 1216904</p> <p>Mola de fixação</p> <p>OPEL (TODOS)</p> <p>25x15x16mm NULL</p> |  | <p>Z80555 NO.</p> <p>Mola de friso</p> <p>Opel</p> <p>30x16.5x6mm NULL</p> |
|  | <p>Z80582 NO.</p> <p>Mola de painel</p> <p>OPEL (TODOS)</p> <p>d16x20mm 1p-d10-19mm</p> |  | <p>Z80656 NO. 90355604</p> <p>Mola de friso</p> <p>OPEL (TODOS)</p> <p>22x18x11mm 1p-8x3-9mm</p> |
|  | <p>Z80684 NO. 1800940 - 90127883 - 16131176747</p> <p>Mola de retenção</p> <p>OPEL (TODOS)</p> <p>d16x10mm 1f-d6mm</p> |  | <p>Z80750 NO. 51471904317 - N90201601H - 2207713 - 6998849</p> <p>Mola de painel</p> <p>OPEL (TODOS)</p> <p>d20x23mm 1p-d9-20mm</p> |

OPEL AGILA

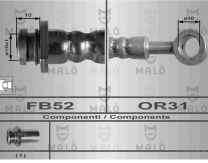
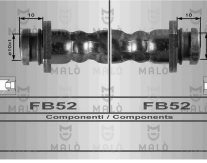
| | | | |
|---|---|---|--|
|  | F1820-I NO. 4705777 FOLE DA TRANSMISSÃO JUNTO À CAIXA OPEL AGILA 1.0i 12V - 1.2i 16V (APÓS 2000) |  | F1829H-I NO. 1603005 - 20424726 - 26067603 - 26070498 FOLE DA TRANSMISSÃO JUNTO À RODA OPEL AGILA 1.0i 12V - 1.2i 16v (APÓS 2000) |
| | d85x88mm 1f-d73mm 1f-d19mm | | d90x130mm 1f-d72mm 1f-d23mm |
|  | KF2371-T NO. 1603005 - 20424726 - 26067603 - 26070498 KIT DE FOLE DO CARDAN JUNTO À RODA OPEL AGILA 1.0i 12V - 1.2i 16v (APÓS 2000) |  | Q2009 NO. UNIÃO DE ESCAPE 48/45x80mm OPEL - AGILA (A) (H00) - 1.3 CDTi (08.03 - 12.07) 70cv 1248cc Hatchback |
| | d88x126mm 1f-d72mm 1f-d23mm | | 80x77x55mm 1f-d45/48mm |
|  | RT08932 NO. 4700362 - 9204000 - 5155083E00 TUBO DE TRAVÃO FRENTE LH-RH OPEL AGILA TT APÓS 09-2000 |  | RT08933 NO. 4701124 - 9206661 - 5177076G00 - 5157076G00 TUBO DE TRAVÃO TRÁS LH-RH OPEL AGILA TT APÓS 09-2000 |
| | 440mm FB52 - OR31 | | 305mm FB52 - FB52 |
|  | W5054 NO. 5614438 - 614150 - 93177317 - 93194443 - 0614150 POLIE DA CABBOTA (6 PISTAS) OPEL AGILA 1.3 CDTi 16v APÓS 08-2003 - Mtr Z13DT (70CV) | | |
| | d165mm d35mm | | |

OPEL ARENA

| | | | |
|--|---|--|--|
|  | F1329-I NO. 4403963 - 4403971 FOLE DA TRANSMISSÃO JUNTO À CAIXA OPEL ARENA 1.9 D - 1.9 DTi - 2.5 D - 2.8 DTi (1998 A 2001) |  | KM0431 NO. 7704001921 KIT BRINCOS MOLAS TRÁS OPEL ARENA Caixa 1.9 D (01.97 A 12.01) 60cv 1870cc Caixa - OPEL ARENA Caixa 2.5 D (01.97 A 12.01) 75cv 2499cc Caixa - OPEL ARENA Autocarro 1.9 D (01.97 A 12.01) 60cv 1870cc Autocarro - OPEL ARENA Autocarro 2.5 D (01.97 A 12.01) 75cv 2499cc Autocarro |
| | d86x102mm 1f-d73mm 1f-d26mm | | 145x105x45mm d34mm |

OPEL ASCONA (A)-(B)-(C)

| | | | |
|--|---|---|---|
|  | A1406 NO. 0650702 - 90233962 SUPORTE DO FILTRO DE ÓLEO OPEL ASCONA C |  | A1634 NO. 684189 - 684234 - 90189477 APOIO DO MOTOR PARTE DA FRENTE ESQUERDO OPEL ASCONA C 1.6 - 1.8 - 2.0 |
| | d20x15mm 1p-d6-10mm 1p-d6-15mm | | 110x90x65mm 2p-d10-26mm 2f-d10mm |

| | | | |
|---|---|--|--|
|  | <p>C0233 NO. 1160724 - 90054143</p> <p>BOTÃO AFINAÇÃO CAPÔT</p> <p>OPEL ASCONA C (81_86_87_88_) 1.3 N (09.81 A 08.86) 60cv 1297cc três volumes - OPEL ASCONA C (81_86_87_88_) 1.3 S (09.81 A 08.88) 75cv 1297cc três volumes - OPEL ASCONA C (81_86_87_88_) 1.6 (09.81 A 09.87) 75cv 1598cc três volumes - OPEL ASCONA C (81_86_87_88_) 1.6 i (09.87 A 08.88) 75cv 1598cc três volumes - OPEL ASCONA C (81_86_87_88_) 1.6 i Cat (09.86 A 08.88) 75cv 1598cc três volumes - OPEL ASCONA C (81_86_87_88_) etc.</p> <p>d19x31mm NULL</p> |  | <p>E0035 NO. 856524</p> <p>ESTICADOR DE ESCAPE</p> <p>OPEL ASCONA C 1.3 (1981 A 1989)</p> <p>58x42x42mm NULL</p> |
|  | <p>E1003 NO. 856519</p> <p>SUPORTE TRÁS DO ESCAPE</p> <p>OPEL ASCONA B - MANTA B</p> <p>50x44x42mm 2f-d5mm 2f-18x9mm</p> |  | <p>F0460-I NO. 322506</p> <p>FOLE DA CREMALHEIRA DA DIRECÇÃO ESQ. E DIR.</p> <p>OPEL ASCONA B (66 A 73)</p> <p>d70x190mm 1f-d22mm 1f-d40mm</p> |
|  | <p>F0465-I NO. 322501</p> <p>FOLE DA CREMALHEIRA DA DIRECÇÃO ESQ. E DIR.</p> <p>OPEL ASCONA A (63 A 66)</p> <p>d75x160mm d52mm 1f-d40mm 1f-d33mm</p> |  | <p>F0466-I NO. 902825 - 902828 - 9105983 - 90090811</p> <p>FOLE DA CREMALHEIRA DA DIRECÇÃO ESQ. E DIR.</p> <p>OPEL ASCONA C (APÓS 79)</p> <p>d78x165mm 1f-d41mm 1f-d51mm</p> |
|  | <p>F0481-I NO. 374019 - 90095087</p> <p>FOLE DO SEMI-EIXO EXTERNO</p> <p>OPEL ASCONA (C) 1.0 - 1.2 - C1.3 1.3S - 1.6 - 1.8 (8-79 a 83)</p> <p>d100x80mm 1f-d20mm 1f-d75mm</p> |  | <p>F0519-I NO. 374040 - 90129014 - 90112609</p> <p>FOLE DO SEMI-EIXO LADO DA CAIXA DE VELOCIDADES</p> <p>OPEL ASCONA (C) 1.6 (1981 A 1988) - 1.6i (1982 A 1988) - 1.8 (1987 A 1988) - 1.8i (1982 A 1986)</p> <p>d88x97mm 1f-d66mm 1f-d21mm</p> |
|  | <p>F0520-I NO. 90095162 - 374018</p> <p>FOLE DO SEMI-EIXO INTERNO (F1026)</p> <p>OPEL ASCONA (C) 1.3S (1981 A 1988) - 1.3N (1981 A 1986)</p> <p>d72x94mm 1f-d54mm 1f-d19mm</p> |  | <p>F1305-I NO. 1609074 - 26024585 - 0902828</p> <p>FOLE DA DIRECÇÃO ASSISTIDA LADO DIREITO E ESQUERDO</p> <p>OPEL ASCONA (C) 1.3S - 1.3N - 1.6S - 1.6D - 1.8 - 1.8E - 2.0i - 2.0iGT</p> <p>d78x170mm 1f-d54mm 1f-d42mm</p> |
|  | <p>F1373-I NO. 1603141 - 374040 - 90009020 - 90112609 - 90421756</p> <p>FOLE DA TRANSMISSÃO JUNTO À CAIXA</p> <p>OPEL ASCONA C 1.6 - 1.6S - 1.6i - 1.8 - 1.8i - 2.0i - 2.0iGT (81 A 88)</p> <p>d87x99mm 1f-d65mm 1f-d22mm</p> |  | <p>KF2300 NO. 374019 - 90095087 - 6152107500002</p> <p>FOLE DO LADO DA RODA</p> <p>OPEL ASCONA (C) 1.0 - 1.2 - 1.3 C</p> <p>d96x79mm 1f-d19mm 1f-d77mm</p> |
|  | <p>KF2310 NO. 374040</p> <p>FOLE DO LADO DA RODA</p> <p>OPEL ASCONA C - DIESEL - 1.6 - 1.8 PETROL</p> <p>d90x79mm 1f-d22mm 1f-d83mm</p> |  | <p>L3020 NO. 856700</p> <p>CASQUILHO DE ESCAPE</p> <p>OPEL ASCONA C (1981 A 1988)</p> <p>NULL NULL</p> |
|  | <p>M6036 NO. 854926 - 02886931 - 02886093</p> <p>JUNTA DE ESCAPE</p> <p>OPEL ASCONA (B) (1971 A 1979)</p> <p>96x60mm 2f-d36mm</p> |  | <p>M6041 NO. 854929 - 90091769</p> <p>JUNTA DE ESCAPE</p> <p>OPEL ASCONA (B) (1979 A 1982) - ASCONA (C) (1981 A 1986)</p> <p>142x68mm 2f-d50mm</p> |

| | | | |
|--|--|--|--|
|  | <p>N2001 NO. 852707 - 852712</p> <p>ANEL DE ESCAPE TRÁS</p> <p>OPEL ASCONA (A) (1972 A 1975)</p> <p>d70x14mm 1f-d46mm</p> |  | <p>N2335 NO. 852713</p> <p>ANEL ESCAPE</p> <p>OPEL ASCONA (C) (1981 A 1998) - ASCONA (B) (1975 A 1979)</p> <p>d65x15mm 1f-d36mm</p> |
|  | <p>N2336 NO. 852711 - 9275338</p> <p>ANEL ESCAPE</p> <p>OPEL ASCONA (A) (1970 A 1975)</p> <p>d62x14mm 1f-d36mm</p> |  | <p>N4021 NO. 852713</p> <p>ANEL DE ESCAPE</p> <p>OPEL ASCONA (B) (1975 A 1982) - ASCONA (C) (1981 A 1988)</p> <p>d60x14mm 1f-d33mm</p> |
|  | <p>P1012 NO. 560808</p> <p>CAPA DE PEDAL DO TRAVÃO E EMBRAIAGEM</p> <p>OPEL ASCONA (C) (1981 A 1988)</p> <p>60x55x9mm NULL</p> |  | <p>R220073 NO. 1336782 - 1336791 - 1336839</p> <p>TUBO DE RADIADOR SUPERIOR</p> <p>OPEL ASCONA (A) 1.25 (1972 A 1975)</p> <p>B340-d34/38mm 115-160-140mm</p> |
|  | <p>R220237 NO. 1336212 - 1336864</p> <p>TUBO DE RADIADOR INFERIOR</p> <p>OPEL ASCONA (B) 1.2 (1976 A 1979)</p> <p>NULL NULL</p> |  | <p>R220254 NO. 1336783 - 1336749</p> <p>TUBO INFERIOR SAÍDA ÁGUA DO RADIADOR</p> <p>OPEL ASCONA (A) 1.25 (1972 A 1975)</p> <p>B250-d45/35mm 75-175-85mm</p> |
|  | <p>R220255 NO. 1336863 - 9281830</p> <p>TUBO DE RADIADOR SUPERIOR</p> <p>OPEL ASCONA (B) 1.2 (1976 A 1979)</p> <p>B360-d40/40mm 125-240-80mm</p> |  | <p>R220260 NO. 1336788</p> <p>TUBO DE RADIADOR SUPERIOR</p> <p>OPEL ASCONA (A) 1.25 (1972 A 1975) - ASCONA (B) (1976 A 1979)</p> <p>B260-d34/34mm 60-150-115-75mm</p> |
|  | <p>R220284 NO. 1336250 - 90091138 - 1336316 - 90169012</p> <p>TUBO DE RADIADOR SUPERIOR</p> <p>OPEL ASCONA (C) 1.3N (1981 A 1986)</p> <p>B225-d34/34mm 120-80-115mm</p> |  | <p>S1275 NO. 402642 - 90189050</p> <p>SILENT-BLOC DA SUSPENSÃO DE TRÁS</p> <p>OPEL ASCONA (C) TODAS MOTORIZAÇÕES (1981 A 1988)</p> <p>d56x75mm c63mm d47mm</p> |
|  | <p>Y3000 NO. 854980 - 854977 - 854917 - 90128081</p> <p>PARAFUSO MOLA DE ESCAPE</p> <p>OPEL ASCONA C (1981 A 1989)</p> <p>82x13mm 1p-d10-20mm</p> |  | <p>Y3004 NO. 854982 - 90128082</p> <p>PARAFUSO ESCAPE</p> <p>OPEL ASCONA (C) (1986 A 1988)</p> <p>d19x65mm d12mm 1r-d10mm</p> |
|  | <p>Z80554 NO. 174837</p> <p>Mola de friso</p> <p>OPEL ASCONA (C) (Após 1982)</p> <p>56x38.5x5mm NULL</p> |  | <p>Z9000 NO. 854880 - 854881 - 858884 - 25501711 - 90234204</p> <p>MOLA DE ESCAPE 42mm</p> <p>OPEL ASCONA (C) (1982 A 1988)</p> <p>d18x26mm NULL</p> |

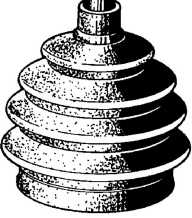
| | | | | | |
|--|---|----------------------------------|--|---|-------------------|
|  | A1406 | NO. 0650702 - 90233962 |  | E1003 | NO. 856519 |
| | SUPORTE DO FILTRO DE ÓLEO OPEL ASTRA | | | SUPORTE TRÁS DO ESCAPE OPEL ASTRA 1.4 - 1.6 - 1.8 - 2.0 - ASTRA DIESEL 1.7 - ASTRA TURBO DIESEL 1.7 | |
| | d20x15mm | 1p-d6-10mm 1p-d6-15mm | | 50x44x42mm | 2f-d5mm 2f-18x9mm |
|  | F0481-I | NO. 90095087 |  | H770 | NO. |
| | FOLE DO SEMI-EIXO LADO DA RODA OPEL ASTRA 1.3 (DESDE 82) | | | PALA ORIGINAL OPEL ASTRA VAN | |
| | d100x80mm | 1f-d20mm 1f-d75mm | | 480x220mm | NULL |
|  | R8078 | NO. 1336328 - 1337393 - 90570033 |  | Z80743 | NO. 2345957 |
| | TUBO DE LIGAÇÃO À BOMBA DE ÁGUA OPEL ASTRA 2.0 16v | | | Mola de painel OPEL ASTRA | |
| | B171-d40/34mm d27mm | 45-90-45mm 85-80mm | | d17x19mm | 1p-d9-13mm |
|  | Z80747 | NO. 1406925 |  | Z80822 | NO. 912466 |
| | Mola de fixação OPEL ASTRA | | | Mola de painel OPEL ASTRA | |
| | d16x21.5mm | 1p-d6-10.5mm | | d14x15mm | 1p-d5.5-13mm |

OPEL ASTRA F











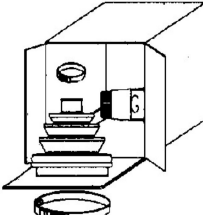

| | | | | | |
|---|--|------------------------------|--|--|---|
|  | A1210 | NO. 682556 - 682601 - 684648 |  | A1213 | NO. 682566 - 682504 - 682558 |
| | APOIO TRÁS DE MOTOR OPEL ASTRA (F) 1.4 - 1.4i - 1.6 - 1.6i - 1.7D - 1.7TDS (1991 A 2005) - ASTRA (G) 1.6 - 1.6 16v (1998 A 2005) | | | APOIO TRÁS DE MOTOR OPEL ASTRA (F) 1.7TD - 1.8i - 1.8s 16v - 2.0i - 2.0i 16v (1991 A 2001) | |
| | 150x98x57mm | 2p-d10-20mm 2f-d10mm | | 150x98x57mm | 2p-d10-20mm 2f-d10mm |
|  | A1216 | NO. 344517 |  | A1392 | NO. 684291 - 6844283 - 6844282 - 684282 |
| | APOIO DO AMOTECEDOR DA FRENTE OPEL ASTRA (F) TODAS MOTORIZAÇÕES (1991 A 2001) | | | APOIO DO MOTOR FRENTE DIREITO OPEL ASTRA (F) 1.4 - 1.4i - 1.6i 16v - 1.7 DIESEL - 1.8i 16v - 2.0i 16v (1991 A 1997) | |
| | 150x130x43mm | 1f-d32mm 1f-d14mm | | 185x95x67mm | 2f-d11mm |
|  | A1394 | NO. 684646 - 90372425 |  | A1553 | NO. 684644 - 90335498 |
| | APOIO MOTOR FRENTE DIREITO OPEL ASTRA (F) 1.8i - 1.8i 16v - 2.0i - 2.0i 16v - (1991 A 2001) | | | APOIO DO MOTOR FRENTE LADO DIREITO OPEL ASTRA (F) (91 A 98) 1.7 TD - 1.7TDS | |
| | 175x95x60mm | 1f-d12mm | | 180x95x80mm | NULL |

| | | | |
|--|--|---|--|
|  | <p>A1646 NO. 684681 - 90497967</p> <p>APOIO DO MOTOR PARTE DA FRENTE ESQUERDO</p> <p>OPEL ASTRA (F) 1.8 - 2.0</p> <p>d105x135mm 1p-d10-44mm 1p-d10-25mm</p> |  | <p>C0233 NO. 1160724 - 90054143</p> <p>BOTÃO AFINAÇÃO CAPÔT</p> <p>OPEL ASTRA F Hatchback (53_54_58_59_) 1.4 i (03.92 A 01.98) 60cv 1389cc Hatchback - OPEL ASTRA F Hatchback (53_54_58_59_) 1.4 (09.91 A 09.93) 75cv 1389cc Hatchback - OPEL ASTRA F Hatchback (53_54_58_59_) 1.4 Si (03.92 A 01.98) 82cv 1389cc Hatchback - OPEL ASTRA F Hatchback (53_54_58_59_) 1.4 (09.92 A 01.98) 82cv 1389cc Hatchback - OPEL ASTRA F Hatchback (53_54_58_59_) 1.4 i 16V (01.96 A 01.98) 90cv 1389cc Hatchback - OPEL...etc.</p> <p>d19x31mm NULL</p> |
|  | <p>E0085 NO. 350261 - 90278577</p> <p>ESTICADOR DA PONTA BARCA ESTABILIZADORA DA FRENTE (BARRA DE 18MM)</p> <p>OPEL ASTRA (F) 1.4 - 1.4 16v - 1.6 - 1.6 16v - 1.7D - 1.7TD - 1.8 - 1.8 16v - 2.0 - 2.0 16v (1991 A 1998)</p> <p>110x40x35mm NULL</p> |  | <p>E0128 NO. 350263 - 90495045 - 4544599</p> <p>ESTICADOR DA BARRA ESTABILIZADORA DA FRENTE</p> <p>OPEL ASTRA (F) TT</p> <p>105x34x34mm 1p-d12-25mm</p> |
|  | <p>E0147 NO. 350260 - 90278579 - 90278586</p> <p>ESTICADOR DA BARRA ESTABILIZADORA DA FRENTE</p> <p>OPEL ASTRA (F) TT</p> <p>100x50x35mm 1f-d21mm 1p-d8-28mm</p> |  | <p>E1007 NO. 852722</p> <p>SUPORTE DE ESCAPE</p> <p>OPEL ASTRA (F) 1.4 - 1.6 - 1.8 - 2.0 - ASTRA DIESEL 1.7 - ASTRA TURBO DIESEL 1.7 (1991 A 1998)</p> <p>70x47x40mm NULL</p> |
|  | <p>F0466-I NO. 902825 - 902828 - 9105983 - 90090811</p> <p>FOLE DA CREMALHEIRA DA DIRECÇÃO ESQ. E DIR.</p> <p>OPEL ASTRA (F) 1.3 - 1.4 - 1.6 - 1.8 - 2.0 - ASTRA (F) DIESEL 1.7 - ASTRA TURBO DIESEL 1.7</p> <p>d72x165mm 1f-d41mm 1f-d51mm</p> |  | <p>F0519-I NO. 374040 - 90129014 - 90112609</p> <p>FOLE DO SEMI-EIXO LADO DA CAIXA DE VELOCIDADES</p> <p>OPEL ASTRA (F) 1.4i - 1.4iSi - 1.6 - 1.6i - 1.6i 16v - 1.6iSi 16v - 1.8i - 1.8i 16v - 2.0i - 2.0i 16v (1991 A 2001)</p> <p>d88x97mm 1f-d66mm 1f-d21mm</p> |
|  | <p>F0520-I NO. 90095162 - 374018</p> <p>FOLE DO SEMI-EIXO INTERNO (F1026)</p> <p>OPEL ASTRA (F) CLASSIC 1.4i - CLASSIC 1.6i - CLASSIC 1.6i 16v - 1.7D - 1.7TD (1998 A 2003)</p> <p>d72x94mm 1f-d54mm 1f-d19mm</p> |  | <p>F1305-I NO. 1609074 - 26024585 - 0902828</p> <p>FOLE DA DIRECÇÃO ASSISTIDA LADO DIREITO E ESQUERDO</p> <p>OPEL ASTRA (F) CLASSIC 1.4i - 1.6i - 1.6i 16v - (1998 A 2003)</p> <p>d78x170mm 1f-d54mm 1f-d42mm</p> |
|  | <p>F1337-I NO. 902829</p> <p>FOLE DA DIRECÇÃO ASSISTIDA (CAIXA ZF)</p> <p>OPEL ASTRA (F) 1.4i - 1.4i Si - 1.6i - 1.6i 16v - 1.6i Si 16v - 1.7D - 1.7 TD - 1.7 TDS - 1.8i - 1.8i 16v - 2.0i - 2.0i 16v (1991 A 2001)</p> <p>d57x425mm 2f-d51mm</p> |  | <p>F1338-I NO. 1609076 - 90442111</p> <p>FOLE DA CREMALHEIRA DA DIRECÇÃO (CREMALHEIRA ZF)</p> <p>OPEL ASTRA (F) 1.4i - 1.4i 16v - 1.4i Si - 1.6i - 1.6i 16v - 1.7D - 1.7TD - 1.7TDS - 1.8i - 1.8i 16v - 2.0i - 2.0i 16v - 2.0i Gsi 16v (1991 A 2001)</p> <p>d80x360mm 1f-d58mm 1f-d42mm</p> |
|  | <p>F1350-I NO. 1609045 - 1609073 - 90188878 - 90398968 - 9943449</p> <p>FOLE DA DIRECÇÃO ASSISTIDA LADO DIREITO E ESQUERDO</p> <p>OPEL ASTRA (F) 1.4 i - 1.6 i - 1.7 D - 1.7 TD - 1.7 TDS - 1.8 i - 2.0 i (1991 A 1998) - ASTRA (F) 1.6 i - 1.8 i (1993 A 2001)</p> <p>d74/63x125mm 1f-d50mm 1f-d38mm</p> |  | <p>F1373-I NO. 1603141 - 374040 - 90009020 - 90112609 - 90421756</p> <p>FOLE DA TRANSMISSÃO JUNTO À CAIXA</p> <p>OPEL ASTRA F 1.4i - 1.4i Si - 1.6i - 1.6i 16V - 1.6i Si 16V - 1.8i - 1.8i 16V - 2.0i - 2.0i 16V (91 A 01)</p> <p>d87x99mm 1f-d65mm 1f-d22mm</p> |
|  | <p>F1848-I NO. 1603238 - 1603014 - 1603183 - 374429 - 374014 - 374319 - 90543336</p> <p>FOLE DA TRANSMISSÃO JUNTO À CAIXA</p> <p>OPEL ASTRA (F) 1.7 CDTi 16v - 1.7D - 1.7 TDS - 1.8i 16v - 2.2i 16v (1991 A 1998)</p> <p>d95x100mm 1f-d65mm 1f-d24mm</p> |  | <p>F4094 NO. 5738414 - 738978 - 0738978 - 90437426 - 90373314</p> <p>FOLE DE ALAVANCA DE VELOCIDADES</p> <p>OPEL ASTRA F Hatchback (53_54_58_59_) 1.4 i (03.92 a 01.98) 60cv 1389cc Hatchback - OPEL ASTRA F Hatchback (53_54_58_59_) 1.4 (09.91 A 09.93) 75cv 1389cc Hatchback - OPEL ASTRA F Hatchback (53_54_58_59_) 1.4 Si (03.92 A 01.98) 82cv 1389cc Hatchback - OPEL ASTRA F Hatchback (53_54_58_59_) 1.4 (09.92 A 01.98) 82cv 1389cc Hatchback - OPEL ASTRA F Hatchback (53_54_58_59_) 1.4 i 16V (01.96 A 01.98) 90cv 1389cc Hatchback - OPEL...etc.</p> <p>170x120x220mm 1f-160x105mm 1f-d50mm</p> |

| | | | |
|---|---|--|---|
|  | <p>H756 NO. [blank]</p> <p>PALA ORIGINAL OPEL ASTRA</p> <p>OPEL ASTRA (F)</p> <p>460x210mm NULL</p> |  | <p>KF2340 NO. 374050 - 90125491 - 1603179</p> <p>FOLE DO LADO DA RODA</p> <p>OPEL ASTRA (F) 1.4 Si - 1.6i - 1.6i 16v - 1.6i Si 16v - 1.7D - 1.7TD - 1.7TDS - 1.8i - 1.8i 16v - 2.0 - 2.0i 16v (1991 A 2001)</p> <p>d103x78mm 1f-d22mm 1f-d82mm</p> |
|  | <p>L3020 NO. 856700</p> <p>CASQUILHO DE ESCAPE</p> <p>OPEL ASTRA (F) (1992 A 1998)</p> <p>NULL NULL</p> |  | <p>M6003 NO. 854952</p> <p>JUNTA DE ESCAPE</p> <p>OPEL ASTRA (F) 1.4 - 1.6 KAT (1991 A 2001)</p> <p>d59x13.5mm 1f-d45mm</p> |
|  | <p>M6041 NO. 854929 - 90091769</p> <p>JUNTA DE ESCAPE</p> <p>OPEL ASTRA (F) 1.7D - 1.7TD - 1.7 TDS (APÓS 1991)</p> <p>142x68mm 2f-d50mm</p> |  | <p>M6045 NO. 854936 - 90231063</p> <p>JUNTA DE ESCAPE</p> <p>OPEL ASTRA (F) (APÓS 1991)</p> <p>95x92mm 1f-d55mm</p> |
|  | <p>M6082 NO. 854955 - 854943 - 854944 - 97069287</p> <p>JUNTA DE ESCAPE</p> <p>OPEL ASTRA (F) (APÓS 1991)</p> <p>d64x5mm 1f-d53mm</p> |  | <p>P1012 NO. 560808</p> <p>CAPA DE PEDAL DO TRAVÃO E EMBRAIAGEM</p> <p>OPEL ASTRA (F) 1.4 - 1.6 - 1.8 - 2.0 - ASTRA DIESEL 1.7 - ASTRA TURBO DIESEL 1.7</p> <p>60x55x9mm NULL</p> |
|  | <p>P1070 NO. 0560194 - 0560811 - 560194 - 560811 - 904687790</p> <p>CAPA DE PEDAL DO TRAVÃO (VEÍCULOS CAIXA AUTOMÁTICA)</p> <p>OPEL ASTRA F HATCHBACK 1.4 - 1.4 I - 1.4 I 16V - 1.4 SI (09-1991 A 01-1998) 1389CC - OPEL ASTRA F HATCHBACK 1.6 - 1.6 I - 1.6 I 16V - 1.6 SI (09-1991 A 01-1998) 1598CC - OPEL ASTRA F HATCHBACK 1.8 I (09-1991 A 01-1998) 90CV 1796CC - OPEL ASTRA F HATCHBACK</p> <p>110x65x14mm NULL</p> |  | <p>P1081 NO. 842736</p> <p>CAPA DE PEDAL DO ACELADOR</p> <p>OPEL ASTRA F HATCHBACK 1.4 - 1.4 I - 1.4 I 16V (09-1991 A 01-1998) 1389CC - OPEL ASTRA F HATCHBACK 1.6 - 1.6 I - 1.6 I 16V (09-1991 A 01-1998) 1598CC - OPEL ASTRA F HATCHBACK 1.8 I (09-1991 A 01-1998) 90CV 1796CC - OPEL ASTRA F HATCHBACK 1.8 I 16V (09-1991 A 01-1998) 1389CC</p> <p>132x53x14mm NULL</p> |
|  | <p>R221402 NO. 1818245 - 6818319</p> <p>TUBO DE LIGAÇÃO AO DEPÓSITO DO ARREFECIMENTO</p> <p>OPEL ASTRA (F) 1.4 - 1.4i - 1.6 - 1.6i (1991 A 2002)</p> <p>B400-d19/15mm 90-80-115-230-150mm + ch-d7mm 40-55</p> |  | <p>R221420 NO. 1337106 - 90421900</p> <p>TUBO SUPERIOR DE ENTRADA DE ÁGUA DO RADIADOR</p> <p>OPEL ASTRA (F) 1.7D (1991 A 1999)</p> <p>B135-d34mm 100-120-70mm</p> |
|  | <p>R221421 NO. 1337111 - 90421905</p> <p>TUBO INFERIOR DE SAÍDA DE ÁGUA DO RADIADOR</p> <p>OPEL ASTRA (F) 1.7D (1991 A 1999)</p> <p>B480-d38/34mm 70-135-255-70mm</p> |  | <p>R221422 NO. 1818159</p> <p>TUBO DE ENTRADA DE ÁGUA DE AQUECIMENTO</p> <p>OPEL ASTRA (F) 1.7D (1991 A 1999)</p> <p>B450-d20/14mm 45-50-135-225-85-135-55mm</p> |
|  | <p>R221423 NO. 1818202</p> <p>TUBO RETORNO DE ÁGUA DE AQUECIMENTO</p> <p>OPEL ASTRA (F) 1.7D (1991 A 1999)</p> <p>B340-d20/15mm 55-55-5550-80-60-90-75mm</p> |  | <p>R221430 NO. 1337107</p> <p>TUBO SUPERIOR DE ENTRADA DE ÁGUA NO RADIADOR</p> <p>OPEL ASTRA (F) 1.7TD (11-1944 A 01-1999)</p> <p>B315-d34/31mm 40-80-120-75mm</p> |

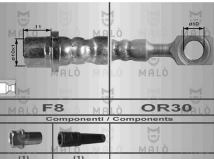
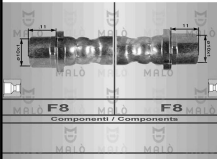

| | | | |
|--|--|--|---|
|  | R221431 NO. 1337098 - 90421810 TUBO INFERIOR DA SAÍDA DE ÁGUA DO RADIADOR OPEL ASTRA (F) 1.7TD (11-1944 A 01-1999) B290-d35/30mm 65-140-100-50-ch85-d14mm |  | R8079 NO. 1336509 - 1337465 - 90351806 - 90530799 TUBO DE LIGAÇÃO AO TERMOSTATO OPEL ASTRA (F) 2.0 - 2.0i (1991 A 1998) B220-d20/20mm 80-70-60-70-60mm |
|  | RT08541 NO. 90235999 - 96179489 - 562346 - 4565719 TUBO DE TRAVÃO TRÁS LH-RH OPEL ASTRA F TT (09-1991 A 09-1998) - OPEL CALIBRA TT (10-1989 A 07-1992) - OPEL CORSA A TT (08-1985 A 03-1993) - CORSA B TT (03-1993 A 09-2000) - OPEL KADETT E TT (08-1985 A 09-1991) - OPEL TIGRA TT (APÓS 07-1994) - OPEL VECTRA A TT (09-1988 A 11-1995) - 195mm FB3/1 - FB3/1 |  | RT08545 NO. 562345 - 562350 - 562358 - 90235568 - 90374106 - 90468316 - 90468319 TUBO DE TRAVÃO FRENTE LH-RH OPEL ASTRA F TT (09-1991 A 09-1998) - OPEL CALIBRA TT (10-1989 A 07-1997) - OPEL VECTRA A TT (09-1988 A 11-1995) 310mm FB3/1 - OR1 |
|  | RT08614 NO. 562352 - 562359 - 90425239 - 90468320 - 4483285 TUBO DE TRAVÃO TRÁS LH-RH OPEL ASTRA F TT (BERLINA - SALOON) (09-1991 A 09-1998) - OPEL CALIBRA (08-1992 A 07-1997) 235mm FB3/1 - MC43 |  | S1127 NO. 352300 - 352346 SILENT-BLOC DO BRAÇO DA SUSPENSÃO FRENTE DIAM. 12mm OPEL ASTRA (F) 1.4 - 1.6 - 1.8 - 2.0 - ASTRA DIESEL 1.7 - ASTRA TURBO DIESEL 1.7 d43x60mm d38mm 1f-d12mm |
|  | S1128 NO. 352347 - 352348 SILENT-BLOC EXTERIOR DO BRAÇO DA SUSPENSÃO FRENTE DIAM. 16mm OPEL ASTRA (F) 1.4 - 1.6 - 1.8 - 2.0 - ASTRA DIESEL 1.7 - 1.7TD d68x58mm d60mm 1f-d16mm |  | S1275 NO. 402642 - 90189050 SILENT-BLOC DA SUSPENSÃO DE TRÁS OPEL ASTRA (F) - 1.4 - 1.4i - 1.4i 16v - 1.6 - 1.6i - 1.6i 16v - 1.7D - 1.7TD - 1.8i - 1.8i 16v - 2.0i - 1.0i 16v d56x75mm c63mm d47mm |
|  | W5034 NO. 614654 POLIE DA CAMBOTA (6 PISTAS) OPEL ASTRA (F) 1.8i 16v - 2.0i - 2.0i 16v d138mm d42mm |  | W5045 NO. 5614417 POLIE DA CAMBOTA (1+1+1 PISTAS) OPEL ASTRA (F) 1.7TDS (1992 A 1998) d139mm d48mm |
|  | Y3000 NO. 854980 - 854977 - 854917 - 90128081 PARAFUSO MOLA DE ESCAPE OPEL ASTRA (F) (APÓS 1991) 82x13mm 1p-d10-20mm |  | Y3004 NO. 854982 - 90128082 PARAFUSO ESCAPE OPEL ASTRA (F) (APÓS 1991) d19x65mm d12mm 1r-d10mm |
|  | Z80846 NO. 90450482 - 1104881 - 1104882 Rebite OPEL ASTRA F d19x29mm 1p-d8-15.2mm |  | Z9004 NO. 856563 MOLA DE ESCAPE OPEL ASTRA (F) (APÓS 1991) 25x22x5mm NULL |

| | | | |
|--|---|--|---|
|  | <p>A1630 NO. 684694</p> <p>APOIO DO MOTOR PARTE DA FRENTE CENTRAL</p> <p>OPEL ASTRA (G) 1.4 - 1.6 16v - 1.8 - ZAFIRA 1.6 16v - 1.8 16v (1999 A 2005)</p> <p>220x120x80mm 1f-d16mm</p> |  | <p>A1631 NO. 0682502 - 09191558 - 24427641 - 5682534</p> <p>APOIO DO MOTOR PARTE DE TRÁS</p> <p>OPEL ASTRA (G) 2.0 Dti - 2.0 OPC - 2.2 16v</p> <p>130x150x90mm 1f-d13/19mm 1f-d12mm</p> |
|  | <p>A1632 NO. 684696</p> <p>APOIO DO MOTOR PARTE DA FRENTE</p> <p>OPEL ASTRA (G) (COM CAIXA AUTOMÁTICA) 2.0 16v - 2.0Di - 2.0DTi 16v</p> <p>150x110x80mm 1f-d16mm</p> |  | <p>A1632 NO. 684696</p> <p>APOIO DO MOTOR PARTE DA FRENTE</p> <p>OPEL ASTRA (G) (COM CAIXA AUTOMÁTICA) 2.0 16v - 2.0Di - 2.0DTi 16v - ZAFIRA 2.0 Dti 16v (09-2000 A 06-2005) (COM CAIXA AUTOMÁTICA)</p> <p>150x110x80mm 1f-d16mm</p> |
|  | <p>A1644 NO. 5684045 - 90575456</p> <p>APOIO DO MOTOR PARTE DA FRENTE ESQUERDO</p> <p>OPEL ASTRA (G) 1.2 - 1.4 - 1.6 - 1.7DTi - 1.8</p> <p>170x105x70mm 1f-d13mm</p> |  | <p>A1647 NO. 5684051 - 90575772 - 5684053 - 5684054</p> <p>APOIO DO MOTOR PARTE DA FRENTE DIREITO</p> <p>OPEL ASTRA (G) 1.2 - 1.4 - 1.6 - 1.8</p> <p>170x140x120mm 1f-d12 - 7mm</p> |
|  | <p>A1651 NO. 684692</p> <p>APOIO DO MOTOR PARTE DA FRENTE CENTRAL</p> <p>OPEL ASTRA (G) 1.2 - 1.6 - 1.7 DTi - 1.7 TD</p> <p>230x130x80mm 1f-d16mm</p> |  | <p>A1685 NO. 684693</p> <p>APOIO DO MOTOR PARTE DA FRENTE</p> <p>OPEL ASTRA (G) 1.4 16v - 1.6 - 1.6 16v - 1.8 16v (COM TRANSMISSÃO AUTOMÁTICA)</p> <p>145x125x75mm 1f-d16mm</p> |
|  | <p>A1691 NO. 684697 - 90576048</p> <p>APOIO DO MOTOR PARTE DA FRENTE</p> <p>OPEL ASTRA (G) 2.0 DTi - 2.0 Di</p> <p>170x123x75mm 1f-d16mm</p> |  | <p>A1694 NO. 5684162 - 684168 - 684695 - 90575190 - 9156951</p> <p>APOIO DO MOTOR PARTE DA FRENTE CENTRAL</p> <p>OPEL ASTRA (G) 2.0 16v - 2.0 OPC - 2.0 16v TURBO - 2.2 16v</p> <p>170x120x75mm 1f-d16mm</p> |
|  | <p>A1943 NO. 0344523 - 344523 - 90468554</p> <p>APOIO AMORTECEDORES FRENTE</p> <p>OPEL ASTRA G Hatchback (F48_, F08_) 1.2 16V (02.98 A 09.00) 65cv 1199cc Hatchback - OPEL ASTRA G Hatchback (F48_, F08_) 1.2 16V (09.00 A 01.05) 75cv 1199cc Hatchback - OPEL ASTRA G Hatchback (F48_, F08_) 1.4 (09.07 A 12.09) 90cv 1364cc Hatchback - OPEL ASTRA G Hatchback (F48_, F08_) 1.4 16V (02.98 A 01.05) 90cv 1389cc Hatchback - OPEL ASTRA G Hatchback (F48_, F08_) 1.6 (02.98 A 09.00) 75cv 1598cc Hatchback - OPEL ASTRA G Hatchback (F48_ ...etc.</p> <p>d115x45mm 1f-d12mm</p> |  | <p>C0233 NO. 1160724 - 90054143</p> <p>BOTÃO AFINAÇÃO CAPÔT</p> <p>OPEL ASTRA G Hatchback (F48_ F08_) 1.2 16V (02.98 A 09.00) 65cv 1199cc Hatchback - OPEL ASTRA G Hatchback (F48_ F08_) 1.2 16V (09.00 A 01.05) 75cv 1199cc Hatchback - OPEL ASTRA G Hatchback (F48_ F08_) 1.4 (09.07 A 12.09) 90cv 1364cc Hatchback - OPEL ASTRA G Hatchback (F48_ F08_) 1.4 16V (02.98 A 01.05) 90cv 1389cc Hatchback - OPEL ASTRA G Hatchback (F48_ F08_) 1.6 (02.98 A 09.00) 75cv 1598cc Hatchback - OPEL ASTRA G Hatchback (F48_ F08_ ...etc.</p> <p>d19x31mm NULL</p> |
|  | <p>E0163 NO. 350611 - 350614 - 13169439 - 90498745</p> <p>ESTICADOR DA BARRA ESTABILIZADORA DA FRENTE</p> <p>OPEL ASTRA (G) TT</p> <p>340x37x37mm 2p-d12-25mm</p> |  | <p>E1092 NO. 852726</p> <p>ESTICADOR DE ESCAPE</p> <p>OPEL ASTRA (G) (APÓS 03-1998)</p> <p>55x40x35mm NULL</p> |
|  | <p>F0520-I NO. 90095162 - 374018</p> <p>FOLE DO SEMI-EIXO INTERNO (F1026)</p> <p>OPEL ASTRA (G) 1.4i 16v - 1.6i - 1.6i 16v - 1.7 Dti 16v - 1.7 TD (1998 A 2004)</p> <p>d72x94mm 1f-d54mm 1f-d19mm</p> |  | <p>F1650A-I NO. 1604252 - 1604300 - 90510398</p> <p>FOLE DA TRANSMISSÃO JUNTO À CAIXA</p> <p>OPEL ASTRA G 1.8i 16V - 2.0 Di 16V - 2.0 DTi 16V - 2.0i 16V - 2.2i 16V (1998 A 2003)</p> <p>d110x125mm 1f-d108mm 1f-d25mm</p> |

| | | | |
|--|---|--|---|
|  | <p>F1848-I NO. 1603238 - 1603014 - 1603183 - 374429 - 374014 - 374319 - 90543336</p> <p>FOLE DA TRANSMISSÃO JUNTO À CAIXA</p> <p>OPEL ASTRA (G) 1.8i - 2.2i (1998 A 2003)</p> <p>d95x100mm 1f-d65mm 1f-d24mm</p> |  | <p>F4097 NO. 0738394 - 0738415 - 738394 - 738415</p> <p>FOLE ALAVANCA VELOCIDADES</p> <p>OPEL ASTRA G Hatchback (F48_ F08_) 1.2 16V (02.98 A 09.00) 65cv 1199cc Hatchback - OPEL ASTRA G Hatchback (F48_ F08_) 1.2 16V (09.00 A 01.05) 75cv 1199cc Hatchback - OPEL ASTRA G Hatchback (F48_ F08_) 1.4 (09.07 A 12.09) 90cv 1364cc Hatchback - OPEL ASTRA G Hatchback (F48_ F08_) 1.4 16V (02.98 A 01.05) 90cv 1389cc Hatchback - OPEL ASTRA G Hatchback (F48_ F08_) 1.6 (02.98 A 09.00) 75cv 1598cc Hatchback - OPEL ASTRA G Hatchback (F48_ ...etc.</p> <p>160x120x170mm 1f-d50mm 1f-140x95mm</p> |
|  | <p>KF2271-T NO. 1603259 - 374434</p> <p>KIT DE FOLE DO CARDAN JUNTO À RODA</p> <p>OPEL ASTRA (G) 1.8i 16v (1998 A 2003)</p> <p>d105x125mm 1f-d83mm 1f-d25mm</p> |  | <p>KF2340 NO. 374050 - 90125491 - 1603179</p> <p>FOLE DO LADO DA RODA</p> <p>OPEL ASTRA (G) 1.8i 16v - 2.0 Di 16v - 2.0 Dti 16v (1998 A 2003)</p> <p>d103x78mm 1f-d22mm 1f-d82mm</p> |
|  | <p>KF3480 NO. 1603011 - 1603220 - 1603221 - 09198502 - 09200338</p> <p>KIT DE FOLE DO CARDAN JUNTO À RODA</p> <p>OPEL ASTRA G HATCHBACK 2.0 OPC 192CV (09-2002 A 01-2005) - 2.0 OPC 200CV (11-2002 A 01-2005) - 2.2 DTi 125CV (09-2002 A 01-2005) - ASTRA G TRÊS VOLUMES 2.2 DTi 125CV (09-2002 A 01-2005) - COMBI 2.0 OPC 192CV (09-2002 A 07-2004) - COMBI 2.0 OPC 200CV (11-2</p> <p>d93x98mm 1f-d26mm 1f-d83mm</p> |  | <p>M6082 NO. 854955 - 854943 - 854944 - 97069287</p> <p>JUNTA DE ESCAPE</p> <p>OPEL ASTRA (G)</p> <p>d64x5mm 1f-d53mm</p> |
|  | <p>R222703 NO. 1337582 - 24413975</p> <p>TUBO SUPERIOR DO RADIADOR</p> <p>OPEL ASTRA (G) 1.4 COM A-C - 1.6 COM A-C</p> <p>B190-d34/34mm 55-70-90-80-50-60mm</p> |  | <p>R222704 NO. 1337556 - 9202896</p> <p>TUBO INFERIOR DO RADIADOR</p> <p>OPEL ASTRA (G) 1.4 - 1.6</p> <p>B455-d38/33mm 255-60-100-70-70mm</p> |
|  | <p>R222715 NO. 1377542</p> <p>TUBO SUPERIOR DO RADIADOR</p> <p>OPEL ASTRA G 1.7 TD (1998 A 2005)</p> <p>B320-d34/34mm 80-110-150-120mm</p> |  | <p>R222716 NO. 1337543 - 9128909</p> <p>TUBO INFERIOR DO RADIADOR</p> <p>OPEL ASTRA (G) 1.7 TD</p> <p>B300-d32/32mm 130-190-100-50mm+ch1125-d20mm</p> |
|  | <p>R222720 NO. 1337484 - 1337586 - 90573847</p> <p>TUBO SUPERIOR DO RADIADOR</p> <p>OPEL ASTRA (G) 1.7 DTi</p> <p>B255-d36/34mm 90-130-150-70-95mm</p> |  | <p>R222721 NO. 1337466 - 90530679</p> <p>TUBO INFERIOR DO RADIADOR</p> <p>OPEL ASTRA (G) 1.7 DTi</p> <p>B465-d34/38mm 70-80-150-40-110-140-90mm</p> |
|  | <p>R222723 NO. 1337565 - 24421116</p> <p>TUBO SUPERIOR DO RADIADOR</p> <p>OPEL ASTRA (G) 2.0 DtI</p> <p>B170-d34/34mm 70-60-100-60-85mm</p> |  | <p>R222724 NO. 1337502 - 90573220 - 91156066</p> <p>TUBO INFERIOR DO RADIADOR</p> <p>OPEL ASTRA G 2.0 DTi (82-101CV) (1999 A 2005)</p> <p>B220-d33/33mm 60-100-35-60-60mm</p> |
|  | <p>RT08934 NO. 562377 - 90498319</p> <p>TUBO DE TRAVÃO FRENTE LH-RH</p> <p>OPEL ASTRA G TT (APÓS 02-1998)</p> <p>396mm F8 - OR30</p> |  | <p>RT08935 NO. 5562078 - 90498330</p> <p>TUBO DE TRAVÃO TRÁS LH-RH</p> <p>OPEL ASTRA G TT 1.2 16V - 1.4 16V - 1.6 16V - 1.7 TD - 1.7 TDI (APÓS 02-1998)</p> <p>207mm F8 - F8</p> |

| | | | |
|--|---|--|--|
|  | <p>S1333 NO. 3523.65 - 90498740</p> <p>SILENT-BLOC DO BRAÇO SUSPENSÃO FRENTE(PARTE DE TRÁS)</p> <p>OPEL ASTRA (G) 1.2 - 1.4 - 1.6 - 1.7DTI - 1.7TD - 1.8 - 2.0 - 2.0DTI (APOS 1998)</p> <p>d60x60mm d47mm 1f-d12mm</p> |  | <p>S1473 NO. 352364 - 90498738 - 0352364</p> <p>SILENT BLOC DO BRAÇO SA SUSPENSÃO DA FRENTE</p> <p>OPEL ASTRA G 1.2 16V - 1.4 16V - 1.6 - 1.6 16V - 1.7TD - 1.7DTi 16V - 1.7CDTi - 1.8 16V - 2.0 OPC - 2.0 OPC 16V - 2.0Di - 2.0 16V - 2.0DTi 16V - 2.0 16V - 2.2DTi (1998 A 2005)</p> <p>d44x60mm d35mm 1f-d12mm</p> |
|  | <p>T0645-I NO. 0344417 - 344417 - 0344417 - 90468644</p> <p>BATENTE SUSPENSÃO DA FRENTE</p> <p>OPEL ASTRA G Hatchback (F48_ - F08_) 1.2 16V (02.98 A 09.00) 65cv 1199cc Hatchback - OPEL ASTRA G Hatchback (F48_ - F08_) 1.2 16V (09.00 A 01.05) 75cv 1199cc Hatchback OPEL ASTRA G Hatchback (F48_ - F08_) 1.4 16V (02.98 A 01.05) 90cv 1389cc Hatchback - OPEL ASTRA G Hatchback (F48_ - F08_) 1.6 (02.98 A 09.00) 75cv 1598cc Hatchback - OPEL ASTRA G Hatchback (F48_ - F08_) 1.6 (09.00 A 01.05) 84cv 1598cc Hatchback - OPEL ASTRA G Hatchback (F48_ - ...etc.</p> <p>d50x64mm 1f-d18mm 1f-d23mm</p> |  | <p>W5051 NO. 55351711 - 5614437 - 614411 - 9128177 - 614444 - 5614415 - 912817769 - 90528648</p> <p>POLIE DA CAMBOTA (6 PISTAS)</p> <p>OPEL ASTRA (G) 2.0 DTi (APÓS 06-1999) - Mtr Y20DTH-X20DTH (101CV) - ASTRA (G) 2.0 DTi (09-1998 A 12-2004) - Mtr Y20DTL-X20DTL (82CV)</p> <p>d153mm d35mm</p> |
|  | <p>W5080 NO. 5614441 - 97353964</p> <p>POLIE DA CAMBOTA (6 PISTAS)</p> <p>OPEL ASTRA (G) 5 VOLUME (CAUDA SPIOVENTE) 1.7CDTi - ASTRA (G) STATION WA(G)ON 1.7 CDTi</p> <p>d152mm d48mm</p> |  | <p>W5082 NO. 5614444</p> <p>POLIE DA CAMBOTA (6 PISTAS)</p> <p>OPEL ASTRA (G) 1.7 CDTi (04-2003 A 02-2004) - ASTRA (G) 1.7 DTi (02-2000 A 12-2004)</p> <p>d139/141mm d48mm</p> |
|  | <p>W5092 NO. 615029</p> <p>POLIE DA CAMBOTA (5 PISTAS)</p> <p>OPEL ASTRA (G) 2.0 (G)ASOLINA</p> <p>d147mm d42mm</p> |  | <p>W5098 NO. 5614427</p> <p>POLIE DA CAMBOTA</p> <p>OPEL ASTRA G 1.7 TD</p> <p>d144mm d42mm</p> |
|  | <p>W5107 NO. 5614425 - 5614431 - 9129209</p> <p>POLIE DA CAMBOTA (5 PISTAS)</p> <p>OPEL ASTRA G 2 VOLUMI - CODA SPIOVENTE 1.4 Z 14 XEP 90CV (09-2007 A 12-2009) - 1.4 16V X 14 XE - Z 14 XE 90CV (02-1998 A 01-2005) - 1.6 Z 16 XEP 103CV (12-2002 A 01-2005) - 1.6 16V X16 XEL - Z 16 XE 101CV (02-1998 A 01-2005) - 1.8 16V X18 XE1 116CV (02-1998</p> <p>NULL d160m 1f-d26mm</p> |  | <p>W5107 NO. 5614425 - 5614431 - 9129209</p> <p>POLIE DA CAMBOTA (5 PISTAS)</p> <p>OPEL ASTRA G STATION WAGON 1.4 16V X 14 XE - Z 14 XE 90CV (06-1998 A 07-2004) - 1.6 Z 16 XEP 103CV (12-2002 A 07-2009) - 1.6 16V X 16 XEL - Z 16 XE 101CV (02-1998 A 07-2004) - 1.8 16V X 18 XE1 116CV (02-1998 A 09-2000) - 1.8 16V Z 18 XE 125CV (09-2000 A 07-20</p> <p>NULL d160m 1f-d26mm</p> |
|  | <p>Z80540 NO. 90022049 - 2240861</p> <p>Mola de painel</p> <p>OPEL ASTRA G</p> <p>d12x14.3mm 1p-d7-12.3mm</p> |  | <p>Z80846 NO. 90450482 - 1104881 - 1104882</p> <p>Rebite</p> <p>OPEL ASTRA G</p> <p>d19x29mm 1p-d8-15.2mm</p> |

OPEL ASTRA H

| | | | |
|--|--|--|---|
|  | <p>A1685 NO. 684693</p> <p>APOIO DO MOTOR PARTE DA FRENTE</p> <p>OPEL ASTRA (H) 1.8 (COM TRANSMISSÃO AUTOMÁTICA)</p> <p>145x125x75mm 1f-d16mm</p> |  | <p>A1944 NO. 5684651 - 13159993</p> <p>APOIO MOTOR ESQUERDO</p> <p>OPEL ASTRA H (L48) 1.4 (04.04 A 10.04) 75cv 1364cc Hatchback - OPEL ASTRA H (L48) 1.4 LPG (08.09 A 10.10) 90cv 1364cc Hatchback - OPEL ASTRA H (L48) 1.4 LPG (08.09 A 10.10) 90cv 1364cc Hatchback - OPEL ASTRA H GTC (L08) 1.4 (03.05 A 10.10) 75cv 1364cc Hatchback - OPEL ASTRA H GTC (L08) 1.4 (03.05 A 10.10) 75cv 1364cc Hatchback - OPEL ASTRA H Combi (L35) 1.4 (08.04 A 10.10) 75cv 1364cc Combi - OPEL ASTRA H Combi (L35) 1.4 (08.04 A 10.10) ...etc.</p> <p>165x110x70mm 1f-d13mm 4f-d9mm 1p-8x18mm</p> |
|--|--|--|---|

| | | | |
|--|--|---|--|
|  | <p>C0233 NO. 1160724 - 90054143</p> <p>BOTÃO AFINAÇÃO CAPÔT</p> <p>OPEL ASTRA H (L48) 1.4 (04.04 A 10.04) 75cv 1364cc Hatchback - OPEL ASTRA H (L48) 1.4 (03.04 A 10.10) 90cv 1364cc Hatchback - OPEL ASTRA H (L48) 1.4 LPG (08.09 A 10.10) 90cv 1364cc Hatchback - OPEL ASTRA H (L48) 1.6 (03.04 A 10.10) 105cv 1598cc Hatchback - OPEL ASTRA H (L48) 1.6 (12.06 A 05.14) 116cv 1598cc Hatchback - OPEL ASTRA H (L48) 1.6 Turbo (02.07 A 10.10) 180cv 1598cc Hatchback - OPEL ASTRA H (L48) 1.8 (03.04 A 10.10) 125cv 1...etc.</p> <p>d19x31mm NULL</p> |  | <p>C0233 NO. 1160724 - 90054143</p> <p>BOTÃO AFINAÇÃO CAPÔT</p> <p>OPEL ASTRA J 1.4 (A Partir de 12.09) 87cv 1398cc Hatchback - OPEL ASTRA J 1.4 (A Partir de 12.09) 100cv 1398cc Hatchback - OPEL ASTRA J 1.4 Turbo (A Partir de 10.10) 120cv 1364cc Hatchback - OPEL ASTRA J 1.4 Turbo (A Partir de 12.09) 140cv 1364cc Hatchback - OPEL ASTRA J 1.4 LPG (A Partir de 01.12) 140cv 1364cc Hatchback - OPEL ASTRA J 1.6 (A Partir de 12.09) 115cv 1598cc Hatchback - OPEL ASTRA J 1.6 SIDI (A Partir de 12.12) 170cv ...etc.</p> <p>d19x31mm NULL</p> |
|  | <p>C0233 NO. 1160724 - 90054143</p> <p>BOTÃO AFINAÇÃO CAPÔT</p> <p>OPEL CASCADA (W13) 1.4 (A Partir de 03.13) 120cv 1362cc Cabriolet - OPEL CASCADA (W 13) 1.4 Turbo (A Partir de 03.13) 140cv 1362cc Cabriolet - OPEL CASCADA (W 13) 1.6 SIDI (A Partir de 03.13) 170cv 1598cc Cabriolet - OPEL CASCADA (W 13) 2.0 CDTi (A Partir de 03.13) 165cv 1956cc Cabriolet - OPEL CASCADA (W 13) 2.0 CDTi (A Partir de 03.13) 194cv 1956cc Cabriolet</p> <p>d19x31mm NULL</p> |  | <p>F0520-I NO. 90095162 - 374018</p> <p>FOLE DO SEM-EIXO INTERNO (F1026)</p> <p>OPEL ASTRA (H) 1.4i 16v - 1.6i 16v (APÓS 03-2004)</p> <p>d72x94mm 1f-d54mm 1f-d19mm</p> |
|  | <p>F1848-I NO. 1603238 - 1603014 - 1603183 - 374429 - 374014 - 374319 - 90543336</p> <p>FOLE DA TRANSMISSÃO JUNTO À CAIXA</p> <p>OPEL ASTRA (H) 1.7CDTi - 1.8i (APÓS 2004)</p> <p>d95x100mm 1f-d65mm 1f-d24mm</p> |  | <p>KF2362-T NO. 1603232 - 1603278 - 1603281 - 1603284 - 93182574</p> <p>KIT DE FOLE DO CARDAN JUNTO À RODA</p> <p>OPEL ASTRA H (APÓS 2004) 1.9CDTi 16V - 1.9CDTi 8V - 2.0i 16V</p> <p>d104x130mm 1f-d91mm 1f-d27mm</p> |
|  | <p>KF3788-T NO. 1603277</p> <p>KIT DE FOLE DO CARDAN JUNTO À RODA</p> <p>OPEL ASTRA (H) 1.7 CDTi 16v - 1.8i 16v (APÓS 2004)</p> <p>d100x122mm 1f-d83mm 1f-d25mm</p> |  | <p>P1081 NO. 842736</p> <p>CAPA DE PEDAL DO ACELADOR</p> <p>OPEL ASTRA G HATCHBACK 1.2 16V (02-1998 A 09-2000) 65CV 1199CC - OPEL ASTRA G HATCHBACK 1.2 16V (09-2000 A 01-2005) 75CV 1199CC - OPEL ASTRA G HATCHBACK 1.4 16V (02-1998 A 01-2005) 90CV 1389CC - OPEL ASTRA G HATCHBACK 1.6 - 1.6 16V (02-1998 A 12-2009) 159</p> <p>132x53x14mm NULL</p> |
|  | <p>RT80277 NO. 5562260 - 13136715 - 562161</p> <p>TUBO DE TRAVÃO FRENTE LH-RH</p> <p>OPEL ASTRA H TT (APÓS 03-2004)</p> <p>440mm F8 - OR30</p> |  | <p>RT80581 NO. 5562249</p> <p>TUBO DE TRAVÃO TRÁS RH (COM TAMBOR)</p> <p>OPEL ASTRA H 1.2 (motor X12XE) (APÓS 10-2006) - (motor Z12XEP) (APÓS 08-2005) - 1.3 CDTi (motor Z13DTH) (APÓS 08-2005) - 1.4 (motor Z14XEL) (APÓS 04-2004) (motor Z14XEP) (APÓS 03-2004) - 1.6 (motor Z16XEP) (APÓS 03-2004) - (motor Z16XER) (APÓS 12-2006) -</p> <p>630mm NULL</p> |
|  | <p>RT80582 NO. 5562248</p> <p>TUBO DE TRAVÃO TRÁS RH (COM DISCO)</p> <p>OPEL ASTRA H 1.2 (motor X 12 XE) (APÓS 10-2006) - (motor Z 12 XEP) (APÓS 08-2005) - 1.3 CDTi (motor Z 13 DTH) (APÓS 08-2005) - 1.4 (motor Z 14 XEL) (APÓS 04-2004) (motor Z 14 XEP) (APÓS 03-2004) - 1.6 (motor Z 16 XEP) (APÓS 03-2004) - 1.6 (motor Z 16 XER)</p> <p>760mm NULL</p> |  | <p>RT80583 NO. 5562247</p> <p>TUBO DE TRAVÃO TRÁS LH (COM DISCO)</p> <p>OPEL ASTRA H 1.2 (motor X 12 XE) (APÓS 10-2006) - 1.2 (motor Z 12 XEP) (APÓS 08-2005) - 1.3 CDTi (motor Z 13 DTH) (APÓS 08-2005) - 1.4 (motor Z 14 XEL) (APÓS 04-2004) - 1.4 (motor Z 14 XEP) (APÓS 03-2004) - 1.6 (motor Z 16 XEP) (APÓS 03-2004) - 1.6 (moto</p> <p>760mm NULL</p> |
|  | <p>S1473 NO. 352364 - 90498738 - 0352364</p> <p>SILENT BLOC DO BRAÇO SA SUSPENSÃO DA FRENTE</p> <p>OPEL ASTRA H 1.4 - GTC 1.4 - 1.6 - GTC 1.6 - 1.7 CDTi - GTC 1.7 CDTi - 1.8 - GTC 1.8 - 1.9CDTi - GTC 1.9CDTi - 2.0 TURBO - GTC 2.0 TURBO - (APÓS 2004) - TWIN TOP 1.6 - 1.8 - 1.9CDTi - 2.0 TURBO (APÓS 09-2005)</p> <p>d44x60mm d35mm 1f-d12mm</p> |  | <p>W5054 NO. 5614438 - 614150 - 93177317 - 93194443 - 0614150</p> <p>POLIE DA CAMBOTA (6 PISTAS)</p> <p>OPEL ASTRA (H) 1.3 CDTi 16v APÓS 08-2005 - Mtr Z13DT(H) (90CV)</p> <p>d165mm d35mm</p> |
|  | <p>W5080 NO. 5614441 - 97353964</p> <p>POLIE DA CAMBOTA (6 PISTAS)</p> <p>OPEL ASTRA (H) 1.7 CDTi Motor Z17DTL - ASTRA (H) STATION WAGON 1.7 CDTi Motor Z17DTL</p> <p>d152mm d48mm</p> |  | <p>W5082 NO. 5614444</p> <p>POLIE DA CAMBOTA (6 PISTAS)</p> <p>OPEL ASTRA (H) 1.7 CDTi 16 V (100CV) (APÓS 03-2004) Motor Z17DTH</p> <p>d139/141mm d48mm</p> |

| | | | |
|----------|---|--------|--|
| | W5107 NO. 5614425 - 5614431 - 9129209 | | W5145 NO. 55210310 - 0614359 - 614359 - 93192547 |
| | POLIE DA CAMBOTA (5 PISTAS) OPEL ASTRA H 1.8 Z 18 XE 125CV (APÓS 03-2004) - 1.8 Z 18 XER 140CV (APÓS 01-2006) - OPEL ASTRA H GTC 1.8 Z 18 XE 125 (APÓS 03-2005) - OPEL ASTRA H STATION WAGON 1.8 Z 18 XE 125CV (APÓS 08-2004) - OPEL ASTRA H TWIN TOP 1.8 Z 18 XE 125CV (APÓS 09-2005) | | POLIE DA CAMBOTA 6 PISTAS OPEL ASTRA H (L48) 1.9 CDTI (09.05 A 10.10) 100cv 1910cc Hatchback - OPEL ASTRA H (L48) 1.9 CDTI (06.04 A 10.10) 120cv 1910cc Hatchback - OPEL ASTRA H GTC (L08) 1.9 CDTI (01.06 A 10.10) 101cv 1910cc Hatchback - OPEL ASTRA H GTC (L08) 1.9 CDTI (09.05 A 10.10) 120cv 1910cc Hatchback - OPEL ASTRA H Combi (L35) 1.9 CDTI (09.05 A 10.10) 100cv 1910cc Combi - OPEL ASTRA H Combi (L35) 1.9 CDTI (09.05 A 10.10) 120cv 1910cc Combi - OPEL ASTRA H Caixa...etc. |
| NULL | d160mm 1f-d26mm | d169mm | d30,5mm |
| | Z80846 NO. 90450482 - 1104881 - 1104882 | | |
| | Rebite OPEL ASTRA H | | |
| d19x29mm | 1p-d8-15,2mm | | |

OPEL CALIBRA

| | | | |
|--------------|---|-------------|---|
| | A1219 NO. 344514 | | A1392 NO. 684291 - 6844283 - 6844282 - 684282 |
| | APOIO DO AMOTECEDOR DA FRENTE OPEL CALIBRA (A) 2.0i - 2.0i 16v - 2.0i 16v 4x4 - 2.0i TURBO 4x4 (1990 A 1997) | | APOIO DO MOTOR FRENTE DIREITO OPEL CALIBRA (A) 2.0i (1990 A 1997) |
| d113x42mm | 1f-d12mm | 185x95x67mm | 2f-d11mm |
| | A1394 NO. 684646 - 90372425 | | A1406 NO. 0650702 - 90233962 |
| | APOIO MOTOR FRENTE DIREITO OPEL CALIBRA (A) 2.0i - 2.0i 16v - 2.0i 16v 4x4 (1990 A 1997) | | SUPORTE DO FILTRO DE ÓLEO OPEL CALIBRA |
| 175x95x60mm | 1f-d12mm | d20x15mm | 1p-d6-10mm 1p-d6-15mm |
| | C0233 NO. 1160724 - 90054143 | | E0128 NO. 350263 - 90495045 - 4544599 |
| | BOTÃO AFINAÇÃO CAPÔT OPEL CALIBRA A (85_) 2.0 i (06.90 A 07.97) 115cv 1998cc Coupé - OPEL CALIBRA A (85_) 2.0 i 4x4 (06.90 A 07.97) 115cv 1998cc Coupé - OPEL CALIBRA A (85_) 2.0 i 16V (02.94 A 07.97) 136cv 1998cc Coupé - OPEL CALIBRA A (85_) 2.0 i 16V 4x4 (02.94 A 07.97) 136cv 1998cc Coupé - OPEL CALIBRA A (85_) 2.0 i 16V (06.90 A 02.94) 150cv 1998cc Coupé - OPEL CALIBRA A (85_) 2.0 i 16V 4x4 (06.90 A 02.94) 150cv 1998cc Coupé - OPEL CALIBRA A (85_)...etc. | | ESTICADOR DA BARRA ESTABILIZADORA DA FRENTE OPEL CALIBRA (A) 2.0i - 2.0i 16v - 2.0i 16v 4x4 - 2.5i V6 |
| d19x31mm | NULL | 105x34x34mm | 1p-d12-25mm |
| | E1071 NO. 852723 - 90352773 | | F1338-I NO. 1609076 - 90442111 |
| | ESTICADOR DE ESCAPE OPEL CALIBRA (A) 2.0i - 2.0i 16v - 2.0i TURBO 4x4 (APÓS 1990) | | FOLE DA CREMALHEIRA DA DIRECÇÃO (CREMALHEIRA ZF) OPEL CALIBRA (A) 2.0i - 2.0i 16v - 2.0i 16v 4x4 - 2.0i 4x4 - 2.0i T 16v 4x4 - 2.5i V6 (1990 A 1997) |
| 72x61x20mm | NULL | d80x360mm | 1f-d58mm 1f-d42mm |
| | F1350-I NO. 1609045 - 1609073 - 90188878 - 90398968 - 9943449 | | F1373-I NO. 1603141 - 374040 - 90009020 - 90112609 - 90421756 |
| | FOLE DA DIRECÇÃO ASSISTIDA LADO DIREITO E ESQUERDO OPEL CALIBRA A 2.0 i - 2.0 i T - 2.5 i (1990 A 1997) | | FOLE DA TRANSMISSÃO JUNTO À CAIXA OPEL CALIBRA A 2.0i - 2.0i 16V - 2.0i 16V 4X4 - 2.5i V6 (90 A 97) |
| d74/63x125mm | 1f-d50mm 1f-d38mm | d87x99mm | 1f-d65mm 1f-d22mm |

| | | | |
|---|---|--|---|
|  | <p>F4094 NO. 5738414 - 738978 - 0738978 - 90437426 - 90373314</p> <p>FOLE DE ALAVANCA DE VELOCIDADES</p> <p>OPEL CALIBRA A (85_) 2.0 i (06.90 A 07.97) 115cv 1998cc Coupé - OPEL CALIBRA A (85_) 2.0 i 4x4 (06.90 A 07.97) 115cv 1998cc Coupé - OPEL CALIBRA A (85_) 2.0 i 16V (02.94 A 07.97) 136cv 1998cc Coupé - OPEL CALIBRA A (85_) 2.0 i 16V 4x4 (02.94 A 07.97) 136cv 1998cc Coupé - OPEL CALIBRA A (85_) 2.0 i 16V (06.90 A 02.94) 150cv 1998cc Coupé - OPEL CALIBRA A (85_) 2.0 i 16V 4x4 (06.90 A 02.94) 150cv 1998cc Coupé - OPEL CALIBRA A (85_)...etc.</p> <p>170x120x220mm 1f-160x105mm 1f-d50mm</p> |  | <p>F4094 NO. 5738414 - 738978 - 0738978 - 90437426 - 90373314</p> <p>FOLE DE ALAVANCA DE VELOCIDADES</p> <p>OPEL SINTRA 2.2 i 16V (11.96 A 04.99) 141cv 2198cc Veículo multiuso - OPEL SINTRA 3.0 i 24V (11.96 A 04.99) 201cv 2962cc Veículo multiuso - OPEL SINTRA 2.2 DTI (07.97 A 04.99) 116cv 2171cc Veículo multiuso</p> <p>170x120x220mm 1f-160x105mm 1f-d50mm</p> |
|  | <p>KF2340 NO. 374050 - 90125491 - 1603179</p> <p>FOLE DO LADO DA RODA</p> <p>OPEL CALIBRA (A) 2.0i - 2.0i 16v - 2.0i 16v 4x4 - 2.0i 4x4 - 2.0i T 4x4 - 2.5i V6 (1990 A 1997)</p> <p>d103x78mm 1f-d22mm 1f-d82mm</p> |  | <p>L3020 NO. 856700</p> <p>CASQUILHO DE ESCAPE</p> <p>OPEL CALIBRA (A) (1990 A 1997)</p> <p>NULL NULL</p> |
|  | <p>M6045 NO. 854936 - 90231063</p> <p>JUNTA DE ESCAPE</p> <p>OPEL CALIBRA (APÓS 1990)</p> <p>95x92mm 1f-d55mm</p> |  | <p>M6060 NO. 854948 - 90423152</p> <p>JUNTA DE ESCAPE</p> <p>OPEL CALIBRA (APÓS 1989)</p> <p>93x95mm 1f-d60mm</p> |
|  | <p>S1127 NO. 352300 - 352346</p> <p>SILENT-BLOC DO BRAÇO DA SUSPENSÃO FRENTE DIAM.12mm</p> <p>OPEL CALIBRA (A) 2.0i - 2.0i 16v</p> <p>d43x60mm d38mm 1f-d12mm</p> |  | <p>S1128 NO. 352347 - 352348</p> <p>SILENT-BLOC EXTERIOR DO BRAÇO DA SUSPENSÃO FRENTE DIAM.16mm</p> <p>OPEL CALIBRA (A) 2.0i (06-1990 A 09-1997)</p> <p>d68x58mm d60mm 1f-d16mm</p> |
|  | <p>T1049F24 NO. 447869 - 0350125</p> <p>BATENTE DO CENTRO DA BARRA ESTABILIZADORA</p> <p>OPEL CALIBRA (A) 2.0i (06-1990 A 09-1997)</p> <p>40x47x40mm 1f-d22mm</p> |  | <p>W5034 NO. 614654</p> <p>POLIE DA CAMBOTA (6 PISTAS)</p> <p>OPEL CALIBRA (A) 2.0i 16v 4x4 Motor X20 XEV (02-1994 A 07-1997)</p> <p>d138mm d42mm</p> |
|  | <p>Z80540 NO. 90022049 - 2240861</p> <p>Mola de painel</p> <p>OPEL CALIBRA</p> <p>d12x14.3mm 1p-d7-12.3mm</p> |  | <p>Z9004 NO. 856563</p> <p>MOLA DE ESCAPE</p> <p>OPEL CALIBRA (APÓS 1993)</p> <p>25x22x5mm NULL</p> |

OPEL CAMPO

| | | | |
|--|---|---|---|
|  | <p>A1415 NO. 8-94472-973-1 - 8-94434208-1</p> <p>APOIO DE MOTOR TRÁS (CAIXA DE VELOCIDADES)</p> <p>OPEL CAMPO</p> <p>158x75x55mm 2p-d10-23mm</p> |  | <p>A1416 NO. 8-94259-086-A</p> <p>APOIO BATENTE SUPERIOR DO BRAÇO DA SUSPENSÃO FRENTE</p> <p>OPEL CAMPO</p> <p>d52x32mm NULL</p> |
|--|---|---|---|

| | | | |
|--|---|--|---|
|  | <p>A1422 NO. 8-97910-967-0</p> <p>APOIO DE MOTOR FRENTE ESQUERDO</p> <p>OPEL CAMPO</p> <p>142x120x95mm 2p-d10-25mm</p> |  | <p>A1425 NO. 8-97910-966-0</p> <p>APOIO MOTOR FRENTE DIREITO</p> <p>OPEL CAMPO</p> <p>142-120-55mm 2p-d10-25mm</p> |
|  | <p>A1493 NO. 8-94204-521-0 - 8-94222-970-0 - 8-94202520-0</p> <p>APOIO DO VEIO DA TRANSMISSÃO</p> <p>OPEL CAMPO 2300</p> <p>170x135x60mm 1f-d26mm</p> |  | <p>A1494 NO. 8-94328-799-0</p> <p>APOIO DO VEIO DA TRANSMISSÃO</p> <p>OPEL CAMPO 2500DI 4X4</p> <p>135x115x50mm 1f-d30mm</p> |
|  | <p>A1495 NO. 8-94328-800-0</p> <p>APOIO DO VEIO DA TRANSMISSÃO</p> <p>OPEL CAMPO 2500DI</p> <p>160x115x48mm 1f-d30mm</p> |  | <p>E0078 NO. 8-94223-156</p> <p>ESTICADOR DAS PONTAS DA BARRA ESTABILIZADORA FRENTE</p> <p>OPEL CAMPO</p> <p>d32x45mm d25mm</p> |
|  | <p>E1054 NO. 852725 - 97023183</p> <p>ESTICADOR DE ESCAPE</p> <p>OPEL CAMPO (1988 A 1994)</p> <p>56x56x29mm 2f-d9mm</p> |  | <p>E1075 NO. 4295700</p> <p>ESTICADOR ESCAPE</p> <p>OPEL CAMPO (1988 A 1994)</p> <p>d61x16mm NULL</p> |
|  | <p>E1117 NO. 2065100QAB</p> <p>ESTICADOR DO ESCAPE</p> <p>OPEL CAMPO (TF_) 2.3 (TFR16) (08.91 A 08.94) 94cv 2255cc Pick-up - OPEL CAMPO (TF_) 2.5 D (TFR54) (08.91 A 06.94) 76cv 2499cc Pick-up</p> <p>68x40x38mm 2f-d12mm</p> |  | <p>KF1612 NO.</p> <p>KIT DE FOLE DO CARDAN LADO DA RODA</p> <p>OPEL CAMPO 3.1 TDIC (APÓS 10-1996)</p> <p>d100x100mm 1f-d83mm 1f-d23mm</p> |
|  | <p>KF2326 NO. 301403 - 94312680</p> <p>KIT DE FOLE LADO DA RODA</p> <p>OPEL CAMPO 2.5 DTi (APÓS 1987)</p> <p>d95x88mm 1f-d85mm 1f-d24mm</p> |  | <p>KF2327 NO. 94312678</p> <p>KIT DE FOLE DO CARDAN JUNTO À RODA</p> <p>OPEL CAMPO 2.5 DTi (APÓS 1987)</p> <p>d86x84mm 1f-d76mm 1f-d22mm</p> |
|  | <p>KM0404 NO. 8-94450-310-2K</p> <p>KIT DE BRINCOS DAS MOLAS DE TRÁS (Composto por 4 casquilhos L1013)</p> <p>OPEL CAMPO TFR</p> <p>132x90x40mm d30mm</p> |  | <p>M6082 NO. 854955 - 854943 - 854944 - 97069287</p> <p>JUNTA DE ESCAPE</p> <p>OPEL CAMPO (1989 A 1990)</p> <p>d64x5mm 1f-d53mm</p> |
|  | <p>M6089 NO. 854954</p> <p>JUNTA DE ESCAPE</p> <p>OPEL CAMPO (1990 A 1994)</p> <p>108x68x1.5mm 1f-d58mm</p> |  | <p>M6100 NO. 852803 - 94328352</p> <p>JUNTA DE ESCAPE</p> <p>OPEL CAMPO (1990 A 1994)</p> <p>116x80x2mm 1f-d65mm</p> |

| | | | | | |
|--|--|---|--|---|----------------------|
|  | P1041 | NO. 8-94222-524-0 |  | S1244 | NO. 8-94408-840-2 |
| | CAPA PEDAL DO TRAVÃO E EMBRAIAGEM OPEL CAMPO TFR | | | SILENT-BLOC DO BRAÇO DA SUSPENSÃO SUPERIOR FRENTE OPEL CAMPO | |
| | 62x53x11mm | NULL | | d50x45mm | c33mm d38mm 1f-d18mm |
|  | T1033 | NO. 8-94459-459-1 - 350667 - 0350667 - 91132005 | | | |
| | BATENTE DA BARRA ESTABILIZADORA (CENTRO) OPEL CAMPO | | | | |
| | 42x38x38mm | 1f-d25mm | | | |









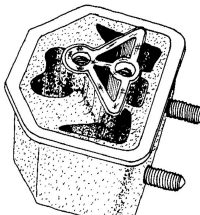
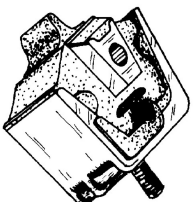



OPEL COMBO



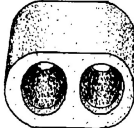

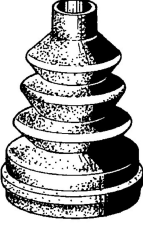
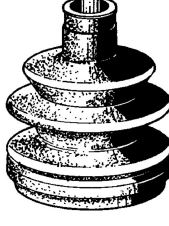
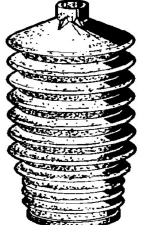
| | | | | | |
|---|--|--|--|---|---|
|  | C0233 | NO. 1160724 - 90054143 |  | F0520-I | NO. 90095162 - 374018 |
| | BOTÃO AFINAÇÃO CAPÔT OPEL COMBO (71_) 1.2 (07.94 A 10.01) 45cv 1195cc Caixa - OPEL COMBO (71_) 1.4 (07.94 A 10.01) 60cv 1389cc Caixa - OPEL COMBO (71_) 1.4 (07.94 A 10.01) 82cv 1389cc Caixa - OPEL COMBO (71_) 1.7 D (07.94 A 10.01) 60cv 1686cc Caixa - OPEL COMBO Tour 1.4 (A Partir de 10.04) 90cv 1364cc Veículo multiuso - OPEL COMBO Tour 1.6 (A Partir de 10.01) 87cv 1598cc Veículo multiuso - OPEL COMBO Tour 1.6 CNG (A Partir de 06.06) 94cv 1598cc Ve?...etc. | | | FOLE DO SEMI-EIXO INTERNO (F1026) OPEL COMBO 1.4i - 1.5D - 1.5TD - 1.7D - 1.7TD (1993 A 2001) | |
| | d19x31mm | NULL | | d72x94mm | 1f-d54mm 1f-d19mm |
|  | F1845-I | NO. 1603004 - 1603230 |  | F4093 | NO. 0738423 - 738423 - 9200970 - 09200970 |
| | FOLE DA TRANSMISSÃO LADO DA CAIXA OPEL COMBO - TOUR 1.4i 1.6i (APÓS 2001) | | | FOLE DE ALAVANCA DE VELOCIDADES OPEL COMBO Tour 1.4 (A Partir de 10.04) 90cv 1364cc Veículo multiuso - OPEL COMBO Tour 1.6 (A Partir de 10.01) 87cv 1598cc Veículo multiuso - OPEL COMBO Tour 1.6 CNG (A Partir de 06.06) 94cv 1598cc Veículo multiuso - OPEL COMBO Tour 1.6 CNG (A Partir de 04.05) 97cv 1598cc Veículo multiuso - OPEL COMBO Tour 1.3 CDTI 16V A Partir de 10.04) 69cv 1248cc Veículo multiuso - OPEL COMBO Tour 1.3 CDTI 16V (A Partir de 10.05) 75cv 1248cc V...etc. | |
| | d81x95mm | 1f-d72mm 1f-d22mm | | 160x110x170mm | 1f-d50mm |
|  | F4094 | NO. 5738414 - 738978 - 0738978 - 90437426 - 90373314 |  | KF2527-T | NO. 1603189 |
| | FOLE DE ALAVANCA DE VELOCIDADES OPEL COMBO (71_) 1.2 (07.94 A 10.01) 45cv 1195cc Caixa - OPEL COMBO (71_) 1.4 (07.94 A 10.01) 60cv 1389cc Caixa - OPEL COMBO (71_) 1.4 (07.94 A 10.01) 82cv 1389cc Caixa - OPEL COMBO (71_) 1.7 D (07.94 A 10.01) 60cv 1686cc Caixa | | | KIT DE FOLE DO CARDAN JUNTO À RODA OPEL COMBO 1.4i - 1.5 TD - 1.7D - 1.7 TD (1994 A 2001) | |
| | 170x120x220mm | 1f-160x105mm 1f-d50mm | | d95x130mm | 1f-d78mm 1f-d23mm |
|  | RT08937 | NO. 5562230 - 9191262 |  | T0039 | NO. 350127 - 90447946 - 0350127 |
| | TUBO DE TRAVÃO FRENTE LH-RH OPEL COMBO 1.3 CDTI 16V (APÓS 10-2004) - 1.4 (APÓS 10-2004) - 1.4 16V (APÓS 08-2005) - 1.6 (APÓS 10-2001) - 1.7 CDTI 16V (APÓS 12-2004) - 1.7 Di 16V (APÓS 10-2001) | | | BATENTE DO CENTRO DA BARRA ESTABILIZADORA OPEL COMBO 1.7D (07-1994 A 10-2001) | |
| | 320mm | F8 - OR29 | | 40x37x34mm | 1f-d21mm |
|  | Z80540 | NO. 90022049 - 2240861 | | | |
| | Mola de painel OPEL COMBO | | | | |
| | d12x14.3mm | 1p-d7-12.3mm | | | |

| | | | |
|---|--|---|---|
|  | <p>E1007 NO. 852722</p> <p>SUPORTE DE ESCAPE</p> <p>OPEL CORSA</p> |  | <p>E1007 NO. 852722</p> <p>SUPORTE DE ESCAPE</p> <p>OPEL CORSA</p> |
| | <p>70x47x40mm NULL</p> | | <p>70x47x40mm NULL</p> |
|  | <p>R2470 NO. 1336323 - M-220543</p> <p>TUBO INFERIOR DO RADIADOR</p> <p>OPEL CORSA 1200</p> |  | <p>RT80583 NO. 5562247</p> <p>TUBO DE TRAVÃO TRÁS LH (COM DISCO)</p> <p>OPEL CORSA 1.0 (motor Z 10 XEP) (APÓS 07-2006) - 1.2 (motor Z 12 XEP) (APÓS 07-2006) - 1.3 CDTi (motor Z 13 DTH) (APÓS 07-2006) - 1.3 CDTi (motor Z 13 DTJ) (APÓS 07-2006) - 1.4 (motor Z 14 XEP) (APÓS 07-2006) - 1.6 TURBO (motor Z 16 LEL) (APÓS 02-2007) -</p> |
| | <p>B440-d35/35mm 115-205-100-110-70mm</p> | | <p>760mm NULL</p> |
|  | <p>Z80628 NO. 2240582</p> <p>Mola de painel</p> <p>OPEL CORSA</p> |  | <p>Z80655 NO. 2346824 - 2338955 - 90431553 - 90283614 - 2338961 - 8964.81 - 8964.57</p> <p>Mola de painel</p> <p>OPEL CORSA</p> |
| | <p>d17x18mm 1p-d8.5-12mm</p> | | <p>d14x17.5mm 1p-d8-15.5mm</p> |
|  | <p>Z80660 NO. 1217801</p> <p>Mola de fixação</p> <p>OPEL CORSA</p> |  | <p>Z80662 NO. 1218604</p> <p>Mola de fixação</p> <p>OPEL CORSA (Após 1993)</p> |
| | <p>30x25x32mm 1p-12x11-9mm</p> | | <p>26x23.4x20mm NULL</p> |
|  | <p>Z80730 NO. 1406984</p> <p>Mola de fixação</p> <p>OPEL CORSA</p> |  | <p>Z80739 NO. 1400806 - 51111964186</p> <p>Mola de fixação</p> <p>OPEL CORSA</p> |
| | <p>d18x25.5mm 1p-8x10-23.5mm 1f-d5.5mm</p> | | <p>d20x41mm 1p-d6.5-20.5mm</p> |
|  | <p>Z80743 NO. 2345957</p> <p>Mola de painel</p> <p>OPEL CORSA</p> |  | <p>Z80792 NO. 174864</p> <p>Mola de painel</p> <p>OPEL CORSA</p> |
| | <p>d17x19mm 1p-d9-13mm</p> | | <p>d17.6x18.8mm 1p-d8.5-14.5mm</p> |

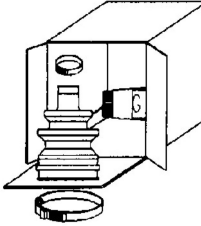
OPEL CORSA A







| | | | |
|---|--|--|---|
|  | <p>A0100 NO. 684195</p> <p>SUPORTE FRENTE DIREITO DO MOTOR</p> <p>OPEL CORSA A 1.0 - 1.2 - 1.3 - CORSA A TR 1.3</p> |  | <p>A0101 NO. 684262</p> <p>SUPORTE FRENTE ESQUERDO DO MOTOR</p> <p>OPEL CORSA A 1.0 - 1.2 - 1.3 - CORSA A TR 1.3</p> |
| | <p>114x91x56mm 2p-d9-25mm 2f-d8mm</p> | | <p>89x83x70mm 1p-d10-20mm 1f-d10mm</p> |

| | | | |
|---|--|---|--|
|  | <p>A1055 NO. 684280</p> <p>SUPORTE ESQUERDO DO MOTOR (CAIXA DE VELOCIDADES)</p> <p>OPEL CORSA A 1500 DIESEL - A 1500 TURBO DIESEL - CORSA A TR 1.5D</p> |  | <p>A1069 NO. 90304647 - 682555</p> <p>SUPORTE TRASEIRO DO MOTOR (CAIXA)</p> <p>OPEL CORSA A 1500 DIESEL - A 1500 TURBO DIESEL</p> |
| | 89x85x70mm 1p-d10-20mm 1f-d10mm | | 145x90x66mm 1f-d10mm |
|  | <p>A1206 NO. 682549</p> <p>APOIO ESQUERDO DE MOTOR TRÁS</p> <p>OPEL CORSA A 1.4i - 1.4S - 1.4Si (1990 A 1993)</p> |  | <p>A1214 NO. 682552</p> <p>APOIO DE MOTOR (PARTE DE TRÁS)</p> <p>OPEL CORSA A 1.0 - 1.2 - 1.3 - 1.4i - 1.4S (09-1982 A 03-1993)</p> |
| | 158x90x60mm 2r-d10mm | | 145x85x66mm 1f-d10mm 1f-d8mm |
|  | <p>A1398 NO. 684281</p> <p>SUPORTE DE MOTOR DIREITO</p> <p>OPEL CORSA A D - A TD</p> |  | <p>E0013 NO. 852715 - 852716 - 852720</p> <p>ESTICADOR DE ESCAPE</p> <p>OPEL CORSA A 1.0 - 1.2 - 1.3 - 1.5D - 1.5TD - (1982 A 1993)</p> |
| | 180x113x95mm 1p-d10-45mm | | 66x56x13mm NULL |
|  | <p>E0048 NO. 852506</p> <p>ESTICADOR DE ESCAPE</p> <p>OPEL CORSA A (09-1982 A 03-1993)</p> |  | <p>E1003 NO. 856519</p> <p>SUPORTE TRÁS DO ESCAPE</p> <p>OPEL CORSA (A)</p> |
| | 59x40x28mm 2f-d14mm | | 50x44x42mm 2f-d5mm 2f-18x9mm |
|  | <p>F0517-I NO. 374093 - 374101</p> <p>FOLE DO SEMI-EIXO INTERNO</p> <p>OPEL CORSA A 1.0 - 1.2 - 1.3 - 1.4 - 1.5D - 1.5TD - 1.6GSi (1982 A 1993)</p> |  | <p>F0518-I NO. 374094</p> <p>FOLE DO SEMI-EIXO EXTERNO</p> <p>OPEL CORSA A 1.0 - 1.2 - 1.3 - 1.5D - 1.5TD - 1.6GSi (1982 A 1993)</p> |
| | d90x103mm 1f-d74mm 1f-d22mm | | d86x108mm 1f-d22mm 1f-d77mm |
|  | <p>F0684-I NO. 902826</p> <p>FOLE DA CREMALHEIRA DA DIREÇÃO ESQUERDO E DIREITO</p> <p>OPEL CORSA A 1.0 - 1.2 - 1.3 - 1.5D - 1.5TD - (1982 A 1993)</p> |  | <p>F4001 NO. 738416 - 0738416 - 90168233</p> <p>FOLE DA ALAVANCA DE VELOCIDADES</p> <p>OPEL CORSA A (TODAS AS MOTORIZAÇÕES) (1982 A 1993)</p> |
| | d68x172mm 1f-d48mm 1f-d12mm | | 210x180x120mm 1f-d10mm |
|  | <p>H740 NO.</p> <p>PALA ORIGINAL</p> <p>OPEL CORSA A (1991)</p> |  | <p>H755 NO.</p> <p>PALA ORIGINAL</p> <p>OPEL CORSA A (1982 A 1993)</p> |
| | 370x210mm NULL | | 40x215mm NULL |
|  | <p>H771 NO.</p> <p>PALA GM</p> <p>OPEL CORSA A TR (1982 A 1993)</p> |  | <p>KF2330 NO. 374094</p> <p>FOLE DO LADO DA RODA</p> <p>OPEL CORSA A 1.0 - 1.2 - 1.3 - 1.5D - 1.5TD - 1.6GSi (1982 A 1993)</p> |
| | 376x215x12mm NULL | | d90x110mm 1f-d23mm 1f-d78mm |

| | | | |
|---|--|--|---|
|  | <p>L3020 NO. 856700</p> <p>CASQUILHO DE ESCAPE</p> <p>OPEL CORSA A (09-1982 A 03-1993)</p> <p>NULL NULL</p> |  | <p>M6003 NO. 854952</p> <p>JUNTA DE ESCAPE</p> <p>OPEL CORSA A (1982 A 1993)</p> <p>d59x13.5mm 1f-d45mm</p> |
|  | <p>M6004 NO. 854934</p> <p>JUNTA DE ESCAPE</p> <p>OPEL CORSA A 1000 S - 1200 N (APÓS 1983)</p> <p>d56x13.5mm 1f-d41mm</p> |  | <p>M6041 NO. 854842 - 90091769</p> <p>JUNTA DE ESCAPE</p> <p>OPEL CORSA A (1983 A 1990)</p> <p>142x68mm 2f-d50mm</p> |
|  | <p>M6054 NO. 854949 - 94344459</p> <p>JUNTA DE ESCAPE</p> <p>OPEL CORSA A</p> <p>d54x5mm 1f-d44mm</p> |  | <p>M6082 NO. 854955 - 854943 - 854944 - 97069287</p> <p>JUNTA DE ESCAPE</p> <p>OPEL CORSA A (APÓS 1988)</p> <p>d64x5mm 1f-d53mm</p> |
|  | <p>P1012 NO. 560808</p> <p>CAPA DE PEDAL DO TRAVÃO E EMBRAIAGEM</p> <p>OPEL CORSA A 1.0 - 1.2 - 1.3</p> <p>60x55x9mm NULL</p> |  | <p>P3668-C NO.</p> <p>CAPA DE PEDAL DO TRAVÃO E EMBRAIAGEM</p> <p>OPEL CORSA A 1ª SÉRIE</p> <p>53x43x10mm NULL</p> |
|  | <p>R021525 NO. 1818521 - 102283 - 4057134 - 60502989 - 7595759 - 11530788160 - 11531258300</p> <p>TUBO RETORNO DE ÁGUA AO DEPÓSITO DE ARREFECIMENTO</p> <p>OPEL CORSA A 1.2</p> <p>B200-d15/15mm 185-80mm</p> |  | <p>R220539 NO. 1336745 - 90352373 - 90350621</p> <p>TUBO DE RADIADOR INFERIOR</p> <p>OPEL CORSA A 1.0 (TEL. 4054862 A 87)</p> <p>B320-d32/32mm 70-200-50-65mm</p> |
|  | <p>R220540 NO. 1336319 - 90128693</p> <p>TUBO DE RADIADOR SUPERIOR</p> <p>OPEL CORSA A 1.0</p> <p>B340-d34/54mm 110-330-140-80mm</p> |  | <p>R220541 NO. 1336384 - 90183672</p> <p>TUBO DE RADIADOR INFERIOR</p> <p>OPEL CORSA A 1.0</p> <p>B310-d35/35mm 75-180-50-95mm</p> |
|  | <p>R220542 NO. 1336320 - 90128695</p> <p>TUBO DE RADIADOR SUPERIOR</p> <p>OPEL CORSA A 1.2</p> <p>B225-d34/34mm 105-80-100mm</p> |  | <p>R220543 NO. 1336323 - 90128699 - 1336410 - 90215368</p> <p>TUBO DE RADIADOR INFERIOR</p> <p>OPEL CORSA A 1.2 - 1.3</p> <p>B460-d35/35mm 70-110-120-200-40-100mm</p> |
|  | <p>R220544 NO. 1336291 - 90144524</p> <p>TUBO DE LIGAÇÃO DA BOMBA AO RADIADOR</p> <p>OPEL CORSA A 1.2</p> <p>B175-d35/33mm 55-90-55mm</p> |  | <p>R220546 NO. 1336431 - 90264448 - 90271497</p> <p>TUBO SUPERIOR DO RADIADOR</p> <p>OPEL CORSA A 1.3</p> <p>B210-d37-d32mm 105-110-70mm</p> |

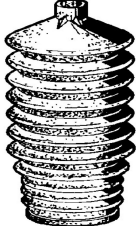
| | | | |
|---|--|---|---|
|  | <p>R8072 NO. 1818335 - 1818361 - 838526</p> <p>TUBO DE CHAUFAGEM DO COLECTOR AO CARBURADOR</p> <p>OPEL CORSA A 1.3 - 1.4</p> <p>B200-d16/16mm d10mm 65-145-100-60mm 340mm</p> |  | <p>R8073 NO. 1818527 - 1818330</p> <p>TUBO DE CHAUFAGEM DO CARBURADOR</p> <p>OPEL CORSA A 1.3 - 1.4</p> <p>B135-d20/17mm d9mm 65-170-110-90mm 440mm</p> |
|  | <p>R8083 NO. 1336467 - 1336484 - 90296942 - 90297639 - 90298564 - 90299114</p> <p>TUBO INFERIOR DO RADIADOR</p> <p>OPEL CORSA A 1.5 D - 1.5 TD</p> <p>B190-d33/33mm d20mm 70-85-75-65mm 55-75-85mm</p> |  <p>FB3/1 OR1 Componenti / Components</p> | <p>RT08540 NO. 532343 - 562343 - 90010524 - 90235567</p> <p>TUBO DE TRAVÃO FRENTE LH-RH</p> <p>OPEL CORSA A 2 Volumi - Coda spiovente (93_ - 94_ - 98_ - 99_) 1.0 (10 S) 45CV (09-1982 A 03-1993) - 1.2 (12 NC - E 12 GV) 45CV (09-1982 A 08-1990) - 1.2 (12 S) 60CV (09-1982 A 08-1990) - 1.2 i (C 12 NZ) 45CV (09-1989 A 03-1993) - 1.2 N (12 NV) 52CV (01-1990 A</p> <p>305mm FB3/1 - OR1</p> |
|  <p>FB3/1 OR1 Componenti / Components</p> | <p>RT08540 NO. 532343 - 562343 - 90010524 - 90235567</p> <p>TUBO DE TRAVÃO FRENTE LH-RH</p> <p>OPEL CORSA A Furgonato 1.0 (10 S) 45CV (02-1986 A 04-1989) - 1.2 (12 NC - E 12 GV) 45CV (02-1986 A 04-1989) - 1.2 (12 S) 60CV (02-1986 A 07-1990) - 1.2 (12 ST) 54CV (02-1986 A 04-1989) - 1.3 (13 NB) 60CV (02-1986 A 04-1989) - 1.3 (13 SB) 69CV (02-1986 A 04-</p> <p>305mm FB3/1 - OR1</p> |  <p>FB3/1 OR1 Componenti / Components</p> | <p>RT08540 NO. 532343 - 562343 - 90010524 - 90235567</p> <p>TUBO DE TRAVÃO FRENTE LH-RH</p> <p>OPEL CORSA A TR (91_ - 92_ - 96_ - 97_) 1.0 (10 S) 45CV (09-1982 A 09-1992) - 1.2 i (C 12NZ) 45CV (09-1989 A 03-1993) - 1.2 N (12 NC - E 12 GV) 45CV (01-1985 A 10-1987) - 1.2 S (12 S) 58CV (09-1982 A 10-1987) - 1.2 S (12 ST) 55CV (09-1982 A 03-1993) - 1.3 (13 NB -</p> <p>305mm FB3/1 - OR1</p> |
|  | <p>S1072 NO. 402643</p> <p>SILENT-BLOC DO ESTABILIZADOR</p> <p>OPEL CORSA A 1.0 - 1.2 - 1.3 - 1.4 - 1.5D - 1.5TD (1982 A 1993)</p> <p>d52x65mm d39mm 1f-d10mm</p> |  | <p>S1073 NO. 352327</p> <p>SILENT-BLOC DO BRAÇO DA SUSPENSÃO</p> <p>OPEL CORSA A 1.0 - 1.2 - 1.3 - 1.4 - 1.5D - 1.5TD (1982 A 1993)</p> <p>d43x52mm d34mm 1f-d10mm</p> |
|  | <p>S1076 NO. 353560</p> <p>SILENT-BLOC DO ESTICADOR DA SUSPENSÃO</p> <p>OPEL CORSA A 1.0 - 1.2 - 1.3 - 1.4 - 1.5D - 1.5TD (1982 A 1993)</p> <p>d46x36mm d42mm d32mm 1f-d14mm</p> |  | <p>T0038F16 NO. 90168602 - 350109</p> <p>BATENTE DE ESTABILIZADOR FURO 17 mm</p> <p>OPEL CORSA A 1.0 - 1.2 - 1.3 (1982 A 1993)</p> <p>40x37x34mm 1f-17mm</p> |
|  | <p>T0038F19 NO.</p> <p>BATENTE DE ESTABILIZADOR FURO 19 mm</p> <p>OPEL CORSA A 1.0 - 1.2 - 1.3 (1982 A 1993)</p> <p>40x37x34mm 1f-19mm</p> |  | <p>Y3000 NO. 854980 - 854977 - 854917 - 90128081</p> <p>PARAFUSO MOLA DE ESCAPE</p> <p>OPEL CORSA A (1983 A 1992)</p> <p>82x13mm 1p-d10-20mm</p> |
|  | <p>Z80503 NO. 174846</p> <p>Mola de friso</p> <p>OPEL CORSA A</p> <p>56x39x5.6mm NULL</p> |  | <p>Z80540 NO. 90022049 - 2240861</p> <p>Mola de painel</p> <p>OPEL CORSA A</p> <p>d12x14.3mm 1p-d7-12.3mm</p> |

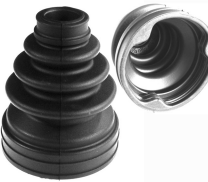
| | | | |
|---|---|--|---|
|  | <p>A0101 NO. 684262</p> <p>SUPORTE FRENTE ESQUERDO DO MOTOR</p> <p>OPEL CORSA B 1.2 - 1.4 - 1.6 GASOLINA</p> <p>89x83x70mm 1p-d10-20mm 1f-d10mm</p> |  | <p>A1055 NO. 684280</p> <p>SUPORTE ESQUERDO DO MOTOR (CAIXA DE VELOCIDADES)</p> <p>OPEL CORSA B 1500 DIESEL - CORSA B 1500 TURBO DIESEL</p> <p>89x85x70mm 1p-d10-20mm 1f-d10mm</p> |
|  | <p>A1069 NO. 90304647 - 682555</p> <p>SUPORTE TRASEIRO DO MOTOR (CAIXA)</p> <p>OPEL CORSA B 1500 DIESEL - B 1500 TURBO DIESEL</p> <p>145x90x66mm 1f-d10mm</p> |  | <p>A1204 NO. 684126</p> <p>APOIO DE MOTOR (LADO ESQUERDO)</p> <p>OPEL CORSA B 1.5D - 1.5TD - 1.7D - 1.7TD (APÓS 1993)</p> <p>153x90x60mm 2r-d10mm</p> |
|  | <p>A1205 NO. 684666 - 90445300</p> <p>APOIO DE MOTOR FRENTE DIREITO</p> <p>OPEL CORSA B 1.0i 12v - 1.2 - 1.4 - 1.6 - 1.6 16v (APÓS 1993)</p> <p>160x100x100mm 1p-d10-45mm 1r-d9mm</p> |  | <p>A1208 NO. 684160</p> <p>APOIO DE MOTOR (LADO DIREITO)</p> <p>OPEL CORSA B 1.5D - 1.5TD - 1.7D - 1.7TD (APÓS 1993)</p> <p>165x92x80mm 2f-d10mm</p> |
|  | <p>A1209 NO. 684661 - 684665 - 684667</p> <p>APOIO FRENTE ESQUERDO DE MOTOR</p> <p>OPEL CORSA B 1.2i - 1.2i 16v - 1.4 - 1.6 - 1.4 16v - 1.6 16v (APÓS 1993)</p> <p>200x90x60mm 2r-d10mm</p> |  | <p>A1211 NO. 90495170</p> <p>APOIO FRENTE ESQUERDO DE MOTOR</p> <p>OPEL CORSA B (APÓS 1993) - 1.4 16v - 1.6 - 1.6 16v</p> <p>200x90x60mm 2r-d10mm</p> |
|  | <p>A1212 NO. 684659 - 684669</p> <p>APOIO FRENTE ESQUERDO DE MOTOR</p> <p>OPEL CORSA B 1.2 - 1.4 - 1.6i 16v (APÓS 1993)</p> <p>157x90x60mm 2r-d10mm</p> |  | <p>A1214 NO. 682552</p> <p>APOIO DE MOTOR (PARTE DE TRÁS)</p> <p>OPEL CORSA B 1.2i - 1.4i - 1.4i 16v - 1.6i 16v (03-1993 A 09-2000)</p> <p>145x85x66mm 1f-d10mm 1f-d8mm</p> |
|  | <p>A1215 NO. 684294</p> <p>APOIO DE MOTOR FRENTE DIREITO</p> <p>OPEL CORSA B 1.0i 12v - 1.2 - 1.4 - 1.6i 16v - (VEÍCULOS COM DIRECÇÃO ASSISTIDA) (03-1993 A 09-2000)</p> <p>160x95x60mm 2r-d10mm</p> |  | <p>A1314 NO. 344519</p> <p>APOIO DE AMORTECEDOR DA FRENTE</p> <p>OPEL CORSA B 1.2i - 1.4i - 1.4i 16v - 1.5 D - 1.5 DT - 1.6i 16v - 1.7D - 1.7 TD (APÓS 1993)</p> <p>136x109x38mm 2p-d8-17mm 1f-d37mm</p> |
|  | <p>BB24 NO. 350376</p> <p>ABRAÇADEIRA DE BARRA ESTABILIZADORA</p> <p>OPEL CORSA B (APÓS 1993)</p> <p>73x29x30mm 2p-d8-23mm</p> |  | <p>C0233 NO. 1160724 - 90054143</p> <p>BOTÃO AFINAÇÃO CAPÔT</p> <p>OPEL CORSA B (73_78_79_) 1.0 i 12V (11.96 A 09.00) 54cv 973cc Hatchback - OPEL CORSA B (73_78_79_) 1.2 i (03.93 A 09.00) 45cv 1195cc Hatchback - OPEL CORSA B (73_78_79_) 1.2 i (03.93 A 09.00) 45cv 1195cc Hatchback - OPEL CORSA B (73_78_79_) 1.2 i 16V (03.98 A 09.00) 65cv 1199cc Hatchback - OPEL CORSA B (73_78_79_) 1.4 i (03.93 A 09.00) 60cv 1389cc Hatchback - OPEL CORSA B (73_78_79_) 1.4 Si (03.93 A 09.00) 82cv 1389cc Hatch...etc.</p> <p>d19x31mm NULL</p> |
|  | <p>E0013 NO. 852715 - 852716 - 852720</p> <p>ESTICADOR DE ESCAPE</p> <p>OPEL CORSA B 1.0i 12v - 1.2i - 1.4i - 1.5D - 1.6i - 1.7D (1993 A 2000)</p> <p>66x56x13mm NULL</p> |  | <p>E1003 NO. 856519</p> <p>SUPORTE TRÁS DO ESCAPE</p> <p>OPEL CORSA (B)</p> <p>50x44x42mm 2f-d5mm 2f-18x9mm</p> |

| | | | |
|---|---|---|--|
|  | <p>E1031 NO. 852516</p> <p>ESTICADOR DE ESCAPE</p> <p>OPEL CORSA B 1.0i 12v - 1.2i - 1.2i 16v - 1.4i - 1.5 - 1.5TD - 1.6i 16v - 1.7D (1993 A 2000)</p> <p>68x44x42mm NULL</p> |  | <p>E1071 NO. 852723 - 90352773</p> <p>ESTICADOR DE ESCAPE</p> <p>OPEL CORSA B COMBO (APÓS 1993)</p> <p>72x61x20mm NULL</p> |
|  | <p>F0517-I NO. 374093 - 374101</p> <p>FOLE DO SEMI-EIXO INTERNO</p> <p>OPEL CORSA B 1.2i - 1.4i - 1.5TD - 1.7D (1992 A 2000)</p> <p>d90x103mm 1f-d74mm 1f-d22mm</p> |  | <p>F0518-I NO. 374094</p> <p>FOLE DO SEMI-EIXO EXTERNO</p> <p>OPEL CORSA B 1.2i - 1.4i - 1.5D - 1.6i - 1.7D (1993 A 2000)</p> <p>d86x108mm 1f-d22mm 1f-d77mm</p> |
|  | <p>F0520-I NO. 90095162 - 374018</p> <p>FOLE DO SEMI-EIXO INTERNO (F1026)</p> <p>OPEL CORSA (B) 1.2i - 1.4i - 1.4i 16v - 1.4iSi - 1.4TD - 1.5D - 1.5TD - 1.6 - 1.6 16v - 1.6 Gsi 16v (1993 A 2000)</p> <p>d72x94mm 1f-d54mm 1f-d19mm</p> |  | <p>F0684-I NO. 902826</p> <p>FOLE DA CREMALHEIRA DA DIRECÇÃO ESQUERDO E DIREITO</p> <p>OPEL CORSA B 1.0i - 1.2i - 1.4i - 1.5D - 1.6i - 1.7D (1993 A 2000) (VEÍCULOS SEM DIRECÇÃO ASSISTIDA)</p> <p>d68x172mm 1f-d48mm 1f-d12mm</p> |
|  | <p>F1617-I NO. 1609087 - 26032286</p> <p>FOLE DE DIRECÇÃO ASSISTIDA DIREITO E ESQUERDO</p> <p>OPEL CORSA B (1993 A 2000)</p> <p>d62x184mm 1f-d11mm 1f-d48mm</p> |  | <p>F1829H-I NO. 1603005 - 20424726 - 26067603 - 26070498</p> <p>FOLE DA TRANSMISSÃO JUNTO À RODA</p> <p>OPEL CORSA B 1.0i 12V - 1.2i 16v (1993 A 2000)</p> <p>d90x130mm 1f-d72mm 1f-d23mm</p> |
|  | <p>F1845-I NO. 1603004 - 1603230</p> <p>FOLE DA TRANSMISSÃO LADO DA CAIXA</p> <p>OPEL CORSA B 1.0i 12V AUTOM. X10XE54 (02-1997 A 11-2000)</p> <p>d81x95mm 1f-d72mm 1f-d22mm</p> |  | <p>F4094 NO. 5738414 - 738978 - 0738978 - 90437426 - 90373314</p> <p>FOLE DE ALAVANCA DE VELOCIDADES</p> <p>OPEL CORSA B (73_78_79_) 1.0 i 12V (11.96 A 09.00) 54cv 973cc Hatchback - OPEL CORSA B (73_78_79_) 1.2 i (03.93 A 09.00) 45cv 1195cc Hatchback - OPEL CORSA B (73_78_79_) 1.2 i (03.93 A 09.00) 45cv 1195cc Hatchback - OPEL CORSA B (73_78_79_) 1.2 i 16 V (03.98 A 09.00) 65cv 1199cc Hatchback - OPEL CORSA B (73_78_79_) 1.4 i (03.93 A 09.00) 60cv 1389cc Hatchback - OPEL CORSA B (73_78_79_) 1.4 S...etc.</p> <p>170x120x220mm 1f-160x105mm 1f-d50mm</p> |
|  | <p>H750 NO.</p> <p>PALA ORIGINAL</p> <p>OPEL CORSA B (1993 A 2000)</p> <p>350x205mm NULL</p> |  | <p>KF2330 NO. 374094</p> <p>FOLE DO LADO DA RODA</p> <p>OPEL CORSA B 1.2i - 1.4i - 1.5D - 1.6i - 1.7D (1993 A 2000)</p> <p>d90x110mm 1f-d23mm 1f-d78mm</p> |
|  | <p>KF2335 NO. 1603188 - 90446236</p> <p>KIT DE FOLE JUNTO À RODA</p> <p>OPEL CORSA B 1.2i - 1.4i - 1.5D - 1.5TD - 1.6i - 1.7D (APÓS 10-1993)</p> <p>d98x112mm 1f-d76mm 1f-d22mm</p> |  | <p>KF2371-T NO. 1603005 - 20424726 - 26067603 - 26070498</p> <p>KIT DE FOLE DO CARDAN JUNTO À RODA</p> <p>OPEL CORSA B 1.0i 12V - 1.2i 16v (1993 A 2000)</p> <p>d88x126mm 1f-d72mm 1f-d23mm</p> |
|  | <p>KF2527-T NO. 1603189</p> <p>KIT DE FOLE DO CARDAN JUNTO À RODA</p> <p>OPEL CORSA B 1.2i - 1.4i - 1.4i 16v - 1.5 TD - 1.7D - 1.7 Di 16v - 1.7 DTi 16v (1993 A 2000)</p> <p>d95x130mm 1f-d78mm 1f-d23mm</p> |  | <p>M6003 NO. 854952</p> <p>JUNTA DE ESCAPE</p> <p>OPEL CORSA B (1993 A 2000)</p> <p>d59x13.5mm 1f-d45mm</p> |

| | | | |
|--|---|--|--|
|  | <p>M6054 NO. 854949 - 94344459</p> <p>JUNTA DE ESCAPE</p> <p>OPEL CORSA B (1993 A 2000)</p> <p>d54x5mm 1f-d44mm</p> |  | <p>M6075 NO. 854825 - 97180750</p> <p>JUNTA DE ESCAPE</p> <p>OPEL CORSA B TURBO DIESEL</p> <p>d64x5mm 1f-d51mm</p> |
|  | <p>M6082 NO. 854955 - 854943 - 854944 - 97069287</p> <p>JUNTA DE ESCAPE</p> <p>OPEL CORSA B 1.5TD (APÓS 03-1993)</p> <p>d64x5mm 1f-d53mm</p> |  | <p>P1012 NO. 560808</p> <p>CAPA DE PEDAL DO TRAVÃO E EMBRAIAGEM</p> <p>OPEL CORSA B 1.0i 12v - 1.2i - 1.2i 16v - 1.4i - 1.4i 16v - 1.4Si - 1.5D - 1.5TD - 1.7D - (APÓS 1993)</p> <p>60x55x9mm NULL</p> |
|  | <p>Q2009 NO.</p> <p>UNIÃO DE ESCAPE 48/45x80mm</p> <p>OPEL - CORSA B (73_ - 78_ - 79_) - 1.2 i 16V (03.98 - 09.00) 65cv 1199cc Hatchback</p> <p>80x77x55mm 1f-d45/48mm</p> |  | <p>R221450 NO. 1337186 - 90444463</p> <p>TUBO SUPERIOR RADIADOR</p> <p>OPEL CORSA B 1.2 - 1.4</p> <p>B185-d40/34mm 120-100-80mm</p> |
|  | <p>R221451 NO. 1337193 - 90410065 - 90444477</p> <p>TUBO DE RADIADOR INFERIOR</p> <p>OPEL CORSA B 1.2 - 1.4</p> <p>B360-d37/33mm 125-205-65mm</p> |  | <p>R8081 NO. 1818256</p> <p>TUBO DO ARREFECIMENTO</p> <p>OPEL CORSA B 1.2 - 1.4</p> <p>B195-d18/18mm 75-95-75mm</p> |
|  | <p>R8082 NO. 1337202 - 1337320 - 1337380 - 90444868 - 90511846 - 90570029</p> <p>TUBO INFERIOR DO RADIADOR</p> <p>OPEL CORSA B - 1.5D - 1.7D (1993 A 2000)</p> <p>B300-d34/31mm d18mm 65-70-90-155-65mm 175-220-130-100-13</p> |  | <p>R8084 NO. 1337190 - 90444470</p> <p>TUBO SUPERIOR DO RADIADOR</p> <p>OPEL CORSA B 1.4i - 1.4i 16v - 1.6i 16v</p> <p>B160-d34/34mm 145-180-95mm</p> |
|  | <p>R8085 NO. 1337191 - 90444475</p> <p>TUBO SUPERIOR DO RADIADOR</p> <p>OPEL CORSA B - 1.6i 16v Motor X16XE (09-1994 A 09-2000) - 1.6i 16v Motor C16 SEL (08-1997 A 09-2000)</p> <p>B185-d32/32mm NULL</p> |  | <p>R8100 NO. 1337381 - 90570023</p> <p>TUBO SUPERIOR DO RADIADOR</p> <p>OPEL CORSA B 1.5D - 1.5TD - 1.7D - 1.7TD (APÓS 1993)</p> <p>B350-d34/34mm 200-90-110mm</p> |
|  | <p>R8136 NO. 6818182</p> <p>TUBO DEPÓSITO COMPENSAÇÃO AO TUBO ÁGUA RÍGIDO</p> <p>OPEL CORSA B (73_ , 78_ , 79_) 1.4 i 16V (09.94 A 09.00) 90cv 1389cc Hatchback - OPEL CORSA B (73_ , 78_ , 79_) 1.4 i 16V (09.94 A 09.00) 91cv 1389cc Hatchback - OPEL CORSA B (73_ , 78_ , 79_) 1.6 i 16V (09.94 A 09.00) 106cv 1598cc Hatchback - OPEL CORSA B (73_ , 78_ , 79_) 1.6 GSI 16V (03.93 A 09.00) 109cv 1598cc Hatchback</p> <p>B340-17/17mm 60-80-100-60-60-180mm</p> |  | <p>R8137 NO. 6818417 - 1818032</p> <p>TUBO PERMUTADOR AQUECIMENTO</p> <p>OPEL CORSA B (73_ , 78_ , 79_) 1.2 i 16V (03.98 A 09.00) 65cv 1199cc Hatchback</p> <p>B190-19/19mm 140-70-50-130-90-40-40-60-50-60-130mm</p> |
|  | <p>RT08615 NO. 562095 - 96212323 - 90473452</p> <p>TUBO DE TRAVÃO FRENTE LH-RH</p> <p>OPEL CORSA B TT (03-1993 A 09-2000) - OPEL TIGRA TT (APÓS 07-1994)</p> <p>340mm FB3/1 - OR19</p> |  | <p>S1072 NO. 402643</p> <p>SILENT-BLOC DO ESTABILIZADOR</p> <p>OPEL CORSA B 1.0i - 1.2i - 1.4i - 1.5D - 1.5TD - 1.7D (1992 A 2000)</p> <p>d52x65mm d39mm 1f-d10mm</p> |

















OPEL CORSA B

| | | | |
|---|--|---|--|
|  | <p>S1126 NO. 904445097 - 352301</p> <p>SILENT-BLOC DA SUSPENSÃO</p> <p>OPEL CORSA B 1.0i - 1.2i - 1.4i - 1.5D - 1.5TD - 1.7D - 1.7TD (1993 A 2000)</p> <p>d45x52mm d38mm 1f-d10mm</p> |  | <p>S1508 NO. 353561</p> <p>SILENT BLOCO DO BRAÇO DA SUSPENSÃO DA FRENTE</p> <p>OPEL CORSA B (73_ - 78_ - 79_) 1.0 i 12V (X 10 XE) 54CV (11-1996 A 09-2000) - 1.2 i (12 NZ) 45CV (03-1993 A 09-2000) - 1.2 i (C 12 NZ - X 12 SZ) 45CV (03-1993 A 09-2000) - 1.2 i 16V (X 12 XE) 65CV (03-1998 A 09-2000) - 1.4 i (C 14 NZ - X 14 SZ) 60CV (03-1993 A</p> <p>d50/46x40mm c18mm d37.5mm 1f-d14mm</p> |
|  | <p>T0039 NO. 350127 - 90447946 - 0350127</p> <p>BATENTE DO CENTRO DA BARRA ESTABILIZADORA</p> <p>OPEL CORSA B 1.0i - 1.2i - 1.4i - 1.5D - 1.5TD - 1.7D (1993 A 2000)</p> <p>40x37x34mm 1f-d21mm</p> |  | <p>W5045 NO. 5614417</p> <p>POLIE DA CAMBOTA (1+1+1 PISTAS)</p> <p>OPEL CORSA B 1.5D - 1.7D - 1.7TD</p> <p>d139mm d48mm</p> |
|  | <p>W5078 NO. 5614430 - 9129210 - 90412837 - 5614406 - 90502115 - 0614611 - 614611</p> <p>POLIE DA CAMBOTA (6 PISTAS)</p> <p>OPEL CORSA B 1.0i 12v (11-1996 A 09-2000) - 1.2i 16v (03-1998 A 09-2000) - 1.4i 16v (09-1994 A 09-2000)</p> <p>d128.5mm d26mm</p> |  | <p>Y3004 NO. 854982 - 90128082</p> <p>PARAFUSO ESCAPE</p> <p>OPEL CORSA B (APÓS 1993)</p> <p>d19x65mm d12mm 1r-d10mm</p> |
|  | <p>Z9004 NO. 856563</p> <p>MOLA DE ESCAPE</p> <p>OPEL CORSA B (1993 A 1995)</p> <p>25x22x5mm NULL</p> | | |

OPEL CORSA C

| | | | |
|--|--|--|--|
|  | <p>A1634 NO. 684234 - 90189477</p> <p>APOIO DO MOTOR PARTE DA FRENTE ESQUERDO</p> <p>OPEL CORSA C 1.4 - 1.8</p> <p>110x90x65mm 2p-d10-26mm 2r-d10mm</p> |  | <p>A1635 NO. 644184 - 684183 - 93183223</p> <p>APOIO DO MOTOR PARTE DA FRENTE DIREITO</p> <p>OPEL CORSA C 1.3 CDTi (APÓS 06-2003) - 1.4 - 1.8</p> <p>170x110x120mm NULL</p> |
|  | <p>A1636 NO. 684188 - 684194</p> <p>APOIO DO MOTOR PARTE DA FRENTE ESQUERDO</p> <p>OPEL CORSA C 1.0 - 1.2 - CORSA C 1.7Di - 1.7DTi - 1.7Di 16v - 1.7DTi 16v (APÓS 09-2000)</p> <p>170x140x110mm 2f-d18mm</p> |  | <p>A1935 NO. 846082</p> <p>APOIO DO MOTOR</p> <p>OPEL CORSA C (F08_ F68) 1.0 N.º chas. a partir de: 34184448 (09.00 A 06.03) 58cv 973cc Hatchback - OPEL CORSA C (F08, F68) 1.0 N.º chas. a partir de: 34184448 (06.03 A 12.09) 60cv 998cc Hatchback</p> <p>220x110x55mm 2f-d12mm 1f-19x14mm</p> |
|  | <p>A1943 NO. 0344523 - 344523 - 90468554</p> <p>APOIO AMORTECEDORES FRENTE</p> <p>OPEL CORSA C (F08, F68) 1.0 (09.00 A 06.03) 58cv 973cc Hatchback - OPEL CORSA C (F08, F68) 1.0 06.03 A 12.09) 60cv 998cc Hatchback - OPEL CORSA C (F08, F68) 1.2 (09.00 A 12.09) 75cv 1199cc Hatchback - OPEL CORSA C (F08, F68) 1.2 Twinport (07.04 A 12.09) 80cv 1229cc Hatchback - OPEL CORSA C (F08, F68) 1.4 Twinport (06.03 A 12.09) 90cv 1364cc Hatchback - OPEL CORSA C (F08, F68) 1.4 (09.00 A 12.09) 90cv 1389cc Hatchback - OPEL CORSA C (F...etc.</p> <p>d115x45mm 1f-d12mm</p> |  | <p>C0233 NO. 1160724 - 90054143</p> <p>BOTÃO AFINAÇÃO CAPÔT</p> <p>OPEL CORSA C (F08_ F68) 1.0 (09.00 A 06.03) 58cv 973cc Hatchback - OPEL CORSA C (F08, F68) 1.0 (06.03 A 12.09) 60cv 998cc Hatchback - OPEL CORSA C (F08, F68) 1.2 (09.00 A 12.09) 75cv 1199cc Hatchback - OPEL CORSA C (F08, F68) 1.2 Twinport (07.04 A 12.09) 80cv 1229cc Hatchback - OPEL CORSA C (F08, F68) 1.4 Twinport (06.03 A 12.09) 90cv 1364cc Hatchback - OPEL CORSA C (F08, F68) 1.4 (09.00 A 12.09) 90cv 1389cc Hatchback - OPEL CORSA C (...etc.</p> <p>d19x31mm NULL</p> |

| | | | |
|---|---|--|---|
|  | <p>E0013 NO. 852715 - 852716 - 852720</p> <p>ESTICADOR DE ESCAPE</p> <p>OPEL CORSA C 1.2 - 1.4 - 1.8 - 1.7Di - 1.7DTi - (APÓS 2000)</p> <p>66x56x13mm NULL</p> |  | <p>E0129 NO. 350610 - 4886606 - 90496116</p> <p>ESTICADOR DA BARRA ESTABILIZADORA DA FRENTE</p> <p>OPEL CORSA C TT</p> <p>285x36x36mm 2p-d12-25mm</p> |
|  | <p>E1092 NO. 852726</p> <p>ESTICADOR DE ESCAPE</p> <p>OPEL CORSA C (APÓS 08-2000)</p> <p>55x40x35mm NULL</p> |  | <p>F0517-I NO. 374093 - 374101</p> <p>FOLE DO SEMI-EIXO INTERNO</p> <p>OPEL CORSA C 1.2i - 1.4i - 1.7i - 1.7DTi (APÓS 2000)</p> <p>d90x103mm 1f-d74mm 1f-d22mm</p> |
|  | <p>F1829H-I NO. 1603005 - 20424726 - 26067603 - 26070498</p> <p>FOLE DA TRANSMISSÃO JUNTO À RODA</p> <p>OPEL CORSA C 1.0i - 1.2i (APÓS 2000)</p> <p>d90x130mm 1f-d72mm 1f-d23mm</p> |  | <p>F1830H-I NO. 1603189 - 1603231</p> <p>FOLE DA TRANSMISSÃO JUNTO À RODA</p> <p>OPEL CORSA C 1.3 CDTi - 1.4i 16v (APÓS 2000) - CORSA C 1.7 Di 16v - 1.7 DTi 16v</p> <p>d90x135mm 1f-d78mm 1f-d23mm</p> |
|  | <p>F1845-I NO. 1603004 - 1603230</p> <p>FOLE DA TRANSMISSÃO LADO DA CAIXA</p> <p>OPEL CORSA C 1.0i - 1.2i - 1.3 CDTi - 1.4i (APÓS 2000)</p> <p>d81x95mm 1f-d72mm 1f-d22mm</p> |  | <p>F1848-I NO. 1603238 - 1603014 - 1603183 - 374429 - 374014 - 374319 - 90543336</p> <p>FOLE DA TRANSMISSÃO JUNTO À CAIXA</p> <p>OPEL CORSA C 1.8i 16v (APÓS 2000)</p> <p>d95x100mm 1f-d65mm 1f-d24mm</p> |
|  | <p>F4093 NO. 0738423 - 738423 - 9200970 - 09200970</p> <p>FOLE DE ALAVANCA DE VELOCIDADES</p> <p>OPEL CORSA C (F08_ F68) 1.0 (09.00 A 06.03) 58cv 973cc Hatchback - OPEL CORSA C (F08, F68) 1.0 (06.03 A 12.09) 60cv 998cc Hatchback - OPEL CORSA C (F08, F68) 1.2 (09.00 A 12.09) 75cv 1199cc Hatchback - OPEL CORSA C (F08, F68) 1.2 Twinport (07.04 A 12.09) 80cv 1229cc Hatchback - OPEL CORSA C (F08, F68) 1.4 Twinport (06.03 A 12.09) 90cv 1364cc Hatchback - OPEL CORSA C (F08, F68) 1.4 (09.00 A 12.09) 90cv 1389cc Hatchback - OPEL CORSA C (...etc.</p> <p>160x110x170mm 1f-d50mm</p> |  | <p>F4094 NO. 5738414 - 738978 - 0738978 - 90437426 - 90373314</p> <p>FOLE DE ALAVANCA DE VELOCIDADES</p> <p>OPEL CORSA C Caixa (F08_ W5L) 1.2 (A Partir de 07.05) 80cv 1229cc Caixa</p> <p>170x120x220mm 1f-160x105mm 1f-d50mm</p> |
|  | <p>F4098 NO. 93181112 - 5738416</p> <p>FOLE ALAVANCA VELOCIDADES</p> <p>OPEL CORSA C (F08, F68) 1.7 CDTi (06.03 A 12.09) 100cv 1686cc Hatchback</p> <p>180x120x170mm 1f-d50mm 1f-155x105mm</p> |  | <p>KF2371-T NO. 1603005 - 20424726 - 26067603 - 26070498</p> <p>KIT DE FOLE DO CARDAN JUNTO À RODA</p> <p>OPEL CORSA C 1.0i - 1.2i (APÓS 2000)</p> <p>d88x126mm 1f-d72mm 1f-d23mm</p> |
|  | <p>KF2527-T NO. 1603189 - 1603231</p> <p>KIT DE FOLE DO CARDAN JUNTO À RODA</p> <p>OPEL CORSA C 1.3 CDTi - 1.4i - 1.7 Di - 1.7 DTi (APÓS 2000)</p> <p>d95x130mm 1f-d78mm 1f-d23mm</p> |  | <p>M6045 NO. 854936 - 90231063</p> <p>JUNTA DE ESCAPE</p> <p>OPEL CORSA C (APÓS 2000)</p> <p>95x92mm 1f-d55mm</p> |
|  | <p>P1056 NO. 560803</p> <p>CAPA DE PEDAL DO TRAVÃO</p> <p>OPEL CORSA C 1.2 - 1.2 16V - 1.4 - 1.7 Di - 1.7 Di 16V - 1.7 DTi - 1.7 DTi 16V - 1.8 (APÓS 09-2000)</p> <p>58x54x14mm NULL</p> |  | <p>P1103 NO. 0560804 - 09191205 - 560804 - 9191205</p> <p>CAPA DE PEDAL DO TRAVÃO</p> <p>OPEL CORSA C (F08_ F68) 1.0 (09.00 A 06.03) 58cv 973cc Hatchback - OPEL CORSA C (F08, F68) 1.0 (06.03 A 12.09) 60cv 998cc Hatchback - OPEL CORSA C (F08, F68) 1.2 (09.00 A 12.09) 75cv 1199cc Hatchback - OPEL CORSA C (F08, F68) 1.2 Twinport (07.04 A 12.09) 80cv 1229cc Hatchback - OPEL CORSA C (F08, F68) 1.4 Twinport (06.03 A 12.09) 90cv 1364cc Hatchback - OPEL CORSA C (F08, F68) 1.4 (09.00 A 12.09) 90cv 1389cc Hatchback - OPEL CORSA C (...etc.</p> <p>110x65x45mm NULL</p> |

| | | | |
|--|--|--|---|
|  | R222750 NO. 1337572 - 9128348 TUBO SUPERIOR DO RADIADOR OPEL CORSA C 1.0 B195-d35/34mm 70-50-50-70mm |  | R222751 NO. 1336227 - 9128347 TUBO INFERIOR DO RADIADOR OPEL CORSA C 1.0 B310-d40/34mm 40-100-180-90mm+ch1080-d20mm |
|  | R222752 NO. 1337573 - 9128354 TUBO SUPERIOR DO RADIADOR OPEL CORSA C 1.2 B170-d34/34mm 110-85mm |  | R222753 NO. 1336233 - 9128353 - 6336101 TUBO INFERIOR DO RADIADOR OPEL CORSA C 1.2 B310-d40/34mm 65-50-110-90-50mm+ch1080-d20mm |
|  | R222754 NO. 1337601 TUBO SUPERIOR DO RADIADOR OPEL CORSA C 1.4 B160-d32/28mm 70-80-80-70-70mm |  | R222755 NO. 1336243 - 9128764 TUBO INFERIOR DO RADIADOR OPEL CORSA C 1.4 B470-d39/34mm 120-100-150-110-95mm |
|  | R222760 NO. 1337574 - 9128807 TUBO SUPERIOR DO RADIADOR OPEL CORSA C 1.7 D - 1.7 DTi B300-d33/37mm 70-80-90-50-85mm |  | R222761 NO. 1336245 - 9128808 TUBO INFERIOR DO RADIADOR OPEL CORSA C 1.7 DTi (APÓS 09-2000) 1.7 Di (APÓS 09-2000) B220-d32/32mm 50-70-30-30-60mm + ch-d20mm 90-140-310-330-105mm |
|  | RT08937 NO. 5562230 - 9191262 TUBO DE TRAVÃO FRENTE LH-RH OPEL CORSA C 1.0 (APÓS 09-2000) - 1.2 (APÓS 09-2000) - 1.2 16V (APÓS 09-2000) - 1.3 CDTi (APÓS 06-2003) - 1.4 (APÓS 09-2000) - 1.7 CDTi (APÓS 06-2003) - 1.7 Di (APÓS 09-2000) - 1.7 DTi (APÓS 09-2000) - 1.7 DTi 16V (APÓS 09-2000) 320mm F8 - OR29 |  | RT08938 NO. 562302 - 9191263 TUBO DE TRAVÃO TRÁS LH OPEL CORSA C (APÓS 2000) 220mm F8 - F8 |
|  | S1441 NO. 13138151-24430103 - 352310 - 352320 SILENT-BLOC DO BRAÇO DA SUSPENSÃO DA FRENTE OPEL CORSA C 1.0 - 1.2 - 1.4 - 1.7D - 1.7DTi - 1.8 d60x45mm c27mm 1f-d12.6mm |  | S1595 NO. 50511650 - 50521486 - 51783056 - 51783057 SILENT-BLOC BRAÇO SUPERIOR FRENTE OPEL CORSA C Caixa (F08, W5L) 1.2 (A Partir de 07.05) 80cv 1229cc Caixa d53x67mm d41mm 1f-d14mm |
|  | T1019 NO. 350104 BATENTE DA BARRA ESTABILIZADORA FRENTE OPEL CORSA C 1.0 - 1.2 (APÓS 2000) (BARRA 15mm) 40x37x35mm 1f-d15mm |  | W5054 NO. 5614438 - 614150 - 93177317 - 93194443 - 0614150 POLIE DA CAMBOTA (6 PISTAS) OPEL CORSA C 1.3 CDTi - Mtr Z13DT (70CV) (APÓS 06-2003) d165mm d35mm |
|  | W5080 NO. 5614441 - 97353964 POLIE DA CAMBOTA (6 PISTAS) OPEL CORSA C 1.7CDTi Motor Z17DHT (APÓS 06-2003) - 1.7Di Motor Y17DTL (APÓS 09-2000) d152mm d48mm |  | W5082 NO. 5614444 POLIE DA CAMBOTA (6 PISTAS) OPEL CORSA C 1.7 Di - 1.7 DTi (APÓS 09-2000) d139/141mm d48mm |

| | | | | |
|--|-----------------------------|---------------------------------|--|--|
|  | W5107 | NO. 5614425 - 5614431 - 9129209 | | |
| | POLIE DA CAMBOTA (5 PISTAS) | | | |
| OPEL CORSA C 1.4 Z 14 XE 90CV (APÓS 09-2000) - 1.8 Z 18 XE 125CV (APÓS 09-2000) | | | | |
| NULL | | d160m 1f-d26mm | | |



OPEL CORSA D - ADAM

| | | | | | | |
|--|-------------------------------------|---|---|------------------------------------|--|--|
|  | C0233 | NO. 1160724 - 90054143 |  | C0233 | NO. 1160724 - 90054143 | |
| | BOTÃO AFINAÇÃO CAPÔT | | | BOTÃO AFINAÇÃO CAPÔT | | |
| OPEL ADAM 1.2 (A Partir de 10.12) 69cv 1229cc Hatchback - OPEL ADAM 1.4 (A Partir de 10.12) 87cv 1398cc Hatchback - OPEL ADAM 1.4 LPG (A Partir de 07.13) 87cv 1398cc Hatchback - OPEL ADAM 1.4 (A Partir de 10.12) 101cv 1398cc Hatchback | | | OPEL CORSA D 1.0 (A Partir de 07.06) 60cv 998cc Hatchback - OPEL CORSA D 1.0 (A Partir de 01.10) 65cv 998cc Hatchback - OPEL CORSA D 1.2 (A Partir de 06.10) 69cv 1229cc Hatchback - OPEL CORSA D 1.2 (A Partir de 07.06) 80cv 1229cc Hatchback - OPEL CORSA D 1.2 LPG (A Partir de 09.09) 80cv 1229cc Hatchback - OPEL CORSA D 1.2 LPG (A Partir de 06.11) 83cv 1229cc Hatchback - OPEL CORSA D 1.2 (A Partir de 06.10) 86cv 1229cc Hatchback - OPE...etc. | | | |
| d19x31mm | | NULL | d19x31mm | | NULL | |
|  | KT0506 | NO. 55701429 |  | Q2009 | NO. | |
| | KIT DE BATENTE SUSPENSÃO DA FRENTE | | | UNIÃO DE ESCAPE 48/45x80mm | | |
| OPEL CORSA D 1.0 (APÓS 07.06) 60cv 998cc Hatchback - OPEL CORSA D 1.0 (APÓS 01.10) 65cv 998cc Hatchback - OPEL CORSA D 1.2 (APÓS 06.10) 69cv 1229cc Hatchback - OPEL CORSA D 1.2 (APÓS 07.06) 80cv 1229cc Hatchback - OPEL CORSA D 1.2 LPG (APÓS 09.09) 80cv 1229cc Hatchback - OPEL CORSA D 1.2 LPG (APÓS 06.11) 83cv 1229cc Hatchback - OPEL CORSA D 1.2 (APÓS 06.10) 86cv 1229cc Hatchback - OPEL CORSA D 1.2 LPG (APÓS 08.11) 86cv 1229cc Hatchback...etc. | | | OPEL - CORSA D - 1.4 (APÓS 07.06) 90cv 1364cc Hatchback - OPEL - CORSA D - 1.4 LPG (APÓS 07.06) 90cv 1364cc Hatchback - OPEL - CORSA D - 1.4 (APÓS 09.09) 87cv 1398cc Hatchback - OPEL - CORSA D - 1.4 (APÓS 06.10) 100cv 1398cc Hatchback | | | |
| d62x285mm | | 1f-d13mm 1f-d60mm | 80x77x55mm | | 1f-d45/48mm | |
|  | Q2010 | NO. |  | RT80580 | NO. 5562250 | |
| | UNIÃO DE ESCAPE 51/48X125MM | | | TUBO DE TRAVÃO TRÁS RH | | |
| OPEL - CORSA D - 1.3 CDTi (APÓS 07.06) 75cv 1248cc - OPEL - CORSA D - 1.3 CDTi (APÓS 07.06) 90cv 1248cc - OPEL - CORSA D - 1.3 CDTi (APÓS 06.10) 95cv 1248cc | | | OPEL CORSA D 1.0 (APÓS 07-2006) - 1.2 (APÓS 07-2006) - 1.3 CDTi (APÓS 07-2006) - 1.4 (APÓS 07-2006) - 1.6 TURBO (APÓS 02-2007) - 1.7 CDTi (APÓS 07-2006) | | | |
| 125x80x60mm | | 1f-d48/51mm | 630mm | | NULL | |
|  | RT80581 | NO. 5562249 |  | RT80582 | NO. 5562248 | |
| | TUBO DE TRAVÃO TRÁS RH (COM TAMBOR) | | | TUBO DE TRAVÃO TRÁS RH (COM DISCO) | | |
| OPEL CORSA D 1.0 (motor Z 10 XEP) (APÓS 7-2006) - 1.2 (motor Z 12 XEP) (APÓS 07-2006) - 1.3 CDTi (motor Z 13 DTH) (APÓS 07-2006) - 1.3 CDTi (motor Z 13 DTJ) (APÓS 7-2006) - 1.4 (motor Z 14 XEP) (APÓS 07-2006) - 1.6 TURBO (motor Z 16 LEL) (APÓS 02-2007) - | | | OPEL CORSA D 1.0 (motor Z 10 XEP) (APÓS 7-2006) - 1.2 (motor Z 12 XEP) (APÓS 07-2006) - 1.3 CDTi (motor Z 13 DTH) (APÓS 07-2006) - 1.3 CDTi (motor Z 13 DTJ) (APÓS 7-2006) - 1.4 (motor Z 14 XEP) (APÓS 07-2006) - 1.6 TURBO (motor Z 16 LEL) (APÓS 02-2007) - | | | |
| 630mm | | NULL | 760mm | | NULL | |
|  | S1595 | NO. 50511650 - 50521486 - 51783056 - 51783057 |  | S1595 | NO. 50511650 - 50521486 - 51783056 - 51783057 | |
| | SILENT-BLOC BRAÇO SUPERIOR FRENTE | | | SILENT-BLOC BRAÇO SUPERIOR FRENTE | | |
| OPEL ADAM 1.2 (A Partir de 10.12) 69cv 1229cc Hatchback - OPEL ADAM 1.2 (A Partir de 07.13) 94cv 1242cc Hatchback - OPEL ADAM 1.4 (A Partir de 10.12) 87cv 1398cc Hatchback - OPEL ADAM 1.4 LPG (A Partir de 07.13) 87cv 1398cc Hatchback - OPEL ADAM 1.4 (A partir de 10.12) 101cv 1398cc Hatchback | | | OPEL CORSA D 1.0 (A Partir de 07.06) 60cv 998cc Hatchback - OPEL CORSA D 1.0 (A partir de 01.10) 65cv 998cc Hatchback - OPEL CORSA D 1.2 (A partir de 06.10) 69cv 1229cc Hatchback - OPEL CORSA D 1.2 (A Partir de 07.06) 80cv 1229cc Hatchback - OPEL CORSA D 1.2 LPG (A Partir de 09.09) 80cv 1229cc Hatchback - OPEL CORSA D 1.2 LPG (A Partir de 06.11) 83cv 1229cc Hatchback - OPEL CORSA D 1.2 (A Partir de 06.10) 86cv 1229cc Hatchback - OPE...etc. | | | |
| d53x67mm | | d41mm 1f-d14mm | d53x67mm | | d41mm 1f-d14mm | |
|  | T0656-I | NO. 0344651 - 344651 |  | W5054 | NO. 5614438 - 614150 - 93177317 - 93194443 - 0614150 | |
| | BATENTE SUSPENSÃO DA FRENTE | | | POLIE DA CAMBOTA (6 PISTAS) | | |
| OPEL CORSA D 1.0 (APÓS 07.06) 60cv 998cc Hatchback - OPEL CORSA D 1.0 (APÓS 01.10) 65cv 998cc Hatchback - OPEL CORSA D 1.2 (APÓS 06.10) 69cv 1229cc Hatchback - OPEL CORSA D 1.2 (APÓS 07.06) 80cv 1229cc Hatchback - OPEL CORSA D 1.2 LPG (APÓS 09.09) 80cv 1229cc Hatchback - OPEL CORSA D 1.2 LPG (APÓS 06.11) 83cv 1229cc Hatchback - OPEL CORSA D 1.2 (APÓS 06.10) 86cv 1229cc Hatchback - OPEL CORSA D 1.4 (APÓS 07.06) 90cv 1364cc Hatchback...etc. | | | OPEL CORSA D 1.3 CDTi APÓS 07-2006 - Mtr Z13DTJ - Z13DTH (75-90CV) | | | |
| d63x65mm | | 1f-d27mm 1f-d20mm | d165mm | | d35mm | |





| | | | | |
|---|-------------------------------|----------------------------------|--|--|
|  | Z80846 | NO. 90450482 - 1104881 - 1104882 | | |
| | <i>Rebite</i> OPEL CORSA D | | | |
| | d19x29mm | 1p-d8-15.2mm | | |

OPEL FRONTERA

| | | | | | |
|---|----------------|---|--|----------------|---|
|  | A1415 | NO. 8-94472-973-1 - 8-94434208-1 |  | A1422 | NO. 8-97910-967-0 |
| <i>APOIO DE MOTOR TRÁS (CAIXA DE VELOCIDADES)</i> OPEL FRONTERA 2.2 D MOTOR Y22 DTH | | | <i>APOIO DE MOTOR FRENTE ESQUERDO</i> OPEL FRONTERA 2.2 D MOTOR Y22 DTH | | |
| 158x75x55mm | | 2p-d10-23mm | 142x120x95mm | | 2p-d10-25mm |
|  | A1425 | NO. 8-97910-966-0 |  | KF1612 | NO. 301710 - 374075 |
| <i>APOIO MOTOR FRENTE DIREITO</i> OPEL FRONTERA 2.2 D MOTOR Y22 DTH | | | <i>KIT DE FOLE DO CARDAN LADO DA RODA</i> OPEL FRONTERA B 2.2i 16v (APÓS 10-1998) - 2.2i 16v WAGON - 2.2 DTi 16v - 2.2i DTi 16v WAGON - 3.2i 24V WAGON (APÓS 10-1998) | | |
| 142-120-55mm | | 2p-d10-25mm | d100x100mm | | 1f-d83mm 1f-d23mm |
|  | KF2327 | NO. 94312678 |  | KF3885 | NO. 301712 - 374082 - 97148750 - 97201314 - 0301712 - 0374082 - 0301710 - 97139981 - 301710 - 8-97139-98... |
| <i>KIT DE FOLE DO CARDAN JUNTO À RODA</i> OPEL FRONTERA A 2.0i - 2.2i 16v - 2.3 TD - 2.4i - 2.5 TDS - 2.8 TD (1992 A 1998) | | | <i>KIT DE FOLE DO CARDAN JUNTO À RODA E CAIXA</i> OPEL FRONTERA B 2.2 DTi 16v - 2.2i 16v - 3.2i (APÓS 1998) | | |
| d86x84mm | | 1f-d76mm 1f-d22mm | d100x100mm | | 1f-d83mm 1f-d25mm |
|  | M6068 | NO. 852800 - 852801 - 90215163 - 6688869 - 6745091 - 174510R030 - 90324050 - 21101206057 - 854970 - 9042... |  | RT08617 | NO. 562304 - 91142432 - 94403322 - 97134830 - 8944033223 - 4301615 - 562366 |
| <i>JUNTA DE ESCAPE</i> OPEL FRONTERA A (1992 A 1993) | | | <i>TUBO DE TRAVÃO FRENTE LH-RH</i> OPEL FRONTERA TT (APÓS 03-1991) | | |
| d71x13mm | | 1f-d56mm | 435mm | | FB43 - OR18 |
|  | RT08618 | NO. 562307 - 91142436 |  | W5034 | NO. 90466618 - 614654 |
| <i>TUBO DE TRAVÃO TRÁS LH-RH</i> OPEL FRONTERA (A) - (TODAS MOTORIZAÇÕES) (03-1992 A 10-1998) | | | <i>POLIE DA CAMBOTA (6 PISTAS)</i> OPEL FRONTERA A 2.0i SPORT - 2.2i (1992 A 1998) - FRONTERA B 2.2i - 2.2DTi (APÓS 1998) | | |
| 468mm | | FB44 - FC1 | d138mm | | d42mm |
|  | W5051 | NO. 55351711 - 5614437 - 614411 - 9128177 - 614444 - 5614415 - 912817769 - 90528648 |  | W5069 | NO. 614654 |
| <i>POLIE DA CAMBOTA (6 PISTAS)</i> OPEL FRONTERA B 2.2 DTi 16v Mtr X22DTH-Y22DT (160-120CV)(APÓS 10-1998) | | | <i>POLIE DA CAMBOTA (6 PISTAS)</i> OPEL FRONTERA A 2.0i SPORT - 2.2i (1992 A 1998) - FRONTERA B 2.2i - 2.2DTi (APÓS 1998) | | |
| d153mm | | d35mm | d140/141mm | | d42mm |

| | | | | | |
|---|--|---|---|--|--|
|  | Y3000 | NO. 854980 - 854977 - 854917 - 90128081 |  | Z9000 | NO. 854880 - 854881 - 858884 - 25501711 - 90234204 |
| | PARAFUSO MOLA DE ESCAPE OPEL FRONTERA A (1992 A 1993) | | | MOLA DE ESCAPE 42mm OPEL FRONTERA A (1992 A 1993) | |
| | 82x13mm | 1p-d10-20mm | | d18x26mm | NULL |











OPEL KADETT (A)-(B)-(C)-(D)-(E)

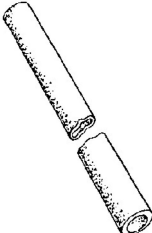
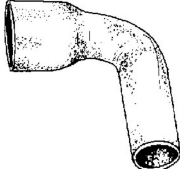
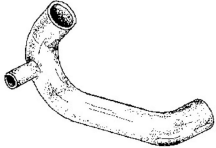
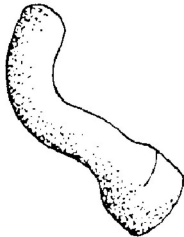

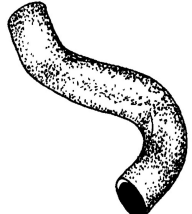

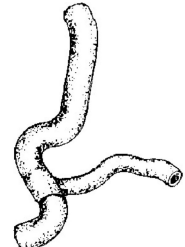

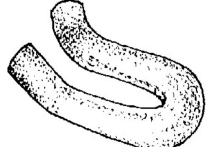



| | | | | | |
|---|--|---|--|--|---|
|  | A0100 | NO. 90135339 - 684195 |  | A0651 | NO. 684266 |
| | SUPORTE FRENTE DIREITO DO MOTOR OPEL KADETT E 1.2 - 1.3 - 1.6 (1984 A 1991) | | | SUPORTE FRENTE DO MOTOR OPEL KADETT B (1965 A 1973) | |
| | 114x91x56mm | 2p-d9-25mm 2r-d8mm | | 73x70x58mm | 1p-d10-16mm |
|  | A0652 | NO. |  | A1191 | NO. 684197 |
| | SUPORTE DA CAIXA DE VELOCIDADES OPEL KADETT B (1967 A 1970) | | | SUPORTE DIREITO DO MOTOR OPEL KADETT 1.6D (APÓS 1985) | |
| | 190x68x54mm | 1f-d14mm | | 115x90x84mm | 2f-d10mm 3r-d10mm |
|  | A1206 | NO. 682549 |  | A1206 | NO. 682549 |
| | APOIO ESQUERDO DE MOTOR TRÁS OPEL CORSA B 1.4i - 1.4i 16v (1998 A 2000) | | | APOIO ESQUERDO DE MOTOR TRÁS OPEL KADETT E 1.2 - 1.3 - 1.5TD - 1.6 - 1.6D - 1.7D - 1.8i (1984 A 1991) | |
| | 158x90x60mm | 2r-d10mm | | 158x90x60mm | 2r-d10mm |
|  | A1207 | NO. 684257 - 684289 - 684843 - 684841 - 684285 - 90216584 |  | A1216 | NO. 344517 |
| | APOIO DE MOTOR OPEL KADETT E 1.2 - 1.3 - 1.4 - 1.5 DIESEL - 1.5 TD - 1.6 - 2.1 - 1.7 TD (1984 A 1991) | | | APOIO DO AMOTECEDOR DA FRENTE OPEL KADETT (E) 1.7D (1992 A 1994) | |
| | 153x90x60mm | 2r-d10mm | | 150x130x43mm | 1f-d32mm 1f-d14mm |
|  | A1218 | NO. 344502 |  | A1392 | NO. 684291 - 6844283 - 6844282 - 684282 |
| | APOIO DO AMOTECEDOR DE TRÁS OPEL KADETT D 1.0 - D 1.2 - D 1.3 | | | APOIO DO MOTOR FRENTE DIREITO OPEL KADETT (E) 2.0i (1987 A 1991) | |
| | 135x110x40mm | 1f-d34mm | | 185x95x67mm | 2f-d11mm |
|  | A1406 | NO. 0650702 - 90233962 |  | A1461 | NO. 684267 - 684265 |
| | SUPORTE DO FILTRO DE ÓLEO OPEL KADETT | | | SUPORTE DA FRENTE MOTOR LADO DIREITO OPEL KADETT E DIESEL 1.6D - 1.7D (1984 A 1991) | |
| | d20x15mm | 1p-d6-10mm 1p-d6-15mm | | 120x100x95mm | NULL |

| | | | |
|--|---|---|--|
|  | <p>C0233 NO. 1160724 - 90054143</p> <p><i>BOTÃO AFINAÇÃO CAPÔT</i></p> <p>OPEL KADETT E Hatchback (33_34_43_44_) 1.2 (09.84 A 07.86) 55cv 1196cc Hatchback - OPEL KADETT E Hatchback (33_34_43_44_) 1.3 i Cat (09.85 A 08.91) 60cv 1297cc Hatchback - OPEL KADETT E Hatchback (33_34_43_44_) 1.3 S (09.84 A 08.87) 75cv 1297cc Hatchback - OPEL KADETT E Hatchback (33_34_43_44_) 1.4 i (01.90 A 08.91) 60cv 1389cc Hatchback - OPEL KADETT E Hatchback (33_34_43_44_) 1.4 S (01.90 A 08.91) 75cv 1389cc Hatchback -...etc.</p> <p>d19x31mm NULL</p> |  | <p>E0006 NO. 852717 - 852718</p> <p><i>SUPORTE DE ESCAPE TRÁS</i></p> <p>OPEL KADETT (APÓS 1985) - KADETT COMBO (1985 A 1990) - KADETT D (1979 A 1985) - KADETT E 1.0 - 1.2 - 1.3 - 1.6 - 1.8 - 2.0 (APÓS 1984) - KADETT DIESEL</p> <p>105x30x20mm NULL</p> |
|  | <p>E0006 NO. 852717 - 852718</p> <p><i>SUPORTE DE ESCAPE TRÁS</i></p> <p>OPEL KADETT (D) 1.2 (1979 A 1982)</p> <p>105x30x20mm NULL</p> |  | <p>E0008 NO. 856517</p> <p><i>ESTICADOR DE ESCAPE</i></p> <p>OPEL KADETT C (1973 A 1979)</p> <p>d44x40mm NULL</p> |
|  | <p>E0013 NO. 852715 - 852716 - 852720</p> <p><i>ESTICADOR DE ESCAPE</i></p> <p>OPEL KADETT E (APÓS 85) - KADETT COMBO (85 A 90)</p> <p>66x56x13mm NULL</p> |  | <p>E0016 NO. 852719</p> <p><i>SUPORTE CENTRAL E TRÁS DO ESCAPE</i></p> <p>OPEL KADETT D 1.0 - 1.2 - KADETT DIESEL 1.6 (1979 A 1984)</p> <p>105x35x33mm NULL</p> |
|  | <p>E0085 NO. 350261 - 90278577</p> <p><i>ESTICADOR DA PONTA BARCA ESTABILIZADORA DA FRENTE (BARRA DE 18MM)</i></p> <p>OPEL KADETT (E) 1.4S - 1.7D (1988 A 1994)</p> <p>110x40x35mm NULL</p> |  | <p>E0128 NO. 350263 - 90495045 - 4544599</p> <p><i>ESTICADOR DA BARRA ESTABILIZADORA DA FRENTE</i></p> <p>OPEL KADETT (E) 1.4S - 1.7D (1989 A 1993)</p> <p>105x34x34mm 1p-d12-25mm</p> |
|  | <p>E0147 NO. 350260 - 90278579 - 90278586</p> <p><i>ESTICADOR DA BARRA ESTABILIZADORA DA FRENTE</i></p> <p>OPEL KADETT (E) 1.4S - 1.7D</p> <p>100x50x35mm 1f-d21mm 1p-d8-28mm</p> |  | <p>E1003 NO. 856519</p> <p><i>SUPORTE TRÁS DO ESCAPE</i></p> <p>OPEL KADETT C)</p> <p>50x44x42mm 2f-d5mm 2f-18x9mm</p> |
|  | <p>E1071 NO. 852723 - 90352773</p> <p><i>ESTICADOR DE ESCAPE</i></p> <p>OPEL KADETT E (1985 A 1991)</p> <p>72x61x20mm NULL</p> |  | <p>F0460-I NO. 322506</p> <p><i>FOLE DA CREMALHEIRA DA DIRECÇÃO ESQ. E DIR.</i></p> <p>OPEL KADETT C (73 A 79)</p> <p>d70x190mm 1f-d22mm 1f-d40mm</p> |
|  | <p>F0465-I NO. 322501</p> <p><i>FOLE DA CREMALHEIRA DA DIRECÇÃO ESQ. E DIR.</i></p> <p>OPEL KADETT A e B (66 A 73)</p> <p>d75x160mm d52mm 1f-d40mm 1f-d33mm</p> |  | <p>F0466-I NO. 902825 - 902828 - 9105983 - 90090811</p> <p><i>FOLE DA CREMALHEIRA DA DIRECÇÃO ESQ. E DIR.</i></p> <p>OPEL KADETT D TT (APÓS 80) - KADETT E</p> <p>d78x165mm 1f-d41mm 1f-d51mm</p> |
|  | <p>F0481-I NO. 374019 - 90095087</p> <p><i>FOLE DO SEMI-EIXO EXTERNO</i></p> <p>OPEL KADETT D 1.1 - 1.3 - 1.6 - KADETT E 1.1 - 1.3 - 1.6 MANUALE (8-1979 A 1984)</p> <p>d100x80mm 1f-d20mm 1f-d75mm</p> |  | <p>F0519-I NO. 374040 - 90129014 - 90112609</p> <p><i>FOLE DO SEMI-EIXO LADO DA CAIXA DE VELOCIDADES</i></p> <p>OPEL KADETT 1.6 AUTOMATIC (APÓS 1989) - KADETT D 1.6 DIESEL (APÓS 1989)</p> <p>d88x97mm 1f-d66mm 1f-d21mm</p> |

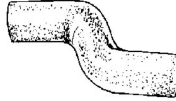



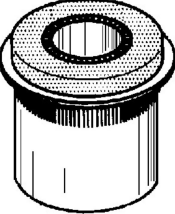
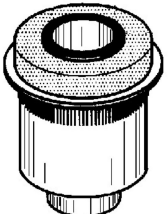
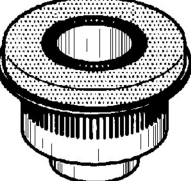
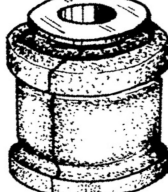
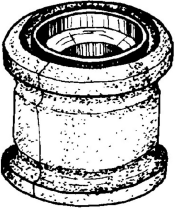





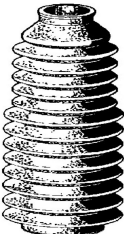
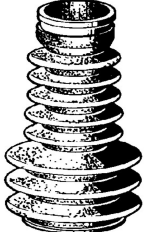
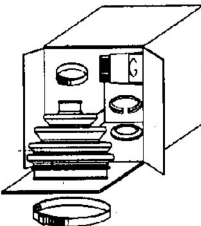

| | | | |
|---|---|--|--|
|  | <p>F0520-I NO. 90095162 - 374018</p> <p>FOLE DO SEMI-EIXO INTERNO (F1026)</p> <p>OPEL KADETT D 1.2 - 1.3 - 1.6 MANUALE (8-1979 A 1984)</p> <p>d72x94mm 1f-d54mm 1f-d19mm</p> |  | <p>F1023 NO.</p> <p>FOLE DA DIRECÇÃO</p> <p>OPEL KADETT C - 1204 - CITY</p> <p>d65x170mm 1f-d40mm 1f-d20mm</p> |
|  | <p>F1029 NO.</p> <p>FOLE DA TRANSMISSÃO</p> <p>OPEL KADETT E</p> <p>d82x50mm 1f-d28mm</p> |  | <p>F1285-I NO. 90236492</p> <p>FOLE DO SEMI-EIXO LADO DA RODA</p> <p>OPEL KADETT (D) 1.3S - 1.6S (1979 A 1984) - KADETT (E) 1.2 - 1.3i - 1.3N - 1.3S - 1.4i (1984 A 1991)</p> <p>d99x85mm 1f-d83mm 1f-d20mm</p> |
|  | <p>F1305-I NO. 1609074 - 26024585 - 0902828</p> <p>FOLE DA DIRECÇÃO ASSISTIDA LADO DIREITO E ESQUERDO</p> <p>OPEL KADETT (E) 1.3i - 1.3S - 1.3N - 1.4i - 1.4S - 1.5TD - 1.6i - 1.6D - 1.7D - 1.8i - 1.8S - 1.8E - 2.0 - 2.0GSi</p> <p>d78x170mm 1f-d54mm 1f-d42mm</p> |  | <p>F1337-I NO. 902829</p> <p>FOLE DA DIRECÇÃO ASSISTIDA (CAIXA ZF)</p> <p>OPEL KADETT (E) 1.2 - 1.3i - 1.3N - 1.4S - 1.5TD - 1.6i - 1.6D - 1.7D - 1.8i - 1.8GSi - 2.0i</p> <p>d57x425mm 2f-d51mm</p> |
|  | <p>F1373-I NO. 1603141 - 374040 - 90009020 - 90112609 - 90421756</p> <p>FOLE DA TRANSMISSÃO JUNTO À CAIXA</p> <p>OPEL KADETT D 1.5TD - 1.6 & S - 1.6D - 1.6S - 1.6i - 1.7D - 1.8GT-E - 1.8S - 1.8i - 1.8i & E - 1.8i & GSi - 2.0i - 2.0i & GSi - 2.0i GSi 16V (79 A 84)</p> <p>d87x99mm 1f-d65mm 1f-d22mm</p> |  | <p>F1373-I NO. 1603141 - 374040 - 90009020 - 90112609 - 90421756</p> <p>FOLE DA TRANSMISSÃO JUNTO À CAIXA</p> <p>OPEL KADETT E 1.5TD - 1.6i - 1.6 - 1.6D - 1.7D - 1.8i - 1.8 - 2.0i (84 A 93)</p> <p>d87x99mm 1f-d65mm 1f-d22mm</p> |
|  | <p>F1534-I NO. 7842255 - 07842255</p> <p>FOLE DA TRANSMISSÃO JUNTO À CAIXA</p> <p>OPEL KADETT D 1.3 N - 1.3 S - 1.3i - 1.4i (1979 A 1984)</p> <p>d109x126mm 1f-d91mm 1f-d23mm</p> |  | <p>F1534-I NO. 7842255 - 07842255</p> <p>FOLE DA TRANSMISSÃO JUNTO À CAIXA</p> <p>OPEL KADETT E 1.3i - 1.3 - 1.4i (1984 A 1991)</p> <p>d109x126mm 1f-d91mm 1f-d23mm</p> |
|  | <p>F4094 NO. 5738414 - 738978 - 0738978 - 90437426 - 90373314</p> <p>FOLE DE ALAVANCA DE VELOCIDADES</p> <p>OPEL KADETT E Hatchback (33_34_43_44_) 1.2 (09.84 A 07.86) 55cv 1196cc Hatchback - OPEL KADETT E Hatchback (33_34_43_44_) 1.3 N (09.84 A 08.91) 60 1297 Hatchback OPEL KADETT E Hatchback (33_34_43_44_) 1.3 i Cat (09.85 A 08.91) 60cv 1297cc Hatchback - OPEL KADETT E Hatchback (33_34_43_44_) 1.3 S (09.84 A 08.87) 75cv 1297cc Hatchback - OPEL KADETT E Hatchback (33_34_43_44_) 1.4 i (01.90 A 08.91) 60cv 1389cc Hatchback - OPEL ...etc.</p> <p>170x120x220mm 1f-160x105mm 1f-d50mm</p> |  | <p>H762 NO.</p> <p>PALA ORIGINAL</p> <p>OPEL KADETT D</p> <p>360x210mm NULL</p> |
|  | <p>H768 NO.</p> <p>PALA ORIGINAL</p> <p>OPEL KADETT E</p> <p>440x225mm NULL</p> |  | <p>KF2300 NO. 374019 - 90095087 - 6152107500002</p> <p>FOLE DO LADO DA RODA</p> <p>OPEL KADETT (D - E) - 1.0 - 1.2 - 1.3 - 1.3 AUT.</p> <p>d96x79mm 1f-d19mm 1f-d77mm</p> |
|  | <p>KF2310 NO. 374040</p> <p>FOLE DO LADO DA RODA</p> <p>OPEL KADETT D - E 1.6 - 1.8</p> <p>d90x79mm 1f-d22mm 1f-d83mm</p> |  | <p>KF2340 NO. 374050 - 90125491 - 1603179</p> <p>FOLE DO LADO DA RODA</p> <p>OPEL KADETT D - E 1.6 - 1.6 AUT. 1.8 - 2.0</p> <p>d103x78mm 1f-d22mm 1f-d82mm</p> |

| | | | |
|--|---|---|---|
|  | <p>KF2345 NO. 374190 - 90236762</p> <p>FOLE DO LADO DA RODA</p> <p>OPEL KADETT E 1.2 - 1.3 S - 1.6</p> |  | <p>L0250 NO. 55044-H5001</p> <p>CASQUILHO DE MOLAS</p> <p>OPEL KADETT</p> |
|  | <p>L3020 NO. 856700</p> <p>CASQUILHO DE ESCAPE</p> <p>OPEL KADETT C</p> |  | <p>M6003 NO. 854952</p> <p>JUNTA DE ESCAPE</p> <p>OPEL KADETT D - KADETT (E)</p> |
|  | <p>M6004 NO. 854934</p> <p>JUNTA DE ESCAPE</p> <p>OPEL KADETT D 1.2S (1979 A 1984) - KADETT E (APÓS 1984)</p> |  | <p>M6036 NO. 854926 - 02886931 - 02886093</p> <p>JUNTA DE ESCAPE</p> <p>OPEL KADETT C (1971 A 1979) - CITY (1976 A 1979)</p> |
|  | <p>M6041 NO. 854842 - 90091769</p> <p>JUNTA DE ESCAPE</p> <p>OPEL KADETT E (1984 A 1993)</p> |  | <p>M6045 NO. 854936 - 90231063</p> <p>JUNTA DE ESCAPE</p> <p>OPEL KADETT E (1985 A 1991)</p> |
|  | <p>M6082 NO. 854955 - 854943 - 854944 - 97069287</p> <p>JUNTA DE ESCAPE</p> <p>OPEL KADETT E (1988 A 1991)</p> |  | <p>N1617 NO. 852711 - 852705</p> <p>ANEL DE ESCAPE</p> <p>OPEL KADETT B (1965 A 1973)</p> |
|  | <p>N2001 NO. 852707 - 852712</p> <p>ANEL DE ESCAPE TRÁS</p> <p>OPEL KADETT A (1962 A 1965)</p> |  | <p>N2074 NO. 856506</p> <p>ANEL DE ESCAPE</p> <p>OPEL KADETT (A) (1962 A 1965) - KADETT (B) (1965 A 1971)</p> |
|  | <p>N2335 NO. 852713</p> <p>ANEL ESCAPE</p> <p>OPEL KADETT E (1984 A 1993)</p> |  | <p>N2336 NO. 852711 - 9275338</p> <p>ANEL ESCAPE</p> <p>OPEL KADETT E (1984 A 1993)</p> |
|  | <p>N4021 NO. 852713</p> <p>ANEL DE ESCAPE</p> <p>OPEL KADETT E (1984 A 1991)</p> |  | <p>N6371 NO. 852706 - 856507</p> <p>ANEL DE ESCAPE</p> <p>OPEL KADETT A - B</p> |

| | | | |
|---|--|--|---|
|  | <p>P1081 NO. 842736</p> <p>CAPA DE PEDAL DO ACELADOR</p> <p>OPEL KADETT E HATCHBACK 1.4 S (01-1990 A 08-1991) 75CV 1389CC - OPEL KADETT E 1.4 S (01-1990 A 08-1991) 75CV 1389CC - OPEL KADETT E COMBI 1.4 S (01-1990 A 08-1991) 75CV 1389CC - OPEL KADETT E CABRIOLET 1.4 S (09-1990 A 02-1993) 75CV 1389CC - OPEL KADE</p> <p>132x53x14mm NULL</p> |  | <p>P1081 NO. 842736</p> <p>CAPA DE PEDAL DO ACELADOR</p> <p>OPEL KADETT E COMBI 1.4 S (01-1990 A 08-1991) 75CV 1389CC - OPEL KADETT E CABRIOLET 1.4 S (09-1990 A 02-1993) 75CV 1389CC - OPEL KADETT E COMBO 1.4 S (07-1989 A 08-1991) 75CV 1389CC - OPEL KADETT E COMBO 1.7 TD (07-1992 A 07-1994) 60CV 1700CC</p> <p>132x53x14mm NULL</p> |
|  | <p>R021964 NO. 1818101 - 5943091</p> <p>TUBO DE RETORNO DA ÁGUA DO AQUECIMENTO</p> <p>OPEL KADETT A 1.0 (09-1962 A 08-1965) - KADETT B 1.1 (09-1965 A 07-1971)</p> <p>B435-d14/14mm 435mm</p> |  | <p>R0705 NO. 13336855</p> <p>TUBO SUPERIOR DO RADIADOR</p> <p>OPEL KADETT C - SEDAN SPECIAL - CITY - E - L - COUPE - SR</p> <p>B180-d76/35mm 115-120mm</p> |
|  | <p>R0710 NO. 1336856 - 1336829 - 1336754</p> <p>TUBO INFERIOR DO RADIADOR</p> <p>OPEL KADETT C-SEDAN-ESPECIAL-CITY EL-COUPE-SR 73 a 79</p> <p>B235-d33/34mm 100-210-65-ch45-d14mm</p> |  | <p>R220277 NO. 1336752 - 1336855</p> <p>TUBO DE RADIADOR SUPERIOR</p> <p>OPEL KADETT B 1.1 (09-1965 A 07-1971) - KADETT C 1.0 (01-1974 A 07-1979)</p> <p>B185-d32/32mm 125-125mm</p> |
|  | <p>R220280 NO. 1818218</p> <p>TUBO DO AQUECIMENTO</p> <p>OPEL KADETT C 1.0 (01-1974 A 07-1979)</p> <p>B140-d17/16mm 50-100-55mm</p> |  | <p>R220281 NO. 1818220</p> <p>TUBO DE RETORNO DA ÁGUA DO AQUECIMENTO</p> <p>OPEL KADETT C 1.0 (01-1974 A 07-1979)</p> <p>B565-d16/18mm 115-95-210-165-115-55mm</p> |
|  | <p>R220284 NO. 1336250 - 90091138 - 1336316 - 99169012</p> <p>TUBO DE RADIADOR SUPERIOR</p> <p>OPEL KADETT D 1.3 - E 1.3</p> <p>B225-d34/34mm 120-80-115mm</p> |  | <p>R220285 NO. 1336244 - 90091137 - 1337051</p> <p>TUBO DE RADIADOR INFERIOR</p> <p>OPEL KADETT D 1.3 - E 1.3</p> <p>B430-d34/34mm 45-220-140-100mm</p> |
|  | <p>R220286 NO. 1336242 - 90088086</p> <p>TUBO DE LIGAÇÃO DO RADIADOR À BOMBA DE ÁGUA</p> <p>OPEL KADETT D 1.3 - E 1.3</p> <p>B145-d33/33mm 55-45-55mm</p> |  | <p>R220535 NO. 1336405 - 90215665</p> <p>TUBO DE RADIADOR INFERIOR COM 3 VIAS</p> <p>OPEL KADETT E DIESEL 1.6</p> <p>B480-d31/31mm 60-210-80-115-80mm + ch d18 50-30-35-70-70mm</p> |
|  | <p>R220536 NO. 1336407 - 90220143</p> <p>TUBO SUPERIOR DO RADIADOR</p> <p>OPEL KADETT E 1.2 (09-1984 A 07-1986)</p> <p>B380-34/54mm 50x70x70x240x80x80x80mm</p> |  | <p>R220538 NO. 1336426 - 90233006</p> <p>TUBO DE RADIADOR SUPERIOR</p> <p>OPEL KADETT E DIESEL 1.6</p> <p>B70-d34/34mm 70-150-200-55mm</p> |
|  | <p>R220815 NO. 1336402 - 90183050</p> <p>TUBO DE RADIADOR SUPERIOR</p> <p>OPEL KADETT E DIESEL 1.6</p> <p>B120-d34/34mm 90-60-85-70mm</p> |  | <p>R220822 NO. 1337002 - 90348446</p> <p>TUBO DE RADIADOR INFERIOR</p> <p>OPEL KADETT E DIESEL 1.7</p> <p>B485-d40/40mm 80-125-60-210-60mm</p> |

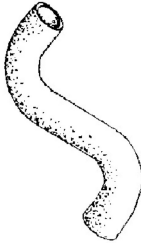
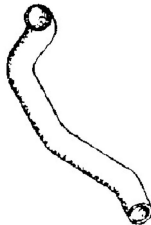
| | | | |
|--|---|---|--|
|  | R220823 NO. 1337009 - 90325853 TUBO DE RADIADOR SUPERIOR DE ENTRADA DE ÁGUA OPEL KADETT E DIESEL 1.7 B135-d34mm 50-140-50-40 |  | R221420 NO. 1337106 - 90421900 TUBO SUPERIOR DE ENTRADA DE ÁGUA DO RADIADOR OPEL KADETT (E) 1.7D (07-1992 A 07-1994) B135-d34mm 100-120-70mm |
|  | R221421 NO. 1337111 - 90421905 TUBO INFERIOR DE SAÍDA DE ÁGUA DO RADIADOR OPEL KADETT (E) 1.7D (07-1992 A 07-1994) B480-d38/34mm 70-135-255-70mm |  | R221422 NO. 1818159 TUBO DE ENTRADA DE ÁGUA DE AQUECIMENTO OPEL KADETT (E) 1.7D (07-1992 A 07-1994) B450-d20/14mm 45-50-135-225-85-135-55mm |
|  | R221423 NO. 1818202 TUBO RETORNO DE ÁGUA DE AQUECIMENTO OPEL KADETT (E) 1.7D (07-1992 A 07-1994) B340-d20/15mm 55-55-5550-80-60-90-75mm |  | R2475 NO. 13362687 - 90128022 TUBO INFERIOR DO RADIADOR OPEL KADETT E 1600-1800-2000-1600D-1800D-ASCONA-C-1600-180 OE B180-d35/32mm 65-65-65mm |
|  | R8078 NO. 1336328 - 1337393 - 90570033 TUBO DE LIGAÇÃO À BOMBA DE ÁGUA OPEL KADETT 2.0 16v B171-d40/34mm d27mm 45-90-45mm 85-80mm |  | R8079 NO. 1336509 - 1337465 - 90351806 - 90530799 TUBO DE LIGAÇÃO AO TERMOSTATO OPEL KADETT D 2.0 i B220-d20/20mm 80-70-60-70-60mm |
|  | R8080 NO. 1336294 - 1337395 - 90128078 - 90166058 - 90570030 - 90916-01013 - 2101-1303090 TUBO DO RADIADOR À BOMBA DE ÁGUA OPEL KADETT D 1.6D (03-1982 A 08-1984) - KADETT E 1.5TD - 1.6D - 1.7D B140-d34/34mm 85-75mm |  | RT08545 NO. 562345 - 562350 - 562358 - 90235568 - 90374106 - 90468316 - 90468319 TUBO DE TRAVÃO FRENTE RH OPEL KADETT E TT (08-1985 A 09-1991) 310mm FB3/1 - OR1 |
|  | S0190 NO. SILENT-BLOC DE VAUS DE SUSPENSÃO OPEL KADETT B d32x28mm d30mm 1f-d15mm |  | S0191 NO. SILENT-BLOC DE VAUS DE SUSPENSÃO OPEL KADETT B d32x41mm d28mm 1f-d12mm |
|  | S1023 NO. SILENT-BLOC DE VAUS SUSPENSÃO INFERIOR OPEL KADETT d36x33mm d28mm 1f-d13mm |  | S1074 NO. 352334 - 352349 - 90235042 - 90335966 - 96335966 SILENT-BLOC FRENTE DO BRAÇO DA SUSPENSÃO FRENTE C/ CASQUILHO OPEL KADETT D 1.0 - 1.2 - 1.3 - 1.6 - 1.8 - 2.0 - KADETT E 1.0 - 1.2 - 1.3 - 1.6 - 1.8 - 2.0 d44x59mm d38mm 1fd-14mm |
|  | S1075 NO. 90217845 SILENT-BLOC DO BRAÇO DA SUSPENSÃO OPEL KADETT S- CASQUILHO d45x49mm d39mm 1f-d18mm |  | S1080 NO. SILENT-BLOC DE VAUS DE SUSPENSÃO OPEL KADETT C d39x41mm c29mm d30mm 1f-d12mm |

| | | | |
|---|---|--|--|
|  | <p>S1127 NO. 352300 - 352346</p> <p>SILENT-BLOC DO BRAÇO DA SUSPENSÃO FRENTE DIAM. 12mm OPEL KADETT (E) 1.4S - 1.7D</p> <p>d43x60mm d38mm 1f-d12mm</p> |  | <p>S1128 NO. 352347 - 352348</p> <p>SILENT-BLOC EXTERIOR DO BRAÇO DA SUSPENSÃO FRENTE DIAM. 16mm OPEL KADETT (E) 1.4S - 1.7D</p> <p>d68x58mm d60mm 1f-d16mm</p> |
|  | <p>S1198 NO. 352335 - 352345 - 90235040</p> <p>SILENT-BLOC DA SUSPENSÃO</p> <p>OPEL KADETT E 1.2 - 1.3 - 1.5TD - 1.6D - 1.7D - 1.8 (1984 A 1991)</p> <p>65x55x55mm 1f-d21mm 1f-d6mm</p> |  | <p>S1275 NO. 402642 - 90189050</p> <p>SILENT-BLOC DA SUSPENSÃO DE TRÁS</p> <p>OPEL KADETT E 1.2 - 1.4S - 1.7D</p> <p>d56x75mm c63mm d47mm</p> |
|  | <p>T0001-E NO. 856516 - 856521</p> <p>BATENTE DE ESCAPE</p> <p>OPEL KADETT C 1.0 (01-1974 A 07-1979) - KADETT E 1.2 - 1.3 - 1.4 - 1.5TD - 1.6 - 1.6D - 1.7D - 1.8 - 2.0</p> <p>NULL NULL</p> |  | <p>W5069 NO. 614654</p> <p>POLIE DA CAMBOTA (6 PISTAS)</p> <p>OPEL SINTRA 2.2i 16v MOTOR X22XE (11-1996 A 04-1999)</p> <p>d140/141mm d42mm</p> |
|  | <p>Y3000 NO. 854980 - 854977 - 854917 - 90128081</p> <p>PARAFUSO MOLA DE ESCAPE</p> <p>OPEL KADETT E (1984 A 1993)</p> <p>82x13mm 1p-d10-20mm</p> |  | <p>Y3004 NO. 854982 - 90128082</p> <p>PARAFUSO ESCAPE</p> <p>OPEL KADETT E (1984 A 1991)</p> <p>d19x65mm d12mm 1r-d10mm</p> |
|  | <p>Z80458 NO.</p> <p>Mola de painel</p> <p>OPEL KADETT (E)</p> <p>d14x10mm 1p-d9-5mm</p> |  | <p>Z80477 NO. 174833</p> <p>Mola de friso</p> <p>OPEL KADETT (E) (Após 1979)</p> <p>39x34.5x7mm NULL</p> |
|  | <p>Z80540 NO. 90022049 - 2240861</p> <p>Mola de painel</p> <p>OPEL KADETT (E)</p> <p>d12x14.3mm 1p-d7-12.3mm</p> |  | <p>Z80655 NO. 2346824 - 2338955 - 90431553 - 90283614 - 2338961 - 8964.81 - 8964.57</p> <p>Mola de painel</p> <p>OPEL KADETT (E)</p> <p>d14x17.5mm 1p-d8-15.5mm</p> |
|  | <p>Z80661 NO. 1218601</p> <p>Mola de fixação</p> <p>OPEL KADETT (E)</p> <p>27.5x22x20mm NULL</p> |  | <p>Z9000 NO. 854880 - 854881 - 858884 - 25501711 - 90234204</p> <p>MOLA DE ESCAPE 42mm</p> <p>OPEL KADETT E (1984 A 1991) - KADETT D (1979 A 1984)</p> <p>d18x26mm NULL</p> |

| | | | |
|--|---|---|--|
|  | <p>E0008 NO. 856517</p> <p>ESTICADOR DE ESCAPE</p> <p>OPEL MANTA B (1965 A 1973) - MANTA C (1973 A 1979)</p> <p>d44x40mm NULL</p> |  | <p>F0460-I NO. 322506</p> <p>FOLE DA CREMALHEIRA DA DIREÇÃO ESQ. E DIR.</p> <p>OPEL MANTA B (66 A 73)</p> <p>d70x190mm 1f-d22mm 1f-d40mm</p> |
|  | <p>F0465-I NO. 322501</p> <p>FOLE DA CREMALHEIRA DA DIREÇÃO ESQ. E DIR.</p> <p>OPEL MANTA A (63 A 66)</p> <p>d75x160mm d52mm 1f-d40mm 1f-d33mm</p> |  | <p>KF2300 NO. 374019 - 90095087 - 6152107500002</p> <p>FOLE DO LADO DA RODA</p> <p>OPEL MANTA B (1975 A 1988)</p> <p>d96x79mm 1f-d19mm 1f-d77mm</p> |
|  | <p>M6036 NO. 854926 - 02886931 - 02886093</p> <p>JUNTA DE ESCAPE</p> <p>OPEL MANTA A - B (1978 A 1983)</p> <p>96x60mm 2f-d36mm</p> |  | <p>M6041 NO. 854929 - 90091769</p> <p>JUNTA DE ESCAPE</p> <p>OPEL MANTA (1978 A 1987)</p> <p>142x68mm 2f-d50mm</p> |
|  | <p>N2001 NO. 852707 - 852712</p> <p>ANEL DE ESCAPE TRÁS</p> <p>OPEL MANTA A 1.2 (04-1972 A 08-1975)</p> <p>d70x14mm 1f-d46mm</p> |  | <p>N2335 NO. 852713</p> <p>ANEL ESCAPE</p> <p>OPEL MANTA CC (1975 A 1989) - MANTA B (1975 A 1990)</p> <p>d65x15mm 1f-d36mm</p> |
|  | <p>N2336 NO. 852711 - 9275338</p> <p>ANEL ESCAPE</p> <p>OPEL MANTA CC (1975 A 1989) - MANTA B (1975 A 1990)</p> <p>d62x14mm 1f-d36mm</p> |  | <p>N4021 NO. 852713</p> <p>ANEL DE ESCAPE</p> <p>OPEL MANTA A 1.2 (04-1972 A 08-1975) - MANTA B 1.2 (08-1976 A 07-1983)</p> <p>d60x14mm 1f-d33mm</p> |
|  | <p>N6371 NO. 852706 - 856507</p> <p>ANEL DE ESCAPE</p> <p>OPEL MANTA A 1.2 - 1.6 - 1.9GT - 1.9E - 1.9S</p> <p>d100x9mm 1f-d82mm</p> |  | <p>R220073 NO. 1336782 - 1336791 - 1336839</p> <p>TUBO DE RADIADOR SUPERIOR</p> <p>OPEL MANTA A 1.6 - 1.9S - 1.9GT</p> <p>B340-d34/38mm 115-160-140mm</p> |
|  | <p>R220237 NO. 1336212 - 1336864</p> <p>TUBO DE RADIADOR INFERIOR</p> <p>OPEL MANTA B 1.2 - 1.6</p> <p>NULL NULL</p> |  | <p>R220254 NO. 1336783 - 1336749</p> <p>TUBO INFERIOR SAÍDA ÁGUA DO RADIADOR</p> <p>OPEL MANTA A 1.6 - 1.9S - 1.9GT</p> <p>B250-d45/35mm 75-175-85mm</p> |
|  | <p>R220255 NO. 1336863 - 9281830</p> <p>TUBO DE RADIADOR SUPERIOR</p> <p>OPEL MANTA B 1.2 - 1.6N - 1.6S - 1.9E - 1.9N - 1.9S</p> <p>B360-d40/40mm 125-240-80mm</p> |  | <p>R220260 NO. 1336788</p> <p>TUBO DE RADIADOR SUPERIOR</p> <p>OPEL MANTA A 1.2 - MANTA B 1.2N - 1.2S</p> <p>B260-d34/34mm 60-150-115-75mm</p> |

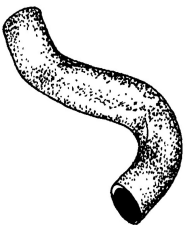
| | | | | |
|---|---------------------------|---|--|--|
|  | R220284 | NO. 1336250 - 90091138 - 1336316 - 90169012 | | |
| | TUBO DE RADIADOR SUPERIOR | | | |
| OPEL MANTA B 1.3N - 1.3S | | | | |
| B225-d34/34mm | 120-80-115mm | | | |

OPEL MERIVA

| | | | | | | |
|---|--|---|---|---|---|--|
|  | A1635 | NO. 644184 - 684183 - 93183223 |  | A1944 | NO. 5684651 - 13159993 | |
| | APOIO DO MOTOR PARTE DA FRENTE DIREITO | | | APOIO MOTOR ESQUERDO | | |
| OPEL MERIVA 1.6 - 1.6 16v - 1.8 | | | OPEL MERIVA B 1.4 (A Partir de 06.10) 100cv 1398cc Veículo multiuso - OPEL MERIVA B 1.4 (A Partir de 06.10) 120cv 1364cc Veículo multiuso - OPEL MERIVA B 1.4 LPG (A Partir de 06.11) 120cv 1364cc Veículo multiuso - OPEL MERIVA B 1.3 CDTi (A Partir de 06.10) 95cv 1248cc Veículo multiuso | | | |
| 170x110x120mm | NULL | | 165x110x70mm | 1f-d13mm 4f-d9mm 1p-8x18mm | | |
|  | C0233 | NO. 1160724 - 90054143 |  | E1092 | NO. 852726 | |
| | BOTÃO AFINAÇÃO CAPÔT | | | ESTICADOR DE ESCAPE | | |
| OPEL MERIVA 1.4 16V Twinport (07.04 A 05.10) 90cv 1364cc Veículo multiuso - OPEL MERIVA 1.4 16V Twinport LPG (07.04 A 05.10) 90cv 1364cc Veículo multiuso - OPEL MERIVA 1.6 (05.03 A 05.10) 87cv 1598cc Veículo multiuso - OPEL MERIVA 1.6 16V (05.03 A 01.06) 100cv 1598cc Veículo multiuso - OPEL MERIVA 1.6 (01.06 A 05.10) 105cv 1598cc Veículo multiuso - OPEL MERIVA 1.6 Turbo (09.05 A 05.10) 180cv 1598cc Veículo multiuso - OPEL MERIVA...etc. | | | OPEL MERIVA (TODAS MOTORIZAÇÕES) | | | |
| d19x31mm | NULL | | 55x40x35mm | NULL | | |
|  | F1842-I | NO. 1603250 - 4707435 - 1142813 - 2S61-4A084-BA - 44315-SA7-981 - C602-22-530 - C602-22-540 - 39741-AY12... |  | F4093 | NO. 0738423 - 738423 - 9200970 - 09200970 | |
| | FOLE DA TRANSMISSÃO JUNTO À CAIXA | | | FOLE DE ALAVANCA DE VELOCIDADES | | |
| OPEL MERIVA 1.6i - 1.6i 16V - 1.8i 16V (APÓS 2003) | | | OPEL MERIVA 1.4 16V Twinport (07.04 A 05.10) 90cv 1364cc Veículo multiuso - OPEL MERIVA 1.4 16V Twinport LPG (07.04 A 05.10) 90cv 1364cc Veículo multiuso - OPEL MERIVA 1.6 (05.03 A 05.10) 87cv 1598cc Veículo multiuso - OPEL MERIVA 1.6 16V (05.03 A 01.06) 100cv 1598cc Veículo multiuso - OPEL MERIVA 1.6 (01.06 A 05.10) 105cv 1598cc Veículo multiuso - OPEL MERIVA 1.6 Turbo (09.05 A 05.10) 180cv 1598cc Veículo multiuso - OPEL MERIVA...etc. | | | |
| d82x87mm | 1f-d75mm 1f-d20mm | | 160x110x170mm | 1f-d50mm | | |
|  | F4098 | NO. 93181112 - 5738416 |  | KF2271-T | NO. 1603259 - 374434 | |
| | FOLE ALAVANCA VELOCIDADES | | | KIT DE FOLE DO CARDAN JUNTO À RODA | | |
| OPEL MERIVA 1.4 16V Twinport (07.04 A 05.10) 90cv 1364cc Veículo multiuso - OPEL MERIVA 1.4 16V Twinport LPG (07.04 A 05.10) 90cv 1364cc Veículo multiuso - OPEL MERIVA 1.6 (05.03 A 05.10) 87cv 1598cc Veículo multiuso - OPEL MERIVA 1.6 16V (05.03 A 01.06) 100cv 1598cc Veículo multiuso - OPEL MERIVA 1.6 (01.06 A 05.10) 105cv 1598cc Veículo multiuso - OPEL MERIVA 1.6 Turbo (09.05 A 05.10) 180cv 1598cc Veículo multiuso - OPEL MERIVA...etc. | | | OPEL MERIVA 1.7 CDTi 16v - 1.7 DTi (APÓS 2003) | | | |
| 180x120x170mm | 1f-d50mm 1f-155x105mm | | d105x125mm | 1f-d83mm 1f-d25mm | | |
|  | P1103 | NO. 0560804 - 09191205 - 560804 - 9191205 |  | RT80582 | NO. 5562248 | |
| | CAPA DE PEDAL DO TRAVÃO | | | TUBO DE TRAVÃO TRÁS RH (COM DISCO) | | |
| OPEL MERIVA 1.4 16V Twinport (07.04 A 05.10) 90cv 1364cc Veículo multiuso - OPEL MERIVA 1.4 16V Twinport LPG (07.04 A 05.10) 90cv 1364cc Veículo multiuso - OPEL MERIVA 1.6 (05.03 A 05.10) 87cv 1598cc Veículo multiuso - OPEL MERIVA 1.6 16V (05.03 A 01.06) 100cv 1598cc Veículo multiuso - OPEL MERIVA 1.6 (01.06 A 05.10) 105cv 1598cc Veículo multiuso - OPEL MERIVA 1.6 Turbo (09.05 A 05.10) 180cv 1598cc Veículo multiuso - OPEL MERIVA...etc. | | | OPEL MERIVA 1.3 CDTi (motor Z 13 DT) (APÓS 04-2005) - 1.3 CDTi (motor Z 13 DTJ) (APÓS 09-2003) - 1.4 16V TWINPORT (motor Z 14 XEP) (APÓS 07-2004) - 1.6 (motor Z 16 SE) (APÓS 05-2003) - 1.6 (motor Z 16 XEP) (APÓS 01-2006) - 1.6 16V (motor Z 16 XE) (APÓS 05 | | | |
| 110x65x45mm | NULL | | 760mm | NULL | | |
|  | RT80583 | NO. 5562247 |  | S1441 | NO. 13138151-24430103 - 352310 - 352320 | |
| | TUBO DE TRAVÃO TRÁS LH (COM DISCO) | | | SILENT-BLOC DO BRAÇO DA SUSPENSÃO DA FRENTE | | |
| OPEL MERIVA 1.3 CDTi (motor Z 13 DT) (APÓS 04-2005) - 1.3 CDTi (motor Z 13 DTJ) (APÓS 09-2003) - 1.4 16V TWINPORT (motor Z 14 XEP) (APÓS 07-2004) - 1.6 (motor Z 16 SE) (APÓS 05-2003) - 1.6 (motor Z 16 XEP) (APÓS 01-2006) - 1.6 16V (motor Z 16 XE) (APÓS 05 | | | OPEL MERIVA 1.4 16v - 1.6 - 1.616v - 1.7 16v CDTi - 1.7 16v DTi - 1.8 16v | | | |
| 760mm | NULL | | d60x45mm | c27mm 1f-d12.6mm | | |

| | | | | | |
|--|---|--|--|--|---------------------------------|
|  | W5054 | NO. 5614438 - 614150 - 93177317 - 93194443 - 0614150 |  | W5080 | NO. 5614441 - 97353964 |
| | POLIE DA CAMBOTA (6 PISTAS) OPEL MERIVA 1.3 CDTi Mtr Z13DTJ (75CV) (APÓS 09-2003) | | | POLIE DA CAMBOTA (6 PISTAS) OPEL MERIVA 1.7 CDTi Motor Z17DTH (APÓS 09-2003) | |
| | d165mm | d35mm | | d152mm | d48mm |
|  | W5082 | NO. 5614444 |  | W5107 | NO. 5614425 - 5614431 - 9129209 |
| | POLIE DA CAMBOTA (6 PISTAS) OPEL MERIVA 1.7 Dti Motor Y17DT - 1.7 CDTi Motor Z17DTH (APÓS 05-2003) | | | POLIE DA CAMBOTA (5 PISTAS) OPEL MERIVA 1.6 16V Z 16 XE 100CV (05-2003 A 05-2010) | |
| | d139/141mm | d48mm | | NULL | d160m 1f-d26mm |

OPEL MIDI

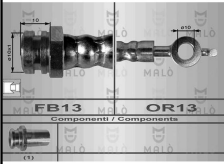







| | | | | |
|---|---|------------------------|--|--|
|  | RT08697 | NO. 94113583 - 4293901 | | |
| | TUBO DE TRAVÃO FRENTE LH-RH OPEL MIDI TT APÓS 1988 | | | |
| | 545mm | FB13 - OR13 | | |

OPEL MONTEREY

| | | | | | |
|--|---|---|--|---|---|
|  | E1054 | NO. 852725 - 97023183 |  | E1076 | NO. 856024 |
| | ESTICADOR DE ESCAPE OPEL MONTEREY (1992 A 1995) | | | ESTICADOR ESCAPE OPEL MONTEREY (1992 A 1995) | |
| | 56x56x29mm | 2f-d9mm | | 60x60x35mm | NULL |
|  | E1117 | NO. 2065100QAB |  | KF3885 | NO. 301712 - 374082 - 97148750 - 97201314 - 0301712 - 0374082 - 0301710 - 97139981 - 301710 - 8-97139-98... |
| | ESTICADOR DO ESCAPE OPEL MONTEREY A (UBS_) 3.2 (UBS25_) (06.92 A 07.98) 177cv 3165cc Veículo todo-terreno fechado - OPEL MONTEREY A (UBS_) 3.1 TD (UBS69_) (09.91 A 07.98) 114cv 3059cc Veículo todo-terreno fechado | | | KIT DE FOLE DO CARDAN JUNTO À RODA E CAIXA OPEL MONTEREY B 3.0 DTi - 3.5i V6 24V (1998 A 1999) | |
| | 68x40x38mm | 2f-d12mm | | d100x100mm | 1f-d83mm 1f-d25mm |
|  | M6082 | NO. 854955 - 854943 - 854944 - 97069287 |  | M6100 | NO. 852803 - 94328352 |
| | JUNTA DE ESCAPE OPEL MONTEREY (1988 A 1991) | | | JUNTA DE ESCAPE OPEL MONTEREY (1992 A 1998) | |
| | d64x5mm | 1f-d53mm | | 116x80x2mm | 1f-d65mm |

| | | | |
|--|--|-------|--|
|  | W5044 NO. 89445062311 | | |
| | POLIE DA CAMBOTA (1+1+1 PISTAS) OPEL MONTEREY 2.1 DIESEL (ORIGEM ISUZU) | | |
| | d145mm | d47mm | |

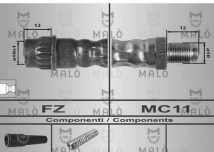
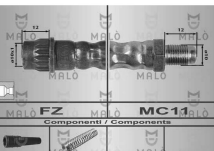
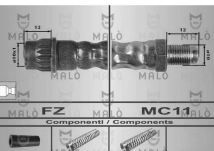







OPEL MOVANO

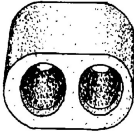



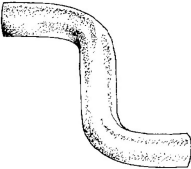
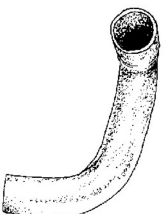
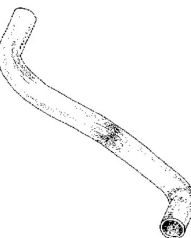
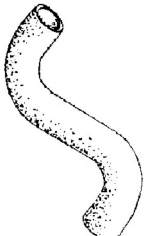
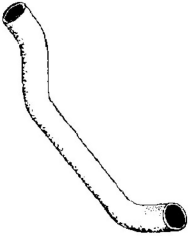
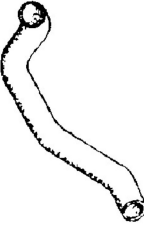
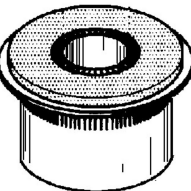

| | | | | | |
|--|---|-------------------|--|--|-------------------|
|  | E0248-M NO. 4402612 | |  | E0248-M NO. 4402612 | |
| | ESTICADOR DO MOTOR PARTE TRÁS OPEL MOVANO Combi 1.9 DTi (F9Q 770) 80CV (09-2000 A 10-2001) - 1.9 DTi (F9Q 774) 82CV (APÓS 10-2001) - 2.2 DTi (G9T 720) 90CV (APÓS 09-2000) - 2.5 CDTi (G9U 632) 120CV (APÓS 08-2006) - 2.5 CDTi (G9U 650) 101CV (APÓS 09-2007) - 2.5 CDTi (G9U 650) 146CV (A | | | ESTICADOR DO MOTOR PARTE TRÁS OPEL MOVANO Ribaltabile 2.2 DTi (G9T 720) 90CV (APÓS 09-2000) - 2.5 CDTi (G9U 632) 120CV (APÓS 08-2006) - 2.5 CDTi (G9U 650) 101CV (APÓS 08-2006) - 2.5 CDTi (G9U 650) 146CV (APÓS 08-2006) - 2.5 DTi (G9U 720 - G9U 724 - G9U 754) 115CV (APÓS 10-2001) - 2.5 (G | |
| | 150x80x94mm | 2f-d12mm | | 150x80x94mm | 2f-d12mm |
|  | F1701K3I NO. 4501297 | |  | F1817-I NO. | |
| | FOLE DA TRANSMISSÃO JUNTO À CAIXA OPEL MOVANO 1.9 DTi - 2.2 DTi - 2.5 DTi (APÓS 1998) | | | FOLE DA TRANSMISSÃO JUNTO À CAIXA OPEL MOVANO 2.5 - 2.8 DTi (1998 A 2001) | |
| | d85x200mm | 1f-d75mm 1f-d25mm | | d98x119mm | 1f-d81mm 1f-d26mm |
|  | KF2539-T NO. | |  | KF2590 NO. | |
| | KIT DE FOLE DO CARDAN JUNTO À RODA OPEL MOVANO 2.5D - 2.8 DTi (APÓS 1998) | | | KIT DE FOLE DO CARDAN JUNTO À RODA OPEL MOVANO 2.5D - 2.8 DTi (APÓS 1998) | |
| | d110x150mm | 1f-d98mm 1f-d30mm | | d105x150mm | 1f-d86mm 1f-d30mm |
|  | KF3395-T NO. 4403476 | |  | RT80206 NO. 5010422007 - 46201-00QAH - 4415698 | |
| | KIT DE FOLE DO CARDAN JUNTO À RODA OPEL MOVANO 1.9 DTi - 2.2 DTi - 2.5 DTi (APÓS 1998) | | | TUBO DE TRAVÃO FRENTE LH-RH OPEL MOVANO TT (APÓS 07-1998) | |
| | d120x150mm | 1f-d99mm 1f-d30mm | | 582mm | FZ - MC11 |
|  | RT80208 NO. 4500133 - 46204-00QAA - 9160433 | |  | RT80211 NO. 4403662 - 46201-00QAE - 46204-00QAE - 9111662 | |
| | TUBO DE TRAVÃO CENTRAL OPEL MOVANO TT (APÓS 07-1998) | | | TUBO DE TRAVÃO TRÁS LH-RH (COM DISCO) OPEL MOVANO TT (APÓS 07-1998) | |
| | 433mm | FZ - MC11 | | 355mm | FZ - MC11 |
|  | RT80384 NO. 4500132 - 9160432 | |  | RT80385 NO. 4500131 - 9160431 | |
| | TUBO DE TRAVÃO FRENTE LH-RH OPEL MOVANO TT (07-1998 A 08-2003) | | | TUBO DE TRAVÃO FRENTE LH-RH OPEL MOVANO TT (07-1998 A 08-2003) | |
| | 570mm | FZ - MG11 | | 615mm | FZ - MG11 |

| | | | | | |
|---|---|---|---|---|------------------------|
|  | L3020 | NO. 856700 |  | M6045 | NO. 854936 - 90231063 |
| | CASQUILHO DE ESCAPE OPEL OMEGA A (09-1982 A 03-1993) | | | JUNTA DE ESCAPE OPEL OMEGA A (1986 A 1994) | |
| | NULL | NULL | | 95x92mm | 1f-d55mm |
|  | M6068 | NO. 852800 - 852801 - 90215163 - 6688869 - 6745091 - 174510R030 - 90324050 - 21101206057 - 854970 - 9042... |  | W5034 | NO. 614654 |
| | JUNTA DE ESCAPE OPEL OMEGA A TURBO DIESEL (1986 A 1994) | | | POLIE DA CAMBOTA (6 PISTAS) OPEL OMEGA 2.0 16v CD-BVA CD | |
| | d71x13mm | 1f-d56mm | | d138mm | d42mm |
|  | W5051 | NO. 55351711 - 5614437 - 614411 - 9128177 - 614444 - 5614415 - 912817769 - 90528648 |  | W5069 | NO. 614654 |
| | POLIE DA CAMBOTA (6 PISTAS) OPEL OMEGA B 2.0 DTi (09-1997 A 09-2000 - Mtr X20DTH (101CV) - OMEGA 2.2 DTi (09-2000 A 07-2003 - Mtr Y22DTH (120CV) | | | POLIE DA CAMBOTA (6 PISTAS) OPEL OMEGA B 2.0 - 2.0 16v - 2.2 16v - 2.2 DTi 16v | |
| | d153mm | d35mm | | d140/141mm | d42mm |
|  | Y3000 | NO. 854980 - 854977 - 854917 - 90128081 |  | Z80540 | NO. 90022049 - 2240861 |
| | PARAFUSO MOLA DE ESCAPE OPEL OMEGA A (1986 A 1994) | | | Mola de painel OPEL OMEGA | |
| | 82x13mm | 1p-d10-20mm | | d12x14.3mm | 1p-d7-12.3mm |
|  | Z80661 | NO. 1218601 |  | Z80745 | NO. 51118174186 |
| | Mola de fixação OPEL OMEGA | | | Mola de fixação OPEL OMEGA | |
| | 27.5x22x20mm | NULL | | d15x44mm | 1p-d6.5-20mm |
|  | Z9000 | NO. 854880 - 854881 - 858884 - 25501711 - 90234204 | | | |
| | MOLA DE ESCAPE 42mm OPEL OMEGA A (1986 A 1992) | | | | |
| | d18x26mm | NULL | | | |

OPEL REKORD (A)-(B)-(C)-(D)-(E)

| | | | | | |
|---|---|-------------|--|---|------------------------------|
|  | A0649 | NO. 684260 |  | E0013 | NO. 852715 - 852716 - 852720 |
| | SUPORTE DO MOTOR OPEL REKORD A 1500 - 1700 | | | ESTICADOR DE ESCAPE OPEL MONZA (78 A 87) | |
| | 80x73x52mm | 1p-d10-18mm | | 66x56x13mm | NULL |

| | | | |
|---|--|---|---|
|  | E0013 NO. 852715 - 852716 - 852720 ESTICADOR DE ESCAPE OPEL REKORD E 1.7 - 1.8 - 1.9 - 2.0 - 2.0S - 2.2E 66x56x13mm NULL |  | E0048 NO. 852506 ESTICADOR DE ESCAPE OPEL SENATOR 59x40x28mm 2f-d14mm |
|  | M6045 NO. 854936 - 90231063 JUNTA DE ESCAPE OPEL SENATOR (1987 A 1993) 95x92mm 1f-d55mm |  | N1617 NO. 852711 - 852705 ANEL DE ESCAPE OPEL REKORD A 1500 (02-1963 A 12-1965) - REKORD B 1.5 (08-1965 A 08-1966) - REKORD C 1.5 - 1.7 - 1.9 - 2.2 (1966 A 1971) - REKORD D 1.7 - 1.9 - 2.0 - 2 - 0D - 2.1D - REKORD E 1.7 - (09-1977 A 10-1982) d65x13mm 1f-d40mm |
|  | N2001 NO. 852707 - 852712 ANEL DE ESCAPE TRÁS OPEL REKORD A 1500 - 1700 (06-1963 A 12-1965) - REKORD B 1.5 - 1.7 - 1.9 (08-1965 A 12-1966) - REKORD C 1.5 - 1.7 - 1.7S - 1.9 - 2-2 - REKORD D 1.7 - 1.7S - 1.9 - 1.9S - 2.0 - 2.0D - 2.1D d70x14mm 1f-d46mm |  | N2074 NO. 856506 ANEL DE ESCAPE OPEL REKORD (A) (1963 A 1965) - REKORD (B) (1965 A 1967) - REKORD (D) (1972 A 1973) d54x10mm 1f-d34mm |
|  | N6371 NO. 852706 - 856507 ANEL DE ESCAPE OPEL REKORD E 1.7 - 1.8 - 1.9 - 2.0 - 2.0S - 2.2E (1977 A 1986) - REKORD A 1500 - 1700 (02-1963 A 12-1965) - REKORD B 1.5 - 1.7 - 1.9 (08-1965 A 12-1966) - REKORD C 1.5 - 1.7 - 1.9 - 2.2 (1966 A 1971) - REKORD D 1.7 - 1.9 - 2.0 - 2.0D - 2.1D d100x9mm 1f-d82mm |  | R0615-M NO. 1336839 - 1336848 - 1336791 - M-220073 TUBO SUPERIOR DO RADIADOR OPEL REKORD B-D-C 1700C-1900 B290-d38/34mm 105-175-90mm |
|  | R0616M NO. 1336744 - M-220220 TUBO INFERIOR DO RADIADOR OPEL REKORD B B250-d34/46mm 100-195-115mm |  | R0709 NO. 1336180 - 1336235 - 1336437 - 1336480 - 90088720 - 902205539 - 90322663 TUBO SUPERIOR DO RADIADOR OPEL REKORD II 2100D sedan 1972-1977 - OPEL OMEGA D TD - OPEL ASCONA 2000D B480-d36/34mm 145-200-170-90mm |
|  | R220073 NO. 1336782 - 1336791 - 1336839 TUBO DE RADIADOR SUPERIOR OPEL REKORD B 1.5 - 1.7 - 1.9 (08-1965 A 12-1966) B340-d34/38mm 115-160-140mm |  | R220231 NO. 1818196 TUBO DO AQUECIMENTO OPEL REKORD D 1.7 GASOLINA (1975 A 1977) B390-d15/15mm 45-45-295-75mm |
|  | R220237 NO. 1336212 - 1336864 TUBO DE RADIADOR INFERIOR OPEL REKORD E 1.7 - 1.8 - 1.9 - 2.0 - 2.0S - 2.2E NULL NULL |  | S1029 NO. SILENT-BLOC DE VAUS DE SUSPENSÃO OPEL REKORD d44x27mm d35 1f-d15mm |
|  | T0001-E NO. 856516 - 856521 BATENTE DE ESCAPE OPEL REKORD (1982 A 1986) NULL NULL |  | Z80563 NO. 174824 Mola de friso OPEL RECKORD (E) 40x24x5.5mm NULL |

| | | | |
|--|---|--|--|
|  | <p>C0233 NO. 1160724 - 90054143</p> <p>BOTÃO AFINAÇÃO CAPÔT</p> <p>OPEL INSIGNIA 1.4 (A Partir de 04.11) 140cv 1364cc Hatchback - OPEL INSIGNIA 1.4 LPG (A Partir de 07.12) 140cv 1364cc Hatchback - OPEL INSIGNIA 1.6 (A Partir de 07.08) 116cv 1598cc Hatchback - OPEL INSIGNIA 1.6 SIDI (A Partir de 03.13) 170cv 1598cc Hatchback - OPEL INSIGNIA 1.6 Turbo (A Partir de 07.08) 180cv 1598cc Hatchback - OPEL INSIGNIA 1.8 (A Partir de 07.08) 140cv 1796cc Hatchback - OPEL INSIGNIA 2.0 Turbo (A Partir de 07.08) 2...etc.</p> <p>d19x31mm NULL</p> |  | <p>F1848-I NO. 1603238 - 1603014 - 1603183 - 374429 - 374014 - 374319 - 90543336</p> <p>FOLE DA TRANSMISSÃO JUNTO À CAIXA</p> <p>OPEL SIGNUM 1.8i 16v - 2.0 DTi 16v - 2.0i T 16v - 2.2 DTi 16v - 2.2i 16v - 3.0 CDTi V6 - 3.2i V6 (APÓS 2003)</p> <p>d95x100mm 1f-d65mm 1f-d24mm</p> |
|  | <p>KF1686-T NO. 1603232</p> <p>KIT DE FOLE DO CARDAN JUNTO À RODA</p> <p>OPEL SIGNUM 2.0iT - 2.2 DTi - 3.0 CDTi - 3.2i (APÓS 2003)</p> <p>d105x130mm 1f-d90mm 1f-d27mm</p> |  | <p>KF2362-T NO. 1603232 - 1603278 - 1603281 - 1603284 - 93182574</p> <p>KIT DE FOLE DO CARDAN JUNTO À RODA</p> <p>OPEL SIGNUM (APÓS 05-2003) 2.2 DTi</p> <p>d104x130mm 1f-d91mm 1f-d27mm</p> |
|  | <p>W5051 NO. 55351711 - 5614437 - 614411 - 9128177 - 614444 - 5614415 - 912817769 - 90528648</p> <p>POLIE DA CAMBOTA (6 PISTAS)</p> <p>OPEL SIGNUM 2.0 DTi - 2.2DTi (APÓS 04-2003) Motor X20DTH - Y22DTR (101-125CV) - SINTRA 2.2 DTi (07-1997 A 04-1999) - Mtr Y22DTH (116CV)</p> <p>d153mm d35mm</p> |  | <p>W5107 NO. 5614425 - 5614431 - 9129209</p> <p>POLIE DA CAMBOTA (5 PISTAS)</p> <p>OPEL SIGNUM 1.8 Z 18 XE 122CV (APÓS 05-2003)</p> <p>NULL d160m 1f-d26mm</p> |
|  | <p>W5145 NO. 55210310 - 0614359 - 614359 - 93192547</p> <p>POLIE DA CAMBOTA 6 PISTAS</p> <p>OPEL SIGNUM 1.9 CDTi (APÓS 04.04) 120cv 1910cc Hatchback</p> <p>d169mm d30,5mm</p> | | |

OPEL TIGRA

| | | | |
|---|--|--|--|
|  | <p>A1205 NO. 684666 - 90445300</p> <p>APOIO DE MOTOR FRENTE DIREITO</p> <p>OPEL TIGRA 1.4 - 1.6 (APÓS 1994)</p> <p>160x100x100mm 1p-d10-45mm 1r-d9mm</p> |  | <p>A1209 NO. 684661 - 684665 - 684667</p> <p>APOIO FRENTE ESQUERDO DE MOTOR</p> <p>OPEL TIGRA 1.4 - 1.6 - (APÓS 1994)</p> <p>200x90x60mm 2r-d10mm</p> |
|  | <p>A1211 NO. 90495170</p> <p>APOIO FRENTE ESQUERDO DE MOTOR</p> <p>OPEL TIGRA 1.4 - 1.6 (APÓS 1994)</p> <p>200x90x60mm 2r-d10mm</p> |  | <p>A1212 NO. 684659 - 684669</p> <p>APOIO FRENTE ESQUERDO DE MOTOR</p> <p>OPEL TIGRA 1.4 - 1.6 (APÓS 1994)</p> <p>157x90x60mm 2r-d10mm</p> |
|  | <p>A1215 NO. 684294</p> <p>APOIO DE MOTOR FRENTE DIREITO</p> <p>OPEL TIGRA 1.4 16v - 1.6 16v (APÓS 1994)</p> <p>160x95x60mm 2r-d10mm</p> |  | <p>A1943 NO. 0344523 - 344523 - 90468554</p> <p>APOIO AMORTECEDORES FRENTE</p> <p>OPEL TIGRA TwinTop 1.4 (A Partir de 06.04) 90cv 1364cc Cabriolet - OPEL TIGRA TwinTop 1.8 (A partir de 06.04) 125cv 1796cc Cabriolet - OPEL TIGRA TwinTop 1.3 CDTi (A Partir de 06.04) 69cv 1248cc Cabriolet</p> <p>d115x45mm 1f-d12mm</p> |

| | | | |
|--|---|---|---|
|  | <p>C0233 NO. 1160724 - 90054143</p> <p>BOTÃO AFINAÇÃO CAPÔT</p> <p>OPEL TIGRA (75_) 1.4 16V (07.94 A 12.00) 90cv 1389cc Coupé - OPEL TIGRA (75_) 1.6 16V (07.94 A 08.98) 106cv 1598cc Coupé - OPEL TIGRA TwinTop 1.4 (A Partir de 06.04) 90cv 1364cc Cabriolet - OPEL TIGRA TwinTop 1.8 (A Partir de 06.04) 125cv 1796cc Cabriolet - OPEL TIGRA TwinTop 1.3 CDTI (A Partir de 06.04) 69cv 1248cc Cabriolet</p> <p>d19x31mm NULL</p> |  | <p>E1031 NO. 852516</p> <p>ESTICADOR DE ESCAPE</p> <p>OPEL TIGRA 1.4 16v - 1.6 16v (APÓS 1994)</p> <p>68x44x42mm NULL</p> |
|  | <p>F1617-I NO. 1609087 - 26032286</p> <p>FOLE DE DIREÇÃO ASSISTIDA DIREITO E ESQUERDO</p> <p>OPEL TIGRA 1.4 16v - 1.6 16v (APÓS 1994)</p> <p>d62x184mm 1f-d11mm 1f-d48mm</p> |  | <p>F1830H-I NO. 1603189 - 1603231</p> <p>FOLE DA TRANSMISSÃO JUNTO À CAIXA</p> <p>OPEL TIGRA TWIN TOP 1.4i 16v (APÓS 2004)</p> <p>d90x135mm 1f-d78mm 1f-d23mm</p> |
|  | <p>F1845-I NO. 1603004 - 1603230</p> <p>FOLE DA TRANSMISSÃO LADO DA CAIXA</p> <p>OPEL TIGRA TWINTOP 1.4i 16v (APÓS 2004)</p> <p>d81x95mm 1f-d72mm 1f-d22mm</p> |  | <p>F4093 NO. 0738423 - 738423 - 9200970 - 09200970</p> <p>FOLE DE ALAVANCA DE VELOCIDADES</p> <p>OPEL TIGRA TwinTop 1.4 (A Partir de 06.04) 90cv 1364cc Cabriolet - OPEL TIGRA TwinTop 1.8 (A Partir de 06.04) 125cv 1796cc Cabriolet - OPEL TIGRA TwinTop 1.3 CDTI (A Partir de 06.04) 69cv 1248cc Cabriolet</p> <p>160x110x170mm 1f-d50mm</p> |
|  | <p>F4094 NO. 5738414 - 738978 - 0738978 - 90437426 - 90373314</p> <p>FOLE DE ALAVANCA DE VELOCIDADES</p> <p>OPEL TIGRA (75_) 1.4 16V (07.94 A 12.00) 90cv 1389cc Coupé - OPEL TIGRA (75_) 1.6 16V (07.94 A 08.98) 106cv 1598cc Coupé</p> <p>170x120x220mm 1f-160x105mm 1f-d50mm</p> |  | <p>KF2527-T NO. 1603189</p> <p>KIT DE FOLE DO CARDAN JUNTO À RODA</p> <p>OPEL TIGRA 1.4i 16v (1994 A 2000)</p> <p>d95x130mm 1f-d78mm 1f-d23mm</p> |
|  | <p>M6003 NO. 854952</p> <p>JUNTA DE ESCAPE</p> <p>OPEL TIGRA (APÓS 1994)</p> <p>d59x13.5mm 1f-d45mm</p> |  | <p>R221450 NO. 1337186 - 90444463</p> <p>TUBO SUPERIOR RADIADOR</p> <p>OPEL TIGRA 1.4 16v (1994 A 2000)</p> <p>B185-d40/34mm 120-100-80mm</p> |
|  | <p>R221451 NO. 1337193 - 90410065 - 90444477</p> <p>TUBO DE RADIADOR INFERIOR</p> <p>OPEL TIGRA 1.4 16v (1994 A 2000)</p> <p>B360-d37/33mm 125-205-65mm</p> |  | <p>R8081 NO. 1818256</p> <p>TUBO DO ARREFECIMENTO</p> <p>OPEL TIGRA 1.4 16v (1994 A 2000)</p> <p>B195-d18/18mm 75-95-75mm</p> |
|  | <p>R8084 NO. 1337190 - 90444470</p> <p>TUBO SUPERIOR DO RADIADOR</p> <p>OPEL TIGRA 1.4 16v - 1.6 16v (1994 A 2000)</p> <p>B160-d34/34mm 145-180-95mm</p> |  | <p>R8085 NO. 1337191 - 90444475</p> <p>TUBO SUPERIOR DO RADIADOR</p> <p>OPEL TIGRA 1.6 16v (COM AR CONDICIONADO) (07-1994 A 08-1998)</p> <p>B185-d32/32mm NULL</p> |
|  | <p>RT08937 NO. 5562230 - 9191262</p> <p>TUBO DE TRAVÃO FRENTE LH-RH</p> <p>OPEL TIGRA 1.3 CDTi TWIN TOP (APÓS 06-2004) - 1.4 TWIN TOP (APÓS 06-2004) - 1.8 TWIN TOP (APÓS 06-2004)</p> <p>320mm F8 - OR29</p> |  | <p>S1072 NO. 402643</p> <p>SILENT-BLOC DO ESTABILIZADOR</p> <p>OPEL TIGRA 1.4 16v - 1.6 16v (1994 A 2000)</p> <p>d52x65mm d39mm 1f-d10mm</p> |

| | | | | | |
|------------|--|---|------------|---|---------------------------------|
| | S1126 | NO. 904445097 - 352301 | | T0039 | NO. 350127 - 90447946 - 0350127 |
| | SILENT-BLOC DA SUSPENSÃO OPEL TIGRA 1.4 16v - 1.6 16v (1994 A 2000) | | | BATENTE DO CENTRO DA BARRA ESTABILIZADORA OPEL TIGRA 1.4i 16v - 1.6i 16v (1994 A 2000) | |
| d45x52mm | | d38mm 1f-d10mm | 40x37x34mm | | 1f-d21mm |
| | W5054 | NO. 5614438 - 614150 - 93177317 - 93194443 - 0614150 | | W5107 | NO. 5614425 - 5614431 - 9129209 |
| | POLIE DA CAMBOTA (6 PISTAS) OPEL TIGRA TWINTOP 1.3 CDTi Motor Z13DT (70CV) (APOS 06-2004) | | | POLIE DA CAMBOTA (5 PISTAS) OPEL TIGRA Twin Top 1.8 Z 18 XE (APÓS 06-2004) | |
| d165mm | | d35mm | NULL | | d160m 1f-d26mm |
| | Z80655 | NO. 2346824 - 2338955 - 90431553 - 90283614 - 2338961 - 8964.81 - 8964.57 | | Z80743 | NO. 2345957 |
| | Mola de painel OPEL TIGRA | | | Mola de painel OPEL TIGRA | |
| d14x17.5mm | | 1p-d8-15.5mm | d17x19mm | | 1p-d9-13mm |
| | Z9004 | NO. 856563 | | | |
| | MOLA DE ESCAPE OPEL TIGRA (APÓS 1994) | | | | |
| 25x22x5mm | | NULL | | | |

OPEL VECTRA

| | | | | | |
|-----------|--|------------------------|---------------------|---|----------------------------------|
| | A1406 | NO. 0650702 - 90233962 | | E0147 | NO. 350260 - 90278579 - 90278586 |
| | SUPORTE DO FILTRO DE ÓLEO OPEL VECTRA | | | ESTICADOR DA BARRA ESTABILIZADORA DA FRENTE OPEL VECTRA (A) TT | |
| d20x15mm | | 1p-d6-10mm 1p-d6-15mm | 100x50x35mm | | 1f-d21mm 1p-d8-28mm |
| | KF9023 | NO. 1609095 - 90512778 | | R8078 | NO. 1336328 - 1337393 - 90570033 |
| | KIT DE FOLIE DA DIREÇÃO OPEL VECTRA B Hatchback (38_) 1.6 i (10.95 A 07.03) 75cv 1598cc Hatchback - OPEL VECTRA B Hatchback (38_) 1.8 i 16V (10.95 A 09.00) 116cv 1796cc Hatchback - OPEL VECTRA B Hatchback (38_) 1.8 i 16V (09.00 A 07.03) 125cv 1796cc Hatchback - OPEL VECTRA B Hatchback (38_) 1.7 TD (10.95 A 12.98) 82cv 1686cc Hatchback - OPEL VECTRA B Hatchback (38_) 2.0 DTi 16V (06.97 A 07.03) 101cv 1995cc Hatchback - OPEL VECTRA B (36_) 1.6 i (10.95 A 04.02) 75cv...etc. | | | TUBO DE LIGAÇÃO À BOMBA DE ÁGUA OPEL VECTRA 2.0 16v | |
| d65x155mm | | 1f-d14mm 1f-d48mm | B171-d40/34mm d27mm | | 45-90-45mm 85-80mm |
| | S1472 | NO. 352358 - 90468638 | | T0644-I | NO. 90495617 - 0436933 - 436933 |
| | SILENT BLOC DO BRAÇO SA SUSPENSÃO DA FRENTE OPEL VECTRA 1.6i - 1.7TD - 1.8i 16V - 2.0i - 2.0i 16V - 2.0DTi 16V - (1995 A 2002) - STATION WAGON 1.6i - 1.8i 16V - 2.0i - 2.0i 16V - 2.0DTi 16V (1996 A 2003) | | | BATENTE SUSPENSÃO DA FRENTE OPEL VECTRA B Hatchback (38_) 1.6 i (10.95 A 07.03) 75cv 1598cc Hatchback - OPEL VECTRA B Hatchback (38_) 1.6 i 16V (10.95 A 07.02) 101cv 1598cc Hatchback - OPEL VECTRA B Hatchback (38_) 1.8 i 16V (10.95 A 09.00) 116cv 1796cc Hatchback - OPEL VECTRA B Hatchback (38_) 1.8 i 16V (09.00 A 07.03) 125cv 1796cc Hatchback - OPEL VECTRA B Hatchback (38_) 2.0 i 16V (10.95 A 09.00) 136cv 1998cc Hatchback - OPEL VECTRA B Hatchback (38_) 2.5 i V6 (10.95...etc. | |
| d61x60mm | | c42mm d48.5mm 1f-d12mm | d56x140mm | | 1f-d17mm 1f-d10mm |

| | | | | | |
|---|--------------------------------|-------------|---|---|------------|
|  | Z80661 | NO. 1218601 |  | Z9004 | NO. 856563 |
| | Mola de fixação OPEL VECTRA | | | MOLA DE ESCAPE OPEL VECTRA (APÓS 1995) | |
| | 27.5x22x20mm | NULL | | 25x22x5mm | NULL |

OPEL VECTRA A



| | | | | | |
|--|---|---------------------------------|--|---|---------------------------------|
|  | A1210 | NO. 682556 - 682601 - 684648 |  | A1213 | NO. 682566 - 682504 - 682558 |
| | APOIO TRÁS DE MOTOR OPEL VECTRA A 1.4S - 1.6 - 1.6i - 1.6i CAT - 1.6S - 1.7TD | | | APOIO TRÁS DE MOTOR OPEL VECTRA A 1.7TD - 1.8S - 2.0i - 2.0i 16v - 2.0i GT - 2.0i 16v CAT | |
| | 150x98x57mm | 2p-d10-20mm 2f-d10mm | | 150x98x57mm | 2p-d10-20mm 2f-d10mm |
|  | A1217 | NO. 344513 |  | A1219 | NO. 344514 |
| | APOIO DO AMOTECEDOR DA FRENTE OPEL VECTRA A 1.8i - 1.8S - 2.0 - 2.0i 16v 4x4 | | | APOIO DO AMOTECEDOR DA FRENTE OPEL VECTRA A 1.4S - 1.6i - 1.7D - 1.7TD - 1.8i - 1.8S - 2.0i - 2.0i 4x4 - 2.5CD - 2.5 V6 | |
| | d104x32mm | 1f-d21mm | | d113x42mm | 1f-d12mm |
|  | A1392 | NO. 684291 - 902783347 - 684282 |  | A1394 | NO. 684646 - 90372425 |
| | APOIO DO MOTOR FRENTE DIREITO OPEL VECTRA A DIESEL 1.8i - 1.8i CAT - 1.8S - 2.0i - 2.0i CAT - 2.0i GT (1988 A 1995) | | | APOIO MOTOR FRENTE DIREITO OPEL VECTRA A 2.0 - 2.0i - 2.0i CAT (1988 A 1995) | |
| | 185x95x67mm | 2f-d11mm | | 175x95x60mm | 1f-d12mm |
|  | A1553 | NO. 684644 - 90335498 |  | C0233 | NO. 1160724 - 90054143 |
| | APOIO DO MOTOR FRENTE LADO DIREITO OPEL VECTRA A (9-88 A 9-95) 1.7 TD (1988 A 1995) | | | BOTÃO AFINAÇÃO CAPÔT OPEL VECTRA A Hatchback (88_89_) 1.6 i (09.93 A 11.95) 71cv 1598cc Hatchback - OPEL VECTRA A Hatchback (88_89_) 1.6 i Cat (09.88 A 11.95) 75cv 1598cc Hatchback - OPEL VECTRA A Hatchback (88_89_) 1.6 S (09.88 A 05.93) 82cv 1598cc Hatchback - OPEL VECTRA A Hatchback (88_89_) 1.8 S (09.88 A 07.89) 88cv 1796cc Hatchback - OPEL VECTRA A Hatchback (88_89_) 1.8 i (09.88 A 10.90) 90cv 1796cc Hatchback - OPEL VECTRA A Hatchback (88_89_) 1....etc. | |
| | 180x95x80mm | NULL | | d19x31mm | NULL |
|  | E0085 | NO. 350261 - 90278577 |  | E0128 | NO. 350263 - 90495045 - 4544599 |
| | ESTICADOR DA PONTA BARCA ESTABILIZADORA DA FRENTE (BARRA DE 18MM) OPEL VECTRA (A) 1.4S - 1.6i - 1.7D - 1.7TD - 1.8i - 1.8s - 2.0i - 2.0i 16v | | | ESTICADOR DA BARRA ESTABILIZADORA DA FRENTE OPEL VECTRA A 1.4S - 1.6i - 1.7D - 1.7TD - 1.8 - 1.8S 4x4 - 2.0 - 2.0i 4x4 - 2.5CD - 2.5 V6 (1988 A 1995) | |
| | 110x40x35mm | NULL | | 105x34x34mm | 1p-d12-25mm |
|  | E1007 | NO. 852722 |  | E1071 | NO. 852723 - 90352773 |
| | SUPORTE DE ESCAPE OPEL VECTRA A 1.4S - 1.6i - 1.7D - 1.7TD - 1.8i - 1.8S - 2.0i - 2.0i 4x4 - 2.5 CD - 2.5 V6 | | | ESTICADOR DE ESCAPE OPEL VECTRA A 1.4S - 1.6i - 1.7D - 1.7TD - 1.8i - 1.8S - 2.0i - 2.0i 4x4 - 2.5CD - 2.5 V6 (1988 A 1995) | |
| | 70x47x40mm | NULL | | 72x61x20mm | NULL |

| | | | |
|---|---|--|---|
|  | <p>F0466-I NO. 902825 - 902828 - 9105983 - 90090811</p> <p>FOLE DA CREMALHEIRA DA DIRECÇÃO ESQ. E DIR.</p> <p>OPEL VECTRA A 1.4S - 1.6i - 1.7D . 1.7TD - 1.8i - 1.8S - 2.0i - 2.0i 4x4 - 2.5CD - 2.5 V6</p> <p>d78x165mm 1f-d41mm 1f-d51mm</p> |  | <p>F1285-I NO. 90236492</p> <p>FOLE DO SEMI-EIXO LADO DA RODA</p> <p>OPEL VECTRA A 1.6i (1988 A 1990)</p> <p>d99x85mm 1f-d83mm 1f-d20mm</p> |
|  | <p>F1305-I NO. 1609074 - 26024585 - 0902828</p> <p>FOLE DA DIRECÇÃO ASSISTIDA LADO DIREITO E ESQUERDO</p> <p>OPEL VECTRA A 1.6i - 1.7 D - 1.7 TD - 1.8i - 2.0i 16V - 2.5i V6 (1988 A 1995)</p> <p>d78x170mm 1f-d54mm 1f-d42mm</p> |  | <p>F1337-I NO. 902829</p> <p>FOLE DA DIRECÇÃO ASSISTIDA (CAIXA ZF)</p> <p>OPEL VECTRA (A) 1.4S - 1.6 - 1.7D . 1.7TD - 1.8i - 1.8S - 2.0</p> <p>d57x425mm 2f-d51mm</p> |
|  | <p>F1350-I NO. 1609045 - 1609073 - 90188878 - 90398968 - 9943449</p> <p>FOLE DA DIRECÇÃO ASSISTIDA LADO DIREITO E ESQUERDO</p> <p>OPEL VECTRA A 1.4 - 1.6 i - 1.7 D - 1.7 TD - 1.8 - 1.8 i - 2.0 - 2.0 i - 2.5 i (1988 A 1995)</p> <p>d74/63x125mm 1f-d50mm 1f-d38mm</p> |  | <p>F1373-I NO. 1603141 - 374040 - 90009020 - 90112609 - 90421756</p> <p>FOLE DA TRANSMISSÃO JUNTO À CAIXA</p> <p>OPEL VECTRA A 1.6i - 1.7TD - 1.8S - 1.8i - 1.8i 16V - 2.0 - 2.0i - 2.0i 16V - 2.5i V6 (88 A 95)</p> <p>d87x99mm 1f-d65mm 1f-d22mm</p> |
|  | <p>F4094 NO. 5738414 - 738978 - 0738978 - 90437426 - 90373314</p> <p>FOLE DE ALAVANCA DE VELOCIDADES</p> <p>OPEL VECTRA A Hatchback (88_ 89_) 1.4 S (04.88 A 06.92) 75cv 1389cc Hatchback - OPEL VECTRA A Hatchback (88_ 89_) 1.6 i (09.93 A 11.95) 71cv 1598cc Hatchback - OPEL VECTRA A Hatchback (88_ 89_) 1.6 i (09.93 A 11.95) 75cv 1598cc Hatchback - OPEL VECTRA A Hatchback (88_ 89_) 1.6 i Cat (09.88 A 11.95) 75cv 1598cc Hatchback - OPEL VECTRA A Hatchback (88_ 89_) 1.6 S (09.88 A 05.93) 82cv 1598cc Hatchback - OPEL VECTRA A Hatchback (88_ 89_) 1....etc.</p> <p>170x120x220mm 1f-160x105mm 1f-d50mm</p> |  | <p>KF2340 NO. 374050 - 90125491 - 1603179</p> <p>FOLE DO LADO DA RODA</p> <p>OPEL VECTRA A 1.4 - 1.6i - 1.7D - 1.8i - 2.0i - 2.5i</p> <p>d103x78mm 1f-d22mm 1f-d82mm</p> |
|  | <p>KF2345 NO. 374190 - 90236762</p> <p>FOLE DO LADO DA RODA</p> <p>OPEL VECTRA A 1.6i (1988 A 1995)</p> <p>d90x82mm 1f-d19mm 1f-d75mm</p> |  | <p>L3020 NO. 856700</p> <p>CASQUILHO DE ESCAPE</p> <p>OPEL VECTRA A 1.4S - 1.6i - 1.7D - 1.7TD - 1.8i - 1.8S - 2.0i - 2.0i 4x4 - 2.5CD - 2.5 V6 (1988 A 1995)</p> <p>NULL NULL</p> |
|  | <p>M6003 NO. 854952</p> <p>JUNTA DE ESCAPE</p> <p>OPEL VECTRA A 1.4S - 1.6i - 1.7D . 1.7TD</p> <p>d59x13.5mm 1f-d45mm</p> |  | <p>M6041 NO. 854842 - 90091769</p> <p>JUNTA DE ESCAPE</p> <p>OPEL VECTRA A 1.7D - 1.7TD</p> <p>142x68mm 2f-d50mm</p> |
|  | <p>M6045 NO. 854936 - 90231063</p> <p>JUNTA DE ESCAPE</p> <p>OPEL VECTRA A 1.7D - 1.7TD (1988 A 1995)</p> <p>95x92mm 1f-d55mm</p> |  | <p>M6060 NO. 90423152</p> <p>JUNTA DE ESCAPE</p> <p>OPEL VECTRA A (1988 A 1995)</p> <p>93x95mm 1f-d60mm</p> |
|  | <p>M6068 NO. 852800 - 852801 - 90215163 - 6688869 - 6745091 - 174510R030 - 90324050 - 21101206057 - 854970 - 9042...</p> <p>JUNTA DE ESCAPE</p> <p>OPEL VECTRA A (1998 A 1989)</p> <p>d71x13mm 1f-d56mm</p> |  | <p>M6082 NO. 854955 - 854943 - 854944 - 97069287</p> <p>JUNTA DE ESCAPE</p> <p>OPEL VECTRA A (1992 A 1995)</p> <p>d64x5mm 1f-d53mm</p> |

OPEL VECTRA A

| | | | |
|---|---|---|--|
|  | R8079 NO. 1336509 - 1337465 - 90351806 - 90530799 TUBO DE LIGAÇÃO AO TERMOSTATO OPEL VECTRA A 2.0 (04-1988 A 09-1989) |  | R8080 NO. 1336294 - 1337395 - 90128078 - 90166058 - 90570030 - 90916-01013 - 2101-1303090 TUBO DO RADIADOR À BOMBA DE ÁGUA OPEL VECTRA A 1.7D - 1.7TD (1988 A 1995) |
| B220-d20/20mm | 80-70-60-70-60mm | B140-d34/34mm | 85-75mm |
|  | S1127 NO. 352300 - 352346 SILENT-BLOC DO BRAÇO DA SUSPENSÃO FRENTE DIAM. 12mm OPEL VECTRA (A) 1.4S - 1.6 - 1.6i - 1.7TD - 1.8i - 1.8s - 2.0 - 2.0i TURBO 4x4 |  | S1128 NO. 0352317 - 0352348 SILENT-BLOC EXTERIOR DO BRAÇO DA SUSPENSÃO FRENTE DIAM. 16mm OPEL VECTRA A 1.4S - 1.6i - 1.7D - 1.7TD - 1.8i - 1.8S - 2.0i - 2.0i 4x4 |
| d43x60mm | d38mm 1f-d12mm | d68x58mm | d60mm 1f-d16mm |
|  | S1275 NO. 402642 - 90189050 SILENT-BLOC DA SUSPENSÃO DE TRÁS OPEL VECTRA A 1.4S - 1.6i - 1.7D - 1.7TD - 1.8i - 1.8S - 2.0i - 2.0i TURBO 4x4 - 2.5 V6 - 2000GT 16v (1988 A 1995) |  | T0646-I NO. 0344411 - 90279302 - 344411 BATENTE SUSPENSÃO DA FRENTE OPEL VECTRA A Hatchback (88_ - 89_) 1.4 S (04.88 A 06.92) 75cv 1389cc Hatchback - OPEL VECTRA A Hatchback (88_ - 89_) 1.6 i (09.93 A 11.95) 71cv 1598cc Hatchback - OPEL VECTRA A Hatchback (88_ - 89_) 1.6 i (09.93 A 11.95) 75cv 1598cc Hatchback - OPEL VECTRA A Hatchback (88_ - 89_) 1.6 i Cat (09.88 A 11.95) 75cv 1598cc Hatchback - OPEL VECTRA A Hatchback (88_ - 89_) 1.6 S (09.88 A 05.93) 82cv 1598cc Hatchback - OPEL VECTRA A Hatchback (88_ - ...) etc. |
| d56x75mm | c63mm d47mm | d49x67mm | 1f-d27mm 1f-d20mm |
|  | T1049F24 NO. 90447869 - 350125 BATENTE DO CENTRO DA BARRA ESTABILIZADORA OPEL VECTRA A 1.4S - 1.6i - 1.7D - 1.7TD - 1.8S - 2.0 - 2.5 V6 (1988 A 1995) |  | W5034 NO. 614654 POLIE DA CAMBOTA (6 PISTAS) OPEL VECTRA A 2.0 16v Motor C20NE - Motor X20XEV |
| 40x47x40mm | 1f-d22mm | d138mm | d42mm |
|  | Z80540 NO. 90022049 - 2240861 Mola de painel OPEL VECTRA A |  | Z9000 NO. 854880 - 854881 - 858884 - 25501711 - 90234204 MOLA DE ESCAPE 42mm OPEL VECTRA A (APÓS 1988) |
| d12x14.3mm | 1p-d7-12.3mm | d18x26mm | NULL |

OPEL VECTRA B

| | | | |
|--|--|---|--|
|  | A1629 NO. 5682507 - 90495513 APOIO DO MOTOR PARTE DE TRÁS OPEL VECTRA B 1.6i - 1.8i 16v - 1.7TD - 1.8i 16v - 2.0 Dti 16v (1992 A 2002) |  | A1645 NO. 684670 - 90496186 - 684674 - 90495447 APOIO DO MOTOR PARTE DA FRENTE DIREITO OPEL VECTRA B 1.6i - 1.8i 16v - 2.0i - 2.0i 16v (1992 A 2002) |
| 170x170x120mm | NULL | d105x120mm | 1p-d10-44mm 1p-d10-25mm |
|  | A1646 NO. 684681 - 90497967 APOIO DO MOTOR PARTE DA FRENTE ESQUERDO OPEL VECTRA B 1.6i - 1.8i 16v - 2.0i - 2.0i 16v (1992 A 2002) |  | A1943 NO. 0344523 - 344523 - 90468554 APOIO AMORTECEDORES FRENTE OPEL VECTRA B Hatchback (38_) 1.6 i (10.95 A 07.03) 75cv 1598 Hatchback - OPEL VECTRA B Hatchback (38_) 1.6 i 16V (10.95 A 07.02) 101cv 1598cc Hatchback - OPEL VECTRA B Hatchback (38_) 1.8 i 16V (10.95 A 09.00) 116cv 1796cc Hatchback - OPEL VECTRA B Hatchback (38_) 1.8 i 16V (09.00 A 07.03) 125cv 1796cc Hatchback - OPEL VECTRA B Hatchback (38_) 1.7 TD (10.95 A 12.98) 82cv 1686cc Hatchback - OPEL VECTRA B (36_) 1.6 i (10.95 A 04.02) 75cv...etc. |
| d105x135mm | 1p-d10-44mm 1p-d10-25mm | d115x45mm | 1f-d12mm |

| | | | |
|--|--|--|--|
|  | <p>C0233 NO. 1160724 - 90054143</p> <p>BOTÃO AFINAÇÃO CAPÔT</p> <p>OPEL VECTRA B Hatchback (38_) 1.6i (10.95 A 07.03) 75cv 1598cc Hatchback - OPEL VECTRA B Hatchback (38_) 1.6i 16 V (10.95 A 07.02) 101cv 1598cc Hatchback - OPEL VECTRA B Hatchback (38_) 1.8i 16 V (10.95 A 09.00) 116cv 1796cc Hatchback - OPEL VECTRA B Hatchback (38_) 1.8i 16 V (09.00 A 07.03) 125cv 1796cc Hatchback - OPEL VECTRA B Hatchback (38_) 2.0i 16 V (10.95 A 09.00) 136cv 1998cc Hatchback - OPEL VECTRA B Hatchback (38_) ...etc.</p> <p>d19x31mm NULL</p> |  | <p>E0129 NO. 350610 - 4886606 - 90496116</p> <p>ESTICADOR DA BARRA ESTABILIZADORA DA FRENTE</p> <p>OPEL VECTRA B 1.6i - 1.6i 16v - 1.7 TD - 1.8i 16v - 2.0 Di 16v - 2.0 DTi 16v - 2.0i - 2.0i 16v - 2.2DTi 16v - 2.5i V6 - 2.6i V6 (1995 A 2002)</p> <p>285x36x36mm 2p-d12-25mm</p> |
|  | <p>E0216-M NO. 684703 - 90496942</p> <p>ESTICADOR DO MOTOR</p> <p>OPEL VECTRA B 1.6i - 1.8i 16v - 2.0i - 2.0i 16v (1992 A 2002)</p> <p>150x60x45mm 1f-d12/25mm 1f-d11mm</p> |  | <p>E1092 NO. 852726</p> <p>ESTICADOR DE ESCAPE</p> <p>OPEL VECTRA B 1.6i - 1.7TD - 1.8i 16v - 2.0DTi 16v - 2.0i - 2.0i 16v (APOS 09-1995)</p> <p>55x40x35mm NULL</p> |
|  | <p>F1373-I NO. 1603141 - 374040 - 90009020 - 90112609 - 90421756</p> <p>FOLE DA TRANSMISSÃO JUNTO À CAIXA</p> <p>OPEL VECTRA B 1.7TD - 1.8i - 2.0i (95 A 02)</p> <p>d87x99mm 1f-d65mm 1f-d22mm</p> |  | <p>F1702-I NO. 1609095 - 90512778</p> <p>FOLE DA DIREÇÃO LADO DIREITO E ESQUERDO</p> <p>OPEL VECTRA B 1.6i - 1.6i 16v - 1.7 TD - 1.8i 16v - 2.0 Di 16v - 2.0 DTi 16v - 2.0i 16v - 2.2i 16v - 2.5i V6 (1995 A 2002)</p> <p>d59x160mm 1f-d45mm 1f-d11mm</p> |
|  | <p>F1848-I NO. 1603238 - 1603014 - 1603183 - 374429 - 374014 - 374319 - 90543336</p> <p>FOLE DA TRANSMISSÃO JUNTO À CAIXA</p> <p>OPEL VECTRA B 1.6i 16v - 1.8i 16v - 1.9 CDTi 16v - 1.9 CDTi 8V - 2.0 Di 16v - 2.0 DTi 16v - 2.0i 16v - 2.0i T 16v - 2.2 DTi 16v - 2.2i 16v - 2.5i V6 (1995 A 2002)</p> <p>d95x100mm 1f-d65mm 1f-d24mm</p> |  | <p>F4096 NO. 90436277 - 5738405</p> <p>FOLE ALAVANCA VELOCIDADES</p> <p>OPEL VECTRA B Hatchback (38_) 1.6i (10.95 A 07.03) 75cv 1598cc Hatchback - OPEL VECTRA B Hatchback (38_) 1.6i 16V (10.95 A 07.02) 101cv 1598cc Hatchback - OPEL VECTRA B Hatchback (38_) 1.8i 16V (10.95 A 09.00) 116cv 1796cc Hatchback - OPEL VECTRA B Hatchback (38_) 1.8i 16V (09.00 A 07.03) 125cv 1796cc Hatchback - OPEL VECTRA B Hatchback (38_) 2.0i 16V (10.95 A 09.00) 136cv 1998cc Hatchback - OPEL VECTRA B Hatchback (38_) 2.2i 16V ...etc.</p> <p>175x120x200 1f-d50mm 1f-155x105mm</p> |
|  | <p>F4112 NO. 90436348 - 0578511</p> <p>FOLE ALAVANCA VELOCIDADES</p> <p>OPEL VECTRA B</p> <p>180x200x50mm 1f-d16mm 1f-190x45mm</p> |  | <p>KF2345 NO. 374190 - 90236762</p> <p>FOLE DO LADO DA RODA</p> <p>OPEL VECTRA B 1.7TD (1995 A 2002)</p> <p>d90x82mm 1f-d19mm 1f-d75mm</p> |
|  | <p>M6082 NO. 854955 - 854943 - 854944 - 97069287</p> <p>JUNTA DE ESCAPE</p> <p>OPEL VECTRA B 1.7 - 1.7TD (APÓS 1995)</p> <p>d64x5mm 1f-d53mm</p> |  | <p>P1049 NO. 560195</p> <p>CAPA DE PEDAL DO TRAVÃO E EMBRAIAGEM</p> <p>OPEL VECTRA B 1.6 - 1.7 TD - 1.8 - 2.0 - 2.0DTI</p> <p>63x63x12mm NULL</p> |
|  | <p>R222770 NO. 1337328</p> <p>TUBO SUPERIOR DO RADIADOR</p> <p>OPEL VECTRA B 1.6i (10-1995 A 07-2003)</p> <p>B210-d31/34mm 80-100-110-60-50-60mm</p> |  | <p>R222772 NO. 1337329</p> <p>TUBO SUPERIOR DO RADIADOR</p> <p>OPEL VECTRA B 1.8i 16V - 2.0i 16V</p> <p>B210-d34/34mm 50-100-50-50mm</p> |
|  | <p>R222774 NO. 1337361</p> <p>TUBO SUPERIOR DO RADIADOR</p> <p>OPEL VECTRA B 1.7 TD (10-1995 A 12-1998)</p> <p>B300-d32/32mm 50-60-70-100-130mm</p> |  | <p>R222776 NO. 1337414</p> <p>TUBO SUPERIOR DO RADIADOR</p> <p>OPEL VECTRA B 2.0 DTi 16V</p> <p>B110-d33/33mm 50-70-60-80mm</p> |

| | | | |
|---|---|---|---|
|  | <p>RT08619 NO. 562373 - 562364 - 90495787 - 90539252</p> <p>TUBO DE TRAVÃO FRENTE LH-RH</p> <p>OPEL VECTRA B TT (APÓS 10-1995)</p> |  | <p>S1464 NO. 423302 - 423318 - 90495585 - 9191309</p> <p>SILENT BLOC DO BRAÇO DA SUSPENSÃO DE TRÁS</p> <p>OPEL VECTRA B 1.6i - 1.7TD - 1.8i 16V - 2.0i - 2.0i 16V - 2.0DTi 16V (1995 A 2002) - STATION WAGON 1.6i - 1.8i 16V - 2.0i 16V - 2.0DTi 16V (1996 A 2003)</p> |
|  | <p>S1465 NO. 5402630 - 90496681</p> <p>SILENT BLOC DA SUSPENSÃO DE TRÁS (TRAVERSA)</p> <p>OPEL VECTRA B 1.6i - 1.7TD - 1.8i 16V - 2.0i - 2.0DTi 16V (1995 A 2002) - STATION WAGON 1.6i - 1.8i 16V - 2.0i - 2.0DTi 16V (1996 A 2003)</p> |  | <p>S1471 NO. 352357 - 90468636</p> <p>SILENT BLOC DO BRAÇO SA SUSPENSÃO DA FRENTE</p> <p>OPEL VECTRA B 1.6i - 1.7TD - 1.8i 16V - 2.0i - 2.0i 16V - 2.0DTi 16V (1995 A 2002) - STATION WAGON 1.6i - 1.8i 16V - 2.0i - 2.0i 16V - 2.0DTi 16V (1996 A 2003)</p> |
|  | <p>S1474 NO. 423316 - 90496686</p> <p>SILENT BLOC DA SUSPENSÃO DE TRÁS</p> <p>OPEL VECTRA B 1.6i - 1.7TD - 1.8i 16V - 2.0i - 2.0i 16V - 2.0DTi 16V (1995 A 2003) - STATION WAGON 1.6i - 1.8i 16V - 2.0i 16V - 2.0DTi 16V - (1996 A 2003)</p> |  | <p>S1476 NO. 423121 - 90486700</p> <p>SILENT BLOC DA SUSPENSÃO DE TRÁS</p> <p>OPEL VECTRA B 1.6i - 1.7TD - 1.8i 16V - 2.0i - 2.0i 16V - 2.0DTi 16V - (1995 A 2003) - STATION WAGON 1.6i - 1.8i 16V - 2.0i 16V - 2.0DTi 16V - (1996 A 2003)</p> |
|  | <p>T0645-I NO. 0344417 - 344417 - 0344417 - 90468644</p> <p>BATENTE SUSPENSÃO DA FRENTE</p> <p>OPEL VECTRA B Combi (31_) 1.6 i (11.96 A 06.00) 75cv 1598cc Combi - OPEL VECTRA B Combi (31_) 1.6 i 16V (11.96 A 07.02) 100cv 1598cc Combi - OPEL VECTRA B Combi (31_) 1.8 i 16V (11.96 A 09.00) 115cv 1796cc Combi - OPEL VECTRA B Combi (31_) 1.8 i 16V (11.96 A 09.00) 115cv 1799cc Combi - OPEL VECTRA B Combi (31_) 1.8 i 16V (09.00 A 07.03) 125cv 1796cc Combi - OPEL VECTRA B Combi (31_) 2.0 i 16V (11.96 A 09.00) 136cv 1998cc Combi - OPEL VECT...etc.</p> |  | <p>W5034 NO. 614654</p> <p>POLIE DA CAMBOTA (6 PISTAS)</p> <p>OPEL VECTRA B 1.8i 16v - 2.0i - 2.0i 16v - 2.2DTi 16v</p> |
|  | <p>W5045 NO. 5614417</p> <p>POLIE DA CAMBOTA (1+1+1 PISTAS)</p> <p>OPEL VECTRA B 1.7TD (1995 A 1998)</p> |  | <p>W5051 NO. 55351711 - 5614437 - 614411 - 9128177 - 614444 - 5614415 - 912817769 - 90528648</p> <p>POLIE DA CAMBOTA (6 PISTAS)</p> <p>OPEL VECTRA B 2.0 DTi (10-1996 A 07-2002) - Mtr X20DTL-Y20DTH (82-101CV) - VECTRA B 2.2DTi (09-2000 A 04-2002) - Mtr Y22DTR (125CV)</p> |
|  | <p>W5069 NO. 5614413 - 614654 - 90466618</p> <p>POLIE DA CAMBOTA (6 PISTAS)</p> <p>OPEL VECTRA B 1.8i 16v - 2.0i - 2.0i 16v - 2.2i 16v</p> |  | <p>W5092 NO. 5614428 - 615029 - 90424119</p> <p>POLIE DA CAMBOTA (5 PISTAS)</p> <p>OPEL VECTRA B 2.0i Motor 20NEJ (10-1995 A 04-2002)</p> |
|  | <p>Y3004 NO. 854982 - 90128082</p> <p>PARAFUSO ESCAPE</p> <p>OPEL VECTRA B (APÓS 1995)</p> |  | <p>Z80540 NO. 90022049 - 2240861</p> <p>Mola de painel</p> <p>OPEL VECTRA B</p> |
|  | <p>Z80846 NO. 90450482 - 1104881 - 1104882</p> <p>Rebite</p> <p>OPEL VECTRA B</p> |  | <p>Z9000 NO. 854880 - 854881 - 858884 - 25501711 - 90234204</p> <p>MOLA DE ESCAPE 42mm</p> <p>OPEL VECTRA B (1992 A 2002)</p> |

| | | | |
|---|--|---|--|
|  | <p>F1827-I NO. 4410859</p> <p>FOLE DA TRANSMISSÃO JUNTO À CAIXA</p> <p>OPEL VIVARO 1.9 Di - 1.9 DTi - 2.0i 16V - 2.5 DTi (APÓS 2001)</p> <p>d115x85mm 1f-d73mm 1f-d42mm</p> |  | <p>KF1686-T NO. 1603232</p> <p>KIT DE FOLE DO CARDAN JUNTO À RODA</p> <p>OPEL VECTRA C E GTS 2.0iT - 2.2 Dt - 3.0 CDTi - 3.2i (2002 A 2008)</p> <p>d105x130mm 1f-d90mm 1f-d27mm</p> |
|  | <p>KF2362-T NO. 1603232 - 1603278 - 1603281 - 1603284 - 93182574</p> <p>KIT DE FOLE DO CARDAN JUNTO À RODA</p> <p>OPEL VECTRA C & GTS (APÓS 2002) 1.9CDTi 16V - 1.9CDTi 8V</p> <p>d104x130mm 1f-d91mm 1f-d27mm</p> |  | <p>W5051 NO. 55351711 - 5614437 - 614411 - 9128177 - 614444 - 5614415 - 912817769 - 90528648</p> <p>POLIE DA CAMBOTA (6 PISTAS)</p> <p>OPEL VECTRA C 2.0 DTi 16v - 2.2 DTi 16v (APÓS 02-2004) Mtr X20DTH - Y22DTR (101-125CV)</p> <p>d153mm d35mm</p> |
|  | <p>W5107 NO. 5614425 - 5614431 - 9129209</p> <p>POLIE DA CAMBOTA (5 PISTAS)</p> <p>OPEL VECTRA C 1.6 16V Z 16 XE 100CV (APÓS 06-2004) - 1.8 Z 18 XEL 110CV (APÓS 04-2002) - 1.8 Z 18 XER 140CV (APÓS 01-2006) - 1.8 16V Z 18 XE 122CV (APÓS 04-2002) - OPEL VECTRA C GTS 1.6 Z 16 XE 100CV (APÓS 08-2005) - 1.8 Z 18 XER 140CV (APÓS 01-2006) - 1.</p> <p>NULL d160m 1f-d26mm</p> |  | <p>W5107 NO. 5614425 - 5614431 - 9129209</p> <p>POLIE DA CAMBOTA (5 PISTAS)</p> <p>OPEL VECTRA C Station wagon 1.8 Z 18 XE 122CV (APÓS 10-2003) - 1.8 Z 18 XER 140CV (APÓS 01-2006)</p> <p>NULL d160m 1f-d26mm</p> |
|  | <p>W5145 NO. 55210310 - 0614359 - 614359 - 93192547</p> <p>POLIE DA CAMBOTA 6 PISTAS</p> <p>OPEL VECTRA C GTS 1.9 CDTi (APÓS 10.05) 100cv 1910cc Hatchback - OPEL VECTRA C GTS 1.9 CDTi (APÓS 04.04) 120cv 1910cc Hatchback - OPEL VECTRA C 1.9 CDTi (APÓS 10.05) 100cv 1910cc três volumes - OPEL VECTRA C 1.9 CDTi (APÓS 04.04) 120cv 1910cc três volumes - OPEL VECTRA C Combi 1.9 CDTi (APÓS 10.05) 100cv 1910cc Combi - OPEL VECTRA C Combi 1.9 CDTi (APÓS 04.04) 120cv 1910cc Combi</p> <p>d169mm d30,5mm</p> |  | <p>Z80846 NO. 90450482 - 1104881 - 1104882</p> <p>Rebite</p> <p>OPEL VECTRA C</p> <p>d19x29mm 1p-d8-15.2mm</p> |

OPEL VIVARO

| | | | |
|--|--|--|---|
|  | <p>E1117 NO. 2065100QAB</p> <p>ESTICADOR DO ESCAPE</p> <p>OPEL VIVARO Combi (J7) 2.0 ECOTEC (A Partir de 08.06) 117cv 1998cc Autocarro - OPEL VIVARO Combi (J7) 2.0 16V (A Partir de 08.01) 120cv 1998cc Autocarro - OPEL VIVARO Combi (J7) 1.9 DI (A Partir de 08.01) 80cv 1870cc Autocarro - OPEL VIVARO Combi (J7) 1.9 DTi (A Partir de 08.01) 101cv 1870cc Autocarro - OPEL VIVARO Combi (J7) 2.5 DTi (A Partir de 05.03) 135cv 2463cc Autocarro - OPEL VIVARO Caixa (F7) 2.0 ECOTEC (A Partir de 08.06) 117c...etc.</p> <p>68x40x38mm 2f-d12mm</p> |  | <p>F1701K3I NO. 4501297</p> <p>FOLE DA TRANSMISSÃO JUNTO À CAIXA</p> <p>OPEL VIVARO 1.9 Di - 1.9 DTi - 2.0i 16v - 2.5 DTi (APÓS 2001)</p> <p>d85x200mm 1f-d75mm 1f-d25mm</p> |
|  | <p>KF2362-T NO. 1603232 - 1603278 - 1603281 - 1603284 - 93182574</p> <p>KIT DE FOLE DO CARDAN JUNTO À RODA</p> <p>OPEL VIVARO (APÓS 2001) 1.9 Di - 1.9DTi - 2.0i 16V - 2.5DTi</p> <p>d104x130mm 1f-d91mm 1f-d27mm</p> |  | <p>RT80200 NO. 4416297 - 93859698</p> <p>TUBO DE TRAVÃO FRENTE LH-RH</p> <p>OPEL VIVARO (MOD.2001) TT APÓS 08-2001</p> <p>415mm FZ - MC11</p> |
|  | <p>RT80201 NO. 4409165</p> <p>TUBO DE TRAVÃO TRÁS LH-RH</p> <p>OPEL VIVARO (MOD.2001) TT APÓS 08-2001</p> <p>230mm FZ - FZ</p> |  | <p>RT80252 NO. 4412727</p> <p>TUBO DE TRAVÃO TRÁS LH-RH</p> <p>OPEL VIVARO TT (APÓS 08-2001)</p> <p>250mm FZ - MC11</p> |

| | | | | |
|--|---|---|--|--|
|  | W5083 | NO. 4433564 - 93198115 - 4418765 - 4416535 - 4416426 - 93196089 - 4405268 - 931188615 - 9121101 - 931874... | | |
| | POLIE DA CAMBOTA (7 PISTAS) | | | |
| | OPEL VIVARO Combi (J7) 2.5 DTI Autocarro 135CV 2463cc (APÓS 05-2003) - 2.5 CDTI 146CV 2463cc (APÓS 08-2006) - VIVARO Caixa (F7) - 2.5 DTI 135CV 2463cc (APÓS 05-2003) - 2.5 CDTI 146CV 2463cc (APÓS 08-2006) - VIVARO Camião de plataforma-chassis (E7) - 2.5 C | | | |
| | d152/162mm | d30/58mm | | |

OPEL ZAFIRA

| | | | | | |
|--|--|--|--|---|--|
|  | A1631 | NO. 0682502 - 09191558 - 24427641 - 5682534 |  | A1643 | NO. 5684048 |
| | APOIO DO MOTOR PARTE DE TRÁS | | | APOIO DO MOTOR PARTE DA FRENTE ESQUERDO | |
| | OPEL ZAFIRA 2.0 Dti 16v (09-2000 A 06-2005) | | | OPEL ZAFIRA 2.0 OPC - 2.0Di 16v - 2.0DTI 16v - 2.2 16v (1999 A 2005) | |
| | 130x150x90mm | 1f-d13/19mm 1f-d12mm | | 160x120x70mm | 1f-d13mm |
|  | A1644 | NO. 5684045 - 90575456 |  | A1647 | NO. 5684051 - 90575772 - 5684053 - 5684054 |
| | APOIO DO MOTOR PARTE DA FRENTE ESQUERDO | | | APOIO DO MOTOR PARTE DA FRENTE DIREITO | |
| | OPEL ZAFIRA 1.6 16v - 1.8 16v (1999 A 2005) | | | OPEL ZAFIRA 1.2 16v - 1.4 16v - 1.6 - 1.6 16v - 1.8 16v (1999 A 2005) | |
| | 170x105x70mm | 1f-d13mm | | 170x140x120mm | 1f-d12 - 7mm |
|  | A1651 | NO. 684692 |  | A1685 | NO. 684693 |
| | APOIO DO MOTOR PARTE DA FRENTE CENTRAL | | | APOIO DO MOTOR PARTE DA FRENTE | |
| | OPEL ZAFIRA 1.2 16v - 1.6 - 1.7TD - 1.7DTi (1999 A 2005) | | | OPEL ZAFIRA 1.6 16v - 1.8 16v (COM TRANSMISSÃO AUTOMÁTICA) (1999 A 2005) | |
| | 230x130x80mm | 1f-d16mm | | 145x125x75mm | 1f-d16mm |
|  | A1691 | NO. 684697 - 90576048 |  | A1692 | NO. 5682519 |
| | APOIO DO MOTOR PARTE DA FRENTE | | | APOIO DO MOTOR PARTE DE TRÁS | |
| | OPEL ZAFIRA 2.0 Dti (09-2000 A 06-2005) | | | OPEL ZAFIRA 1.6 - 1.6 16v - 1.8 - 1.8 16v - 1.9CDTi - 2.0 OPC (1999 A 2005) | |
| | 170x123x75mm | 1f-d16mm | | 155x125x92mm | 1f-d12mm |
|  | A1694 | NO. 5684162 - 684168 - 684695 - 90575190 - 9156951 |  | C0233 | NO. 1160724 - 90054143 |
| | APOIO DO MOTOR PARTE DA FRENTE CENTRAL | | | BOTÃO AFINAÇÃO CAPÔT | |
| | OPEL ZAFIRA 2.0 OPC (09-2001 A 06-2005) | | | OPEL ZAFIRA A (F75_) 1.6 CNG (09.01 A 06.05) 97cv 1598cc Veículo multiuso - OPEL ZAFIRA A (F 75 _) 1.6 16 V (04.99 A 06.05) 101cv 1598 Veículo multiuso - OPEL ZAFIRA A (F 75 _) 1.8 16 V (04.99 A 09.00) 116cv 1796cc Veículo multiuso - OPEL ZAFIRA A (F 75 _) 1.8 1 6 V (09.00 A 06.05) 125cv 1796cc Veículo multiuso - OPEL ZAFIRA A (F 75 _) 2.0 OPC (09.01 A 06.05) 192cv 1998cc Veículo multiuso - OPEL ZAFIRA A (F 75 _) 2.0 OPC (11.02 A 06...etc. | |
| | 170x120x75mm | 1f-d16mm | | d19x31mm | NULL |
|  | C0233 | NO. 1160724 - 90054143 |  | C0233 | NO. 1160724 - 90054143 |
| | BOTÃO AFINAÇÃO CAPÔT | | | BOTÃO AFINAÇÃO CAPÔT | |
| | OPEL ZAFIRA B (A 05) 1.6 CNG (A Partir de 01.06) 94cv 1598cc Veículo multiuso - OPEL ZAFIRA B (A 05) 1.6 (A Partir de 07.05) 105cv 1598cc Veículo multiuso - OPEL ZAFIRA B (A 05) 1.6 (A partir de 01.08) 115cv 1598cc Veículo multiuso - OPEL ZAFIRA B (A 05) 1.6 CNG Turbo (A Partir de 02.09) 150cv 1598cc Veículo multiuso OPEL ZAFIRA B (A 05) 1.8 (A Partir de 07.05) 140cv 1796 Veículo multiuso - OPEL ZAFIRA B (A 05) 2.0 (A Partir de 07....etc. | | | OPEL ZAFIRA TOURER C (P 12) 1.4 (A Partir de 10.11) 120cv 1364cc Veículo multiuso - OPEL ZAFIRA TOURER C (P 12) 1.4 (A Partir de 10.11) 140cv 1364cc Veículo multiuso - OPEL ZAFIRA TOURER C (P 12) 1.4 LPG (A Partir de 10.11) 140cv 1364cc Veículo multiuso - OPEL ZAFIRA TOURER C (P 12) 1.6 CNG (A Partir de 10.11) 150cv 1598cc Veículo multiuso - OPEL ZAFIRA TOURER C (P 12) 1.6 SIDI (A Partir de 12.12) 170cv 1598cc Veículo multiuso - O...etc. | |
| | d19x31mm | NULL | | d19x31mm | NULL |

| | | | |
|--|--|--|---|
|  | <p>E0163 NO. 350611 - 350614 - 13169439 - 90498745</p> <p>ESTICADOR DA BARRA ESTABILIZADORA DA FRENTE</p> <p>OPEL ZAFIRA TT (1999 A 2005)</p> |  | <p>E1092 NO. 852726</p> <p>ESTICADOR DE ESCAPE</p> <p>OPEL ZAFIRA (APÓS 03-1998)</p> |
|  | <p>F1650A-I NO. 1604252 - 1604300 - 90510398</p> <p>FOLE DA TRANSMISSÃO JUNTO À CAIXA</p> <p>OPEL ZAFIRA (1) 1.8i 16V - 2.0 Di 16V (1999 A 2005)</p> |  | <p>F1848-I NO. 1603238 - 1603014 - 1603183 - 374429 - 374014 - 374319 - 90543336</p> <p>FOLE DA TRANSMISSÃO JUNTO À CAIXA</p> <p>OPEL ZAFIRA 1.6i CN(G) - 1.8i 16v - 2.0 DTi 16v - 2.2i 16v (APÓS 1999)</p> |
|  | <p>F4099 NO. 93182743 - 5738419</p> <p>FOLE ALAVANCA VELOCIDADES</p> <p>OPEL ZAFIRA A (F75_) 1.6 CNG (09.01 A 06.05) 97cv 1598cc Veículo multiuso - OPEL ZAFIRA A (F75_) 1.6 16V (04.99 A 06.05) 101cv 1598cc Veículo multiuso - OPEL ZAFIRA A (F75_) 1.8 16V (04.99 A 09.00) 116cv 1796cc Veículo multiuso - OPEL ZAFIRA A (F75_) 1.8 16V (09.00 A 06.05) 125cv 1796cc Veículo multiuso - OPEL ZAFIRA A (F75_) 2.0 OPC (09.01 A 06.05) 192cv 1998cc Veículo multiuso - OPEL ZAFIRA A (F75_) 2.0 OPC (11.02 A 06.05) 200cv...etc.</p> |  | <p>F4100 NO. 93182744 - 5738420</p> <p>FOLE ALAVANCA VELOCIDADES</p> <p>OPEL ZAFIRA A (F75_) 1.6 CNG (09.01 A 06.05) 97cv 1598cc Veículo multiuso - OPEL ZAFIRA A (F75_) 1.6 16V (04.99 A 06.05) 101cv 1598cc Veículo multiuso - OPEL ZAFIRA A (F75_) 1.8 16V (04.99 A 09.00) 116cv 1796cc Veículo multiuso - OPEL ZAFIRA A (F75_) 1.8 16V (09.00 A 06.05) 125cv 1796cc Veículo multiuso - OPEL ZAFIRA A (F75_) 2.0 OPC (09.01 A 06.05) 192cv 1998cc Veículo multiuso - OPEL ZAFIRA A (F75_) 2.0 OPC (11.02 A 06.05) 200cv...etc.</p> |
|  | <p>KF2271-T NO. 1603259 - 374434</p> <p>KIT DE FOLE DO CARDAN JUNTO À RODA</p> <p>OPEL ZAFIRA 1.6i CN(G) - 1.8i 16v - 2.0 DTi 16v (APÓS 1999)</p> |  | <p>KF3480 NO. 1603011 - 1603220 - 1603221 - 09198502 - 09200338</p> <p>KIT DE FOLE DO CARDAN JUNTO À RODA</p> <p>OPEL ZAFIRA 2.0 OPC 192CV (09-2001 A 06-2005) - 2.0 OPC 200CV (11-2002 A 06-2005) - 2.2 DTi 16V 125CV (01-2002 A 06-2005)</p> |
|  | <p>P1081 NO. 842736</p> <p>CAPA DE PEDAL DO ACELARADOR</p> <p>OPEL ZAFIRA A 1.6 16V (04-1999 A 06-2005) 101CV 1598CC - OPEL ZAFIRA A 1.8 16V (04-1999 A 09-2000) 116CV 1796CC - OPEL ZAFIRA A 1.8 16V (09-2000 A 06-2005) 125CV 1796CC - OPEL ZAFIRA A 2.0 OPC (09-2001 A 06-2005) 192CV 1998CC - OPEL ZAFIRA A 2.0 OPC (11-2</p> |  | <p>P1103 NO. 0560804 - 09191205 - 560804 - 9191205</p> <p>CAPA DE PEDAL DO TRAVÃO</p> <p>OPEL ZAFIRA A (F75_) 1.6 CNG (09.01 A 06.05) 97cv 1598cc Veículo multiuso - OPEL ZAFIRA A (F75_) 1.6 16V (04.99 A 06.05) 101cv 1598cc Veículo multiuso - OPEL ZAFIRA A (F75_) 1.8 16V (04.99 A 09.00) 116cv 1796cc Veículo multiuso - OPEL ZAFIRA A (F75_) 1.8 16V (09.00 A 06.05) 125cv 1796cc Veículo multiuso - OPEL ZAFIRA A (F75_) 2.0 OPC (09.01 A 06.05) 192cv 1998cc Veículo multiuso - OPEL ZAFIRA A (F75_) 2.0 OPC (11.02 A 06.05) 200cv...etc.</p> |
|  | <p>R222703 NO. 1337582 - 24413975</p> <p>TUBO SUPERIOR DO RADIADOR</p> <p>OPEL ZAFIRA 1.6 COM A-C (04-1999 A 06-2005)</p> |  | <p>R222704 NO. 1337556 - 9202896</p> <p>TUBO INFERIOR DO RADIADOR</p> <p>OPEL ZAFIRA 1.6 (04-1999 A 06-2005)</p> |
|  | <p>R222715 NO. 1377542</p> <p>TUBO SUPERIOR DO RADIADOR</p> <p>OPEL ZAFIRA 1.7 TD (1998 A 2005)</p> |  | <p>R222723 NO. 1337565 - 24421116</p> <p>TUBO SUPERIOR DO RADIADOR</p> <p>OPEL ZAFIRA 2.0 DTi 16v (09-2000 A 06-2005)</p> |
|  | <p>R222724 NO. 1337502 - 90573220 - 91156066</p> <p>TUBO INFERIOR DO RADIADOR</p> <p>OPEL ZAFIRA DTi (82-101CV) (2000 A 2005)</p> |  | <p>RT08934 NO. 562377 - 90498319</p> <p>TUBO DE TRAVÃO FRENTE LH-RH</p> <p>OPEL ZAFIRA TT (APÓS 04-1999)</p> |

| | | | |
|--|--|--|--|
| | <p>RT80277 NO. 5562260 - 13136715 - 562161</p> <p>TUBO DE TRAVÃO FRENTE LH-RH</p> <p>OPEL ZAFIRA II TT (APÓS 07-2005)</p> | | <p>RT80582 NO. 5562248</p> <p>TUBO DE TRAVÃO TRÁS RH (COM DISCO)</p> <p>OPEL ZAFIRA 1.6 (motor Z 16 XEP) (APÓS 7-2005) - 1.6 (motor Z 16 XER) (APÓS 01-2008) - 1.6 (motor Z 16 YNG) (APÓS 01-2008) - 1.7 CDTi (motor A 17 DTJ) (APÓS 01-2008) - 1.7 CDTi (motor A 17 DTR) (APÓS 01-2008) - 1.8 (motor Z 18 XEP) (APÓS 07-2005) - 1.9 CD</p> |
| | <p>RT80583 NO. 5562247</p> <p>TUBO DE TRAVÃO TRÁS LH (COM DISCO)</p> <p>OPEL ZAFIRA 1.6 (motor Z 16 XEP) (APÓS 7-2005) - 1.6 (motor Z 16 XER) (APÓS 01-2008) - 1.6 (motor Z 16 YNG) (APÓS 01-2006) - 1.7 CDTi (motor A 17 DTJ) (APÓS 01-2008) - 1.7 CDTi (motor A 17 DTR) (APÓS 01-2008) - 1.8 (motor Z 18 XEP) (APÓS 07-2005) - 1.9 CD</p> | | <p>S1333 NO. 3523.65 - 90498740</p> <p>SILENT-BLOC DO BRAÇO SUSPENSÃO FRENTE(PARTE DE TRÁS)</p> <p>OPEL ZAFIRA 1.6 - 1.8 - 2.0 - 2.0DTI (APÓS 1999)</p> |
| | <p>S1473 NO. 352364 - 90498738 - 0352364</p> <p>SILENT BLOC DO BRAÇO SA SUSPENSÃO DA FRENTE</p> <p>OPEL ZAFIRA 1.6 16V - 1.6CNG - 1.8 - 1.8 16V - 1.9CDTi - 2.0 OPC - 2.0Di 16V - 2.0DTi 16V - 2.2 16V - 2.2DTi 16V</p> | | <p>T0645-I NO. 0344417 - 344417 - 0344417 - 90468644</p> <p>BATENTE SUSPENSÃO DA FRENTE</p> <p>OPEL ZAFIRA A (F75_) 1.6 CNG (09.01 A 06.05) 97cv 1598cc Veículo multiuso - OPEL ZAFIRA A (F 75_) 1.6 16 V (04.99 A 06.05) 101cv 1598cc Veículo multiuso - OPEL ZAFIRA A (F 75_) 1.8 16 V (04.99 A 09.00) 116cv 1796cc Veículo multiuso - OPEL ZAFIRA A (F 75_) 1.8 16 V (09.00 A 06.05) 125cv 1796cc Veículo multiuso - OPEL ZAFIRA A (F 75_) 2.0 OPC (09.01 A 06.05) 192cv 1998cc Veículo multiuso - OPEL ZAFIRA A (F 75_) 2.0 OPC (11.02 A 06.05) ...etc.</p> |
| | <p>T1076 NO. 350093</p> <p>BATENTE DA BARRA ESTABILIZADORA FRENTE</p> <p>OPEL ZAFIRA (APÓS 1999) 1.6 - 1.8 - 2.0 - 2.0 DTI APÓS Y2168372 (BARRA (23mm))</p> | | <p>T1077 NO. 350140</p> <p>BATENTE DA BARRA ESTABILIZADORA FRENTE</p> <p>OPEL ZAFIRA (APÓS 1999) 1.6 - 1.8 - 2.0 - 2.0 DTI APÓS Y2168371 (BARRA (24mm))</p> |
| | <p>W5051 NO. 55351711 - 5614437 - 614411 - 9128177 - 614444 - 5614415 - 912817769 - 90528648</p> <p>POLIE DA CAMBOTA (6 PISTAS)</p> <p>OPEL ZAFIRA 2.0 Di 16v APÓS 04-1999 - Mtr X20DTL (82CV) - ZAFIRA 2.0 DTI 16v APÓS 01-2000 - Mtr Y20DTH (101CV) - ZAFIRA 2.2 DTI 16v APÓS 04-2002 - Mtr Y22DTR (125CV)</p> | | <p>W5098 NO. 5614427</p> <p>POLIE DA CAMBOTA</p> <p>OPEL ZAFIRA 1.7 TD</p> |
| | <p>W5107 NO. 5614425 - 5614431 - 9129209</p> <p>POLIE DA CAMBOTA (5 PISTAS)</p> <p>OPEL ZAFIRA 1.6 16V X 16 XEL - Z 16 XE 101CV (04-1999 A 06-2005) - 1.6 CNG Z 16 YNG 97CV (09-2001 A 06-2005) - 1.8 16V Z 18 XE 125CV (09-2000 A 06-2005)</p> | | <p>W5145 NO. 55210310 - 0614359 - 614359 - 93192547</p> <p>POLIE DA CAMBOTA 6 PISTAS</p> <p>OPEL ZAFIRA B (A05) 1.9 CDTi (APÓS 07.05) 100cv 1910cc Veículo multiuso - OPEL ZAFIRA B (A05) 1.9 CDTi (APÓS 07.05) 120cv 1910cc Veículo multiuso</p> |
| | <p>Z80792 NO. 174864</p> <p>Mola de painel</p> <p>OPEL ZAFIRA</p> | | <p>Z80846 NO. 90450482 - 1104881 - 1104882</p> <p>Rebite</p> <p>OPEL ZAFIRA B (Após 2005)</p> |