







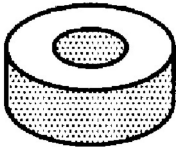

	<p><b>C1000</b> NO. 65806-H5000</p> <p>BOTÃO DE CAPOT</p> <p>NISSAN</p> <p>NULL NULL</p>		<p><b>H127</b> NO.</p> <p>PALA CAMIÃO PEQUENA PICOTADA NISSAN</p> <p>NISSAN</p> <p>450x340mm NULL</p>
	<p><b>H340</b> NO.</p> <p>PALA</p> <p>NISSAN</p> <p>262x306mm NULL</p>		<p><b>H811</b> NO.</p> <p>PALA MEIA LUA GRANDE</p> <p>NISSAN</p> <p>510x226x5mm NULL</p>
	<p><b>L0176</b> NO. 56127-25660 - 56112-09490 - 56112-09400 - 56112-0F000 - 56112-V0100</p> <p>CASQUILHO DA BARRA ESTABILIZADORA</p> <p>NISSAN</p> <p>d25x16mm 1f-d11mm</p>		<p><b>Z80760</b> NO. 155303831 - 62318-33M00</p> <p>Mola de fixação</p> <p>NISSAN (TODOS)</p> <p>11.6x6.8x22.3mm NULL</p>
	<p><b>Z80777</b> NO. 155309241</p> <p>Mola de fixação</p> <p>NISSAN (TODOS)</p> <p>d18x28mm 1p-d10-18mm</p>		<p><b>Z80778</b> NO. 6385401A00 - 91545SE0003 - MR328954</p> <p>Mola de fixação</p> <p>NISSAN (TODOS)</p> <p>d20x26mm 1p-d8-15mm</p>
	<p><b>Z80783</b> NO. 155300051</p> <p>Mola de painel</p> <p>NISSAN (TODOS)</p> <p>d20x19mm 1p-d7-16mm</p>		

NISSAN 100 NX

	<p><b>KF1635</b> NO. 3924101E25 - 3924101E00 - 3924101E26 - 3924101E27 - 3924101E28 - 3924101E29 - 3924101E85 - 3924101E8...</p> <p>KIT DE FOLE DO CARDAN LADO DA RODA</p> <p>NISSAN 100NX 1.6i (01-1991 A 04-1994) - 2.0i GTI (01-1991 A 09-1993)</p> <p>d97x96mm 1f-d86mm 1f-d22mm</p>		<p><b>KF1691</b> NO. 39241-01E29 - 39741-4F125</p> <p>KIT DE FOLE DO CARDAN JUNTO Á RODA</p> <p>NISSAN 100 NX 1.6 - 1.6i - 2.0i Gti (03-1990 A 10-1994)</p> <p>d94x95mm 1f-d80mm 1f-d21mm</p>
	<p><b>M6019</b> NO. 2069177A00 - 206919C000</p> <p>JUNTA DE ESCAPE</p> <p>NISSAN 100NX (1990 A 1992)</p> <p>d51x4mm 1f-d43.6mm</p>		<p><b>M6020</b> NO. 206911B00</p> <p>JUNTA DE ESCAPE</p> <p>NISSAN 100NX (1990 A 1996)</p> <p>d46x4mm 1f-d38.5mm</p>

	<b>M6044</b>	NO. 20692P9000 - 2069265J00		<b>RT80053</b>	NO. 4621050Y02 - 4621050Y12 - 46210-97N01 - 46214-79917
	JUNTA DE ESCAPE			TUBO DE TRAVÃO FRENTE LH	
NISSAN 100NX (APÓS 1991) - 260SX (APÓS 1989)			NISSAN 100NX 1.6 - 1.6SR - 2.0 GTI (10-1990 A 10-1994)		
132x96mm	1f-d64mm		500mm	FB43 - OR33	
	<b>RT80054</b>	NO. 4621050Y07 - 46210-50Y15 - 46210-50Y17			
	TUBO DE TRAVÃO TRÁS LH- RH				
NISSAN 100NX 1.6 - 1.6SR - 2.0 GTI ((10-1990 A 10-1994)					
497mm	FA5 - OR33				

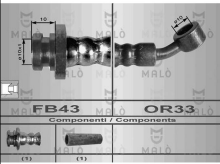
## NISSAN 280 ZX

	<b>E0032</b>	NO. 42013-0101P			
	ESTICADOR DE ESCAPE				
NISSAN 280 ZX (79- A 81)					
68x30x13mm	NULL				

## NISSAN ALMERA-ALMERA TINO-N15-N16-B10



	<b>A1857</b>	NO. 113204M400 - 11320BM500 - 11320-4M400		<b>F1260-I</b>	NO. 39741-OM325
	APOIO DO MOTOR PARTE DE TRÁS			FOLE DA TRANSMISSÃO JUNTO À CAIXA	
NISSAN ALMERA II Hatchback (N16) 1.5 (APÓS 10.02) 98CV 1497CC - NISSAN ALMERA II Hatchback (N16) 1.5 (APÓS 03.00) 90CV 1498CC - NISSAN ALMERA II Hatchback (N16) 1.8 (APÓS 01.00) 114CV 1769CC - NISSAN ALMERA II Hatchback (N16) 1.8 (APÓS 10.02) 116CV 1769CC			NISSAN ALMERA (1) 2.0i GTi (1996 A 2000)		
135x100x60mm	1f-d10mm		d92x91mm	1f-d81mm 1f-d22mm	
	<b>KF1635</b>	NO. 3924101E25 - 3924101E00 - 3924101E26 - 3924101E27 - 3924101E28 - 3924101E29 - 3924101E85 - 3924101E8...		<b>KF1665</b>	NO. 39241-5M325 - 39241-9E025
	KIT DE FOLE DO CARDAN LADO DA RODA			KIT DE FOLE DO CARDAN JUNTO À RODA	
NISSAN ALMERA I 1.6i (07-95 A 09-99) - 2.0D (09-95 A 09-99) - ALMERA II 1.6i (APÓS 09-99) - 1.8i (02-00 A 08-02) - 20i (APÓS 09-99)			NISSAN ALMERA 2 (APÓS 2000) 2.2i		
d97x96mm	1f-d86mm 1f-d22mm		d100x82mm	1f-d84mm 1f-d25mm	
	<b>KF1683-T</b>	NO. 39241-5V125 - 39241-8V125		<b>KF1684-T</b>	NO. 39241-BM725 - 39241-BM726
	KIT DE FOLE DO CARDAN JUNTO À RODA E CAIXA			KIT DE FOLE DO CARDAN JUNTO À RODA	
NISSAN ALMERA 2 1.8i (APÓS 2000) - ALMERA TINO 1.8i - 2.0i (APÓS 2000)			NISSAN ALMERA 2 (APÓS 2000) 1.5 Dci - 1.8i ALMERA TINO (APÓS 2000) 1.8i		
d103x111mm	1f-d97mm 1f-d28mm		d96x123mm	1f-d83mm 1f-d23mm	



	<p><b>S1548</b> NO. 54570-4M400</p> <p>SILENT-BLOC DO BRAÇO DA SUSPENSÃO DA FRENTE PARTE INFERIOR NISSAN ALMERA N16 (APÓS 2001)</p> <p>d49,3x38mm c32mm 1f-d21mm</p>		<p><b>T1028</b> NO. 55149-50A00</p> <p>BATENTE DA BARRA ESTABILIZADORA DE TRÁS (CENTRO) NISSAN ALMERA</p> <p>58x57x40mm 1f-d23mm</p>
	<p><b>T1145</b> NO. 54613-4M420 - 54613BM400 - 54613-4Z000</p> <p>BATENTE DA BARRA ESTABILIZADORA DA FRENTE</p> <p>NISSAN ALMERA I Hatchback (N15) 1.4 S - GX - LX (09.95 A 03.00) 75CV 1392CC - NISSAN ALMERA I Hatchback (N15) 1.4 (09.95 A 03.00) 87CV 1392CC - NISSAN ALMERA I Hatchback (N15) 1.6 SR - SLX (09.95 A 03.00) 90CV 1597CC - NISSAN ALMERA I Hatchback (N15) 1.6 (09.95</p> <p>36x37x40mm 1f-d19mm</p>		<p><b>T1155</b> NO. 546132Y003 - 546134U006 - 54613AU004</p> <p>BATENTE DA BARRA ESTABILIZADORA DA FRENTE</p> <p>NISSAN ALMERA TINO (V10) 1.8 (APÓS 08.00) 114cv 1769cc Veículo multiuso - NISSAN ALMERA TINO (V10) 1.8 (APÓS 12.02) 116cv 1769cc Veículo multiuso - NISSAN ALMERA TINO (V10) 2.0 (APÓS 08.00) 136cv 1998cc Veículo multiuso - NISSAN ALMERA TINO (V10) 2.2 dCi (APÓS 09.03) 112cv 2184cc Veículo multiuso - NISSAN ALMERA TINO (V10) 2.2 Di (APÓS 08.00) 115cv 2184cc Veículo multiuso - NISSAN ALMERA TINO (V10) 2.2 dCi (APÓS 09.03) 136cv 2184...etc.</p> <p>36x49x46mm 1f-d23mm</p>
	<p><b>W5106</b> NO. 1230300QAY - 1230300QAU - 1230900QAG - 1220100QAW</p> <p>POLIE DA CAMBOTA (6 PISTAS)</p> <p>NISSAN ALMERA II 1.5 Dci (K9K 722) 82CV (APÓS 01-2003)</p> <p>d155/151mm d26mm</p>		











## NISSAN AUSTER-VIOTEL-STANZA

	<p><b>E0044</b> NO. 846082</p> <p>ESTICADOR DE ESCAPE</p> <p>NISSAN STANZA (82 A 86)</p> <p>77x58x20mm NULL</p>		<p><b>E1034</b> NO. 20650D0100 - 20650V5000 - 20650V5200 - 2065041L00 - 206509C000 - 2066029R00</p> <p>ESTICADOR DE ESCAPE</p> <p>NISSAN STANZA (1982 A 1986)</p> <p>72x62x35mm 2f-d11mm</p>
	<p><b>F1200-I</b> NO. 39241-01E25 - 39241-01E27 - 39241-01E28 - 39241-0M326 - 39241-64J25 - 39241-63Y25 - 39241-01E26 - 39241-01E28 - 39241-01E26 - 39241-01E88 - 39741-01E28 - 39741-01E26 - 39741-01E89</p> <p>FOLE DA TRANSMISSÃO LADO DA RODA</p> <p>NISSAN AUSTER 1.6 - 1.8 - STANZA 1.6 - 1.8</p> <p>d97x96mm 1f-d86mm 1f-d22mm</p>		<p><b>F1200-I</b> NO. 39241-01E25 - 39241-01E27 - 39241-01E28 - 39241-0M326 - 39241-64J25 - 39241-63Y25 - 39241-01E26 - 39241-01E28 - 39241-01E26 - 39241-01E88 - 39741-01E28 - 39741-01E26 - 39741-01E89</p> <p>FOLE DA TRANSMISSÃO LADO DA RODA</p> <p>NISSAN PRAIRIE 2.0 4x4 (06-1986 A 09-1988) - PRO 2.4i (04-1992 A 07-1994) - PRO 2.4i 4x4 (04-1992 A 07-1994)</p> <p>d97x96mm 1f-d86mm 1f-d22mm</p>
	<p><b>F1201-I</b> NO. 39741-01E25 - 39741-01E00 - 39741-01E88 - 39741-01E28 - 39741-01E26 - 39741-01E89</p> <p>FOLE DA TRANSMISSÃO LADO DA CAIXA</p> <p>NISSAN VIOLET 1.6 - AUSTER 1.6 - 1.8 MT - 1.8 AT - STANZA 1.6 - 1.8MT - 1.8 AT</p> <p>d95x100mm 1f-d84mm 1f-d22mm</p>		<p><b>F1203-I</b> NO. 39741-10E00 - 39741-10E25</p> <p>FOLE DA TRANSMISSÃO LADO DA CAIXA</p> <p>NISSAN VIOLET - AUSTER - STANZA 1.8 AT</p> <p>d102x103mm 1f-d90mm 1fd24mm</p>
	<p><b>KF1691</b> NO. 39241-01E29 - 39741-4F125</p> <p>KIT DE FOLE DO CARDAN JUNTO À RODA</p> <p>NISSAN STANZA 1.6 (08-1981 A 12-1985) - 1.8 (1981 A 1985)</p> <p>d94x95mm 1f-d80mm 1f-d21mm</p>		

	<b>F1200-I</b>	NO. 39241-01E25 - 39241-01E27 - 39241-01E28 - 39241-0M326 - 39241-64J25 - 39241-63Y25 - 39241-01E26 - 39241-01E28		<b>F1203-I</b>	NO. 39741-10E00 - 39741-10E25
	FOLE DA TRANSMISSÃO LADO DA RODA			FOLE DA TRANSMISSÃO LADO DA CAIXA	
NISSAN AVENIR 1.5 - 1.6 - 1.7 - 1.8 4WD			NISSAN AVENIR 2.0		
d97x96mm		1f-d86mm 1f-d22mm		d102x103mm	
1f-d95mm 1f-d23mm		1f-d90mm 1fd24mm			
	<b>KF1645</b>	NO. 3824101E26 - 3924110E02			
	KIT DE FOLE				
NISSAN AVENIR 2.0 MTM					
d108x92mm		1f-d95mm 1f-d23mm			

NISSAN BLUEBIRD-U12-U13-U14-910





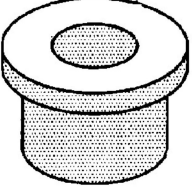
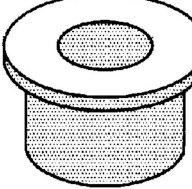
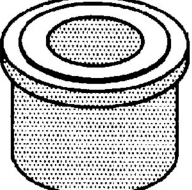







	<b>A1247</b>	NO. 37521-W1025 - 37521-W1027 - 37521-W1625 - 37521-Q0125 - 37521-W1000 - 37521-W1026 - 37521-P0125		<b>E0044</b>	NO. 8033989089591
	APOIO DO VEIO DA TRANSMISSÃO			ESTICADOR DE ESCAPE	
NISSAN BLUEBIRD 910 MOTOR LD20 4WD - 2WD187			NISSAN BLUEBIRD (APÓS 83)		
d110x51mm		1f-d30mm		77x58x20mm	
1f-d30mm		2p-d9-20mm		NULL	
	<b>E0195</b>	NO. 56261-OE000		<b>E1021</b>	NO. 20650-50A00 - 20650-70A10 - 20651-90J02 - 20650-60V00
	ESTICADOR DA BARRA ESTABILIZADORA DE TRÁS			ESTICADOR DE ESCAPE	
NISSAN BLUEBIRD U12 - U13			NISSAN BLUEBIRD		
125x27x27mm		2p-d9-20mm		68x49x23mm	
2p-d9-20mm		2f-d11mm		NULL	
	<b>E1034</b>	NO. 20650D0100 - 20650V5000 - 20650V5200 - 2065041L00 - 206509C000 - 2066029R00		<b>F1200-I</b>	NO. 39241-01E25 - 39241-01E27 - 39241-01E28 - 39241-0M326 - 39241-64J25 - 39241-63Y25 - 39241-01E26 - 39241-01E28
	ESTICADOR DE ESCAPE			FOLE DA TRANSMISSÃO LADO DA RODA	
NISSAN BLUEBIRD (1984 A 1990)			NISSAN BLUEBIRD 1.6 - 1.8 - 2.0		
72x62x35mm		2f-d11mm		d97x96mm	
2f-d11mm		1f-d84mm 1f-d22mm		1f-d86mm 1f-d22mm	
	<b>F1201-I</b>	NO. 39741-01E25 - 39741-01E00 - 39741-01E88 - 39741-01E28 - 39741-01E26 - 39741-01E89		<b>F1202-I</b>	NO. 39241-10E25 - 39241-10E26
	FOLE DA TRANSMISSÃO LADO DA CAIXA			FOLE DE TRANSMISSÃO JUNTO À RODA	
NISSAN BLUEBIRD 1.6 - 1.8AT - 1.8 MT - 2.0 MT			NISSAN BLUEBIRD 1.8 - 2.0		
d95x100mm		1f-d84mm 1f-d22mm		d109x96mm	
1f-d84mm 1f-d22mm		1f-d95mm 1f-d23mm		1f-d95mm 1f-d23mm	
	<b>F1203-I</b>	NO. 39741-10E00 - 39741-10E25		<b>F1333-I</b>	NO. 48203-10V00 - 48203-10V25 - 48203-33P00 - 48203-33P01 - 48203-41B27 - 48204-53Y25 - 48203-50Y25 - 48203-50Y25 - 48203-50Y25
	FOLE DA TRANSMISSÃO LADO DA CAIXA			FOLE DIREÇÃO ASSISTIDA DIREITO E ESQUERDO	
NISSAN BLUEBIRD 1.8 TURBO T12-18 ET - 2.0 U11-LD 20T - 2.0 U11-CA20S - 2.0 E-WHU12			NISSAN BLUEBIRD 1.6 - 1.8 4WD		
d102x103mm		1f-d90mm 1fd24mm		d66x145mm	
1f-d90mm 1fd24mm		1f-d37mm 1f-d9mm		1f-d37mm 1f-d9mm	

	<b>F4006</b> NO. 30542-E9000 - 30542-03E10 FOLE DA EMBRAIAGEM NISSAN BLUEBIRD 910 94x54x49mm NULL		<b>KF1625</b> NO. 3924103A25 - 3924103A26 KIT DE FOLE DO CARDAN JUNTO À RODA NISSAN BLUEBIRD 1.6 (1983 A 1990) d91x86mm 1f-d20mm 1f-d75mm
	<b>KF1635</b> NO. 3924101E25 - 3924101E00 - 3924101E26 - 3924101E27 - 3924101E28 - 3924101E29 - 3924101E85 - 3924101E8... KIT DE FOLE DO CARDAN LADO DA RODA NISSAN BLUEBIRD 1.6 (12-1983 A 02-1986) - 1.8 (04-1984 A 02-1986) - 2.0 (09-1987 A 05-1988) - 2.0I (09-1987 A 05-1990) - 2.0I - WAGON (09-1987 A 10-1990) - 2.0D (04-1984 A 10-1990) - 2.0D WAGON (02-1986 A 10-1990) - 2.0 TD (04-1984 A 02-1986) d97x96mm 1f-d86mm 1f-d22mm		<b>KF1645</b> NO. 3824101E26 - 3924110E02 KIT DE FOLE DO CARDAN JUNTO À RODA NISSAN BLUEBIRD 1.8 - 2.0 - 2.0i - 2.0D (1983 A 1990) d108x92mm 1f-d95mm 1f-d23mm
	<b>KF1691</b> NO. 39241-01E29 - 39741-4F125 KIT DE FOLE DO CARDAN JUNTO À RODA NISSAN BLUEBIRD 1.6 - 1.8 - 2.0 - 2.0D - 2.0i - 2.0TD (1983 A 1990) d94x95mm 1f-d80mm 1f-d21mm		<b>L1071</b> NO. 54477-G8010 CASQUILHO DA BARRA DE TORÇÃO NISSAN BLUEBIRD 910 d51x27mm 1f-d16mm
	<b>L1072</b> NO. 54476-G8010 CASQUILHO DA BARRA DE TORÇÃO NISSAN BLUEBIRD 910 d50x30mm 1f-d16mm		<b>L3030</b> NO. 48544-H1000 CASQUILHO DO PENDURAL DA DIREÇÃO NISSAN BLUEBIRD d32x19mm 1f-d16mm
	<b>M6040</b> NO. 20711-01E00 - 20691-01E80 JUNTA DE ESCAPE NISSAN BLUEBIRD (1984 A 1990) 102x100mm 1f-d58mm		<b>M6105</b> NO. 20692-M3060 - 20692-V6200 - 20692-31G02 - 20692-M3080 JUNTA DE ESCAPE NISSAN BLUEBIRD (1980 A 1990) 116x80x2mm 1f-d49mm
	<b>R8006</b> NO. 21503-B5010 TUBO INFERIOR DO RADIADOR NISSAN 620 1.5 (1972 A 1979) B260-d34/34mm 75-200100mm		<b>R8006</b> NO. 21503-B5010 TUBO INFERIOR DO RADIADOR NISSAN BLUEBIRD 1.3 (1965 A 1967) B260-d34/34mm 75-200100mm
	<b>R8016</b> NO. V9600 TUBO SUPERIOR DO RADIADOR NISSAN BLUEBIRD 910 SÉRIE 1 2.0 (1981 A 1983) - U9600-720 (ATÉ 1980) B260-d34/34mm 85-110-85mm		<b>R8121</b> NO. 21501-W2300 TUBO SUPERIOR DO RADIADOR NISSAN BLUEBIRD 1800CC B270-d32/32mm 110-140-70mm
	<b>S1453</b> NO. 54590-01E00 SILENT-BLOC DO BRACO DA SUSPENSÃO DA FRENTE PARTE INFERIOR NISSAN BLUEBIRD U11 - U12 d38.6x50mm c40mm 1f-d18.2mm		<b>T1028</b> NO. 55149-50A00 BATENTE DA BARRA ESTABILIZADORA DE TRÁS (CENTRO) NISSAN B12 - N13 (1986 A 1990) - SUNNY - SENTRA 58x57x40mm 1f-d23mm

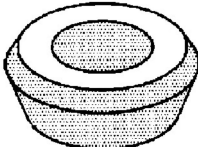
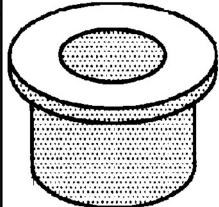
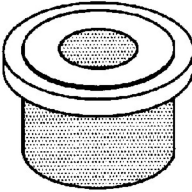
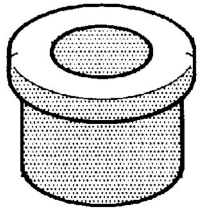
	<b>L1024</b> NO. 35129-4401-P CASQUILHO DE MOLAS FRENTE NISSAN CABALL		<b>L1025</b> NO. CASQUILHO DE MOLAS TRÁS NISSAN CABALL
	d41x44mm d32mm 1f-d19mm		d46x44mm d36mm 1f-d21mm
	<b>L1026</b> NO. 55046-76000 CASQUILHO DE MOLAS TRÁS NISSAN CABALL		
	d36x42mm d32mm 1f-d19mm		

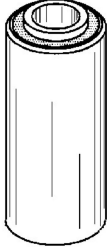
NISSAN CABSTAR

	<b>A1023</b> NO. 55207-T9021 APOIO BATENTE DE MOLA NISSAN CABSTAR F22 - BH40 - H40		<b>A1249</b> NO. 37520-77200 - 37521-J2100 - 37521-J5125 APOIO DO VEIO DA TRANSMISSÃO NISSAN CABALL
	98x85x30mm 1p-d8-20mm		120x120x62mm 1f-d30mm
	<b>A1249</b> NO. 37520-77200 - 37521-J2100 - 37521-J5125 APOIO DO VEIO DA TRANSMISSÃO NISSAN CABSTAR		<b>A1260</b> NO. 11220-T6010 - 11220-T6000 SUPORTE DA FRENTE DO MOTOR ESQUERDO E DIREITO NISSAN CABSTAR F22 MOTOR TD25 - BH 40 FD35
	120x120x62mm 1f-d30mm		105x55x49mm 2p-d10-22mm
	<b>A1364</b> NO. 11321-T7211 SUPORTE DA CAIXA TRÁS ESQUERDO NISSAN CABSTAR F22		<b>A1365</b> NO. 11320-T7211 SUPORTE DA CAIXA TRÁS DIREITO NISSAN CABSTAR F22
	110x75x40mm 1p-d10-25mm 1p-d8-21mm		110x75x40mm 1p-d10-25mm 1p-d8-21mm
	<b>A1517</b> NO. 11320-W1001 APOIO MOTOR PARTE DE TRÁS(CAIXA) NISSAN CABSTAR		<b>A1676</b> NO. 55060-T3201 APOIO BATENTE DA SUSPENSÃO DE TRÁS NISSAN CABSTAR F22
	130x95x50mm 4p-d8-16mm		145x132x65mm 2p-d10-24mm
	<b>A1714</b> NO. 54050-T3061 APOIO BATENTE DA SUSPENSÃO DA FRENTE NISSAN CABSTAR F22 - E23 - E24		<b>A1793</b> NO. APOIO BATENTE DE MOLA NISSAN CABSTAR
	180x65x65mm 2f-d12mm		84x55x25mm 2p-d8x27mm

	<b>A1796</b> NO. 11220-T6010 APOIO DO MOTOR PARTE DA FRENTE NISSAN CABSTAR (F22) 105x72x54mm 2p-d12mm		<b>E0032</b> NO. 42013-0101P ESTICADOR DE ESCAPE NISSAN CABSTAR (APÓS 1985) 68x30x13mm NULL
	<b>F4006</b> NO. 30542-E9000 - 30542-03E10 FOLE DA EMBRAIAGEM NISSAN CABSTAR F22 MOTOR TD25 94x54x49mm NULL		<b>F4006</b> NO. 30542-E9000 - 30542-03E10 FOLE DA EMBRAIAGEM NISSAN CABSTAR F22 MOTOR TD25 - CABSTAR DH40 94x54x49mm NULL
	<b>F4027</b> NO. FOLE RESGUARDO DAS RÓTULAS NISSAN CABSTAR d48x30mm 1f-d40mm 1f-d17mm		<b>F4029</b> NO. 75949T7800 FOLE DA ALAVANCA DE VELOCIDADES NISSAN CABSTAR 145x130x80mm 1f-d18mm
	<b>L1005</b> NO. 56119-T9300 CASQUILHO DE AMORTECEDORES NISSAN CABSTAR F22 - BH40 - N10 - N12 - NL10 - NL12 d47x26mm d37mm 1f-d24mm		<b>L1012</b> NO. CASQUILHO DE MOLAS FRENTE NISSAN CABSTAR d36x37mm d30mm 1f-d18mm
	<b>L1031</b> NO. 55045-T3000 CASQUILHO DE MOLA NISSAN CABSTAR F22 d44x46mm d35mm 1f-d18mm		<b>L1063</b> NO. 35129-4401P - 54041-76001 CASQUILHO DE MOLAS TRÁS NISSAN CABSTAR RODADO DUPLO d37x44mm d32mm 1f-d20mm
	<b>L1073</b> NO. 35129-6403P CASQUILHO DE MOLAS DE TRÁS (PEQUENO) NISSAN CABSTAR RODADO SIMPLES d32x44mm d28mm-1f-d17mm		<b>M6040</b> NO. 20711-01E00 - 20691-01E80 JUNTA DE ESCAPE NISSAN CABSTAR (APÓS 1987) 102x100mm 1f-d58mm
	<b>S1044</b> NO. 55045G9500 SILENT-BLOC DE MOLAS NISSAN CABSTAR d33x73mm c65mm 1f-d16mm		<b>S1208</b> NO. SILENT-BLOC DAS MOLAS DE TRÁS PARTE DA FRENTE NISSAN CABSTAR d45x77mm c65mm 1f-d24mm
	<b>S1314</b> NO. 31027-0401P SILENT-BLOC DA BARRA DE TORÇÃO NISSAN CABSTAR d39x80mm d24mm 1f-d16mm		<b>S1495</b> NO. SILENT BLOC DAS MOLAS DE TRÁS PARTE DA FRENTE NISSAN CABSTAR E d45x77mm c65mm 1f-d16mm



	<b>KF1645</b>	NO. 3824101E26 - 3924110E02		<b>L3070</b>	NO. 55046B8460
	KIT DE FOLE NISSAN CARAVAN - HOMOY			CASQUILHO NISSAN CARAVAN (E20)	
d108x92mm		1f-d95mm 1f-d23mm	d37x35mm		d33mm 1f-d15mm

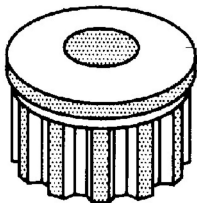

NISSAN CEDRIC







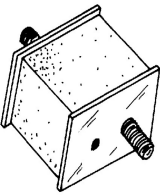

	<b>L1028</b>	NO. 55045-P0101		
	CASQUILHO DE MOLAS NISSAN DATSUN 2200 CEDRIC			
d38x43mm		d36mm 1f-d15mm		

NISSAN CEFIRO

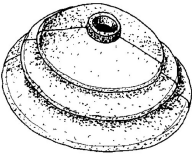
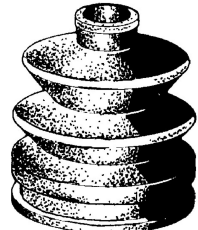
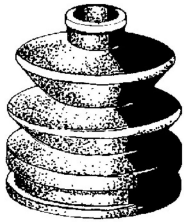
	<b>KF1625</b>	NO. 3924103A25 - 3924103A26		<b>S1428</b>	NO. 55136-0M000
	KIT DE FOLE DO CARDAN JUNTO À RODA NISSAN CEFIRO 4WD			SILENT-BLOC DO BRAÇO DA SUSPENSÃO DA FRENTE PARTE TRÁS NISSAN CEFIRO - A32 - B14	
d91x86mm		1f-d20mm 1f-d75mm	d35x45mm		d30.8mm 1f-d12.2mm
	<b>S1440</b>	NO. 55045-0M000			
	SILENT-BLOC DO BRAÇO DA SUSPENSÃO DA FRENTE PARTE TRÁS NISSAN CEFIRO - A32 - B14				
d60x60mm		c38.5mm 1f-d12.5mm			

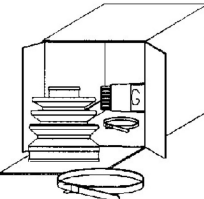
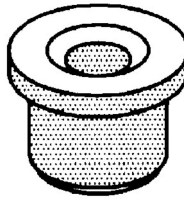
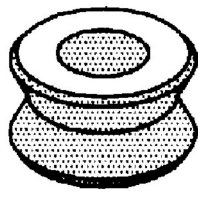
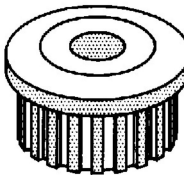
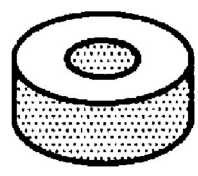
NISSAN CHERRY-DATSUN 100A-DATSUN 120A-DATSUN 1200

	<b>A0871</b>	NO. 11223-H1000		<b>E0038</b>	NO. 20650-50A00 - 20650-70A10 - 20651-90J02 - 20650-60V00
	SUPORTE DO MOTOR DIREITO E ESQUERDO NISSAN DATSUN 1200 B110			ESTICADOR DE ESCAPE NISSAN CHERRY (82 A 86)	
51x45x41mm		2p-d8-18mm	60x42x19mm		NULL

	<p><b>E0044</b> NO. 1232415013</p> <p>ESTICADOR DE ESCAPE</p> <p>NISSAN CHERRY (82 A 86)</p> <p>77x58x20mm NULL</p>		<p><b>E1015</b> NO. 20641-M6810 - 20641-M7060 - 20641-58100 - 20641-U6800 - 20641-U6810</p> <p>ESTICADOR DE ESCAPE</p> <p>NISSAN CHERRY (1980 A 1982)</p> <p>59x50x46mm 2p-d8-18mm</p>
	<p><b>E1034</b> NO. 20650D0100 - 20650V5000 - 20650V5200 - 2065041L00 - 206509C000 - 2066029R00</p> <p>ESTICADOR DE ESCAPE</p> <p>NISSAN CHERRY (1982 A 1986)</p> <p>72x62x35mm 2f-d11mm</p>		<p><b>F0143</b> NO.</p> <p>FOLE DA ALAVANCA DE VELOCIDADES</p> <p>NISSAN DATSUN 1200</p> <p>d110x36mm 1f-d13mm</p>
	<p><b>F0511-I</b> NO. 44315-SA2-003 - 44315-SA5-003 - 44325-SB0-300 - 39155-M7270</p> <p>FOLE DO SEMI-EIXO EXTERNO</p> <p>NISSAN CHERRY (10-70 A 9-74) - CHERRY 1.4(APOS 74 A 78) - 1.5</p> <p>d89x91mm 1f-d75mm 1f-d21mm</p>		<p><b>F0706-I</b> NO. 39741-11M00 - 40088-M0820 - 40089-M0825</p> <p>FOLE DO SEMI-EIXO INTERNO</p> <p>NISSAN CHERRY 1.2 (KPE10) (10-70 A 9-74) - CHERRY 1.4 (74 A 78) - PULSAR - LANGLEY - LIVERTA - VILLA 1.4 - 1.5 (78 A 82) - SUNNY - LAUREL - SPRINT 1.5(APOS 10-81)</p> <p>d89x92mm 1f-d76mm 1f-d22mm</p>
	<p><b>F1201-I</b> NO. 39741-01E25 - 39741-01E00 - 39741-01E88 - 39741-01E28 - 39741-01E26 - 39741-01E89</p> <p>FOLE DA TRANSMISSÃO LADO DA CAIXA</p> <p>NISSAN CHERRY</p> <p>d95x100mm 1f-d84mm 1f-d22mm</p>		<p><b>KF1625</b> NO. 3924103A25 - 3924103A26</p> <p>KIT DE FOLE DO CARDAN JUNTO À RODA</p> <p>NISSAN CHERRY 1.5</p> <p>d91x86mm 1f-d20mm 1f-d75mm</p>
	<p><b>KF1640</b> NO. 39241-11M00 - 39241-11M25 - 39241-11M26</p> <p>KIT FOLE DO LADO DA RODA</p> <p>NISSAN CHERRY 1.0 - 1.3</p> <p>d90x85mm 1f-d74mm 1f-d22mm</p>		<p><b>L0237</b> NO. 55047-H1000</p> <p>CASQUILHO DE MOLAS (TRÁS DO OLHAL DA FRENTE)</p> <p>NISSAN DATSUN 1200</p> <p>d30x34mm d23mm 1f-d11mm</p>
	<p><b>L0329</b> NO. 54476-W5000 - 54476-W5001</p> <p>CASQUILHO</p> <p>NISSAN DATSUN 1200</p> <p>d38x26mm 1f-d16mm</p>		<p><b>L1002</b> NO. 55045-H1000</p> <p>CASQUILHO DE MOLAS (TRÁS DO OLHAL DE TRÁS)</p> <p>NISSAN DATSUN 1200 B110 - B210</p> <p>d40x37mm d34mm 1f-d12mm</p>
	<p><b>L1008</b> NO. 56125-18000</p> <p>CASQUILO DA BARRA ESTABILIZADORA</p> <p>NISSAN DATSUN 1200 - 100A - 120Y</p> <p>d21x14mm 1f-d8mm</p>		<p><b>L3017</b> NO. 20136B5001 - 20136M7080</p> <p>CASQUILHO DE ESCAPE</p> <p>NISSAN CHERRY (1980 A 1986)</p> <p>NULL NULL</p>
	<p><b>L3018</b> NO. 20136B5001 - 20136M7080</p> <p>CASQUILHO DE ESCAPE</p> <p>NISSAN CHERRY (1980 A 1986)</p> <p>NULL NULL</p>		<p><b>M6105</b> NO. 20692-M3060 - 20692-V6200 - 20692-31G02 - 20692-M3080</p> <p>JUNTA DE ESCAPE</p> <p>NISSAN CHERRY (1985 A 1987)</p> <p>116x80x2mm 1f-d49mm</p>

	<b>P0003-R</b> NO. 46531-M3000 CAPA DE PEDAL TRAVÃO E EMBRAIAGEM NISSAN DATSUN 1200		<b>R0590</b> NO. 21501-H1000 TUBO SUPERIOR DO RADIADOR NISSAN DATSUN 1200
	76x50x11mm NULL		B160-d27/27mm 75-100-75mm
	<b>R0778-M</b> NO. TUBO SUPERIOR DO RADIADOR NISSAN DATSUN-100A		<b>R8005</b> NO. 21506 - H1101 TUBO INFERIOR DO RADIADOR (COMPLETO COM LIGAÇÃO METÁLICA) NISSAN DATSUN 1200
	B180-d27/27mm 75-105-85-50mm		B380-d25/26mm NULL
	<b>T1102</b> NO. 54613-R0400 - 54613-A0100 BATEANTE DA BARRA ESTABILIZADORA NISSAN DATSUN 1200		<b>T1108</b> NO. 54613-V0102 BATEANTE DA BARRA ESTABILIZADORA NISSAN DATSUN 1200
	32x29x39mm 1f-d21mm		28x34x42mm 1f-d22mm

NISSAN D22

	<b>A1247</b> NO. 37521-W1025 - 37521-W1027 - 37521-W1625 - 37521-Q0125 - 37521-W1000 - 37521-W1026 - 37521-P0125 APOIO DO VEIO DA TRANSMISSÃO NISSAN DS22 4WD		
	d110x51mm 1f-d30mm		

NISSAN EBRO

	<b>S1168</b> NO. SILENT-BLOC DE MOLAS NISSAN EBRO (CAMIÃO)		
	d45x92.5mm c80mm 1f-d20mm		

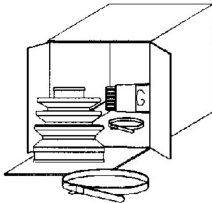
	<b>KF1640</b> NO. 39241-11M00 - 39241-11M25 - 39241-11M26 KIT FOLE DO LADO DA RODA NISSAN FIGARO		
	d90x85mm 1f-d74mm 1f-d22mm		

## NISSAN INTERSTAR





	<b>F1827A-I</b> NO. 40089-00QAA - 40089-00QAF FOLE DA TRANSMISSÃO JUNTO À CAIXA NISSAN INTERSTAR 1.9 DCi - 2.2 DCi - 2.5 DCi (APÓS 2002)		<b>W5083</b> NO. 12303AW300 - 12309AW300 POLIE DA CAMBOTA (7 PISTAS) NISSAN INTERSTAR Autocarro (X70) - dCi 90 90CV 2188cc (APÓS 07-2002) - Dci 100 99cv 2463cc (APÓS 11-2003) - dCi 100 101CV 2464cc (APÓS 04-2006) - dCi 120 120CV 2464cc (APÓS 09-2006) - dCi 150 145CV 2464cc (APÓS 09-2006) - INTERSTAR Caixa (X70) - dCi 90
	d115x85mm 1f-d81mm 1f-d27.8mm		d152/162mm d30/58mm

## NISSAN JUKE

	<b>T1158</b> NO. 54613JD03A - 54613JG03A BATENTE DA BARRA ESTABILIZADORA DA FRENTE NISSAN JUKE (F15) 1.6 DIG-T 06.10 - 140 190 1618 Hatchback NISSAN JUKE (F15) 1.6 DIG-T NISMO (03.13 A 07.14) 200cv 1618cc Hatchback - NISSAN JUKE (F15) 1.6 DIG-T NISMO 4x4 (02.13 A 07.14) 200cv 1618cc Hatchback - NISSAN JUKE (F15) 1.6 DIG-T NISMO RS 4x4 (APÓS 08.14) 214cv 1618cc Hatchback - NISSAN JUKE (F15) 1.6 DIG-T NISMO RS (APÓS 08.14) 218cv 1618cc Hatchback - NISSAN JUKE (F15) 1.5 dCi (APÓS 06.10) 110cv 1461cc Hatchback		
	74x47x34mm 1f-d23mm		

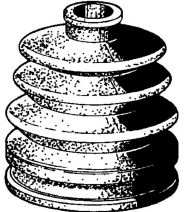
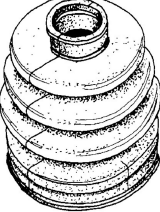
## NISSAN KUBISTAR



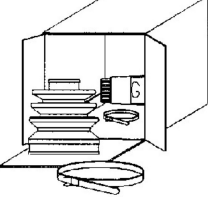









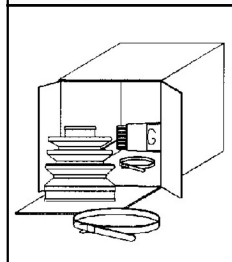

	<b>F1827A-I</b> NO. 40089-00QAA - 40089-00QAF FOLE DA TRANSMISSÃO JUNTO À CAIXA NISSAN KUBISTAR 1.2i - 1.4i - 1.5 DCi - 1.6i 16V - 1.9 DCi (APÓS 2002)		<b>KF2528-T</b> NO. 40088-00QAG - 329319 - GG09-22-530 - GG09-22-530A KIT DE FOLE DO CARDAN JUNTO À RODA NISSAN KUBISTAR 1.2i - 1.4i - 1.5 DCi - 1.6i 16V - 1.9 DCi (APÓS 2003)
	d115x85mm 1f-d81mm 1f-d27.8mm		d90x140mm 1f-d80mm 1f-d25mm
	<b>Q2009</b> NO. UNIÃO DE ESCAPE 48/45x80mm NISSAN - KUBISTAR (X76) - 1.2 16V (04.06 - 10.09) 75cv 1149cc Veículo multiuso - NISSAN - KUBISTAR (X76) - 1.5 dCi (08.03 - 10.09) 57cv 1461cc Veículo multiuso - NISSAN - KUBISTAR (X76) - 1.5 dCi (08.03 - 10.09) 65cv 1461cc Veículo multiuso - NISSAN - K		
	80x77x55mm 1f-d45/48mm		





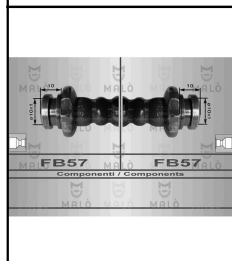

	<p><b>E1015</b> NO. 20641-M6810 - 20641-M7060 - 20641-58100 - 20641-U6800 - 20641-U6810</p> <p>ESTICADOR DE ESCAPE</p> <p>NISSAN LAUREL</p>		<p><b>F0512-I</b> NO. 39241-01B25 - 39241-01M00 - 39241-01M29 - 39241-11M00 - 39241-11M25</p> <p>FOLE DO SEMI-EIXO EXTERNO</p> <p>NISSAN LAUREL - SPIRIT 1.5 (APÓS 7-1984)</p>
	<p><b>F0694-I</b> NO. 39241-16R00 - 39241-16R25</p> <p>FOLE DO SEMI-EIXO EXTERNO</p> <p>NISSAN LAUREL - SPIRIT B11 (09-1985 A 09-1987)</p>		<p><b>F1201-I</b> NO. 39741-01E25 - 39741-01E00 - 39741-01E88 - 39741-01E28 - 39741-01E26 - 39741-01E89</p> <p>FOLE DA TRANSMISSÃO LADO DA CAIXA</p> <p>NISSAN LAUREL SPIRIT NY100</p>
	<p><b>F1212-I</b> NO. 39741-02A25</p> <p>FOLE DA TRANSMISSÃO LADO DA CAIXA</p> <p>NISSAN LAUREL-SPIRIT 4-83-7-84 - PULSAR 1.3-1.4 4-83-7-84 - SENTRA 1.3 (1983 A 1985) - SUNNY 1.3 - 1.4 B11</p>		<p><b>KF1625</b> NO. 3924103A25 - 3924103A26</p> <p>KIT DE FOLE DO CARDAN JUNTO À RODA</p> <p>NISSAN LAUREL SPIRIT - DATSUN AD VAN</p>
	<p><b>KF1640</b> NO. 39241-11M00 - 39241-11M25 - 39241-11M26</p> <p>KIT FOLE DO LADO DA RODA</p> <p>NISSAN LAUREL SPIRIT 1.3 - 1.5 AD - 1.3 - 1.5 - SUNNY PULSAR</p>		

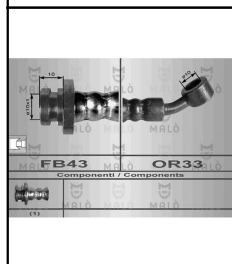
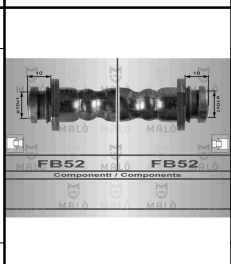
NISSAN MAXIMA

	<p><b>F1203-I</b> NO. 39741-10E00 - 39741-10E25</p> <p>FOLE DA TRANSMISSÃO LADO DA CAIXA</p> <p>NISSAN MAXIMA 2.0 - 3.0</p>		<p><b>F1619-I</b> NO. 48204-42L00 - 48204-42L25</p> <p>FOLE DIREÇÃO ASSISTIDA LADO ESQUERDO</p> <p>NISSAN MAXIMA - LAUREL - BLUEBIRD - AUSTER - STANZA</p>
	<p><b>F1620-I</b> NO. 48203-0500 - 48203-05F26</p> <p>FOLE DIREÇÃO ASSISTIDA LADO DIREITO</p> <p>NISSAN MAXIMA - LAUREL - BLUEBIRD - AUSTER - STANZA</p>		<p><b>KF1645</b> NO. 3824101E26 - 3924110E02</p> <p>KIT DE FOLE</p> <p>NISSAN MAXIMA 2.0 - 3.0</p>
	<p><b>KF1683-T</b> NO. 39241-5V125 - 39241-8V125</p> <p>KIT DE FOLE DO CARDAN JUNTO À RODA E CAIXA</p> <p>NISSAN MAXIMA QX 2.0i - 3.0i (APÓS 2000)</p>		<p><b>M6091</b> NO.</p> <p>JUNTA DE ESCAPE</p> <p>NISSAN MAXIMA (APÓS 1988)</p>

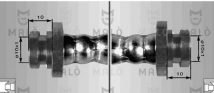
	<p><b>A1856</b> NO. 11210-01B01</p> <p>APOIO DO MOTOR PARTE DA FRENTE</p> <p>NISSAN MICRA II (K11) 1.0 i 16V Hatchback (08.92 A 09.00) 54CV 998CC - NISSAN MICRA II (K11) 1.0i 16V Hatchback (09.00 A 02.03) 60CV 998CC - NISSAN MICRA II (K11) 1.3 i 16V Hatchback (08.92 A 09.00) 75CV 1275CC - NISSAN MICRA II (K11) 1.4 i 16V Hatchback</p> <p>95x86x64mm 2f-d14mm 1f-d11,5mm</p>		<p><b>A1908</b> NO. 11320-99B11 - 11320-41B01 - 11320-99B05 - 11320-99B15 - 11320-44B01 - 11320-99B00</p> <p>APOIO DO MOTOR PARTE DE TRÁS LADO DA CAIXA</p> <p>NISSAN MICRA II (K11) 1.0 i 16V (08.92 - 09.00) 54cv 998cc Hatchback - NISSAN MICRA II (K11) 1.0 i 16V (09.00 - 02.03) 60cv 998cc Hatchback - NISSAN MICRA II (K11) 1.3 i 16V (08.92 - 09.00) 75cv 1275cc Hatchback - NISSAN MICRA II (K11) 1.4 i 16V (09.00 -</p> <p>155x90x46mm 3f-d10mm</p>
	<p><b>E0044</b> NO. 1232414113</p> <p>ESTICADOR DE ESCAPE</p> <p>NISSAN MICRA K10 (APÓS 82)</p> <p>77x58x20mm NULL</p>		<p><b>E0184</b> NO. 56261-4F725 - 56261-4F702</p> <p>ESTICADOR DA BARRA ESTABILIZADORA DA FRENTE</p> <p>NISSAN MICRA K11 TT (1993 A 1997)</p> <p>120x30x35mm 2p-d10-26mm</p>
	<p><b>E0185</b> NO. 5626147B01</p> <p>ESTICADOR DA BARRA ESTABILIZADORA DE TRÁS</p> <p>NISSAN MICRA K11 TT (1993 A 1997)</p> <p>120x30x30xx 2p-d10-21mm</p>		<p><b>E0186</b> NO. 54618-AX600 - 8200127308 - 8200605381</p> <p>ESTICADOR DA BARRA ESTABILIZADORA DA FRENTE</p> <p>NISSAN MICRA K12 TT</p> <p>275x30x35mm 2p-d10-22mm</p>
	<p><b>E1021</b> NO. 20650-50A00 - 20650-70A10 - 20651-90J02 - 20650-60V00</p> <p>ESTICADOR DE ESCAPE</p> <p>NISSAN MICRA K11 (APÓS 08-1992)</p> <p>68x49x23mm NULL</p>		<p><b>E1034</b> NO. 20650D0100 - 20650V5000 - 20650V5200 - 2065041L00 - 206509C000 - 2066029R00</p> <p>ESTICADOR DE ESCAPE</p> <p>NISSAN MICRA K10 (1982 A 1992)</p> <p>72x62x35mm 2f-d11mm</p>
	<p><b>F0512-I</b> NO. 39241-01B25 - 39241-01M00 - 39241-01M29 - 39241-11M00 - 39241-11M25</p> <p>FOLE DO SEMI-EIXO EXTERNO</p> <p>NISSAN MICRA K10 1.0 (APÓS 1982)</p> <p>d83x85mm 1f-d72mm 1f-d22mm</p>		<p><b>F0884-I</b> NO. 39241-01M29 - 04438-87206-000 - 04438-87701-000 - 44333-SB2-761 - 44333-SC2-003 - B001-22-530A - B00...</p> <p>FOLE DO SEMI-EIXO INTERNO E EXTERNO</p> <p>NISSAN MICRA K10 SÉRIE L (ATÉ 1992)</p> <p>d81x85mm 1f-d78mm 1f-d20mm</p>
	<p><b>F0887-I</b> NO. 48203-01F00 - 48203-04A00 - 48203-11B00 - 48203-70A00 - 48203-W1000 - 48203-W1025 - 48204-01F00 - 48204-01F00</p> <p>FOLE DA CREMALHEIRA DA DIREÇÃO DIREITO</p> <p>NISSAN DATSUN MICRA 1.2 (1982 A 1992)</p> <p>d58x160mm 1f-d31mm 1f-d9mm</p>		<p><b>F0888-I</b> NO. 48204-01F00 - 48204-04A01 - 48204-W1000 - 48203-W1000 - 48204-50Y25</p> <p>FOLE DA CREMALHEIRA DA DIREÇÃO ESQUERDO</p> <p>NISSAN DATSUN MICRA 1.2 (1982 A 1992)</p> <p>d59x205mm 1f-d31mm 1f-d9mm</p>
	<p><b>F0996-I</b> NO. 73J25-4F425 - 39241-73J25</p> <p>FOLE DO LADO DA RODA (JUNTA 80 mm EIXO d25mm)</p> <p>NISSAN MICRA K11 1.3cc (APÓS 1992)</p> <p>d94x86mm 1f-d83mm 1f-d20mm</p>		<p><b>F1273-I</b> NO. 04438-87106 - 04438-87107 - 04438-87111 - 04438-87F43</p> <p>FOLE DA TRANSMISSÃO JUNTO À CAIXA</p> <p>NISSAN MARCH 1.0i (APÓS 1993)</p> <p>d82x82mm 1f-d62mm 1f-d20mm</p>
	<p><b>F1623-I</b> NO. 39241-4F125 - 39241-4F126</p> <p>FOLE DA TRANSMISSÃO JUNTO À RODA</p> <p>NISSAN MICRA 1.0i 16V (1992 A 2003)</p> <p>d82x86mm 1f-d69mm 1f-d21mm</p>		<p><b>KF1320-T</b> NO. 39241-AY125</p> <p>KIT DE FOLE DO CARDAN JUNTO À RODA</p> <p>NISSAN MICRA K12 1.2i 16V - 1.4i 16V (APÓS 2003)</p> <p>d91x115mm 1f-d74mm 1f-d21mm</p>

	<p><b>KF1606</b> NO. 39241-4F125 - 39241-4F126</p> <p>KIT DE FOLE DO CARDAN JUNTO À RODA</p> <p>NISSAN MICRA K11 - K11C 1.0i 16V (1992 A 2003)</p> <p>d90x85mm 1f-d66mm 1f-21mm</p>		<p><b>KF1607</b> NO. 39241-4F425 - 39241-4F427</p> <p>KIT DE FOLE DO CARDAN JUNTO À RODA</p> <p>NISSAN MICRA K11 - K11C 1.3i 16V - 1.5 D (1992 A 2003)</p> <p>d90x90mm 1f-d78mm 1f-d21mm</p>
	<p><b>KF1640</b> NO. 39241-11M00 - 39241-11M25 - 39241-11M26</p> <p>KIT FOLE DO LADO DA RODA</p> <p>NISSAN MARCH 1.0</p> <p>d90x85mm 1f-d74mm 1f-d22mm</p>		<p><b>KF2327</b> NO. 39241-16R00 - 39241-16R25 - 39241-16R27</p> <p>KIT DE FOLE DO CARDAN JUNTO À RODA</p> <p>NISSAN MARCH 1.0</p> <p>d86x84mm 1f-d76mm 1f-d22mm</p>
	<p><b>L3017</b> NO. 20136B5001 - 20136M7080</p> <p>CASQUILHO DE ESCAPE</p> <p>NISSAN MICRA K10 (1982 A 1990)</p> <p>NULL NULL</p>		<p><b>L3018</b> NO. 20136B5001 - 20136M7080</p> <p>CASQUILHO DE ESCAPE</p> <p>NISSAN MICRA K10 (1982 A 1990)</p> <p>NULL NULL</p>
	<p><b>M6011</b> NO. 2069599B00</p> <p>JUNTA DE ESCAPE</p> <p>NISSAN MICRA K11 (APÓS 1992)</p> <p>d59.5x13.5mm 1f-d46.2mm</p>		<p><b>M6020</b> NO. 206911B00</p> <p>JUNTA DE ESCAPE</p> <p>NISSAN MICRA K10 (APÓS 1988)</p> <p>d46x4mm 1f-d38.5mm</p>
	<p><b>M6044</b> NO. 20692P9000 - 2069265J00</p> <p>JUNTA DE ESCAPE</p> <p>NISSAN MICRA K11 (APÓS 1992)</p> <p>132x96mm 1f-d64mm</p>		<p><b>RT08993</b> NO. 462105F001 - 46210-5F002</p> <p>TUBO DE TRAVÃO FRENTE LH-RH</p> <p>NISSAN MICRA 1.0 - 1.3 K11 (-ABS) (APÓS 08-1992)</p> <p>475mm FB57 - OR33</p>
	<p><b>RT08994</b> NO. 462145F000 - 46214-5F001</p> <p>TUBO DE TRAVÃO TRÁS LH-RH</p> <p>NISSAN MICRA 1.0 - 1.3 K11 (-ABS) APÓS 08-1992</p> <p>222mm FB57 - FB57</p>		<p><b>RT08995</b> NO. 462105F006 - 46210-5F007 - 46210-5F010</p> <p>TUBO DE TRAVÃO FRENTE LH-RH</p> <p>NISSAN MICRA 1.0 - 1.3 K11 (+ABS) APÓS 08-1992</p> <p>483mm FB57 - OR64</p>
	<p><b>RT08996</b> NO. 462105F200 - 46210-5F201</p> <p>TUBO DE TRAVÃO TRÁS LH-RH</p> <p>NISSAN MICRA 1.0 - 1.3 K11 (+ABS) APÓS 08-1992</p> <p>234mm FB57 - OR33</p>		<p><b>RT80064</b> NO. 4621001B10 - 46210-01B00 - 46210-50Y70</p> <p>TUBO DE TRAVÃO FRENTE RH</p> <p>NISSAN MICRA 1.0 - 1.2 K10 (12-1982 A 03-1989)</p> <p>543mm FB43 - OR2</p>
	<p><b>RT80065</b> NO. 4621028B00 - 46210-28B10</p> <p>TUBO DE TRAVÃO FRENTE LH</p> <p>NISSAN MICRA 1.0 - 1.2 K10 (04-1989 A 07-1992)</p> <p>540mm FB43 - OR33</p>		<p><b>RT80066</b> NO. 4621489914 - 4621040R00 - 4621301A13</p> <p>TUBO DE TRAVÃO TRÁS LH-RH</p> <p>NISSAN MICRA 1.0 - 1.2 K10 (12-1982 A 07-1992)</p> <p>293mm FB52 - FB52</p>

 <b>FB57</b> <b>OR123</b> <small>Component / Components</small>	<b>RT80574</b> NO. 46210AX606 - 46210-9U01A <b>TUBO DE TRAVÃO FRENTE LH</b> NISSAN MICRA (K12) TT (APÓS 01-2003) 620mm FB57 - OR123	 <b>FB57</b> <b>FB57</b> <small>Component / Components</small>	<b>RT80575</b> NO. 46214AX600 <b>TUBO DE TRAVÃO DE TRÁS LH-RH</b> NISSAN MICRA III (K12) 1.0 16V (01.03 A 06.10) 65cv 998cc Hatchback - NISSAN MICRA III (K12) 1.2 16V (01.03 A 06.10) 65cv 1240cc Hatchback - NISSAN MICRA III (K12) 1.2 16V (01.03 A 06.10) 80cv 1240cc Hatchback - NISSAN MICRA III (K12) 1.4 16V (01.03 A 06.10) 88cv 1386cc Hatchback - NISSAN MICRA III (K12) 160 SR (05.05 A 06.10) 110cv 1598cc Hatchback - NISSAN MICRA III (K12) 1.5 dCi (01.03 A 06.10) 65cv 1461cc Hatchback - NISSAN MICRA III (K...etc. 305mm FB57 - FB57
 <b>FB43</b> <b>FB43</b> <small>Component / Components</small>	<b>RT80937</b> NO. 462101HJ5B <b>TUBO DE TRAVÃO DE TRÁS LH-RH</b> NISSAN MICRA IV (K13) 1.2 (APÓS 05.10) 80cv 1198cc Hatchback - NISSAN MICRA IV (K13) 1.2 DIG-S (APOS 04.11) 98cv 1198cc Hatchback 300mm FB43 - FB43		<b>S1456</b> NO. 54476-01B00 <b>SILENT BLOC DO BRAÇO DA SUSPENSÃO DA FRENTE PARTE TRÁS</b> NISSAN MICRA (K10) 1.0 (12-1982 A 12-1989) - 1.2 (07-1986 A 07-1992) 47x54x36mm c44mm 1f-d16mm
	<b>S1457</b> NO. 54535-01B00 <b>SILENT BLOC DO BRAÇO DA SUSPENSÃO DA FRENTE PARTE DA FRENTE</b> NISSAN MICRA (K10) 1.0 (12-1982 A 12-1989) - 1.2 (07-1986 A 07-1992) d29.5x46mm c40mm d29.5mm 1f-d12.5mm		<b>W5106</b> NO. 1230300QAY - 1230390QAU - 1230900QAG - 1220100QAW - 1230300QAX <b>POLIE DA CAMBOTA (6 PISTAS)</b> NISSAN MICRA III 1.5 Dci (K9K 704) 65CV (01-2003 A 06-2010) d155/151mm d26mm
	<b>Z80823</b> NO. 6385401A00 - NA0156145 <b>Rebite</b> NISSAN MICRA (Após 1993) d20x33mm 1p-d8-20mm		

## NISSAN NAVARA

	<b>A1867</b> NO. 37522-JR60A <b>APOIO DA TRANSMISSÃO</b> NISSAN NP300 NAVARA (D40) 2.5 dCi (APÓS 07-2005) 144CV 2488CC - NISSAN NP300 NAVARA (D40) 2.5 dCi 4WD (APÓS 10-2006) 171CV 2488CC - NISSAN NP300 NAVARA (D40) 2.5 dCi 4WD (APÓS 07-2005) 174CV 2488CC - NISSAN NP300 NAVARA (D40) 2.5 dCi 4WD (APÓS 12-2009) 19 198x120x46mm 1f-d45mm		<b>E0242</b> NO. 54668-EB71A <b>ESTICADOR DA BARRA ESTABILIZADORA DA FRENTE LADO ESQUERDO</b> NISSAN NAVARA 95x30x40mm 2p-d12-29mm
	<b>E0243</b> NO. 54618-EB71A <b>ESTICADOR DA BARRA ESTABILIZADORA DA FRENTE LADO DIREITO</b> NISSAN PATROL GR (Y60) 95x30x40mm 2p-d12-29mm		<b>F1910-T</b> NO. 40308383 - 46308480 - 1607740880 - LR003160 - 39242EB30B - C9241EB30A <b>FOLE DO EIXO DE TRANSMISSÃO LADO DA RODA</b> NISSAN NP300 NAVARA (D40) 2.5 dCi 4WD (A Partir de 07.05) 174cv 2488cc Pick-up d120x150mm 1f-d28mm 1f-d100mm
	<b>R8029</b> NO. 21501-44G10 - 21501-7F000 <b>TUBO SUPERIOR DO RADIADOR</b> NISSAN NAVARA D21 TD27 2.7 DIESEL B350-d38/34mm 150-260mm		<b>R8123</b> NO. 21503-2S602 <b>TUBO INFERIOR DO RADIADOR</b> NISSAN NAVARA D22 TD27 2.7 DIESEL B400-d38/33mm 100-75-160-130-95mm



	<b>R8127</b>	NO. 21501-44G00		<b>RT80573</b>	NO. 462109U00A - 46210AX601
	<p>TUBO SUPERIOR DO RADIADOR</p> <p>NISSAN NAVARA D21 2.5 DIESEL SD25 (10-1987 A 03-1992)</p>			<p>TUBO DE TRAVÃO FRENTE RH</p> <p>NISSAN NAVARA</p>	
B310-32/36mm		240x120mm	615mm		FA6 - OR129
	<b>RT80926</b>	NO. 46210EB005 - 46210EB00A - 46210-EB02A			
	<p>TUBO DE TRAVÃO DE TRÁS LH-RH</p> <p>NISSAN NP300 NAVARA (D40) 2.5 dCi (APÓS 07.05) 144cv 2488cc Pick-up - NISSAN NP300 NAVARA (D40) 2.5 dCi 4WD (APOS 10.06) 171cv 2488cc Pick-up - NISSAN NP300 NAVARA (D40) 2.5 dCi 4WD (APOS 07.05) 174cv 2488cc Pick-up</p>				
415mm		FB43 - FB43			

NISSAN NOTE

	<b>RT80574</b>	NO. 46210AX606 - 46210-9U01A		<b>RT80575</b>	NO. 46214AX600
	<p>TUBO DE TRAVÃO FRENTE LH</p> <p>NISSAN NOTE TT (APÓS 03-2006)</p>			<p>TUBO DE TRAVÃO DE TRÁS LH-RH</p> <p>NISSAN NOTE (E11 - NE11) 1.4 (03.06 A 06.12) 88cv 1386cc Veículo multiuso - NISSAN NOTE (E11 - NE11) 1.6 (03.06 A 06.12) 110cv 1598cc Veículo multiuso - NISSAN NOTE (E11 - NE11) 1.5 dCi (03.06 A 06.12) 68cv 1461cc Veículo multiuso - NISSAN NOTE (E11 - NE11) 1.5 dCi (03.06 A 06.12) 86cv 1461cc Veículo multiuso</p>	
620mm		FB57 - OR123	305mm		FB57 - FB57
	<b>T1157</b>	NO. 54613-9U000			
	<p>BATENTE DA BARRA ESTABILIZADORA DA FRENTE</p> <p>NISSAN NOTE (E11 - NE11) 1.4 (03.06 A 06.12) 88cv 1386cc Veículo multiuso - NISSAN NOTE (E11 - NE11) 1.6 (03.06 A 06.12) 110cv 1598cc Veículo multiuso - NISSAN NOTE (E11 - NE11) 1.5 dCi (03.06 A 06.12) 68cv 1461cc Veículo multiuso - NISSAN NOTE (E11 - NE11) 1.5 dCi (03.06 A 06.12) 86cv 1461cc Veículo multiuso - NISSAN NOTE (E11 - NE11) 1.5 dCi (09.10 A 06.12) 90cv 1461cc Veículo multiuso - NISSAN NOTE (E11 - NE11) 1.5 dCi (07.08 A 06.12...etc.</p>				
40x42x41mm		1f-d20,5mm			

NISSAN PATHFINDER

	<b>F1910-T</b>	NO. 40308383 - 46308480 - 1607740880 - LR003160 - 39242EB30B - C9241EB30A		<b>KF1681</b>	NO. 39172-31G25 - 39712-31G25 - 39741-41W03 - 39741-41W25 - 39741-41W26 - 39741-50W25
	<p>FOLE DO EIXO DE TRANSMISSÃO LADO DA RODA</p> <p>NISSAN PATHFINDER III (R51) 2.5 dCi 4WD (A Partir de 08.10) 190cv 2488cc Veículo todo-terreno fechado</p>			<p>KIT DE FOLE DO CARDAN JUNTO À RODA</p> <p>NISSAN PATHFINDER (APÓS 1997) 3.3i</p>	
d120x150mm		1f-d28mm 1f-d100mm	d98x100mm		1f-d85mm 1f-d20mm
	<b>T1142</b>	NO. 54613-4P007 - 54613-0P005			
	<p>BATENTE DA BARRA ESTABILIZADORA DA FRENTE</p> <p>NISSAN PATHFINDER II (R50) 3.3 V6 4WD (03.98 A 10.00) 150CV 3275CC - NISSAN PATHFINDER II (R50) 3.3 V6 4WD (09.97 A 12.04) 170CV 3275CC - NISSAN PATHFINDER II (R50) 3.5 V6 4WD (11.00 A 12.04) 220CV 3498CC - NISSAN PATHFINDER II (R50) 2.7 TD 4WD (09.97 A 1</p>				
47x45x29mm		1f-d26mm			

	<p><b>A1601</b> NO.  SEPARADOR DAS MOLAS 71X50X4 - 5 PINO 28X13 - 50X7 NISSAN PATROL</p> <p>70x49x4mm Pino 28x13x8mm</p>		<p><b>A1669</b> NO. 11220-C6001 - 11220-C6000 - 11220-G9603 APOIO DO MOTOR LADO DIREITO NISSAN PATROL - SAFARI 160</p> <p>140x110x47mm 1p-d12-30mm</p>
	<p><b>A1702</b> NO. 11221-C6000 APOIO DO MOTOR LADO ESQUERDO NISSAN PATROL SAFARI 160</p> <p>140x115x48mm 1p-d12-25mm</p>		<p><b>A1715</b> NO. 11320-C6001 - 11320-C6000 APOIO DO MOTOR PARTE DE TRÁS (CAIXA) NISSAN PATROL 4X4 - SAFARI P40</p> <p>135x48x55mm 1p-d12-25mm</p>
	<p><b>A1757</b> NO. 11220-10J00 - 11220-10J03 APOIO DO MOTOR FRENTE LADO DIREITO E ESQUERDO NISSAN PATROL GR I (Y60 - GR) 2.8 TD (09-1988 A 06-1997) - 4.2 CAT (11-1988 A 06-1997) - 4.2 D (11-1988 A 06-1997) - PATROL GR II (Y61) 2.8 TD (06-1997 A 05-2000) - 3.0 DTi (APÓS 05-2000) - 4.2 TD (APÓS 06-1997)</p> <p>130x120x40mm 2f-d12.5mm 1p-d12x30mm</p>		<p><b>A1773</b> NO. 11320-01J00 - 11320-06J00 - 11320-G9801 APOIO DO MOTOR PARTE DE TRÁS NISSAN PATROL GR I (Y60) 2.8 TD (06-1997 A 05-2000) - 3.0 DTi (APÓS 05-2000) - 3.2 D (05-1998 A 06-2001) - PATROL GR II 2.8 TD (Y61) - 2.8 TD (06-1997 A 05-2000) - 3.0 DTi (APÓS 05-2000) - 3.2 D (05-1998 A 06-2001)</p> <p>133x103x66mm 1p-d12-26mm 2f-d11mm</p>
	<p><b>A1912</b> NO. 11220-10J07 - 11220-10J10 APOIO DO MOTOR PARTE DA FRENTE NISSAN PATROL (Y60 TB42 - TD42) (APÓS 1994)</p> <p>130x120x43mm 1p-d12-30mm 1pino-d12-30mm 4f-d15mm</p>		<p><b>KM0403</b> NO. 54220-C8200K KIT DE BRINCOS DAS MOLAS DE TRÁS (Composto por 2 casquilhos L3048) NISSAN PATROL G160</p> <p>117x115x52mm d40mm</p>
	<p><b>KM0405</b> NO. 55222-00900K KIT DE BRINCOS DAS MOLAS FRENTE E TRÁS (PARTE DE TRÁS) NISSAN PATROL G 60 - G 160 MQ</p> <p>120x100x35mm d22mm</p>		<p><b>KM0415</b> NO. 55220-10J00K KIT DE BRINCOS DAS MOLAS DA FRENTE (COMPOSTO POR 4 CASQUILHOS L3066) NISSAN PATROL LWB Y 60</p> <p>140x104x60mm d40mm 2p-d13.8mm</p>
	<p><b>KM0421</b> NO. 55220-10J00K KIT DE BRINCOS DAS MOLAS DE TRÁS (COMPOSTO POR 4 CASQUILHOS L3065) NISSAN PATROL LWB Y 60</p> <p>136x103x60mm 2d-35mm 2p-d13.8-16mm</p>		<p><b>KM0429</b> NO. 55210-01W00 KIT DE BRINCOS DAS MOLAS DE TRÁS (COMPOSTO POR 2 CASQUILHOS L3048) NISSAN PATROL G160 - 720 4X4</p> <p>111x82x67mm d40mm 1p-d12-30mm</p>
	<p><b>L1035</b> NO. 55046-01W10L CASQUILHO DE MOLAS (TRÁS DO OLHAL DA FRENTE) NISSAN PATROL</p> <p>d39x38mm d34mm 1f-d17mm</p>		<p><b>L1049</b> NO. 55046-R8000 - 55046-G9601 CASQUILHO DE MOLA NISSAN PATROL</p> <p>d37x39mm d33mm 1f-d18mm</p>
	<p><b>L1068</b> NO. 55046-G9600 - 55046-C6000 - 55046-C6000 - 55046-R8800 - 55046-R8000 - 55046-69600 CASQUILHO MOLA TRÁS NISSAN PATROL (JEEP)</p> <p>d38x50mm 1f-d18mm d32mm</p>		<p><b>L3017</b> NO. 20136B5001 - 20136M7080 CASQUILHO DE ESCAPE NISSAN PATROL (1981 A 1990)</p> <p>NULL NULL</p>

	<p><b>L3018</b> NO. 20136B5001 - 20136M7080</p> <p>CASQUILHO DE ESCAPE</p> <p>NISSAN PATROL (1981 A 1990)</p> <p>NULL NULL</p>		<p><b>L3048</b> NO. 55045-10W00 - 55045-G9600</p> <p>CASQUILHO DAS MOLAS DE TRÁS PARTE FRENTE</p> <p>NISSAN PATROL G160 - D21</p> <p>d48x38mm d40mm 1f-d18mm</p>
	<p><b>L3065</b> NO. 55045-10J00</p> <p>CASQUILHO DAS MOLAS DE TRÁS</p> <p>NISSAN PATROL GQ - Y60</p> <p>d44x44mm d35mm 1f-d18mm</p>		<p><b>L3066</b> NO. 55045-10J10</p> <p>CASQUILHO DAS MOLAS DE TRÁS</p> <p>NISSAN PATROL GQ - Y60</p> <p>d49x45mm d40mm 1f-d18mm</p>
	<p><b>L3113</b> NO. 55135-01J00</p> <p>CASQUILHO DA BARRA ESTABILIZADORA DA FRENTE</p> <p>NISSAN PATROL GR IV (Y60 - GR) 4.2 Cat (11.88 A 02.98) 165cv 4169cc Veículo todo-terreno fechado - NISSAN PATROL GR IV (Y60 - GR) 2.8 TD (Y60A) (09.88 A 06.97) 116cv 2826cc Veículo todo-terreno fechado - NISSAN PATROL GR IV (Y60 - GR) 4.2 D (Y60GR) (11.88 A 06.97) 116cv 4169cc Veículo todo-terreno fechado</p> <p>d47x29mm d39/41mm 1f-d25mm</p>		<p><b>L3114</b> NO. 54476-01J00</p> <p>CASQUILHO DA BARRA ESTABILIZADORA DA FRENTE</p> <p>NISSAN PATROL III/2 Hardtop (K260) 2.8 D (03.89 A 03.96) 90cv 2826cc Veículo todo-terreno fechado</p> <p>d54x28mm 1f-d24mm</p>
	<p><b>L3114</b> NO. 54476-01J00</p> <p>CASQUILHO DA BARRA ESTABILIZADORA DA FRENTE</p> <p>NISSAN PATROL GR IV (Y60 - GR) 4.2 Cat (11.88 A 02.98) 165cv 4169cc Veículo todo-terreno fechado - NISSAN PATROL GR IV (Y60 - GR) 2.8 TD (Y60A) (09.88 A 06.97) 116cv 2826cc Veículo todo-terreno fechado - NISSAN PATROL GR IV (Y60 - GR) 4.2 D (Y60GR) (11.88 A 06.97) 116cv 4169cc Veículo todo-terreno fechado</p> <p>d54x28mm 1f-d24mm</p>		<p><b>P1095</b> NO. 46531-VB000</p> <p>CAPA DE PEDAL DO TRAVÃO E EMBRAIAGEM</p> <p>NISSAN PATROL Y61 SAFARI TB42S - TB45E.MT - RD28TI.MT - TD42 (08-1997 A 08-1998)</p> <p>60x60x10mm NULL</p>
	<p><b>RT80071</b> NO. 4621020J00</p> <p>TUBO DE TRAVÃO FRENTE RH</p> <p>NISSAN PATROL GR (Y60) 2.8 TD - 4.2 (09-1988 A 06-1997)</p> <p>380mm FB52 - FC1</p>		<p><b>RT80072</b> NO. 4621001J10 - 4621001J11</p> <p>TUBO DE TRAVÃO FRENTE LH</p> <p>NISSAN PATROL HARDTOP(K160) 2.8 (07-1980 A 08-1988) - 3.2 D (11-1979 A 08-1988) - 3.2 TD (07-1983) - PATROL HARDTOP (K260) 2.8 (05-1986 A 06-1990) 2.8 TD (05-1986 A 06-1990) - 3.2 D (08-1988 A 06-1990) - PATROL STATION WAGON (W160) 2.8 (07-1980 A 08-1988)</p> <p>263mm FB43 - OR94</p>
	<p><b>RT80072</b> NO. 4621001J10 - 4621001J11</p> <p>TUBO DE TRAVÃO FRENTE LH</p> <p>NISSAN PATROL STATION WAGON (W260) 2.8 TD (06-1989 A 11-1995) - 3.2 D (08-1988 A 06-1990)</p> <p>263mm FB43 - OR94</p>		<p><b>RT80072</b> NO. 4621001J10 - 4621001J11</p> <p>TUBO DE TRAVÃO FRENTE LH</p> <p>OPEL ASTRA H 1.2 (APÓS 08-2005) - 1.3 CDTi (APÓS 08-2005) - 1.4 (APÓS 03-2004) - 1.6 (APÓS 03-2004) - 1.6 TURBO (APÓS 02-2007) - 1.7 CDTi (APÓS 03-2004) - 1.8 (APÓS 03-2004) - 1.9 CDTi (APÓS 06-2004) - 1.9 CDTi 16V (APÓS 04-2004) - 2.0 TURBO (APÓS 03-2004)</p> <p>263mm FB43 - OR94</p>
	<p><b>RT80073</b> NO. 4621002J10</p> <p>TUBO DE TRAVÃO TRÁS LH-RH INTERMÉDIO</p> <p>NISSAN PATROL GR (Y60) 2.8 TD - 4.2 (09-1988 A 06-1997)</p> <p>225mm FB43 - OR2</p>		<p><b>RT80074</b> NO. 46201R8200 - 46203G9500 - 46210R8200 - 5873211100 - MA181409 - MB004446 - MB004448 - MB238154 - MB85...</p> <p>TUBO DE TRAVÃO FRENTE RH</p> <p>NISSAN PATROL HARDTOP (K160) - 2.8 - 3.2D - 3.2TD (11-1979 A 08-1988) - PATROL STATION WAGON (W160) - 2.8 - 3.2D - 3.2TD (11-1979 A 08-1988)</p> <p>340mm FB52 - OR38</p>
	<p><b>RT80075</b> NO. 46204C6000</p> <p>TUBO DE TRAVÃO FRENTE LH</p> <p>NISSAN PATROL HARDTOP (K160) - 2.8 - 3.2D - 3.2TD (11-1979 A 08-1988) - PATROL STATION WAGON(W160) - 2.8 - 3.2D - 3.2TD (11-1979 A 08-1988)</p> <p>413mm FC - OR1</p>		<p><b>RT80076</b> NO. 46201-89946 - 46211-01A46</p> <p>TUBO DE TRAVÃO TRÁS LH-RH</p> <p>NISSAN PATROL HARDTOP(K160) 2.8 - 3.2 D - 3.2 TD (11-1979 A 08-1988)</p> <p>461mm FB48 - MC50</p>













	<b>S1044</b> NO. 55045G9500 SILENT-BLOC DE MOLAS NISSAN PATROL d33x73mm c65mm 1f-d16mm		<b>S1245</b> NO. 55045-07200 SILENT-BLOC MOLAS TRÁS E FRENTE (PARTE DA FRENTE) NISSAN PATROL d33x64mm c60mm 1f-d15.5mm
	<b>S1480</b> NO. 54560-06Y00 SILENT BLOC DO BRAÇO DA SUSPENSÃO NISSAN PATROL d50x60mm c46mm 1f-d14.5mm		<b>S1485</b> NO. 54560-01J00 - 54560-VB011 - 54560-VB012 - 54560-VC000 - 48702-60050 - 48610-60021 - 48610-60022 - 48610-60023 SILENT BLOC DO BRAÇO INFERIOR DA SUSPENSÃO NISSAN PATROL GRI Y60 (11-1988 A 06-1997) d60.5x50mm c40mm 1f-d16mm
	<b>T1106</b> NO. 54613-88G00 BATENTE DA BARRA ESTABILIZADORA DA FRENTE NISSAN SAFARI 52x38x37mm 1f-d24mm		<b>T1121</b> NO. 54613-06J10 BATENTE BARRA ESTABILIZADORA DA FRENTE NISSAN PATROL GR I (Y60) (Y60A) 2.8 TD (09-1988 A 06-1997) - 4.2 CAT. (11-1988 A 06-1997) - 4.2 D (Y60GR) (11-1988 A 06-1997) 40x38x46mm 1f-d17mm 30x33mm
	<b>T1136</b> NO. 54613-VC223 BATENTE DA BARRA ESTABILIZADORA NISSAN PATROL GR V Wagon (Y61) 2.7 TD (05.98 - 06.01) 99cv 2664cc Veículo todo-terreno fechado - NISSAN PATROL GR V Wagon (Y61) 2.8 TD (06.97 - 05.00) 129cv 2826cc Veículo todo-terreno fechado - NISSAN PATROL GR V Wagon (Y61) 3.0 DTi (APÓS 05.00) 158cv 46x46x28mm 1f-d23mm		<b>Z80823</b> NO. 6385401A00 - NAO156145 Rebite NISSAN PATROL d20x33mm 1p-d8-20mm

## NISSAN PICK-UP (D21)-(D22)-(D23)-BIGM-KING-HARDBODY

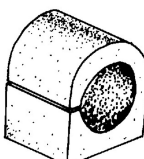
	<b>A1123</b> NO. 11320-01G00 SUPORTE DA CAIXA DE VELOCIDADES NISSAN DATSUN D21 - TD25 - 2WD MOTOR SD23 140x100x62mm 2p-d10-23mm		<b>A1133</b> NO. 11210-18G01 - 11220-18G11 APOIO DA FRENTE DIREITO DO MOTOR NISSAN DATSUN D21 - TD25 150x110x60mm 1p-d9.5-24mm
	<b>A1247</b> NO. 37521-W1025 - 37521-W1027 - 37521-W1625 - 37521-Q0125 - 37521W1000 - 37521-W1026 - 37521-P0125 APOIO DO VEIO DA TRANSMISSÃO NISSAN D21 MOTOR SD23 d110x51mm 1f-d30mm		<b>A1248</b> NO. 37521-36G25 - 37521-32G25 - 37521-33G25 - 37522-34G00 - 37521-56G25 - 37521-33G26 APOIO DO VEIO DA TRANSMISSÃO NISSAN HARD BODY D21 - SD 25 d125x50mm 1f-d30mm
	<b>A1335</b> NO. 55240-01G00 - 55240-15G00 APOIO BATENTE DAS MOLAS DE TRÁS NISSAN D21 184x95x66mm NULL		<b>A1359</b> NO. 11220-35G00 - 11220-43G00 SUPORTE DE MOTOR ESQUERDO NISSAN D21 - TD25 134x105x100mm 1p-d10-20mm

	<p><b>A1360</b> NO. 11221-18G11</p> <p>SUPORTE DE MOTOR ESQUERDO</p> <p>NISSAN D21 - SD23</p> <p>120x104x96mm 1p-d10-20mm</p>		<p><b>A1366</b> NO. 11320-7F000</p> <p>SUPORTE DA CAIXA TRÁS</p> <p>NISSAN BIGM - D21 - (Z16 B2000) 4WD</p> <p>165x115x75mm 2p-d10-22mm</p>
	<p><b>A1428</b> NO. 11210-43G00 - 11210-35G00</p> <p>APOIO DE MOTOR FRENTE DIREITO</p> <p>NISSAN D21 TD25</p> <p>153x140x57mm 1p-d10-20mm</p>		<p><b>A1542</b> NO. 54050-01G00</p> <p>APOIO BATENTE INFERIOR DO BRAÇO DA SUSPENSÃO DA FRENTE</p> <p>NISSAN D21</p> <p>71x66x56mm 1p-d8-18mm</p>
	<p><b>A1913</b> NO. 11320-31G05</p> <p>APOIO DO MOTOR PARTE DE TRÁS CAIXA DE VELOCIDADES</p> <p>NISSAN PICK UP (D21) 2.4 i 12V 4WD (04.92 A 02.98) 126cv 2389cc Pick-up - NISSAN PICK UP (D21) 2.3 D 4WD (09.85 A 08.87) 69cv 2289cc Pick-up - NISSAN PICK UP (D21) 2.5 D 4WD Ano fabric. até: 10.87 (03.86 A 08.91) 75cv 2494cc Pick-up - NISSAN PICK UP (D21) 2.7 D 4WD (08.87 A 02.98) 99cv 2663cc Pick-up - NISSAN PICK UP (D22) 2.4 i 4WD Ano fabric. até: 11.01 (02.98 A 04.05) 120cv 2389cc Pick-up - NISSAN PICK UP (D22) 2.4 i 4WD (03.02 A 04.05)...etc.</p> <p>160x115x65mm 2p-d10-22mm 2f-d13mm</p>		<p><b>A1917</b> NO. 1121035G00</p> <p>APOIO DO MOTOR PARTE DA FRENTE LADO DIREITO E ESQUERDO</p> <p>NISSAN PICK UP (D22) 2.5 Di 4WD (03.02 A 04.05) 133cv 2488cc Pick-up - NISSAN TERRANO I (WD21) 2.7 TD 4WD (02.89 A 02.96) 99cv 2664cc Veiculo todo-terreno fechado</p> <p>150x140x58mm 1p-d10-24mm 2f-d11mm 2f-d8mm</p>
	<p><b>D0017</b> NO. 48071-01G00</p> <p>CARDAN DA DIRECÇÃO</p> <p>NISSAN MICRA (K12) 1.0 16V (APÓS 01-2003) - 1.2 16V (APÓS 01-2003) - 1.4 16V (APÓS 01-2003) - 1.5 DCi (APÓS 06-2005) - 160 SR (APÓS 05-2005) - 1.4 (APÓS 03-2006) - 1.5 DCi (APÓS 03-2006) - 1.6 (APÓS 03-2006)</p> <p>d69x11mm 2f-d8.5mm 2f-d12mm</p>		<p><b>D0017-C</b> NO. 48071-01G00</p> <p>CARDAN DA DIRECÇÃO (Completo)</p> <p>NISSAN D21</p> <p>d70x62mm NULL</p>
	<p><b>E0190</b> NO. 54618-01G00</p> <p>ESTICADOR DA BARRA ESTABILIZADORA</p> <p>NISSAN D21 PICK-UP (84 A94)</p> <p>d34x210mm d26mm</p>		<p><b>E1015</b> NO. 20641-M6810 - 20641-M7060 - 20641-58100 - 20641-U6800 - 20641-U6810</p> <p>ESTICADOR DE ESCAPE</p> <p>NISSAN PICK-UP D21</p> <p>59x50x46mm 2p-d8-18mm</p>
	<p><b>F1221-I</b> NO. 39241-41W01 - 39241-41W25</p> <p>FOLE DE TRANSMISSÃO DO LADO DA RODA</p> <p>NISSAN DATSUN TRUCK D21</p> <p>d90x115mm 1f-d75mm 1f-25mm</p>		<p><b>F4036</b> NO. 32862-V5002</p> <p>FOLE DA ALAVANCA DE VELOCIDADES</p> <p>NISSAN D21 - D22</p> <p>d83x51mm 1f-d60mm 1f-d12mm</p>
	<p><b>H345</b> NO.</p> <p>PALA ORIGINAL</p> <p>NISSAN BIGM PICK-UP - D21 2WD - 4WD</p> <p>500x285mm NULL</p>		<p><b>KF1645</b> NO. 3824101E26 - 3924110E02</p> <p>KIT DE FOLE DO CARDAN JUNTO À RODA</p> <p>NISSAN DATSUN PICK-UP D21 2.0 - 2.3 - 2.7</p> <p>d108x92mm 1f-d95mm 1f-d23mm</p>
	<p><b>KF1681</b> NO. 39172-31G25 - 39712-31G25 - 39741-41W03 - 39741-41W25 - 39741-41W26 - 39741-50W25</p> <p>KIT DE FOLE DO CARDAN JUNTO À CAIXA</p> <p>NISSAN PICK UP D21 - BIGM 4WD (APÓS 1980) 1.8 - 2.0 - 2.2 - 2.3 - 2.7</p> <p>d98x100mm 1f-d85mm 1f-d20mm</p>		<p><b>KF1683-T</b> NO. 39241-5V125 - 39241-8V125</p> <p>KIT DE FOLE DO CARDAN JUNTO À RODA E CAIXA</p> <p>NISSAN KING CAB 2.4i - 2.5 Tdi (APÓS 98)</p> <p>d103x111mm 1f-d97mm 1f-d28mm</p>













	<b>KM0400</b> NO. 55220-15G00K <b>KIT DE BRINCOS DAS MOLAS (TRÁS PARTE DE TRÁS)</b> (composto por 4 casquilhos 11046) NISSAN PICK-UP D21		<b>KM0429</b> NO. 55210-01W00 <b>KIT DE BRINCOS DAS MOLAS DE TRÁS (COMPOSTO POR 2 CASQUILHOS L3048)</b> NISSAN PICK-UP D21
	<b>L0007-NY</b> NO. 48544-01G00 <b>CASQUILHO DO PENDURAL DA DIRECÇÃO</b> NISSAN PICK-UP D21 TT		<b>L1035</b> NO. 55046-01W10LP <b>CASQUILHO DE MOLAS (TRÁS DO OLHAL DA FRENTE)</b> NISSAN DATSUN PICK-UP D21
	<b>L1042</b> NO. 8200802664 - 8200051126 - 8200213058 - 8200207436 - 8200664348 - 8200195546 - 8200555547 - 820046808... <b>CASQUILHO DE MOLAS TRÁS DO OLHAL DE TRÁS</b> NISSAN PICK-UP D21		<b>L1046</b> NO. 55046-01G00 <b>CASQUILHO DE MOLAS</b> NISSAN DATSUN PICK-UP D21
	<b>L1070</b> NO. 54476-01G00 - 54476-35G00 - 54476-01W00 <b>CASQUILHO DO BRAÇO DA SUSPENSÃO</b> NISSAN PICK-UP D21		<b>M6040</b> NO. 20711-01E00 - 20691-01E80 <b>JUNTA DE ESCAPE</b> NISSAN KING CAB (APÓS 1985)
	<b>P1038</b> NO. 46531-18001 - 46531-M3000 <b>CAPA PEDAL DO TRAVÃO E EMBRAIAGEM</b> NISSAN D21 - D22		<b>R8099</b> NO. 16576-87900 - 16576-87900B - 16576-87G00 - 16576-87G00B <b>TUBO DO FILTRO DE AR</b> NISSAN PICK-UP D21 - D22
	<b>RT80082</b> NO. 4621001G00 - 46210-01G10 <b>TUBO DE TRAVÃO FRENTE RH</b> NISSAN PICK UP (D21) (04-1992 A 02-1988)		<b>RT80083</b> NO. 4621101G00 - 46211-00G10 <b>TUBO DE TRAVÃO FRENTE LH</b> NISSAN PICK UP (D21) (04-1992 A 02-1988)
	<b>RT80084</b> NO. 4621031G10 - 4621031G11 - 1954516 - 1954519 - 46210-01F10 - 46210-EK400 - 46210-50Y07 <b>TUBO DE TRAVÃO FRENTE RH</b> NISSAN PICK UP (D21) (03-1986 A 02-1998)		<b>RT80085</b> NO. 4621131G11 - 46211-0F010 - 46211-31G10 - 46211-EK400 - 46210-50Y12 <b>TUBO DE TRAVÃO FRENTE LH</b> NISSAN PICK UP (D21) (03-1986 A 02-1998)
	<b>RT80272</b> NO. 4621032G10 <b>TUBO DE TRAVÃO TRÁS LH-RH (INTERMÉDIO)</b> NISSAN PICK UP(D21) TT (4WD) (03-1986 A 02-1998)		<b>RT80387</b> NO. 4621101A45 <b>TUBO DE TRAVÃO DE TRÁS LH-RH</b> NISSAN PICK UP (D21) 2.4 i 12V(04.92 A 02.98) 124cv 2389cc Pick-up - NISSAN PICK UP (D21) 2.5 D (08.92 A 02.98) 83cv 2494cc Pick-up

	<p><b>RT80396</b> NO. 4621101A60</p> <p>TUBO DE TRAVÃO TRÁS LH-RH</p> <p>NISSAN PICK UP(D21) TT (4WD) (03-1986 A 02-1998)</p>		<p><b>S1104</b> NO. 55045-31G00</p> <p>SILENT-BLOC DE MOLAS</p> <p>NISSAN PICK-UP D21 4x4 2WD</p>
	<p><b>S1170</b> NO. 54560-01G00</p> <p>SILENT-BLOC DAS MOLAS</p> <p>NISSAN D21</p>		<p><b>S1335</b> NO. 55045-31G00</p> <p>SILENT-BLOC DAS MOLAS TRÁS</p> <p>NISSAN PICK-UP D21 4X4</p>
	<p><b>S1512</b> NO. 54542-2S610</p> <p>SILENT BLOC DO BRAÇO DA SUSPENSÃO DA FRENTE PARTE SUPERIOR</p> <p>NISSAN PICK-UP (D22) 2.5Di 133CV 2488cc (APÓS 03-2002) - 2.5Di 4WD 133CV 2488cc (APOS 03-2002) - 2.5D 83CV 2494cc (APÓS 02-1998) - 2.5D 4WD 83CV 2494cc (APÓS 02-1998) - 2.5TD 4WD 103CV 2494cc (APÓS 05-1998)</p>		<p><b>S1550</b> NO. 54560-2S600</p> <p>SILENT-BLOC DO BRAÇO DA SUSPENSÃO DA FRENTE PARTE INFERIOR</p> <p>NISSAN PICK UP III (D22) 2.4 i 4WD (02.98 A 11.01) 120CV 2389CC - NISSAN PICK UP III (D22) 2.4 i 4WD (APOS 03.02) 133CV 2389CC - NISSAN PICK UP III (D22) 2.5 D 4WD (02.98 A 11.01) 83CV 2494CC - NISSAN PICK UP III (D22) 2.5 TD 4WD (05.98 A 11.01) 103CV 24</p>
	<p><b>T0041</b> NO. 54613-W1410 - 54613-W1410 - 54613-M1410</p> <p>BATENTE DA BARRA ESTABILIZADORA DO CENTRO</p> <p>NISSAN PICK-UP D21 4x2 e 4x4</p>		<p><b>T1084</b> NO. 54613-32G00</p> <p>BATENTE DA BARRA ESTABILIZADORA DA FRENTE E CENTRO</p> <p>NISSAN D21 4WD</p>
	<p><b>T1104</b> NO. 54613-43G00</p> <p>BATENTE DA BARRA ESTABILIZADORA</p> <p>NISSAN D21</p>		<p><b>T1104</b> NO. 54613-43G00</p> <p>BATENTE DA BARRA ESTABILIZADORA</p> <p>NISSAN KING-CAB</p>
	<p><b>T1122</b> NO. 54613-0P005 - 54613-4P007</p> <p>BATENTE DA BARRA ESTABILIZADORA DA FRENTE</p> <p>NISSAN PIK-UP(D22) 2.5 Di 4X4 (APÓS 01/1997)</p>		<p><b>T1143</b> NO. 54613-2S600</p> <p>BATENTE DA BARRA ESTABILIZADORA DA FRENTE</p> <p>NISSAN PICK UP III (D22) 2.5 Di 4WD (APÓS 03.02) 133CV 2488CC - NISSAN PICK UP III (D22) 2.5 D 4WD (APÓS 02.98) 83CV 2494CC - NISSAN PICK UP III (D22) 2.5 TD 4WD (APÓS 05.98) 103CV 2494CC - NISSAN PICKUP / NP300 PICKUP III (D22) 2.5 dCi 4x4 Diâm. da roda:</p>
	<p><b>W5153</b> NO. 123032S600 - 123032S601</p> <p>POLIE CAMBOTA</p> <p>NISSAN PICK UP (D21) 2.5 D 4WD (08.87 A 02.98) 80cv 2494cc Pick-up - NISSAN PICK UP (D21) 2.5 D (08.92 A 02.98) 83cv 2494cc Pick-up - NISSAN PICK UP (D21) 2.5 D 4WD (03.96 A 02.98) 83cv 2494cc Pick-up - NISSAN PICK UP (D21) 2.7 D 4WD (08.87 A 02.98) 99cv 2663cc Pick-up - NISSAN PICK UP (D22) 2.5 D (02.98 A 04.05) 83cv 2494cc Pick-up - NISSAN PICK UP (D22) 2.5 TD 4WD (05.98 A 04.05) 103cv 2494cc Pick-up - NISSAN PICK UP (D22) 3.2 D 4WD...etc.</p>		

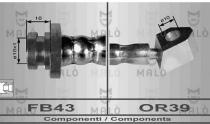
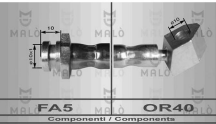
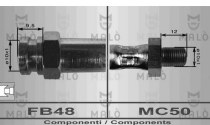
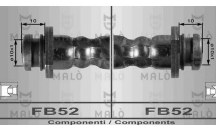
	<p><b>A1122</b> NO. 55240-01W01 - 55240-01W00 - 55240-B5000</p> <p>APOIO - BATENTE DA MOLA DE TRÁS</p> <p>NISSAN DATSUN 620 - 720 MOTOR SD22 E SD23</p> <p>160x80x68mm NULL</p>		<p><b>A1124</b> NO. 54050-B9500</p> <p>APOIO BATENTE DO BRAÇO INFERIOR DA SUSPENSÃO</p> <p>NISSAN DATSUN 720</p> <p>70x70x45mm 1p-d7.5-19mm 2p-d11.5-25mm</p>
	<p><b>A1135</b> NO. 11221-09W01 - 11221-09W10 - 11221-09W02</p> <p>APOIO - BATENTE INFERIOR ESQUERDO DA FRENTE DO MOTOR</p> <p>NISSAN DATSUN 720 - MOTOR SD23</p> <p>104x80x56mm 2p-d11.5-25mm</p>		<p><b>A1136</b> NO. 11220-09W01B</p> <p>SUPORTE LADO DIREITO DA FRENTE DO MOTOR</p> <p>NISSAN DATSUN 720 - MOTOR SD23 - 780 D</p> <p>125x110x58mm 1p-d11.5-25mm</p>
	<p><b>A1138</b> NO. 11220-G7000</p> <p>APOIO - BATENTE INFERIOR DIREITO DA FRENTE DO MOTOR</p> <p>NISSAN DATSUN 720 - MOTOR SD22</p> <p>118x110x58mm 1p-d12-27mm</p>		<p><b>A1139</b> NO. 11221-31W00 - 11221-34W00</p> <p>SUPORTE DA FRENTE DO MOTOR LADO ESQUERDO</p> <p>NISSAN DATSUN 720 - MOTOR SD22</p> <p>115x110x57mm 1p-d12-26mm</p>
	<p><b>A1258</b> NO. 11220-08W01 - 11220-08W02</p> <p>SUPORTE DA FRENTE DO MOTOR</p> <p>NISSAN PICK-UP 720 MOTOR 95 - J16 - L18 - Z22</p> <p>150x128x48mm 1p-d10-22mm</p>		<p><b>A1259</b> NO. 11220-B8000</p> <p>SUPORTE DA FRENTE DO MOTOR</p> <p>NISSAN PICK-UP 620 MOTOR SD22</p> <p>100x94x45mm 1p-d10-22mm</p>
	<p><b>A1261</b> NO. 37521-B5000 - 37521-B5025 - 37522-B5001 - 37521-B5026</p> <p>APOIO DO VEIO DA TRANSMISSÃO</p> <p>NISSAN PICK-UP 620 (TODAS)</p> <p>d120x62mm 1f-d30mm</p>		<p><b>A1263</b> NO. 11221-03W00</p> <p>SUPORTE DA FRENTE DO MOTOR</p> <p>NISSAN PICK-UP 720 (P)</p> <p>130x60x48mm 1p-d10-22mm 1p-d12-28mm</p>
	<p><b>A1265</b> NO. 11320-B5000 - 11320-B5001</p> <p>SUPORTE CAIXA DE VELOCIDADES</p> <p>NISSAN PICK-UP 620 MOTOR SD22</p> <p>135x80x60mm 2r-d10mm</p>		<p><b>A1266</b> NO. 37521-01W25</p> <p>APOIO DO VEIO DE TRANSMISSÃO</p> <p>NISSAN DATSUN 720 (1979 A 1985)</p> <p>d120x47mm NULL</p>
	<p><b>A1299</b> NO. 37521-33G25 - 37521-32G25 - 37521-34G25 - 37521-33G26</p> <p>SUPORTE DA TRANSMISSÃO COM RETENTOR</p> <p>NISSAN PICK-UP 720</p> <p>NULL NULL</p>		<p><b>C0232</b> NO. 62840-V0100</p> <p>BOTÃO AFINAÇÃO DE CAPÔT</p> <p>NISSAN 720 PICK-UP (1980 A 1986) L20B- SD22 -SD25 - Z20 - Z22 -Z24 -Z24L</p> <p>d22x31mm c23mm</p>
	<p><b>E0074</b> NO. 54616-B9700K</p> <p>ESTICADOR DE BARRA ESTABILIZADORA</p> <p>NISSAN PICK-UP 720 SD23</p> <p>d33x210mm d25mm</p>		<p><b>F1221-I</b> NO. 39241-41W01 - 39241-41W25</p> <p>FOLE DE TRANSMISSÃO DO LADO DA RODA</p> <p>NISSAN DATSUN TRUCK 720</p> <p>d90x115mm 1f-d75mm 1f-25mm</p>

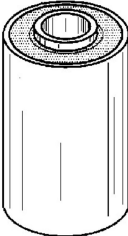
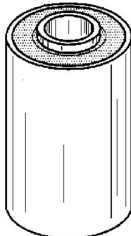

	<p><b>F4005</b> NO. 32862-E9300 - 32862-V5001</p> <p>FOLE DA TRANSMISSÃO</p> <p>NISSAN PICK-UP 720 MOTOR SD22 SD23 - DS21 MOTOR SD23 TD25</p> <p>d70x55mm 1f-d42mm 1f-d12mm</p>		<p><b>F4006</b> NO. 30542-E9000 - 30542-03E10</p> <p>FOLE DA EMBRAIAGEM</p> <p>NISSAN PICK-UP 720 MOTOR SD22 SD23 - DS21 MOTOR SD23 TD25 - 620</p> <p>94x54x49mm NULL</p>
	<p><b>F4030</b> NO. 74963H5000</p> <p>FOLE DA ALAVANCA DE VELOCIDADES</p> <p>NISSAN PICK-UP 720 - 120Y</p> <p>d115x60mm 1f-d87mm 1f-d15mm</p>		<p><b>KM0425</b> NO. 55220-01W00K</p> <p>KIT DE BRINCOS DAS MOLAS PARTE DE TRÁS</p> <p>NISSAN PICK-UP 720</p> <p>245x36x36mm 2p-d12-25mm</p>
	<p><b>L0014</b> NO. 56119-32201</p> <p>CASQUILHO DE AMORTECEDORES (CÔNICOS)</p> <p>NISSAN 620 - 670</p> <p>d30x19mm d26mm 1f-d16mm</p>		<p><b>L0329</b> NO. 54476-W5000 - 54476-W5001</p> <p>CASQUILHO</p> <p>NISSAN PICK-UP 720</p> <p>d38x26mm 1f-d16mm</p>
	<p><b>L1027</b> NO. 55045-01W10 - 55045-01W10LP</p> <p>CASQUILHO DE MOLAS DE TRÁS DO OLHAL DE TRÁS</p> <p>NISSAN PICK-UP 720</p> <p>d48x37mm d40mm 1f-d17mm</p>		<p><b>L1038</b> NO. 55046-01W00 - 55046-01W10 - 55045-B0700</p> <p>CASQUILHO DE MOLAS TRÁS DO OLHAL DA FRENTE</p> <p>NISSAN DATSUN PICK-UP 720</p> <p>d40x43mm d34mm 1f-d15mm</p>
	<p><b>L1077</b> NO. 54476-F0200</p> <p>CASQUILHO DO ESTICADOR DA SUSPENSÃO</p> <p>NISSAN PICK-UP 720</p> <p>d50x32mm 1f-d22mm</p>		<p><b>L3027</b> NO. 34552-89900</p> <p>CASQUILHO DO PENDURAL DA DIRECÇÃO</p> <p>NISSAN 720</p> <p>NULL NULL</p>
	<p><b>L3030</b> NO. 48544-H1000</p> <p>CASQUILHO DO PENDURAL DA DIRECÇÃO</p> <p>NISSAN NISSAN 720</p> <p>d32x19mm 1f-d16mm</p>		<p><b>L3052</b> NO. 55046-07200</p> <p>CASQUILHO SUPERIOR DO BRAÇO DA SUSPENSÃO FRENTE</p> <p>NISSAN PICK-UP 620</p> <p>d37x40mm d33mm 1f-d16mm</p>
	<p><b>P1031</b> NO. 46431-04100</p> <p>CAPA DE PEDAL TRAVÃO E EMBRAIAGEM</p> <p>NISSAN PICK-UP 520 - PICK-UP 521</p> <p>66x47x10mm NULL</p>		<p><b>R8003</b> NO. 21501-B5000</p> <p>TUBO SUPERIOR DO RADIADOR</p> <p>NISSAN PICK-UP 620 MOTOR SD22 1.5 (1972 A 10-1973)</p> <p>B175-d28/28mm 195-170mm</p>
	<p><b>R8004</b> NO. 21501-B5011</p> <p>TUBO SUPERIOR DO RADIADOR</p> <p>NISSAN PICK-UP 620 (UTILITÁRIO 1.5) (11-1973 A 1979)</p> <p>B190-d27/27mm 65-50-100-110mm</p>		<p><b>R8006</b> NO. 21503-B5010</p> <p>TUBO INFERIOR DO RADIADOR</p> <p>NISSAN PICK-UP 620 (UTILITÁRIO 1.5) (1972 A 1979)</p> <p>B260-d34/34mm 75-200100mm</p>

	<b>R8008</b> NO. TUBO SUPERIOR DO RADIADOR NISSAN PICK-UP 620 UTILITÁRIO 1.5 11-73 (APÓS 1979) B230-d27/27mm 75-140-155mm		<b>R8009</b> NO. 21503-B5011 TUBO INFERIOR DO RADIADOR NISSAN PICK-UP 620 B310-d34/34mm 120-175-150mm
	<b>R8012</b> NO. 21503-W2300 TUBO INFERIOR DO RADIADOR NISSAN PICK-UP 720 (ATÉ 80) B345-d34/34mm 120-130-115-125-110mm		<b>R8019</b> NO. 21069-61500 TUBO BY-PASS DA BOMBA DE ÁGUA NISSAN 720 SD22 4WD (1980 A 1982) - 720 SD22 SD23 2WD (1980 A 1985) B90-d26/26mm 100-100mm
	<b>R8025</b> NO. 21501-53Y00 - 21501-53Y01 TUBO DE RADIADOR NISSAN PICK-UP 720 NULL NULL		<b>R8109</b> NO. 2150111W01 TUBO SUPERIOR DO RADIADOR NISSAN PICK-UP 720 UTILITÁRIO 1.8 (L18 GASOLINA) (1980 A 1985) B270-d34-d34mm 70-50-60-50-70mm
	<b>RT80077</b> NO. 4621109W01 TUBO DE TRAVÃO FRENTE RH NISSAN PICK UP (720) (01-1983 A 03-1986) FB43 OR39 345mm FB43 - OR39		<b>RT80078</b> NO. 4621009W01 TUBO DE TRAVÃO FRENTE LH NISSAN PICK UP (720) (01-1983 A 03-1986) FA5 OR40 345mm FA5 - OR40
	<b>RT80079</b> NO. 4621179944 TUBO DE TRAVÃO TRÁS LH-RH NISSAN PICK UP (720) (01-1983 A 03-1986) FB48 MC50 438mm FB48 - MC50		<b>RT80080</b> NO. 4620489911 - 4621401A11 - 4621489911 - 46214-79911 TUBO DE TRAVÃO FRENTE LH-RH NISSAN PICK UP (720) (01-1983 A 03-1986) FB52 FB52 261mm FB52 - FB52
	<b>RT80081</b> NO. 4621179966 TUBO DE TRAVÃO TRÁS LH-RH NISSAN PICK UP (720) (01-1983 A 03-1986) FB31 MC49 559mm FB31 - MC40		<b>S1015</b> NO. 55045-B5000 SILENT-BLOC DE MOLAS DE TRÁS NISSAN DATSUN PICK-UP 620 d41x69mm c61mm 1f-16mm
	<b>S1015-B</b> NO. 55045-B5000 SILENT-BLOC DE MOLAS DE TRÁS NISSAN DATSUN PICK-UP 620 d41x69mm c61mm 1f-16mm		<b>S1141</b> NO. 54423-B9500 SILENT-BLOC INFERIOR DA MOLA DA FRENTE NISSAN DATSUN 720 - 620 d36x81mm c64mm 1f-d18mm
	<b>S1172</b> NO. 54506-B9500 - 1954757 SILENT-BLOC DO BRAÇO SUPERIOR DA SUSPENSÃO NISSAN PICK-UP 720 d47x48mm d41mm 1f-d17.5mm		<b>S1173</b> NO. 54423-04300 SILENT-BLOC DO BRAÇO INFERIOR DA SUSPENSÃO NISSAN PICK-UP 620 d36x68mm c64mm 1f-d18mm

	<b>T0021</b> NO. 54613-14900 BATERENTE DA BARRA ESTABILIZADORA NISSAN DATSUN PICK-UP 620 - NISSAN DATSUN PICK-UP 720		<b>T1106</b> NO. 54613-88G00 BATERENTE DA BARRA ESTABILIZADORA DA FRENTE NISSAN PICK-UP 720
	40x38x32mm 1f-d21mm		52x38x37mm 1f-d24mm
	<b>U7002</b> NO. 15255-T8200 TAMPÃO DO ÓLEO NISSAN PICK-UP 720 PRO - SD23		
	d55x25mm NULL		

NISSAN PRAIRIE (M10)-(M11)







	<b>E0018</b> NO. 17565-15010 ESTICADOR DE ESCAPE NISSAN PRAIRIE (APÓS 88)		<b>E0038</b> NO. 20650-50A00 - 20650-70A10 - 20651-90J02 - 20650-60V00 ESTICADOR DE ESCAPE NISSAN PRAIRIE (APÓS 82)
	68x54x25mm NULL		60x42x19mm NULL
	<b>E1034</b> NO. 20650D0100 - 20650V5000 - 20650V5200 - 2065041L00 - 206509C000 - 2066029R00 ESTICADOR DE ESCAPE NISSAN PRAIRIE (1986 A 1992)		<b>F0511-I</b> NO. 44315-SA2-003 - 44315-SA5-003 - 44325-SB0-300 - 39155-M7270 FOLE DO SEMI-EIXO EXTERNO NISSAN PRAIRIE 1.8(APÓS 8-82)
	72x62x35mm 2f-d11mm		d89x91mm 1f-d75mm 1f-d21mm
	<b>F0694-I</b> NO. 39241-16R00 - 39241-16R25 FOLE DO SEMI-EIXO EXTERNO NISSAN PRAIRIE M10 1.8 (1-86 A 8-88) - M11 2.0		<b>F1201-I</b> NO. 39741-01E25 - 39741-01E00 - 39741-01E88 - 39741-01E28 - 39741-01E26 - 39741-01E89 FOLE DA TRANSMISSÃO LADO DA CAIXA NISSAN PRAIRIE 2.0 4x4 (06-1986 A 09-1988) - 2.4i 4x4 (06-1992 A 12-1995)
	d90x86mm 1f-d23mm 1f-d79mm		d95x100mm 1f-d84mm 1f-d22mm
	<b>F1202-I</b> NO. 39241-10E25 - 39241-10E26 FOLE DE TRANSMISSÃO JUNTO À RODA NISSAN PRAIRIE 2.0 - AUSTER 1.8 AT - STANZA 1.8 AT - MAXIMA 2.0 - 3.0 - AVENIR 2.0 - DATSUN TRUCK - CARAVAN		<b>F1333-I</b> NO. 48203-10V00 - 48203-10V25 - 48203-33P00 - 48203-33P01 - 48203-41B27 - 48204-53Y25 - 48203-50Y25 - 48203-50Y26 FOLE DIRECÇÃO ASSISTIDA DIREITO E ESQUERDO NISSAN PRAIRIE 2.0
	d109x96mm 1f-d95mm 1f-d23mm		d66x145mm 1f-d37mm 1f-d9mm
	<b>KF1635</b> NO. 3924101E25 - 3924101E00 - 3924101E26 - 3924101E27 - 3924101E28 - 3924101E29 - 3924101E85 - 3924101E8... KIT DE FOLE DO CARDAN LADO DA RODA NISSAN PRAIRIE 2.0 4X4 (07-86 A03-89) - 2.4i 4X4 (06-92 A 12-95)		<b>KF1645</b> NO. 3824101E26 - 3924110E02 KIT DE FOLE NISSAN PRAIRIE 2.0 (1983 A 1988)
	d97x96mm 1f-d86mm 1f-d22mm		d108x92mm 1f-d95mm 1f-d23mm

	<p><b>KF1670</b> NO. 3924116R00 - 3924116R25</p> <p><i>KIT DE FOLE LADO DA RODA</i></p> <p>NISSAN PRAIRIE 1.8 (1983 A 1988) - 2.0i (1988 A 1994)</p>		<p><b>KF1691</b> NO. 39241-01E29 - 39741-4F125</p> <p><i>KIT DE FOLE DO CARDAN JUNTO À RODA</i></p> <p>NISSAN PRAIRIE 2.0 4X4 (06-1986 A 09-1988) - PRAIRIE PRO 2.4i - 2.4i 4X4 (04-1992 A 07-1994)</p>
	<p><b>KF2327</b> NO. 39241-16R00 - 39241-16R25 - 39241-16R27</p> <p><i>KIT DE FOLE DO CARDAN JUNTO À RODA</i></p> <p>NISSAN PRAIRIE 1.8 SGL (1983 A 1988) - PRAIRIE PRO 2.0i (1988 A 1994)</p>		<p><b>L3017</b> NO. 20136B5001 - 20136M7080</p> <p><i>CASQUILHO DE ESCAPE</i></p> <p>NISSAN PRAIRIE (1983 A 1987)</p>
	<p><b>L3018</b> NO. 20136B5001 - 20136M7080</p> <p><i>CASQUILHO DE ESCAPE</i></p> <p>NISSAN PRAIRIE (1983 A 1987)</p>		<p><b>M6105</b> NO. 20692-M3060 - 20692-V6200 - 20692-31G02 - 20692-M3080</p> <p><i>JUNTA DE ESCAPE</i></p> <p>NISSAN PRAIRIE (1986 A 1992)</p>
	<p>NULL NULL</p>		<p>116x80x2mm 1f-d49mm</p>

## NISSAN PRIMASTAR

	<p><b>E1117</b> NO. 2065100QAB</p> <p><i>ESTICADOR DO ESCAPE</i></p> <p>NISSAN PRIMASTAR Autocarro (X83) dCi 80 (A Partir de 03.01) 80cv 1870cc Autocarro - NISSAN PRIMASTAR Autocarro (X83) dCi 100 (A Partir de 03.01) 101cv 1870cc Autocarro - NISSAN PRIMASTAR Autocarro (X83) dCi 140 (A Partir de 07.03) 135cv 2464cc Autocarro - NISSAN PRIMASTAR Caixa (X83) 1.9 dCi 80 (A Partir de 09.02) 82cv 1870cc Caixa - NISSAN PRIMASTAR Caixa (X83) 1.9 dCi 100 (A Partir de 09.02) 100cv 1870cc Caixa - NISSAN PRIMASTAR Caixa...etc.</p>		<p><b>KF1686-T</b> NO. 39241-BU125 - 39241-BU185 - 39241-BU186</p> <p><i>KIT DE FOLE DO CARDAN JUNTO À RODA</i></p> <p>NISSAN PRIMASTAR 1.9DCi - 2.0i - 2.5DCi (APÓS 2002)</p>
	<p><b>RT80200</b> NO. 4624200QAA</p> <p><i>TUBO DE TRAVÃO FRENTE LH-RH</i></p> <p>NISSAN PRIMASTAR TT (APÓS 03-2001)</p>		<p><b>RT80201</b> NO. 4621300QAA</p> <p><i>TUBO DE TRAVÃO TRÁS LH-RH</i></p> <p>NISSAN PRIMASTAR TT (APÓS 03-2001)</p>
	<p><b>RT80252</b> NO. 4621300QAC</p> <p><i>TUBO DE TRAVÃO TRÁS LH-RH</i></p> <p>NISSAN PRIMASTER TT (APÓS 03-2001)</p>		<p><b>W5083</b> NO. 12303AW300 - 12309AW300</p> <p><i>POLIE DA CAMBOTA (7 PISTAS)</i></p> <p>NISSAN PRIMASTAR Autocarro (X83) - dCi 150 145CV 2464cc (APÓS 09-2006) - PRIMASTAR Caixa (X83) - dCi 150 145CV 2464cc (APÓS 09-2006)</p>
	<p>415mm FZ - MC11</p>		<p>d105x130mm 1f-d90mm 1f-d27mm</p>
			<p>230mm FZ - FZ</p>
	<p>250mm FZ - MC11</p>		<p>d152/162mm d30/58mm</p>

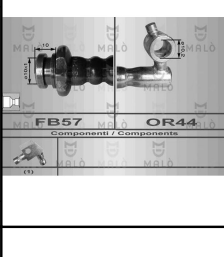
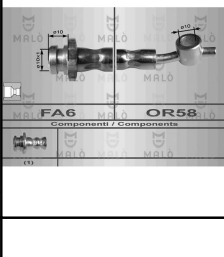
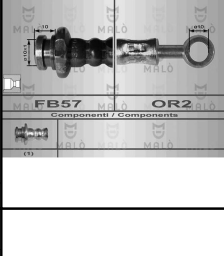
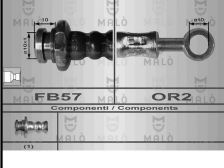
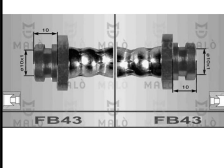

	<b>KF1684-T</b> NO. 39241-BM725 - 39241-BM726 KIT DE FOLE DO CARDAN JUNTO À RODA NISSAN PRIMERA 1.6i - 1.8i (APÓS 2002)		<b>KF1685-T</b> NO. 39241-BM725 - 39241-BM726 KIT DE FOLE DO CARDAN JUNTO À RODA NISSAN PRIMERA (APÓS 2002) 1.6i - 1.8i
	d96x123mm 1f-d83mm 1f-d23mm		d96x123mm 1f-d82mm 1f-d24mm
	<b>KF1686-T</b> NO. 39241-BU125 - 39241-BU185 - 39241-BU186 KIT DE FOLE DO CARDAN JUNTO À RODA NISSAN PRIMERA 2.0i - 2.2Di - 2.2DCi (APÓS 2002)		<b>KF1696</b> NO. KIT DE FOLE DO CARDAN JUNTO À RODA NISSAN PRIMERA 1.6i - 1.6 - 2.0D (1990 A 1998) PRIMERA 1.6i (1996 A 2002)
	d105x130mm 1f-d90mm 1f-d27mm		d93x87mm 1f-d78mm 1f-d20mm
	<b>KF1697</b> NO. 3924171J25 KIT DE FOLE NISSAN PRIMERA 1.8i - 2.0i - 2.0TD (1990 A 2002)		<b>KF2271-T</b> NO. 39241-AW326 KIT DE FOLE DO CARDAN JUNTO À RODA NISSAN PRIMERA 1.9 DCi - 2.0i (APÓS 2002)
	d92x105mm 1f-d84mm 1f-d23mm		d105x125mm 1f-d83mm 1f-d25mm
	<b>KF3350-T</b> NO. 39241-AW325 KIT DE FOLE DO CARDAN JUNTO À RODA NISSAN PRIMERA 1.9 Dci (APÓS 2002)		<b>M6019</b> NO. 2069177A00 - 206919C000 JUNTA DE ESCAPE NISSAN PRIMERA (1990 A 1992)
	d100x125mm 1f-d93mm 1f-d27mm		d51x4mm 1f-d43.6mm
	<b>M6044</b> NO. 20692P9000 - 2069265J00 JUNTA DE ESCAPE NISSAN PRIMERA (APÓS 1990)		<b>RT80089</b> NO. 4621190J00 - 46211-50J60 TUBO DE TRAVÃO FRENTE LH NISSAN PRIMERA TT (06-1990 A 06-1996)
	132x96mm 1f-d64mm		455mm FB57 - OR44
	<b>RT80090</b> NO. 4621490J00 TUBO DE TRAVÃO TRÁS LH-RH NISSAN PRIMERA TT (06-1990 A 06-1996)		<b>RT80091</b> NO. 462102F001 TUBO DE TRAVÃO FRENTE RH NISSAN PRIMERA TT (APÓS 07-1996)
	310mm FB57 - FB57		421mm FA6 - OR58
	<b>RT80092</b> NO. 462102F002 TUBO DE TRAVÃO FRENTE LH NISSAN PRIMERA TT (APÓS 07-1996)		<b>RT80093</b> NO. 462102F205 - 46210-8F800 TUBO DE TRAVÃO TRÁS RH NISSAN PRIMERA TT (APÓS 07-1996)
	421mm FB57 - OR59		590mm FB57 - OR2
	<b>RT80094</b> NO. 462102F206 - 46210-8F801 TUBO DE TRAVÃO TRÁS LH NISSAN PRIMERA TT (APÓS 07-1996)		<b>RT80100</b> NO. 4621401A17 TUBO DE TRAVÃO DE TRÁS LH-RH NISSAN PRIMERA Traveller (W10) 1.6 i Versão: Tamburo post. (07.90 A 03.98) 90cv 1597cc Combi - NISSAN PRIMERA Traveller (W10) 1.6 i Versão: Tamburo post. (02.91 A 03.98) 102cv 1597cc Combi - NISSAN PRIMERA Traveller (W10) 2.0 i Versão: Tamburo post. (07.90 A 03.98) 116cv 1998cc Combi - NISSAN PRIMERA Traveller (W10) 2.0 D Versão: Tamburo post. (07.90 A 12.95) 75cv 1974cc Combi
	581mm FB57 - OR2		325mm FB43 - FO43

	<p><b>RT80239</b> NO. 462142F001</p> <p>TUBO DE TRAVÃO DE TRÁS LH-RH</p> <p>NISSAN PRIMERA Hatchback (P11) 1.6 16V (09.96 A 07.02) 90cv 1597cc Hatchback - NISSAN PRIMERA Hatchback (P11) 1.6 16V (09.96 A 07.02) 99cv 1597cc Hatchback - NISSAN PRIMERA Hatchback (P11) 1.6 16V (09.00 A 07.02) 106cv 1597cc Hatchback - NISSAN PRIMERA Hatchback (P11) 1.8 16V (08.99 A 07.02) 114cv 1769cc Hatchback - NISSAN PRIMERA Hatchback (P11) 2.0 16V (09.96 A 07.02) 131cv 1998cc Hatchback - NISSAN PRIMERA Hatchback (P11) 2.0 16V (08.99 A...etc.</p> <p>350mm FB57 - FB57</p>		<p><b>S1192</b> NO.</p> <p>SILENT-BLOC DO BRAÇO DA SUSPENSÃO DA FRENTE PARTE CENTRAL</p> <p>NISSAN PRIMERA (APÓS 9-1994)</p> <p>d38x50mm c40mm 1f-d18mm</p>
	<p><b>S1194</b> NO. 54570 - 50J00</p> <p>SILENT-BLOC DO BRAÇO DA SUSPENSÃO DA FRENTE LADO EXTERNO</p> <p>NISSAN PRIMERA (APÓS 9-1994)</p> <p>70x59x57mm 1f-d21mm</p>		<p><b>S1571</b> NO. 54500-2F500</p> <p>SILENTBLOC DO BRAÇO ESQUERDO DA SUSPENSÃO DA FRENTE</p> <p>NISSAN PRIMERA Hatchback (P11) 1.6 16V Local de montagem: em baixo - Local de montagem: à direita 09.96 - 07.02 66 90 1597 Hatchback NISSAN PRIMERA Hatchback (P11) 1.6 16V Local de montagem: em baixo - Local de montagem: à direita 09.96 - 07.02 73 99 1597 Hatchback NISSAN PRIMERA Hatchback (P11) 1.6 16V Local de montagem: em baixo - Local de montagem: à direita 09.00 - 07.02 78 106 1597 Hatchback NISSAN PRIMERA Hatchback (P11) 1.8 16V Lo...etc.</p> <p>145x60x80mm 1f-d21mm 1f-15mm 1f-20x15mm</p>
	<p><b>S1572</b> NO. 54501-2F500</p> <p>SILENTBLOC DO BRAÇO DIREITO DA SUSPENSÃO DA FRENTE</p> <p>NISSAN PRIMERA Hatchback (P11) 1.6 16V Local de montagem: em baixo - Local de montagem: esquerda (09.96 A 07.02) 90cv 1597cc Hatchback - NISSAN PRIMERA Hatchback (P11) 1.6 16V Local de montagem: em baixo - Local de montagem: esquerda (09.96 A 07.02) 99cv 1597cc Hatchback - NISSAN PRIMERA Hatchback (P11) 1.6 16V Local de montagem: em baixo - Local de montagem: esquerda (09.00 A 07.02) 106cv 1597cc Hatchback - NISSAN PRIMERA Hatchback (P11) 1.8...etc.</p> <p>145x60x80mm 1f-d21mm 1f-15mm 1f-20x15mm</p>		<p><b>T1155</b> NO. 546132Y003 - 546134U006 - 546134U004</p> <p>BATENTE DA BARRA ESTABILIZADORA DA FRENTE</p> <p>NISSAN PRIMERA Hatchback (P12) 1.6 (APÓS 07.02) 106cv 1597cc Hatchback - NISSAN PRIMERA Hatchback (P12) 1.6 (APÓS 07.02) 109cv 1597cc Hatchback - NISSAN PRIMERA Hatchback (P12) 1.8 (APÓS 07.02) 115cv 1769cc Hatchback - NISSAN PRIMERA Hatchback (P12) 2.0 (APÓS 07.02) 140cv 1998cc Hatchback - NISSAN PRIMERA Hatchback (P12) 1.9 dCi (APÓS 08.02) 116cv 1870cc Hatchback - NISSAN PRIMERA Hatchback (P12) 1.9 dCi (APÓS 04.03) 120cv 1870cc Hat...etc.</p> <p>36x49x46mm 1f-d23mm</p>
	<p><b>W5128</b> NO. 12303000OBD - 12303AW300 - 12309AW300 - 1261967JG1 - 12303-00QBD</p> <p>POLIE DA CAMBOTA (7 PISTAS)</p> <p>NISSAN PRIMERA Hatchback (P12) 1.9 dCi (APÓS 04-2003) 120CV 1870CC - NISSAN PRIMERA (P12) 1.9 dCi (APÓS 04-2003) 120CV 1870CC - NISSAN PRIMERA Combi (WP12) 1.9 dCi (APÓS 04-2003) 120CV 1870CC</p> <p>d155mm 1f-d25mm</p>		<p><b>Z80823</b> NO. 6385401A00 - NA0156145</p> <p>Rebite</p> <p>NISSAN PRIMERA</p> <p>d20x33mm 1p-d8-20mm</p>

NISSAN PULSAR-LANGLEY-LIBERTA VILLA-PRESEA

	<p><b>F0066-I</b> NO. 39741-01M25 - 39741-01M29 - 40089-M0200 - 40088-M0820</p> <p>FOIE DO SEMI-EIXO LADO DA RODA</p> <p>NISSAN PULSAR - LANGLEY - LIVERTA - VILLA 1.2-1.3(APÓS 78)</p> <p>d88x84mm 1f-d64mm 1f-d19mm</p>		<p><b>F0511-I</b> NO. 44315-SA2-003 - 44315-SA5-003 - 44325-SB0-300 - 39155-M7270</p> <p>FOIE DO SEMI-EIXO EXTERNO</p> <p>NISSAN PULSAR - LANGLEY - LIVERTA - VILLA(APÓS 78 A 82) - VILLA 1.5(APÓS 83)</p> <p>d89x91mm 1f-d75mm 1f-d21mm</p>
	<p><b>F0512-I</b> NO. 39241-01B25 - 39241-01M00 - 39241-01M29 - 39241-11M00 - 39241-11M25</p> <p>FOIE DO SEMI-EIXO EXTERNO</p> <p>NISSAN PULSAR - LANGLEY - LIVERTA SPRIT 1.3 (APÓS 5-82)</p> <p>d83x85mm 1f-d72mm 1f-d22mm</p>		<p><b>F0694-I</b> NO. 39241-16R00 - 39241-16R25</p> <p>FOIE DO SEMI-EIXO EXTERNO</p> <p>NISSAN PULSAR N13 1.5 (5-86 A 4-88) - N13 1.6 (5-86 A 7-90) - LANGLEY - LIVERTA - VILLA N3 1.5 - 1.6 (10-86 A 10-91) - EKA KN13 1.6 (10-86 A 10-91)</p> <p>d90x86mm 1f-d23mm 1f-d79mm</p>
	<p><b>F0706-I</b> NO. 39741-11M00 - 40088-M0820 - 40089-M0825</p> <p>FOIE DO SEMI-EIXO EXTERNO</p> <p>NISSAN PULSAR - LANGLEY - LIVERTA - VILLA 1.4</p> <p>d89x92mm 1f-d76mm 1f-d22mm</p>		<p><b>F1200-I</b> NO. 39241-01E25 - 39241-01E27 - 39241-01E28 - 39241-0M326 - 39241-64J25 - 39241-63Y25 - 39241-01E26 - 39241-01E27</p> <p>FOIE DA TRANSMISSÃO LADO DA RODA</p> <p>NISSAN PRESEA 1.8</p> <p>d97x96mm 1f-d86mm 1f-d22mm</p>

	<b>F1200-I</b> NO. 39241-01E25 - 39241-01E27 - 39241-01E28 - 39241-0M326 - 39241-64J25 - 39241-63Y25 - 39241-01E26 - 39241-01E27		<b>F1201-I</b> NO. 39741-01E25 - 39741-01E00 - 39741-01E88 - 39741-01E28 - 39741-01E26 - 39741-01E89
FOLE DA TRANSMISSÃO LADO DA RODA NISSAN PULSAR 1.5 - 1.6 - 1.7		FOLE DA TRANSMISSÃO LADO DA CAIXA NISSAN PRESEA 1.8	
d97x96mm 1f-d86mm 1f-d22mm		d95x100mm 1f-d84mm 1f-d22mm	
	<b>F1201-I</b> NO. 39741-01E25 - 39741-01E00 - 39741-01E88 - 39741-01E28 - 39741-01E26 - 39741-01E89		<b>F1214-I</b> NO. 39241-03A25 - 39241-03A26
FOLE DA TRANSMISSÃO LADO DA CAIXA NISSAN PULSAR - LANGLEY - LIBERTA		FOLE DA TRANSMISSÃO LADO DA RODA NISSAN LAUREL 1.3 - 1.5	
d95x100mm 1f-d84mm 1f-d22mm		d92x90mm 1f-d78mm 1f-d20mm	
	<b>F1214-I</b> NO. 39241-03A25 - 39241-03A26		<b>F1214-I</b> NO. 39241-03A25 - 39241-03A26
FOLE DA TRANSMISSÃO LADO DA RODA NISSAN PULSAR 1.3 - 1.5 4WD - 1.6 - 1.7 - LANGLEY 1.2 - N13 1.5 - 1.6 - DATSUN AD VAN 1.3		FOLE DA TRANSMISSÃO LADO DA RODA NISSAN SUNNY 1.3 - 1.5	
d92x90mm 1f-d78mm 1f-d20mm		d92x90mm 1f-d78mm 1f-d20mm	
	<b>KF1625</b> NO. 3924103A25 - 3924103A26		<b>KF1640</b> NO. 39241-11M00 - 39241-11M25 - 39241-11M26
KIT DE FOLE DO CARDAN JUNTO À RODA NISSAN LANGLEY - LIVERTA VILLA - PRESEA - PULSAR		KIT FOLE DO LADO DA RODA NISSAN PULSAR - LANGLEY - LIVERTA VILLA 1.3 - 1.5	
d91x86mm 1f-d20mm 1f-d75mm		d90x85mm 1f-d74mm 1f-d22mm	
	<b>T1028</b> NO. 55149-50A00		
BATENTE DA BARRA ESTABILIZADORA DE TRÁS (CENTRO) NISSAN PULSAR			
58x57x40mm 1f-d23mm			

## NISSAN QASHQAI

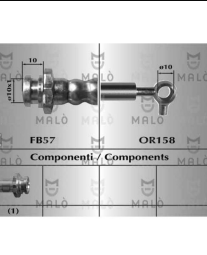
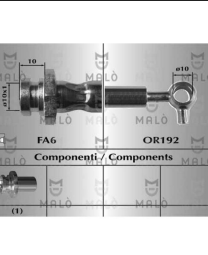
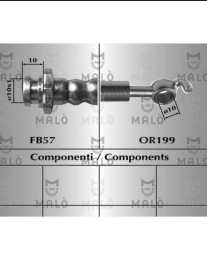
	<b>F1941-I</b> NO.		<b>RT80819</b> NO. 46210JD005
FOLE DO CARDAN LADO DA CAIXA NISSAN - QASHQAI - QASHQAI + 2 (J10 - JJ10) - 2.0 dCi Veículo todo-terreno fechado 150CV 1995cc (APOS 02-2007) - 2.0 dCi Tração integral veiculo todo-terreno fechado 150CV 1995cc (APOS 02-2007)		TUBO DE TRAVÃO DA FRENTE LH NISSAN QASHQAI/QASHQAI +2 I (J10 - JJ10) 1.6 (02.07 A 12.13) 114cv 1598cc Veículo todo-terreno fechado - NISSAN QASHQAI/QASHQAI +2 I (J10 - JJ10) 1.6 (11.10 A 12.13) 117cv 1598cc Veículo todo-terreno fechado - NISSAN QASHQAI/QASHQAI +2 I (J10 - JJ10) 2.0 (02.07 A 12.13) 141cv 1997cc Veículo todo-terreno fechado - NISSAN QASHQAI/QASHQAI +2 I (J10 - JJ10) 2.0 Tração integral (02.07 A 12.13) 141cv 1997cc Veículo todo-terreno fechado - NIS...etc.	
d104x100mm 1f-d28mm 1f-d92mm		635mm FB57 - OR158	
	<b>RT80820</b> NO. 46210JD000		<b>RT80821</b> NO. 46210JD620
TUBO DE TRVÃO DA FRENTE RH NISSAN QASHQAI/QASHQAI +2 I (J10 - JJ10) 1.6 (02.07 A 12.13) 114cv 1598cc Veículo todo-terreno fechado - NISSAN QASHQAI/QASHQAI +2 I (J10 - JJ10) 1.6 (11.10 A 12.13) 117cv 1598cc Veículo todo-terreno fechado - NISSAN QASHQAI/QASHQAI +2 I (J10 - JJ10) 2.0 (02.07 A 12.13) 141cv 1997cc Veículo todo-terreno fechado - NISSAN QASHQAI/QASHQAI +2 I (J10 - JJ10) 2.0 Tração integral (02.07 A 12.13) 141cv 1997cc Veículo todo-terreno fechado - NIS...etc.		TUBO DE TRAVÃO DE TRÁS LH NISSAN QASHQAI/QASHQAI +2 I (J10 - JJ10) 1.6 (02.07 A 12.13) 114cv 1598cc Veículo todo-terreno fechado - NISSAN QASHQAI/QASHQAI +2 I (J10 - JJ10) 1.6 (11.10 A 12.13) 117cv 1598cc Veículo todo-terreno fechado - NISSAN QASHQAI/QASHQAI +2 I (J10 - JJ10) 2.0 (02.07 A 12.13) 141cv 1997cc Veículo todo-terreno fechado - NISSAN QASHQAI /QASHQAI +2 I (J10 - JJ10) 2.0 Tração integral (02.07 A 12.13) 141cv 1997cc Veículo todo-terreno fechado - NI...etc.	
640mm FA6 - OR192		255mm FB57 - OR199	



	<b>RT80822</b> NO. 46210JD610 <b>TUBO DE TRAVÃO DE TRÁS RH</b> NISSAN QASHQAI/QASHQAI +2 I (J10 - JJ10) 1.6 (02.07 A 12.13) 114cv 1598cc Veículo todo-terreno fechado - NISSAN QASHQAI/QASHQAI +2 I (J10 - JJ10) 1.6 (11.10 A 12.13) 117cv 1598cc Veículo todo-terreno fechado - NISSAN QASHQAI/QASHQAI +2 I (J10 - JJ10) 2.0 (02.07 A 12.13) 141cv 1997cc Veículo todo-terreno fechado - NISSAN QASHQAI/QASHQAI +2 I (J10 - JJ10) 2.0 Tração integral (02.07 A 12.13) 141cv 1997cc Veículo todo-terreno fechado - Ni...etc. 255mm FB57 - OR200		<b>T1158</b> NO. 54613JD03A - 54613JG03A <b>BATERIE DA BARRA ESTABILIZADORA DA FRENTE</b> NISSAN QASHQAI/QASHQAI +2 I (J10 - JJ10) 1.6 (02.07 A 12.13) 114cv 1598cc Veículo todo-terreno fechado - NISSAN QASHQAI/QASHQAI +2 I (J10 - JJ10) 1.6 (11.10 A 12.13) 117cv 1598cc Veículo todo-terreno fechado - NISSAN QASHQAI/QASHQAI +2 I (J10 - JJ10) 2.0 (02.07 A 12.13) 141cv 1997cc Veículo todo-terreno fechado - NISSAN QASHQAI/QASHQAI +2 I (J10 - JJ10) 2.0 Tração integral (02.07 A 12.13) 141cv 1997cc Veículo todo-terreno fechado -...etc. 74x47x34mm 1f-d23mm
	<b>T1159</b> NO. 54613-JD18C <b>BATERIE DA BARRA ESTABILIZADORA DE TRÁS</b> NISSAN QASHQAI /QASHQAI +2 I (J10 - JJ10) 1.6 Ano fabric. até: 01.10 (02.07 A 12.13) 114cv 1598cc Veículo todo-terreno fechado - NISSAN QASHQAI /QASHQAI +2 I (J10 - JJ10) 2.0 Ano fabric. até: 01.10 (02.07 A 12.13) 141cv 1997cc Veículo todo-terreno fechado - NISSAN QASHQAI /QASHQAI +2 I (J10 - JJ10) 2.0 Tração integral Ano fabric. até: 01.10 (02.07 A 12.13) 141cv 1997cc Veículo todo-terreno fechado - NISSAN QASHQAI /QASHQAI +2 I (J10 -...etc. 49x51x38mm 1f-d16mm		

NISSAN S CARGO

	<b>KF1625</b> NO. 3924103A25 - 3924103A26 <b>KIT DE FOLE DO CARDAN JUNTO À RODA</b> NISSAN S CARGO 1.3 - 2.6i Bi-T d91x86mm 1f-d20mm 1f-d75mm		



NISSAN SENTRA-B13

	<b>A1681</b> NO. 11211-50Y00 - 11210-75Y01 <b>APOIO DO MOTOR LADO DIREITO</b> NISSAN SUNNY II (N13) Hatchback (1986 A 1991) - SUNNY - SENTRA d74x60mm c40mm 1f-d10mm		<b>F1201-I</b> NO. 39741-01E25 - 39741-01E00 - 39741-01E88 - 39741-01E28 - 39741-01E26 - 39741-01E89 <b>FOLE DA TRANSMISSÃO LADO DA CAIXA</b> NISSAN SENTRA d95x100mm 1f-d84mm 1f-d22mm
	<b>F4042</b> NO. 55240-0M015 - 552400M315 <b>FOLE DOS AMORTECEDORES DE TRÁS</b> NISSAN B14 - SUNNY - SENTRA d70x195mm 1f-d53mm 1f-d16mm		<b>F4043</b> NO. 54052-0M011 <b>FOLE DOS AMORTECEDORES DA FRENTE</b> NISSAN B14 - SUNNY - SENTRA d79x210mm 1f-d65mm 1f-d27mm
	<b>R8119</b> NO. 21501-53Y00B-1 <b>TUBO SUPERIOR DO RADIADOR</b> NISSAN B13 - B14 (A-T) - SUNNY - SENTRA B200-d27/27mm 75-80-60-80mm		<b>T1100</b> NO. 54613-58A00 - 54613-58A10 <b>BATERIE DA BARRA ESTABILIZADORA DA FRENTE</b> NISSAN B12 SUNNY - SENTRA 28x36x41mm 1f-d23mm

## NISSAN SERENA

	<b>E1034</b>	NO. 20650D0100 - 20650V5000 - 20650V5200 - 2065041L00 - 206509C000 - 2066029R00		<b>KF1681</b>	NO. 39172-31G25 - 39712-31G25 - 39741-41W03 - 39741-41W25 - 39741-41W26 - 39741-50W25
	ESTICADOR DE ESCAPE NISSAN SERENA DIESEL (ATÉ 1993)			KIT DE FOLE DO CARDAN JUNTO À CAIXA NISSAN SERENA 1.6i (APÓS 1992)	
72x62x35mm		2f-d11mm	d98x100mm		1f-d85mm 1f-d20mm
	<b>M6019</b>	NO. 2069177A00 - 206919C000		<b>T1160</b>	NO. 54613-1C406 - 54613-1C404
	JUNTA DE ESCAPE NISSAN SERENA (APÓS 1993)			BATENTE DA BARRA ESTABILIZADORA DA FRENTE NISSAN SERENA (C23) 1.6 (02.93 A 09.01) 97cv 1597cc Veículo multiuso - NISSAN SERENA (C23) 2.0 Ano fabric. a partir de: 05.94 (11.92 A 09.01) 126cv 1998cc Veículo multiuso - NISSAN SERENA (C23) 2.0 D Ano fabric. até: 09.94 (11.92 A 09.01) 67cv 1952cc Veículo multiuso - NISSAN SERENA (C23) 2.3 D (01.95 A 09.01) 75cv 2283cc Veículo multiuso	
d51x4mm		1f-d43.6mm	48x48x28mm		1f-d25mm











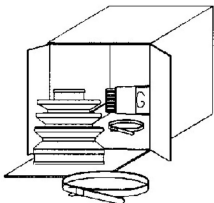

## NISSAN SILVIA

	<b>E1015</b>	NO. 20641-M6810 - 20641-M7060 - 20641-58100 - 20641-U6800 - 20641-U6810		<b>M6044</b>	NO. 20692P9000 - 2069265J00
	ESTICADOR DE ESCAPE NISSAN SILVIA			JUNTA DE ESCAPE NISSAN SILVIA (APÓS 1988)	
59x50x46mm		2p-d8-18mm	132x96mm		1f-d64mm
	<b>M6105</b>	NO. 20692-M3060 - 20692-V6200 - 20692-31G02 - 20692-M3080			
	JUNTA DE ESCAPE NISSAN SILVIA (1983 A 1990)				
116x80x2mm		1f-d49mm			

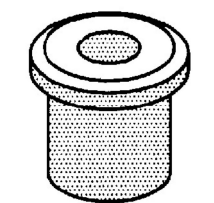
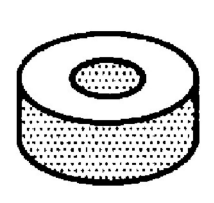
## NISSAN SUNNY-DATSUN 120Y-B210

	<b>A1363</b>	NO. 11211-50Y05 - 11211-50A06		<b>A1662</b>	NO. 11210-50Y00 - 11210-50Y05 - 11210-50Y10 - 11210-50Y11 - 11210-50Y20
	APOIO DE REPARAÇÃO DO MOTOR LADO DIREITO (SUPLEMENTO DO A1681) NISSAN SUNNY II (N13) Hatchback (1986 A 1991)			APOIO DO MOTOR LADO DIREITO NISSAN SUNNY III (Y10) TRAVELLER 1.6i 16V (90CV - 1597cc) (06-1991 A 03-2000)	
d75.5x60mm		c40mm 1f-d10mm	145x79x60		1f-d10mm
	<b>E0018</b>	NO. 17565-15010		<b>E0038</b>	NO. 20650-50A00 - 20650-70A10 - 20651-90J02 - 20650-60V00
	ESTICADOR DE ESCAPE NISSAN SUNNY (APÓS 86)			ESTICADOR DE ESCAPE NISSAN SUNNY (82 A 86)	
68x54x25mm		NULL	60x42x19mm		NULL

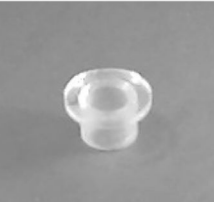
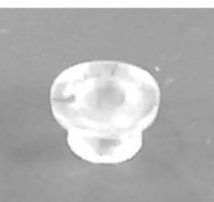
	<p><b>E0044</b> NO. 46803521</p> <p>ESTICADOR DE ESCAPE</p> <p>NISSAN SUNNY (APÓS 82)</p> <p>77x58x20mm NULL</p>		<p><b>E0212M</b> NO. 11350-50Y00 - 11350-41B00 - 11350-50T00</p> <p>ESTICADOR DO MOTOR PARTE DA FRENTE</p> <p>NISSAN SUNNY N13 - N14</p> <p>123x60x44mm 2f-d10.5mm</p>
	<p><b>E1021</b> NO. 20650-50A00 - 20650-70A10 - 20651-90J02 - 20650-60V00</p> <p>ESTICADOR DE ESCAPE</p> <p>NISSAN SUNNY DIESEL</p> <p>68x49x23mm NULL</p>		<p><b>E1034</b> NO. 20650D0100 - 20650V5000 - 20650V5200 - 2065041L00 - 206509C000 - 2066029R00</p> <p>ESTICADOR DE ESCAPE</p> <p>NISSAN SUNNY (1982 A 1986)</p> <p>72x62x35mm 2f-d11mm</p>
	<p><b>F0511-I</b> NO. 44315-SA2-003 - 44315-SA5-003 - 44325-SB0-300 - 39155-M7270</p> <p>FOLE DO SEMI-EIXO EXTERNO</p> <p>NISSAN SUNNY LAUREL SPRIT 1.5(APÓS 81)</p> <p>d89x91mm 1f-d75mm 1f-d21mm</p>		<p><b>F0512-I</b> NO. 39241-01B25 - 39241-01M00 - 39241-01M29 - 39241-11M00 - 39241-11M25</p> <p>FOLE DO SEMI-EIXO EXTERNO</p> <p>NISSAN SUNNY III 1.3 - 1.6 (1986 A 1991)</p> <p>d83x85mm 1f-d72mm 1f-d22mm</p>
	<p><b>F0512-I</b> NO. 39241-01B25 - 39241-01M00 - 39241-01M29 - 39241-11M00 - 39241-11M25</p> <p>FOLE DO SEMI-EIXO EXTERNO</p> <p>NISSAN SUNNY VAN</p> <p>d83x85mm 1f-d72mm 1f-d22mm</p>		<p><b>F0694-I</b> NO. 39241-16R00 - 39241-16R25</p> <p>FOLE DO SEMI-EIXO EXTERNO</p> <p>NISSAN SUNNY II 1.5 (1982 A 1986)</p> <p>d90x86mm 1f-d23mm 1f-d79mm</p>
	<p><b>F0887-I</b> NO. 48203-01F00 - 48203-04A00 - 48203-11B00 - 48203-70A00 - 48203-W1000 - 48203-W1025 - 48204-01F00 - 48203-40</p> <p>FOLE DA CREMALHEIRA DA DIRECÇÃO DIREITO</p> <p>NISSAN SUNNY(APÓS 86)</p> <p>d58x160mm 1f-d31mm 1f-d9mm</p>		<p><b>F0888-I</b> NO. 48204-01F00 - 48204-04A01 - 48204-W1000 - 48203-W1000 - 48204-50Y25</p> <p>FOLE DA CREMALHEIRA DA DIRECÇÃO ESQUERDO</p> <p>NISSAN SUNNY(APÓS 86)</p> <p>d59x205mm 1f-d31mm 1f-d9mm</p>
	<p><b>F1200-I</b> NO. 39241-01E25 - 39241-01E27 - 39241-01E28 - 39241-0M326 - 39241-64J25 - 39241-63Y25 - 39241-01E26 - 39241-01E28</p> <p>FOLE DA TRANSMISSÃO LADO DA RODA</p> <p>NISSAN CALIFORNIA Y10 1.5 4WD</p> <p>d97x96mm 1f-d86mm 1f-d22mm</p>		<p><b>F1200-I</b> NO. 39241-01E25 - 39241-01E27 - 39241-01E28 - 39241-0M326 - 39241-64J25 - 39241-63Y25 - 39241-01E26 - 39241-01E28</p> <p>FOLE DA TRANSMISSÃO LADO DA RODA</p> <p>NISSAN SUNNY 1.5 - 1.6 - 1.8</p> <p>d97x96mm 1f-d86mm 1f-d22mm</p>
	<p><b>F1201-I</b> NO. 39741-01E25 - 39741-01E00 - 39741-01E88 - 39741-01E28 - 39741-01E26 - 39741-01E89</p> <p>FOLE DA TRANSMISSÃO LADO DA CAIXA</p> <p>NISSAN SUNNY III 1.6i 12V (1986 A 1991) - 1.6i 12V 4x4 (1988 A 1990) - SUNNY IV 1.6i 16V (1990 A 1995) - 1.6i 16V 4x4 (1992 A 1995) - 2.0i Gti 16V (1990 A 1995)</p> <p>d95x100mm 1f-d84mm 1f-d22mm</p>		<p><b>F1237-I</b> NO. 39241-0M325</p> <p>FOLE DA TRANSMISSÃO LADO DA RODA</p> <p>NISSAN SUNNY 1.6i (1990 A 1995)</p> <p>d96x100mm 1f-d80mm 1f-d23mm</p>
	<p><b>KF1612</b> NO. 3924153J25 - 3924153J26</p> <p>KIT DE FOLE DO CARDAN LADO DA RODA</p> <p>NISSAN SUNNY 1.6i (01-1991 A 10-1995) - 1.6i ABS (01-1991 A 10-1995) - 1.6i WAGON (01-1994 A 08-1996) - 1.8i 16V GTI (03-1989 A 12-1990)</p> <p>d100x100mm 1f-d83mm 1f-d23mm</p>		<p><b>KF1625</b> NO. 3924103A25 - 3924103A26</p> <p>KIT DE FOLE DO CARDAN JUNTO À RODA</p> <p>NISSAN SUNNY II 1.3 - 1.7D - (1982 A 1990) - SUNNY III 1.3 - 1.4 - 1.6 (1986 A 1990) - SUNNY IV 1.4 - 1.4i - 2.0D (1990 A 1995)</p> <p>d91x86mm 1f-d20mm 1f-d75mm</p>

	<p><b>KF1635</b> NO. 3924101E25 - 3924101E00 - 3924101E26 - 3924101E27 - 3924101E28 - 3924101E29 - 3924101E85 - 3924101E8...</p> <p>KIT DE FOLE DO CARDAN LADO DA RODA</p> <p>NISSAN SUNNY 1.3 (07-84 A 08-86) - 1.4i 16V AUTOM. (11-94 A 10-95) - 1.5 (07-84 A 08-86) - 1.6i (01-91 A 10-95) - 1.6i WAGON (01-91 A 12-93) - 1.7D (08-84 A 08-86) - 2.0i 16V GTI (01-91 A 09-94) - 2.0i T 16V GTIR 4X4 (03-92 A 12-92)</p> <p>d97x96mm 1f-d86mm 1f-d22mm</p>		<p><b>KF1640</b> NO. 39241-11M00 - 39241-11M25 - 39241-11M26</p> <p>KIT FOLE DO LADO DA RODA</p> <p>NISSAN SUNNY III 1.3 - 1.6 (1986 A 1990)</p> <p>d90x85mm 1f-d74mm 1f-d22mm</p>
	<p><b>KF1670</b> NO. 3924116R00 - 3924116R25</p> <p>KIT DE FOLE LADO DA RODA</p> <p>NISSAN SUNNY 1.5 B11 (1982 A 1990)</p> <p>d86x84mm 1f-d76mm 1f-d22mm</p>		<p><b>KF1691</b> NO. 39241-01E29 - 39741-4F125</p> <p>KIT DE FOLE DO CARDAN JUNTO A RODA</p> <p>NISSAN SUNNY II 1.3 - 1.5 - 1.7D (03-1982 A 08-1990) - SUNNY III 1.4 - 1.6i - 1.6i 12V - 1.6i 12V 4X4 - 1.6i Gti 16V (06-1986 A 06-1991) - SUNNY IV 1.4i 16V - 1.6i 16V - 1.6i 16V 4X4 - 2.0i Gti 16V - 2.0i Gti -R 4X4 (1990 A 1995)</p> <p>d94x95mm 1f-d80mm 1f-d21mm</p>
	<p><b>KF1696</b> NO.</p> <p>KIT DE FOLE DO CARDAN JUNTO A RODA</p> <p>NISSAN SUNNY 2 1.3 - 1.5 (1982 A 1990)</p> <p>d93x87mm 1f-d78mm 1f-d20mm</p>		<p><b>KF1945</b> NO. 39241-OM626</p> <p>KIT DE FOLE DO CARDAN JUNTO A RODA</p> <p>NISSAN SUNNY IV 1.6i 16V (1990 A 1995)</p> <p>d93x94mm 1f-d83mm 1f-d24mm</p>
	<p><b>KF2327</b> NO. 39241-16R00 - 39241-16R25 - 39241-16R27</p> <p>KIT DE FOLE DO CARDAN JUNTO A RODA</p> <p>NISSAN SUNNY II 1.5 - 1.6 - 1.6i (1982 A 1990)</p> <p>d86x84mm 1f-d76mm 1f-d22mm</p>		<p><b>L0250</b> NO. 55044-H5001</p> <p>CASQUILHO MOLA DE TRÁS</p> <p>NISSAN SUNNY</p> <p>d29x45mm d22mm 1f-d11mm</p>
	<p><b>L1008</b> NO. 56125-18000</p> <p>CASQUILO DA BARRA ESTABILIZADORA</p> <p>NISSAN DATSUN 1200 - 100A - 120Y</p> <p>d21x14mm 1f-d8mm</p>		<p><b>L3017</b> NO. 20136B5001 - 20136M7080</p> <p>CASQUILHO DE ESCAPE</p> <p>NISSAN SUNNY (1982 A 1986) - 120Y (1979 A 1982)</p> <p>NULL NULL</p>
	<p><b>L3018</b> NO. 20136B5001 - 20136M7080</p> <p>CASQUILHO DE ESCAPE</p> <p>NISSAN SUNNY (1982 A 1986) - 120Y (1979 A 1982)</p> <p>NULL NULL</p>		<p><b>L3024</b> NO. 55193-50A00</p> <p>CASQUILHO DA BARRA ESTABILIZADORA TRÁS (PONTAS)</p> <p>NISSAN SUNNY B12 - B13 - N13 (1986 A 1990)</p> <p>d41x34mm 1f-d20mm</p>
	<p><b>L3026</b> NO. 32855-H1010</p> <p>CASQUILHO DO PENDURAL DA DIRECÇÃO</p> <p>NISSAN B210 - B310 - BLUEBIRD - SUNNY - SENTRA</p> <p>d18x10mm d12mm 1f-d9mm</p>		<p><b>L3027</b> NO. 34552-89900</p> <p>CASQUILHO DO PENDURAL DA DIRECÇÃO</p> <p>NISSAN SUNNY B11</p> <p>NULL NULL</p>
	<p><b>L3030</b> NO. 48544-H1000</p> <p>CASQUILHO DO PENDURAL DA DIRECÇÃO</p> <p>NISSAN SUNNY B11</p> <p>d32x19mm 1f-d16mm</p>		<p><b>L3091</b> NO. 54476-Q0101</p> <p>CASQUILHO DO ESTICADOR DA SUSPENSÃO</p> <p>NISSAN SUNNY</p> <p>d52x31mm 1f-d16mm</p>

	<p><b>M6019</b> NO. 2069177A00 - 206919C000</p> <p>JUNTA DE ESCAPE</p> <p>NISSAN SUNNY (1986 A 1992)</p> <p>d51x4mm 1f-d43.6mm</p>		<p><b>M6020</b> NO. 206911B00</p> <p>JUNTA DE ESCAPE</p> <p>NISSAN SUNNY (1990 A 1996)</p> <p>d46x4mm 1f-d38.5mm</p>
	<p><b>M6044</b> NO. 20692P9000 - 2069265J00</p> <p>JUNTA DE ESCAPE</p> <p>NISSAN SUNNY (APÓS 1991)</p> <p>132x96mm 1f-d64mm</p>		<p><b>RT80053</b> NO. 4621050Y02 - 4621050Y12 - 46210-97N01 - 46214-79917</p> <p>TUBO DE TRAVÃO FRENTE LH</p> <p>NISSAN SUNNY II N13 1.4 - 1.6 - 2.0D (10-1990 A 05-1995) - 1.4 - 1.6 - 2.0 GTI - 2.0 4X4 - 2.0D (10-1990 A 05-1995) - SUNNY III (N14-Y10) 1.6 - 1.6 4WD - 2.0D (APÓS 06-1991) - 1.6 - 1.7D (05-1992 A 04-1996)</p> <p>500mm FB43 - OR33</p>
	<p><b>RT80054</b> NO. 4621050Y07 - 46210-50Y15 - 46210-50Y17</p> <p>TUBO DE TRAVÃO FRENTE RH</p> <p>NISSAN SUNNY II N13 1.4 - 1.6 - 2.0 D (10-1990 A 05-1995) - 1.4 - 1.6 - 2.0 GTI - 2.0 4X4 - 2.0 D (10-1990 A 05-1995) - SUNNY III (N14 - Y10) 1.6 - 1.6 4WD - 2.0 D (APÓS 06-1991) - 1.6 - 1.7 D (05-1992 A 04-1996)</p> <p>497mm FA5 - OR33</p>		<p><b>RT80066</b> NO. 4621489914 - 4621040R00 - 4621301A13</p> <p>TUBO DE TRAVÃO TRÁS LH-RH</p> <p>NISSAN SUNNY II 1.5 - 1.6 - 1.6i.1.6i 12V - 1.6i 4X4 - 1.7D (B12-N13) (9-86 A1992)</p> <p>293mm FB52 - FB52</p>
	<p><b>RT80080</b> NO. 4620489911 - 4621401A11 - 4621489911 - 48214-79911</p> <p>TUBO DE TRAVÃO TRÁS LH-RH</p> <p>NISSAN SUNNY II (N13) 1.4 - 1.6 - 2.0D (IMP. HITACHI) (10-1990 A 05-1995) - NISSAN SUNNY II (N13) 1.4 - 1.6 - 2.0 GTI - 2.0 4X4 - 2.0D (IMP. NICHIRIN) (10-1990 A 05-1995)</p> <p>261mm FB52 - FB52</p>		<p><b>RT80097</b> NO. 4621060A10 - 46210-60A00</p> <p>TUBO DE TRAVÃO FRENTE LH-RH</p> <p>NISSAN SUNNY II (N13) TT (06-1986 A 06-1991)</p> <p>520mm FB43 - OR51</p>
	<p><b>RT80098</b> NO. 4620489914 - 4621040R00 - 4621040R10 - 4621061A00 - 4621061A10 - 4621301A13 - 4621301A14 - 462137991...</p> <p>TUBO DE TRAVÃO TRÁS LH-RH</p> <p>NISSAN SUNNY II (N13) 1.4 - 1.6 - 2.0 D (10-1990 A 05-1995) + ABS - 2.0 GTI - 2.0 4X4 (10-1990 A 05-1995) + ABS - TT (06-1986 A 06-1991) (TAMBOR)</p> <p>292mm FB43 - FB43</p>		<p><b>RT80099</b> NO. 4621053A01 - 4621053A11</p> <p>TUBO DE TRAVÃO DE TRÁS LH-RH</p> <p>NISSAN SUNNY II Hatchback (N13) 1.6 (06.86 A 10.88) 84cv 1597cc Hatchback - NISSAN SUNNY II Hatchback (N13) 1.6 GTI 16V (06.87 A 05.89) 110cv 1598cc Hatchback - NISSAN SUNNY II Hatchback (N13) 1.8 GTI 16V (01.89 A 06.91) 125cv 1809cc Hatchback - NISSAN SUNNY II (N13) 1.4 LX (10.88 A 08.91) 75cv 1392cc três volumes - NISSAN SUNNY II (N13) 1.6 (06.86 A 10.88) 84cv 1597cc três volumes - NISSAN SUNNY II (N13) 1.6 GTI 16V (02.87 A 10.88) 110cv...etc.</p> <p>442mm FB43 - OR52</p>
	<p><b>RT80100</b> NO. 4621401A17</p> <p>TUBO DE TRAVÃO DE TRÁS LH-RH</p> <p>NISSAN SUNNY III Traveller (Y10) 1.6 i (06.91 A 03.00) 90cv 1597cc Combi - NISSAN SUNNY III Traveller (Y10) 2.0 D (06.91 A 03.00) 75cv 1974cc Combi - NISSAN SUNNY III Caixa (Y10) 1.6 i 16V (10.92 A 03.00) 90cv 1597cc Caixa - NISSAN SUNNY III Caixa (Y10) 1.7 D (11.90 A 03.00) 54cv 1681cc Caixa</p> <p>325mm FB43 - FO43</p>		<p><b>S1199</b> NO. 55045-01A05</p> <p>SILENT-BLOC DA SUSPENSÃO</p> <p>NISSAN SUNNY 130Y</p> <p>d57x69mm d45mm 1f-d10mm</p>
	<p><b>S1199-B</b> NO. 55045-01A05</p> <p>SILENT-BLOC DA SUSPENSÃO</p> <p>NISSAN SUNNY 130Y</p> <p>d57x69mm d45mm 1f-d10mm</p>		<p><b>S1218</b> NO. 55157-50A10 - 55152-50A10</p> <p>SILENT-BLOC DO BRAÇO DA SUSPENSÃO DE TRÁS</p> <p>NISSAN SUNNY N13 (1987 A 1990)</p> <p>d38x40mm d34mm 1f-d14mm</p>
	<p><b>S1248</b> NO. 54570-50A10</p> <p>SILENT-BLOC DO BRAÇO DA SUSPENSÃO FRENTE (PONTAS)</p> <p>NISSAN SUNNY B12 - N13</p> <p>75x65x57mm 1f-d22/4mm</p>		<p><b>S1249</b> NO. 48058-12110B</p> <p>SILENT-BLOC DO BRAÇO DA SUSPENSÃO FRENTE (MEIO)</p> <p>NISSAN SUNNY B12 - N13</p> <p>d40x59mm d35mm</p>

	<b>S1281</b> NO. 54504-01A00 - 54504-01A10 SILENT-BLOC DO BRAÇO DA SUSPENSÃO FRENTE NISSAN SUNNY B11 - B12 (1982 A 1990)		<b>S1284</b> NO. 54560-50Y10 - 54560-50A00 SILENT-BLOC DO BRAÇO DA SUSPENSÃO FRENTE NISSAN SUNNY B12 - B13 - B14
	d36.5x60mm      c51mm 1f-d16mm		d36x60mm      c51mm 1f-d14mm
	<b>S1287</b> NO. 54570-69Y10 SILENT-BLOC DO BRAÇO DA SUSPENSÃO FRENTE NISSAN SUNNY B13 - U13 - A32		<b>S1315</b> NO. 54570-0M010 SILENT-BLOC INFERIOR DO BRAÇO DA SUSPENSÃO FRENTE NISSAN SUNNY B13 - B14
	68x65x57mm      NULL		68x68x59mm      NULL
	<b>S1439</b> NO. 54505-01A10 - 54505-01A00 SILENT-BLOC DO BRAÇO DA SUSPENSÃO DA FRENTE PARTE INFERIOR NISSAN SUNNY LAUREL SPIRIT B11 - B12		<b>S1481</b> NO. 54560-0M000 SILENT BLOC DO BRAÇO DA SUSPENSÃO NISSAN SUNNY (APÓS 1997)
	d41x60mm      c50mm 1f-d16.4mm		d45x60mm      c43mm d39mm 1f-d14.5mm
	<b>T1113</b> NO. 54612-60Y00 BATENTE DA BARRA ESTABILIZADORA NISSAN SUNNY (B14)		<b>T1134</b> NO. 54617-H1001 BATENTE DA BARRA ESTABILIZADORA DE TRÁS NISSAN - SUNNY (10.1975 - 03.1994) - NISSAN 1200
	47x39x40mm      1f-d27.5mm		38x34x30mm      1f-d20mm



## NISSAN TERRANO-X-TRAIL

	<b>A1671</b> NO. 11220-7F000 - 11210-7F000 APOIO DO MOTOR LADO ESQUERDO NISSAN TERRANO WD21		<b>A1725</b> NO. 11210-0F002 APOIO DO MOTOR LADO DIREITO NISSAN TERRANO WD21
	140x100x95      1p-d10-21mm		152x140x70mm      1p-d10-22mm
	<b>A1913</b> NO. 11320-31G05 APOIO DO MOTOR PARTE DE TRÁS CAIXA DE VELOCIDADES NISSAN TERRANO I (WD21) 3.0 i 4WD 01.90 - 12.95 109 148 2960 Veiculo todo-terreno fechado NISSAN TERRANO I (WD21) 2.7 TD 4WD 02.89 - 02.96 73 99 2664 Veiculo todo-terreno fechado NISSAN TERRANO II (R20) 2.4 4WD 05.96 - 01.02 85 116 2389 Veiculo todo-terreno fechado NISSAN TERRANO II (R20) 2.4 4WD 05.96 - 09.07 87 118 2389 Veiculo todo-terreno fechado NISSAN TERRANO II (R20) 2.4 i 12V 4WD 02.93 - 06.96 91 124 2389 Veiculo todo-terreno fechado...etc.		<b>E0193</b> NO. 54618-0F000 - 1954778 ESTICADOR DA BARRA ESTABILIZADORA DA FRENTE NISSAN TERRANO II R20 (APÓS 1993) - TERRANO (APÓS 2002)
	160x115x65mm      2p-d10-22mm 2f-d13mm		105x30x30mm      1p-d10-18mm 1p-d12-23mm
	<b>F1202-I</b> NO. 39241-10E25 - 39241-10E26 FOLE DE TRANSMISSÃO JUNTO À RODA NISSAN TERRANO		<b>KF1645</b> NO. 3824101E26 - 3924110E02 KIT DE FOLE NISSAN TERRANO
	d109x96mm      1f-d95mm 1f-d23mm		d108x92mm      1f-d95mm 1f-d23mm

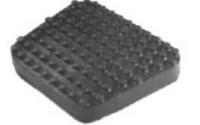

	<p><b>KF1681</b> NO. 39172-31G25 - 39712-31G25 - 39741-41W03 - 39741-41W25 - 39741-41W26 - 39741-50W25</p> <p><b>KIT DE FOLE DO CARDAN JUNTO À RODA</b></p> <p>NISSAN TERRANO I (86 A 93) 2.4i - 2.7 TD - 3.0i - TERRANO II (APOS 1993) 2.4i - 2.5 TD - 2.5 Tdi - 3.2i</p>		<p><b>KF1683-T</b> NO. 39241-5V125 - 39241-8V125</p> <p><b>KIT DE FOLE DO CARDAN JUNTO À RODA E CAIXA</b></p> <p>NISSAN TERRANO II 3.5i (APÓS 1993) X-TRAIL 2.0i - 2.2 Dci - 2.5i (APOS 2001)</p>
	<p><b>KF1890</b> NO.</p> <p><b>KIT DE FOLE DO CARDAN LADO DA RODA</b></p> <p>NISSAN TERRANO II 2.4i (08-1993 A 12-1999) - 2.7TD (08-1993 A 01-1998)</p>		<p><b>M6027</b> NO.</p> <p><b>JUNTA DE ESCAPE</b></p> <p>NISSAN TERRANO (1988 A 1993) - TERRANO II (1993 A 1996)</p>
	<p><b>R8127</b> NO. 21501-44G00</p> <p><b>TUBO SUPERIOR DO RADIADOR</b></p> <p>NISSAN TERRANO II 2.7 DIESEL TD 27 (1993 A 2000)</p>		<p><b>RT80084</b> NO. 4621031G10 - 4621031G11 - 1954516 - 1954519 - 46210-01F10 - 46210-EK400 - 46210-50Y07</p> <p><b>TUBO DE TRAVÃO FRENTE RH</b></p> <p>NISSAN TERRANO I (WD21) 2.4 4WD - 2.7 TD 4WD - 3.0 4WD (10-1987 A 02-1993) - TERRANO II (R20) 2.4 4WD - 2.7 TD 4WD - 2.7 TDi 4WD (APOS 02-1993)</p>
	<p><b>RT80085</b> NO. 4621131G11 - 46211-0F010 - 46211-31G10 - 46211-EK400 - 46210-50Y12</p> <p><b>TUBO DE TRAVÃO FRENTE LH</b></p> <p>NISSAN TERRANO I (WD21) 2.4 4WD - 2.7 TD 4WD - 3.0 4WD (10-1987 A 02-1993) - TERRANO II (R20) 2.4 4WD - 2.7 TD 4WD - 2.7 TDi 4WD (APOS 02-1993)</p>		<p><b>RT80101</b> NO. 4621101A41</p> <p><b>TUBO DE TRAVÃO TRÁS LH-RH</b></p> <p>NISSAN TERRANO I (WD21) 2.4 4WD - 2.7 TD 4WD (IMP. NICHIRIN) (10-1987 A 02-1993)</p>
	<p><b>RT80102</b> NO. 462110F015 - 46211-0F005</p> <p><b>TUBO DE TRAVÃO TRÁS LH-RH</b></p> <p>NISSAN TERRANO II (R20) 2.4 4WD - 2.7 TD 4WD - 2.7 TDi 4WD (APOS 02-1993)</p>		<p><b>S1390</b> NO. 55135-11C00 - 04766814AB - 04766814ABS - 55135-0W000</p> <p><b>SILENT-BLOC DA SUSPENSÃO</b></p> <p>NISSAN TERRANO</p>
	<p><b>S1414</b> NO. 55045-41G00 - 55046-41G00 - 55045-6S300</p> <p><b>SILENT BLOC DO BRAÇO DA SUSPENSÃO DA FRENTE PARTE SUPERIOR</b></p> <p>NISSAN TERRANO WD21 WAGON 2DOOR - WAGON 4DOOR</p>		<p><b>S1458</b> NO.</p> <p><b>SILENT BLOC DO BRAÇO DA SUSPENSÃO</b></p> <p>NISSAN TERRANO WD21 (1986 A 1995) - PATROL Y60 - SAFARI Y60 (1986 A 1995) - PATHFINDER (1986 A 1995)</p>
	<p><b>S1480</b> NO. 54560-06Y00</p> <p><b>SILENT BLOC DO BRAÇO DA SUSPENSÃO</b></p> <p>NISSAN TERRANO</p>		<p><b>S1539</b> NO. 55045-0W023 - 55046-0F000 - 55500-H1050</p> <p><b>SILENT-BLOC DO BRAÇO DA SUSPENSÃO DA FRENTE</b></p> <p>NISSAN TERRANO II (R20) 2.4 4WD (05.96 A 01.02) 116CV 2389CC - NISSAN TERRANO II (R20) 2.4 4WD (05.96 A 09.07) 118CV 2389CC - NISSAN TERRANO II (R20) 2.4 i 12V 4WD (02.93 A 06.96) 124CV 2389CC - NISSAN TERRANO II (R20) 2.7 TD 4WD (02.93 A 01.02) 101CV 266</p>
	<p><b>T0031</b> NO.</p> <p><b>BATENTE DA BARRA ESTABILIZADORA</b></p> <p>NISSAN TERRANO II</p>		<p><b>T1104</b> NO. 54613-43G00</p> <p><b>BATENTE DA BARRA ESTABILIZADORA</b></p> <p>NISSAN TERRANO I WD21 (1986 A 1995)</p>

	<p><b>T1156</b> NO. 54613-8H518</p> <p>BATENTE DA BARRA ESTABILIZADORA DA FRENTE</p> <p>NISSAN X-TRAIL (T30) 2.0 (07.01 A 01.13) 140cv 1998cc Veículo todo-terreno fechado - NISSAN X-TRAIL (T30) 2.0 4x4 (07.01 A 01.13) 140cv 1998cc Veículo todo-terreno fechado - NISSAN X-TRAIL (T30) 2.5 4x4 (09.02 A 01.13) 165cv 2488cc Veículo todo-terreno fechado - NISSAN X-TRAIL (T30) 2.2 Di 4x4 (07.01 A 10.05) 114cv 2184cc Veículo todo-terreno fechado - NISSAN X-TRAIL (T30) 2.2 dCi (12.03 A 01.13) 136cv 2184cc Veículo todo-terreno fechad...etc.</p> <p>39x40x42mm 1f-d19mm</p>		<p><b>T1158</b> NO. 54613JD03A - 54613JG03A</p> <p>BATENTE DA BARRA ESTABILIZADORA DA FRENTE</p> <p>NISSAN X-TRAIL (T32_) 1.6 DIG-T (T32) (APÓS 06.15) 163cv 1618cc Veículo todo-terreno fechado - NISSAN X-TRAIL (T32_) 1.6 dCi (T32) (APÓS 12.13) 130cv 1598cc Veículo todo-terreno fechado - NISSAN X-TRAIL (T32_) 1.6 dCi ALL MODE 4x4-i (NT32) (APÓS 12.13) 130cv 1598cc Veículo todo-terreno fechado</p> <p>74x47x34mm 1f-d23mm</p>
	<p><b>T1160</b> NO. 54613-1C406 - 54613-1C404</p> <p>BATENTE DA BARRA ESTABILIZADORA DA FRENTE</p> <p>NISSAN TERRANO II (R20) 2.4 4WD (05.96 A 01.02) 116cv 2389cc Veículo todo-terreno fechado - NISSAN TERRANO II (R20) 2.4 4WD (05.96 A 09.07) 118cv 2389cc Veículo todo-terreno fechado - NISSAN TERRANO II (R20) 2.4 i 12V 4WD Ano fabric. até: 05.96 (02.93 A 06.96) 124cv 2389cc Veículo todo-terreno fechado - NISSAN TERRANO II (R20) 2.7 TD 4WD (02.93 A 01.02) 101cv 2664cc Veículo todo-terreno fechado - NISSAN TERRANO II (R20) 2.7 TDi 4WD Ano f...etc.</p> <p>48x48x28mm 1f-d25mm</p>		<p><b>W5153</b> NO. 123032S600 - 123032S601</p> <p>POLIE CAMBOTA</p> <p>NISSAN TERRANO I (WD21) 3.0 i 4WD (01.90 A 12.95) 148cv 2960cc Veículo todo-terreno fechado - NISSAN TERRANO I (WD21) 2.7 TD 4WD (02.89 A 02.96) 99cv 2664cc Veículo todo-terreno fechado</p> <p>d145mm d43mm</p>
	<p><b>W5153</b> NO. 123032S600 - 123032S601</p> <p>POLIE CAMBOTA</p> <p>NISSAN TERRANO II (R20) 2.7 TD 4WD (02.93 A 01.02) 101cv 2664cc Veículo todo-terreno fechado - NISSAN TERRANO II (R20) 2.7 TDi 4WD (05.96 A 09.07) 125cv 2664cc Veículo todo-terreno fechado</p> <p>d145mm d43mm</p>		

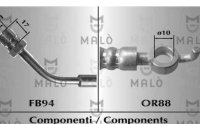
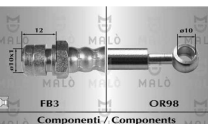
## NISSAN TRADE



	<p><b>P0006-R</b> NO. 46531Y0100</p> <p>CAPA DE PEDAL TRAVÃO E EMBRAIAGEM</p> <p>NISSAN TRADE</p> <p>67x52x10mm NULL</p>		<p><b>P1046</b> NO. 46531-Y0100 - 46531-Y9500</p> <p>CAPA PEDAL TRAVÃO E EMBRAIAGEM</p> <p>NISSAN TRADE</p> <p>70x56x10mm NULL</p>
	<p><b>RT80636</b> NO. 46210F3600</p> <p>TUBO DE TRAVÃO DA FRENTE</p> <p>NISSAN TRADE Autocarro 3.0 TDiC (06.96 A 10.01) 106cv 2953cc Autocarro</p> <p>155mm FB94 - OR88</p>		<p><b>RT80638</b> NO. 066055841 - 66055841 - 46210-F3600</p> <p>TUBO DE TRAVÃO DA FRENTE LH-RH</p> <p>NISSAN TRADE Autocarro 3.0 TDiC Versão: Autobus (06.96 A 10.01) 106cv 2953cc Autocarro</p> <p>445mm FB3 - OR98</p>

## NISSAN URVAN-E23-E24-E25





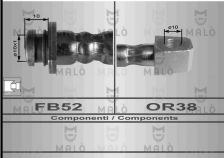



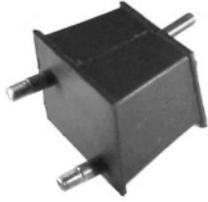

	<p><b>A1558</b> NO. 55240R8201</p> <p>APOIO BATENTE DA SUSPENSÃO</p> <p>NISSAN URVAN E23</p> <p>135x115x60mm NULL</p>		<p><b>A1559</b> NO. 11220-27G00 - 11220-40N00 - 11220-11N00 - 11220-36N00</p> <p>APOIO DO MOTOR FRENTE</p> <p>NISSAN URVAN E24 (1986 A 2001)</p> <p>110x60x60mm 2p-d10-20mm</p>
--	---	---	---











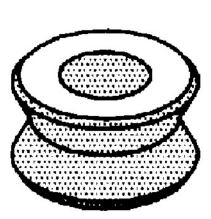
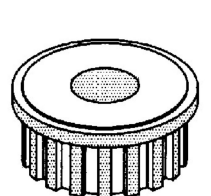
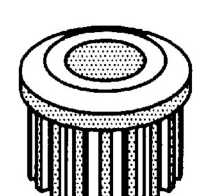
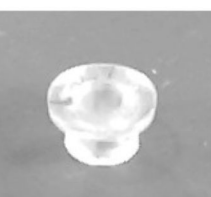

	<p><b>A1560</b> NO. 11320-40N00 - 11320-R8060</p> <p>APOIO DA CAIXA VELOCIDADES</p> <p>NISSAN URVAN E24 (1986 A 2001)</p> <p>137x115x70mm NULL</p>		<p><b>A1683</b> NO. 55240-R8001</p> <p>APOIO BATENTE DA SUSPENSÃO DE TRÁS</p> <p>NISSAN E24 URVAN</p> <p>135x95x60mm NULL</p>
	<p><b>E0033</b> NO.</p> <p>ESTICADOR DE ESCAPE</p> <p>NISSAN URVAN E23 (1981-1987)</p> <p>133x30x14mm NULL</p>		<p><b>E1015</b> NO. 20641-M6810 - 20641-M7060 - 20641-58100 - 20641-U6800 - 20641-U6810</p> <p>ESTICADOR DE ESCAPE</p> <p>NISSAN URVAN E24 (APÓS 1987)</p> <p>59x50x46mm 2p-d8-18mm</p>
	<p><b>E1034</b> NO. 20650D0100 - 20650V5000 - 20650V5200 - 2065041L00 - 206509C000 - 2066029R00</p> <p>ESTICADOR DE ESCAPE</p> <p>NISSAN URVAN E24 (1987 A 1996)</p> <p>72x62x35mm 2f-d11mm</p>		<p><b>KM0413</b> NO. 55220-R8010K - 55221-05N00</p> <p>KIT DE BRINCOS DAS MOLAS(COMPOSTO POR 4 CASQUILHOS L1049)</p> <p>NISSAN URVAN E23 (1980 A 1986)</p> <p>122x88x39mm 2d-33mm 2p-d11.8-18mm</p>
	<p><b>L1027</b> NO. 55045-01W10 - 55045-01W10LP</p> <p>CASQUILHO DE MOLAS DE TRÁS DO OLHAL DE TRÁS</p> <p>NISSAN DATSUN URVAN</p> <p>d48x37mm d40mm 1f-d17mm</p>		<p><b>L3106</b> NO. 55046-VW000</p> <p>CASQUILHO DAS MOLAS DE TRÁS OLHAL DE TRÁS SUPERIOR</p> <p>NISSAN URVAN E25 (2001 A 2012)</p> <p>d45x51mm d36mm 1f-d18mm</p>
	<p><b>L3107</b> NO. 55047-VW000</p> <p>CASQUILHO DAS MOLAS DE TRÁS OLHAL DE TRÁS</p> <p>NISSAN URVAN E25 (2001 A 2012)</p> <p>d55x37mm d36mm 1f-d18mm</p>		<p><b>M6040</b> NO. 20711-01E00 - 20691-01E80</p> <p>JUNTA DE ESCAPE</p> <p>NISSAN URVAN E24 (1987 A 1994)</p> <p>102x100mm 1f-d58mm</p>
	<p><b>R8007</b> NO. 21503-R8201</p> <p>TUBO INFERIOR DO RADIADOR</p> <p>NISSAN URVAN E23 - Z20 GASOLINA (1982 A 1986)</p> <p>B370-d34/34mm 80-300-200-160mm</p>		<p><b>R8010</b> NO. 21503-R8100 - 21503-R8102</p> <p>TUBO INFERIOR DO RADIADOR</p> <p>NISSAN URVAN E23 - SD 23 DIESEL (1982 A 1986)</p> <p>B345-d34/34mm 115-100-115-190-105mm</p>
	<p><b>R8014</b> NO. 21503-T3400</p> <p>TUBO SUPERIOR DO RADIADOR</p> <p>NISSAN URVAN E23 - SD22 (1982 A 1986)</p> <p>B320-d34/34mm 100-115-160-130-155mm</p>		<p><b>R8017</b> NO. 21501-02N00 - 4338483 - 4343796 - 5972937 - 4217314 - 4227314</p> <p>TUBO SUPERIOR DO RADIADOR</p> <p>NISSAN URVAN E24 MOTOR TD 27</p> <p>B250-d34/34mm 130-180mm</p>
	<p><b>R8019</b> NO. 21069-61500</p> <p>TUBO BY-PASS DA BOMBA DE ÁGUA</p> <p>NISSAN URVAN E23 (1982 A 1986)</p> <p>B90-d26/26mm 100-100mm</p>		<p><b>R8101</b> NO. 21503-02N00 - 21503-02N60</p> <p>TUBO INFERIOR DE RADIADOR</p> <p>NISSAN URVAN E24 MOTOR TD27 (1987 A 1993)</p> <p>B375-d38/36mm 90-280-150mm</p>

	<b>RT80074</b>	NO. 46201R8200 - 46203G9500 - 46210R8200 - 5873211100 - MA181409 - MB004446 - MB004448 - MB238154 - MB85...		<b>S1340</b>	NO. 5504505N10
	TUBO DE TRAVÃO FRENTE RH NISSAN URVAN E23 2.0 - 2.3D (12-1982 A 11-1988)			SILENT-BLOC DAS MOLAS DE TRAS (OLHAL DA FRENTE) NISSAN URVAN E24 (1986 A 2001)	
340mm		FB52 - OR38	d40x71mm		c60mm 1f-d12mm
	<b>T1085</b>	NO. 5461301N00			
	BATENTE DA BARRA ESTABILIZADORA NISSAN URVAN E24 (1986 2001)				
47x42x37mm		1f-d24mm			

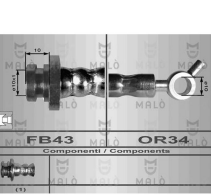
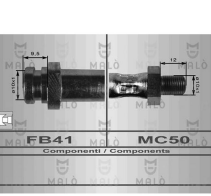
## NISSAN VANETTE-VANETTE CARGO

	<b>A1288</b>	NO. 54221-G2501		<b>A1289</b>	NO. 54220-G2501
	APOIO ESQUERDO DA MOLA DA FRENTE NISSAN VANETTE C220			APOIO DIREITO DA MOLA DA FRENTE NISSAN VANETTE C220	
84x68x44mm		1p-d8-25mm 2p-d10-25mm	84x68x44mm		1p-d8-25mm 2p-d10-25mm
	<b>A1313</b>	NO. 55060-G2501 - 55060-G2502		<b>A1627</b>	NO. 54091-G5111
	BATENTE DAS MOLAS TRÁS NISSAN VANETTE C20			APOIO DA MOLA DA FRENTE LADO DIREITO NISSAN VANETTE C22 1.5	
160x160x90mm		1f-d48mm	98x80x60mm		2p-d10-30mm 1p-d8-27mm
	<b>A1628</b>	NO. 54092-G5111		<b>A1666</b>	NO. 55060-G6100
	APOIO DA MOLA DA FRENTE LADO ESQUERDO NISSAN VANETTE C22 1.5			APOIO BATENTE DA SUSPENSÃO NISSAN VANETTE C22	
98x80x60mm		2p-d10-30mm 1p-d8-27mm	220x155x63mm		2f-d12mm
	<b>A1794</b>	NO.		<b>E1014</b>	NO. 20625-H9400
	APOIO BATENTE DE MOLA NISSAN VANETTE			ESTICADOR DE ESCAPE NISSAN VANETTE C120 - C22 (1979 A 1994)	
67x34x14mm		pino d12x8mm pino d12x8mm	68x68x36mm		NULL
	<b>E1034</b>	NO. 20650D0100 - 20650V5000 - 20650V5200 - 2065041L00 - 206509C000 - 2066029R00		<b>F1200-I</b>	NO. 39241-01E25 - 39241-01E27 - 39241-01E28 - 39241-0M326 - 39241-64J25 - 39241-63Y25 - 39241-01E26 - 39241-01E27
	ESTICADOR DE ESCAPE NISSAN VANETTE (ATÉ 1987)			FOLE DA TRANSMISSÃO LADO DA RODA NISSAN VANETTE C22 (1990 A 1994)	
72x62x35mm		2f-d11mm	d97x96mm		1f-d86mm 1f-d22mm

	<p><b>F1202-I</b> NO. 39241-10E25 - 39241-10E26</p> <p>FOLE DE TRANSMISSÃO JUNTO À RODA</p> <p>NISSAN VANETTE CARGO 1.8 - 2.0</p> <p>d109x96mm 1f-d95mm 1f-d23mm</p>		<p><b>KF1635</b> NO. 3924101E25 - 3924101E00 - 3924101E26 - 3924101E27 - 3924101E28 - 3924101E29 - 3924101E85 - 3924101E8...</p> <p>KIT DE FOLE DO CARDAN LADO DA RODA</p> <p>NISSAN VANETTE 2.0D (09-90 A 08-94)</p> <p>d97x96mm 1f-d86mm 1f-d22mm</p>
	<p><b>KF1645</b> NO. 3824101E26 - 3924110E02</p> <p>KIT DE FOLE</p> <p>NISSAN VANETTE CARGO 1.6i (APÓS 1995) - VANETTE 1.5 (1986 A 1995)</p> <p>d108x92mm 1f-d95mm 1f-d23mm</p>		<p><b>KF1681</b> NO. 39172-31G25 - 39712-31G25 - 39741-41W03 - 39741-41W25 - 39741-41W26 - 39741-50W25</p> <p>KIT DE FOLE DO CARDAN JUNTO À RODA</p> <p>NISSAN VANETTE 1.5 C22 - S20 (1986 A 1995) - VANETTE CARGO C22 - S20 (APÓS 1995) 1.6i</p> <p>d98x100mm 1f-d85mm 1f-d20mm</p>
	<p><b>KF1691</b> NO. 39241-01E29 - 39741-4F125</p> <p>KIT DE FOLE DO CARDAN JUNTO À RODA</p> <p>NISSAN VANETTE 2.0D (10/1986 A 12/1995)</p> <p>d94x95mm 1f-d80mm 1f-d21mm</p>		<p><b>L0329</b> NO. 54476-W5000 - 54476-W5001</p> <p>CASQUILHO</p> <p>NISSAN VANETTE C220</p> <p>d38x26mm 1f-d16mm</p>
	<p><b>L1053</b> NO. 55045-G2500</p> <p>CASQUILHO DE MOLAS DE TRÁS PARTE DA FRENTE</p> <p>NISSAN VANETTE</p> <p>d51x37mm d44mm 1f-d18mm</p>		<p><b>L1054</b> NO. 55046-G8300</p> <p>CASQUILHO DE MOLAS DE TRÁS PARTE DE TRÁS</p> <p>NISSAN VANETTE</p> <p>d31x39mm d28mm 1f-d14mm</p>
	<p><b>L3027</b> NO. 34552-89900</p> <p>CASQUILHO DO PENDURAL DA DIRECÇÃO</p> <p>NISSAN VANETTE C20 - E20</p> <p>NULL NULL</p>		<p><b>P1053</b> NO. 46431-G0301</p> <p>CAPA DE PEDAL DO TRAVÃO E EMBRAIAGEM</p> <p>NISSAN VANETTE C20</p> <p>55x52x11mm d75mm 1f-d15mm 1f-d28mm</p>
	<p><b>RT80106</b> NO. 46211Y9600 - 46211-Y9500</p> <p>TUBO DE TRAVÃO FRENTE LH</p> <p>NISSAN VANETTE BUS TT (01-1990 A 12-1995) - VANETTE VAN 2.0D (07-1991 A 01-1995)</p> <p>454mm FB43 - OR34</p>		<p><b>RT80107</b> NO. 4620189942 - 46201Y9502 - 4621101A42 - 4621189942</p> <p>TUBO DE TRAVÃO TRÁS LH-RH</p> <p>NISSAN VANETTE BUS TT (10-1986 A 12-1995) - VANETTE VAN 2.0D (07-1991 A 01-1995)</p> <p>465mm FB41 - MC50</p>
	<p><b>S1391</b> NO. 54450-G0300</p> <p>SILENT-BLOC DO BRAÇO DA SUSPENSÃO DA FRENTE PARTE SUPERIOR</p> <p>NISSAN VANETTE C20</p> <p>d40x45mm d35mm 1f-d16mm</p>		<p><b>S1392</b> NO. 54460-G0300</p> <p>SILENT-BLOC DO BRAÇO DA SUSPENSÃO DA FRENTE PARTE SUPERIOR</p> <p>NISSAN VANETTE C20</p> <p>d38x110mm 1f-d12mm</p>
	<p><b>T1160</b> NO. 54613-1C406 - 54613-1C404</p> <p>BATENTE DA BARRA ESTABILIZADORA DA FRENTE</p> <p>NISSAN VANETTE CARGO Autocarro (HC 23) 1.6 i (01.96 A 05.01) 98cv 1597cc Autocarro - NISSAN VANETTE CARGO Autocarro (HC 23) 2.3 D (09.94 A 05.01) 75cv 2283cc Autocarro - NISSAN VANETTE CARGO Caixa (HC 23) 1.6 i (09.94 A 05.01) 97cv 1597cc Caixa - NISSAN VANETTE CARGO Caixa (HC 23) 2.3 D (09.94 A 05.02) 75cv 2283cc Caixa</p> <p>48x48x28mm 1f-d25mm</p>		