





	F4003 NO. 0662-34-515 FOLE RESGUARDO DAS RÓTULAS DA DIRECÇÃO MITSUBISHI		H125 NO. PALA CAMIÃO PEQUENA PICOTADA MITSUBISHI MITSUBISHI
	d49x39mm 1f-d37mm 1f-d15mm		450x340mm NULL
	H807 NO. PALA MEIA LUA GRANDE MITSUBISHI		L0014 NO. CASQUILHO DE AMORTECEDORES (CÔNICOS) MITSUBISHI
	510x226x5mm NULL		d30x19mm d26mm 1f-d16mm
	R2440 NO. MB005079 BOMBA DE ÁGUA DO RADIADOR MITSUBISHI		R8108 NO. MB1061790 TUBO DO FILTRO DO AR MITSUBISHI
	B200-d30/20mm 90-85-100mm		B185-d64/60mm 50-120-50mm
	Z80771 NO. M293328 Mola de retenção MITSUBISHI (TODOS)		
	16x15x10mm 1p-10x10-8mm 1f-d6.3mm		

MITSUBISHI 3000

	F1794-I NO. MB350581 - MB501711 - MR369122 FOLE DA DIRECÇÃO LADO DIREITO E ESQUERDO MITSUBISHI 3000 V6 (10-1992 A 01-2000)		
	d65x190mm 1f-d45mm 1f-d10mm		

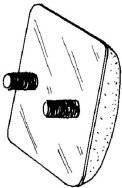





MITSUBISHI CANTER-T210

	A0982 NO. MB104718 - MC114546S - MC114546 SUPORTE - BATENTE DE MOLA MITSUBISHI CANTER T210 - FE331 - FE110 - FE444		A1114 NO. MT-116187 APOIO BATENTE DA MOLA DE TRÁS MITSUBISHI CANTER T210
	70x70x21mm 2p-d8-19mm		117x65x58mm NULL

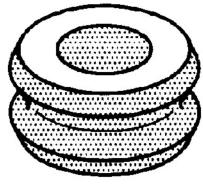
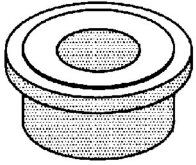
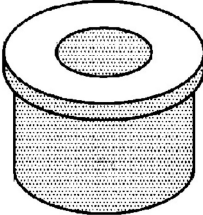
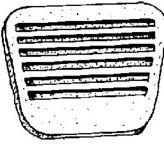
	<p>A1130 NO. ME011807 - ME011832 - ME011836</p> <p>SUPORTE DA FRENTE DO MOTOR DIREITO E ESQUERDO</p> <p>MITSUBISHI CANTER FE110 - 331 - 444 - T210 - F111 - 4D30</p> <p>128x75x50mm 2p-d11.5-25mm</p>		<p>A1137 NO. ME011832-011836 - ME-011832 - ME-011836</p> <p>SUPORTE DA FRENTE DO MOTOR DIREITO E ESQUERDO</p> <p>MITSUBISHI CANTER FE331-444 - T210</p> <p>125x63x45mm 2p-d11.5-25mm</p>
	<p>A1142 NO. MB00076-83 - MB-000083</p> <p>APOIO DO VEIO DE TRANSMISSÃO (COM ROLAMENTO)</p> <p>MITSUBISHI CANTER FE110-331-444</p> <p>215x160x50mm 1f-d35mm</p>		<p>A1148 NO. MB161440</p> <p>APOIO - BATENTE DA MOLA DE TRÁS INFERIOR</p> <p>MITSUBISHI CANTER T210</p> <p>148x110x80mm 2p-d7.5-18mm</p>
	<p>A1269 NO. MT202766</p> <p>SUPORTE DA FRENTE DO MOTOR</p> <p>MITSUBISHI T120</p> <p>80x40x40mm 2p-d10-18mm</p>		<p>A1270 NO. MT119504</p> <p>SUPORTE DA TRANSMISSÃO</p> <p>MITSUBISHI CANTER T210</p> <p>NULL NULL</p>
	<p>A1276 NO. MB000083-563228</p> <p>APOIO DO VEIO DA TRANSMISSÃO (SUPL. DO APOIO A1142)</p> <p>MITSUBISHI T210 - EE111 - TE331 - TE444</p> <p>95x95x58mm 1f-d35mm</p>		<p>A1291 NO.</p> <p>SEPARADOR DE MOLA</p> <p>MITSUBISHI CANTER FE331 - FE444</p> <p>73x50x8mm Pino 22x13x8mm</p>
	<p>A1298 NO. ME000034-011815</p> <p>SUPORTE DO MOTOR E CAIXA TRASEIRO</p> <p>MITSUBISHI CANTER FE111</p> <p>NULL NULL</p>		<p>A1315 NO. MB161571</p> <p>SUPORTE BATENTE DA MOLA TRASEIRA</p> <p>MITSUBISHI CANTER SE 331 - 446</p> <p>120x90x64mm 2p-d8-17mm</p>
	<p>A1336 NO. MB000076</p> <p>APOIO DE BORRACHA TRANSMISSÃO (Complemento do A1142)</p> <p>MITSUBISHI CANTER FE110 - FE111 - FE331 - FE444</p> <p>150x130x47mm NULL</p>		<p>A1343 NO. MB025453</p> <p>APOIO BATENTE ESQUERDO DA MOLA DA FRENTE</p> <p>MITSUBISHI CANTER FE444</p> <p>174x88x72mm NULL</p>
	<p>A1344 NO. MB025454</p> <p>APOIO BATENTE DIREITO DA MOLA DA FRENTE</p> <p>MITSUBISHI CANTER FE444</p> <p>173x88x72mm NULL</p>		<p>A1374 NO. MB025162</p> <p>APOIO BATENTE DA MOLA DA FRENTE</p> <p>MITSUBISHI CANTER</p> <p>174x66x60mm 2f-d13mm</p>
	<p>A1402 NO. ME000030</p> <p>SUPORTE DE MOTOR DIREITO E ESQUERDO</p> <p>MITSUBISHI CANTER T210 (4DR5)</p> <p>104x70x46mm 2p-d12-28mm</p>		<p>A1491 NO. MB387590 - ME201952</p> <p>APOIO DA CAIXA DE VELOCIDADES</p> <p>MITSUBISHI CANTER FE444</p> <p>54x42x38mm 2p-d8-16mm</p>





	<p>A1571 NO.</p> <p>SEPARADOR MOLAS 74X50X8 PIN029X15X8</p> <p>ISUZU NKR</p> <p>73x50x8mm Pino 29x15x8mm</p>		<p>A1582 NO. MD018993 - ME018993</p> <p>APOIO DO MOTOR DO LADO DIREITO E ESQUERDO</p> <p>MITSUBISHI CANTER FE 635</p> <p>115x95x63mm 2p-d12-26mm</p>
	<p>A1583 NO. MC110181</p> <p>APOIO BATENTE DAS MOLAS</p> <p>MITSUBISHI CANTER FE 531 - FE 649</p> <p>96x90x68mm NULL</p>		<p>A1585 NO. MC-114503</p> <p>APOIO BATENTE DA SUSPENSÃO DE TRÁS</p> <p>MITSUBISHI CANTER FE 444 - FE 449</p> <p>200x85x63mm 2p-d8-42mm</p>
	<p>A1601 NO.</p> <p>SEPARADOR DAS MOLAS 71X50X4 - 5 PINO 28X13 - 50X7</p> <p>MITSUBISHI CANTER FE 331 - FE 444</p> <p>70x49x4mm Pino 28x13x8mm</p>		<p>A1653 NO. MC416498</p> <p>APOIO BATENTE SUSPENSÃO DA FRENTE</p> <p>MITSUBISHI CANTER FH215</p> <p>125x70x75mm NULL</p>
	<p>A1657 NO. ME031962 - ME074024 - ME-031774</p> <p>APOIO DO MOTOR PARTE DA FRENTE</p> <p>MITSUBISHI CANTER FM215 - FM515 - FM516 - FH215</p> <p>142x120x63mm 1p-d14-25mm</p>		<p>A1659 NO. MC824412</p> <p>APOIO DA TRANSMISSÃO (SÓ BORRACHA)</p> <p>MITSUBISHI CANTER FH215</p> <p>145x145x38mm 1f-d98mm</p>
	<p>A1670 NO. MB293333</p> <p>APOIO DA TRANSMISSÃO</p> <p>MITSUBISHI CANTER FE434</p> <p>150x140x60mm 1f-d40mm</p>		<p>A1682 NO. MC830615</p> <p>APOIO DA TRANSMISSÃO</p> <p>MITSUBISHI CANTER FE444 (6208)</p> <p>155x130x47mm 1f-d40mm</p>
	<p>A1833 NO. MC122542</p> <p>APOIO DO MOTOR PARTE DE TRÁS ESQUERDO</p> <p>MITSUBISHI CANTER Camião de plataforma/chassis (FB_ - FE_ - FG_) 3.0 TDi Caixa de velocidades manual - Dados: Trans.mounting (APÓS 08.01) 125cv 2977cc - MITSUBISHI CANTER Camião de plataforma/chassis (FB_ - FE_ - FG_) 3.9 Caixa de velocidades manual - Dados:</p> <p>57x53x53mm 2p-d10x22mm</p>		<p>A1836 NO. MC127153</p> <p>APOIO DO RADIADOR</p> <p>MITSUBISHI CANTER FUSO (09-1995 A 2005) FE637 - FE639 - FE657 - FE859</p> <p>46X23mm 1p-d8x23mm 1p-d8x11mm</p>
	<p>A1861 NO. ME017631</p> <p>APOIO DO MOTOR PARTE DA FRENTE</p> <p>MITSUBISHI CANTER FE639 (4D35) TURBO</p> <p>125x130x85mm 1p-d12mm 1r-d12mm</p>		<p>A1871 NO. MB000078</p> <p>APOIO DA TRANSMISSÃO</p> <p>MITSUBISHI CANTER</p> <p>205x153x55mm 1f-d40mm</p>
	<p>KM0401 NO. MB025157K</p> <p>KIT DE BRINCOS DAS MOLAS (FRENTE E TRÁS PARTE DE TRÁS) (composto por 4 casquilhos L1056)</p> <p>MITSUBISHI CANTER FE110 - 331 - 444</p> <p>135x130x55mm d40mm</p>		<p>KM0411 NO. MB025177</p> <p>KIT DE BRINCOS DAS MOLAS DE TRÁS (PARTE DA FRENTE E TRÁS) (COMPOSTO POR 2 L1056NIT)</p> <p>MITSUBISHI CANTER T210 (4-6 WH) - FE110 - FE331 - FE444 - FE535 - FE635</p> <p>105x75x60mm d40mm 1p-d16-25mm</p>

MITSUBISHI CANTER-T210

	<p>KM0424 NO. MB035279</p> <p>KIT DE BRINCOS DAS MOLAS DE TRÁS</p> <p>MITSUBISHI CANTER</p> <p>130x92x80mm NULL</p>		<p>L0232 NO. MB161492</p> <p>CASQUILHO DE AMORTECEDOR</p> <p>MITSUBISHI CANTER</p> <p>d31x26mm 1f-d16mm</p>
	<p>L1037 NO. MB025185</p> <p>CASQUILHO DE MOLA FRENTE</p> <p>MITSUBISHI CANTER</p> <p>d46x40mm d40mm 1f-d22mm</p>		<p>L1056 NO. MB025153</p> <p>CASQUILHO DAS MOLAS DE TRÁS PARTE DA FRENTE E TRÁS</p> <p>MITSUBISHI CANTER T210 (4-6WH) - FE110 - FE331 - FE444 - FE535 - FE635</p> <p>d48x47mm d40mm 1f-d22mm</p>
	<p>P4788-C NO. MT321741</p> <p>CAPA DE PEDAL</p> <p>MITSUBISHI CANTER TT</p> <p>67x61x9mm NULL</p>		<p>R8104 NO. MB110270</p> <p>TUBO SUPERIOR DE RADIADOR</p> <p>MITSUBISHI CANTER FM 211 (DE 1985 ATÉ 1989)</p> <p>B255-d43/40mm 150-150mm</p>
	<p>R8105 NO. MB110271</p> <p>TUBO INFERIOR DE RADIADOR</p> <p>MITSUBISHI CANTER FM 211 (DE 1985 ATÉ 1989)</p> <p>B270-d45/42mm 70-155-90mm</p>		<p>R8115 NO. ME290064</p> <p>TUBO SUPERIOR DO RADIADOR</p> <p>MITSUBISHI CANTER FH215</p> <p>B365-d45/48mm 130-260-90mm</p>
	<p>R8116 NO. MC432404</p> <p>TUBO INFERIOR DO RADIADOR</p> <p>MITSUBISHI CANTER FH215</p> <p>B190-d42/40mm 130-130mm</p>		<p>R8129 NO. MB-390037</p> <p>TUBO INFERIOR DO RADIADOR</p> <p>MITSUBISHI CANTER FE444 (4D31 4D32) (1986 A 1995)</p> <p>B350-41/43mm 170-140-150mm</p>

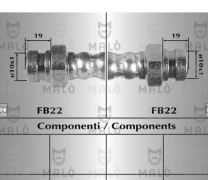
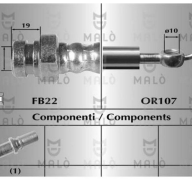
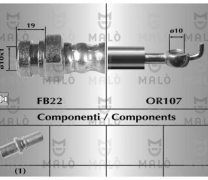
MITSUBISHI CARISMA

	<p>E1052 NO. MB376954 - MB906128</p> <p>ESTICADOR DE ESCAPE</p> <p>MITSUBISHI CARISMA (APÓS 1995)</p> <p>65x54x26mm 2f-d11mm</p>		<p>F4046 NO.</p> <p>FOLE DA DIRECÇÃO LADO ESQUERDO E DIREITO</p> <p>MITSUBISHI CARISMA (APÓS 1995) 1.6i - 1.8 GDi - 1.8 GDi 16V - 1.9 TD</p> <p>d63x185mm 1f-d41mm 1f-d12mm</p>
	<p>KF2532-T NO. MR263171</p> <p>KIT DE FOLE DO CARDAN LADO DA RODA</p> <p>MITSUBISHI CARISMA 1.6i 16V (06-95 A 05-00) - 1.8i 16V (06-95 A 09-97) - 1.8i GDi - 1.8i GDi DOHC (10-97 A 03-00) - 1.9 TD - 1.9 TDiC (01-97 A 12-99)</p> <p>d94x138mm 1f-d24mm 1f-d82mm</p>		<p>KF2532BT NO. MR263171</p> <p>KIT DE FOLE DO CARDAN JUNTO À RODA</p> <p>MITSUBISHI CARISMA 1.6i - 1.8 GDi - 1.8 GDi 16V - 1.9 TD (APÓS 1995)</p> <p>d105x150mm 1f-d85mm 1f-d23mm</p>

	<p>M6046 NO. MB313111 - MB687012</p> <p><i>JUNTA DE ESCAPE</i></p> <p>MITSUBISHI CARISMA (APÓS 1995)</p> <p>97x67mm 1f-d51mm</p>		<p>RT80414 NO. MB950626 - MR910915</p> <p><i>TUBO DE TRAVÃO DE TRÁS LH-RH</i></p> <p>MITSUBISHI CARISMA (DA_) 1.6 (DA1A) (07.95 A 06.06) 90cv 1597cc Hatchback - MITSUBISHI CARISMA (DA_) 1.6 (DA1A) (12.98 A 06.06) 95cv 1597cc Hatchback - MITSUBISHI CARISMA (DA_) 1.6 (DA1A) (05.97 A 06.06) 99cv 1597cc Hatchback - MITSUBISHI CARISMA (DA_) 1.6 (DA1A) (09.00 A 06.06) 103cv 1597cc Hatchback - MITSUBISHI CARISMA (DA_) 1.8 (DA2A) (07.95 A 07.97) 116cv 1834cc Hatchback - MITSUBISHI CARISMA (DA_) 1.8 GDI (DA2A) (10.00 A 06.06) 122cv ...etc.</p> <p>230mm FB22 - FB22</p>
	<p>RT80561 NO. MB950627</p> <p><i>TUBO DE TRAVÃO DE TRÁS LH-RH</i></p> <p>MITSUBISHI CARISMA (DA_) 1.6 (DA1A) Ano fabric. até: 04.99 (07.95 A 06.06) 90cv 1597cc Hatchback - MITSUBISHI CARISMA (DA_) 1.6 (DA1A) Ano fabric. até: 04.99 (12.98 A 06.06) 95cv 1597cc Hatchback - MITSUBISHI CARISMA (DA_) 1.6 (DA1A) Ano fabric. até: 04.99 (05.97 A 06.06) 99cv 1597cc Hatchback - MITSUBISHI CARISMA (DA_) 1.8 (DA2A) (07.95 A 07.97) 116cv 1834cc Hatchback - MITSUBISHI CARISMA (DA_) 1.8 16V GDI (DA2A) Ano fabric. até: 04.99 (...etc.</p> <p>425mm FB22 - OR107</p>		<p>RT80562 NO. MM862413</p> <p><i>TUBO DE TRAVÃO DE TRÁS LH-RH</i></p> <p>MITSUBISHI CARISMA (DA_) 1.6 (DA1A) Ano fabric. a partir de: 05.99 (07.95 A 06.06) 90cv 1597cc Hatchback - MITSUBISHI CARISMA (DA_) 1.6 (DA1A) Ano fabric. a partir de: 05.99 (12.98 A 06.06) 95cv 1597cc Hatchback - MITSUBISHI CARISMA (DA_) 1.6 (DA1A) Ano fabric. a partir de: 05.99 (05.97 A 06.06) 99cv 1597cc Hatchback - MITSUBISHI CARISMA (DA_) 1.8 (DA2A) (07.95 A 07.97) 116cv 1834cc Hatchback - MITSUBISHI CARISMA (DA_) 1.8 16V GDI (DA2A) Ano ...etc.</p> <p>430mm FB22 - OR107</p>
	<p>T1144 NO. MB809357</p> <p><i>BATENTE DA BARRA ESTABILIZADORA DE TRÁS</i></p> <p>MITSUBISHI CARISMA (DA_) 1.6 (DA1A) Hatchback (07.95 A 06.06) 90CV 1597CC - MITSUBISHI CARISMA (DA_) 1.6 (DA1A) Hatchback (12.98 A 06.06) 95CV 1597CC - MITSUBISHI CARISMA (DA_) 1.6 (DA1A) Hatchback (05.97 A 06.06) 99CV 1597CC - MITSUBISHI CARISMA (DA_) 1</p> <p>36x34x37mm 30x34x28mm 1f-d15mm</p>		<p>Z80775 NO. MB253964</p> <p><i>Mola de fixação</i></p> <p>MITSUBISHI CARISMA</p> <p>d17x20mm 1p-d7-10mm</p>
	<p>Z80781 NO. MB344789</p> <p><i>Mola de painel</i></p> <p>MITSUBISHI CARISMA</p> <p>d17x17mm 1p-d7.5-11mm</p>		





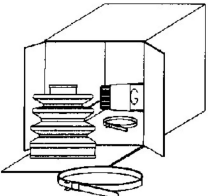









MITSUBISHI CHARIOT

	<p>F0512-I NO. MB109011 - MB176162 - MB176860 - MB297147 - MB297190</p> <p><i>FOLE DO SEMI-EIXO EXTERNO</i></p> <p>MITSUBISHI CHARIOT 1.6</p> <p>d83x85mm 1f-d72mm 1f-d22mm</p>		<p>F0694-I NO. MB176870 - MB297370</p> <p><i>FOLE DOS SEMI-EIXOS ESQUERDO E DIREITO</i></p> <p>MITSUBISHI CHARIOT 1.8 (7-83 A 5-84)</p> <p>d90x86mm 1f-d23mm 1f-d79mm</p>
	<p>F1234-I NO. MB297379 - 23222-GA153 - MB620053 - 23222-GA150 - 23222-GA151</p> <p><i>FOLE DO SEMI-EIXO LADO CAIXA E RODA</i></p> <p>MITSUBISHI CHARIOT</p> <p>88x90mm 1f-d85mm 1f-d24mm</p>		<p>F1252-I NO. MB160658 - MB297536</p> <p><i>FOLE JUNTO À CAIXA</i></p> <p>MITSUBISHI CHARIOT 1.8 (APÓS 7-1983) - CHARIOT 2.0 4WD FRENTE (APÓS 6-1984)</p> <p>d102x95mm 1f-d80mm 1f-d25mm</p>
	<p>F1257-I NO. MB526148 - MB526274</p> <p><i>FOLE DE TRANSMISSÃO LADO DA RODA</i></p> <p>MITSUBISHI CHARIOT 2.0 (APÓS 1984)</p> <p>d95x91mm 1f-d80mm 1f-d26mm</p>		<p>F1259-I NO. MB297340 - MB297339</p> <p><i>FOLE DA TRANSMISSÃO LADO DA CAIXA</i></p> <p>MITSUBISHI CHARIOT 1.6 (APÓS 1984)</p> <p>d84x88mm 1f-d74mm 1f-d20mm</p>

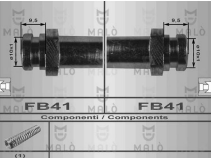
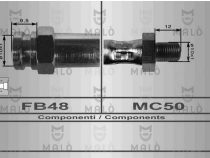
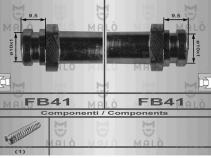
	KF3410 NO. MB176860 - MB297147 - MB297184 - MB297190 - MB297351 - MB393129 - MB526057		
	FOLE DO LADO DA RODA MITSUBISHI CHARIOT 1.6		
	d89x87mm	1f-d73mm 1f-d21mm	

MITSUBISHI COLT

	E0018 NO. MB376954	ESTICADOR DE ESCAPE MITSUBISHI COLT (APÓS 86)		E1010 NO. MB906128
	68x54x25mm			NULL
	E1043 NO. MB059936 - MB059522 - MB059935 - MB059937 - MB906124 - 28658-21000	ESTICADOR DE ESCAPE MITSUBISHI COLT		E1052 NO. MB376954 - MB906128
	NULL			NULL
	E1115 NO. MN130295 - MR431636	APOIO DO ESCAPE MITSUBISHI COLT VI (Z3_A - Z2_A) 1.1 Sistema de escape: para a panela de escape traseira - Local de montagem: traseira (10.04 A 06.12) 75cv 1124cc Hatchback - MITSUBISHI COLT VI (Z3_A - Z2_A) 1.3 Sistema de escape: para a panela de escape traseira - Local de montagem: traseira (06.04 A 06.12) 95cv 1332cc Hatchback - MITSUBISHI COLT VI (Z3_A - Z2_A) 1.5 Sistema de escape: para a panela de escape traseira - Local de montagem: traseira (06.04 A ...etc.		F0066-I NO. MB290156
	76x70x22mm			3f-d12mm
	F0512-I NO. MB109011 - MB176162 - MB176860 - MB297147 - MB297190	FOLE DO SEMI-EIXO EXTERNO MITSUBISHI COLT		F0706-I NO. MB109012 - MB109184
	d83x85mm			1f-d72mm 1f-d22mm
	F1254-I NO. MB526894 - MB937307 - MR446048 - MB526356	FOLE DA TRANSMISSÃO JUNTO À CAIXA MITSUBISHI COLT III 1.5i (1988 A 1992)		F1260-I NO. MB175851 - MB176164
	d83x95mm			1f-d25mm 1f-d72mm
	F1328-I NO. MB526006 - MB936162 - MB936667	FOLE DA TRANSMISSÃO JUNTO À CAIXA MITSUBISHI COLT (4) 1.6i 16V (1992 A 1996)		F1794-I NO. MB350581 - MB501711 - MR369122
	d75x85mm			1f-d64mm 1f-d18mm

	<p>F1796-I NO. MB347365</p> <p>FOLE DA DIRECÇÃO LADO ESQUERDO</p> <p>MITSUBISHI COLT 1.2 EL-GL-DL 03-84 A 09-88 - 1.3 EL-GL 09-88 A 03-91 - 1.3 12V 09-90 A 05-92 - 1.3i 12V EL-GI-STD-GLX 01-92 A 01-96 - 1.4 GLX - 1.5 GL-GLX 09-88 A 05-92 - 1.6 03-84 A 09-88 - 1.6i 16V 01-92 A 01-96 - 1.8 DIESEL 03-84 A 02-92 - 1.8i 16V GT</p> <p>d60x165mm 1f-d36mm 1f-d10mm</p>		<p>F1797-I NO. MB347364</p> <p>FOLE DA DIRECÇÃO LADO DIREITO</p> <p>MITSUBISHI COLT 1.2 EL-GL-DL (03-84 A 09-88) - 1.3 EL-GL (09-88 A 03-91) - 1.3 12V (09-90 A 05-92) - 1.3i 12V EL-GI-STD-GLX 01-92 A 01-96 - 1.4 GLX - 1.5 GL-GLX 09-88 A 05-92 - 1.6 (03-84 A 09-88) - 1.6i 16V (01-92 A 01-96) - 1.8 DIESEL (03-84 A 02-92) -</p> <p>d60x170mm 1f-d30mm 1f-d10mm</p>
	<p>KF3421-T NO. MR222635</p> <p>KIT DE FOLE DO CARDAN JUNTO À RODA</p> <p>MITSUBISHI COLT IV (1992 A 1995) 1.8i GTi 16V</p> <p>d94x160mm 1f-d87mm 1f-d26mm</p>		<p>KF3493 NO. MB297379 - MB297569</p> <p>KIT DE FOLE DO CARDAN LADO DA RODA</p> <p>MITSUBISHI COLT 1.5i (09-88 A 03-91) - 1.5i 12V (09-90 A 05-92) - 1.6T (03-84 A 09-88) - 1.6i 16V (09-88 A 01-96) - 1.8D (09-88 A 02-92)</p> <p>NULL NULL</p>
	<p>KF3494 NO. MB6200 - MB936182</p> <p>KIT DE FOLE DO CARDAN LADO DA RODA</p> <p>MITSUBISHI COLT 1.3 (09-88 A 03-91) - 1.3 12V (09-90 A 05-92) - 1.5 (10-86 A 09-88)</p> <p>NULL NULL</p>		<p>L3094 NO. MD701577</p> <p>CASQUILHO DA ALAVANCA VELOCIDADES</p> <p>MITSUBISHI COLT</p> <p>d18x12mm 1f-d13mm 1f-d10mm</p>
	<p>M6027 NO. MB156180 - MB687001</p> <p>JUNTA DE ESCAPE</p> <p>MITSUBISHI COLT (1984 A 1995)</p> <p>112x80mm 1f-d54mm</p>		<p>M6046 NO. MB313111 - MB687012</p> <p>JUNTA DE ESCAPE</p> <p>MITSUBISHI COLT (1988 A 1995)</p> <p>97x67mm 1f-d51mm</p>
	<p>RT80044 NO. MB058593 - MB238161 - MB058509 - MB238162 - MB238164 - MB238166 - MB587740 - MB857559 - MB857561</p> <p>TUBO DE TRAVÃO FRENTE LH-RH</p> <p>MITSUBISHI COLT TT (12-1978 A 05-1992)</p> <p>316mm FB41 - FB41</p>		<p>RT80045 NO. MB239151</p> <p>TUBO DE TRAVÃO FRENTE LH-RH</p> <p>MITSUBISHI COLT TT (12-1978 A 05-1992)</p> <p>212mm FB48 - MC50</p>
	<p>RT80047 NO. MB238163 - MB587743 - MB857555 - MB857570 - MR129775</p> <p>TUBO DE TRAVÃO TRÁS LH-RH</p> <p>MITSUBISHI COLT TT (04-1988 A 05-1992)</p> <p>259mm FB41 - FB41</p>		<p>RT80369 NO. MB857567 - MR129787</p> <p>TUBO DE TRAVÃO DE TRÁS LH-RH</p> <p>MITSUBISHI COLT IV (CA_A) 1.3 GLi 12V (CA1A) (04.92 A 04.96) 75cv 1299cc Hatchback - MITSUBISHI COLT V (CJ_ - CP_) 1.6 (CA4A) (02.94 A 04.96) 90cv 1597cc Hatchback - MITSUBISHI COLT IV (CA_A) 1.6 GLXi 16V (CA4A) (04.92 A 04.96) 113cv 1597cc Hatchback - MITSUBISHI COLT IV (CA_A) 1.8 GTi 16V (CA5A) (04.92 A 04.96) 140cv 1834cc Hatchback</p> <p>235mm FB51 - FB51</p>
	<p>RT80369 NO. MB857567 - MR129787</p> <p>TUBO DE TRAVÃO DE TRÁS LH-RH</p> <p>MITSUBISHI COLT V (CJ_ - CP_) 1300 (CJ1A) (06.00 A 09.03) 82cv 1299cc Hatchback - MITSUBISHI COLT V (CJ_ - CP_) 1.5 16V (CJ2A) (10.99 A 09.03) 94cv 1468cc Hatchback - MITSUBISHI COLT V (CJ_ - CP_) 1600 GLX (CJ4A) (05.96 A 09.00) 90cv 1597cc Hatchback - MITSUBISHI COLT V (CJ_ - CP_) 1600 (09.00 A 09.03) 103cv 1597cc Hatchback</p> <p>235mm FB51 - FB51</p>		<p>RT80389 NO. MR129882</p> <p>TUBO DE TRAVÃO DA FRENTE LH-RH</p> <p>MITSUBISHI COLT V (CJ_ - CP_) 1300 GL - GLX (CJ1A) (05.96 A 06.00) 75cv 1299cc Hatchback - MITSUBISHI COLT V (CJ_ - CP_) 1300 (CJ1A) (06.00 A 09.03) 82cv 1299cc Hatchback - MITSUBISHI COLT V (CJ_ - CP_) 1.5 16V (CJ2A) (10.99 A 09.03) 94cv 1468cc Hatchback - MITSUBISHI COLT V (CJ_ - CP_) 1600 GLX (CJ4A) (05.96 A 09.00) 90cv 1597cc Hatchback - MITSUBISHI COLT V (CJ_ - CP_) 1600 (09.00 A 09.03) 103cv 1597cc Hatchback</p> <p>450mm FB51 - OR21</p>
	<p>RT80391 NO. MB857426 - MR129799</p> <p>TUBO DE TRAVÃO DA FRENTE LH-RH</p> <p>MITSUBISHI COLT IV (CA_A) 1.3 GLi 12V (CA1A) (04.92 A 04.96) 75cv 1299cc Hatchback - MITSUBISHI COLT IV (CA_A) 1.6 (CA4A) (02.94 A 04.96) 90cv 1597cc Hatchback - MITSUBISHI COLT IV (CA_A) 1.6 GLXi 16V (CA4A) (04.92 A 04.96) 113cv 1597cc Hatchback - MITSUBISHI COLT IV (CA_A) 1.8 GTi 16V (CA5A) (04.92 A 04.96) 140cv 1834cc Hatchback</p> <p>430mm FB51 - OR21</p>		<p>S1528 NO. 4013A150 - 4013A135</p> <p>SILENT BLOC DO BRAÇO DA SUSPENSÃO DA FRENTE PARTE DE TRÁS</p> <p>MITSUBISHI - COLT VI (Z3_A - Z2_A) - 1.1 (10.04 - 06.12) 75cv 1124cc Hatchback - MITSUBISHI - COLT VI (Z3_A - Z2_A) - 1.3 (06.04 - 06.12) 95cv 1332cc Hatchback - MITSUBISHI - COLT VI (Z3_A - Z2_A) - 1.5 (06.04 - 06.12) 109cv 1499cc Hatchback - MITSUBISHI -</p> <p>d60x54mm c26mm 1f-d14mm</p>

MITSUBISHI COLT

	<p>S1590 NO. 4013A135S3 - MN186217 - MN186218</p> <p><i>SILENTBLOC BRAÃO SUSPENSÃO FRENTE</i></p> <p>MITSUBISHI COLT VI (Z3_A, Z2_A) 1.1 (10.04 A 06.12) 75cv 1124cc Hatchback - MITSUBISHI COLT VI (Z3_A, Z2_A) 1.3 (06.04 A 06.12) 95cv 1332cc Hatchback - MITSUBISHI COLT VI (Z3_A, Z2_A) 1.3 LPG (06.04 A 06.12) 95cv 1332cc Hatchback - MITSUBISHI COLT VI (Z3_A, Z2_A) 1.5 (06.04 A 06.12) 109cv 1499cc Hatchback - MITSUBISHI COLT VI (Z3_A, Z2_A) 1.5 DI-D (08.04 A 06.12) 68cv 1493cc Hatchback - MITSUBISHI COLT VI (Z3_A, Z2_A) 1.5 DI-D (08.04 A ...etc.</p> <p>d38x60mm d36mm c36mm 1f-d14mm</p>		<p>S1590 NO. 4013A135S3 - MN186217 - MN186218</p> <p><i>SILENTBLOC BRAÃO SUSPENSÃO FRENTE</i></p> <p>MITSUBISHI COLT CZC Cabriolet (RG) 1.5 (Z23) (05.06 A 07.09) 109cv 1499cc Cabriolet</p> <p>d38x60mm d36mm c36mm 1f-d14mm</p>
	<p>Z80775 NO. MB253964</p> <p><i>Mola de fixação</i></p> <p>MITSUBISHI COLT</p> <p>d17x20mm 1p-d7-10mm</p>		<p>Z80776 NO. MR288150</p> <p><i>Mola de fixação</i></p> <p>MITSUBISHI COLT</p> <p>d15x24mm 1p-d6-11.5mm</p>
	<p>Z80781 NO. MB344789</p> <p><i>Mola de painel</i></p> <p>MITSUBISHI COLT</p> <p>d17x17mm 1p-d7.5-11mm</p>		<p>Z80833 NO. 30873201 - MB-814152</p> <p><i>Mola</i></p> <p>MITSUBISHI COLT (De 1992 A 2002)</p> <p>25x11.5x4.7mm NULL</p>







MITSUBISHI DELICA

	<p>E0248 NO. MB598097</p> <p><i>ESTICADOR DA BARRA ESTABILIZADORA DA FRENTE</i></p> <p>MITSUBISHI DELICA (BUS) 2.0 4WD (APÓS 11-1986) - 2.4 4WD (APÓS 11-1986) - 2.5 TD 4WD (APÓS 11-1988)</p> <p>71x32mm 1p-d10mm</p>		<p>F1252-I NO. MB160658 - MB297536</p> <p><i>FOLE JUNTO À CAIXA</i></p> <p>MITSUBISHI DELICA 1.8 - 2.0 - 2.2 - 2.4 - 2.5 4WD (APÓS 10-1982)</p> <p>d102x95mm 1f-d80mm 1f-d25mm</p>
	<p>F1257-I NO. MB526148 - MB526274</p> <p><i>FOLE DE TRANSMISSÃO LADO DA RODA</i></p> <p>MITSUBISHI DELICA 2.0 - 2.4 4WD - 2.5 (APÓS 1986)</p> <p>d95x91mm 1f-d80mm 1f-d26mm</p>		<p>RT80363 NO. MR129721</p> <p><i>TUBO DE TRAVÃO DA FRENTE LH-RH</i></p> <p>MITSUBISHI DELICA / SPACE GEAR 2.0 (09.95 A 10.02) 113cv 1997cc Veículo multiuso - MITSUBISHI LANCER VI (CJ-CP_) 2.0 16V EVO (08.98 A 08.01) 280cv 1997cc três volumes - MITSUBISHI LANCER três volumes (CS_A - CT0) 2.0 16V EVO VIII (CT9A) (APÓS 03.04) 265cv 1997cc três volumes - MITSUBISHI LANCER três volumes (CS_A - CT0) 2.0 16V EVO IX (CT9A) (APÓS 01.06) 280cv 1997cc três volumes - MITSUBISHI OUTLANDER I (CU_W) 2.0 (CU2W) (05.03 A 10....etc.</p> <p>335mm FB51 - FB51</p>
	<p>RT80366 NO. MR129788</p> <p><i>TUBO DE TRAVÃO DE TRÁS RH</i></p> <p>MITSUBISHI DELICA / SPACE GEAR 2.0 (09.95 A 10.02) 113cv 1997cc Veículo multiuso - MITSUBISHI LANCER VI (CJ-CP_) 2.0 16V EVO (08.98 A 08.01) 280cv 1997cc três volumes - MITSUBISHI LANCER três volumes (CS_A - CT0) 2.0 16V EVO VIII (CT9A) (APÓS 03.04) 265cv 1997cc três volumes - MITSUBISHI LANCER três volumes (CS_A - CT0) 2.0 16V EVO IX (CT9A) (APÓS 01.06) 280cv 1997cc três volumes - MITSUBISHI OUTLANDER I (CU_W) 2.0 (CU2W) (05.03 A 10....etc.</p> <p>330mm FB51 - FB51</p>		<p>S1496 NO. MR112709 - 545224B010 - 545224B000 - 545404B001 - 545504A000 - 545104B001</p> <p><i>SILENT BLOC DO BRAÇO TRANSVERSAL</i></p> <p>MITSUBISHI DELICA SPACE GEAR - CARGO PA - PB - PC (1994 A 2006) - DELICA TRUCK P02T - P05T - P15T - P25T (1994 A 1999)</p> <p>d53x76mm c51mm d40mm 1f-d16.3mm</p>

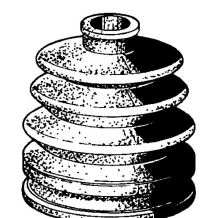
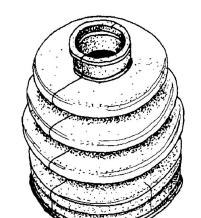
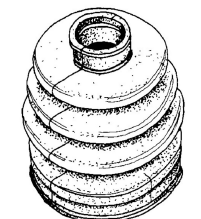
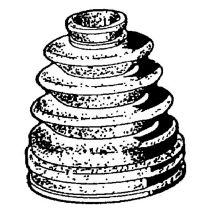

	A1803	NO. MB505495		E1043	NO. MB059936 - MB059522 - MB059935 - MB059937 - MB906124 - 28658-21000
	APOIO DA TRANSMISSÃO MITSUBISHI ECLIPSE I (D2 A) 2.0 I 16V 4WD (22A D27A) (01-1991 A 11-1995) 150CV 1997CC			ESTICADOR DE ESCAPE MITSUBISHI ECLIPSE (APÓS 1991) - P05V - N38W - D22H - P15V	
210x120x65mm		1f-d30mm	NULL		NULL
	E1052	NO. MB376954 - MB906128		F1240-I	NO. MB526516
	ESTICADOR DE ESCAPE MITSUBISHI ECLIPSE (1991 A 1996)			FOLE DA TRANSMISSÃO LADO DA RODA MITSUBISHI ECLIPSE 2.0 (APÓS 1989)	
65x54x26mm		2f-d11mm	d85x95mm		1f-d76mm 1f-d21mm
	F1254-I	NO. MB526894 - MB937307 - MR446048 - MB526356		F1254-I	NO. MB526894 - MB937307 - MR446048 - MB526356
	FOLE DA TRANSMISSÃO JUNTO À CAIXA MITSUBISHI ECLIPSE II 2.0i 2000 GS 16V - 2.4i (APÓS 1995)			FOLE DA TRANSMISSÃO JUNTO À CAIXA MITSUBISHI ECLIPSE III 2.4i (APÓS 2000)	
d83x95mm		1f-d25mm 1f-d72mm	d83x95mm		1f-d25mm 1f-d72mm
	F1794-I	NO. MB350581 - MB501711 - MR369122		M6027	NO. MB156180 - MB687001
	FOLE DA DIRECÇÃO LADO DIREITO E ESQUERDO MITSUBISHI ECLIPSE 2.0i 16V (APÓS 04-92)			JUNTA DE ESCAPE MITSUBISHI ECLIPSE (1991 A 1996)	
d65x190mm		1f-d45mm 1f-d10mm	112x80mm		1f-d54mm
	RT80360	NO. MB081939 - MB238153 - MB587751 - MB857532 - MB857545 - MR129750			
	TUBO DE TRAVÃO DE TRÁS LH-RH MITSUBISHI ECLIPSE I (D2_A) 2.0 i 16V (D22A - D27A) (04.91 A 11.95) 150cv 1997cc Coupé - MITSUBISHI ECLIPSE I (D2_A) 2.0 i 16V 4WD (D22A - D27A) (04.91 A 11.95) 150cv 1997cc Coupé				
255mm		FB50 - MC50/1			

MITSUBISHI FUSO-BRAVO

	A1834	NO. MK314011		F1328-I	NO. MB526006 - MB936162 - MB936667
	APOIO DO MOTOR MITSUBISHI FUSO 10M20 - 10M21 - 8M20 - 8M21 - 8M22 - OM457 - 8DC2 - 8DC4 - 8DC6 - 8DC8 - 6M60 - 6M70 - 6R10 - 6D10 - 6D11 - 6D14 - 6D15 - 6D16 - 6D17 - 6D22 - 6D31 - 6D34 - 6D57			FOLE DA TRANSMISSÃO JUNTO À CAIXA MITSUBISHI BRAVO 660 (APÓS 12-1990)	
130x100x105mm		2p-d12x26mm	d75x85mm		1f-d64mm 1f-d18mm
	H139	NO.			
	PALA MITSUBISHI FUSO - CANTER				
620x610mm		NULL			

	<p>A1737 NO. MB844274 - MB844275</p> <p>APOIO DE REPARAÇÃO MOTOR FRENTE</p> <p>MITSUBISHI GALANT ULTIMA (1995 A 1998)</p> <p>d70x52mm c38mm 1f-d16.5</p>		<p>A1803 NO. MB505495</p> <p>APOIO DA TRANSMISSÃO</p> <p>MITSUBISHI GALANT IV (E3 A) 2.0 4WD (E33A E38A E39A) (04-1989 A 10-1992) 10CV 1997 CC - MITSUBISHI GALANT IV (E3 A) 2.0 GTI 16V 4X4 (E38A E39A E33A) (07-1989 A 12-1992) 144CV 1997CC - MITSUBISHI GALANT IV 3VOLUMES (E3 A) 2.0 GTI 16V 4WD (E39A E38A E33A) (</p> <p>210x120x65mm 1f-d30mm</p>
	<p>E0018 NO. MB376954</p> <p>ESTICADOR DE ESCAPE</p> <p>MITSUBISHI GALANT (APÓS 88)</p> <p>68x54x25mm NULL</p>		<p>E0045 NO. MB149083</p> <p>ESTICADOR DE ESCAPE</p> <p>MITSUBISHI GALANT (75 A 78)</p> <p>100x40x27mm 1f-d16mm</p>
	<p>E1043 NO. MB059936 - MB059522 - MB059935 - MB059937 - MB906124 - 28658-21000</p> <p>ESTICADOR DE ESCAPE</p> <p>MITSUBISHI GALANT (APÓS 1988)</p> <p>NULL NULL</p>		<p>E1052 NO. MB376954 - MB906128</p> <p>ESTICADOR DE ESCAPE</p> <p>MITSUBISHI GALANT (1988 A 1996) - SIGMA (1991 A 1997)</p> <p>65x54x26mm 2f-d11mm</p>
	<p>F0512-I NO. MB109011 - MB176162 - MB176860 - MB297147 - MB297190</p> <p>FOLE DO SEMI-EIXO EXTERNO</p> <p>MITSUBISHI GALANT (1.6-1.8) - ETERNA (1.6-1.8)</p> <p>d83x85mm 1f-d72mm 1f-d22mm</p>		<p>F0694-I NO. MB176870 - MB297370</p> <p>FOLE DOS SEMI-EIXOS ESQUERDO E DIREITO</p> <p>MITSUBISHI GALANT - 1.8 AT (APÓS 8-83) - ETERNA 1.8 AT (APÓS 5-84) - GALANT - ETERNA 2.0 (APÓS 8-83)</p> <p>d90x86mm 1f-d23mm 1f-d79mm</p>
	<p>F0694-I NO. MB176870 - MB297370</p> <p>FOLE DO SEMI-EIXO DIREITO</p> <p>MITSUBISHI GALANT - ETERNA HARD TOP (APÓS 1-89)</p> <p>d90x86mm 1f-d23mm 1f-d79mm</p>		<p>F0694-I NO. MB176870 - MB297370</p> <p>FOLE DO SEMI-EIXO ESQUERDO</p> <p>MITSUBISHI GALANT E - E12A (APÓS 10-84)</p> <p>d90x86mm 1f-d23mm 1f-d79mm</p>
	<p>F1234-I NO. MB297379 - 23222-GA153 - MB620053 - 23222-GA150 - 23222-GA151</p> <p>FOLE DO SEMI-EIXO LADO CAIXA E RODA</p> <p>MITSUBISHI GALANT</p> <p>88x90mm 1f-d85mm 1f-d24mm</p>		<p>F1240-I NO. MB526516</p> <p>FOLE DA TRANSMISSÃO LADO DA RODA</p> <p>MITSUBISHI GALANT 1.8 - 18 STD - 2.0 E - 2.8 E35A - E33A (APÓS 1986) - ETERNA 1.8 - 2.0E</p> <p>d85x95mm 1f-d76mm 1f-d21mm</p>
	<p>F1252-I NO. MB160658 - MB297536</p> <p>FOLE JUNTO À CAIXA</p> <p>MITSUBISHI GALANT 1.8 E12A MT AT (APÓS 10-1984) - GALANT ETERNA 1.8 - 2.0 (APÓS 3-1984) - GALANT ETERNA HARD TOP 2.0 (APÓS 10-1984) (DO LADO DREITO)</p> <p>d102x95mm 1f-d80mm 1f-d25mm</p>		<p>F1254-I NO. MB526894 - MB937307 - MR446048 - MB526356</p> <p>FOLE DA TRANSMISSÃO JUNTO À CAIXA</p> <p>MITSUBISHI GALANT V 2.0i V6 24V (1992 A 1996)</p> <p>d83x95mm 1f-d25mm 1f-d72mm</p>
	<p>F1254-I NO. MB526894 - MB937307 - MR446048 - MB526356</p> <p>FOLE DA TRANSMISSÃO JUNTO À CAIXA</p> <p>MITSUBISHI SIGMA 3.0i V6 (1990 A 1996)</p> <p>d83x95mm 1f-d25mm 1f-d72mm</p>		<p>F1257-I NO. MB526148 - MB526274</p> <p>FOLE DE TRANSMISSÃO LADO DA RODA</p> <p>MITSUBISHI GALANT 1.8 (APÓS 1984) - ETERNA 2.0 (APÓS 1986)</p> <p>d95x91mm 1f-d80mm 1f-d26mm</p>

	<p>F1794-I NO. MB350581 - MB501711 - MR369122</p> <p>FOLE DA DIRECÇÃO LADO DIREITO E ESQUERDO</p> <p>MITSUBISHI GALANT 1.6 - 1.8 - 2.0 - 2.0i - 2.4i - 2.5i</p>		<p>KF3410 NO. MB176860 - MB297147 - MB297184 - MB297190 - MB297351 - MB393129 - MB526057</p> <p>FOLE DO LADO DA RODA</p> <p>MITSUBISHI ETERNA 1.6 - GALANT 1.6</p>
	<p>KF3421-T NO. MR222635</p> <p>KIT DE FOLE DO CARDAN JUNTO À RODA</p> <p>MITSUBISHI GALANT V (1992 A 1996) 2.0i V6 24V - RVR 2.0i</p>		<p>KF3423-T NO. MR222684 - MR336590 - MR336591</p> <p>KIT DE FOLE DO CARDAN JUNTO À RODA</p> <p>MITSUBISHI GALANT V (1992 A 1996) 2.0 TD - 2.0 TD GLS TD - 2.0i - 2.0i GLSi - 2.4 GDI - 2.5i V6 24V - GALANT VI (1996 A 2004) 2.0i - 2.0 TD - 2.4 GDi - 2.5i</p>
	<p>KF3493 NO. MB297379 - MB297569</p> <p>KIT DE FOLE DO CARDAN LADO DA RODA</p> <p>MITSUBISHI GALANT 1.8 (02-88 A 08-90) - 1.8TD (04-86 A 12-88) - 2.0 (04-84 A 12-85) - 2.0 WAGON (04-84 A 12-85)</p>		<p>KF3494 NO. MB6200 - MB936182</p> <p>KIT DE FOLE DO CARDAN LADO DA RODA</p> <p>MITSUBISHI GALANT 1.6 - 1.6 WAGON - 2.0 (06-86 A 02-88)</p>
	<p>L3056 NO. MB001766</p> <p>CASQUILHO DA BARRA DE TORÇÃO</p> <p>MITSUBISHI GALANT</p>		<p>M6027 NO. MB156180 - MB687001</p> <p>JUNTA DE ESCAPE</p> <p>MITSUBISHI GALANT (1984 A 1996)</p>
	<p>M6046 NO. MB313111 - MB687012</p> <p>JUNTA DE ESCAPE</p> <p>MITSUBISHI GALANT (1984 A 1992)</p>		<p>RT80044 NO. MB058593 - MB238161 - MB058509 - MB238162 - MB238164 - MB238166 - MB587740 - MB587559 - MB857561</p> <p>TUBO DE TRAVÃO TRÁS LH-RH</p> <p>MITSUBISHI GALANT (MOD II - A16) TT (09-1980 A 05-1984)</p>
	<p>RT80044 NO. MB058593 - MB238161 - MB058509 - MB238162 - MB238164 - MB238166 - MB587740 - MB587559 - MB857561</p> <p>TUBO DE TRAVÃO FRENTE LH-RH</p> <p>MITSUBISHI GALANT (MOD III - E1 A) TT (09-1982 A 12-1987) - GALANT (MOD IV - E3 A) TT (11-1987 A 10-1992)</p>		<p>RT80045 NO. MB239151</p> <p>TUBO DE TRAVÃO FRENTE LH-RH</p> <p>MITSUBISHI GALANT (MOD II - A16) TT (09-1980 A 05-1984) - GALANT (MOD III - E1 A) TT (09-1982 A 12-1987) - GALANT (MOD IV - E3 A) TT EXCEPTO 4X4 (11-1987 A 10-1992)</p>
	<p>RT80048 NO. MB500452 - MB587742 - MB857558 - MB857572 - MR129778</p> <p>TUBO DE TRAVÃO TRÁS LH-RH</p> <p>MITSUBISHI GALANT (MOD IV - E3 A) TT EXCEPTO 4X4 (11-1987 A 10-1992)</p>		<p>RT80360 NO. MB081939 - MB238153 - MB587751 - MB857532 - MB857545 - MR129750</p> <p>TUBO DE TRAVÃO DE TRÁS LH-RH</p> <p>MITSUBISHI GALANT III (E1_A) 1.6 GLX (E11A) (06.84 A 04.90) 75cv 1597cc três volumes - MITSUBISHI GALANT III (E1_A) 2.0 GLS (E15A) (06.86 A 04.90) 90cv 1997cc três volumes - MITSUBISHI GALANT III (E1_A) 2.0 GLS (E15A) (06.84 A 04.90) 102cv 1997cc três volumes - MITSUBISHI GALANT III (E1_A) 2.0 Turbo ECi (E15A) (06.84 A 04.90) 150cv 1997cc três volumes - MITSUBISHI GALANT III (E1_A) 2.4 GLS (E16A) (07.85 A 04.90) 112cv 2351cc três volume...etc.</p>
	<p>RT80360 NO. MB081939 - MB238153 - MB587751 - MB857532 - MB857545 - MR129750</p> <p>TUBO DE TRAVÃO DE TRÁS LH-RH</p> <p>MITSUBISHI SIGMA (F2_A - F1_A) 3.0 V6 (12.90 A 07.96) 177cv 2972cc três volumes - MITSUBISHI SIGMA (F2_A - F1_A) 3.0 V6 (12.90 A 07.96) 205cv 2972cc três volumes</p>		<p>T1065 NO. MB80884 - MB303052</p> <p>BATENTE DO CENTRO DA BARRA ESTABILIZADORA DA FRENTE</p> <p>MITSUBISHI GALANT - LANCER C11 - C12</p>

	Z80775	NO. MB253964		Z80778	NO. 6385401A00 - 91545SE0003 - MR328954
	Mola de fixação MITSUBISHI GALANT			Mola de fixação MITSUBISHI GALANT	
	d17x20mm	1p-d7-10mm		d20x26mm	1p-d8-15mm
	Z9006	NO. MB179443			
	MOLA DE ESCAPE MITSUBISHI GALANT (1980 A 1986) - L200 (APÓS 1992) - PAJERO (1982 A 1996) - SAPPORO (1980 A 1985) - STARION (1982 A 1990)				
	d26x45mm	NULL			

MITSUBISHI GRANDIS

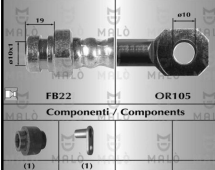
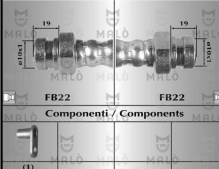
	RT80351	NO. MR955468		RT80564	NO. MR955461
	TUBO DE TRAVÃO DE TRÁS LH-RH MITSUBISHI GRANDIS (NA_W) 2.4 (APÓS 04.04) 165cv 2378cc Veículo multiuso - MITSUBISHI GRANDIS (NA_W) 2.0 DI-D (APÓS 09.05) 136cv 1968cc Veículo multiuso - MITSUBISHI GRANDIS (NA_W) 2.0 DI-D (APÓS 02.07) 140cv 1968cc Veículo multiuso			TUBO DE TRAVÃO DA FRENTE LH-RH MITSUBISHI GRANDIS (NA_W) 2.4 (APÓS 04.04) 165cv 2378cc Veículo multiuso	
	270mm	FB54 - MC50/1		505mm	FB22 - OR105
	RT80565	NO. MR955467			
	TUBO DE TRAVÃO INTERIOR MITSUBISHI GRANDIS (NA_W) 2.4 (APÓS 04.04) 165cv 2378cc Veículo multiuso - MITSUBISHI GRANDIS (NA_W) 2.0 DI-D (APÓS 09.05) 136cv 1968cc Veículo multiuso MITSUBISHI GRANDIS (NA_W) 2.0 DI-D (APÓS 02.07) 140cv 1968cc Veículo multiuso				
	405mm	FB22 - FB22			







MITSUBISHI L200-STRAKAR-STRADA-FORTE-TRITON

	A1113	NO. MB000815 - MB154199 - MB154706		A1120	NO. MB111253
	APOIO DO VEIO DE TRANSMISSÃO MITSUBISHI L200 4x2-K14T - 4x4-K34T			APOIO - BATENTE DE MOLA TRASEIRO MITSUBISHI L200 - K14-4x2 - K34-4x4	
	NULL	NULL		105x95x70mm	NULL
	A1121	NO. MB007023 - MB437578 - MB436578T - MD070023		A1121	NO. MB007023 - MB437578 - MB436578T - MD070023
	SUPORTE DA FRENTE DO MOTOR DIREITO E ESQUERDO MITSUBISHI L200 DIESEL - 4x2 - 4x4 (1989 A 1992) - L200 K14T - K34T 4x2 E 4x4			SUPORTE DA FRENTE DO MOTOR DIREITO E ESQUERDO MITSUBISHI L200 K14T - K34T 4x2 E 4x4	
	115x115x54mm	1p-d10-18mm		115x115x54mm	1p-d10-18mm

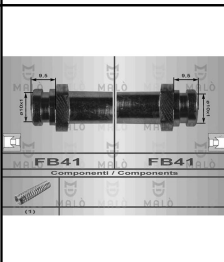
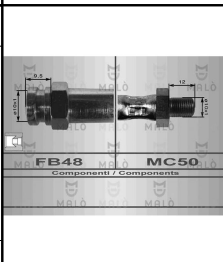











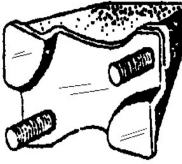
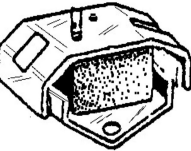

	<p>A1121 NO. MB007023 - MB437578 - MB436578T - MD070023</p> <p>SUPOORTE DA FRENTE DO MOTOR DIREITO E ESQUERDO</p> <p>MITSUBISHI STRADA</p> <p>115x115x54mm 1p-d10-18mm</p>		<p>A1129 NO. MB109916</p> <p>APOIO DO BRAÇO DA SUSPENSÃO DA FRENTE DIREITO</p> <p>MITSUBISHI L200</p> <p>100x75x70mm 2p-d12-30mm</p>
	<p>A1132 NO. MB185373 - MB109915</p> <p>APOIO DO BRAÇO DA SUSPENSÃO DA FRENTE ESQUERDO</p> <p>MITSUBISHI L200</p> <p>100x75x70mm 2p-d12-30mm</p>		<p>A1160 NO. MB581845-260676 - MB-581845 - MB-260676 - MR353470</p> <p>APOIO AUXILIAR DA CAIXA TRASEIRO</p> <p>MITSUBISHI L200 4x4 - L200-K34T</p> <p>87x62x48mm 1f-d10mm 1p-d10-20mm</p>
	<p>A1244 NO. MB154199 - MB000580 - MB-000815 - MB-154706</p> <p>APOIO DO VEIO DA TRANSMISSÃO</p> <p>MITSUBISHI L021 PICK-UP - L200 K14 - L200D CYCLONE</p> <p>205xd115x62mm 1f-d30mm</p>		<p>A1372 NO.</p> <p>SEPARADOR DAS MOLAS</p> <p>MITSUBISHI STRADA</p> <p>d41x6mm Pino d9x10mm</p>
	<p>A1376 NO. MB109530 - MB185995</p> <p>APOIO BRAÇO DA SUSPENSÃO DA FRENTE ESQUERDO</p> <p>MITSUBISHI L200</p> <p>102x80x80mm 2p-d12-37mm</p>		<p>A1376 NO. MB109530 - MB185995</p> <p>APOIO BRAÇO DA SUSPENSÃO DA FRENTE ESQUERDO</p> <p>MITSUBISHI STRADA</p> <p>102x80x80mm 2p-d12-37mm</p>
	<p>A1418 NO. MR133062</p> <p>APOIO DE MOTOR TRÁS (CAIXA DE VELOCIDADES)</p> <p>MITSUBISHI STRADA 2500 - 2800 D</p> <p>175-95-53mm NULL</p>		<p>A1421 NO. MB007023T</p> <p>APOIO DE MOTOR FRENTE DIREITO</p> <p>MITSUBISHI L200 D</p> <p>117x105x53mm 1p-d10-25mm</p>
	<p>A1421 NO. MB007023T</p> <p>APOIO DE MOTOR FRENTE DIREITO</p> <p>MITSUBISHI STRADA</p> <p>117x105x53mm 1p-d10-25mm</p>		<p>A1423 NO. MR151375 - MR151328</p> <p>APOIO DE MOTOR FRENTE DIREITO E ESQUERDO</p> <p>MITSUBISHI STRADA 2800</p> <p>126x122x72mm 1p-d10-25mm</p>
	<p>A1429 NO. MB436365 - MB436365T</p> <p>APOIO DE MOTOR TRÁS (CAIXA DE VELOCIDADES)</p> <p>MITSUBISHI L200</p> <p>175x95x52mm NULL</p>		<p>A1433 NO. MB109531</p> <p>APOIO DO BRAÇO DA SUSPENSÃO FRENTE DIREITO</p> <p>MITSUBISHI L200</p> <p>95x75x70mm 2p-d12-33mm</p>
	<p>A1433 NO. MB109531</p> <p>APOIO DO BRAÇO DA SUSPENSÃO FRENTE DIREITO</p> <p>MITSUBISHI STRADA</p> <p>95x75x70mm 2p-d12-33mm</p>		<p>A1546 NO. MB154279</p> <p>APOIO DA TRANSMISSÃO</p> <p>MITSUBISHI STRADA 4WD</p> <p>210x130x60mm 1f-d30mm</p>

	<p>A1709 NO. MR133073T</p> <p>APOIO DO MOTOR PARTE DE TRÁS</p> <p>MITSUBISHI STRADA 4 WD</p> <p>170x170x160mm NULL</p>		<p>A1712 NO. MB260670</p> <p>APOIO DA CAIXA DE VELOCIDADES PARTE DE TRÁS</p> <p>MITSUBISHI L200 4 WD K22T - K23T - K24T - K32T - K33T - K34T - PAJERO L042G - L043G - L044G - L047G - L048G - L049G - L149G</p> <p>155x140x85mm 2f-d12mm 2f-d11mm</p>
	<p>A1713 NO. MB154080 - MB154081</p> <p>APOIO DA TRANSMISSÃO</p> <p>MITSUBISHI L200 2WD(79 A 89) L021P - L025P</p> <p>200x116x60mm 1f-d30mm</p>		<p>A1740 NO. MB185502</p> <p>APOIO BATEnte DA SUSPENSAO DA FRENTE SUPERIOR</p> <p>MITSUBISHI L200 K - K64 - K67</p> <p>50x50x40mm 1p-d8-20mm</p>
	<p>A1764 NO. MB-691282</p> <p>APOIO DO MOTOR PARTE DE TRÁS CAIXA VELOCIDADES</p> <p>MITSUBISHI L200</p> <p>170x160x105mm 4f-d11mm</p>		<p>A1775 NO. MR580647</p> <p>APOIO DA TRANSMISSÃO</p> <p>MITSUBISHI L200 (KB_T - KA_T) - 2.5 DI-D 4X4 (KB4T) PICK-UP 136CV (APÓS 11-2005)</p> <p>190x125x56mm 1f-d30mm 2f-11/14mm</p>
	<p>A1802 NO. 09319-12044 - 0931912044</p> <p>APOIO DA TRANSMISSÃO</p> <p>MITSUBISHI L200 (KB T KA T) 2.5 DI D 4WD (APÓS 11-2005)</p> <p>188x125x55mm 1f-d30mm</p>		<p>A1860 NO. MR223119 - MN171429</p> <p>APOIO DA TRANSMISSÃO</p> <p>MITSUBISHI L 200 (K3_T - K2_T - K1_T - K0_T) 2.5 TD 4WD (K34T) Pick-up (11.92 A 08.96) 87CV 2477CC - MITSUBISHI L 200 (K7_T - K6_T) 2.5 TD 4WD (K74T) Pick-up (06.96 A 12.07) 99CV 2477CC - MITSUBISHI L 200 (K7_T - K6_T) 2.5 TD 4WD (K74T) Pick-up (09.01 A 12.07)</p> <p>195x105x60mm 2f-d11mm 1f-d30mm</p>
	<p>A1864 NO. MR992717</p> <p>APOIO DA CAIXA DE VELOCIDADES</p> <p>MITSUBISHI L200 (KB_T - KA_T) 2.5 DID 4WD (KB4T) Pick-up (11.05 A 08.06) 136CV 2477CC - MITSUBISHI L200 (KB_T - KA_T) 2.5 DID 4WD (KB 4T) Pick-up (APÓS 11.05) 136CV 2477CC - MITSUBISHI L200 (KB_T - KA_T) 2.5 DID 4WD (KB4 T)Pick-up (APÓS 10.07) 167CV 2477CC</p> <p>284x100x75mm 4f-d11mm 2p-d25mm</p>		<p>A1928 NO. MR995005 - MR112003 - MR992670</p> <p>APOIO DO MOTOR PARTE DA FRENTE</p> <p>MITSUBISHI L 200 / TRITON (KA_T, KB_T) 2.5 DI-D 4WD (KB4T) (A Partir de 11.05) 136cv 2477cc Pick-up</p> <p>125x120x65mm 1p-d10mm 2f-14x11mm</p>
	<p>E0079 NO. MB527168</p> <p>ESTICADOR DA BARRA ESTABILIZADORA (PONTAS)</p> <p>MITSUBISHI L200 - E12</p> <p>d34x130mm d25mm</p>		<p>E0248 NO. MB598097</p> <p>ESTICADOR DA BARRA ESTABILIZADORA DA FRENTE</p> <p>MITSUBISHI L200 (K24T) 2.5 D (12-1987 A 05-1993) - L200 (K34T) 2.5 TD 4WD (11-1992 A 08-1996) - L200 (K33T) 2.6 4WD (11-1989 A 05-1995)</p> <p>71x32mm 1p-d10mm</p>
	<p>E1025 NO. MB431175</p> <p>ESTICADOR DE ESCAPE</p> <p>MITSUBISHI L200 (APÓS 1988)</p> <p>75x70x20mm 3f-d10mm</p>		<p>E1088 NO. MB-185618</p> <p>ESTICADOR DO ESCAPE</p> <p>MITSUBISHI L200</p> <p>76x74x30mm 3f-d10mm</p>
	<p>F1252-I NO. MB160658 - MB297536</p> <p>FOLE JUNTO À CAIXA</p> <p>MITSUBISHI FORTE 2.0 4WD</p> <p>d102x95mm 1f-d80mm 1f-d25mm</p>		<p>H348 NO.</p> <p>PALA ORIGINAL</p> <p>MITSUBISHI PICK-UP - L200</p> <p>500x285mm NULL</p>

	<p>H348 NO.</p> <p>PALA ORIGINAL</p> <p>MITSUBISHI STRADA</p> <p>500x285mm NULL</p>		<p>KF3415-T NO. MR110859</p> <p>KIT DE FOLE LADO DA RODA</p> <p>MITSUBISHI L200 2000E 4X4 - 2500 DIESEL PICK-UP E CLUB 2500TD GL - GLS - GLX - 2500T DIESEL PICK UP 4X4</p> <p>d103x150mm 1f-d88mm 1f-d29mm</p>
	<p>KF3480 NO. MB526148 - MB526274 - MB526275 - MB896069</p> <p>KIT DE FOLE DO CARDAN JUNTO À RODA</p> <p>MITSUBISHI L200 2,5D 70CV (11-1986 A 08-1996) - 2.4 4X4 132CV (APOS 06-1996)</p> <p>d93x98mm 1f-d26mm 1f-d83mm</p>		<p>KM0406 NO. MB110494</p> <p>KIT DE BRINCOS DAS MOLAS TRÁS (PARTE DE TRÁS - COMPOSTO POR 2 L3053 MAIS 2 L3059)</p> <p>MITSUBISHI L200</p> <p>120x120x40mm d28mm</p>
	<p>KM0420 NO. MB111200</p> <p>KIT DE BRINCOS DAS MOLAS DE TRÁS PARTE DA FRENTE (COMPOSTO POR 2 CASQUILHOS L 3021)</p> <p>MITSUBISHI L200</p> <p>76x53x88mm d-32mm 1p-d11.8-23mm</p>		<p>KM0430 NO. SK43037 - MB110494 - MB110496</p> <p>KIT DE BRINCOS DAS MOLAS DE TRÁS PARTE DE TRÁS (CAVILHAS LUBRIFICAVEIS)</p> <p>MITSUBISHI L200 (K3_T - K2_T - K1_T - K0_T) 2.5 D (K14T) Ano fabric. A partir de: (01.87) (11.86 - 10.96) 70cv 2476cc Pick-up - MITSUBISHI L 200 (K3_T - K2_T - K1_T - K0_T) 2.5 D 4WD (K24T) Ano fabric. A partir de: (01.88) (12.87 - 05.93) 70cv 2476cc Pick-up -</p> <p>150x120x43mm d16mm 2p-d12x25mm</p>
	<p>L1051 NO. MB584530 - MT362394 - MB-111070</p> <p>CASQUILHO DE MOLA TRÁS</p> <p>MITSUBISHI L200</p> <p>d35x45mm d27.5mm 1f-d16mm</p>		<p>L1052 NO. MB584531 - MT362413 - MB-111071</p> <p>CASQUILHO DE MOLA TRÁS</p> <p>MITSUBISHI L200</p> <p>d35x54mm d27.5mm 1f-d16mm</p>
	<p>L1086 NO.</p> <p>CASQUILHO - ESTICADOR DA SUSPENSÃO</p> <p>MITSUBISHI L200</p> <p>d54x27mm 1f-d21mm</p>		<p>L3011 NO. MB109529</p> <p>CASQUILHO DO BRAÇO INFERIOR DA SUSPENSÃO</p> <p>MITSUBISHI L200</p> <p>d38x44mm d29mm 1f-d18mm</p>
	<p>L3045 NO. MB176371</p> <p>CASQUILHO DO ESTICADOR DA SUSPENSÃO</p> <p>MITSUBISHI L200 (K14)</p> <p>d58x31mm 1f-d20mm</p>		<p>L3049 NO. MB176372</p> <p>CASQUILHO DO ESTICADOR DA BARRA DE TORÇÃO</p> <p>MITSUBISHI L200 - K14</p> <p>d56x25mm 1f-d19mm</p>
	<p>L3055 NO. MB001868</p> <p>CASQUILHO DA BARRA DE TORÇÃO</p> <p>MITSUBISHI L200</p> <p>d50x26mm 1f-d20mm</p>		<p>L3069 NO. MB005833</p> <p>CASQUILHO DO PENDURAL DA DIRECÇÃO</p> <p>MITSUBISHI L200</p> <p>d33x21mm d22mm 1f-d17mm</p>
	<p>P1037 NO. MA126093</p> <p>CAPA DE PEDAL TRAVÃO EMBRAIAGEM E ACELARADOR</p> <p>MITSUBISHI L200 - LANCER - GALANT - COLT</p> <p>69x48x8mm NULL</p>		<p>R8015 NO. MB009016 - AD009016</p> <p>TUBO DA BOMBA DE ÁGUA</p> <p>MITSUBISHI L200</p> <p>B175-d16/16mm 45-80-80mm</p>

	<p>R8124 NO. MR-127413</p> <p>TUBO DO FILTRO DE AR</p> <p>MITSUBISHI L200 STRADA 2.5 D (K64T) (APÓS 06-1996)</p>		<p>R8130 NO. MN171012T</p> <p>TUBO DO FILTRO DO AR</p> <p>MITSUBISHI L200 PICK UP 2.5 (APÓS 06-2012) 2.5 CC</p>
	<p>RT80044 NO. MB058593 - MB238161 - MB058509 - MB238162 - MB238164 - MB238166 - MB587740 - MB857559 - MB857561</p> <p>TUBO DE TRAVÃO FRENTE LH-RH</p> <p>MITSUBISHI L200 2.5D ((11-1986 A 08-1996)</p>		<p>RT80045 NO. MB239151</p> <p>TUBO DE TRAVÃO TRÁS LH-RH</p> <p>MITSUBISHI L200 2.5D - 2.5 TD (11-1986 A 08-1996)</p>
	<p>RT80048 NO. MB500452 - MB587742 - MB857558 - MB857572 - MR129778</p> <p>TUBO DE TRAVÃO FRENTE LH-RH</p> <p>MITSUBISHI L200 2.0 - 2.0 4X4 - 2.5D - 2.5 TD 4X4 (APÓS 06-1996)</p>		<p>RT80049 NO. MB857552 - MB238425</p> <p>TUBO DE TRAVÃO FRENTE LH-RH</p> <p>MITSUBISHI L200 2.5 TD - 2.5 TD 4WD - 2.6 4WD (11-1986 A 08-1996)</p>
	<p>RT80328 NO. MR129795</p> <p>TUBO DE TRAVÃO TRÁS LH-RH</p> <p>MITSUBISHI L200 2.5 D (K64T) 4D56 (8V) 75CV (06-1996 A 12-2007) - 2.5 TD 4X4 (K74T) 4D56 T 100CV (11-2001 A 12-2007) - 2.5 TD 4X4 (K74T) 4D56 TD 99CV (06-1996 A 12-2007)</p>		<p>RT80350 NO. MB857535 - MR129753</p> <p>TUBO DE TRAVÃO FRENTE E TRÁS LH-RH</p> <p>MITSUBISHI L200 2.5 TD 4WD (K34T) (APÓS 11-1992)</p>
	<p>S1111 NO. MB515925</p> <p>SILENT-BLOC DAS MOLAS</p> <p>MITSUBISHI L200 4x4</p>		<p>S1111-A NO. MB515925</p> <p>SILENT-BLOC DAS MOLAS</p> <p>MITSUBISHI L200 4x4</p>
	<p>S1111-B NO. MB515925</p> <p>SILENT-BLOC DAS MOLAS</p> <p>MITSUBISHI L200 4x4</p>		<p>S1256 NO. MB109662</p> <p>SILENT-BLOC DO BRAÇO DA SUSPENSÃO FRENTE INFERIOR</p> <p>MITSUBISHI L200 - PAGERO (1987 A 1993)</p>
	<p>S1279 NO. MB132039</p> <p>SILENT-BLOC DO BRAÇO DA SUSPENSÃO SUPERIOR</p> <p>MITSUBISHI STRADA K64RBI</p>		<p>S1280 NO. MB430462</p> <p>SILENT-BLOC DO BRAÇO DA SUSPENSÃO SUPERIOR</p> <p>MITSUBISHI L200</p>
	<p>S1403 NO. MB-633870</p> <p>SILENT BLOC DO BRAÇO DA SUSPENSÃO DA FRENTE PARTE INFERIOR</p> <p>MITSUBISHI STRADA 4WD - PAJERO V6</p>		<p>S1420 NO. MB633820</p> <p>SILENT-BLOC DO BRAÇO DA SUSPENSÃO DA FRENTE PARTE SUPERIOR</p> <p>MITSUBISHI STRADA 4X4</p>

	<p>S1452 NO. MB515303 - MR151808</p> <p>SILENT-BLOC DAS MOLAS DE TRÁS OLHAL DA FRENTE</p> <p>MITSUBISHI STRADA 4WD</p> <p>d41x78.5mm c70mm 1f-d14.6mm</p>		<p>S1522 NO. MR992256</p> <p>SILENT BLOC DO BRAÇO TRANSVERSAL</p> <p>MITSUBISHI L200 (KB T KA T) 2.5 DI D 4WD (KB4T) (APOS 11-2005) 136CV 2477CC</p> <p>d62x64.5mm c46mm 1f-d16mm</p>
	<p>T0037 NO. MB175804</p> <p>BATENTE DA BARRA ESTABILIZADORA</p> <p>MITSUBISHI L200</p> <p>40x39x36mm 1f-d23mm</p>		<p>T1021 NO. MB109557</p> <p>BATENTE DA BARRA ESTABILIZADORA</p> <p>MITSUBISHI L200</p> <p>38x38x36mm 1f-d26mm</p>
	<p>T1038 NO. MR-150767</p> <p>BATENTE DA BARRA ESTABILIZADORA PONTAS FRENTE</p> <p>MITSUBISHI STRADA 4WD - L200 4X4</p> <p>46x41x39mm 1f-d20mm</p>		<p>T1060 NO. MB111240</p> <p>BATENTE DO CENTRO DA BARRA ESTABILIZADORA FRENTE</p> <p>MITSUBISHI STRADA</p> <p>38x29x30mm 1f-d14mm</p>
	<p>T1061 NO. 09319-12044 - 0931912044</p> <p>BATENTE DO CENTRO DA BARRA ESTABILIZADORA</p> <p>MITSUBISHI L200</p> <p>39x39x35mm 1f-d23mm</p>		<p>T1110 NO. MR151326</p> <p>BATENTE DA BARRA ESTABILIZADORA</p> <p>MITSUBISHI STRADA 4WD K77 T 2800 CC</p> <p>41x40x44mm 1f-d24mm</p>
	<p>T1120 NO. MB109219</p> <p>BATENTE DA BARRA ESTABILIZADORS DE TRÁS</p> <p>MITSUBISHI L200 2.6 4WD (K33T) (11-1989 A 05-1995) - 2.5 D (K14T) (11-1986 A 08-1996) - 2.5 D 4WD(K24T)(12-1987 A 05-1993) - 2.5 TD 4WD(K34T) - 2.0(K62T) (APÓS 06-1996) - 2.4 4X4 (K75T) (APÓS 06-1996) - 2.5 D(K64T)(APÓS 06-1996) - 2.5 TD 4X4(K74T)(APÓS 06</p> <p>38x36x43mm 1f-d19mm 30x38mm</p>		<p>T1129 NO. MR151327</p> <p>BATENTE DA BARRA ESTABILIZADORA INFERIOR DA FRENTE</p> <p>MITSUBISHI L200 PICK-UP (K7_T - K6_T) (K74T) 2.5 TD 4WD 99CV 2477cc (06-1996 A 12-2007) - 2.5 TD 4WD 115CV 2477cc (09-2001 A 12-2007) - 2.5 TD 4WD 133CV 2477cc (08-2001 A 12-2007)</p> <p>42x41x44mm 1f-d27mm 35x30x36mm</p>
	<p>T1139 NO. MR992317</p> <p>BATENTE DA BARRA ESTABILIZADORA DA FRENTE PARTE DO MEIO</p> <p>MITSUBISHI L 200 (KB_T - KA_T) 2.5 DI-D (KA4T) Pick-up (APÓS 04.10) 128CV 2477CC - MITSUBISHI L 200 (KB_T - KA_T) 2.5 DI-D 4WD (KB4T) Pick-up (APÓS 11.05) 136CV 2477CC - MITSUBISHI L 200 (KB_T - KA_T) 2.5 DI-D Pick-up (APÓS 08.07) 167CV 2477CC - MITSUBISHI L</p> <p>49x58x57mm 36x45x46mm 1f-d24mm</p>		<p>W5042 NO. MD110165 - MD050355 - 23129-42070 - 23124-42000 - 23124-42001 - 23429-42070</p> <p>POLIE DA CAMBOTA (1+1 PISTAS)</p> <p>MITSUBISHI L200</p> <p>d174mm d35mm</p>
	<p>W5043 NO. MD160546 - 23124-42010 - 23124-42011 - 23129-42000</p> <p>POLIE DA CAMBOTA (1 PISTA)</p> <p>MITSUBISHI L200</p> <p>d170/180mm d35mm</p>		<p>W5114 NO. MD374223</p> <p>POLIE DA CAMBOTA (1+1 PISTAS)</p> <p>MITSUBISHI L200 (K7 T K6 T) 2.4 4WD (06-1996 A 12-2007) 132CV 2351CC - MITSUBISHI L200 (K7 TK6 T) 2.5 D (06-1996 A 12-2007) 75CV 2477CC - MITSUBISHI L200 (K7 T K6 T) 2.5 TD 4WD (06-1996 A 12-2007) 99CV 2477CC - MITSUBISHI L200 (K7 T K6 T) 2.5 TD 4WD (09-2</p> <p>d173mm d35mm</p>
	<p>Z80775 NO. MB253964</p> <p>Mola de fixação</p> <p>MITSUBISHI STRAKAR</p> <p>d17x20mm 1p-d7-10mm</p>		

	<p>A1121 NO. MB007023 - MB437578 - MB436578T - MD070023</p> <p>SUPOORTE DA FRENTE DO MOTOR DIREITO E ESQUERDO</p> <p>MITSUBISHI L300 DELICO L038P - L300 L039P</p> <p>115x115x54mm 1p-d10-18mm</p>		<p>A1129 NO. MB109916</p> <p>APOIO DO BRAÇO DA SUSPENSÃO DA FRENTE DIREITO</p> <p>MITSUBISHI L300 - L039P CAIXA ABERTA - L300 D</p> <p>100x75x70mm 2p-d12-30mm</p>
	<p>A1132 NO. MB185373 - MB109915</p> <p>APOIO DO BRAÇO DA SUSPENSÃO DA FRENTE ESQUERDO</p> <p>MITSUBISHI L300 - L039P CAIXA ABERTA - L300 D</p> <p>100x75x70mm 2p-d12-30mm</p>		<p>A1140 NO. MB007038 - MB691203</p> <p>SUPOORTE DA FRENTE DO MOTOR</p> <p>MITSUBISHI L300 DIESEL (1980 A 1987)</p> <p>135x115x60mm 1p-d9,5-27mm</p>
	<p>A1372 NO.</p> <p>SEPARADOR DAS MOLAS</p> <p>MITSUBISHI L300</p> <p>d41x6mm Pino d9x10mm</p>		<p>A1721 NO. MB-260882</p> <p>APOIO DO MOTOR PARTE DE TRÁS</p> <p>MITSUBISHI L300 4D55 - 4D56</p> <p>58x58x55mm 1f-d10mm 1p-d10-20mm</p>
	<p>A1722 NO. MB-436036</p> <p>APOIO DO MOTOR PARTE DE TRÁS</p> <p>MITSUBISHI L300 (87 A 89)</p> <p>105x80x100mm 1f-d13mm</p>		<p>A1723 NO. MB-438440</p> <p>APOIO DO MOTOR PARTE DA FRENTE ESQUERDO</p> <p>MITSUBISHI L300 (87 A 90)</p> <p>125x130x70mm 1p-d10mm 1f-d13mm</p>
	<p>A1724 NO. MB-438441 - MB436444 - MB436832 - MB436833</p> <p>APOIO DO MOTOR PARTE DA FRENTE DIREITO E ESQUERDO</p> <p>MITSUBISHI L300 (87 A 90)</p> <p>125x130x70mm 1p-d10mm 1f-d13mm</p>		<p>E0018 NO. MB376954</p> <p>ESTICADOR DE ESCAPE</p> <p>MITSUBISHI L300 (APÓS 86)</p> <p>68x54x25mm NULL</p>
	<p>E0045 NO. MB149083</p> <p>ESTICADOR DE ESCAPE</p> <p>MITSUBISHI L300 (80-87)</p> <p>100x40x27mm 1f-d16mm</p>		<p>E1043 NO. MB059936 - MB059522 - MB059935 - MB059937 - MB906124 - 28658-21000</p> <p>ESTICADOR DE ESCAPE</p> <p>MITSUBISHI L300 4WD (APÓS 1986)</p> <p>NULL NULL</p>
	<p>E1052 NO. MB376954 - MB906128</p> <p>ESTICADOR DE ESCAPE</p> <p>MITSUBISHI L300 (1986 A 1996)</p> <p>65x54x26mm 2f-d11mm</p>		<p>KF3480 NO. MB526148 - MB526274 - MB526275 - MB896069</p> <p>KIT DE FOLE DO CARDAN JUNTO Á RODA</p> <p>MITSUBISHI L300 AUTOCARRO 1.8 4X4 82CV (08-1984 A 02-1987) - 2.3 D 68CV (04-1983 A 10-1986) - L300 CAIXA 2.3 68CV (09-1983 A 10-1986) - L300 CAMIÃO DE PLATAFORMA/CHASSIS 2.5 D 69CV (11-1986 A 04-1994) - L300 AUTOCARRO 2.0 4WD 90CV (APÓS 11-1986)</p> <p>d93x98mm 1f-d26mm 1f-d83mm</p>
	<p>KM0420 NO. MB111200</p> <p>KIT DE BRINCOS DAS MOLAS DE TRÁS PARTE DA FRENTE (COMPOSTO POR 2 CASQUILHOS L 3021)</p> <p>MITSUBISHI L300</p> <p>76x53x88mm d-32mm 1p-d11.8-23mm</p>		<p>L1086 NO.</p> <p>CASQUILHO - ESTICADOR DA SUSPENSÃO</p> <p>MITSUBISHI L300 - L039P CAIXA ABERTA</p> <p>d54x27mm 1f-d21mm</p>

	<p>P1036 NO. MT146280</p> <p>CAPA DE PEDAL TRAVÃO E EMBRAIAGEM</p> <p>mitsubishi L300</p> <p>62x54x11mm NULL</p>		<p>R8015 NO. MB009016 - AD009016</p> <p>TUBO DA BOMBA DE ÁGUA</p> <p>mitsubishi L300</p> <p>B175-d16/16mm 45-80-80mm</p>
	<p>R8026 NO. MB007728 - MB110082</p> <p>TUBO DE RADIADOR INFERIOR</p> <p>mitsubishi L300</p> <p>B240-d34/34mm 200-155-185mm</p>		<p>R8027 NO. MB007725 - MB110068</p> <p>TUBO DE RADIADOR SUPERIOR</p> <p>mitsubishi L300</p> <p>B300-d33/33mm 75-105-55-65mm</p>
	<p>R8032 NO. MB356347</p> <p>TUBO SUPERIOR DO RADIADOR</p> <p>mitsubishi L300</p> <p>NULL NULL</p>		<p>R8033 NO. MB356348</p> <p>TUBO INFERIOR DO RADIADOR</p> <p>mitsubishi L300</p> <p>NULL NULL</p>
	<p>RT80046 NO. MB238160 - MR129777 - MB058592 - MB587741</p> <p>TUBO DE TRAVÃO FRENTE LH-RH</p> <p>mitsubishi L300 TT</p> <p>264mm FB41 - FB41</p>		<p>RT80050 NO. MB150672 - MB699986 - MR129724 - MB150762</p> <p>TUBO DE TRAVÃO TRÁS LH-RH</p> <p>mitsubishi L300</p> <p>380mm FB41 - FB41</p>
	<p>RT80050 NO. MB150672 - MB699986 - MR129724 - MB150762</p> <p>TUBO DE TRAVÃO TRÁS LH-RH</p> <p>mitsubishi L300 TT</p> <p>380mm FB41 - FB41</p>		<p>RT80372 NO. MB058595</p> <p>TUBO DE TRAVÃO TRÁS LH-RH</p> <p>mitsubishi L300 2.0 4WD (APÓS 11-1986) - 2.4 4WD (APÓS 11-1986)</p> <p>380mm FB51 - FB51</p>
	<p>RT80375 NO. MR129720</p> <p>TUBO DE TRAVÃO FRENTE LH-RH</p> <p>mitsubishi L300 2.0 (APÓS 07-1994) - 2.5 D (APÓS 12-1994)</p> <p>295mm FB51 - FB51</p>		<p>RT80566 NO. MB500748</p> <p>TUBO DE TRAVÃO DA FRENTE LH-RH</p> <p>mitsubishi L 300 III Autocarro (P0_W - P1_W - P2_W) 2.0 4WD (P23W - P03W - P13W) (12.86 A 05.04) 88cv 1997cc Autocarro - MITSUBISHI L 300 III Autocarro (P0_W - P1_W - P2_W) 2.0 4WD (P23W - P03W - P13W) (11.86 A 05.04) 90cv 1997cc Autocarro - MITSUBISHI L 300 III Autocarro (P0_W - P1_W - P2_W) 2.4 4WD (P24W) (11.86 A 12.90) 109cv 2351cc Autocarro - MITSUBISHI L 300 III Autocarro (P0_W - P1_W - P2_W) 2.4 4WD (P24W) (11.90 A 05.04) 112cv 2351cc ...etc.</p> <p>210mm FB41 - FB41</p>
	<p>S1203 NO.</p> <p>SILENT-BLOC DE MOLAS</p> <p>mitsubishi L300</p> <p>d40x80mm c70mm 1f-d14mm</p>		<p>S1230 NO.</p> <p>SILENT-BLOC DAS MOLAS DE TRÁS PARTE DA FRENTE</p> <p>mitsubishi L300</p> <p>80x75x55mm c68mm 1f-d14mm</p>
	<p>S1255 NO. MB430145 - MR319537 - MB598017 - MB598018 - 54510-43152 - 54522-43002 - 54522-43003 - 54522-43500 -</p> <p>SILENT-BLOC DO BRAÇO DE SUSPENSÃO INFERIOR FRENTE</p> <p>mitsubishi L300 (1988 A 1995)</p> <p>d56x70mm c51mm d45mm 1f-d15.5mm</p>		<p>S1459 NO. MB430200</p> <p>SILENT BLOC DO BRAÇO DA SUSPENSÃO</p> <p>mitsubishi L300</p> <p>d58x77mm c64mm d51/49mm 1f-d25.5mm</p>

	S1460 NO. MB430201 SILENT BLOC DO BRAÇO DA SUSPENSÃO MITSUBISHI L300 d55x41mm c29mm d46/44.5mm 1f-d22.3mm		S1540 NO. MB109937 SILENT-BLOC DO BRAÇO DA SUSPENSÃO DA FRENTE PARTE INFERIOR MITSUBISHI L300 d41x80mm c54mm d37mm 1f-d14,4mm
	S1547 NO. MB109936 SILENT-BLOC DO BRAÇO DA SUSPENSÃO DA FRENTE PARTE INFERIOR MITSUBISHI L300 d39x80mm d36x52mm 1f-d14mm		T0035 NO. MB175581 BATENTE DA PONTA DA BARRA ESTABILIZADORA MITSUBISHI L300 40x38x38mm 1f-d20mm
	T0036 NO. 09319-12044 - 0931912044 BATENTE DO CENTRO DA BARRA ESTABILIZADORA MITSUBISHI L300 42x42x40mm 1f-d18mm		T1161 NO. MB175534 BATENTE DA BARRA ESTABILIZADORA DA FRENTE MITSUBISHI L 300 III Autocarro (P0_W - P1_W - P2_W) 1.6 (P02W - P12W) (11.86 A 05.04) 69cv 1598cc Autocarro - MITSUBISHI L 300 III Autocarro (P0_W - P1_W - P2_W) 2.5 D (P05W - P15W - P25W) (11.86 A 05.04) 69cv 2477cc Autocarro - MITSUBISHI L 300 III Caixa (P0_V - P1_V - P_2V) 1.6 (P12V - P02V) (11.86 A 05.94) 69cv 1598cc Caixa - MITSUBISHI L 300 III Caixa (P0_V - P1_V - P_2V) 2.5 D (P05V - P05W - P15V) (11.86 A 02.06) 69cv 2477cc Caixa 38x41x40mm 31x37x35mm 1f-d21mm
	W5042 NO. MD110165 - MD050355 - 23129-42070 - 23124-42000 - 23124-42001 - 23429-42070 POLIE DA CABBOTA (1+1 PISTAS) MITSUBISHI L300 (MOTOR 4D-562-TD) d174mm d35mm		W5043 NO. MD160546 - 23124-42010 - 23124-42011 - 23129-42000 POLIE DA CABBOTA (1 PISTA) MITSUBISHI L300 (MOTOR 4D-561-TD) d170/180mm d35mm

MITSUBISHI L400

	A1598 NO. MR165252 APOIO DA TRANSMISSÃO MITSUBISHI L400 200x120x60mm 1f-d30mm		RT80368 NO. MB500748 - MB857551 - MR129771 TUBO DE TRAVÃO DA FRENTE LH-RH MITSUBISHI L 400 Autocarro (PD_W - PC_W - PA_W - PB_V - PA_W) 2.0 16V (PA3V/W - PB3V - PA3W) (05.95 A 05.00) 115cv 132cv 2351cc Autocarro - MITSUBISHI L 400 Autocarro (PD_W - PC_W - PA_V - PB_V - PA_W) 2.4 i 4WD (PD4V/W) (05.95 A 05.00) 132cv 2351cc Autocarro - MITSUBISHI L 400 Autocarro (PD_W - PC_W - PA_V - PB_V - PA_W) 2.5 TD (PA5V/W - PB5V) (05.95 A 05.00) 99cv 2477cc Autocarro - MITSUBISHI L 400 Autocarro (PD_W - PC_W - PA_V - PB_V - PA_W) 2.5 ...etc. 215mm FB51 - FB51
	RT80567 NO. MR129793 TUBO DE TRAVÃO DE TRÁS LH MITSUBISHI L 400 Autocarro (PD_W - PC_W - PA_V - PB_V - PA_W) 2.0 16V (PA3V/W - PB3V - PA3W) (05.95 A 05.00) 115cv 1997cc Autocarro - MITSUBISHI L 400 Autocarro (PD_W - PC_W - PA_V - PB_V - PA_W) 2.4 i 4WD (PD4V/W) (05.95 A 05.00) 132cv 2351cc Autocarro - MITSUBISHI L 400 Autocarro (PD_W - PC_W - PA_V - PB_V - PA_W) 2.5 TD (PA5V/W - PB5V) (05.95 A 05.00) 99cv 2477cc Autocarro - MITSUBISHI L 400 Autocarro (PD_W - PC_W - PA_V - PB_V - PA_W) 2.5 ...etc. 355mm FB51 - FB51		S1238 NO. 55147-43002 SILENT-BLOC DAS MOLAS DE TRÁS (PARTE DE TRÁS) MITSUBISHI L400 d55.5x79mm c70mm 1f-d14mm
	S1295 NO. SILENT-BLOC DAS MOLAS TRÁS PARTE FRENTE MITSUBISHI L400 d55.5x80mm c70mm 1f-d16.5mm		S1496 NO. MR112709 - 545224B010 - 545224B000 - 545404B001 - 545504A000 - 545104B001 SILENT BLOC DO BRAÇO TRANSVERSAL MITSUBISHI L400 PA3W - PA4W (1994 A 2002) - L400 SPACE GEAR PD4W - PD5W (1994 A 2001) d53x76mm c51mm d40mm 1f-d16.3mm

	W5097	NO. MD305544		
	POLIE DA CAMBOTA MITSUBISHI L400			
	d173mm	d35mm		

MITSUBISHI LANCER-CELESTE-FIORE-MIRAGE-CHAMP

	A1713	NO. MB154080 - MB154081		A1722	NO. MB-436036
	APOIO DA TRANSMISSÃO MITSUBISHI LANCER A161 (83 A 86)			APOIO DO MOTOR PARTE DE TRÁS MITSUBISHI LANCER GLX	
	200x116x60mm	1f-d30mm		105x80x100mm	1f-d13mm
	E0018	NO. MB376954		E0045	NO. MB149083
	ESTICADOR DE ESCAPE MITSUBISHI LANCER (86 A 88)			ESTICADOR DE ESCAPE MITSUBISHI CELESTE (76 A 78) - LANCER (75 A 79) - L 300 (80-87)	
	68x54x25mm	NULL		100x40x27mm	1f-d16mm
	E1043	NO. MB059936 - MB059522 - MB059935 - MB059937 - MB906124 - 28658-21000		E1052	NO. MB376954 - MB906128
	ESTICADOR DE ESCAPE MITSUBISHI LANCER			ESTICADOR DE ESCAPE MITSUBISHI LANCER	
	NULL	NULL		65x54x26mm	2f-d11mm
	F0512-I	NO. MB109011 - MB176162 - MB176860 - MB297147 - MB297190		F0694-I	NO. MB176870 - MB297370
	FOLE DO SEMI-EIXO EXTERNO MITSUBISHI LANCER (1.2-1.4) - FIORE (1.2-1.4)-MIRAGE 1.3 - LANCER 1.3 - FIORE 1.3 - CHAMP			FOLE DOS SEMI-EIXOS ESQUERDO E DIREITO MITSUBISHI LANCER FIORE (10-83 A 12-85)	
	d83x85mm	1f-d72mm 1f-d22mm		d90x86mm	1f-d23mm 1f-d79mm
	F0694-I	NO. MB176870 - MB297370		F0706-I	NO. MB109012 - MB109184
	FOLE DO SEMI-EIXO DIREITO MITSUBISHI MIRAGE 1.4 (2-82 A 9-83) - 1.6E (APÓS 10-87) - LANCER 1.6E (6-88 A 9-89)			FOLE DO SEMI-EIXO INTERNO MITSUBISHI CHAMP - MIRAGE (1.2-1.4-1.6) - LANCER (1.2-1.4-1.6) - FIORE(1.2-1.4-1.6)	
	d90x86mm	1f-d23mm 1f-d79mm		d89x92mm	1f-d76mm 1f-d22mm
	F1234-I	NO. MB297379 - 23222-GA153 - MB620053 - 23222-GA150 - 23222-GA151		F1240-I	NO. MB526516
	FOLE DO SEMI-EIXO LADO CAIXA E RODA MITSUBISHI MIRAGE			FOLE DA TRANSMISSÃO LADO DA RODA MITSUBISHI MIRAGE 1.6 E - C53A MT (APÓS 1987) - LANCER 1.6 E C63A - MT88	
	88x90mm	1f-d85mm 1f-d24mm		d85x95mm	1f-d76mm 1f-d21mm

	<p>F1253-I NO. MB176871 - MB620061</p> <p>FOLE DO SEMI-EIXO LADO RODA</p> <p>MITSUBISHI LANCER - MIRAGE</p> <p>d96x80mm 1f-d78mm 1f-d18mm</p>		<p>F1259-I NO. MB297340 - MB297339</p> <p>FOLE DA TRANSMISSÃO LADO DA CAIXA</p> <p>MITSUBISHI MIRAGE 1.3 - C11A - LANCER 1.3 - 1.8 - FIORE 1.3 (APÓS 1980) - MIRAGE 1.8 (APÓS 1985)</p> <p>d84x88mm 1f-d74mm 1f-d20mm</p>
	<p>F1260-I NO. MB175851 - MB176164</p> <p>FOLE DA TRANSMISSÃO JUNTO À CAIXA</p> <p>MITSUBISHI LANCER (1) 1.4 (1979 A 1983) - LANCER (2) 1.2 (1983 A 1984) - LANCER (3) 1.2 (1984 A 1988)</p> <p>d92x91mm 1f-d81mm 1f-d22mm</p>		<p>F1328-I NO. MB526006 - MB936162 - MB936667</p> <p>FOLE DA TRANSMISSÃO JUNTO À CAIXA</p> <p>MITSUBISHI LANCER (5) 1.6i 16V - 1.6i 16V 4WD (1992 A 1995)</p> <p>d75x85mm 1f-d64mm 1f-d18mm</p>
	<p>F1794-I NO. MB350581 - MB501711 - MR369122</p> <p>FOLE DA DIREÇÃO LADO DIREITO E ESQUERDO</p> <p>MITSUBISHI LANCER 1.2 - 1.3 - 1.5 - 1.6 - 1.8 - 2.0 DIESEL</p> <p>d65x190mm 1f-d45mm 1f-d10mm</p>		<p>KF3410 NO. MB176860 - MB297147 - MB297184 - MB297190 - MB297351 - MB393129 - MB526057</p> <p>FOLE DO LADO DA RODA</p> <p>MITSUBISHI LANCER - FIORE 1.5 - MIRAGE 1.3 - 1.5</p> <p>d89x87mm 1f-d73mm 1f-d21mm</p>
	<p>KF3493 NO. MB297379 - MB297569</p> <p>KIT DE FOLE DO CARDAN LADO DA RODA</p> <p>MITSUBISHI LANCER 1.3i 12V (09-90 A 03-93) - 1.5i (08-88 A 03-91) - 1.5i WAGON (08-88 A 03-91) - 1.6i 16V (04-93 A 02-96) - 1.6i 16V WAGON (08-92 A 08-97) - 1.8D - WAGON (08-88 A 03-93) - 2.0D - 2.0D COMBI (08-92 A 01-96)</p> <p>NULL NULL</p>		<p>KF3494 NO. MB6200 - MB936182</p> <p>KIT DE FOLE DO CARDAN LADO DA RODA</p> <p>MITSUBISHI LANCER 1.3 (08-88 A 03-91) - 1.3i 12V (04-93 A 01-96) - 1.5 - 1.5 WAGON (08-86 A 08-88) - 1.5i 12V WAGON (09-90 A 03-93) - 1.8 WAGON (02-87 A 04-89)</p> <p>NULL NULL</p>
	<p>L3056 NO. MB001766</p> <p>CASQUILHO DA BARRA DE TORÇÃO</p> <p>MITSUBISHI LANCER</p> <p>d50x29mm 1f-d20mm</p>		<p>M6027 NO. MB156180 - MB687001</p> <p>JUNTA DE ESCAPE</p> <p>MITSUBISHI LANCER (1984 A 1996)</p> <p>112x80mm 1f-d54mm</p>
	<p>M6046 NO. MB313111 - MB687012</p> <p>JUNTA DE ESCAPE</p> <p>MITSUBISHI LANCER (APÓS 1988)</p> <p>97x67mm 1f-d51mm</p>		<p>RT80044 NO. MB058593 - MB238161 - MB058509 - MB238162 - MB238164 - MB238166 - MB587740 - MB857559 - MB857561</p> <p>TUBO DE TRAVÃO FRENTE LH-RH</p> <p>MITSUBISHI LANCER (MOD III SW - C1 V - C3 V) TT (09-1985 A 06-1992) - LANCER (MOD II - A 17 E MOD III - C1 A - C6 A) TT (03-1983 A 09-1986) - LANCER (MOD IV - C6 A - C7 A) TT (04-1988 A 12-1993)</p> <p>316mm FB41 - FB41</p>
	<p>RT80045 NO. MB239151</p> <p>TUBO DE TRAVÃO FRENTE LH-RH</p> <p>MITSUBISHI LANCER (MOD III SW - C1 V - C3 V) TT (09-1985 A 06-1992) - LANCER (MOD II - A 17 E MOD III - C1 A - C6 A) TT (03-1983 A 09-1986) - LANCER (MOD IV - C6 A - C7 A) TT (04-1988 A 12-1993)</p> <p>212mm FB48 - MC50</p>		<p>RT80046 NO. MB238160 - MR129777 - MB058592 - MB587741</p> <p>TUBO DE TRAVÃO TRÁS LH-RH</p> <p>MITSUBISHI LANCER (MOD III SW - C1 V - C3 V) TT (09-1985 A 06-1992)</p> <p>264mm FB41 - FB41</p>
	<p>RT80047 NO. MB238163 - MB587743 - MB857555 - MB857570 - MR129775</p> <p>TUBO DE TRAVÃO TRÁS LH-RH</p> <p>MITSUBISHI LANCER TT (MOD IV - C6A - C7 A) (04-1988 A 12-1993)</p> <p>259mm FB41 - FB41</p>		<p>RT80369 NO. MB857567 - MR129787</p> <p>TUBO DE TRAVÃO DE TRÁS LH-RH</p> <p>MITSUBISHI LANCER V (CB/D_A) 1.3 (CB1A) (06.92 A 12.96) 75cv 1299cc três volumes - MITSUBISHI LANCER V (CB/D_A) 1.6 (CB4A) (02.94 A 12.96) 90cv 1597cc três volumes - MITSUBISHI LANCER V (CB/D_A) 1.6 16V (CB4A) (06.92 A 12.96) 113cv 1597cc três volumes - MITSUBISHI LANCER V (CB/D_A) 2.0 Diesel (CB8A) (06.92 A 12.96) 68cv 1998cc três volumes - MITSUBISHI LANCER V Station Wagon (CB_W - CD_W) 1.6 16V (CB4W) (12.92 A 10.03) 113cv 1597cc Combi...etc.</p> <p>235mm FB51 - FB51</p>

	<p>RT80369 NO. MB857567 - MR129787</p> <p>TUBO DE TRAVÃO DE TRÁS LH-RH</p> <p>MITSUBISHI LANCER VI (CJ-CP_) 1.3 12V (CK1A) (12.95 A 08.03) 75cv 1299cc três volumes</p> <p>Componenti / Components</p>		<p>RT80389 NO. MR129882</p> <p>TUBO DE TRAVÃO DA FRENTE LH-RH</p> <p>MITSUBISHI LANCER VI (CJ-CP_) 1.3 12V (CK1A) (12.95 A 08.03) 75cv 1299cc três volumes</p> <p>Componenti / Components</p>
	<p>RT80391 NO. MB857426 - MR129799</p> <p>TUBO DE TRAVÃO DA FRENTE LH-RH</p> <p>MITSUBISHI LANCER V (CB/D_A) 1.3 (CB1A) (06.92 A 12.96) 75cv 1299cc três volumes - MITSUBISHI LANCER V (CB/D_A) 1.6 (CB4A) (02.94 A 12.96) 90cv 1597cc três volumes - MITSUBISHI LANCER V (CB/D_A) 1.6 16V (CB4A) (06.92 A 12.96) 113cv 1597cc três volumes - MITSUBISHI LANCER V (CB/D_A) 2.0 Diesel (CB8A) (06.92 A 12.96) 68cv 1998cc três volumes - MITSUBISHI LANCER V Station Wagon (CB_W - CD_W) 1.6 16V (CB4W) (12.92 A 10.03) 113cv 1597cc Combi...etc.</p> <p>Componenti / Components</p>		<p>RT80925 NO. MR493450</p> <p>TUBO DE TRAVÃO DE TRÁS LH-RH</p> <p>MITSUBISHI LANCER três volumes (CS_A - CT0) 1.3 (APÓS 09.03) 82cv 1299cc três volumes - MITSUBISHI LANCER três volumes (CS_A - CT0) 1.6 (CS3A) (APÓS 09.03) 98cv 1584cc três volumes - MITSUBISHI LANCER três volumes (CS_A - CT0) 2.0 (CS9A) (APÓS 12.03) 135cv 1997cc três volumes</p> <p>Componenti / Components</p>
	<p>S1320-D NO. MB808910</p> <p>SILENT-BLOC INFERIOR DIREITO DO BRAÇO DA SUSPENSÃO FRENTE</p> <p>MITSUBISHI LANCER E-CAR CB1 - CB2</p>		<p>S1320-E NO. MB808909</p> <p>SILENT-BLOC INFERIOR ESQUERDO DO BRAÇO DA SUSPENSÃO FRENTE</p> <p>MITSUBISHI LANCER E-CAR CB1 - CB2</p>
	<p>S1321 NO. MB130983</p> <p>SILENT-BLOC INFERIOR DO BRAÇO DA SUSPENSÃO DA FRENTE</p> <p>MITSUBISHI LANCER E - CB2</p>		<p>Z80775 NO. MB253964</p> <p>Mola de fixação</p> <p>MITSUBISHI LANCER</p>
	<p>Z80776 NO. MR288150</p> <p>Mola de fixação</p> <p>MITSUBISHI LANCER</p>		<p>Z80781 NO. MB344789</p> <p>Mola de painel</p> <p>MITSUBISHI LANCER</p>
	<p>Z80833 NO. 30873201 - MB-814152</p> <p>Mola</p> <p>MITSUBISHI MIRAGE</p>		<p>Z80833 NO. 30873201 - MB-814152</p> <p>Mola</p> <p>MITSUBISHI LANCER (De 1991 A 2000)</p>

MITSUBISHI MIGHTY MAX CYCLONE











	<p>F4086 NO. MB446706</p> <p>FOLE DA ALAVANCA DE VELOCIDADES</p> <p>MITSUBISHI MIGHTY MAX (1993 A 1996) - MIRAGE - CYCLONE</p>		
	<p>130x135x140mm</p> <p>1f-d12mm</p>		

	F0066-I	NO. MB290156		F1328-I	NO. MB526006 - MB936162 - MB936667
	FOLE DO SEMI-EIXO LADO DA RODA (LADO INTERNO NO MINICAB)(F1007) MITSUBISHI MINICAB			FOLE DA TRANSMISSÃO JUNTO À CAIXA MITSUBISHI MINI CAB 550 - 660 (1984 A 1990)	
d88x84mm		1f-d64mm 1f-d19mm	d75x85mm		1f-d64mm 1f-d18mm

MITSUBISHI PAJERO

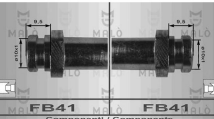
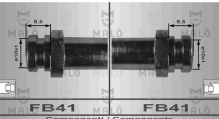
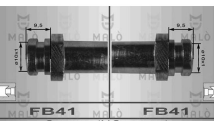
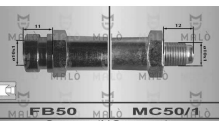
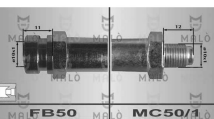
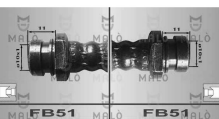
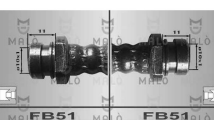
	A1121	NO. MB007023 - MB437578 - MB436578T - MD070023		A1160	NO. MB581845-260676 - MB-581845 - MB-260676 - MR353470
	SUPORTE DA FRENTE DO MOTOR DIREITO E ESQUERDO MITSUBISHI PAJERO L144G			APOIO AUXILIAR DA CAIXA TRASEIRO MITSUBISHI PAJERO L144G - L044G - V24W	
115x115x54mm		1p-d10-18mm	87x62x48mm		1f-d10mm 1p-d10-20mm
	A1545	NO. MB109685		A1584	NO. MB672325
	APOIO BATENTE DO BRAÇO DA SUSPENSÃO DA FRENTE MITSUBISHI PAJERO			APOIO DA SUSPENSÃO DA FRENTE PARTE SUPERIOR MITSUBISHI PAJERO	
d76x52mm		1p-d10-17mm	85x43x35mm		NULL
	A1601	NO. SEPARADOR DAS MOLAS 71X50X4 - 5 PINO 28X13 - 50X7		A1711	NO. MB260676
	MITSUBISHI PAJERO			APOIO AUXILIAR DA CAIXA MITSUBISHI PAJERO (1992) L047	
70x49x4mm		Pino 28x13x8mm	80x53x35mm		1f-d25mm 1p-d10-16mm
	A1764	NO. MB-691280		A1769	NO. MB691280 - MR133078 - MR133079
	APOIO DO MOTOR PARTE DE TRÁS CAIXA VELOCIDADES MITSUBISHI PAJERO			APOIO DO MOTOR PARTE DE TRÁS CAIXA VELOCIDADES MITSUBISHI PAJERO LS (APÓS 1992) - RS (APÓS 1992) - SR (APÓS 1992)	
170x160x105mm		4f-d11mm	170x160x160mm		4f-d11mm
	E0045	NO. MB149083		E0244	NO. MB267876
	ESTICADOR DE ESCAPE MITSUBISHI PAJERO (APÓS 82)			ESTICADOR DA BARRA ESTABILIZADORA DA FRENTE LADO DIREITO MITSUBISHI PAJERO SPORT (K90) 2.5 TD (APÓS 1998) - PAJERO III (V60) 3.2 DI-D (APÓS 2000) - (V60) 3.5 V6 GDI (APÓS 2000)	
100x40x27mm		1f-d16mm	120x40x27mm		1f-d12.6mm 1p-d12x28mm
	E0245	NO. MB267877 - MR374521 - 4056A106		E0248	NO. MB598097
	ESTICADOR DA BARRA ESTABILIZADORA DA FRENTE LADO ESQUERDO MITSUBISHI PAJERO V6 (1986 A 1990)			ESTICADOR DA BARRA ESTABILIZADORA DA FRENTE MITSUBISHI PAJERO I (L044G - L049G) 2.5 TD (11-1989 A 12-1991) - PAJERO I (L141G - L146G) 3.0 V6 (11-1988 A 11-1990)	
120x40x27mm		1f-d12.6mm 1p-d12x28mm	71x32mm		1p-d10mm



	<p>E1025 NO. MB431175</p> <p>ESTICADOR DE ESCAPE</p> <p>MITSUBISHI PAJERO (1990 A 1996)</p> <p>75x70x20mm 3f-d10mm</p>		<p>E1088 NO. MB-185618</p> <p>ESTICADOR DO ESCAPE</p> <p>MITSUBISHI PAJERO</p> <p>76x74x30mm 3f-d10mm</p>
	<p>F1252-I NO. MB160658 - MB297536</p> <p>FOLE JUNTO À CAIXA</p> <p>MITSUBISHI PAJERO 2.0 - 2.0 - 3.0 (APÓS 4-1982) (LADO DIREITO E ESQUERDO)</p> <p>d102x95mm 1f-d80mm 1f-d25mm</p>		<p>F1257-I NO. MB526148 - MB526274</p> <p>FOLE DE TRANSMISSÃO LADO DA RODA</p> <p>MITSUBISHI PAJERO 2.0 - 2.3 - 2.5 (APÓS 1982)</p> <p>d95x91mm 1f-d80mm 1f-d26mm</p>
	<p>F1328-I NO. MB526006 - MB936162 - MB936667</p> <p>FOLE DA TRANSMISSÃO JUNTO À CAIXA</p> <p>MITSUBISHI PAJERO 660i 4WD MINI (APÓS 1996)</p> <p>d75x85mm 1f-d64mm 1f-d18mm</p>		<p>KF3416-T NO. MN156832 - MR232240</p> <p>KIT DE FOLE LADO DA RODA</p> <p>MITSUBISHI PAJERO 3000I V6 E WAGON - 2500TD I.C - 2800TD I.C E WAGON - GLS - GLX WAGON - 3200 TD TDI GL - GLS - GLX - 3500I V6 24V GLS - GLX - GDI</p> <p>d97x123mm 1f-d90mm 1f-d27mm</p>
	<p>KF3480 NO. MB526148 - MB526274 - MB526275 - MB896069</p> <p>KIT DE FOLE DO CARDAN JUNTO À RODA</p> <p>MITSUBISHI PAJERO I 2.5 TD 95CV 95CV (11-1989 A 11-1990) - PAJERO I VEICULO TODO TERRENO ABERTO 2.3 TD 84CV (12-1982 A 04-1986) - 2.5 TD 95CV (11-1989 A 11-1990)</p> <p>d93x98mm 1f-d26mm 1f-d83mm</p>		<p>KM0406 NO. MB110494</p> <p>KIT DE BRINCOS DAS MOLAS TRÁS (PARTE DE TRÁS - COMPOSTO POR 2 L3053 MAIS 2 L3059)</p> <p>MITSUBISHI PAJERO</p> <p>120x120x40mm d28mm</p>
	<p>KM0420 NO. MB111200</p> <p>KIT DE BRINCOS DAS MOLAS DE TRÁS PARTE DA FRENTE (COMPOSTO POR 2 CASQUILHOS L 3021)</p> <p>MITSUBISHI PAJERO</p> <p>76x53x88mm d-32mm 1p-d11.8-23mm</p>		<p>KM0430 NO. SK43037 - MB110494 - MB110496</p> <p>KIT DE BRINCOS DAS MOLAS DE TRÁS PARTE DE TRÁS (CAVILHAS LUBRIFICAVEIS)</p> <p>MITSUBISHI PAJERO I (L04_G - L14_G) 3.0 V6 (L141G - L146G) Ano fabric. a partir de: (01.89) (11.88 - 11.90) 141cv 2972cc Veículo todo-terreno fechado - MITSUBISHI PAJERO I (L04_G - L14_G) 2.5 TD (L044G - L049G) (01.90 - 12.91) 87cv 2477cc Veículo todo-terreno</p> <p>150x120x43mm d16mm 2p-d12x25mm</p>
	<p>KM0430 NO. SK43037 - MB110494 - MB110496</p> <p>KIT DE BRINCOS DAS MOLAS DE TRÁS PARTE DE TRÁS (CAVILHAS LUBRIFICAVEIS)</p> <p>MITSUBISHI PAJERO II (V3_W - V2_W - V4_W) 2.4 (V21W - V21C) (04.91 - 10.99) 112cv 2351cc Veículo todo-terreno fechado - MITSUBISHI PAJERO II Canvas Top (V2_W - V4_W) 2.4 (V41W - V21W - V21C) (04.91 - 04.00) 112cv 2351cc Veículo todo-terreno aberto</p> <p>150x120x43mm d16mm 2p-d12x25mm</p>		<p>L3021 NO. MB111203</p> <p>CASQUILHO DAS MOLAS</p> <p>MITSUBISHI PAJERO</p> <p>d38x45mm d32mm 1f-d18mm</p>
	<p>L3053 NO. MB111071 - MB-584531 - MT-362413</p> <p>CASQUILHO DAS MOLAS TRÁS PARTE DA FRENTE</p> <p>MITSUBISHI PAJERO</p> <p>d35x55mm d28mm 1f-d16mm</p>		<p>L3059 NO. MB110070 - MT-362394 - MB-584530</p> <p>CASQUILHO DAS MOLAS TRÁS PARTE DE TRÁS</p> <p>MITSUBISHI PAJERO</p> <p>d35x44mm d27mm 1f-d15mm</p>
	<p>L3076 NO. MB809388</p> <p>CASQUILHO DA SUSPENSÃO DE TRÁS</p> <p>MITSUBISHI PAJERO</p> <p>d60x27mm 1f-d24mm</p>		<p>L3077 NO. MB673524</p> <p>CASQUILHO DA DIREÇÃO</p> <p>MITSUBISHI PAJERO</p> <p>d33x21mm d25mm 1f-d19mm</p>

	<p>L3078 NO. MB664448</p> <p>CASQUILHO DA SUSPENSÃO DE TRÁS</p> <p>MITSUBISHI PAJERO</p> <p>d61x19mm 1f-d40mm</p>		<p>L3098 NO. MB-584146 - MB-584166</p> <p>CASQUILHO DA BARRA ESTABILIZADORA</p> <p>MITSUBISHI PAJERO L044 - L200 GALLOPER</p> <p>58x35mm 1f-d23 - 8mm</p>
	<p>M6027 NO. MB156180 - MB687001</p> <p>JUNTA DE ESCAPE</p> <p>MITSUBISHI PAJERO (1986 A 1990)</p> <p>112x80mm 1f-d54mm</p>		<p>M6046 NO. MB313111 - MB687012</p> <p>JUNTA DE ESCAPE</p> <p>MITSUBISHI PAJERO (1988 A 1996)</p> <p>97x67mm 1f-d51mm</p>
	<p>R8030 NO. MB660693</p> <p>TUBO INFERIOR DO RADIADOR</p> <p>MITSUBISHI PAJERO NA - NB - NC - ND - NE - NF - 2.3 - 2.5 DIESEL (DE 1983 ATÉ 1988)</p> <p>B290-d32/32mm 80-160-60-110mm</p>		<p>R8114 NO. MB660521 - MB222484</p> <p>TUBO SUPERIOR DO RADIADOR</p> <p>MITSUBISHI PAJERO</p> <p>B285-d34/34mm 150-150-90mm</p>
	<p>RT80049 NO. MB857552 - MB238425</p> <p>TUBO DE TRAVÃO FRENTE LH-RH</p> <p>MITSUBISHI PAJERO 3.0 V6 (11-1988 A 11-1990)</p> <p>218mm FB41 - FB41</p>		<p>RT80051 NO. MB316287 - MB857553 - MR129773</p> <p>TUBO DE TRAVÃO FRENTE LH-RH</p> <p>MITSUBISHI PAJERO 2.3 TD - 2.5 - 2.5 TD (12-1982 A 11-1990)</p> <p>237mm FB41 - FB41</p>
	<p>RT80052 NO. MB150761 - MB699985 - MB238165 - MR129723</p> <p>TUBO DE TRAVÃO TRÁS LH-RH</p> <p>MITSUBISHI PAJERO 2.3 TD - 2.5 - 2.5 TD (12-1982 A 11-1990)</p> <p>364mm FB41 - FB41</p>		<p>RT80343 NO. MB857531 - MR129749</p> <p>TUBO DE TRAVÃO FRENTE LH-RH</p> <p>MITSUBISHI PAJERO III (1992 A 1999)</p> <p>250mm FB50 - MC50/1</p>
	<p>RT80350 NO. MB857535 - MR129753</p> <p>TUBO DE TRAVÃO FRENTE E TRÁS LH-RH</p> <p>MITSUBISHI PAJERO I 2.3 TD (L043G - L048G) (12-1982 A 04-1986) - 2.5 TD (044G - L049G) (APÓS 05-1986 A 12-1991) - 2.6 (L042G - L047G) (01-1983 A 1983) - 3.0 V6 (L141G - L146G) (11-1988 A 11-1990)</p> <p>195mm FB50 - MC50/1</p>		<p>RT80374 NO. MR129770 - MB857550 - MN116498</p> <p>TUBO DE TRAVÃO FRENTE LH-RH(EXTERNO)</p> <p>MITSUBISHI PAJERO II (12-1990 A 04-2000)</p> <p>185 mm FB51 - FB51</p>
	<p>RT80394 NO. MR249392</p> <p>TUBO DE TRAVÃO TRÁS LH-RH</p> <p>MITSUBISHI PAJERO II TT (V3-W) (07-1996 A 04-2000)</p> <p>425mm FB51 - FB51</p>		<p>RT80580 NO. 5562250</p> <p>TUBO DE TRAVÃO TRÁS RH</p> <p>MITSUBISHI PAJERO II 1.8 Gdi (06-1998 A 04-2000) - 2.4 (04-1991 A 04-2000) - 2.5 TD (12-1990 A 04-2000) - 2.5 TD 4X4 (12-1990 A 04-2000) - 2.8 TD (06-1994 A 04-2000) - 3.0 V6 (12-1990 A 12-1995) - 3.0 V6 24V (06-1994 A 04-2000) - 3.0 V6 4X4 (12-1990 A</p> <p>630mm NULL</p>
	<p>RT80682 NO. MR407251</p> <p>TUBO DE TRAVÃO DE TRÁS LH-RH</p> <p>MITSUBISHI PAJERO III (V7_W - V6_W) 3.2 Di-D (04.00 A 12.06) 160cv 3200cc Veículo todo terreno fechado - MITSUBISHI PAJERO III (V7_W - V6_W) 3.2 Di-D (04.00 A 10.01) 165cv 3200cc Veículo todo terreno fechado - MITSUBISHI PAJERO III Veículo todo terreno aberto (V6_W - V7_W) 3.2 Di-D (V68W - V78W) (04.00 A 12.06) 165cv 3200cc Veículo todo terreno aberto -</p> <p>555mm FB98 - OR105</p>		<p>S1285 NO. MB109684</p> <p>SILENT-BLOC BRAÇO DA SUSPENSÃO FRENTE</p> <p>MITSUBISHI PAGERO K77</p> <p>d42x64mm 1f-d14mm</p>

	<p>S1461 NO. MB631492</p> <p>SILENT BLOC DO BRAÇO DA SUSPENSÃO</p> <p>MITSUBISHI PAJERO (APÓS 1992)</p> <p>d65x61mm c40mm 1f-d17mm</p>		<p>T1080F24 NO. MB573784</p> <p>BATENTE DA BARRA ESTABILIZADORA</p> <p>MITSUBISHI PAJERO</p> <p>40x46x45mm 1f-d24mm</p>
	<p>T1080F27 NO. MB573783</p> <p>BATENTE DA BARRA ESTABILIZADORA</p> <p>MITSUBISHI PAJERO</p> <p>40x46x45mm 1f-d27mm</p>		<p>T1087 NO. MB338596</p> <p>BATENTE DA BARRA ESTABILIZADORA DE TRÁS</p> <p>MITSUBISHI PAJERO V 44W</p> <p>43x41x37mm 1f-d27mm</p>
	<p>T1103 NO. MB-176442</p> <p>BATENTE DA BARRA ESTABILIZADORA</p> <p>MITSUBISHI PAJERO L044 - L200 GALLOPER</p> <p>39x41x41mm 1f-d23mm</p>		<p>T1105 NO. MR-150094</p> <p>BATENTE DA BARRA ESTABILIZADORA</p> <p>MITSUBISHI PAJERO V44 - L200 GALLOPER</p> <p>45x58x54mm 1f-d27mm</p>
	<p>T1120 NO. MB109219</p> <p>BATENTE DA BARRA ESTABILIZADORA DE TRÁS</p> <p>MITSUBISHI PAGERO II (V3 W - V2 W - V4 W) - 2.5 TD 4X4 (12-1990 A 04-2000) - VEÍCULO TODO TERRENO ABERTO (V2 W - ..(12-1990 A 04-2000)</p> <p>38x36x43mm 1f-d19mm 30x38mm</p>		<p>T1140 NO. 4056A121 - MR374520 - MR554271</p> <p>BATENTE DA BARRA ESTABILIZADORA DA FRENTE</p> <p>MITSUBISHI PAJERO III (V7_W - V6_W) 3.5 (04.00 A 01.07) 203CV 3497CC - MITSUBISHI PAJERO III (V7_W - V6_W) 2.5 TDi (09.01 A 12.06) 115CV 2477CC - MITSUBISHI PAJERO III (V7_W - V6_W) 3.2 Di-D (04.00 A 12.06) 160CV 3200CC - MITSUBISHI PAJERO III (V7_W - V6_W) 3</p> <p>48x57x55mm 36x43x46mm 1f-d29mm</p>
	<p>W5096 NO. ME202491</p> <p>POLIE DA CAMBOTA (1+2 PISTAS)</p> <p>MITSUBISHI PAJERO 2800 (4M40) - MITSUBISHI PAJERO II (V2_W - V3_W - V4_W)-2.8 TD 125CV 2835CC (V46W) (06-1994 A 10-1999)</p> <p>d154mm d36mm</p>		<p>W5114 NO. MD374223</p> <p>POLIE DA CAMBOTA (1+1 PISTAS)</p> <p>MITSUBISHI PAJERO II(V3 W V2W V4W) 2.5 TD 4WD (12-1990 A 10-1999) 99CV 2477CC - MITSUBISHI PAJERO SPORT (K90) 2.5 TD (APÓS 11-1988) 99CV 2477CC - MITSUBISHI PAJERO SPORT (K90) 2.5 TD (07-2002) 115CV 2477CC - MITSUBISHI PAJERO SAPORT (K90) 2.5 TD (APÓS 08-</p> <p>d173mm d35mm</p>
	<p>Z80776 NO. MR288150</p> <p>Mola de fixação</p> <p>MITSUBISHI PAJERO</p> <p>d15x24mm 1p-d6-11.5mm</p>		<p>Z80778 NO. 6385401A00 - 91545SE0003 - MR328954</p> <p>Mola de fixação</p> <p>MITSUBISHI PAJERO</p> <p>d20x26mm 1p-d8-15mm</p>

MITSUBISHI SENTRA

	<p>KF1635 NO.</p> <p>KIT DE FOLE DO CARDAN LADO DA RODA</p> <p>MITSUBISHI SENTRA 4WD APÓS 10-87 - D DIESEL COUPÉ 01-86 A 12-87</p> <p>d97x96mm 1f-d86mm 1f-d22mm</p>		
---	---	--	--

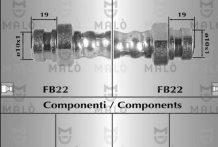
	<p>E1042 NO. MB514063 - MB313278 - MR281858 - MR431635</p> <p>ESTICADOR DE ESCAPE</p> <p>MITSUBISHI SPACE RUNNER (APÓS 1991)</p>		<p>E1052 NO. MB376954 - MB906128</p> <p>ESTICADOR DE ESCAPE</p> <p>MITSUBISHI SPACE RUNNER (APÓS 1991)</p>
	<p>F1254-I NO. MB526894 - MB937307 - MR446048 - MB526356</p> <p>FOLE DA TRANSMISSÃO JUNTO À CAIXA</p> <p>MITSUBISHI SPACE RUNNER 2.0 TD GLX - 2.0i (1991 A 1999)</p>		<p>KF3423-T NO. MR222684 - MR336590 - MR336591</p> <p>KIT DE FOLE DO CARDAN JUNTO À RODA</p> <p>MITSUBISHI SPACE RUNNER (APÓS 1999) 2.4GDI</p>
	<p>M6027 NO. MB156180 - MB687001</p> <p>JUNTA DE ESCAPE</p> <p>MITSUBISHI SPACE RUNNER (APÓS 1991)</p>		<p>RT80045 NO. MB239151</p> <p>TUBO DE TRAVÃO FRENTE LH-RH</p> <p>MITSUBISHI SPACE RUNNER 1.8 - 1.8 4X4 - 2.0 TD</p>
	<p>RT80046 NO. MB238160 - MR129777 - MB058592 - MB587741</p> <p>TUBO DE TRAVÃO TRÁS LH-RH</p> <p>MITSUBISHI SPACE RUNNER 1.8 - 1.8 4X4 - 2.0 TD</p>		<p>RT80569 NO. MR289286</p> <p>TUBO DE TRAVÃO DE TRÁS LH-RH</p> <p>MITSUBISHI SPACE RUNNER (N6_W) 2.0 (N63W) (08.99 A 08.02) 136cv 1997cc Veículo multiuso - MITSUBISHI SPACE RUNNER (N6_W) 2.4 GDI (08.99 A 01.03) 150cv 2351cc Veículo multiuso</p>
	<p>Z80775 NO. MB253964</p> <p>Mola de fixação</p> <p>MITSUBISHI SPACE RUNNER</p>		<p>Z80778 NO. 6385401A00 - 91545SE0003 - MR328954</p> <p>Mola de fixação</p> <p>MITSUBISHI SPACE RUNNER</p>
	<p>Z80781 NO. MB344789</p> <p>Mola de painel</p> <p>MITSUBISHI SPACE RUNNER</p>		

MITSUBISHI SPACE STAR

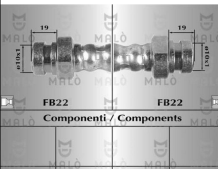
	<p>F1842-I NO. MR911156 - MR911157</p> <p>FOLE DA TRANSMISSÃO JUNTO À CAIXA</p> <p>MITSUBISHI SPACE STAR 1.3i 16V - 1.6i 16V (APÓS 98)</p>		<p>RT80414 NO. MB950626 - MR910915</p> <p>TUBO DE TRAVÃO DE TRÁS LH-RH</p> <p>MITSUBISHI SPACE STAR Veículo multiuso (DG_A) 1.3 16V (DG1A) (12.98 A 12.04) 83cv 1299cc Veículo multiuso - MITSUBISHI SPACE STAR Veículo multiuso (DG_A) 1.3 16V (DG1A) (06.98 A 12.04) 86cv 1299cc Veículo multiuso - MITSUBISHI SPACE STAR Veículo multiuso (DG_A) 1.8 GDI (DG5A) (06.98 A 12.04) 118cv 1834cc Veículo multiuso MITSUBISHI SPACE STAR Veículo multiuso (DG_A) 1.8 GDI (DG5A) (06.98 A 12.04) 122cv 1834cc Veículo multiuso</p>
--	---	--	--

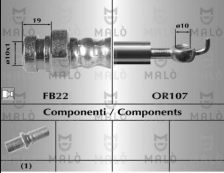
	RT80562	NO. MM862413		
	TUBO DE TRAVÃO DE TRÁS LH-RH MITSUBISHI SPACE STAR Veículo multiuso (DG_A) 1.6 16V (DG3A) (01.01 A 12.04) 98cv 1584cc Veículo multiuso - MITSUBISHI SPACE STAR Veículo multiuso (DG_A) 1.8 MPI (10.02 A 12.04) 112cv 1834cc Veículo multiuso - MITSUBISHI SPACE STAR Veículo multiuso (DG_A) 1.9 DI-D (DG4A) (02.01 A 12.04) 102cv 1870cc Veículo multiuso - MITSUBISHI SPACE STAR Veículo multiuso (DG_A) 1.9 DI-D (10.02 A 12.04) 115cv 1870cc Veículo multiuso 430mm		FB22 - OR107	

MITSUBISHI SPACE WAGON

	A1803	NO. MB505495		A1862	NO. MB691490
	APOIO DA TRANSMISSÃO MITSUBISHI SPACE WAGON (N3 W N4 W) 2.0 4WD (N43W) (10-1992 A 10-1998) 133CV 1997CC - MITSUBISHI SPACE RUNNER (N1 W N2 W) 1.8 4WD (N21W) (06-1996 A 08-1999) 116CV 1834CC - MITSUBISHI SPACE RUNNER (N1 W N2 W) 1.8 4WD (N21W) (06-1991 A 08-1999) 122CV 1834CC 210x120x65mm 1f-d30mm			APOIO DO MOTOR LADO ESQUERDO MITSUBISHI SPACE WAGON (N3 W - N4 W) 1.8 (N31W) (10.91 - 10.98) 122cv 1834cc Veículo multiuso - MITSUBISHI SPACE WAGON (N3 W - N4 W) 2.0 (N33W) (10.92 - 10.98) 133cv 1997cc Veículo multiuso 140x85x42x56mm 2f-12x15mm 1f-d12mm	
	E0018	NO. MB376954		E1042	NO. MB514063 - MB313278 - MR281858 - MR431635
	ESTICADOR DE ESCAPE MITSUBISHI SPACE WAGON (APÓS 88) 68x54x25mm NULL			ESTICADOR DE ESCAPE MITSUBISHI SPACE WAGON (APÓS 1991) - L300 (APÓS 1986) NULL NULL	
	E1043	NO. MB059936 - MB059522 - MB059935 - MB059937 - MB906124 - 28658-21000		E1052	NO. MB376954 - MB906128
	ESTICADOR DE ESCAPE MITSUBISHI SPACE WAGON (1984 A 1991) NULL NULL			ESTICADOR DE ESCAPE MITSUBISHI SPACE WAGON (1988 A 1996) 65x54x26mm 2f-d11mm	
	KF2271-T	NO. MR911162		KF3416-T	NO. MN156832 - MR232240
	KIT DE FOLE DO CARDAN JUNTO À RODA MITSUBISHI SPACE STAR 1.8 GDi - 1.8 GDi 16V (APÓS 1998) d105x125mm 1f-d83mm 1f-d25mm			KIT DE FOLE LADO DA RODA MITSUBISHI SPACE WAGON 2000I GLX CAT. - 2000TD GLX d97x123mm 1f-d90mm 1f-d27mm	
	KF3423-T	NO. MR222684 - MR336590 - MR336591		M6027	NO. MB156180 - MB687001
	KIT DE FOLE DO CARDAN JUNTO À RODA MITSUBISHI SPACE WAGON (APÓS 1998) 2.4 GDI d92x130mm 1f-d82mm 1f-d26mm			JUNTA DE ESCAPE MITSUBISHI SPACE WAGON (1985 A 1996) 112x80mm 1f-d54mm	
	RT80044	NO. MB058593 - MB238161 - MB058509 - MB238162 - MB238164 - MB238166 - MB587740 - MB857559 - MB857561		RT80045	NO. MB239151
	TUBO DE TRAVÃO FRENTE LH-RH MITSUBISHI SPACE WAGON (DO W) TT (06-1986 A 04-1991) 316mm FB41 - FB41			TUBO DE TRAVÃO FRENTE LH-RH MITSUBISHI SPACE WAGON (DO W) TT EXCEPTO 4X4 (06-1986 A 04-1991) - SPACE WAGON (N3 - N4) TT (05-1991 A 08-1999) 212mm FB48 - MC50	

	RT80046 NO. MB238160 - MR129777 - MB058592 - MB587741 TUBO DE TRAVÃO TRÁS LH-RH MITSUBISHI SPACE WAGON (DO W) TT EXCEPTO 4X4 (06-1986 A 04-1991) - SPACE WAGON (N3 - N4) TT (05-1991 A 08-1999)		RT80051 NO. MB316287 - MB857553 - MR129773 TUBO DE TRAVÃO FRENTE LH-RH MITSUBISHI SPACE WAGON (DO W) TT E 4X4 (06-1986 A 04-1991)
264mm	FB41 - FB41	237mm	FB41 - FB41
	RT80346 NO. MB238156 - MB587752 - MB857530 - MB857544 - MR129748 - MR129755 TUBO DE TRAVÃO DE TRÁS LH-RH MITSUBISHI SPACE WAGON (N3_W - N4_W) 1.8 (N31W) (10.91 A 10.98) 122cv 1834cc Veículo multiuso - MITSUBISHI SPACE WAGON (N3_W - N4_W) 1.8 4WD (N41W) (10.91 A 10.98) 122cv 1834cc Veículo multiuso - MITSUBISHI SPACE WAGON (N3_W - N4_W) 2.0 (N33W) (10.92 A 10.98) 133cv 1997cc Veículo multiuso - MITSUBISHI SPACE WAGON (N3_W - N4_W) 2.0 4WD (N43W) (10.92 A 10.98) 133cv 1997cc Veículo multiuso - MITSUBISHI SPACE WAGON (N3_W - N4_W) 1.8 TD (N35W)...etc.		RT80352 NO. MR289287 TUBO DE TRAVÃO DE TRÁS LH-RH MITSUBISHI SPACE WAGON (N3_W - N4_W) 1.8 (N31W) (10.91 A 10.98) 122cv 1834cc Veículo multiuso - MITSUBISHI SPACE WAGON (N3_W - N4_W) 1.8 4WD (N41W) (10.91 A 10.98) 122cv 1834cc Veículo multiuso - MITSUBISHI SPACE WAGON (N3_W - N4_W) 2.0 (N33W) (10.92 A 10.98) 133cv 1997cc Veículo multiuso - MITSUBISHI SPACE WAGON (N3_W - N4_W) 2.0 4WD (N43W) (10.92 A 10.98) 133cv 1997cc Veículo multiuso - MITSUBISHI SPACE WAGON (N3_W - N4_W) 1.8 TD (N35W)...etc.
240mm	FB50 - MC50/1	240mm	FB54 - MC50/1
	RT80369 NO. MB857567 - MR129787 TUBO DE TRAVÃO DE TRÁS LH-RH MITSUBISHI SPACE WAGON (D0_V/W) 1.8 4WD (D05V - D05W) (10.87 A 08.88) 90cv 1755cc Veículo multiuso - MITSUBISHI SPACE WAGON (D0_V/W) 2.0 GLX 4WD (D08W) (06.86 A 05.88) 84cv 1997cc Veículo multiuso - MITSUBISHI SPACE WAGON (D0_V/W) 2.0 GLX 4WD (D08W) (06.88 A 04.91) 101cv 1997cc Veículo multiuso - MITSUBISHI SPACE WAGON (D0_V/W) 2.0 4WD (D08W) (03.85 A 04.91) 102cv 1997cc Veículo multiuso		RT80568 NO. MN116821 TUBO DE TRAVÃO DA FRENTE MITSUBISHI SPACE WAGON (N3_W - N4_W) 1.8 (N31W) (10.91 A 10.98) 122cv 1834cc Veículo multiuso - MITSUBISHI SPACE WAGON (N3_W - N4_W) 1.8 4WD (N41W) (10.91 A 10.98) 122cv 1834cc Veículo multiuso - MITSUBISHI SPACE WAGON (N3_W - N4_W) 2.0 (N33W) (10.92 A 10.98) 133cv 1997cc Veículo multiuso - MITSUBISHI SPACE WAGON (N3_W - N4_W) 2.0 4WD (N43W) (10.92 A 10.98) 133cv 1997cc Veículo multiuso - MITSUBISHI SPACE WAGON (N3_W - N4_W) 1.8 TD (N35W)...etc.
235mm	FB51 - FB51	525mm	FB22 - OR23
	RT80569 NO. MR289286 TUBO DE TRAVÃO DE TRÁS LH-RH MITSUBISHI SPACE WAGON (N3_W - N4_W) 1.8 (N31W) (10.91 A 10.98) 122cv 1834cc Veículo multiuso - MITSUBISHI SPACE WAGON (N3_W - N4_W) 1.8 4WD (N41W) (10.91 A 10.98) 122cv 1834cc Veículo multiuso - MITSUBISHI SPACE WAGON (N3_W - N4_W) 2.0 (N33W) (10.92 A 10.98) 133cv 1997cc Veículo multiuso - MITSUBISHI SPACE WAGON (N3_W - N4_W) 2.0 4WD (N43W) (10.92 A 10.98) 133cv 1997cc Veículo multiuso - MITSUBISHI SPACE WAGON (N3_W - N4_W) 1.8 TD (N35W)...etc.		
220mm	FB22 - FB22		

MITSUBISHI STARION

	F0066-I NO. MB290156 FOLE DO SEMI-EIXO LADO DA RODA (LADO INTERNO NO MINICAB)(F1007) MITSUBISHI STARION		RT80045 NO. MB239151 TUBO DE TRAVÃO FRENTE LH-RH MITSUBISHI STARION 2.0 TURBO - 2.5 TURBO (06-1982 A 06-1990)
d88x84mm	1f-d64mm 1f-d19mm	212mm	FB48 - MC50
	RT80046 NO. MB238160 - MR129777 - MB058592 - MB587741 TUBO DE TRAVÃO TRÁS LH-RH MITSUBISHI STARION 2.0 TURBO - 2.5 TURBO (06-1982 A 06-1990)		RT80360 NO. MB081939 - MB238153 - MB587751 - MB857532 - MB857545 - MR129750 TUBO DE TRAVÃO DE TRÁS LH-RH MITSUBISHI STARION (A18_A) 2.0 Turbo ECi (A183A) (06.82 A 12.85) 170cv 1997cc Coupé - MITSUBISHI STARION (A18_A) 2.0 Turbo ECi (A183A) (05.85 A 08.87) 180cv 1997cc Coupé - MITSUBISHI STARION (A18_A) 2.6 Turbo ECi (A187A) (09.87 A 06.90) 155cv 2555cc Coupé
264mm	FB41 - FB41	255mm	FB50 - MC50/1

	<p>E1043 NO. MB059936 - MB059522 - MB059935 - MB059937 - MB906124 - 28658-21000</p> <p>ESTICADOR DE ESCAPE</p> <p>MITSUBISHI TREDIA - (APÓS 1983) - CORDIA (1983 A 1987)</p> <p>NULL NULL</p>		<p>F0512-I NO. MB109011 - MB176162 - MB176860 - MB297147 - MB297190</p> <p>FOLE DO SEMI-EIXO EXTERNO</p> <p>MITSUBISHI TREDIA 1.4-1.6 - CORDIA 1.4-1.6</p> <p>d83x85mm 1f-d72mm 1f-d22mm</p>
	<p>F0694-I NO. MB176870 - MB297370</p> <p>FOLE DOS SEMI-EIXOS ESQUERDO E DIREITO</p> <p>MITSUBISHI TREDIA - CORDIA 1.6E - A212 . AT5 (3-82 A 9-84) - 1.8 (APÓS 3-82) - 1.8 GTX (APÓS 4-85)</p> <p>d90x86mm 1f-d23mm 1f-d79mm</p>		<p>F1252-I NO. MB160658 - MB297536</p> <p>FOLE JUNTO À CAIXA</p> <p>MITSUBISHI TREDIA - CORDIA 1.8 (APÓS 3-1982)</p> <p>d102x95mm 1f-d80mm 1f-d25mm</p>
	<p>F1253-I NO. MB176871 - MB620061</p> <p>FOLE DO SEMI-EIXO LADO RODA</p> <p>MITSUBISHI TREDIA</p> <p>d96x80mm 1f-d78mm 1f-d18mm</p>		<p>F1257-I NO. MB526148 - MB526274</p> <p>FOLE DE TRANSMISSÃO LADO DA RODA</p> <p>MITSUBISHI TREDIA 1.8 4WD (APÓS 1984) - CORDIA 1.8 4WD (APÓS 1984)</p> <p>d95x91mm 1f-d80mm 1f-d26mm</p>
	<p>F1259-I NO. MB297340 - MB297339</p> <p>FOLE DA TRANSMISSÃO LADO DA CAIXA</p> <p>MITSUBISHI TREDIA 1.6 (APÓS 1984) - CORDIA 1.6 (APÓS 1984)</p> <p>d84x88mm 1f-d74mm 1f-d20mm</p>		<p>KF3410 NO. MB176860 - MB297147 - MB297184 - MB297190 - MB297351 - MB393129 - MB526057</p> <p>FOLE DO LADO DA RODA</p> <p>MITSUBISHI TREDIA - CORDIA 1.4</p> <p>d89x87mm 1f-d73mm 1f-d21mm</p>
	<p>RT80044 NO. MB058593 - MB238161 - MB058509 - MB238162 - MB238164 - MB238166 - MB587740 - MB857559 - MB857561</p> <p>TUBO DE TRAVÃO FRENTE LH-RH</p> <p>MITSUBISHI CORDIA TT (09-1982 A 12-1986) - TREDIA 1.6 - 1.8 TURBO (09-1982 A 07-1986)</p> <p>316mm FB41 - FB41</p>		<p>RT80045 NO. MB239151</p> <p>TUBO DE TRAVÃO FRENTE LH-RH</p> <p>MITSUBISHI CORDIA TT (09-1982 A 12-1986) - TREDIA 1.4 - 1.6 - 1.8 EXCEPTO TURBO E 4X4 (09-1982 A 07-1987)</p> <p>212mm FB48 - MC50</p>
	<p>RT80046 NO. MB238160 - MR129777 - MB058592 - MB587741</p> <p>TUBO DE TRAVÃO TRÁS LH-RH</p> <p>MITSUBISHI CORDIA TT (09-1982 A 12-1986) - TREDIA 1.4 - 1.6 - 1.8 EXCEPTO TURBO E 4X4 (09-1982 A 10-1987)</p> <p>264mm FB41 - FB41</p>		<p>RT80051 NO. MB316287 - MB857553 - MR129773</p> <p>TUBO DE TRAVÃO TRÁS LH-RH</p> <p>MITSUBISHI TREDIA 1.8 TURBO (09-1982 A 07-1986)</p> <p>237mm FB41 - FB41</p>