









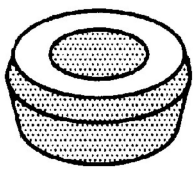

	<b>F1253-I</b> NO. G01322540 - G001-22-540A		<b>H115</b> NO.
	FOLE DO SEMI-EIXO LADO RODA MAZDA d96x80mm 1f-d78mm 1f-d18mm		PALA DE FURGÃO MAZDA FURGÃO 315x315mm NULL
	<b>H116</b> NO.		<b>L0014</b> NO.
	PALA CAMIÃO PEQUENO MAZDA 445x330mm NULL		CASQUILHO DE AMORTECEDORES (CÔNICOS) MAZDA d30x19mm d26mm 1f-d16mm
	<b>N3727</b> NO.		
	ANEL DE ESCAPE MAZDA TT d55x12mm 1f-d31mm		

MAZDA 121

	<b>F1444-I</b> NO.		<b>F1615-I</b> NO. 1E00-22-540A
	FOLE DA TRANSMISSÃO JUNTO À RODA MAZDA 121 III 1.8 D (1996 A 2001) d104x92mm 1f-d87mm 1f-d23mm		FOLE DA TRANSMISSÃO JUNTO À CAIXA MAZDA 121 III 1.2i - 1.3i - 1.8D (1996 A 2001) d87x114mm 1f-d77mm 1f-d23mm
	<b>F1649-I</b> NO. 1E01-32-125 - 1E02-32-125		<b>F1844-I</b> NO. 1E00-22-540B
	FOLE DA DIRECÇÃO ASSISTIDA LADO DIREITO E ESQUERDO MAZDA 121 III (1996 A 2001 1.3i) d70x190mm 1f-d55mm 1f-d12mm		FOLE DA TRANSMISSÃO JUNTO À CAIXA MAZDA 121 III 1.2i 16V - 1.3i - 1.8D (1996 A 2000) d91x102mm 1f-d80mm 1f-d22mm
	<b>F1855-I</b> NO. 1E00-32-125		<b>M6019</b> NO. B34540305A
	FOLE DA DIRECÇÃO LADO DIREITO E ESQUERDO MAZDA 121 III 1.2i - 1.3i - 1.8D (1996 A 2001) d60x220mm 1f-d37mm 1f-d13mm		JUNTA DE ESCAPE MAZDA 121 d51x4mm 1f-d43.6mm
	<b>M6064</b> NO. E5B640581 - B31140581A - B31140581		<b>N2336</b> NO. 030540061 - 811840061 - 811240061
	JUNTA DE ESCAPE MAZDA 121 (1989 A 1991) - 323 (1985 A 1992) - 626 (1985 A 1987) d63x15mm 1f-d48mm		ANEL ESCAPE MAZDA 121 (1987 A 1995) - 323 (1980 A 1994) - 626 (1978 A 1987) - 929 (1978 A 1988) d62x14mm 1f-d36mm

 <p><b>MC40</b> <b>MG1</b> Componenti / Components</p>	<p><b>RT08604</b> NO. 1021841 - 1033252 - 1066801 - 1109679 - 96FB2078CG - 96FB2078EA - 1E0043810D - 96FB2078JA - XS612078...</p> <p><b>TUBO DE TRAVÃO FRENTE RH</b></p> <p>MAZDA 121 III (JASM - JBSM) 1.3 (J4R - J4T) 60CV (03-1996 A 04-2003) - 1.25 (DHF - DHG) 75CV (03-1996 A 04-2003) - 1.3 (JJK - JJM) 50CV (03-1996 A 04-2003) - 1.8 D (RTJ - RTK) 60CV (03-1996 A 04-2003)</p>	 <p><b>MC11</b> <b>MC42</b> Componenti / Components</p>	<p><b>RT08607</b> NO. 1011342 - 1014204 - 96FB2282AC - 1E0043980</p> <p><b>TUBO DE TRAVÃO TRÁS LH-RH</b></p> <p>MAZDA 121 III (JASM - JBSM) 1.3 (J4R - J4T) 60CV (03-1996 A 04-2003) - 1.25 (DHF - DHG) 75CV (03-1996 A 04-2003) - 1.3 (JJK - JJM) 50CV (03-1996 A 04-2003) - 1.8 D (RTJ - RTK) 60CV (03-1996 A 04-2003)</p>
 <p><b>MC40</b> <b>MG1</b> Componenti / Components</p>	<p><b>RT08687</b> NO. 1021839 - 1066796 - 1109679 - 1E0143810D - 1E01-43-810A - 1E0143810 - 1E0143810B - 1E0143810C - 1E02...</p> <p><b>TUBO DE TRAVÃO FRENTE LH</b></p> <p>MAZDA 121 III (JASM - JBSM) 1.25 (DHF - DHG) 75CV (03-1996 A 04-2003) - 1.3 (J4R - J4T) 60CV (03-1996 A 04-2003) - 1.3 (JJK - JJM) 50CV (03-1996 A 04-2003) - 1.8 D (RTJ - RTK) 60CV (03-1996 A 04-2003)</p>		<p><b>S1477</b> NO. 1E0028460B - 1E0028460C</p> <p><b>SILENT BLOC DO EIXO TRASEIRO</b></p> <p>MAZDA 121 III 1.25 - 1.3 - 1.8D (APÓS 1996)</p>
415mm	MC40 - MG1	335mm	MC11 - MC42
415mm	MC40 - MG1	d75x70mm	d64mm 1f-d12mm

## MAZDA 1500

	<p><b>R0638</b> NO.</p> <p><b>TUBO DA CHAUFAGE</b></p> <p>MAZDA 1500</p>		
B375-d15/15mm	55-55-95-100-90-70mm		

## MAZDA 2

	<p><b>A1594</b> NO. DD32-34-380 - DD32-34-380A</p> <p><b>APOIO DO AMORTECEDOR DA FRENTE</b></p> <p>MAZDA 2 (B2W) 1.25 - 1.4 - 1.6 APÓS 04-03</p>		<p><b>E0236</b> NO. GJ6A28170A</p> <p><b>ESTICADOR DA BARRA ESTABILIZADORA DE TRÁS</b></p> <p>MAZDA 1.8 (APÓS 08-2002) - 2.0 - 2.0 Di (APÓS 08-2002) - 2.3 (APÓS 08-2002) - 2.3 AWD (APÓS 11-2002)</p>
108x108x34mm	3p-d8-22mm	105x32x32mm	1p-d10-19mm 1f-d10mm
	<p><b>E0258</b> NO. D65134170 - D65134170A</p> <p><b>ESTICADOR DA BARRA ESTABILIZADORA DA FRENTE</b></p> <p>MAZDA - 2 (DE) 1.3 Hatchback (10.07 - 06.15) 75cv 1349cc - MAZDA - 2 (DE) - 1.3 Hatchback (10.07 - 06.15) 86cv 1349cc - MAZDA - 2 (DE) - 1.5 Hatchback (10.07 - 06.15) 103cv 1498cc - MAZDA - 2 (DE) - 1.4 MZR-CD Hatchback (01.08 - 06.15) 68cv 1399cc</p>		<p><b>F1623-I</b> NO. C602-22-530 - Y402-22-530</p> <p><b>FOLE DA TRANSMISSÃO JUNTO À RODA</b></p> <p>MAZDA 2 1.4 HDi - 1.6i (APÓS 2003)</p>
290x36x35mm	2p-d10x25mm	d82x86mm	1f-d69mm 1f-d21mm
	<p><b>F1820-I</b> NO. Y402-22-530 - Y402-22-540</p> <p><b>FOLE DA TRANSMISSÃO JUNTO À CAIXA</b></p> <p>MAZDA 2 1.4 HDi (APÓS 2003)</p>		<p><b>KF1606</b> NO. C602-22-530 - Y402-22-530</p> <p><b>KIT DE FOLE DO CARDAN JUNTO À RODA</b></p> <p>MAZDA 2 1.4 HDi - 1.6i (APÓS 2003)</p>
d85x88mm	1f-d73mm 1f-d19mm	d90x85mm	1f-d66mm 1f-21mm

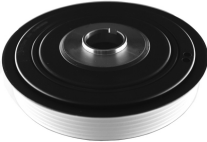
	<b>W5120</b> NO. Y40111401 - Y40111401A - Y40111401C - Y60311401 - Y40111401B - Y40111406A - 11237801979 - 112378019...		
	<b>POLIE DA CAMBOTA (6 PISTAS)</b> MAZDA - 2 (DY) - 1.4 CD (APÓS 04.03) 68cv 1399cc Hatchback - MAZDA - 2 (DE) - 1.4 MZR-CD Ano fabric. até: (04.10) (01.08 - 06.15) 68cv 1399cc Hatchback		
	d150/162mm	d29,5mm	

MAZDA 3

	<b>A1784</b> NO. BP4K-39-040D - BP4K-39-040E - BP4K-39-040C - BP4K-39-040 - BP4S-39-040 - BP4K-39-040F		<b>A1827</b> NO. BP4L-34-380B - B39D-34-380 - BBT9-34-380 - BP4L-34-380 - BP4K-34-380A - B39D-34-380A - BP4K-34-380D...
	<b>APOIO DA CAIXA VELOCIDADES</b> MAZDA -3 (BK) - 1.6(HATCHBACK) 105CV 1598cc (10-2003 A 06-2009) - TRÊS VOLUMES (BK) 1.6 105CV 1598cc (APÓS 02-2004)		<b>APOJO DO AMORTECEDOR DA FRENTE DIREITO E ESQUERDO</b> MAZDA 3 (BK) 1.4 Ano fabric. até: (11.08) (10.03 - 06.09) 84cv 1349cc Hatchback - MAZDA 3 (BK) 1.6 Ano fabric. até: (11.08) (10.03 - 06.09) 105cv 1598cc Hatchback - MAZDA 3 (BK) 2.0 Ano fabric. até: (11.08) (10.03 - 06.09) 150cv 1999cc Hatchback - MAZDA 3
	160x1005x45mm	2f-d12mm 1f-M12	140x32mm
			1f-d12mm 3r-d8mm
	<b>E0178</b> NO. BP4K34170C - BP4K34170D		<b>E0251</b> NO. C236-28-500A - BP4K28500C
	<b>ESTICADOR DA BARRA ESTABILIZADORA DA FRENTE</b> MAZDA 3 TT - 5 TT		<b>ESTICADOR DA SUSPENSÃO DE TRÁS</b> MAZDA 3 (BK14) 1.4 - 1.6 Di TURBO - 2.0 APÓS 10-03 MAZDA 3 TRÊS VOLUMES (BK12) 1.6 - 1.6 Di TURBO - 2.0 - APÓS 02-04 - MAZDA 5 (CR19) 1.8 - 2.0 - 2.0 CD APÓS 03-05
	325x30x35mm	2p-d10-22mm	280x58x35mm
			2d-32mm 2f-11.2mm
	<b>RT80216</b> NO. BP4L43980E		<b>S1506</b> NO. B32H-34-250E - 332H-34-250E S3
	<b>TUBO DE TRAVÃO FRENTE LH-RH</b> MAZDA 3 TT (APÓS 10-2003)		<b>SILENT BLOCO DO BRAÇO SUSPENSÃO FRENTE PARTE DE TRÁS</b> MAZDA - 3 (BK) - 1.6 Hatchback 105CV (1598cc)(10-2003 A 06-2009) - 1.6 DI Turbo Hatchback 109cv (1560cc)(06-2004 A 06-2009) - 2.0 MZR-CD Hatchback 143 (1998cc)(12-2006 A 06-2009) - MAZDA - 3 Três volumes (BK) - 1.6 105CV (1598cc)(APÓS 02-2004) - 1.6 DI Tu
	420mm	FB42 - MC11	123x82x93mm
			1f-d21.7mm 2f-d13mm 2r-d12mm
	<b>W5120</b> NO. Y40111401 - Y40111401A - Y40111401C - Y60311401 - Y40111401B - Y40111406A - 11237801979 - 112378019...		
	<b>POLIE DA CAMBOTA (6 PISTAS)</b> MAZDA - 3 (BK) - 1.6 MZ-CD (APÓS 06.06) 90cv 1560cc Hatchback - MAZDA - 3 (BK) - 1.6 DI Turbo (06.04 - 06.09) 109cv 1560cc Hatchback - MAZDA - 3 três volumes (BK) - 1.6 DI Turbo (APÓS 06.04) 109cv 1560cc três volumes - MAZDA - 3 (BL) - 1.6 MZR CD (APÓS 1		
	d150/162mm	d29,5mm	

MAZDA 3000

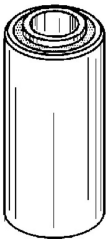
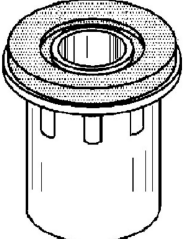
	<b>S1031</b> NO. 55934330		<b>S1032</b> NO. 68034330 - 0680-34-330
	<b>SILENT-BLOC DA MOLA DA FRENTE E TRÁS</b> MAZDA 3000		<b>SILENT-BLOC DA MOLA DA FRENTE</b> MAZDA 3000
	d33x76mm	c69mm 1f-d16mm	d47.5x43mm
			d35mm 1f-d17mm

	<p><b>E1000</b> NO. 387440060 - 411240060 - 8531.40060 - 853140060A</p> <p>ESTICADOR DE ESCAPE</p> <p>MAZDA 323 - 626 - 929 - 121</p> <p>110x75x40mm NULL</p>		<p><b>F0512-I</b> NO. F001.22.530 - F003.22.530A - F002.22.530</p> <p>FOLE DO SEMI-EIXO INTERNO</p> <p>MAZDA 323 (1.3 - 1.5)(SDE 80)</p> <p>d83x85mm 1f-d72mm 1f-d22mm</p>
	<p><b>F0687-I</b> NO. B300-32-125 - H002-32-125</p> <p>FOLE DA DIREÇÃO ASSISTIDA LADO DIREITO E ESQUERDO</p> <p>MAZDA 323 I (1977 A 1986 1.1 - 1.3 - 1.3i - 1.5 - 1.6 - 1.6 GT - 1.6i T GT 4WD - 1.7 D - MAZDA 323 C V (1994 A 1998 1.8i 16V - MAZDA 323 F IV (1989 A 1994 1.6i 16V - 1.8 16V - 1.8i 16V - 1.8i 4WD - MAZDA 323 P V (1996 A 1998 2.0 D - MAZDA 323 S IV (1989 A</p> <p>d60x230mm 1f-d48mm 1f-d10mm</p>		<p><b>F0706-I</b> NO. F001.22.540</p> <p>FOLE DO SEMI-EIXO INTERNO</p> <p>MAZDA 323 (1.3 - 1.5)(ATÉ 11-84)</p> <p>d89x92mm 1f-d76mm 1f-d22mm</p>
	<p><b>F1081-I</b> NO. B001-32-118</p> <p>FOLE DA DIREÇÃO ASSISTIDA LADO DIREITO</p> <p>MAZDA 323 I (1977 A 1986 1.1 - 1.3 - 1.5 - MAZDA 323 II (1980 A 1989 1.1 - 1.3 - 1.5</p> <p>d60x230mm 1f-d48mm 1f-d10mm</p>		<p><b>F1224-I</b> NO. F00122540</p> <p>FOLE DO LADO DA CAIXA</p> <p>MAZDA 323 - FAMILIA 1.3 - 1.5 (06-80 A 12-84)</p> <p>d85x90mm 1f-74mm 1f-23mm</p>
	<p><b>F1260-I</b> NO. F004-22-540C - G012-22-540A - G033-22-540</p> <p>FOLE DA TRANSMISSÃO JUNTO À CAIXA</p> <p>MAZDA LASER 1.6 (1985 A 1989)</p> <p>d92x91mm 1f-d81mm 1f-d22mm</p>		<p><b>F1294-I</b> NO. B001-32-125</p> <p>FOLE DA DIREÇÃO ASSISTIDA LADO ESQUERDO</p> <p>MAZDA 323 I (1977 A 1986 1.1 - 1.3 - 1.5 - MAZDA 323 II (1980 A 1989 1.1 - 1.3 - 1.5</p> <p>d60x220mm 1f-d37mm 1f-d11mm</p>
	<p><b>F1328-I</b> NO. B004-22-540 - F006-22-540A - F006-22-540B - F011-22-540 - F057-22-540 - G071-22-540 - ZS4-22-540</p> <p>FOLE DA TRANSMISSÃO JUNTO À CAIXA</p> <p>MAZDA 323 I 1.1 - 1.3 - 1.6i T GT 4WD (1977 A 1986)</p> <p>d75x85mm 1f-d64mm 1f-d18mm</p>		<p><b>F1328-I</b> NO. B004-22-540 - F006-22-540A - F006-22-540B - F011-22-540 - F057-22-540 - G071-22-540 - ZS4-22-540</p> <p>FOLE DA TRANSMISSÃO JUNTO À CAIXA</p> <p>MAZDA 323 II 1.1 - 1.3 (1980 A 1989)</p> <p>d75x85mm 1f-d64mm 1f-d18mm</p>
	<p><b>F1328-I</b> NO. B004-22-540 - F006-22-540A - F006-22-540B - F011-22-540 - F057-22-540 - G071-22-540 - ZS4-22-540</p> <p>FOLE DA TRANSMISSÃO JUNTO À CAIXA</p> <p>MAZDA 323 III 1.1 - 1.3 - 1.6i T (1985 A 1993)</p> <p>d75x85mm 1f-d64mm 1f-d18mm</p>		<p><b>F1328-I</b> NO. B004-22-540 - F006-22-540A - F006-22-540B - F011-22-540 - F057-22-540 - G071-22-540 - ZS4-22-540</p> <p>FOLE DA TRANSMISSÃO JUNTO À CAIXA</p> <p>MAZDA 323 S IV 1.3 (1989 A 1994)</p> <p>d75x85mm 1f-d64mm 1f-d18mm</p>
	<p><b>F4040</b> NO. B455-28-111A</p> <p>FOLE DOS AMORTECEDORES DE TRÁS</p> <p>MAZDA MD 323 ASTINA</p> <p>d68x255mm 1f-d55mm 1f-d19mm</p>		<p><b>F4041</b> NO. B455-34-111B</p> <p>FOLE DOS AMORTECEDORES DA FRENTE</p> <p>MAZDA MD 323 ASTINA</p> <p>d70x185mm 1f-d60mm 1f-d19mm</p>
	<p><b>KF1612</b> NO.</p> <p>KIT DE FOLE DO CARDAN LADO DA RODA</p> <p>MAZDA 323F 2.0i 24V 08-94 A 05-98</p> <p>d100x100mm 1f-d83mm 1f-d23mm</p>		<p><b>KF3210</b> NO.</p> <p>KIT DE FOLE DO CARDAN LADO DA RODA</p> <p>MAZDA 323 1.5 - 1.5 ESTATE 04-87 A 07-87 - 1.6i DOHC 10-85 A 01-89 - 626 1.6 01-83 A 07-87 - 1.6 COUPE 01-83 A 07-87 - 1.8 02-83 A 07-87 - 1.8 12V 07-87 A 03-93 - 1.8 12V WAGON 07-87 A 03-93 - 2.0 - 2.0 COUPE 04-87 A 07-87 - 2.0i 12V - COUPE 07-87 A 03-90</p> <p>d86x84mm 1f-d76mm 1f-d22mm</p>

	<p><b>KF3282</b> NO. FA50-22-530 - FA50-22-530A</p> <p>KIT DE FOLE DO CARDAN JUNTO À RODA</p> <p>MAZDA 323 C V (1994 A 1998 1.3i 16V - MAZDA 323 F V (1994 A 1998 1.3i 16V - 1.4i 16V - 1.5i 16V - 1.9i 16V - 2.0 D - 2.0 TD - MAZDA 323 S VI APÓS 1998 1.4i 16V - 1.5i 16V</p> <p>d84x68mm 1f-d74mm 1f-d20mm</p>		<p><b>M6008</b> NO. KL1440305</p> <p>JUNTA DE ESCAPE</p> <p>MAZDA 323F (APÓS 1994)</p> <p>d65x5mm 1f-d50mm</p>
	<p><b>M6088</b> NO. E52340581C - BP4840581A</p> <p>JUNTA DE ESCAPE</p> <p>MAZDA 323 (1985 A 1989 - 626 (1987 A 1992)</p> <p>d68x15mm 1f-d54mm</p>		<p><b>M6098</b> NO. F60140581B - RF0340581</p> <p>JUNTA DE ESCAPE</p> <p>MAZDA 323 (1994 A 1995) - 323F (1994 A 1995) - 626 (1983 A 1987)</p> <p>d59x16mm 1f-d45mm</p>
	<p><b>RT80037</b> NO. B45543980B - B45543980 - B45543980A - 3898670 - F4CZ2078B</p> <p>TUBO DE TRAVÃO FRENTE LH-RH</p> <p>MAZDA 323 323F 1.3 16V - 1.5 16V - 1.8 - 2.0 24V (1994 A 09-1998) - 323F 1.6 - 1.6 16V - 1.8 16V (1989 A 1994) - 323S 1.3 16V - 1.5 16V - 1.8 - 1.6TD (08-1994 A 09-1998) - 323S 1.3 - 1.3 16V - 1.6 - 1.6 16V - 1.8 16V - 1.7D (1989 A 07-1994) - 626S (1992 A 04-</p> <p>435mm FB63 - OR42</p>		<p><b>RT80038</b> NO. B45543810A - B45543810B - B45543810C</p> <p>TUBO DE TRAVÃO TRÁS LH-RH</p> <p>MAZDA 323 323F(1.6 - 1.6 16V - 1.8 16V) (1989 A 1994 - 323S (1.3 - 1.3 16V - 1.6 - 1.6 16V - 1.8 16V - 1.7D) (1989 A 07-1994</p> <p>281mm FB63 - FB63</p>
	<p><b>S1174</b> NO. B001-34-460</p> <p>SILENT-BLOC DO BRAÇO INFERIOR DA SUSPENSÃO</p> <p>MAZDA 323</p> <p>57x50x45mm 1f-d18mm</p>		<p><b>S1175</b> NO. B001-34-470</p> <p>SILENT-BLOC DO BRAÇO INFERIOR DA SUSPENSÃO</p> <p>MAZDA 323</p> <p>d42x52mm d31mm 1f-d18mm</p>
	<p><b>S1176</b> NO. B092-34-460B - B092-34-460</p> <p>SILENT-BLOC DA SUSPENSÃO</p> <p>MAZDA 323</p> <p>56x51x44mm 1f-d18mm</p>		<p><b>S1435</b> NO. BC1F-34-46X - BC1F-34-46AX</p> <p>SILENT-BLOC DO BRAÇO DA SUSPENSÃO DA FRENTE PARTE INFERIOR DIREITO</p> <p>MAZDA 323 (APÓS 1996)</p> <p>160x55x63mm 1f-d18mm</p>
	<p><b>S1436</b> NO. BC1F-34-46Y - BC1F-34-46YA</p> <p>SILENT-BLOC DO BRAÇO DA SUSPENSÃO DA FRENTE PARTE INFERIOR ESQUERDO</p> <p>MAZDA 323 (APÓS 1996)</p> <p>160x55x63mm 1f-d18mm</p>		<p><b>S1437</b> NO. B25D-34-470</p> <p>SILENT-BLOC DO BRAÇO DA SUSPENSÃO DA FRENTE PARTE INFERIOR</p> <p>MAZDA 323 SEDAN (APÓS 2000)</p> <p>d42x60mm c50mm d30.6mm 1f-d12.5mm</p>



MAZDA 5 (PREMACY)

	<p><b>S1506</b> NO. B32H-34-250E - 332H-34-250E S3</p> <p>SILENT BLOCO DO BRAÇO SUSPENSÃO FRENTE PARTE DE TRÁS</p> <p>MAZDA - 5 (CR19) - 1.8 116CV (Veículo multiuso) 116CV (1798cc)(APÓS 03-2005) - 2.0 146CV (Veículo multiuso) (1999CC)(APÓS 03-2005) - 2.0 CD 110CV (Veículo multiuso)(1998CC) (APOS 03-2005) - 2.0 CD 143(Veículo multiuso)(1998cc)(APÓS 06-2005)</p> <p>123x82x93mm 1f-d21.7mm 2f-d13mm 2r-d12mm</p>		
--	--	--	--

## MAZDA 6

	<b>A1909</b> NO. GJY039060 - GJ6F39060E - GJ6G39060D - GJ6G39060G - GJ6G39060H - GJ6G39060C - GR9V39060C - G22G-39-06...		<b>E0240</b> NO. GJ6A34150A
	<b>APOIO DO MOTOR PARTE DA FRENTE DIREITO</b> MAZDA 6 Hatchback (GG) 1.8 Local de montagem: à direita - Ano fabric. até: 02.05 (08.02 A 08.07) 120cv 1798cc Hatchback - MAZDA 6 Hatchback (GG) 2.0 Local de montagem: à direita (08.02 A 08.07) 141cv 1999cc Hatchback - MAZDA 6 Hatchback (GG) 2.0 Local de montagem: à direita - Tipo de caixa de velocidades: Totalmente automático (03.05 A 08.07) 147cv 1999cc Hatchback - MAZDA 6 Hatchback (GG) 2.3 Local de montagem: à direita - Tipo de caixa...etc.		<b>ESTICADOR DA BARRA ESTABILIZADORA DA FRENTE LADO DIREITO</b> MAZDA 6 (TODAS MOTORIZAÇÕES)
200x170x160mm	1r-d12mm 1f-d14mm 1f-12-14mm 1f-d10r	182x32x32mm	2p-d10-23mm
	<b>E0241</b> NO. GJ6A34170A		
	<b>ESTICADOR DA BARRA ESTABILIZADORA DA FRENTE LADO ESQUERDO</b> MAZDA 6 (TODAS MOTORIZAÇÕES)		
182x32x32mm	2p-d10-23mm		

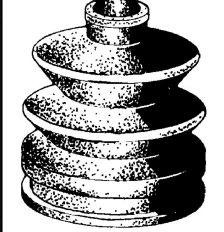
## MAZDA 626

	<b>A1241</b> NO. 8593-25-300		<b>F0511-I</b> NO. GOO1.22.540
	<b>APOIO DO VEIO DA TRANSMISSÃO</b> MAZDA 626		<b>FOLE DO SEMI-EIXO INTERNO</b> MAZDA 626 - CAPELLA 1.6 - 1.8 - TELSTAR - TX5
180x130x59mm	1f-d25mm	d89x91mm	1f-d75mm 1f-d21mm
	<b>F1260-I</b> NO. F004-22-540C - G012-22-540A - G033-22-540		<b>M6063</b> NO. FE1440581C - FE3540581
	<b>FOLE DA TRANSMISSÃO JUNTO À CAIXA</b> MAZDA 626 2.0 DiT - 2.0i (1997 A 2002)		<b>JUNTA DE ESCAPE</b> MAZDA 626 (1982 A 1987)
d92x91mm	1f-d81mm 1f-d22mm	d65x15mm	1f-d50mm
	<b>N1617</b> NO. 8118.40.061		
	<b>ANEL DE ESCAPE</b> MAZDA 626		
d65x13mm	1f-d40mm		

## MAZDA 818

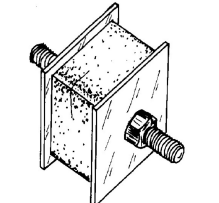
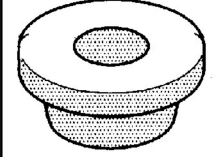

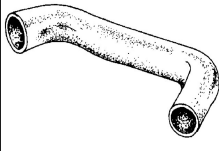
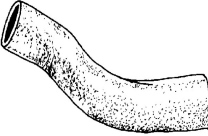
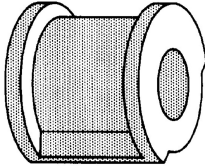

	<b>A0866</b> NO. 0370-39-040A		<b>L0268</b> NO. 856534153
	<b>SUPORTE DO MOTOR</b> MAZDA 818		<b>CASQUILHO DE ESTABILIZADOR</b> MAZDA 818
55x55x34mm	2p-d10-28mm	d40x25mm	d32mm 1f-d16mm











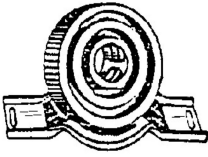





	<b>R0597</b>	NO.		<b>R0651</b>	NO.
	TUBO INFERIOR DO RADIADOR			TUBO SUPERIOR DO RADIADOR	
MAZDA 818		MAZDA 818			
B280-d34/34mm		140-200-120mm		B220-d35/34mm	
140-200-120mm		50-75-115mm			
	<b>T0008</b>	NO. 1881-34-156 - 0259-34-156			
	BATENTE DA BARRA ESTABILIZADORA				
MAZDA 818					
47x44x42mm		1f-d20mm			

MAZDA 929

	<b>A1241</b>	NO. 8593-25-300			
	APOIO DO VEIO DA TRANSMISSÃO				
MAZDA 929					
180x130x59mm		1f-d25mm			

MAZDA B

	<b>A1895</b>	NO. SA68-25-300A - SA68-25-300		<b>L3147</b>	NO. 1729345 - UH7128470
	APOIO DA TRANSMISSÃO			CASQUILHO SUPERIOR MOLA LAMINA TRÁS	
MAZDA B-SERIE (UN) 2.5D Pick-up (06-1999 A 11-2006) 78CV 2500CC - MAZDA B-SERIE (UN) 2.5D 4WD Pick-up (06-1999 A 11-2006) 78CV 2500CC - MAZDA B-SERIE (UN) 2.5D Pick-up (12-2002 A 11-2006) 84CV 2500CC - MAZDA B-SERIE (UN) 2.5D 4WD (12-2002 A 11-2006) 84CV		MAZDA B-SERIE (UN) 2.2 4WD N.º peças nec.: 2, (02.99 A 11.06) 82cv 2184cc Pick-up - MAZDA B-SERIE (UN) 2.2 8V 4WD N.º peças nec.: 2,(06.99 A 11.06) 92cv 2148cc Pick-up - MAZDA B-SERIE (UN) 2.5 D N.º peças nec.: 2, (06.99 A 11.06) 78cv 2500cc Pick-up - MAZDA B-SERIE (UN) 2.5 D 4WD N.º peças nec.: 2,(06.99 A 11.06) 78cv 2500cc Pick-up - MAZDA B-SERIE (UN) 2.5 D 4WD (12.02 A 11.06) 84cv 2500cc Pick-up - MAZDA B-SERIE...etc.		d41x53mm	
210x135x57mm		1f-d35mm		d31mm 1f-d20mm	
	<b>L3148</b>	NO. 1729347 - UH7128480		<b>S1543</b>	NO. UR56-34-470B
	CASQUILHO INFERIOR MOLA LAMINA TRÁS			SILENT-BLOC DO BRAÇO SUPERIOR DA SUSPENSÃO DA FRENTE	
MAZDA B-SERIE (UN) 2.2 4WD N.º peças nec.: 2, (02.99 A 11.06) 82cv 2184cc Pick-up - MAZDA B-SERIE (UN) 2.2 8V 4WD N.º peças nec.: 2,(06.99 A 11.06) 92cv 2148cc Pick-up - MAZDA B-SERIE (UN) 2.5 D N.º peças nec.: 2, (06.99 A 11.06) 78cv 2500cc Pick-up - MAZDA B-SERIE (UN) 2.5 D 4WD N.º peças nec.: 2,(06.99 A 11.06) 78cv 2500cc Pick-up - MAZDA B-SERIE (UN) 2.5 D 4WD (12.02 A 11.06) 84cv 2500cc Pick-up - MAZDA B-SERIE...etc.		MAZDA B-SERIE (UN) 2.5 D Pick-up (06.99 A 11.06) 78CV 2500CC - MAZDA B-SERIE (UN) 2.5 D 4WD (06.99 A 11.06) 78CV 2500CC - MAZDA B-SERIE (UN) 2.5 D Pick-up (12.02 A 11.06) 84CV 2500CC - MAZDA B-SERIE (UN) 2.5 D 4WD Pick-up (12.02 A 11.06) 84CV 2500CC - MAZ		d48x60mm	
d41x34mm		d31mm 1f-d20mm		c31mm d38mm 1f-d16mm	
	<b>S1554</b>	NO. UR5828450A - 1454931			
	SILENT-BLOC DO BRAÇO DA SUSPENSÃO DA FRENTE				
MAZDA B-SERIE (UN) 2.5 D Pick-up (06.99 A 11.06) 78CV 2500CC - MAZDA B-SERIE (UN) 2.5 D 4WD Pick-up (06.99 A 11.06) 78CV 2500CC - MAZDA B-SERIE (UN) 2.5 D Pick-up (12.02 A 11.06) 84CV 2500CC - MAZDA B-SERIE (UN) 2.5 D 4WD Pick-up (12.02 A 11.06) 84CV 2500					
d56x37mm		c28mm d40,3mm 1f-d14,4mm			

	<p><b>A1131</b> NO. 0755-25-300</p> <p>APOIO DO VEIO DE TRANSMISSÃO</p> <p>MAZDA B1200 - B1600</p> <p>NULL NULL</p>		<p><b>A1242</b> NO. P030-35-310A - P030-25-310A</p> <p>APOIO DA TRANSMISSÃO COM ROLAMENTO</p> <p>MAZDA B2200</p> <p>NULL NULL</p>
	<p><b>A1243</b> NO. P030-25-310</p> <p>SUPORTE DE TRANSMISSÃO SEM ROLAMENTO</p> <p>MAZDA B2200</p> <p>NULL NULL</p>		<p><b>A1497</b> NO. P047-25-310A - P047-25-310</p> <p>APOIO DO VEIO DA TRANSMISSÃO</p> <p>MAZDA B2500</p> <p>190x115x65mm 1f-d30mm</p>
	<p><b>A1663</b> NO. UH74-39-33X</p> <p>APOIO DO MOTOR PARTE DE TRÁS</p> <p>MAZDA B2500 4WD</p> <p>47x39x32mm 2p-d10-24mm</p>		<p><b>A1664</b> NO. UH74-39-34X</p> <p>APOIO DO MOTOR</p> <p>MAZDA B2500 4WD</p> <p>111x66x44mm 2p-d10-22mm</p>
	<p><b>A1674</b> NO. UH71-39-040</p> <p>APOIO DO MOTOR PARTE DA FRENTE</p> <p>MAZDA B2500 4WD</p> <p>110x55x43mm 2p-d10-22mm</p>		<p><b>A1736</b> NO. UB39-34-110</p> <p>APOIO BATENTE DA SUSPENSÃO PARTE INFERIOR</p> <p>MAZDA MAGNUM - FIGHTER</p> <p>71x65x49mm 1p-d10-28mm</p>
	<p><b>A1742</b> NO. UH74-34-110</p> <p>APOIO BATENTE DA SUSPENSÃO DA FRENTE INFERIOR</p> <p>MAZDA FIGHTER 4X4 - B2200</p> <p>67x63x36mm 1p-d10-27mm</p>		<p><b>KF1665</b> NO. 39241-5M325 - 39241-9E025</p> <p>KIT DE FOLE DO CARDAN JUNTO À RODA</p> <p>MAZDA SÉRIE B (APÓS 1999) 2.5D</p> <p>d100x82mm 1f-d84mm 1f-d25mm</p>
	<p><b>KF2362-T</b> NO. 4119973 - 4371800 - 4410860</p> <p>KIT DE FOLE DO CARDAN JUNTO À RODA</p> <p>MAZDA B-SERIE 2.5D (APÓS 1999)</p> <p>d104x130mm 1f-d91mm 1f-d27mm</p>		<p><b>L3016</b> NO. 3784-28-330</p> <p>BATENTE DE MOLA TRÁS</p> <p>MAZDA B2200</p> <p>d40x40mm d36mm 1f-d19mm</p>
	<p><b>L3029</b> NO. 3874-28-330</p> <p>CASQUILHO DAS MOLAS DE TRÁS (OLHAL FRENTE)</p> <p>MAZDA PICK-UP B2200</p> <p>d37x37mm d31mm 1f-d17mm</p>		<p><b>L3050</b> NO. UB39-28-333 - XM345719AA</p> <p>CASQUILHO DAS MOLAS TRÁS PARTE DA FRENTE</p> <p>MAZDA B2200</p> <p>d37x47mm d32mm 1f-d18mm</p>
	<p><b>L3051</b> NO. UB40-28-333 - S084-28-333 - UH7128480 - XM345719BA - 4023510</p> <p>CASQUILHO DAS MOLAS TRÁS PARTE DE TRÁS</p> <p>MAZDA B2200</p> <p>d37x37mm d32mm 1f-d18mm</p>		<p><b>L3092</b> NO. UB39-32-329</p> <p>CASQUILHO DA DIREÇÃO</p> <p>MAZDA B2500</p> <p>d39x29mm d30mm1f-d23mm</p>







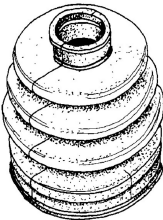

	<b>L3097</b> NO. UB39-34-136 - XM343C078AA	CASQUILHO DO ESTICADOR DA SUSPENSÃO MAZDA MAGNUM		<b>M6089</b> NO. E30140305 - N32740305 - 1259-40-325A - 1480-13-621 - B32240305 - E30540305
	d47x27mm 1f-d23mm			JUNTA DE ESCAPE MAZDA B2000 - B2200 (1985 A 1996) - B2600 (1998 A 1990) - E2000 - E2200 (APOS 1984) - MX-3 (1991 A 1993) - MX5 (APOS 1989) - 121 (1987 A 1995) - 323 - 323F (1989 A 1994) - 626 (1982 A 1993)
	<b>P1040</b> NO. S083-43-028	CAPA PEDAL DO TRAVÃO E EMBRAIAGEM MAZDA B2200 - B2500 - B2700 - B3000		<b>S1139</b> NO. UA01-34-818
	60x55x11mm NULL	SILENT-BLOC DO BRAÇO INFERIOR DA SUSPENSÃO MAZDA B2500		d45x59mm d34mm 1f-d18mm
	<b>S1179</b> NO. VA01-34-820	SILENT-BLOC DO BRAÇO INFERIOR DA SUSPENSÃO MAZDA B2200		<b>S1419</b> NO. UH71-34-470
	d46x58mm d33mm c46mm 1f-d18mm	SILENT-BLOC DO BRAÇO DA SUSPENSÃO DA FRENTE PARTE SUPERIOR MAZDA B2500 (4WD)		d49x50mm c31mm d38mm d37mm 1f-d18mm
	<b>S1422</b> NO. UH71-34-460 - UC86-34-460 - UH75-34-460 - UR61-34-460 - UC86-34-460A	SILENT-BLOC DO BRAÇO DA SUSPENSÃO DA FRENTE PARTE INFERIOR MAZDA B2500 (4WD)		<b>T1015</b> NO. UB71-34-156 - UB71-34-156A
	d50x92mm c63mm d40mm 1f-d18.4mm	BATENTE DA BARRA ESTABILIZADORA DA FRENTE PARTE DO CENTRO MAZDA B2500		36x33x33mm 1f-d24mm

MAZDA BONGO

	<b>F0694-I</b> NO. F004-22-530A - G001-22-530 - G021-22-530A - F004-22-530 - G021-22-530	FOLE DO SEMI-EIXO LADO DA RODA MAZDA BONGO - BONGO BRAWNY		
	d90x86mm 1f-d23mm 1f-d79mm			

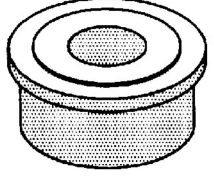
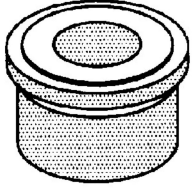
MAZDA BT-50

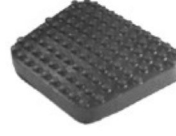
	<b>A1741</b> NO. UH71-34-110	APOIO BATENTE DA SUSPENSÃO DA FRENTE INFERIOR MAZDA BT-50 (APÓS 2006)		
	70x60x48mm 1p-d10-31mm			

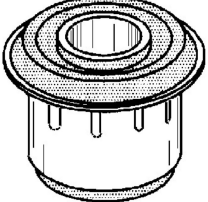
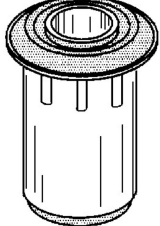
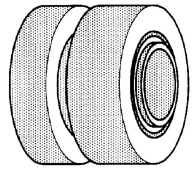
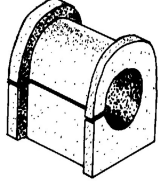
	<b>A1516</b> NO. S093-39-040A - UB39-39-040A - UB73-39-040 - S093-39-040 - UB39-39-040 - 0K01139050B - 0K01139040B - APOIO DA FRENTÉ DO MOTOR MAZDA MAXI E2200 115x53x43mm 2p-d10-22mm		<b>F4028</b> NO. 0187-34-515 - 018734515 FOLE RESGUARDO DAS RÓTULAS MAZDA MAXI E2200 d42x26mm 1f-d26mm 1f-d11mm
	<b>L1042</b> NO. S08725333 CASQUILHO DE MOLA TRÁS MAZDA E2200 d45x35mm d40mm 1f-d18mm		<b>L1049</b> NO. S00128333 CASQUILHO DE MOLA FRENTE MAZDA E2200 d37x39mm d33mm 1f-d18mm
	<b>L3036</b> NO. S083-28-333 CASQUILHO DAS MOLAS DETRÁS (PARTE DE TRÁS) MAZDA E2200 d47x38.5mm c30mm d40mm 1f-d19mm		<b>P0006-R</b> NO. CAPA DE PEDAL TRAVÃO E EMBRAIAGEM MAZDA E2200 67x52x10mm NULL
	<b>P1039</b> NO. 0559-43-028 CAPA PEDAL DO TRAVÃO E EMBRAIAGEM MAZDA PICK-UP E2500 - E2700 - E3000 75x66x12mm NULL		<b>S1048</b> NO. S083-34-470 SILENT-BLOC DO BRAÇO SUSPENSÃO SUPERIOR MAZDA E2200 d57x43mm d45mm 1f-d22mm
	<b>S1049</b> NO. S083-34-460 - 019334320 SILENT-BLOC DO BRAÇO SUSPENSÃO SUPERIOR MAZDA E2200 d57x71mm d45mm 1f-d24mm		<b>T0017</b> NO. S08334136 BATENTE DA BARRA ESTABILIZADORA MAZDA E2200 d48x40mm NULL
	<b>T0040</b> NO. S083-34-156 BATENTE DA BARRA ESTABILIZADORA DO CENTRO MAZDA E2200 41x38x38mm 1f-d19mm		

## MAZDA E2700

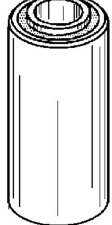
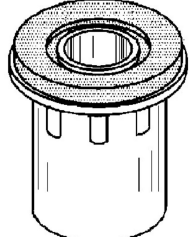
	<b>S1031</b> NO. 55934330 SILENT-BLOC DA MOLA DA FRENTE E TRÁS MAZDA E2700 d33x76mm c69mm 1f-d16mm		<b>S1032</b> NO. 68034330 - 0680-34-330 SILENT-BLOC DA MOLA DA FRENTE MAZDA E2700 d47.5x43mm d35mm 1f-d17mm
---	---	---	--



	<b>F0694-I</b> NO. F004-22-530A - G001-22-530 - G021-22-530A - F004-22-530 - G021-22-530		<b>F1252-I</b> NO. G00222540
	FOLE DO SEMI-EIXO LADO DA RODA  MAZDA FAMÍLIA 1.5 (1-85 A 1-87) - 1.6E (APÓS 10-85) - 1.5 - 1.6 CABRIO (APÓS 1-86) - ETUDE 1.6 MT (APÓS 1-87) - 626 - CAPELLA 1.6 - 1.8 (APÓS 2-82) - 2.0 (3-87 A 10-87) - PERSONA 1.8 (APÓS 10-88)		FOLE JUNTO À CAIXA  MAZDA FAMÍLIA 1500 (1-1985 A 1-1987)
d90x86mm	1f-d23mm 1f-d79mm	d102x95mm	1f-d80mm 1f-d25mm
	<b>F1260-I</b> NO. F004-22-540C - G012-22-540A - G033-22-540		
	FOLE DA TRANSMISSÃO JUNTO À CAIXA  MAZDA ETUDE 1.6 (APÓS 1986)		
d92x91mm	1f-d81mm 1f-d22mm		

MAZDA MPV

	<b>F1260-I</b> NO. F004-22-540C - G012-22-540A - G033-22-540		<b>KF3350-T</b> NO. GD45-22-530 - GD45-22530A
	FOLE DA TRANSMISSÃO JUNTO À CAIXA  MAZDA MPV II 2.0i (1999 A 2002)		KIT DE FOLE DO CARDAN JUNTO À RODA  MAZDA MPV 2 2.3i (APÓS 99)
d92x91mm	1f-d81mm 1f-d22mm	d100x125mm	1f-d93mm 1f-d27mm
	<b>KF3480</b> NO. GD46-22-540 - GD46-22-540A - G022-22-530A		
	KIT DE FOLE DO CARDAN JUNTO À RODA  MAZDA MPV II 2.3 141CV (07-2002 A 02-2006)		
d93x98mm	1f-d26mm 1f-d83mm		

MAZDA MX-3-MX-5-MX-6





	<b>E1057</b> NO. K8010061A		<b>E1058</b> NO. KL0140061B - RF0340061
	ESTICADOR DE ESCAPE  MAZDA MX-3 (APÓS 1991) - MX5 (APÓS 1990) - MX6 (APÓS 1991) - XEDOS (ATÉ 6-1992) - 121 (1987 A 1995) - 323 (1980 A 1994) - 323 (1989 A 1994) - 626 8DE 1982 A 1992)		ESTICADOR DE ESCAPE  MAZDA MX-3 (APÓS 1991) - MX5 (APÓS 1990) - MX6 (APÓS 1992) - 323 (APÓS 1985) - 626 (APÓS 1992) - 929 (1984 A 1987)
64x54x25mm	2f-d9mm	65x52x30mm	2f-d9mm
	<b>KF3799-T</b> NO. M090-22-530 - M090-22-530A		<b>M6047</b> NO. B69040305 - 0B6904035A - G50340305 - JF0140305 - JFY140305 - 6162279 - 6642511 - 6692741 - 6692743 - ...
	KIT DE FOLE DO CARDAN JUNTO À RODA  MAZDA MX 5 I 1.6i - 1.6i 16V - 1.8i 16V (1989 A 1998) - MAZDA MX 5 II 1.6i - 1.8i (APÓS 1998)		JUNTA DE ESCAPE  MAZDA MX-3 (APÓS 1991) - MX5 (APÓS 1989) - MX6 (APÓS 1991) - XEDOS (APÓS 1992) - 626 (APÓS 1987)
d85x100mm	1f-d75mm 1f-d22mm	118x80mm	1f-d67mm

	<b>M6106</b>	NO. B32340305		<b>M6107</b>	NO. F20140305 - F20440305 - F2Y440305
	JUNTA DE ESCAPE			JUNTA DE ESCAPE	
	MAZDA MX-3 91-93 - 323 89-94 - 323F 89-94			MAZDA MX-3 91-99 - MX6 91-96 - XEDOS 6 APÓS 92 - 626 91-97	
	140x70x2mm	1f-d57mm		140x80x2mm	1f-d60mm

## MAZDA PROCEED

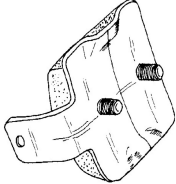
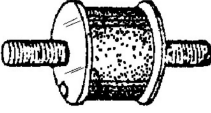
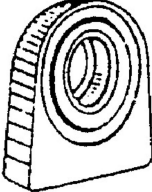
	<b>E0020</b>	NO. 18234-579-000 - 18234-634-940		
	ESTICADOR DE ESCAPE			
	MAZDA PROCEED			
	76x41x41mm	2f-d15mm		

## MAZDA T3000-T3500-T4100

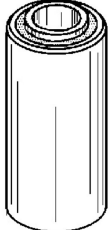
	<b>A0992</b>	NO. W02528360A		<b>A1109</b>	NO. W023-39-340A
	SUPORTE - BATENTE DE MOLA			SUPORTE TRASEIRO DO MOTOR	
	MAZDA T3000 - T3500			MAZDA T3000	
	71x91x49mm	2p-d8-16mm		NULL	NULL
	<b>A1112</b>	NO. W001-25-321		<b>A1241</b>	NO. 8593-25-300
	APOIO DO VEIO DE TRANSMISSÃO			APOIO DO VEIO DA TRANSMISSÃO	
	MAZDA T3000 - T3500			MAZDA T3000	
	NULL	NULL		180x130x59mm	1f-d25mm
	<b>A1242</b>	NO. P030-35-310A - P030-25-310A		<b>A1697</b>	NO. W025-28-320
	APOIO DA TRANSMISSÃO COM ROLAMENTO			APOIO BATENTE DA SUSPENSÃO DE TRÁS	
	MAZDA T3000			MAZDA T3500 - T4100	
	NULL	NULL		130x70x77mm	NULL
	<b>R8120</b>	NO. SL01-15-186 - 0K42115186 - OSL0115186 - K42115186		<b>S1031</b>	NO. 55934330
	TUBO SUPERIOR DO RADIADOR			SILENT-BLOC DA MOLA DA FRENTE E TRÁS	
	MAZDA T3500			MAZDA T3000 - T3500	
	B340-d41/41mm	200-230mm		d33x76mm	c69mm 1f-d16mm

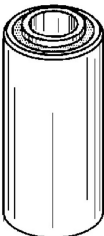
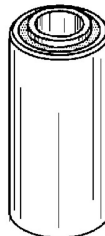
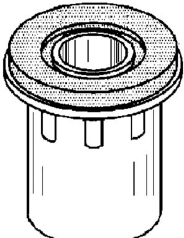
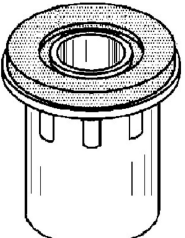
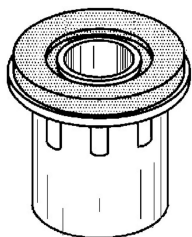
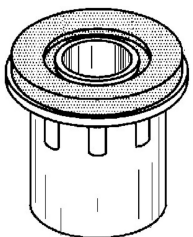

	<b>S1031</b> NO. 55934330		<b>S1031</b> NO. 55934330
	SILENT-BLOC DA MOLA DA FRENTE E TRÁS MAZDA T3000 - T3500		SILENT-BLOC DA MOLA DA FRENTE E TRÁS MAZDA T3000 - T3500
	d33x76mm c69mm 1f-d16mm		d33x76mm c69mm 1f-d16mm
	<b>S1032</b> NO. 68034330 - 0680-34-330		<b>S1032</b> NO. 68034330 - 0680-34-330
	SILENT-BLOC DA MOLA DA FRENTE MAZDA T3000		SILENT-BLOC DA MOLA DA FRENTE MAZDA T3000
	d47.5x43mm d35mm 1f-d17mm		d47.5x43mm d35mm 1f-d17mm
	<b>S1033</b> NO. 68028330		<b>S1033-B</b> NO. 68028330 - 0680-28-330
	SILENT-BLOC DE MOLA TRÁS MAZDA T3500		SILENT-BLOC DE MOLA TRÁS MAZDA T3500
	d52x44mm d38mm 1f-d19mm		d52x44mm d38mm 1f-d19mm

MAZDA TELSTAR-SPECTRON

	<b>F0694-I</b> NO. F004-22-530A - G001-22-530 - G021-22-530A - F004-22-530 - G021-22-530		<b>F1260-I</b> NO. F004-22-540C - G012-22-540A - G033-22-540
	FOLE DO SEMI-EIXO LADO DA RODA MAZDA TELSTAR - SPECTRON - TX5		FOLE DA TRANSMISSÃO JUNTO À CAIXA MAZDA TELSTAR 2.0 (APÓS 1987)
	d90x86mm 1f-d23mm 1f-d79mm		d92x91mm 1f-d81mm 1f-d22mm
	<b>F1328-I</b> NO. B004-22-540 - F006-22-540A - F006-22-540B - F011-22-540 - F057-22-540 - G071-22-540 - ZZS4-22-540		
	FOLE DA TRANSMISSÃO JUNTO À CAIXA MAZDA TELSTAR 1.8 - 2.0 (APÓS 1987)		
	d75x85mm 1f-d64mm 1f-d18mm		

MAZDA TRIBUTE

	<b>KF2271-T</b> NO. GG03-22-530		
	KIT DE FOLE DO CARDAN JUNTO À RODA MAZDA TRIBUTE 2.0i 4WD -3.0i V6 4WD (APÓS 2000)		
	d105x125mm 1f-d83mm 1f-d25mm		

	<b>KF3423-T</b> NO. GU01-22-530		<b>M6008</b> NO. KL1440305
	KIT DE FOLE DO CARDAN JUNTO À RODA MAZDA XEDOS 9 (1993 A 2000) 2.5i 24V		JUNTA DE ESCAPE MAZDA XEDOS 9 (APÓS 1993)
	d92x130mm      1f-d82mm 1f-d26mm		d65x5mm      1f-d50mm