











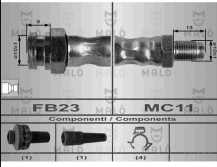



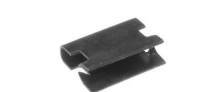







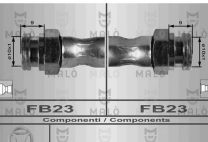
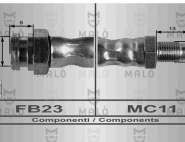
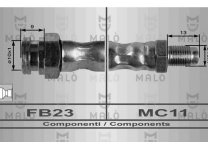
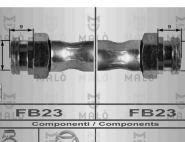
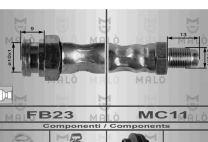
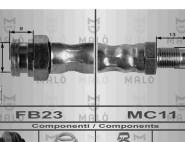

	<p>E0144 NO. 1308664080 - 1317425080</p> <p>ESTICADOR DA BARRA ESTABILIZADORA DA FRENTE</p> <p>LANCIA AUTOBIANCHI ZETA TT</p> <p>120x40x40mm 1p-d12-25mm 1f-d12mm</p>		<p>H671 NO.</p> <p>PALA ORIGINAL LINEACCESSORI</p> <p>LANCIA</p> <p>370x200mm NULL</p>
	<p>RT08415 NO. 7609087 - 7655156</p> <p>TUBO DE TRAVÃO FRENTE LH-RH</p> <p>LANCIA AUTOBIANCHI DELTA II 1.6 - 1.8 (03-1993 A 08-1999) (-ABS)</p> <p>405mm FB23 - MC11</p>		<p>RT08415 NO. 7609087 - 7655156</p> <p>TUBO DE TRAVÃO FRENTE LH-RH</p> <p>LANCIA AUTOBIANCHI-DEDRA 1.6 (-ABS) (02-1993 A 06-1994) (ATÉ CH:4014293) - 1.6 8V (FL 94) (07-1994 A 11-1996) - 1.8 (ATÉ 06-1994) - 1.8 16V(115CV) (11-1995 A 07-1999) - 1.8 8V (FL 94) (07-1994 A 07-1999) - 1.9 TD - 2.0(ATÉ 06-1994) - 2.0 16V (FL 94)</p> <p>405mm FB23 - MC11</p>
	<p>RT08484 NO. 7735010</p> <p>TUBO DE TRAVÃO FRENTE LH</p> <p>LANCIA AUTOBIANCHI - Y 1.2 (16V) 1.4 (APÓS 11-1995)</p> <p>385mm FB23 - MC11</p>		<p>T1095 NO. 7750990</p> <p>BATENTE DA BARRA ESTABILIZADORA DA FRENTE</p> <p>LANCIA AUTOBIANCHI Y 1.1 - 1.2 (8V) - 1.2 (16V) - 1.4 (12V 75CV) - 1.4 (12V 80CV)</p> <p>87x31x34mm NULL</p>
	<p>Z10342 NO. 82312645</p> <p>Mola de painel</p> <p>LANCIA (TODOS)</p> <p>d17x23mm 1p-d8.3-18mm</p>		<p>Z10348 NO. 14587570</p> <p>Mola de painel</p> <p>LANCIA (TODOS)</p> <p>30x14x16.5mm 1p-d8.4-8.5mm</p>
	<p>Z10892 NO. 698681 - 14570180 - 7703079072 - A0009957644</p> <p>Mola de fixação</p> <p>LANCIA (TODOS)</p> <p>22x8.4x26mm 1f-17mm</p>		<p>Z29785 NO. 92061009</p> <p>Mola de fixação</p> <p>LANCIA (TODOS)</p> <p>13x8.5x4.8mm NULL</p>
	<p>Z29787 NO. 14184074</p> <p>Mola de fixação</p> <p>LANCIA (TODOS)</p> <p>13x8.2x4.9mm NULL</p>		<p>Z80340 NO. 14591686 - 14591687 - 17887187</p> <p>Mola de painel</p> <p>LANCIA (TODOS)</p> <p>d15x14.5mm 1p-d8-12.5mm</p>
	<p>Z80353 NO. 14591787 - 17887287</p> <p>Mola de painel</p> <p>LANCIA (TODOS)</p> <p>d15x19mm 1p-d8-17mm</p>		<p>Z80355 NO. 4292906 - 17887787 - 14591487</p> <p>Mola de painel</p> <p>LANCIA (TODOS)</p> <p>d16x19mm 1p-d9.5-17mm</p>
	<p>Z80425 NO. 14592086 - 14592087 - 735284886</p> <p>Mola de painel</p> <p>LANCIA (TODOS)</p> <p>d20x25mm 1p-d8-23mm</p>		<p>Z80479 NO. 14568987</p> <p>Mola de painel</p> <p>LANCIA (TODOS)</p> <p>d24x33mm 1p-d11-29mm</p>

	Z80483 NO. 4484226		Z80518 NO. 14115980 - 155809966 - 6992G2
	Mola de painel LANCIA (TODOS)		Mola de retenção LANCIA (TODOS)
	d18x17mm 1p-d7.5-15mm		d13x9mm 1p-7x7-8mm 1f-d4.8mm
	Z80579 NO. 14569880		Z80631 NO. 14591887
	Mola de fixação LANCIA (TODOS)		Mola de painel LANCIA (TODOS)
	19.6x8x20mm 1f-11mm		d15x25mm 1p-d8-23mm
	Z80645 NO. 7663916		Z80664 NO. 14575380 - 17868880
	Mola de fixação LANCIA (TODOS)		Mola de fixação LANCIA (TODOS)
	16x14x16mm 1p-8x12-14mm 1f-d6.3mm		25x25x13.2mm 1f-8mm
	Z80667 NO. 4264257 - 14215282		
	Mola de retenção LANCIA (TODOS)		
	11x11x9mm 1p-8x8-7.5mm 1f-d3.5mm		

LANCIA BETA

	C0229 NO. 100816 - 4276430		F0822-I NO. 82301070 - 82313445
	BOTÃO DE AFINAÇÃO DO CAPOT (GRANDE) LANCIA BETA (828_) 1300 (828CB3) Local de montagem: à frente 61kW 83CV 1297cc Hatchback (DE 04-76 ATÉ 07-82) LANCIA BETA (828_) 1400 (828AB2) Local de montagem: à frente 66kW 90CV 1438cc Hatchback (DE 08-73 ATÉ 07-76) LANCIA BETA (828_) 1600 (828CB0, 828AB0) Local de montagem: à frente 74kW 101CV 1585cc Hatchback (DE 08-73 ATÉ 07-82) LANCIA BETA (828_) 1800 (828AB1) Local de montagem: à frente 81kW 110CV 1756cc Hatchback (DE 08-73 ATÉ 07-82) etc. INCLUDE 0...etc.		FOLE DA DIREÇÃO ASSISTIDA ESQUERDO E DIREITO LANCIA BETA (TRW RACK)
ESC: 1/2			d67x140mm 1f-d52mm 1f-d39mm
	M6042 NO. 4166914 - 4152873 - 82460789 - 7664668 - 7678282 - 82376425		Z10829 NO. 82326124
	JUNTA DE ESCAPE LANCIA BETA (1974 A 1986)		Mola de friso LANCIA BETA
	115x72mm 2f-d40mm		12x8.6x12mm 1p-d7-8mm

	<p>E192 NO. 51701045 - 46413122 - 46545743 - 60813377</p> <p>ESTICADOR DA BARRA ESTABILIZADORA DA FRENTE</p> <p>LANCIA DEDRA 1.6 16V - 2.0 16V - 1.9TD</p> <p>310x31x36mm 2p-d10-25mm</p>		<p>E1082 NO. 7664624</p> <p>ESTICADOR ESCAPE</p> <p>LANCIA DEDRA (1989 A 1994)</p> <p>60x45x16mm NULL</p>
	<p>E1105-I NO. 48331-0F010</p> <p>ESTICADOR DE ESCAPE</p> <p>LANCIA DEDRA</p> <p>72x58x43mm NULL</p>		<p>E1152-C NO. 60570627 - 12574521 - 7601642 - 7601643</p> <p>ESTICADOR DA BARRA ESTABILIZADORA DA FRENTE</p> <p>LANCIA DEDRA TT</p> <p>120x35x32mm 1f-d12mm</p>
	<p>F0469-I NO. 82282140</p> <p>FOLE DA TRANSMISSÃO LADO DA CAIXA</p> <p>LANCIA DEDRA (EXCEPTO 1.6)</p> <p>d85x80mm 1f-d61mm 1f-d23mm</p>		<p>F0836-I NO. 7635255</p> <p>FOLE DO DIFERENCIAL LADO DA RODA</p> <p>LANCIA DEDRA 1.6 I.E. (APÓS 10-90)</p> <p>d96x103mm 1f-d76mm 1f-d20mm</p>
	<p>F0897-I NO. 82443750 - 82462961</p> <p>FOLE JUNTO À RODA</p> <p>LANCIA DEDRA TDS (ANTISKID) - DEDRA I.E. TURBO 2.0</p> <p>d100x98mm 1f-d86mm 1f-d26mm</p>		<p>F0898F65 NO. 7682886</p> <p>FOLE JUNTO À RODA</p> <p>LANCIA DEDRA 1600 IE ANTISKID (APÓS 1989)</p> <p>d91x80mm 1f-d65mm 1f-d19mm</p>
	<p>F0898F76 NO. 7642776 - 7682886</p> <p>FOLE DO SEMI-EIXO JUNTO À RODA</p> <p>LANCIA DEDRA 1.6 I.E. (ANTISKID)</p> <p>d89x83mm 1f-d76mm 1f-d21mm</p>		<p>F1181-I NO. 7545579</p> <p>FOLE DA DIREÇÃO DIREITO</p> <p>LANCIA DEDRA</p> <p>d63x155mm 1f-d45mm 1f-d10mm</p>
	<p>KF1715 NO. 7635255</p> <p>KIT FOLE DO LADO DA RODA</p> <p>LANCIA DEDRA 1.6 i.e.</p> <p>d92x105mm 1f-d20mm 1f-d75mm</p>		<p>KF1775 NO. 7642776 - 7682886</p> <p>KIT FOLE DO LADO DA RODA</p> <p>LANCIA DEDRA - DEDRA PETROL COM ANTISKID</p> <p>d90x79mm 1f-d21mm 1f-d76mm</p>
	<p>M6028 NO. 82407143</p> <p>JUNTA DE ESCAPE</p> <p>LANCIA DEDRA (1992 A 1994)</p> <p>d57x10mm 1f-d47mm</p>		<p>M6033 NO. 7578742</p> <p>JUNTA DE ESCAPE</p> <p>LANCIA DEDRA (1989 A 1994)</p> <p>85x85mm 1f-d54mm</p>
	<p>M6038 NO. 7664769 - 7646609 - 4147260 - 5891207</p> <p>JUNTA DE ESCAPE</p> <p>LANCIA DEDRA (1989 A 1984)</p> <p>104x76mm 2f-d37mm</p>		<p>M6042 NO. 4166914 - 4152873 - 82460789 - 7664668 - 7678282 - 82376425</p> <p>JUNTA DE ESCAPE</p> <p>LANCIA DEDRA (1989 A 1994)</p> <p>115x72mm 2f-d40mm</p>

	<p>N2331 NO. 7610077 - 4422885</p> <p>ANEL ESCAPE</p> <p>LANCIA DEDRA (1989 A 1994)</p> <p>d58x14mm 1f-d31mm</p>		<p>P1076 NO. 7961080</p> <p>CAPA DE PEDAL DO TRAVÃO E EMBRAIAGEM</p> <p>LANCIA DEDRA 1.6 IE (835AN) (04-1993 A 07-1999) 75CV 1581CC - LANCIA DEDRA 1.6 LE (835EB) CAT (07-1994 A 07-1999) 90CV 1581CC - LANCIA DEDRA 1.6 16V (835EI) (01-1996 07-1999) 103CV 1581CC - LANCIA DEDRA 1.8 16V LE (835FG) (03-1996 A 07-1999) 113CV 1747CC</p> <p>80x60x10mm NULL</p>
	<p>RT08417 NO. 7667806 - 71736920</p> <p>TUBO DE TRAVÃO TRÁS LH-RH</p> <p>LANCIA DEDRA 1.6 (ATÉ 06-1994) - 1.6 16V (01-1996 A 07-1999) - 1.6 8V (FL 1994) (07-1994 A 11-1996) - 1.8 (ATÉ 06-1994) - 1.8 16V (115 CV) (11-1995 A 07-1999) - 1.8 8V (FL 1994) (07-1994 A 07-1999) - 1.9TD - (ATÉ 06-1994) - 1.9 TD (FL 1994) (07-1994 A 07-1)</p> <p>240mm FB23 - FB23</p>		<p>RT08459 NO. 7586907</p> <p>TUBO DE TRAVÃO TRÁS LH-RH</p> <p>LANCIA DEDRA 1.6 16V (01-1996 A 07-1999) - 1.6 i.e (08-1989 A 07-1999) - 1.6 LE Cat.(07-1994 A 07-1999) - 1.8 16V LE (03-1996 A 07-1999) - 1.8 GT 16V (03-1996 A 07-1999) - 1.8 i.e. (09-1989 A 07-1999) - 1.9 TDS (04-1989 A 07-1999) - 2.0 16V (07-1994 A 07-)</p> <p>182mm FB23 - MC11</p>
	<p>RT08459 NO. 7583907</p> <p>TUBO DE TRAVÃO TRÁS LH-RH</p> <p>LANCIA DEDRA W 1.6 (10-1994 A 07-1999) - 1.6 16V (01-1996 A 07-1999) - 1.8 16V LE (03-1996 A 07-1999) - 1.8 GT 16V (03-1996 A 07-1999) - 1.8 i.e. (07-1994 A 07-1999) - 1.9 TDS (07-1994 A 07-1999) - 2.0 INTEGRALE (07-1994 A 07-1999) - 2.0 16V (07-1994 A 07-)</p> <p>182mm FB23 - MC11</p>		<p>RT08486 NO. 7670215</p> <p>TUBO DE TRAVÃO TRÁS LH-RH (COM ABS)</p> <p>LANCIA DEDRA 1.6iE - 1.8iE - 1.8 16V - 1.8 GT 16V - 1.9 TDS - 2.0iE - 2.0 16V (1989 A 1999)</p> <p>245mm FB23 - FB23</p>
	<p>RT08552 NO. 7674977</p> <p>TUBO DE TRAVÃO FRENTE RH</p> <p>LANCIA DEDRA 1.8 16V (115 CV) (11-1995 A 07-1999)</p> <p>415mm FB23 - MC11</p>		<p>RT08553 NO. 46421965 - 46448592 - 46448593 - 71736969 - 46448592</p> <p>TUBO DE TRAVÃO FRENTE LH-RH</p> <p>LANCIA DEDRA 1.6 16V (01-1996 A 07-1999) - SW 1.6 16V (01-1996 A 07-1999)</p> <p>435mm FB23 - MC11</p>
	<p>S1161D20 NO. 7601065</p> <p>SILENT-BLOC CENTRAL DO BRAÇO DA SUSPENSÃO DIANTEIRO (DIREITO)</p> <p>LANCIA DEDRA 1.6 i.e. 75CV (04-1993 A 07-1999) - 1.6 i.e. 90CV (08-1989 A 06-1994) - 1.6 16V 103CV (01-1996 A 07-1999) - 1.8 GT 16V 131CV (03-1996 A 07-1999) - 1.8 i.e. 90CV (08-1993 A 07-1999) - 1.8 i.e. 105CV (09-1989 A 07-1999) - 1.8 i.e. 109CV (09-198)</p> <p>120x60x50mm 1f-d20mm 2r-d10mm</p>		<p>S1161D21 NO. 60603027</p> <p>SILENT-BLOC CENTRAL DO BRAÇO DA SUSPENSÃO DIANTEIRO (DIREITO)</p> <p>LANCIA DEDRA 1.6 i.e. 75CV (04-1993 A 07-1999) - 1.6 i.e. 90CV (08-1989 A 06-1994) - 1.6 16V 103CV (01-1996 A 07-1999) - 1.8 GT 16V 131CV (03-1996 A 07-1999) - 1.8 i.e. 90CV (08-1993 A 07-1999) - 1.8 i.e. 105CV (09-1989 A 07-1999) - 1.8 i.e. 109CV (09-198)</p> <p>120x60x50mm 1f-d21mm 2r-d10mm</p>
	<p>S1162E20 NO. 7601068</p> <p>SILENT-BLOC CENTRAL DO BRAÇO DA SUSPENSÃO DIANTEIRO(ESQUERDO)</p> <p>LANCIA DEDRA 1.6 i.e. 75CV (04-1993 A 07-1999) - 1.6 i.e. 90CV (08-1989 A 06-1994) - 1.6 16V 103CV (01-1996 A 07-1999) - 1.8 GT 16V 131CV (03-1996 A 07-1999) - 1.8 i.e. 90CV (08-1993 A 07-1999) - 1.8 i.e. 105CV (09-1989 A 07-1999) - 1.8 i.e. 109CV (09-198)</p> <p>120x60x50mm 1f-d20mm 2r-d10mm</p>		<p>S1162E21 NO. 60603028</p> <p>SILENT-BLOC CENTRAL DO BRAÇO DA SUSPENSÃO DIANTEIRO(ESQUERDO)</p> <p>LANCIA DEDRA 1.6 i.e. 75CV (04-1993 A 07-1999) - 1.6 i.e. 90CV (08-1989 A 06-1994) - 1.6 16V 103CV (01-1996 A 07-1999) - 1.8 GT 16V 131CV (03-1996 A 07-1999) - 1.8 i.e. 90CV (08-1993 A 07-1999) - 1.8 i.e. 105CV (09-1989 A 07-1999) - 1.8 i.e. 109CV (09-198)</p> <p>120x60x50mm 1f-d21mm 2r-d10mm</p>
	<p>S1189F20 NO. 7601064</p> <p>SILENT-BLOC CENTRAL DO BRAÇO DA SUSPENSÃO DIANTEIRO</p> <p>LANCIA DEDRA 1.6 i.e. 75CV (04-1993 A 07-1999) - 1.6 i.e. 90CV (08-1989 A 06-1994) - 1.6 16V 103CV (01-1996 A 07-1999) - 1.8 GT 16V 131CV (03-1996 A 07-1999) - 1.8 i.e. 90CV (08-1993 A 07-1999) - 1.8 i.e. 105CV (09-1989 A 07-1999) - 1.8 i.e. 109CV (09-198)</p> <p>100x51x46mm 1f-d20mm 2r-d10mm</p>		<p>S1189F21 NO.</p> <p>SILENT-BLOC CENTRAL DO BRAÇO DA SUSPENSÃO DIANTEIRO</p> <p>LANCIA DEDRA 1.6 i.e. 75CV (04-1993 A 07-1999) - 1.6 i.e. 90CV (08-1989 A 06-1994) - 1.6 16V 103CV (01-1996 A 07-1999) - 1.8 GT 16V 131CV (03-1996 A 07-1999) - 1.8 i.e. 90CV (08-1993 A 07-1999) - 1.8 i.e. 105CV (09-1989 A 07-1999) - 1.8 i.e. 109CV (09-198)</p> <p>100x51x46mm 1f-d21mm 2r-d10mm</p>
	<p>T0647-I NO. 7588036</p> <p>BATENTE SUSPENSÃO DA FRENTE</p> <p>LANCIA DEDRA (835_) 1.6 i.e. (835AN) (04.93 A 07.99) 75cv 1581cc três volumes - LANCIA DEDRA (835_) 1.6 i.e. (835AB) (08.89 A 03.93) 78cv 1581cc três volumes - LANCIA DEDRA (835_) 1.6 i.e. (835AA) (08.89 A 06.94) 90cv 1581cc três volumes - LANCIA DEDRA (835_) 1.6 LE Cat (835EB) (07.94 A 07.99) 90cv 1581cc três volumes - LANCIA DEDRA (835_) 1.8 16V LE (835FG) (03.96 A 07.99) 113cv 1747cc três volumes - LANCIA DEDRA (835_) 1.8 i.e. (835AT...etc.</p> <p>d56x104mm 1f-d27mm 1f-d21mm</p>		<p>T1025 NO. 7635714</p> <p>BATENTE DA BARRA ESTABILIZADORA</p> <p>LANCIA DEDRA 1.6 IE</p> <p>60x46x40mm 1f-d20mm</p>

	<p>Z80350 NO. 4294167</p> <p>Mola de friso</p> <p>LANCIA DEDRA</p> <p>NULL NULL</p>		<p>Z80447 NO. 14211880</p> <p>Mola de fixação</p> <p>LANCIA DEDRA</p> <p>15.5x15.5x12.5mm 1p-10x10-9.5mm 1f-d5mm</p>
	<p>Z80586 NO. 82448727</p> <p>Mola de fixação</p> <p>LANCIA DEDRA</p> <p>d12.8x22.5mm 1p-d6.5-8.5mm</p>		<p>Z80588 NO. 7637466</p> <p>Mola de painel</p> <p>LANCIA DEDRA</p> <p>d24x16.5mm 1p-d16.5-14mm</p>
	<p>Z80612 NO. 7569468</p> <p>Mola de fixação</p> <p>LANCIA DEDRA</p> <p>d10x33.7mm 1p-d6-18.5mm</p>		<p>Z80625 NO. 82421028 - 504056662</p> <p>Mola de fixação</p> <p>LANCIA DEDRA</p> <p>d18x42.5mm 1p-d8-19mm</p>
	<p>Z80638 NO. 7638283</p> <p>Mola de painel</p> <p>LANCIA DEDRA</p> <p>d25x19.5mm 1p-d8-17mm</p>		<p>Z80646 NO. 7578051</p> <p>Mola de fixação</p> <p>LANCIA DEDRA</p> <p>13x17.8x15mm 1p-9x14-14mm 1f-d5.5mm</p>
	<p>Z80651 NO. 82426359</p> <p>Mola de fixação</p> <p>LANCIA DEDRA</p> <p>d18x42mm 1p-d10-19mm</p>		<p>Z80653 NO. 14211580</p> <p>Mola de fixação</p> <p>LANCIA DEDRA</p> <p>9x9x10mm 1p-7x7-9mm 1f-d4.2mm</p>
	<p>Z80654 NO. 7556533</p> <p>Mola de fixação</p> <p>LANCIA DEDRA</p> <p>d12.8x28mm 1p-d6.2-11.5mm</p>		<p>Z80703 NO. 5988006</p> <p>Mola de fixação</p> <p>LANCIA DEDRA</p> <p>d15x24mm 1p-d6.5-12mm</p>
	<p>Z80708 NO. 7630854</p> <p>Mola de fixação</p> <p>LANCIA DEDRA</p> <p>d15x8.2mm 1p-6x6-6.6mm 1f-d4.8mm</p>		<p>Z80744 NO. 83468473</p> <p>Mola de fixação</p> <p>LANCIA DEDRA</p> <p>12.5x12.5x19.2mm 1p-9.5x9.5-18mm 1f-d6.3mm</p>

	<p>E0018 NO.</p> <p>ESTICADOR DE ESCAPE</p> <p>LANCIA DELTA TT</p> <p>68x54x25mm NULL</p>		<p>E1009 NO. 82347855</p> <p>ESTICADOR DE ESCAPE</p> <p>LANCIA DELTA (1979 A 1983)</p> <p>83x48x24mm 2f-d12mm</p>
	<p>E1082 NO. 7664624</p> <p>ESTICADOR ESCAPE</p> <p>LANCIA DELTA (APÓS 1993)</p> <p>60x45x16mm NULL</p>		<p>E1152-C NO. 60570627 - 12574521 - 7601642 - 7601643</p> <p>ESTICADOR DA BARRA ESTABILIZADORA DA FRENTE</p> <p>LANCIA DELTA II TT</p> <p>120x35x32mm 1f-d12mm</p>
	<p>F0057-I NO. 4294117</p> <p>FOLE DO DIFERENCIAL LADO DA CAIXA (F1012)</p> <p>LANCIA DELTA 1300 - 1500 (ATÉ 11-82)</p> <p>d95x85mm 1f-d65mm 1f-d23mm</p>		<p>F0060-I NO. 4239459 - 4371156</p> <p>FOLE DA CREMALHEIRA DA DIRECÇÃO DIREITO (F1038)</p> <p>LANCIA DELTA (DO Nº 293229 A 5-86) - DELTA R-86 1.3 - 1.5 (APÓS 5-87)</p> <p>d59x180mm d47mm 1f-d1f-d26mm 1f-d10mm</p>
	<p>F0061-I NO. 4371155</p> <p>FOLE DA CREMALHEIRA DA DIRECÇÃO ESQUERDO</p> <p>LANCIA DELTA (DO Nº 293229 A 5-86) - DELTA R-86 1.3 - 1.5 (APÓS 5-87) - PRISMA TT (ATÉ 6-86) - THEMA (COM DIR. ASSISTIDA)</p> <p>d59x118mm 1f-d41mm 1f-d10mm</p>		<p>F0388-I NO. 4315444</p> <p>FOLE DO DIFERENCIAL</p> <p>LANCIA DELTA 1.5 - 1.6 - TDS (ATÉ 6-88) - DELTA 2.0 4wd (FRONT) (APÓS 11-87)</p> <p>d77x85mm 1f-d62mm 1f-d24mm</p>
	<p>F0389-I NO. 4433969</p> <p>FOLE DO DIFERENCIAL LADO DA RODA</p> <p>LANCIA DELTA 1.5 - R-86 TDS (ATÉ 8-86)</p> <p>d90x82mm 1f-d76mm 1f-22mm</p>		<p>F0403-I NO. 4383758 - 7501348</p> <p>FOLE DO DIFERENCIAL LADO RODA</p> <p>LANCIA DELTA 1.3 (ATÉ 2-85)</p> <p>d80x80mm 1f-d70mm 1f-d20mm</p>
	<p>F0468-I NO. 92601216</p> <p>FOLE ESQUERDO E DIREITO DO DIFERENCIAL COM CASQUILHO EM NYLON (APENAS DIREITO NOS MODELOS R-86)</p> <p>LANCIA DELTA 1.3 - 1.5 (APÓS 12-82) - DELTA R-86 1.3 (ATÉ 10-87)</p> <p>d95x70mm 1f-d63mm 1f-d23mm</p>		<p>F0468B-I NO. 92601255</p> <p>FOLE DO DIFERENCIAL SEMI-EIXO ESQUERDO COM CASQUILHO EM NYLON</p> <p>LANCIA DELTA 1.5 (3-85 A 2-86)</p> <p>d95x73mm 1f-d71mm 1f-d23mm</p>
	<p>F0469-I NO. 82282140</p> <p>FOLE DA TRANSMISSÃO LADO DA CAIXA</p> <p>LANCIA DELTA R-86 1.5 - 1.6 - TDS - 2.0 4WD (APÓS 7-1988) - 2.0 (APÓS 1994)</p> <p>d85x80mm 1f-d61mm 1f-d23mm</p>		<p>F0514-I NO. 5987092</p> <p>FOLE DO SEMI-EIXO JUNTO À RODA</p> <p>LANCIA DELTA R-86 1.3 (ATÉ 6-88)</p> <p>d86x82mm 1f-d71mm 1f-d20mm</p>
	<p>F0787-I NO. 92601366</p> <p>FOLE JUNTO À CAIXA</p> <p>LANCIA DELTA R-86 1.3 (3-1986 A 9-1987)</p> <p>d94x76mm 1f-d80mm 1f-d22mm</p>		<p>F0834-I NO. 7621245</p> <p>FOLE DO DIFERENCIAL SEMI-EIXO DIREITO</p> <p>LANCIA DELTA R-86 1.3 (APÓS 10-87)</p> <p>d91x82mm 1f-d65mm 1f-d32mm</p>







	<p>F0834A-I NO. 7621245</p> <p>FOLE DO DIFERENCIAL SEMI-EIXO DIREITO COM ROLAMENTO d23mm LANCIA DELTA R-86 1.3 (APÓS 10-87)</p> <p>d93x90mm 1f-d23mm</p>		<p>F0835-I NO. 7625541</p> <p>FOLE ESQUERDO DO DIFERENCIAL LADO CAIXA</p> <p>LANCIA DELTA R-86 1.3 (APÓS 10-87) - NOVO DELTA 1.4 - 1.6 (APÓS 1994)</p> <p>d90x85mm 1f-d77mm 1f-d22.8mm</p>
	<p>F0835A-I NO. 7625541</p> <p>FOLE ESQUERDO DO DIFERENCIAL LADO CAIXA COM ROLAMENTO LANCIA DELTA R-86 1.3 (APÓS 10-87) - NOVO DELTA 1.4 - 1.6 (APÓS 1994)</p> <p>d90x85mm 1f-d77mm 1f-d22.8mm</p>		<p>F0835A5I NO. 46307071 - 46307436 - 46307503 - 46307784 - 60813077</p> <p>FOLE DA TRANSMISSÃO JUNTO À CAIXA</p> <p>LANCIA DELTA II 1.4 ie (10-94 A 08-99) - 1.6 i e (06-96 A 08-99) - 1.6 ie 16V (01-96 A 08-99) - 1.8 ie (07-94 A 08-99)</p> <p>d93x87mm 1f-d79mm 1f-d24.4mm</p>
	<p>F0897-I NO. 82443750 - 82462961</p> <p>FOLE JUNTO À RODA</p> <p>LANCIA NOVO DELTA 1.8 (APÓS 1994) - K2000 - 2400 (APÓS 1995)</p> <p>d100x98mm 1f-d86mm 1f-d26mm</p>		<p>F0897-I NO. 82443750 - 82462961</p> <p>FOLE JUNTO À RODA</p> <p>LANCIA DELTA I.E. TURBO (APÓS 1995) - DELTA R-86 1.6 - 2.0 TURBO (APÓS 7-1988)</p> <p>d100x98mm 1f-d86mm 1f-d26mm</p>
	<p>F0898F65 NO. 7682886</p> <p>FOLE JUNTO À RODA</p> <p>LANCIA DELTA R86 1300 (APÓS 7-88)</p> <p>d91x80mm 1f-d65mm 1f-d19mm</p>		<p>F0898F76 NO. 7642776 - 7682886</p> <p>FOLE DO SEMI-EIXO JUNTO À RODA</p> <p>LANCIA DELTA - R-86 1.3 (APÓS 7-88) - NOVO DELTA 1.4 - 1.6 (APÓS 1994)</p> <p>d89x83mm 1f-d76mm 1f-d21mm</p>
	<p>F0903-I NO. 82443745 - 82463084</p> <p>FOLE DO DIFERENCIAL LADO DA RODA</p> <p>LANCIA DELTA R-86 1.5 - 1.6 I.E. TDS</p> <p>d90x82mm 1f-d76mm 1f-d25mm</p>		<p>F1127H-I NO. 7645160</p> <p>FOLE DA DIRECÇÃO ESQUERDO E DIREITO (DIRECÇÃO ASSISTIDA)</p> <p>LANCIA NOVO DELTA 1.4 - 1.6 - 1.8 (APÓS 1994)</p> <p>d62x210mm 1f-d58mm 1f-d10mm</p>
	<p>F1138H-I NO. 7761570 - 46307555 - 46429633 - 82483204 - 46307067 - 46307575 - 60813074 - 60813077 - 46307060</p> <p>FOLE DA TRANSMISSÃO JUNTO À RODA</p> <p>LANCIA DELTA 1.4-1.6 SEM ABS (APÓS 1994)</p> <p>d92x88mm 1f-d80mm 1f-d23mm</p>		<p>F1175-I NO. 7545579 - 7602437 - 7645160 - 7664428</p> <p>FOLE DA DIRECÇÃO LADO DIREITO</p> <p>LANCIA DELTA I 1.3 - 1.5 - 1.6 GT - 1.6 HF TURBO - 1.6 i.e GT (1979 A 1994)</p> <p>d63x180mm 1f-d45mm 1f-d10mm</p>
	<p>F1181-I NO. 7545579</p> <p>FOLE DA DIRECÇÃO ESQUERDO E DIREITO</p> <p>LANCIA NOVO DELTA 1.4 - 1.6 - 1.8 (APÓS 1994)</p> <p>d63x155mm 1f-d45mm 1f-d10mm</p>		<p>F1666-I NO.</p> <p>FOLE DIRECÇÃO ASSISTIDA LADO ESQUERDO E DIREITO</p> <p>LANCIA DELTA</p> <p>d64x165mm 1f-d46mm 1f-d10mm</p>
	<p>F1822-I NO. 4315444 - 46307029</p> <p>FOLE DA TRANSMISSÃO JUNTO À CAIXA</p> <p>LANCIA DELTA I 1.5 - 1.8 i.e. - 1.8 i.e. 16V - 1.8 i.e. GT 16V - 1.9TD - 2.0i 16V - 2.0iT 16V (79 A 94)</p> <p>d102x94mm 1f-d99mm 1f-d25mm</p>		<p>F1910-T NO. 40308383 - 46308480 - 1607740880 - LR003160 - 39242EB30B - C9241EB30A</p> <p>FOLE DO EIXO DE TRANSMISSÃO LADO DA RODA</p> <p>LANCIA DELTA III (844_) 1.8 (01.09 A 08.14) 200cv 1742cc Hatchback - LANCIA DELTA III (844_) 1.9 D Multijet (01.09 A 08.14) 190cv 1910cc Hatchback - LANCIA DELTA III (844_) 2.0 D Multijet (09.08 A 08.14) 165cv 1956cc Hatchback</p> <p>d120x150mm 1f-d28mm 1f-d100mm</p>

	<p>F9052H-I NO. 46308465</p> <p>FOLE DO CARDAN LADO DA RODA</p> <p>LANCIA DELTA III (844) 1.6 D Multijet (198 A2.000) 120CV (APÓS 09-2008)</p> <p>d105x125mm 1f-d28mm 1f-d88mm</p>		<p>KF1730 NO. 5966569 - 5987092</p> <p>KIT FOLE DO LADO DA RODA</p> <p>LANCIA DELTA</p> <p>d82x80mm 1f-d20mm 1f-d68mm</p>
	<p>KF1775 NO. 7642776 - 7682886</p> <p>KIT FOLE DO LADO DA RODA</p> <p>LANCIA DELTA</p> <p>d90x79mm 1f-d21mm 1f-d76mm</p>		<p>L0419-I NO. 4330731</p> <p>CASQUILHO DE NYLON CREMALHEIRA DA DIRECÇÃO</p> <p>LANCIA DELTA</p> <p>28x28x18mm 1f-d21mm</p>
	<p>M6028 NO. 82407143</p> <p>JUNTA DE ESCAPE</p> <p>LANCIA DELTA (1987 A 1995)</p> <p>d57x10mm 1f-d47mm</p>		<p>M6033 NO. 7578742</p> <p>JUNTA DE ESCAPE</p> <p>LANCIA DELTA (1993 A 1995)</p> <p>85x85mm 1f-d54mm</p>
	<p>M6038 NO. 7664769 - 7646609 - 4147260 - 5891207</p> <p>JUNTA DE ESCAPE</p> <p>LANCIA DELTA (1979 A 1996)</p> <p>104x76mm 2f-d37mm</p>		<p>M6042 NO. 4166914 - 4152873 - 82460789 - 7664668 - 7678282 - 82376425</p> <p>JUNTA DE ESCAPE</p> <p>LANCIA DELTA (1982 A 1995)</p> <p>115x72mm 2f-d40mm</p>
	<p>N2331 NO. 7610077 - 4422885</p> <p>ANEL ESCAPE</p> <p>LANCIA DELTA (APÓS 1993)</p> <p>d58x14mm 1f-d31mm</p>		<p>P1076 NO. 7961080</p> <p>CAPA DE PEDAL DO TRAVÃO E EMBRAIAGEM</p> <p>LANCIA DELTA II 1.4 IE (836AF 836AH) (10-1994 A 08-1999) 69CV 1372CC - LANCIA DELTA II 1.6 IE (836AD) (06-1993 A 08-1999) 75CV 1581CC - LANCIA DELTA II 1.6 IE (836AP) (03-1996 A 08-1999) 90CV 1581CC - LANCIA DELTA II 1.6 IE 16V (836AO) (01-1996 A 08-1999)</p> <p>80x60x10mm NULL</p>
	<p>RT08417 NO. 7667806 - 71736920</p> <p>TUBO DE TRAVÃO TRÁS LH-RH</p> <p>LANCIA DELTA II 1.6 (03-1993 A 08-1999) - 1.6 16V (01-1996 A 08-1999) - 1.8 (03-1993 A 08-1999) - 1.8 16V (115 CV) (03-1996 A 08-1999) - 1.8 16V (132CV) (03-1996 A 08-1999) - 1.9 TD - 2.0 16V TURBO (03-1993 A 08-1999)</p> <p>240mm FB23 - FB23</p>		<p>RT08459 NO. 7586907</p> <p>TUBO DE TRAVÃO TRÁS LH-RH</p> <p>LANCIA DELTA II 1.6 i.e (03-1996 A 08-1999) - 1.6 i.e.16V (01-1996 A 08-1999) - 1.8 i.e. (06-1993 A 08-1999) - 1.8 i.e.16V (03-1996 A 08-1999) - 1.8 i.e. 16V GT (03-1996 A 08-1999) - 1.9 TD (10-1994 A 08-1999) - 2.0 16V (06-1993 A 08-1999) - 2.0 16V TURBO</p> <p>182mm FB23 - MC11</p>
	<p>RT08486 NO. 7670215</p> <p>TUBO DE TRAVÃO TRÁS LH-RH (COM ABS)</p> <p>LANCIA DELTA II 1.4iE - 1.6iE - 1.6iE 16V - 1.8iE - 1.8iE 16V - 1.8iE 16V GT - 1.9TD - 2.0 16V (1993 A 1999)</p> <p>245mm FB23 - FB23</p>		<p>RT08552 NO. 7674977</p> <p>TUBO DE TRAVÃO FRENTE LH-RH</p> <p>LANCIA DELTA II 1.6 16V (01-1996 A 08-1999) - 1.8 16V (115 CV) (03-1996 A 08-1999)</p> <p>415mm FB23 - MC11</p>
	<p>RT08553 NO. 46421965 - 46448592 - 46448593 - 71736969 - 46448592</p> <p>TUBO DE TRAVÃO FRENTE LH-RH</p> <p>LANCIA DELTA II 1.8 i.e. 16V GT (03-1996 A 08-1999) - DELTA II 2.0 16V TURBO (07-1996 A 08-1999)</p> <p>435mm FB23 - MC11</p>		<p>S1161D20 NO. 7601065</p> <p>SILENT- BLOC CENTRAL DO BRAÇO DA SUSPENSÃO DIANTEIRO (DIREITO)</p> <p>LANCIA DELTA II 1.4 i.e.69CV (10-1994 A 08-1999) - 1.6 i.e.75CV (06-1993 A 08-1999) - 1.6 i.e. 90CV (03-1996 A 08-1999) - 1.6 i.e. 16V 103CV (01-1996 A 08-1999) - 1.8 i.e. 16V 113CV (03-1996 A 08-1999) - 1.8 i.e. 16V GT 131CV (03-1996 A 08-1999) - 1.8 i.e</p> <p>120x60x50mm 1f-d20mm 2r-d10mm</p>

	<p>S1161D21 NO. 60603027</p> <p>SILENT-BLOC CENTRAL DO BRAÇO DA SUSPENSÃO DIANTEIRO (DIREITO)</p> <p>LANCIA DELTA II 1.4 i.e.69CV (10-1994 A 08-1999) - 1.6 i.e.75CV (06-1993 A 08-1999) - 1.6 i.e. 90CV (03-1996 A 08-1999) - 1.6 i.e. 16V 103CV (01-1996 A 08-1999) - 1.8 i.e. 16V 113CV (03-1996 A 08-1999) - 1.8 i.e. 16V GT 131CV (03-1996 A 08-1999) - 1.8 i.e</p> <p>120x60x50mm 1f-d21mm 2r-d10mm</p>		<p>S1162E20 NO. 7601068</p> <p>SILENT- BLOC CENTRAL DO BRAÇO DA SUSPENSÃO DIANTEIRO(ESQUERDO)</p> <p>LANCIA DELTA II 1.4 i.e.69CV (10-1994 A 08-1999) - 1.6 i.e.75CV (06-1993 A 08-1999) - 1.6 i.e. 90CV (03-1996 A 08-1999) - 1.6 i.e. 16V 103CV (01-1996 A 08-1999) - 1.8 i.e. 16V 113CV (03-1996 A 08-1999) - 1.8 i.e. 16V GT 131CV (03-1996 A 08-1999) - 1.8 i.e</p> <p>120x60x50mm 1f-d20mm 2r-d10mm</p>
	<p>S1162E21 NO. 60603028</p> <p>SILENT- BLOC CENTRAL DO BRAÇO DA SUSPENSÃO DIANTEIRO(ESQUERDO)</p> <p>LANCIA DELTA II 1.4 i.e.69CV (10-1994 A 08-1999) - 1.6 i.e.75CV (06-1993 A 08-1999) - 1.6 i.e. 90CV (03-1996 A 08-1999) - 1.6 i.e. 16V 103CV (01-1996 A 08-1999) - 1.8 i.e. 16V 113CV (03-1996 A 08-1999) - 1.8 i.e. 16V GT 131CV (03-1996 A 08-1999) - 1.8 i.e</p> <p>120x60x50mm 1f-d21mm 2r-d10mm</p>		<p>S1189F20 NO. 7601064</p> <p>SILENT- BLOC CENTRAL DO BRAÇO DA SUSPENSÃO DIANTEIRO</p> <p>LANCIA DELTA II 1.4 i.e.69CV (10-1994 A 08-1999) - 1.6 i.e.75CV (06-1993 A 08-1999) - 1.6 i.e. 90CV (03-1996 A 08-1999) - 1.6 i.e. 16V 103CV (01-1996 A 08-1999) - 1.8 i.e. 16V 113CV (03-1996 A 08-1999) - 1.8 i.e. 16V GT 131CV (03-1996 A 08-1999) - 1.8 i.e</p> <p>100x51x46mm 1f-d20mm 2r-d10mm</p>
	<p>S1189F21 NO.</p> <p>SILENT- BLOC CENTRAL DO BRAÇO DA SUSPENSÃO DIANTEIRO</p> <p>LANCIA DELTA II 1.4 i.e.69CV (10-1994 A 08-1999) - 1.6 i.e.75CV (06-1993 A 08-1999) - 1.6 i.e. 90CV (03-1996 A 08-1999) - 1.6 i.e. 16V 103CV (01-1996 A 08-1999) - 1.8 i.e. 16V 113CV (03-1996 A 08-1999) - 1.8 i.e. 16V GT 131CV (03-1996 A 08-1999) - 1.8 i.e</p> <p>100x51x46mm 1f-d21mm 2r-d10mm</p>		<p>S1584 NO. 82337597 - 82379625 - 82403643</p> <p>SILENT BLOC DO BRAÇO DA SUSPENSÃO DE TRÁS</p> <p>LANCIA DELTA I (831_) 1.3 (831AB.011) (09.79 A 08.92) 75cv 1301cc Hatchback - LANCIA DELTA I (831_) 1.3 (09.83 A 08.92) 79cv 1301cc Hatchback - LANCIA DELTA I (831_) 1.5 (831AB.025) (09.79 A 12.92) 86cv 1498cc Hatchback</p> <p>d30x30mm c22mm 1f-d10mm</p>
	<p>S1595 NO. 50511650 - 50521486 - 51783056 - 51783057</p> <p>SILENT-BLOC BRAÇO SUPERIOR FRENTE</p> <p>LANCIA DELTA III (844_) 1.4 (09.08 A 08.14) 120cv 1368cc Hatchback - LANCIA DELTA III (844_) 1.4 16V (07.10 A 08.14) 140cv 1368cc Hatchback - LANCIA DELTA III (844_) 1.4 (09.08 A 08.14) 150cv 1368cc Hatchback - LANCIA DELTA III (844_) 1.8 (01.09 A 08.14) 200cv 1742cc Hatchback - LANCIA DELTA III (844_) 1.6 D Multijet (09.08 A 08.14) 120cv 1598cc Hatchback - LANCIA DELTA III (844_) 1.9 D Multijet (01.09 A 08.14) 190cv 1910cc Hatchback -...etc.</p> <p>d53x67mm d41mm 1f-d14mm</p>		<p>T0647-I NO. 7588036</p> <p>BATENTE SUSPENSÃO DA FRENTE</p> <p>LANCIA DELTA II (836_) 1.4 i.e. (836AF - 836AH) (10.94 A 08.99) 69cv 1372cc Hatchback - LANCIA DELTA II (836_) 1.6 i.e. (836AD) (06.93 A 08.99) 75cv 1581cc Hatchback - LANCIA DELTA II (836_) 1.6 i.e. (836AP) (03.96 A 08.99) 90cv 1581cc Hatchback - LANCIA DELTA II (836_) 1.6 i.e. 16V (836AO) (01.96 A 08.99) 103cv 1581cc Hatchback - LANCIA DELTA II (836_) 1.8 i.e. 16V (836AQ) (03.96 A 08.99) 113cv 1747cc Hatchback - LANCIA DELTA II (836_) 1.8 ...etc.</p> <p>d56x104mm 1f-d27mm 1f-d21mm</p>
	<p>W5145 NO. 55210310 - 0614359 - 614359 - 93192547</p> <p>POLIE DA CAMBOTA 6 PISTAS</p> <p>LANCIA DELTA III (844_) 1.6 D Multijet Código do motor: 844A3.000 (04.11 A 08.14) 105cv 1598cc Hatchback - LANCIA DELTA III (844_) 1.6 D Multijet (08.08 A 08.14) 116cv 1598cc Hatchback - LANCIA DELTA III (844_) 1.6 D Multijet N.º chas. a partir de: 1063140 - Código do motor: 198A2.000 - Código do motor: 198A2.000/F - Código do motor: 955A4.000 - Código do motor: 955A4.000/F (09.08 A 08.14) 120cv 1598cc Hatchback - LANCIA DELTA III (844_)...etc.</p> <p>d169mm d30,5mm</p>		<p>Z80502 NO. 5757553</p> <p>Mola de retenção</p> <p>LANCIA DELTA</p> <p>d16x9,5mm 1p-7x7-8,5mm 1f-d4,8mm</p>
	<p>Z80578 NO. 14569580 - 14569680</p> <p>Mola de fixação</p> <p>LANCIA DELTA</p> <p>20x8x15mm 1f-8mm</p>		<p>Z80588 NO. 7637466</p> <p>Mola de painel</p> <p>LANCIA DELTA</p> <p>d24x16,5mm 1p-d16,5-14mm</p>
	<p>Z80590 NO. 14569187</p> <p>Mola de painel</p> <p>LANCIA DELTA</p> <p>d22x22,5mm 1p-d10,4-20mm</p>		<p>Z80604 NO. 7739801 - 500382985</p> <p>Mola de painel</p> <p>LANCIA DELTA</p> <p>d18,2x21,6mm 1p-d6,4-16,1mm</p>
	<p>Z80612 NO. 7569468</p> <p>Mola de fixação</p> <p>LANCIA DELTA</p> <p>d10x33,7mm 1p-d6-18,5mm</p>		<p>Z80619 NO. 7677865</p> <p>Mola de painel</p> <p>LANCIA DELTA</p> <p>d14x12mm 1p-d7,5-10mm</p>

LANCIA DELTA-NOVO DELTA

Rafri, Lda.

	Z80625 NO. 82421028 - 504056662		Z80646 NO. 7578051
	Mola de fixação LANCIA DELTA d18x42.5mm 1p-d8-19mm		Mola de fixação LANCIA DELTA 13x17.8x15mm 1p-9x14-14mm 1f-d5.5mm
	Z80647 NO. 14222380		Z80653 NO. 14211580
	Mola de fixação LANCIA DELTA 12.5x12.5x19.2mm 1p-9.5x9.5-18mm 1f-d4.8mm		Mola de fixação LANCIA DELTA 9x9x10mm 1p-7x7-9mm 1f-d4.2mm
	Z80666 NO. 5962559		Z80705 NO. 14191280 - 82377183
	Mola de fixação LANCIA DELTA d11x20mm 1p-d6.2-10mm		Mola de painel LANCIA DELTA d21x22.5mm 1p-d7.5-15.5mm
	Z80744 NO. 83468473		
	Mola de fixação LANCIA DELTA 12.5x12.5x19.2mm 1p-9.5x9.5-18mm 1f-d6.3mm		

LANCIA KAPPA

	E1009 NO. 82347855		F0799B-I NO. 46307462
	ESTICADOR DE ESCAPE LANCIA KAPPA (APÓS 1994) 83x48x24mm 2f-d12mm		FOLE DA TRANSMISSÃO JUNTO À CAIXA LANCIA KAPPA 2.4 JTD - 2.4 TDS - 2.4i 20V - 3.0i 24V (1994 A 2001) - LYBRA 1.9 JTD (APÓS 1999) d80x100mm 1f-d58mm 1f-d23mm
	F1761-I NO. 9941293		F1822-I NO. 4315444 - 46307029
	FOLE DA DIREÇÃO ASSISTIDA DIREITO E ESQUERDO LANCIA KAPPA d66x255mm 1f-d52mm 1f-d38mm		FOLE DA TRANSMISSÃO JUNTO À CAIXA LANCIA KAPPA 2.0i 20V - 2.0i T 16V - 2.0i T 20V (94 A 01) d102x94mm 1f-d99mm 1f-d25mm
	M6103 NO. 82473601		Z80242 NO. 14573280
	JUNTA DE ESCAPE LANCIA KAPPA APÓS 2002 108x82x1.5mm 1f-d61mm		Mola de fixação LANCIA KAPPA 12x9x18mm 1p-7x6.5-8mm

	Z80588	NO. 7637466		Z80604	NO. 7739801 - 500382985
	<i>Mola de painel</i> LANCIA KAPPA			<i>Mola de painel</i> LANCIA KAPPA	
d24x16.5mm		1p-d16.5-14mm	d18.2x21.6mm		1p-d6.4-16.1mm
	Z80605	NO. 7745194		Z80612	NO. 7569468
	<i>Mola de fixação</i> LANCIA KAPPA			<i>Mola de fixação</i> LANCIA KAPPA	
d20x20.5mm		1p-d9-18.5mm 1f-7x7mm	d10x33.7mm		1p-d6-18.5mm
	Z80619	NO. 7677865		Z80668	NO. 735266957
	<i>Mola de painel</i> LANCIA KAPPA			<i>Mola de painel</i> LANCIA KAPPA	
d14x12mm		1p-d7.5-10mm	d20x15.5mm		1p-d8.2-13mm
	Z80702	NO. 46408953 - 46748771		Z80727	NO. 7798971
	<i>Mola de fixação</i> LANCIA KAPPA			<i>Mola de fixação</i> LANCIA KAPPA	
d16x25.5mm		1p-8x8-24mm 1f-d4.8mm	d18x19mm		1p-d7.5-12mm

LANCIA LYBRA











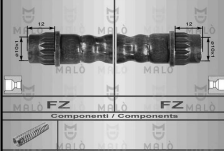



	A1688	NO. 46781213		E0192	NO. 51701045 - 46413122 - 46545743 - 60813377
	<i>APOIO DO MOTOR PARTE DE TRÁS</i> LANCIA LYBRA 1.9 JTD - 2.4 JTD			<i>ESTICADOR DA BARRA ESTABILIZADORA DA FRENTE</i> LANCIA LYBRA TT	
170x109x95mm		1f-d11mm	310x31x36mm		2p-d10-25mm
	F0835A5I	NO. 46307071 - 46307436 - 46307503 - 46307784 - 60813077		F1822-I	NO. 4315444 - 46307029
	<i>FOLE DA TRANSMISSÃO JUNTO À CAIXA</i> LANCIA LYBRA 1.6 i 16V (APÓS 07-99)			<i>FOLE DA TRANSMISSÃO JUNTO À CAIXA</i> LANCIA LYBRA 1.8i 16V - 2.0i 20V (APÓS 99)	
d93x87mm		1f-d79mm 1f-d24.4mm	d102x94mm		1f-d99mm 1f-d25mm
	F1825-I	NO. 46307840		KF1752-T	NO. 46307733
	<i>FOLE DA TRANSMISSÃO JUNTO À CAIXA</i> LANCIA LYBRA 2.4 JTD (APÓS 1999)			<i>KIT DE FOLE DO CARDAN JUNTO À CAIXA</i> LANCIA LYBRA 2.4 JTD (APÓS 1999)	
d95x120mm		1f-d80mm 1f-d23mm	d113x102mm		1f-d87mm 1f-d27mm

	<p>P1076 NO. 7961080</p> <p>CAPA DE PEDAL DO TRAVÃO E EMBRAIAGEM</p> <p>LANCIA LYBRA 1.6 16V (839AXA1A) (07-1999 A 10-2005) 103CV 1581CC - LANCIA LYBRA 1.8 16V (839AXB1A 839AXG1A) (07-1999 A 10-2005) 131CV 1747CC - LANCIA LYBRA 2.0 20V (839AXH1A) (09-2000 A 10-2005) 150CV 1998CC - LANCIA LYBRA 2.0 20V (839AXC11 839AXC1A) (07-</p> <p>80x60x10mm NULL</p>		<p>RT08554 NO. 45454003</p> <p>TUBO DE TRAVÃO FRENTE LH-RH</p> <p>LANCIA LYBRA (APÓS 07-1999)</p> <p>435mm FB23 - MC11</p>
	<p>T1119 NO. 500932</p> <p>BATEANTE DA BARRA ESTABILIZADORA DA FRENTE</p> <p>LANCIA LYBRA (839AX) 1.6 (182.B6.000) 103CV (10-2000 A 10-2005) - 1.6 16V (839AXA1A) (182 A4.000 - 182 B6.000) 103CV (07-1999 A 10-2005) - 1.8 16V (839AXB1A - 839AXG1A)(839 A4.000 - 839 A7.000 - 839 A9.000) 131CV (07-1999 A 10-2005) - 1.9 JTD (937 A2.000) 116</p> <p>48x36x39mm 1f-d20mm 40x29x32mm</p>		<p>W5013 NO. 73501275 - 55190424 - 55185409 - 55185403 - 614352 - 5614445 - 93183257 - 93191381 - 614571 - 551963...</p> <p>POLIE DA CAMBOTA (6 pistas)</p> <p>LANCIA LYBRA 19 JTD DIESEL - TURBO DIESEL</p> <p>d164.5mm d30.5mm</p>
	<p>Z80502 NO. 5757553</p> <p>Mola de retenção</p> <p>LANCIA LYBRA</p> <p>d16x9.5mm 1p-7x7-8.5mm 1f-d4.8mm</p>		<p>Z80578 NO. 14569580 - 14569680</p> <p>Mola de fixação</p> <p>LANCIA LYBRA</p> <p>20x8x15mm 1f-8mm</p>
	<p>Z80605 NO. 7745194</p> <p>Mola de fixação</p> <p>LANCIA LYBRA</p> <p>d20x20.5mm 1p-d9-18.5mm 1f-7x7mm</p>		<p>Z80619 NO. 7677865</p> <p>Mola de painel</p> <p>LANCIA LYBRA</p> <p>d14x12mm 1p-d7.5-10mm</p>
	<p>Z80625 NO. 82421028 - 504056662</p> <p>Mola de fixação</p> <p>LANCIA LYBRA</p> <p>d18x42.5mm 1p-d8-19mm</p>		<p>Z80637 NO. 7788400</p> <p>Mola de fixação</p> <p>LANCIA LYBRA</p> <p>d30x31.7mm 1p-d19-29mm</p>
	<p>Z80638 NO. 7638283</p> <p>Mola de painel</p> <p>LANCIA LYBRA</p> <p>d25x19.5mm 1p-d8-17mm</p>		<p>Z80646 NO. 7578051</p> <p>Mola de fixação</p> <p>LANCIA LYBRA</p> <p>13x17.8x15mm 1p-9x14-14mm 1f-d5.5mm</p>
	<p>Z80668 NO. 735266957</p> <p>Mola de painel</p> <p>LANCIA LYBRA</p> <p>d20x15.5mm 1p-d8.2-13mm</p>		<p>Z80686 NO. 7770156</p> <p>Mola de friso</p> <p>LANCIA LYBRA</p> <p>NULL NULL</p>
	<p>Z80702 NO. 46408953 - 46748771</p> <p>Mola de fixação</p> <p>LANCIA LYBRA</p> <p>d16x25.5mm 1p-8x8-24mm 1f-d4.8mm</p>		

	E0213-M NO. 46528871 - 46844208		P1100 NO. 71732392
	ESTICADOR DO MOTOR PARTE DE TRÁS LANCIA MUSA 1.4(16V FIRE)		CAPA DO PEDAL DO TRAVÃO E EMBRAIAGEM LANCIA MUSA (350_) 1.4 (09.05 A 09.12) 78cv 1368cc Veículo multiuso - LANCIA MUSA (350_) 1.4 (10.04 A 09.12) 95cv 1368cc Veículo multiuso - LANCIA MUSA (350_) 1.3 D Multijet (10.04 A 09.12) 70cv 1248cc Veículo multiuso - LANCIA MUSA (350_) 1.3 D Multijet (09.06 A 09.12) 90cv 1248cc Veículo multiuso - LANCIA MUSA (350_) 1.9 D Multijet (10.04 A 09.12) 101cv 1910cc Veículo multiuso
	210x100x35mm 1f-d24mm 1f-d12mm		76x53x9mm NULL
	W5054 NO. 46819147 - 55200498 - 1539102 - 1564852 - 9S516B319AA - 1261085 - 1261085E00 - 1539102 - 1564852		Z80830 NO. 156070584
	POLIE DA CAMBOTÁ (6 PISTAS) LANCIA MUSA 1.3 MULTIJET (APÓS 12-2004) - Mtr 188A9000 - 199A3000 (70-90CV)		NULL LANCIA MUSA
	d165mm d35mm		NULL NULL

LANCIA PHEDRA-ZETA

	A1588 NO. 9618184180		A1922 NO. 1714E3 - 9642742880 - 1755E4 - 17565YV010
	APOIO DO MOTOR PARTE DE TRÁS LANCIA ZETA 2.0 IE 16V - 2.0 IE TB - 2.0 JTD - 2.1 TD		APOIO DO ESCAPE LANCIA PHEDRA (179_) 3.0 V6 Local de montagem: à frente (09.02 A 11.10) 204cv 2946cc Veículo multiuso
	140x98x92mm NULL		53x39x45mm 2p-d6-18mm
	BE22 NO. 9624037280 - 9401713699		F1301-I NO. 9564479480
	ABRAÇADEIRA ESCAPE LANCIA ZETA (APÓS 1994)		FOLE DO LADO DA CAIXA LANCIA ZETA 2000 - 2000 TURBO (APÓS 07 - 1995)
	96x100x18mm 1p-d10-75mm		d90x100mm 1f-d78mm 1f-d25mm
	F1667-I NO.		F4037 NO. 9404066418
	FOLE DIREÇÃO ASSISTIDA LADO DIREITO E ESQUERDO LANCIA ZETA		FOLE DA DIREÇÃO LADO DIREITO E ESQUERDO LANCIA ZETA 2.0i - 2.0 iT - 2.0 JTD - 2.1 TD (1995 A 2002)
	d65x200mm 1f-d58mm 1f-d10mm		d72/54x240mm 1f-d68mm 1f-d10mm
	KF1060 NO. 82436966 - 82483504 - 82443750 - 824629961		KF1406-T NO. 9567504880
	KIT DE FOLE DO CARDAN JUNTO À RODA LANCIA ZETA 2.0i 16V (1995 A 2002) - DEDRA 1.9 TDS - 2.0 (APÓS 1989) - LYBRA 1.8 - 1.9 JTD - 2.0 (APÓS 1999) - THEMA 2.0 i.e. - 2.0 i.e. 16V - 2.0 TURBO 16V - 2.4 TD - 2.5 TD (1988 A 1994) - LANCIA Z 2.0 - 2.0 16V - 2.0 JTD - 2.0 TURBO (APÓS 1995)		KIT DE FOLE DO CARDAN JUNTO À RODA LANCIA PHEDRA 2.0 JTD - 2.2 JTD - 3.0i V6 (APÓS 2002) - ZETA 2.0i T TURBO - 2.1 TD (1995 A 2002)
	d100x100mm 1f-d78mm 1f-d24mm		d110x120mm 1f-d99mm 1f-d30mm
	RT08569 NO. 147919080		RT08570 NO. 1472155080
	TUBO DE TRAVÃO FRENTE LH-RH LANCIA ZETA (APÓS 1994)		TUBO DE TRAVÃO TRÁS LH-RH LANCIA ZETA TT (APÓS 1994)
	515mm FZ - MG1		325mm FZ - MC11

	RT08573 NO. 1472157080 TUBO DE TRAVÃO INTERMÉDIO LANCIA ZETA TT (APÓS 1994)		S1468 NO. 1313083080 - 1305551080 SILENT BLOC ESQUERDO DO BRAÇO DA SUSPENSÃO DA FRENTE LANCIA ZETA 2.0 16V - 2.0 TURBO - 2.0JTD - 2.1TD (1995 A 2002)
	275mm FZ - FZ		130x132x85mm d60mm c62mm 1f-d22.8mm
	S1469 NO. 1313084080 - 1305552080 SILENT BLOC DIREITO DO BRAÇO DA SUSPENSÃO DA FRENTE LANCIA ZETA 2.0 16V - 2.0 TURBO - 2.0JTD - 2.1TD (1995 A 2002)		S1470 NO. 1312317080 SILENT BLOC CENTRAL DO BRAÇO DA SUSPENSÃO DA FRENTE LANCIA ZETA 2.0 16V - 2.0 TURBO - 2.0JTD - 2.1TD (1995 A 2002)
	130x132x85mm d60mm c62mm 1f-d22.8mm		126x50x62mm 1f-d22.8mm 2f-d12mm
	T0665-I NO. 503339 - 1307021080 BATENTE SUSPENSÃO DA FRENTE LANCIA ZETA (22_) 2.0 16V (220AL5) (05.98 A 07.00) 132cv 1998cc Veículo multiuso - LANCIA ZETA (22_) 2.0 16V (220AQ5) (07.00 A 09.02) 136cv 1997cc Veículo multiuso - LANCIA ZETA (22_) 2.0 Turbo (220AD5 - 220CD5) (05.95 A 09.02) 147cv 1998cc Veículo multiuso - LANCIA ZETA (22_) 2.0 JTD 16V (220AN5) (09.99 A 09.02) 109cv 1997cc Veículo multiuso - LANCIA ZETA (22_) 2.1 TD (220AJ5) (05.96 A 09.99) 109cv 2088cc Veículo multiuso		T1123 NO. 1305782080 BATENTE DA BARRA ESTABILIZADORA DA FRENTE LANCIA ZETA 2.0 16V (220AL5) RFV 132CV (05-1998 A 07-2000) - 2.0 16V (220AQ5) RFN 136CV (07-2000 A 09-2002) - 2.0 JTD RHZ 109CV (04-2000 A 09-2002) - 2.0 JTD (220AN5) RHW 109CV (09-1999 A 09-2002) - 2.0 Turbo (220AD5 - 220CD5) RGX 147CV (05-1995 A 09-2002)
	d54x107mm 1f-d25mm 1f-d20mm		64x53x45x50mm 1f-d24.5mm
	W5003 NO. 9641548980 - 9467586180 - 9630647180 - 9681761480 - 9685774180 - 9666471189 - 9634848980 - 946447128... POLIE DA CAMBOTA (6 pistas) LANCIA PHEDRA (2.0 - 2.2 JTD) - ZETA (2.0 JTD)		W5011 NO. POLIE DA CAMBOTA (6 pistas) LANCIA ZETA 2.1 TD (05-1996 A 09-1999)
	d152.8mm d30mm		d152.8mm d30mm
	W5085 NO. 9643354180 POLIE DA CAMBOTA (6 PISTAS) LANCIA PHEDRA 2.0 JTD 16V (136CV) (APÓS 06-2006)		W5101 NO. 9681761480 POLIE DA CAMBOTA LANCIA PHEDRA - ZETA 2.0 JTD - 2.2 JTD
	d153/158mm d16mm		d152.8mm d30mm
	Z80533 NO. 7543023 - 7703081019 - 9759904480 Mola de retenção LANCIA ZETA		Z80533 NO. 7543023 - 7703081019 - 9759904480 Mola de retenção LANCIA PHEDRA
	10x17x10mm 1p-7.2x14-9mm 1f-d4.2mm		10x17x10mm 1p-7.2x14-9mm 1f-d4.2mm
	Z80607 NO. 500358569 - 9621837480 Mola de fixação LANCIA PHEDRA		Z80680 NO. 9605146380 - 6999A3 Mola de painel LANCIA ZETA
	d16x21mm 1p-d5.5-10mm		d12x12mm 1p-d6-10mm
	Z80690 NO. 699783 - 9621385880 Mola de fixação LANCIA PHEDRA		
	d22x28mm 1p-d6.5-14mm		







	<p>E0018 NO. ESTICADOR DE ESCAPE LANCIA PRISMA TT 68x54x25mm NULL</p>		<p>E1009 NO. 82347855 ESTICADOR DE ESCAPE LANCIA PRISMA (1982 A 1990) 83x48x24mm 2f-d12mm</p>
	<p>F0060-I NO. 4239459 - 4371156 FOLE DA CREMALHEIRA DA DIRECÇÃO DIREITO (F1038) LANCIA PRISMA TT (ATÉ 6-86) d59x180mm d47mm 1f-d1f-d26mm 1f-d10mm</p>		<p>F0388-I NO. 4315444 FOLE DO DIFERENCIAL LANCIA PRISMA 1.3 . 1.5 (CAIXA AUT.) - PRISMA R-86 1.6 - DIESEL - TDS - PRISMA 2.0 4wd (TRÁS) d77x85mm 1f-d62mm 1f-d24mm</p>
	<p>F0389-I NO. 4433969 FOLE DO DIFERENCIAL LADO DA RODA LANCIA PRISMA R-86 DIESEL (ATÉ 5-86) d90x82mm 1f-d76mm 1f-22mm</p>		<p>F0403-I NO. 4383758 - 7501348 FOLE DO DIFERENCIAL LADO RODA LANCIA PRISMA 1.3 - 1.5 (ATÉ 2-85) d80x80mm 1f-d70mm 1f-d20mm</p>
	<p>F0468-I NO. 92601216 FOLE ESQUERDO E DIREITO DO DIFERENCIAL COM CASQUILHO EM NYLON (APENAS DIREITO NOS MODELOS LANCIA PRISMA 1.3 - 1.5 (ATÉ 2-85) - PRISMA R-86 1.3 - 1.5 (3-85 A 9-87) d95x70mm 1f-d63mm 1f-d23mm</p>		<p>F0468B-I NO. 92601255 FOLE DO DIFERENCIAL SEMI-EIXO ESQUERDO COM CASQUILHO EM NYLON LANCIA PRISMA 1.5 (2-85 A 2-86) d95x73mm 1f-d71mm 1f-d23mm</p>
	<p>F0469-I NO. 82282140 FOLE DA TRANSMISSÃO LADO DA CAIXA LANCIA PRISMA R-86 1.3 . 1.5 (AUT) - 2.0 4WD - REAR - 1.6 - 2.0IE DIESEL TDS d85x80mm 1f-d61mm 1f-d23mm</p>		<p>F0514-I NO. 5987092 FOLE DO SEMI-EIXO JUNTO À RODA LANCIA PRISMA R-86 1.3 (ATÉ 6-88) d86x82mm 1f-d71mm 1f-d20mm</p>
	<p>F0787-I NO. 92601366 FOLE JUNTO À CAIXA LANCIA PRISMA R-86 1.3 - 1.5 (ATÉ 9-1987) d94x76mm 1f-d80mm 1f-d22mm</p>		<p>F0834-I NO. 7621245 FOLE DO DIFERENCIAL SEMI-EIXO DIREITO LANCIA PRISMA R-86 1.3 - 1.5 (APÓS 10-87) d91x82mm 1f-d65mm 1f-d32mm</p>
	<p>F0834A-I NO. 7621245 FOLE DO DIFERENCIAL SEMI-EIXO DIREITO COM ROLAMENTO d23mm LANCIA PRISMA R-86 1.3 - 1.5 (APÓS 10-87) d93x90mm 1f-d23mm</p>		<p>F0835-I NO. 7625541 FOLE ESQUERDO DO DIFERENCIAL LADO CAIXA LANCIA PRISMA R-86 1.3 - 1.5 (APÓS 10-87) d90x85mm 1f-d77mm 1f-d22.8mm</p>
	<p>F0835A-I NO. 7625541 FOLE ESQUERDO DO DIFERENCIAL LADO CAIXA COM ROLAMENTO LANCIA PRISMA R-86 1.3 - 1.5 (APÓS 10-87) d90x85mm 1f-d77mm 1f-d22.8mm</p>		<p>F0897-I NO. 82443750 - 82462961 FOLE JUNTO À RODA LANCIA PRISMA R-86 2.0 (APÓS 7-1988) d100x98mm 1f-d86mm 1f-d26mm</p>

	<p>F0898F76 NO. 7642776 - 7682886</p> <p>FOLE DO SEMI-EIXO JUNTO À RODA</p> <p>LANCIA PRISMA R-86 1.3 1.5 - (APÓS 7-88)</p> <p>d89x83mm 1f-d76mm 1f-d21mm</p>		<p>F0903-I NO. 82443745 - 82463084</p> <p>FOLE DO DIFERENCIAL LADO DA RODA</p> <p>LANCIA PRISMA R-86 1.3 - 1.5 (CAIXA AUT.) (APÓS 7-88) - 1.6 - 1.6 I.E. - DIESEL - TDS (APÓS 7-88)</p> <p>d90x82mm 1f-d76mm 1f-d25mm</p>
	<p>F1175-I NO. 7545579 - 7602437 - 7645160 - 7664428</p> <p>FOLE DA DIREÇÃO LADO DIREITO</p> <p>LANCIA PRISMA 1.6 - 1.6 i.e - 1.9 TD (1983 A 1992)</p> <p>d63x180mm 1f-d45mm 1f-d10mm</p>		<p>F1822-I NO. 4315444 - 46307029</p> <p>FOLE DA TRANSMISSÃO JUNTO À CAIXA</p> <p>LANCIA PRISMA 2.0 i.e. 4WD (83 A92)</p> <p>d102x94mm 1f-d99mm 1f-d25mm</p>
	<p>KF1730 NO. 5966569 - 5987092</p> <p>KIT FOLE DO LADO DA RODA</p> <p>LANCIA PRISMA 1.3 (01-1983 A 04-1995) - 1.5 (01-1983 A 02-1992)</p> <p>d82x80mm 1f-d20mm 1f-d68mm</p>		<p>KF1775 NO. 7642776 - 7682886</p> <p>KIT FOLE DO LADO DA RODA</p> <p>LANCIA PRISMA 1.3 (01-1983 A 02-1992) - 1.5 (09-1985 A 02-1992)</p> <p>d90x79mm 1f-d21mm 1f-d76mm</p>
	<p>M6028 NO. 82407143</p> <p>JUNTA DE ESCAPE</p> <p>LANCIA PRISMA (1987 A 1989)</p> <p>d57x10mm 1f-d47mm</p>		<p>M6038 NO. 7664769 - 7646609 - 4147260 - 5891207</p> <p>JUNTA DE ESCAPE</p> <p>LANCIA PRISMA (1982 A 1990)</p> <p>104x76mm 2f-d37mm</p>
	<p>M6042 NO. 4166914 - 4152873 - 82460789 - 7664668 - 7678282 - 82376425</p> <p>JUNTA DE ESCAPE</p> <p>LANCIA PRISMA (1982 A 1990)</p> <p>115x72mm 2f-d40mm</p>		<p>S1584 NO. 82337597 - 82379625 - 82403643</p> <p>SILENT BLOC DO BRAÇO DA SUSPENSÃO DE TRÁS</p> <p>LANCIA PRISMA (831_) 1.5 (09.85 A 02.92) 75cv 1498cc três volumes - LANCIA PRISMA (831_) 1.5 (08.86 A 02.92) 80cv 1498cc três volumes - LANCIA PRISMA (831_) 1.5 (01.83 A 04.86) 86cv 1498cc três volumes - LANCIA PRISMA (831_) 1.6 i.e. Super (05.87 A 12.89) 90cv 1585cc três volumes - LANCIA PRISMA (831_) 1.6 (08.86 A 02.92) 99cv 1585cc três volumes - LANCIA PRISMA (831_) 1.6 (01.83 A 04.86) 105cv 1585cc três volumes - LANCIA PRISM...etc.</p> <p>d30x30mm c22mm 1f-d10mm</p>
	<p>Z80502 NO. 5757553</p> <p>Mola de retenção</p> <p>LANCIA PRISMA</p> <p>d16x9.5mm 1p-7x7-8.5mm 1f-d4.8mm</p>		<p>Z80625 NO. 82421028 - 504056662</p> <p>Mola de fixação</p> <p>LANCIA PRISMA</p> <p>d18x42.5mm 1p-d8-19mm</p>
	<p>Z80705 NO. 14191280 - 82377183</p> <p>Mola de painel</p> <p>LANCIA PRISMA</p> <p>d21x22.5mm 1p-d7.5-15.5mm</p>		<p>Z80744 NO. 83468473</p> <p>Mola de fixação</p> <p>LANCIA PRISMA</p> <p>12.5x12.5x19.2mm 1p-9.5x9.5-18mm 1f-d6.3mm</p>

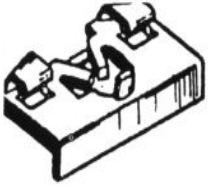

	<p>F0060-I NO. 4239459 - 4371156</p> <p>FOLE DA CREMALHEIRA DA DIRECÇÃO DIREITO (F1038)</p> <p>LANCIA THEMA (COM DIR. ASSISTIDA)</p> <p>d59x180mm d47mm 1f-d1f-d26mm 1f-d10mm</p>		<p>F0388-I NO. 4315444</p> <p>FOLE DO DIFERENCIAL</p> <p>LANCIA THEMA (APÓS 06-1988)</p> <p>d77x85mm 1f-d62mm 1f-d24mm</p>
	<p>F0469-I NO. 82282140</p> <p>FOLE DA TRANSMISSÃO LADO DA CAIXA</p> <p>LANCIA THEMA (APÓS 07-1988) - 2.0 - 2.4</p> <p>d85x80mm 1f-d61mm 1f-d23mm</p>		<p>F1118-I NO. 60760026</p> <p>FOLE DA DIRECÇÃO LADO DIREITO</p> <p>LANCIA THEMA (DIRECÇÃO ASSISTIDA)</p> <p>d65x210mm 1f-d45mm 1f-d10mm</p>
	<p>F1119-I NO. 36020065 - 9943835</p> <p>FOLE DA DIRECÇÃO LADO ESQUERDO</p> <p>LANCIA THEMA (DIRECÇÃO ASSISTIDA)</p> <p>d65x165mm 1f-d46mm 1f-d10mm</p>		<p>F1335-I NO. 9943835</p> <p>FOLE DA DIRECÇÃO LADO DIREITO</p> <p>LANCIA THEMA FERRARI</p> <p>130x75x225mm 1f-100/47mm 1f-d18mm 1f-d10mm</p>
	<p>F1336-I NO. 36020065</p> <p>FOLE DA DIRECÇÃO DO LADO ESQUERDO</p> <p>LANCIA THEMA FERRARI</p> <p>87x81x170mm 1f-d45mm 1f-d10mm</p>		<p>F1822-I NO. 4315444 - 46307029</p> <p>FOLE DA TRANSMISSÃO JUNTO À CAIXA</p> <p>LANCIA THEMA 2.4TD 2500 Turbo DS - 2.5 TD 2500 Turbo DS (84 A 94)</p> <p>d102x94mm 1f-d99mm 1f-d25mm</p>
	<p>M6028 NO. 82407143</p> <p>JUNTA DE ESCAPE</p> <p>LANCIA THEMA (1984 A 1995)</p> <p>d57x10mm 1f-d47mm</p>		<p>M6042 NO. 4166914 - 4152873 - 82460789 - 7664668 - 7678282 - 82376425</p> <p>JUNTA DE ESCAPE</p> <p>LANCIA THEMA (1984 A 1995)</p> <p>115x72mm 2f-d40mm</p>
	<p>Z10430 NO. 4198690</p> <p>Mola de fixação</p> <p>LANCIA THEMA</p> <p>11x11x13mm 1p-8x8-11.3mm 1f-d4.2mm</p>		<p>Z80243 NO. 14187880</p> <p>Mola de painel</p> <p>LANCIA THEMA</p> <p>d17x17.5mm 1p-d8-11.5mm</p>
	<p>Z80247 NO. 14188380</p> <p>Mola de painel</p> <p>LANCIA THEMA</p> <p>d16x18.6mm 1p-d7.5-12.6mm</p>		<p>Z80352 NO. 14567187 - 17886087</p> <p>Mola de painel</p> <p>LANCIA THEMA</p> <p>d15x19mm 1p-d8-16.5mm</p>
	<p>Z80502 NO. 5757553</p> <p>Mola de retenção</p> <p>LANCIA THEMA</p> <p>d16x9.5mm 1p-7x7-8.5mm 1f-d4.8mm</p>		<p>Z80532 NO. 5998258</p> <p>Mola de friso</p> <p>LANCIA THEMA</p> <p>20x7x5mm NULL</p>

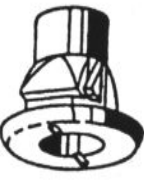
LANCIA THEMA

Rafpi, Lda.



	Z80547 NO. 82407538 <i>Mola de friso</i> LANCIA THEMA NULL NULL		Z80578 NO. 14569580 - 14569680 <i>Mola de fixação</i> LANCIA THEMA 20x8x15mm 1f-8mm
	Z80612 NO. 7569468 <i>Mola de fixação</i> LANCIA THEMA d10x33.7mm 1p-d6-18.5mm		Z80619 NO. 7677865 <i>Mola de painel</i> LANCIA THEMA d14x12mm 1p-d7.5-10mm
	Z80625 NO. 82421028 - 504056662 <i>Mola de fixação</i> LANCIA THEMA d18x42.5mm 1p-d8-19mm		Z80635 NO. 14216080 - 14216087 <i>Mola de fixação</i> LANCIA THEMA d18x14mm 1p-10x10-12.5mm 1f-d4.8mm
	Z80651 NO. 82426359 <i>Mola de fixação</i> LANCIA THEMA d18x42mm 1p-d10-19mm		Z80703 NO. 5988006 <i>Mola de fixação</i> LANCIA THEMA d15x24mm 1p-d6.5-12mm

LANCIA THESIS

	F4037 NO. 9404066418 <i>FOLE DA DIRECÇÃO LADO DIREITO E ESQUERDO</i> LANCIA THESIS 2.0 iT (APÓS 2002) d72/54x240mm 1f-d68mm 1f-d10mm		M6103 NO. 82473601 <i>JUNTA DE ESCAPE</i> LANCIA THESIS (APÓS 2002) 108x82x1.5mm 1f-d61mm
	Z80352 NO. 14567187 - 17886087 <i>Mola de painel</i> LANCIA THESIS d15x19mm 1p-d8-16.5mm		Z80590 NO. 14569187 <i>Mola de painel</i> LANCIA THESIS d22x22.5mm 1p-d10.4-20mm
	Z80612 NO. 7569468 <i>Mola de fixação</i> LANCIA THESIS d10x33.7mm 1p-d6-18.5mm		Z80653 NO. 14211580 <i>Mola de fixação</i> LANCIA THESIS 9x9x10mm 1p-7x7-9mm 1f-d4.2mm









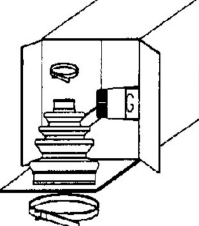

	Z80666	NO. 5962559		Z80668	NO. 735266957
	Mola de fixação LANCIA THESIS			Mola de painel LANCIA THESIS	
d11x20mm		1p-d6.2-10mm	d20x15.5mm		1p-d8.2-13mm
	Z80707	NO. 60660554			
	Mola de fixação LANCIA THESIS				
12x9.7x21.6mm		1p-11.5x3-19.4mm			

LANCIA TREVI

 ESC: 1/2	C0229	NO. 100816 - 4276430		M6042	NO. 4166914 - 4152873 - 82460789 - 7664668 - 7678282 - 82376425
	BOTÃO DE AFINAÇÃO DO CAPOT (GRANDE) LANCIA TREVI (828_) 2000 i.e. Local de montagem: à frente 90kW 122CV 1995cc três volumes (DE 05-80 ATÉ 01-87) LANCIA TREVI (828_) 2000 Volumex (828DB17) Local de montagem: à frente 99kW 135CV 1995cc três volumes (DE 08-83 ATÉ 05-85)			JUNTA DE ESCAPE LANCIA TREVI (1980 A 1986)	
d18x44mm		NULL	115x72mm		2f-d40mm

LANCIA Y10















	A0926-I	NO. 7543418 - 7613889		A0927-I	NO. 7544643 - 7544644
	SUPORTE TRÁS DO MOTOR LANCIA Y10 4x4 (APOIO TRÁS)- LANCIA Y10 TURBO - LX - FIRE 1.3I.E. (APOIO FRENTE)			SUPORTE TRÁS DO MOTOR LANCIA Y10	
116x80x62mm		1f-d10mm	135x80x60mm		1f-d9mm
	A0996	NO. 5974775	 ESC: 1/2	C0229	NO. 100816 - 4276430
	SUPORTE DO MOTOR LADO DA CAIXA LANCIA Y10			BOTÃO DE AFINAÇÃO DO CAPOT (GRANDE) LANCIA A 112 1.0 LX Local de montagem: à frente 35kW 48CV 965cc Hatchback (DE 03-84 ATÉ 12-86) LANCIA A 112 1.0 Abarth (A112B2/5) Local de montagem: à frente 51kW 69CV 1050cc Hatchback (DE 03-78 ATÉ 02-84)	
150x80x48mm		1f-d8mm	d18x44mm		NULL
 ESC: 1/2	C0229	NO. 100816 - 4276430		E0017	NO. 4387293
	BOTÃO DE AFINAÇÃO DO CAPOT (GRANDE) LANCIA Y10 (156_) 1.0 Fire (156B, 156AD) Local de montagem: à frente e atrás 32kW 44CV 999cc Hatchback (DE 06-85 ATÉ 06-91) LANCIA Y10 (156_) 1.0 Fire Tração integral Local de montagem: à frente e atrás 32kW 44CV 999cc Hatchback (DE 12-86 ATÉ 02-89) LANCIA Y10 (156_) 1.0 Fire (156AA) Local de montagem: à frente e atrás 33kW 45CV 999cc Hatchback (DE 03-85 ATÉ 06-89) LANCIA Y10 (156_) 1.0 Fire Multi-Conv (156AE) Local de mo...etc.			ESTICADOR DE ESCAPE LANCIA Y10 (APÓS 85)	
116x44mm		NULL	55x45x28mm		NULL

	E0041 NO. 4393777 - 4380523 - GE-115139 ESTICADOR DE ESCAPE LANCIA Y10 (APÓS 85) 76x64x15mm NULL		F1137-I NO. 7746232 - 7715294 - 46307644 - 51704105 FOLE DO LADO DA CAIXA LANCIA Y10 (APÓS 10-95) d76x90mm 1f-d60mm 1f-d19mm
	H528 NO. PALA ORIGINAL LINEACCESSORI LANCIA Y10 370x205mm NULL		KF1775 NO. 7642776 - 7682886 KIT FOLE DO LADO DA RODA LANCIA Y10 d90x79mm 1f-d21mm 1f-d76mm
	M6049 NO. 7669581 JUNTA DE ESCAPE LANCIA Y10 113x60mm 2f-d35mm		M6094 NO. 7690882 JUNTA DE ESCAPE LANCIA Y10 d60x13mm 1f-d45mm
	RF5012 NO. 7545122 TUBO DE FERRO RADIADOR LANCIA Y10 FIRE A 1993 B270-d27/28mm 225-75mm		Z10845 NO. 14203080 Mola de fixação Lancia Y10 15x15x21mm 1p-11x11-19.5mm 1f-d5.5mm
	Z80465 NO. 4389939 Mola de fixação LANCIA Y10 14x11x15mm 1p-10.5x6-8mm		Z80476 NO. 14188282 - 46306526 - 60507749 Mola de painel LANCIA Y10 d18x20.5mm 1p-d8-14mm
	Z80502 NO. 5757553 Mola de retenção LANCIA Y10 d16x9.5mm 1p-7x7-8.5mm 1f-d4.8mm		Z80504 NO. 7600779 Mola de fixação LANCIA Y10 d16x25mm 1p-d8-13mm
	Z80562 NO. 7570122 Mola de painel LANCIA Y10 d16x22mm 1p-d7.5-16.5mm		Z80588 NO. 7637466 Mola de painel LANCIA Y10 d24x16.5mm 1p-d16.5-14mm
	Z80620 NO. 833640 Mola de painel LANCIA Y10 d18x18.4mm 1p-d9.5-11.8mm		Z80635 NO. 14216080 - 14216087 Mola de fixação LANCIA Y10 d18x14mm 1p-10x10-12.5mm 1f-d4.8mm

	Z80705	NO. 14191280 - 82377183		
	Mola de painel LANCIA Y10			
	d21x22.5mm	1p-d7.5-15.5mm		

LANCIA YPSILON

	A1686	NO. 46528869		E0213-M	NO. 46528871 - 46844208
	APOIO DO MOTOR PARTE DE TRÁS LANCIA YPSILON 1.3 JTD MJ (16V)			ESTICADOR DO MOTOR PARTE DE TRÁS LANCIA YPSILON 1.2(8V) - 1.2(16V) - 1.4(16V FIRE)	
	265x110x143mm	1f-d19mm		210x100x35mm	1f-d24mm 1f-d12mm
	E0214-M	NO. 46552759		F1127H-I	NO. 7645160
	ESTICADOR DO MOTOR PARTE DE TRÁS LANCIA YPSILON 1.3 JTD MJ 16V			FOLE DA DIRECÇÃO ESQUERDO E DIREITO (DIRECÇÃO ASSISTIDA) LANCIA Y 1242cc.1370 cc. (APÓS 10-95)	
	200x110x60mm	1f-d20mm 1f-d12 - 6mm		d62x210mm	1f-d58mm 1f-d10mm
	F1181-I	NO. 7545579		F1327-I	NO. 7762159
	FOLE DA DIRECÇÃO ESQUERDO E DIREITO LANCIA Y 1242cc.1370 cc. (APÓS 10-95)			FOLE DE AMORTECEDOR DA FRENTE LANCIA Y	
	d63x155mm	1f-d45mm 1f-d10mm		d70x200mm	1f-d60mm 1f-d18mm
	KF1797-T	NO. 46429633 - 60812755		KF1798-T	NO. 46307555 - 46307575
	KIT DO FOLE DO CARDAN JUNTO À RODA LANCIA Y 1.2i - 1.2i 16V - 1.4i 12V (1995 A 2004) - DELTA II 1.9 TD (1993 A 1999) - KAPPA 2.0i 20V - 2.0i T 16V - 2.0i T 20V - 2.4i 20V (1994 A 2001) - LYBRA 1.8i 16V - 2.0i 20V (APÓS 1999) -			KIT DE FOLE DO CARDAN JUNTO À RODA LANCIA YPSILON 1.2i - 1.4i (APÓS 2003)	
	d110x102mm	1f-d87mm 1f-d27mm		d95x95mm	1f-d74mm 1f-d22mm
	KF3705-T	NO. 51704102		P1100	NO. 71732392
	KIT DE FOLE DO CARDAN JUNTO À RODA LANCIA YPSILON 1.3 JTD 16V (APÓS 2003)			CAPA DO PEDAL DO TRAVÃO E EMBRAIAGEM LANCIA YPSILON (843_) 1.2 (10.03 A 12.11) 60cv 1242cc Hatchback - LANCIA YPSILON (843_) 1.2 (10.03 A 12.11) 80cv 1242cc Hatchback - LANCIA YPSILON (843_) 1.4 (02.06 A 12.11) 78cv 1368cc Hatchback - LANCIA YPSILON (843_) 1.4 16V (10.03 A 12.11) 95cv 1368cc Hatchback - LANCIA YPSILON (843_) 1.3 JTD (10.03 A 12.11) 70cv 1248cc Hatchback - LANCIA YPSILON (843_) 1.3 D Multijet (09.06 A 12.11) 75cv 1248cc Hatchback - LANCIA YPSILON (843_) 1.3 D M...etc.	
	d91x120mm	1f-d78mm 1f-d22mm		76x53x9mm	NULL
	R019305	NO. 46744677		RT08427	NO. 7563852
	TUBO INFERIOR DO RADIADOR LANCIA Y (840_) 1.2 (840AA_ 840AF1A) Mod. t ipo: FL2000 (03.96 A 09.03) 60cv 1242cc Hatchback - LANCIA Y (840_) 1.2 16V (840AG1A) Mod. t ipo: FL2000 (10.00 A 09.03) 80cv 1242cc Hatchback - LANCIA Y (840_) 1.2 16V (840AD) Mod. t ipo: FL2000, (04.97 A 09.03) 86cv 1242cc Hatchback			TUBO DE TRAVÃO TRÁS LH-RH LANCIA Y (APÓS 11-1995)	
	B320-d26/26mm	60-70-160-100-60mm +ch 710-d14mm		217mm	FB23 - FB23

 <p>FB23 MC11 Componenti / Components</p>	<p>RT08481 NO. 7735009</p> <p>TUBO DE TRAVÃO FRENTE RH</p> <p>LANCIA Y 1.1 - 1.2 (APÓS 11-1995)</p>	 <p>FB23 MC11 Componenti / Components</p>	<p>RT08482 NO. 7735008</p> <p>TUBO DE TRAVÃO FRENTE LH</p> <p>LANCIA Y 1.1 - 1.2 8V (APÓS 11-1995)</p>
	<p>W5054 NO. 46819147 - 55200498 - 1539102 - 1564852 - 9S516B319AA - 1261085 - 1261085E00 - 1539102 - 1564852</p> <p>POLIE DA CAMBOTÁ (6 PISTAS)</p> <p>LANCIA YPSILON 1.3 JTD 16V APÓS 06-2003 - Mtr 188A9000 (70CV)</p>		<p>Z80502 NO. 5757553</p> <p>Mola de retenção</p> <p>LANCIA YPSILON</p>
	<p>Z80578 NO. 14569580 - 14569680</p> <p>Mola de fixação</p> <p>LANCIA YPSILON</p>		<p>Z80588 NO. 7637466</p> <p>Mola de painel</p> <p>LANCIA YPSILON</p>
	<p>Z80604 NO. 7739801 - 500382985</p> <p>Mola de painel</p> <p>LANCIA YPSILON</p>		<p>Z80605 NO. 7745194</p> <p>Mola de fixação</p> <p>LANCIA YPSILON</p>
	<p>Z80605 NO. 7745194</p> <p>Mola de fixação</p> <p>LANCIA YPSILON</p>		<p>Z80615 NO. 46436251</p> <p>Mola de fixação</p> <p>LANCIA YPSILON</p>
	<p>Z80619 NO. 7677865</p> <p>Mola de painel</p> <p>LANCIA YPSILON</p>		<p>Z80635 NO. 14216080 - 14216087</p> <p>Mola de fixação</p> <p>LANCIA YPSILON</p>
	<p>Z80638 NO. 7638283</p> <p>Mola de painel</p> <p>LANCIA YPSILON</p>		<p>Z80638 NO. 7638283</p> <p>Mola de painel</p> <p>LANCIA YPSILON (Após 2000)</p>
	<p>Z80641A NO. 1H0853586</p> <p>Mola de fixação</p> <p>LANCIA YPSILON (Após 2000)</p>		<p>Z80651 NO. 82426359</p> <p>Mola de fixação</p> <p>LANCIA YPSILON</p>

	<table border="1"> <tr> <td>Z80668</td> <td>NO. 735266957</td> </tr> <tr> <td colspan="2"><i>Mola de painel</i></td> </tr> <tr> <td colspan="2">LANCIA YPSILON</td> </tr> <tr> <td>d20x15.5mm</td> <td>1p-d8.2-13mm</td> </tr> </table>	Z80668	NO. 735266957	<i>Mola de painel</i>		LANCIA YPSILON		d20x15.5mm	1p-d8.2-13mm		<table border="1"> <tr> <td>Z80676</td> <td>NO. 46558337</td> </tr> <tr> <td colspan="2"><i>Mola de fixação</i></td> </tr> <tr> <td colspan="2">LANCIA YPSILON</td> </tr> <tr> <td>d18x17mm</td> <td>1p-8x8-13.7mm 1f-d4.8mm</td> </tr> </table>	Z80676	NO. 46558337	<i>Mola de fixação</i>		LANCIA YPSILON		d18x17mm	1p-8x8-13.7mm 1f-d4.8mm
Z80668	NO. 735266957																		
<i>Mola de painel</i>																			
LANCIA YPSILON																			
d20x15.5mm	1p-d8.2-13mm																		
Z80676	NO. 46558337																		
<i>Mola de fixação</i>																			
LANCIA YPSILON																			
d18x17mm	1p-8x8-13.7mm 1f-d4.8mm																		
	<table border="1"> <tr> <td>Z80686</td> <td>NO. 7770156</td> </tr> <tr> <td colspan="2"><i>Mola de friso</i></td> </tr> <tr> <td colspan="2">LANCIA YPSILON</td> </tr> <tr> <td>NULL</td> <td>NULL</td> </tr> </table>	Z80686	NO. 7770156	<i>Mola de friso</i>		LANCIA YPSILON		NULL	NULL		<table border="1"> <tr> <td>Z80695</td> <td>NO. 46537978</td> </tr> <tr> <td colspan="2"><i>Mola de friso</i></td> </tr> <tr> <td colspan="2">LANCIA YPSILON</td> </tr> <tr> <td>17x15x18.7mm</td> <td>1p-8x8-15mm</td> </tr> </table>	Z80695	NO. 46537978	<i>Mola de friso</i>		LANCIA YPSILON		17x15x18.7mm	1p-8x8-15mm
Z80686	NO. 7770156																		
<i>Mola de friso</i>																			
LANCIA YPSILON																			
NULL	NULL																		
Z80695	NO. 46537978																		
<i>Mola de friso</i>																			
LANCIA YPSILON																			
17x15x18.7mm	1p-8x8-15mm																		
	<table border="1"> <tr> <td>Z80702</td> <td>NO. 46408953 - 46748771</td> </tr> <tr> <td colspan="2"><i>Mola de fixação</i></td> </tr> <tr> <td colspan="2">LANCIA YPSILON</td> </tr> <tr> <td>d16x25.5mm</td> <td>1p-8x8-24mm 1f-d4.8mm</td> </tr> </table>	Z80702	NO. 46408953 - 46748771	<i>Mola de fixação</i>		LANCIA YPSILON		d16x25.5mm	1p-8x8-24mm 1f-d4.8mm										
Z80702	NO. 46408953 - 46748771																		
<i>Mola de fixação</i>																			
LANCIA YPSILON																			
d16x25.5mm	1p-8x8-24mm 1f-d4.8mm																		