

	<p><b>A1384</b> NO. 1040404 - 94AB 6B049CF - 94AB.6B049.CF - 1012895</p> <p>APOIO DO MOTOR DE TRÁS</p> <p>FORD 1.6 16V (1995 A 1998) - 1.8 16V XR3 - 1.8i 16V (1992 A 1995) - 1.8D (1988 A 1999) - 1.8 TD (1993 A 2000)</p> <p>160x100x70mm 1p-d12-30mm</p>		<p><b>A1592</b> NO. M4C3007COM - 36499KOM</p> <p>APOIO DA TRANSMISSÃO</p> <p>FORD</p> <p>195x105x75mm 1f-d30mm</p>
	<p><b>F1088-I</b> NO. E1F2</p> <p>FOLE DA DIRECÇÃO</p> <p>FORD AMERICA F2</p> <p>d60x195mm 1f-d45mm 1f-d10mm</p>		<p><b>H813</b> NO.</p> <p>PALA MEIA LUA GRANDE</p> <p>FORD</p> <p>510x226x5mm NULL</p>
	<p><b>L0014</b> NO.</p> <p>CASQUILHO DE AMORTECEDORES (CÔNICOS)</p> <p>FORD</p> <p>d30x19mm d26mm 1f-d16mm</p>		<p><b>M6089</b> NO. 3250969 - 3846629</p> <p>JUNTA DE ESCAPE</p> <p>FORD ECONOVAN (APÓS 1995)</p> <p>108x68x1.5mm 1f-d58mm</p>
	<p><b>S1034</b> NO. 81DB5348AA</p> <p>SILENT-BLOC DE MOLAS</p> <p>FORD CARGO</p> <p>d51x78mm c76mm 1f-d20mm</p>		<p><b>UMV25711</b> NO. 8L071184</p> <p>MANETE ALAVANCA VELOCIDADES</p> <p>FORD - ADPATAVEL TODOS MODELOS COM HASTE 12mm</p> <p>110x51x38mm 1pino-d15mm</p>
	<p><b>Z00531</b> NO. 1470998 - 207217563 - N0154322</p> <p>Mola porca rápida</p> <p>FORD (TODOS)</p> <p>24.6x16.2x5.5mm 1f-d6.3mm</p>		<p><b>Z01561</b> NO. 211837223</p> <p>Mola porca rápida</p> <p>FORD (TODOS)</p> <p>24x11x4mm 1f-d4.2mm</p>
	<p><b>Z80219</b> NO.</p> <p>Mola de friso</p> <p>Ford</p> <p>19x15x12.6mm 1p-d4.5-4.5mm</p>		<p><b>Z80459</b> NO. 823867299</p> <p>Mola de painel</p> <p>FORD (TODOS)</p> <p>d18x21.2mm 1p-d7.6-14.2mm</p>
	<p><b>Z80470</b> NO. 164361 - 7703072177</p> <p>Mola de fixação</p> <p>FORD (TODOS)</p> <p>d5x45mm NULL</p>		<p><b>Z80624</b> NO. 7M0883069</p> <p>Mola de painel</p> <p>FORD (TODOS)</p> <p>d20.5x19mm 1p-d8.8-13mm</p>
	<p><b>Z80684</b> NO. 1800940 - 90127883 - 16131176747</p> <p>Mola de retenção</p> <p>FORD (TODOS)</p> <p>d16x10mm 1f-d6mm</p>		<p><b>Z80757</b> NO. 7703079338 - 6992H3</p> <p>Mola de painel</p> <p>FORD (TODOS)</p> <p>47.5x10x45.5mm 1p-d8-9mm</p>





	<p><b>A1780</b> NO. 1345657 - 1567937 - 3M516F012.BH - 31277669 - 3M516F012BG - 1437549 - 123092 - 1250618</p> <p><b>APOIO DO MOTOR FRENTE</b></p> <p>FORD FOCUS C-MAX 1.6 TDCi (G8DA) 109CV (10-2003 A 03-2007) - 1.6 TDCi (HHDA - HHDB) 90CV (02-2005 A 03-2007)</p> <p>256x140x120mm 1f-d12mm 1f-d13mm 2f-18x20mm</p>		<p><b>A1823</b> NO. 1370378 - 3M516P090AC</p> <p><b>APOIO DA CAIXA DE VELOCIDADES</b></p> <p>FORD C-MAX (DM2) 1.6 (02.07 - 09.10) 100cv 1596cc - FORD C-MAX (DM2) 1.6 (04.07 - 09.10) 116cv 1596cc - FORD C-MAX (DM2) 1.8 (02.07 - 09.10) 122cv 1798cc - FORD C-MAX (DM2) 1.8 (02.07 - 09.10) 125cv 1798cc - FORD C-MAX (DM2) 1.8 Flexifuel (02.07 - 09.10)</p> <p>72X67X40mm 3f-d12mm</p>
	<p><b>A1824</b> NO. 1347798 - 1224051 - 1256701 - 3M516P093AE - 3M516P093AC</p> <p><b>APOIO DA CAIXA DE VELOCIDADES</b></p> <p>FORD FOCUS C-MAX 1.6 TDCi (02.05 - 03.07) 90cv 1560cc - FORD FOCUS C-MAX 1.6 TDCi (10.03 - 03.07) 109cv 1560cc - FORD FOCUS C-MAX 1.8 TDCi (01.05 - 03.07) 115cv 1753cc - FORD FOCUS C-MAX 2.0 TDCi (10.03 - 03.07) 136cv 1997cc - FORD FOCUS II (DA_) 1.6 TDCi</p> <p>170X130X80mm 2f-d10mm 2f-d12mm</p>		<p><b>A1825</b> NO. 1490983 - 1233950 - 3M5118A116AB - 3M5118A116GB - 1300459 - BR55-28-910E</p> <p><b>APOIO DO AMORTECEDOR DE TRÁS</b></p> <p>FORD C-MAX (DM2) 1.6 (02.07 - 09.10) 100cv 1596cc - FORD C-MAX (DM2) 1.6 (04.07 - 09.10) 116cv 1596cc - FORD C-MAX (DM2) 1.8 (02.07 - 09.10) 122cv 1798cc - FORD C-MAX (DM2) 1.8 (02.07 - 09.10) 125cv 1798cc - FORD C-MAX (DM2) 1.8 Flexifuel (02.07 - 09.10)</p> <p>125x60x40mm 3f-d8mm</p>
	<p><b>A1827</b> NO. 1308719 - 1308718 - 1334230 - 1230960 - 1305954 - 1365854 - 1255747 - 1377471 - 1377612 - 1320605 - ...</p> <p><b>APOIO DO AMORTECEDOR DA FRENTE DIREITO E ESQUERDO</b></p> <p>FORD C-MAX (DM2) 1.6 (02.07 - 09.10) 100cv 1596cc Veículo multiuso - FORD C-MAX (DM2) 1.6 (04.07 - 09.10) 116cv 1596cc Veículo multiuso - FORD C-MAX (DM2) 1.8 (02.07 - 09.10) 122cv 1798cc Veículo multiuso - FORD C-MAX (DM2) 1.8 (02.07 - 09.10) 125cv 1798cc</p> <p>140x32mm 1f-d12mm 3f-d8mm</p>		<p><b>A1829</b> NO. 1235847 - 1224260 - 3M5H8B204AB - 3M5H8B204AA - 1244260</p> <p><b>APOIO DO RADIADOR</b></p> <p>FORD C-MAX (DM2) 1.6 (02.07 - 09.10) 100cv 1596cc - FORD C-MAX (DM2) 1.8 (02.07 - 09.10) 122cv 1798cc - FORD C-MAX (DM2) 1.8 (02.07 - 09.10) 125cv 1798cc - FORD C-MAX (DM2) 1.8 Flexifuel (02.07 - 09.10) 125cv 1798cc - FORD C-MAX (DM2) 2.0 (02.07 - 09.10)</p> <p>38x38mm 1f-d14mm</p>
	<p><b>KF9016</b> NO. 1676324 - 1493023A - 1322210 - 1439850 - 7M514C062CB - 7M514C062AA - 1322212 - 1344655 - 1346550 - ...</p> <p><b>KIT DE FOLE DO CARDAN JUNTO À RODA E CAIXA LADO DIREITO</b></p> <p>FORD C-MAX (DM2) 1.6 TDCi (02.07 - 09.10) 90cv 1560cc - FORD C-MAX (DM2) 1.8 TDCi (02.07 - 09.10) 115cv 1753cc - FORD FOCUS II (DA_) 1.6 TDCi Hatchback (01.05 - 09.12) 90cv 1560cc - FORD FOCUS II (DA_) 1.6 TDCi Hatchback (11.04 - 09.12) 109cv 1560cc - FOR</p> <p>110x120mm - 90x100mm 1f-d85mm 1f-d35mm - 1f-80mm 1f-d35mm</p>		<p><b>KF9017</b> NO. 1676323 - 1493022 - 1439366 - 1359667 - 7M514C062BB - 7M514C062BA - 3M514A084BB - 3M514A084BC - 3M514A084BD - ...</p> <p><b>KIT DE FOLE DO JUNTO À CAIXA E RODA LADO ESQUERDO</b></p> <p>FORD C-MAX (DM2) 1.6 TDCi (02.07 - 09.10) 90cv 1560cc - FORD C-MAX (DM2) 1.6 TDCi (02.07 - 09.10) 101cv 1560cc - FORD C-MAX (DM2) 1.6 TDCi (02.07 - 09.10) 109cv 1560cc - FORD C-MAX (DM2) 1.8 TDCi (02.07 - 09.10) 115cv 1753cc - FORD FOCUS C-MAX 1.6 TDCi (0)</p> <p>110x120mm - 90x100mm 1f-d85mm 1f-d29mm - 1f-80mm 1f-d25</p>
	<p><b>KF9020</b> NO. 1493023 - 1493017 - 1676324 - 1302513 - 1359669 - 1439367 - 1439850 - 1485324 - 3M514A084CC - 3M514A...</p> <p><b>KIT DE FOLE DO CARDAN LADO DA CAIXA</b></p> <p>FORD C-MAX (DM2) 1.6 TDCi (02.07 - 09.10) 90cv 1560cc - FORD C-MAX (DM2) 1.6 TDCi (02.07 - 09.10) 101cv 1560cc - FORD C-MAX (DM2) 1.6 TDCi (02.07 - 09.10) 109cv 1560cc - FORD C-MAX (DM2) 1.8 TDCi (02.07 - 09.10) 115cv 1753cc - FORD FOCUS C-MAX 1.6 TDCi (0)</p> <p>90x100mm 1f-80mm 1f-d35mm</p>		<p><b>KF9021</b> NO. 1676323 - 1493022A - 1359667 - 1359670 - 1438787 - 1439366 - 1485325 - 1493016 - 1493022 - 1676321 - ...</p> <p><b>KIT DE FOLE DO CARDAN JUNTO À CAIXA LADO ESQUERDO</b></p> <p>FORD C-MAX (DM2) 1.6 TDCi (02.07 - 09.10) 90cv 1560cc - FORD C-MAX (DM2) 1.6 TDCi (02.07 - 09.10) 101cv 1560cc - FORD C-MAX (DM2) 1.6 TDCi (02.07 - 09.10) 109cv 1560cc - FORD C-MAX (DM2) 1.8 TDCi (02.07 - 09.10) 115cv 1753cc - FORD FOCUS C-MAX 1.6 TDCi (0)</p> <p>90x100mm 1f-25mm 1f-80mm</p>
	<p><b>R8133</b> NO. 1439410 - 1672189 - 6M516C646GA - 6M516C646GC</p> <p><b>TUBO DO TURBO SOBREALIMENTAÇÃO</b></p> <p>FORD C-MAX (DM2) 1.6 TDCi (02.07 - 09.10) 90cv 1560cc Veículo multiuso - FORD C-MAX (DM2) 1.6 TDCi (02.07 - 09.10) 101cv 1560cc Veículo multiuso - FORD C-MAX (DM2) 1.6 TDCi (02.07 - 09.10) 109cv 1560cc Veículo multiuso - FORD FOCUS II (DA_) 1.6 TDCi (01.0)</p> <p>B300-d47/44mm 130-180-100mm</p>		<p><b>RT80388</b> NO. 1387264</p> <p><b>TUBO DE TRAVÃO FRENTE LH-RH</b></p> <p>FORD C-MAX TT (APÓS 02-2007)</p> <p>435mm FB78 - MCL2</p>
	<p><b>RT80450</b> NO. 1379911 - 1671020</p> <p><b>TUBO DE TRAVÃO FRENTE LH-RH</b></p> <p>FORD S-MAX 1.8 TDCi (APÓS 05-2006) - S-MAX 2.0 (APÓS 05-2006) - S-MAX 2.0 TDCi (APÓS 05-2006) - S-MAX 2.2 TDCi (APÓS 03-2008) - S-MAX 2.5 ST (APÓS 05-2006) - S-MAX 2.3 (APÓS 07-2007)</p> <p>420mm FB76 - MC64</p>		<p><b>S1505</b> NO. 1570748 - 1570750 - 1723324 - 1723323 - 1420795 - 1420858 - 1234375 - 1234371 - 1355151 - 1355149 - ...</p> <p><b>SILENT BLOC DO BRAÇO DA SUSPENSÃO DA FRENTE</b></p> <p>FORD - C-MAX - 1.6 Veículo multiuso 100CV 1596cc (APÓS 02-2007) - 1.8 Veículo multiuso 122CV 1798cc (APÓS 02-2007) - 1.8 Veículo multiuso 125CV 1798cc (APÓS 02-2007) - 1.8 Flexifuel Veículo multiuso 125CV 1798cc (APÓS 02-2007) - 2.0 Veículo multiuso 145CV</p> <p>d45x65mm d40.5mm 1f-d14mm</p>
	<p><b>W5120</b> NO. 1147683 - 1319519 - 1369546 - 1473366 - 1485765 - 1517975 - 1517976 - 2S606B319AD - 2S606B319AB - 2S...</p> <p><b>POLIE DA CABBOTA (6 PISTAS)</b></p> <p>FORD - C-MAX (DM2) - 1.6 TDCi Ano fabric. até: (12.09) (02.07 - 09.10) 90cv 1560cc Veículo multiuso - FORD - C-MAX (DM2) - 1.6 TDCi Ano fabric. até: (12.09) (02.07 - 09.10) 101cv 1560cc Veículo multiuso - FORD - C-MAX (DM2) - 1.6 TDCi Ano fabric. até: (1)</p> <p>d150/162mm d29,5mm</p>		<p><b>W5136</b> NO. 1131911 - 1198049 - 1339469 - 1711500 - 1S4Q6B319BD - 2M5Q6B319AA - 4M5Q6B319BA - 4M5Q6B319EA</p> <p><b>POLIE DA CABBOTA 6 PISTAS</b></p> <p>FORD C-MAX (DM2) 1.8 TDCi (02.07 A 09.10) 115cv 1753cc Veículo multiuso - FORD FOCUS (DAW - DBW) 1.8 TDCi (03.01 A 11.04) 115cv 1753cc Hatchback - FORD FOCUS Combi (DNW) 1.8 TDCi (03.01 A 11.04) 115cv 1753cc Combi - FORD FOCUS C-MAX 1.8 TDCi (01.05 A 03.07) 115cv 1753cc Veículo multiuso - FORD FOCUS II (DA_) 1.8 TDCi (01.05 A 09.12) 115cv 1753cc Hatchback - FORD FOCUS II Combi (DA_) 1.8 TDCi (07.04 A 09.12) 115cv 1753cc Combi - FORD TRANS...etc.</p> <p>d146mm d14mm</p>

	<b>Z80848</b>	NO. 1257376		
	Mola de painel FORD C-MAX (De 2003 A 2010)			
	d18x27.5mm	1p-d8.5-10.5mm		

FORD CAPRI-CONSUL-GRANADA

	<b>D0037</b>	NO. 1515117 - 1638947 - 6518778 - 83BG4684BA - 83GB4684BA - 88GG4684BA - GAF41		<b>E0008</b>	NO. 801909 - 0801909
	CARDAN TRANSMISSÃO FORD GRANADA (GGTL, GGFL) 1.7 (03.72 A 02.75) 75cv 1699cc três volumes - FORD GRANADA (GGTL, GGFL) 2.0 (01.75 A 08.77) 90cv 1998cc três volumes - FORD GRANADA (GGTL, GGFL) 2.3 (01.75 A 08.77) 108cv 2294cc três volumes - FORD GRANADA (GU) 1.6 Ano fabric. a part ir de: 08.82, (07.81 A 08.85) 75cv 1593cc três volumes - FORD GRANADA (GU) 1.7 Ano fabric. até: 08.81, (08.77 A 05.82) 70cv 1699cc três volumes 5 / 9 - FORD GRANADA (GU) 1.7...etc.			ESTICADOR DE ESCAPE FORD CAPRI 1300 - 1600 - 2000 - CONSUL (72-75) - GRANADA - GRANADA (72-85)	
	120x135x40x46mm	6f-12x12mm		d44x40mm	NULL
	<b>F0456-I</b>	NO. 1451308 - 1454203 - 1512346 - 6060790		<b>F0457-I</b>	NO. 1454202 - 1467265 - 6060786
	FOLE DA CREMALHEIRA DA DIRECÇÃO DIREITO (F1034) FORD CAPRI TT (excepto 3000)			FOLE DA CREMALHEIRA DA DIRECÇÃO ESQUERDO (F1035) FORD CAPRI TT (excepto 3000)	
	d55x160mm	1f-d33mm 1f-d9mm		d55x120mm	1f-d43mm 1f-d9mm
	<b>F0462-I</b>	NO. 1568353 - 1568676		<b>F0463-I</b>	NO. 1568355
	FOLE DA CREMALHEIRA DA DIRECÇÃO ESQ. E DIR. FORD CAPRI 3000 (CAM RACK) (69 A 81)			FOLE DA DIRECÇÃO ESQUERDO FORD CAPRI 3000	
	d65x150mm	1f-d47mm 1f-d9mm		d62x205mm	1f-d26mm 1f-d10mm
	<b>F0687-I</b>	NO. 1610365 - 83BB3K661AA - 1160365		<b>F0687-I</b>	NO. 1610365 - 83BB3K661AA - 1160365
	FOLE DA DIRECÇÃO FORD GRANADA (APÓS 1985)			FOLE DA DIRECÇÃO FORD GRANADA (APÓS 1985)	
	d60x230mm	1f-d48mm 1f-d10mm		d60x230mm	1f-d48mm 1f-d10mm
	<b>F4022</b>	NO. 1568353		<b>F4023</b>	NO. 1568355
	FOLE DA DIRECÇÃO ESQUERDO FORD CAPRI 3.0 (1974 A 1977) - FORD CONSUL 3000 (1972 A 1975)			FOLE DA DIRECÇÃO DIREITO FORD CAPRI 3.0 (1974 A 1977) - FORD CONSUL 3000 (1972 A 1975)	
	d65x140mm	1f-d48mm 1f-d10mm		d62x210mm	d44mm 1f-d27mm 1f-d10mm
	<b>L1030</b>	NO. 1412951 - 6100095 - 1421951		<b>L3043</b>	NO. 1481463 - 71BB.5K498.BB
	CASQUILHO DE BRAÇOS DE SUSPENSÃO FORD CAPRI			CASQUILHO DAS PONTAS DA BARRA ESTABILIZADORA FORD CONSUL	
	d41x37mm	1f-d20mm		d28x42mm	1f-d10mm

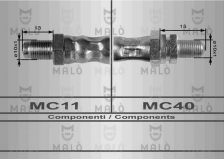
# FORD CAPRI-CONSUL-GRANADA

	<b>L3043</b>	NO. 1481463 - 71BB.5K498.BB		<b>M6079</b>	NO. 6027648 - 1709852 - 749451BA
	CASQUILHO DAS PONTAS DA BARRA ESTABILIZADORA FORD GRANADA			JUNTA DE ESCAPE FORD CAPRI (1974 A 1985) - GRANADA (1972 A 1985)	
	d28x42mm	1f-d10mm		54x13mm	1f-d41mm
	<b>M6108</b>	NO. 6026339		<b>N1617</b>	NO.
	JUNTA DE ESCAPE FORD GRANADA (75-82)			ANEL DE ESCAPE FORD CAPRI MK I 1300 - 1600	
	57x14mm	1f-d43mm		d65x13mm	1f-d40mm
	<b>RT08565</b>	NO. 6179304 - 6714710 - 1027745 - 6132910 - 91FB2282AA		<b>RT08600</b>	NO. 6125634 - 1638393 - 1666247 - 1666460
	TUBO DE TRAVÃO TRÁS LH-RH FORD GRANADA TT (02-1985 A 1991)			TUBO DE TRAVÃO TRÁS LH-RH FORD GRANADA TT (02-1985 A 1991)	
	340mm	MC40 - MC40		355mm	MC11 - MC40
	<b>S1384</b>	NO. 72GB3068AC - 1520587			
	SILENT-BLOC DO BRAÇO DA SUSPENSÃO DA FRENTE PARTE SUPERIOR FORD GRANADA				
	d45x42mm	d32mm 1f-d14mm			

## FORD CORTINA- P100 PICK-UP

	<b>A0644</b>	NO. 3034E - 691F-6038B		<b>A0644P</b>	NO. 3034E - 691F-6038AB
	SUPORTE DO MOTOR S/ PERNO FORD CORTINA			SUPORTE DO MOTOR C/ PERNO FORD CORTINA	
	128x91x86mm	1r-d8mm		135x92x90mm	1p-d10-22mm
	<b>E0008</b>	NO. 801909 - 0801909		<b>E0008</b>	NO. 801909 - 0801909
	ESTICADOR DE ESCAPE FORD CORTINA MK III - MK IV			ESTICADOR DE ESCAPE FORD TAUNUS (70-83)	
	d44x40mm	NULL		d44x40mm	NULL
	<b>F0462-I</b>	NO. 1568353 - 1568676		<b>F0463-I</b>	NO. 1568355
	FOLE DA CREMALHEIRA DA DIRECÇÃO ESQ. E DIR. FORD CORTINA			FOLE DA DIRECÇÃO ESQUERDO FORD CORTINA - TAUNUS - CAPRI 3000 - P100 PICK UP	
	d65x150mm	1f-d47mm 1f-d9mm		d62x205mm	1f-d26mm 1f-d10mm



	<p><b>F0599-M</b> NO. 428028</p> <p>FOLE DA TRANSMISSÃO</p> <p>FORD CORTINA</p> <p>d87x83mm 1f-d74mm 1f-d13mm</p>		<p><b>F4022</b> NO. 1568353</p> <p>FOLE DA DIRECÇÃO ESQUERDO</p> <p>FORD CORTINA 1100 (1970 A 1972)</p> <p>d65x140mm 1f-d48mm 1f-d10mm</p>
	<p><b>F4022</b> NO. 1568353</p> <p>FOLE DA DIRECÇÃO ESQUERDO</p> <p>FORD TAUNUS 12M 1.3 (1966 A 1971)</p> <p>d65x140mm 1f-d48mm 1f-d10mm</p>		<p><b>F4023</b> NO. 1568355</p> <p>FOLE DA DIRECÇÃO DIREITO</p> <p>FORD CORTINA 1100 (1970 A 1972)</p> <p>d62x210mm d44mm 1f-d27mm 1f-d10mm</p>
	<p><b>L0221</b> NO.</p> <p>CASQUILHO DE MOLAS</p> <p>FORD CORTINA</p> <p>d24x35mm d20mm 1f-d12mm</p>		<p><b>L1030</b> NO. 1412951 - 6100095 - 1421951</p> <p>CASQUILHO DE BRAÇOS DE SUSPENSÃO</p> <p>FORD CORTINA</p> <p>d41x37mm 1f-d20mm</p>
	<p><b>L3008</b> NO. 1610371</p> <p>CASQUILHO DA DIRECÇÃO</p> <p>FORD CORTINA 1100 (01-1970 A 03-1972)</p> <p>35x35x18mm 1f-d22mm</p>		<p><b>L3015</b> NO.</p> <p>CASQUILHO DA BARRA ESTABILIZADORA</p> <p>FORD CORTINA</p> <p>d48x18mm 1f-d16mm</p>
	<p><b>L3041</b> NO. 6005983 - 74BB.3B197.AA</p> <p>CASQUILHO DA BARRA ESTABILIZADORA</p> <p>FORD CORTINA - TAUNUS (1976 A 1992)</p> <p>d50x17mm 1f-d20mm</p>		<p><b>N1617</b> NO.</p> <p>ANEL DE ESCAPE</p> <p>FORD CORTINA</p> <p>d65x13mm 1f-d40mm</p>
	<p><b>N2002</b> NO. 1719466 - 113E5381B</p> <p>ANEL DE ESCAPE</p> <p>FORD CORTINA 1200 - 1300 - 1500 - GT</p> <p>d43x12mm 1f-d19mm</p>		<p><b>S1039</b> NO. 6099528 - 81BB.5K789.AA</p> <p>SILENT-BLOC DE VAUS DE SUSPENSÃO (FURO 13mm)</p> <p>FORD CORTINA</p> <p>d39x46mm c32mm 1f-d13mm</p>
	<p><b>S1047</b> NO. 6099529 - 81BB.5K790.AA</p> <p>SILENT-BLOC DO TRIANGULO DA SUSPENSÃO</p> <p>FORD CORTINA</p> <p>d43x65mm c52mm 1f-d12mm</p>		<p><b>T0003</b> NO. 204460 - 0204460</p> <p>BATENTE DA BARRA ESTABILIZADORA</p> <p>FORD CORTINA</p> <p>41x39x36mm 1f-d18mm</p>

	<p><b>A1388</b> NO. 6838725 - 93BB.18198.BC</p> <p>APOIO DA SUSPENSÃO DE TRÁS (AMORTECEDOR)</p> <p>FORD COUGAR 2.0 16V - 2.5 V6 24V - 2.5 ST 200</p> <p>174x172x44mm 1f-d12mm 2f-d8mm</p>		<p><b>A1591</b> NO. 1024959 - 1097914 - 98BB.6P082.AA - 6803993 - 6911968</p> <p>APOIO DO MOTOR PARTE DE TRÁS CAIXA DE VELOCIDADES</p> <p>FORD COUGAR (EC) 2.0 16V 08-98 A 12-01</p> <p>140x130x125mm 1f-d20mm</p>
	<p><b>A1593</b> NO. 6799585 - 1793880 - 93BB.3K155.AC - 93BJ.3K155.AC - 93BB3K1555AC</p> <p>APOIO DO AMORTECEDOR DA FRENTE</p> <p>FORD COUGAR (EC-) 2.0 16V 08-98 A 12-01 - 2.5 ST 200 - 2.5 V6 24V 09-98 A 12-01 - MONDEO I (GBP) 1.6 i 16V - 1.8 16V - 1.8 TD - 2.0 i 16V 02-93 A 08-96 MONDEO I COMBI (BNP) 1.6 i 16V - 1.8 i 16V - 1.8 TD - 2.0 i 16V 04-93 A 08-96 - MONDEO I TRÊS VOLUMES</p> <p>d120x51mm 1f-d12mm</p>		<p><b>C0231</b> NO. 6483712 - 91AB.16C618.AA</p> <p>BOTÃO DE AFINAÇÃO DE CAPOT</p> <p>FORD COUGAR (1998 A 2000)</p> <p>d27x44mm NULL</p>
	<p><b>F1618-I</b> NO. 3904122 - 6772173 - F6RC.3K661.AA - 157C3K661AB - 4119193</p> <p>FOLE DA DIREÇÃO ASSISTIDA LADO DIREITO E ESQUERDO</p> <p>FORD COUGAR APÓS 1998 2.0 16V - 2.5i V6 24V</p> <p>d58x215mm 1f-d55mm 1f-d15mm</p>		<p><b>F1659E-I</b> NO. 6757645</p> <p>FOLE DA TRANSMISSÃO JUNTO À CAIXA</p> <p>FORD COUGAR 2.0 16V - 2.5i V6 24V (APÓS 98)</p> <p>d96x126mm 1f-d85mm 1f-d25mm</p>
	<p><b>F1835-T</b> NO. 1073937 - 3940332 - F8RZ3A331C</p> <p>FOLE DA TRANSMISSÃO JUNTO À RODA</p> <p>FORD COUGAR 2.0 16V - 2.5i V6 24V (APÓS 1998)</p> <p>d96x135mm 1f-d89mm 1f-d25mm</p>		<p><b>F4021</b> NO. F33.3K661.AA - 3904122 - F6RC3K661AA</p> <p>FOLE DA DIREÇÃO ASSISTIDA DIREITO E ESQUERDO</p> <p>FORD COUGAR 2.0 - 2.5i (APÓS 1998)</p> <p>d62x210mm d58mm d51mm 1f-d53mm 1f-d16mm</p>
	<p><b>KF9000</b> NO. 1073937 - 3940332 - F8RZ3A331C</p> <p>KIT DE FOLE LADO DA RODA</p> <p>FORD COUGAR 2.0 - 2.5I (APÓS 1998)</p> <p>d95x135mm 1f-d92mm 1f-d25mm</p>		<p><b>RT08648</b> NO. 1025018 - 1071639</p> <p>TUBO DE TRAVÃO TRÁS LH-RH</p> <p>FORD MONDEO II TRE VOLUMI 1.6 i (09-1996 A 11-2000) - MONDEO II TRE VOLUMI 1.6 i 16V (05-1998 A 11-2000) - MONDEO II TRE VOLUMI 1.8 i (09-1996 A 11-2000) - MONDEO II TRE VOLUMI 1.8 D (09-1996 A 11-2000) - MONDEO II TRE VOLUMI 2.0 i (09-1996 A 11-2000)</p> <p>580mm NULL</p>
	<p><b>S1445</b> NO. 6829045 - 935K653AB - 93BB-5500-AC - 93BB-5500-AD - 1S71-5500-AA - 93BB-5K653-AB - 1S71-5K743-CA - 1...</p> <p>SILENT-BLOC DO BRAÇO DA SUSPENSÃO</p> <p>FORD COUGAR 2.0 16V - 2.5 V6 24V - 2.5 ST 200 (98 A 2001)</p> <p>d36.5x35mm c28mm 1f-12.2mm</p>		<p><b>T1051</b> NO. 6714195</p> <p>BATENTE DO CENTRO DA BARRA ESTABILIZADORA (FURO DIÂMETRO 20mm)</p> <p>FORD COUGAR 2.0 16V - 2.5 V6 24V - 2.5 ST200 (1998 A 2001)</p> <p>43x39x30mm 1f-d20mm</p>
	<p><b>W5035</b> NO. 1135052</p> <p>POLIE DA CAMBOTA (6 PISTAS)</p> <p>FORD COUGAR 2.0 16V</p> <p>d132mm d28mm</p>		<p><b>Z80787</b> NO. 1039463 - 8E0825267</p> <p>Mola de fixação</p> <p>FORD COUGAR</p> <p>d20x34mm 1p-d8.5-21mm</p>

















	<p><b>A0292</b> NO. 6140218 - 6140223 - 81AB6B032AK</p> <p>SUPORTE TRÁS E FRENTE DA CAIXA</p> <p>FORD ESCORT - ORION 1.1 - 1.3 - 1.6 (APÓS 2-82 A 1-86)</p> <p>130x92x55mm 1f-d12mm</p>		<p><b>A0644</b> NO. 3034E - 691F-6038B</p> <p>SUPORTE DO MOTOR SI/PERNO</p> <p>FORD ESCORT (1966 - 70)</p> <p>128x91x86mm 1r-d8mm</p>
	<p><b>A0644P</b> NO. 3034E - 691F-6038AB</p> <p>SUPORTE DO MOTOR C/PERNO</p> <p>FORD ESCORT (1966 - 70)</p> <p>135x92x90mm 1p-d10-22mm</p>		<p><b>A0960</b> NO. 1454275 - 1515124 - 72HF.6068.AB - 72HF6068AA - 711F6068AB</p> <p>SUPORTE TRÁS DO MOTOR</p> <p>FORD ESCORT (O.9-1.1-1.3-1.6) - ESCORT DIESEL - FORD ORION (1.3-1.4-1.6) - ORION DIESEL (1.6-1.8)</p> <p>166x97x55mm 1f-d13mm</p>
	<p><b>A1036</b> NO. 6845223 - 6845225 - 91AB.6L028.CB</p> <p>APOIO INFERIOR DA FRENTE DO MOTOR LADO CAIXA</p> <p>FORD ESCORT GASOLINA 0.9 - 1.1 - 1.3 - 1.4 - 1.6 (1981 A 1999) - 1.8 TD (1995 A 2001) - FORD ORION 1.3 - 1.4 - 1.6 - 1.8i 16V (1983 A 1993) - 1.8 D (1989 A 1993) - 1.8 TD (1992 A 1993)</p> <p>NULL NULL</p>		<p><b>A1037</b> NO. 86AB6038DB - 6160229 - 6157620</p> <p>APOIO DIREITO DO MOTOR</p> <p>FORD ESCORT 1.6D (1984 A 1989) - FORD ORION 1.6D (1984 A 1989)</p> <p>152x85x60mm 1f-d12mm</p>
	<p><b>A1057</b> NO. 1640021 - 6133904 - 6161628 - 84FB6038CD</p> <p>SUPORTE DIREITO FRENTE DO MOTOR</p> <p>FORD ESCORT 1.3 - 1.4 - 1.6 (1980 A 1995) - FORD ORION 1.3 (1983 A 1986)</p> <p>130x110x50mm 3p-d10-27mm 1r-d6mm</p>		<p><b>A1318</b> NO. 6172938</p> <p>SUPORTE DE TRÁS DO MOTOR</p> <p>FORD ESCORT 1.1 - 1.3 - 1.4 - 1.6 - 1.6i - 1.6 TURBO - 1.6D - 1.8D (1980 A 1996) - ORION 1.3 - 1.6 - 1.6i - 1.6D (1983 A 1986)</p> <p>140x109x105mm 1p-d10-35mm</p>
	<p><b>A1380</b> NO. 7350847 - 95AB3K155AD</p> <p>APOIO DA SUSPENSÃO DA FRENTE</p> <p>FORD ESCORT 1.3 - 1.4 - 1.4i - 1.6 16V - 1.8i 16V - 1.8 16V XR3 (1970 A 2000) - 1.8D - 1.8TD (1988 A 2001)</p> <p>145x145x40mm 3p-d8-17mm</p>		<p><b>A1382</b> NO. 6548783 - 91AB8125AC</p> <p>APOIO DO RADIADOR</p> <p>FORD ESCORT (08-1990 A 09-2001) - FORD ORION (08-1990 A 09-2001)</p> <p>d32x33mm 1f-d13mm</p>
	<p><b>A1385</b> NO. 6179974 - 77BM6K255AC - 1113176 - 77BM.6K255.AF</p> <p>APOIO DO TENSOR DE EMBRAIAGEM</p> <p>FORD ESCORT</p> <p>63x16x13mm NULL</p>		<p><b>A1385</b> NO. 6179974 - 77BM6K255AC - 1113176 - 77BM.6K255.AF</p> <p>APOIO DO TENSOR DE EMBRAIAGEM</p> <p>FORD ORION (APÓS 1981)</p> <p>63x16x13mm NULL</p>
	<p><b>A1390</b> NO. 92AB6B049BA - T102901 - T057300 - 91AB6P071EA - 92AB6P071BA - 6766044 - 6610305</p> <p>APOIO DO MOTOR DE TRÁS</p> <p>FORD ESCORT (1993 A 1995)</p> <p>d87x90mm c56 2f-d13mm 1f-d18mm</p>		<p><b>A1396</b> NO. 6137369 - 6532935 - 85HF6038EB</p> <p>SUPORTE DO MOTOR DIREITO E ESQUERDO</p> <p>FORD ESCORT DIESEL (ATÉ 1991) - ORION DIESEL</p> <p>d108x89mm 1p-d10-27mm 1p-d10-57mm</p>
	<p><b>A1399</b> NO. 6793344</p> <p>SUPORTE DE MOTOR DIREITO</p> <p>FORD ESCORT 1.3 - 1.4 - 1.4i ((1986 A 1999) - 1.8 TD (1995 A 2001) - FORD ORION 1.3 - 1.4 - 1.6 (1983 A 1993)</p> <p>142x120x68mm 1f-d12mm 2p-d10-26mm 2p-d12-37mm</p>		<p><b>A1498</b> NO. 6186726 - 6178901 - 89AB6038BB</p> <p>APOIO MOTOR LADO DIREITO</p> <p>FORD ESCORT 1.8 D (1988 A 1995) - ORION 1.8 DIESEL (1989 A 1993)</p> <p>155x95x61mm 1f-d12mm 1p-d10-26mm</p>













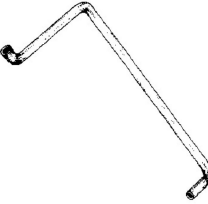
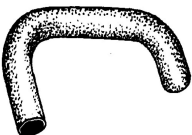

	<p><b>C0231</b> NO. 6483712 - 91AB.16C618.AA</p> <p>BOTÃO DE AFINAÇÃO DE CAPOT</p> <p>FORD ESCORT (APÓS 1995) - FORD ORION (07-1990 A 12-1993)</p>		<p><b>D0012</b> NO. 72GG4684BA</p> <p>CARDAN DA TRANSMISSÃO</p> <p>FORD ESCORT</p>
	<p><b>D0037</b> NO. 1515117 - 1638947 - 6518778 - 83BG4684BA - 83GB4684BA - 88GG4684BA - GAF41</p> <p>CARDAN TRANSMISSÃO</p> <p>FORD ESCORT I (AFH, ATH) 950 (08.68 A 08.74) 34cv 940cc três volumes - FORD ESCORT I (AFH, ATH) 1100 (06.68 A 06.71) 40cv 1098cc três volumes</p>		<p><b>D0037</b> NO. 1515117 - 1638947 - 6518778 - 83BG4684BA - 83GB4684BA - 88GG4684BA - GAF41</p> <p>CARDAN TRANSMISSÃO</p> <p>FORD ESCORT V (GAL) 1.3 Ano fabric. a partir de: 04.92, (07.90 A 09.92) 60cv 1299cc Hatchback - FORD ESCORT V (GAL) 1.4 Ano fabric. a part ir de: 04.92, (07.90 A 09.92) 71cv 1392cc Hatchback - FORD ESCORT V (GAL) 1.6 Ano fabric. a part ir de: 04.92, (07.90 A 08.92) 90cv 1598cc Hatchback - FORD ESCORT V (GAL) 1.6 Ano fabric. a part ir de: 04.92, (07.90 A 12.92) 105cv 1598cc Hatchback - FORD ESCORT V (GAL) 1.8 16V XR3i Ano fabric. a part ir ...etc.</p>
	<p><b>D0037</b> NO. 1515117 - 1638947 - 6518778 - 83BG4684BA - 83GB4684BA - 88GG4684BA - GAF41</p> <p>CARDAN TRANSMISSÃO</p> <p>FORD ESCORT VI (GAL) 1.3 (09.92 A 01.95) 60cv 1299cc Hatchback - FORD ESCORT VI (GAL) 1.4 (01.94 A 01.95) 75cv 1392cc Hatchback - FORD ESCORT VI (GAL) 1.6 i 16V (01.94 A 01.95) 88cv 1597cc Hatchback - FORD ESCORT VI (GAL) 1.6 i 16V (09.92 A 01.95) 90cv 1597cc Hatchback - FORD ESCORT VI (GAL) 1.8 i 16V (09.92 A 01.95) 105cv 1796cc Hatchback - FORD ESCORT VI (GAL) 1.8 XR3i 16V 4x4 (08.93 A 01.95) 105cv 1796cc Hatchback - FORD ESCORT VI ...etc.</p>		<p><b>D0037</b> NO. 1515117 - 1638947 - 6518778 - 83BG4684BA - 83GB4684BA - 88GG4684BA - GAF41</p> <p>CARDAN TRANSMISSÃO</p> <p>FORD ESCORT VII (GAL, AAL, ABL) 1.3 Ano fabric. até: 08.96, (01.95 A 10.98) 60cv 1299cc Hatchback - FORD ESCORT VII (GAL, AAL, ABL) 1.4 Ano fabric. até: 08.96, (01.95 A 10.98) 75cv 1392cc Hatchback - FORD ESCORT VII (GAL, AAL, ABL) 1.6 16V 4x4 (01.95 A 10.98) 90cv 1597cc Hatchback - FORD ESCORT VII (GAL, AAL, ABL) 1.8 16V (01.95 A 08.95) 105cv 1796cc Hatchback - FORD ESCORT VII (GAL, AAL, ABL) 1.8 16V Ano fabric. até: 08.96, (01.95 A 1...etc.</p>
	<p><b>E0008</b> NO. 801909 - 0801909</p> <p>ESTICADOR DE ESCAPE</p> <p>FORD ESCORT (08-1970 A 08-1980)</p>		<p><b>E0010</b> NO. 6048886 - 6053849 - 6111692 - 77FB5A262CA - 77FB5A262BD</p> <p>ESTICADOR DE ESCAPE</p> <p>FORD ESCORT (0.9-1.1-1.3-1.6 - DIESEL) 1.6 - 1.8 (80 A 8-83) - ORION (APÓS 83)</p>
	<p><b>E0012</b> NO. 553769 - 69AB5281BA - 6030483</p> <p>ESTICADOR DE ESCAPE</p> <p>FORD ESCORT CATAL. (02-1975 A 08 1980)</p>		<p><b>E0023</b> NO. 6120254 - 6136012 - 6122002 - 81AB5A262AC - 93BB5A262HA - 6162002 - 6111691 - 87BB3K661AA</p> <p>ESTICADOR DE ESCAPE</p> <p>FORD ORION 1.3 - 1.4 - 1.6 (9-1983 A 8-1991) - ESCORT 0.9 - 1.1 - 1.3 - 1.6 (9-83 A 8-91)</p>
	<p><b>E0100</b> NO. 1130273 - 1661237 - 1061631 - 1071336 - 89FB3B438A1E - 98AG3B438AB - 1067818 - 1S61.3B438.AA - 1E91</p> <p>ESTICADOR DA BARRA ESTABILIZADORA DA FRENTE</p> <p>FORD ESCORT V - VI TT (1990 A 1992 - ESCORT VI TT (1992 A 1995 - ESCORT VII TT APÓS 1995</p>		<p><b>E0262</b> NO. 1107068 - 1111769 - 1135077 - 1209035 - 1471446 - 5S433B438AA - 98AG3B438AD - YS413B438AA - YS413B438A</p> <p>ESTICADOR DA BARRA ESTABILIZADORA DA FRENTE</p> <p>FORD ESCORT V (GAL) - 1.3 (07.90 - 09.92) 60cv 1299cc - FORD - ESCORT V (GAL) - 1.4 (07.90 - 09.92) 71cv 1392cc - FORD - ESCORT V (GAL) - 1.6 (07.90 - 12.92) 105cv 1598cc - FORD - ESCORT V (GAL) - 1.8D (07.90 - 12.92) 60cv 1753cc - FORD - ESCORT V Combi (</p>
	<p><b>E1016</b> NO.</p> <p>ESTICADOR DE ESCAPE</p> <p>FORD ESCORT KAT. (APÓS 09-1992) - ORION KAT. (APÓS 1989)</p>		<p><b>E1017</b> NO. 6905927 - 93AB5A262AA - 7131646 - 93AB.5A262.BA</p> <p>ESTICADOR DE ESCAPE</p> <p>FORD ESCORT KAT (1992 A 10-1995) - FORD ORION KAT (1992 A 1993)</p>
	<p><b>E1029</b> NO. 6882943 - 6827033</p> <p>ESTICADOR DE ESCAPE</p> <p>FORD ESCORT KAT (APÓS 09-1992) - FORD ORION KAT (APÓS 1992)</p>		<p><b>E1070</b> NO. 1016405 - 1003890</p> <p>ESTICADOR DE ESCAPE</p> <p>FORD ESCORT TD (APÓS 1991)</p>





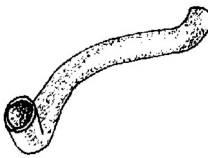



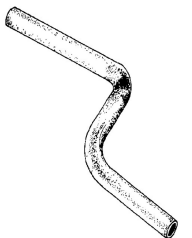



	<p><b>E1087</b> NO. 1022729</p> <p>ESTICADOR DO ESCAPE</p> <p>FORD ESCORT (1995 A 1999)</p> <p>70x50x25mm NULL</p>		<p><b>F0386-I</b> NO. 6047901 - 6079916 - 1470870</p> <p>FOLE DA CREMALHEIRA DA DIRECÇÃO ESQ. E DIR.</p> <p>FORD ESCORT TT (APÓS 80) - ORION TT</p> <p>d59x157mm 1f-d30mm 1f-d10mm</p>
	<p><b>F0387-I</b> NO. 6047900 - 6047904</p> <p>FOLE DA CREMALHEIRA DA DIRECÇÃO ESQ. E DIR.</p> <p>FORD ESCORT III 1.1 - 1.3 - 1.6 - 1.6i (1980 A 1986)</p> <p>d58x127mm 1f-d47mm 1f-d8mm</p>		<p><b>F0456-I</b> NO. 1451308 - 1454203 - 1512346 - 6060790</p> <p>FOLE DA CREMALHEIRA DA DIRECÇÃO DIREITO (F1034)</p> <p>FORD ESCORT (ATÉ 8-79)</p> <p>d55x160mm 1f-d33mm 1f-d9mm</p>
	<p><b>F0457-I</b> NO. 1454202 - 1467265 - 6060786</p> <p>FOLE DA CREMALHEIRA DA DIRECÇÃO ESQUERDO (F1035)</p> <p>FORD ESCORT (ATÉ 8-79)</p> <p>d55x120mm 1f-d43mm 1f-d9mm</p>		<p><b>F0462-I</b> NO. 1568353 - 1568676</p> <p>FOLE DA CREMALHEIRA DA DIRECÇÃO ESQ. E DIR.</p> <p>FORD ESCORT (ATÉ FINS 59) - PICK-UP (81 A 10-82)</p> <p>d65x150mm 1f-d47mm 1f-d9mm</p>
	<p><b>F0538-I</b> NO. 6043191 - 77TTA331FA - 98AX.4A084.BA - 1073846</p> <p>FOLE DO SEMI-EIXO JUNTO À RODA OU CAIXA DE VELOCIDADES</p> <p>FORD ESCORT 1.3 - 1.6 - ORION 1.3 - 1.6</p> <p>d92x100mm 1f-d75mm 1f-d20mm</p>		<p><b>F0539-I</b> NO. 77TT3A331AA - 6028724 - 556021105 - 1016756</p> <p>FOLE DO SEMI-EIXO JUNTO À RODA</p> <p>FORD ESCORT 1.1</p> <p>d81x100mm 1f-d68mm 1f-d20mm</p>
	<p><b>F0547-I</b> NO. 6028751 - 77TT3A331BA - 1073802 - 1016758 - 6161378 - 86AG3A331AA - 98FX4A084CA - 98FX4A084BA - 1072...</p> <p>FOLE DO SEMI-EIXO JUNTO À CAIXA DE VELOCIDADES</p> <p>FORD ESCORT 1.1</p> <p>d63x93mm 1f-d72mm 1f-d19mm</p>		<p><b>F1043-18</b> NO. 1450821 - 69AB3025BA</p> <p>FOLE DO AMORTECEDOR DA SUSPENSÃO FRENTE</p> <p>FORD ESCORT (0.9-1.1-1.3-1.6) ESCORT DIESEL (1.6-1.8) - ORION(1.3-1.4-1.6) - DIESEL(1.6-1.8)</p> <p>d75x145mm 1f-d68mm 1f-d18mm</p>
	<p><b>F1081-I</b> NO. 617346 - 617347 - 1610365 - 84AB.3K661.AA</p> <p>FOLE DA DIRECÇÃO</p> <p>FORD ESCORT (APÓS 6-83) - FURGÃO VAN 55 - ORION (APÓS 6-83)</p> <p>d60x230mm 1f-d48mm 1f-d10mm</p>		<p><b>F1081-I</b> NO. 617346 - 617347 - 1610365 - 84AB.3K661.AA</p> <p>FOLE DA DIRECÇÃO</p> <p>FORD ESCORT (APÓS 6-83) - FURGÃO VAN 55 - ORION (APÓS 6-83)</p> <p>d60x230mm 1f-d48mm 1f-d10mm</p>
	<p><b>F1183-I</b> NO. 6676140 - 92AG003L537AA</p> <p>FOLE JUNTO À CAIXA DE VELOCIDADES</p> <p>FORD ESCORT VI 1.8i (1992 A 1995) - ESCORT VII 1.8i - 1.8D - 1.8TD (1995 A 2000)</p> <p>d100x103mm 1f-d85mm 1f-d23mm</p>		<p><b>F1294-I</b> NO. 6127744</p> <p>FOLE DA DIRECÇÃO LADO DIREITO E ESQUERDO</p> <p>FORD ESCORT MK IV 10-88 A 10-90 ESCORT MK V APÓS 9-90 - ORION APÓS 1983</p> <p>d60x220mm 1f-d37mm 1f-d11mm</p>
	<p><b>F1294-I</b> NO. 6127744</p> <p>FOLE DA DIRECÇÃO LADO DIREITO E ESQUERDO</p> <p>FORD ESCORT MK IV 10-88 A 10-90 ESCORT MK V APÓS 9-90 - ORION APÓS 1983</p> <p>d60x220mm 1f-d37mm 1f-d11mm</p>		<p><b>F1444-I</b> NO. 6676136 - 92TT3A331</p> <p>FOLE DA TRANSMISSÃO JUNTO À RODA</p> <p>FORD ESCORT VII 1.8 TD (1995 A 1999)</p> <p>d104x92mm 1f-d87mm 1f-d23mm</p>



	<p><b>F1668-I</b> NO. 1619061 - 83BB.3K661.BD</p> <p>FOLE DA DIRECÇÃO DIREITO E ESQUERDO</p> <p>FORD ESCORT MK III - MK IV - MK V</p> <p>d62x200mm 1f-d37mm 1f-d10mm</p>		<p><b>F1702-I</b> NO.</p> <p>FOLE DA DIRECÇÃO LADO DIREITO E ESQUERDO</p> <p>FORD ESCORT VII (1995 A 2000 1.6i &amp; XR3i 16V</p> <p>d59x160mm 1f-d45mm 1f-d11mm</p>
	<p><b>F1716-I</b> NO. 6182818 - 1085517 - 3043575 - 87BB3K661AA</p> <p>FOLE DA DIRECÇÃO ASSISTIDA DIREITO E ESQUERDO</p> <p>FORD ORION 1.1 - 1.3 - 1.4 - 1.6 - 1.6 16V - 1.6 D - 1.8 16V - 1.8 D - 1.8 TD (APÓS 1990)</p> <p>d61x190mm 1f-d46mm 1f-d13mm</p>		<p><b>F1855-I</b> NO. 6935233 - 92AB3K661AA - 4381841 - 98AG3K661AA - 6182218 - 2T143K661AA - 86AB3K661A1A - 6177346</p> <p>FOLE DA DIRECÇÃO LADO DIREITO E ESQUERDO</p> <p>FORD ESCORT IV 1.1 - 1.1i - 1.3 - 1.3i - 1.4 - 1.4i - 1.6 - 1.6i - 1.6i &amp; XR3i 16V - 1.6i 16V - 1.6i XR3i 16V - 1.8D - 1.8 TD - 1.8i &amp; XR3i 16V - 1.8i 16V (1985 A 1990) - ESCORT V 1.1i - 1.3i - 1.4i - 1.6i - 1.8D (1990 A 1992) - ESCORT VI 1.3i - 1.4i - 1.6i</p> <p>d60x220mm 1f-d37mm 1f-d13mm</p>
	<p><b>H731</b> NO.</p> <p>PALA ORIGINAL FORD ESCORT</p> <p>FORD ESCORT</p> <p>400x230mm NULL</p>		<p><b>KF1800</b> NO. 6028724 - 77TT3A331AA - 556021105 - 1016756</p> <p>FOLE DO LADO DA RODA (DIAM. 68mm)</p> <p>FORD ESCORT 1.1 - ESCORT VAN MK III - ESCORT VAN DIESEL</p> <p>d89x100mm 1f-d20mm 1f-d68mm</p>
	<p><b>KF1810</b> NO. 1638320 - 6043191 - 1073846 - 98AX.4A084.BA - 77TT3A331FA</p> <p>FOLE DO LADO DA RODA (DIAM. 78mm)</p> <p>FORD ESCORT 1.3 - 1.6 - ESCORT VAN MK III-P100 PICK-UP - ORION</p> <p>d93x103mm 1f-d20mm 1f-d78mm</p>		<p><b>KF9002</b> NO. 1073803 - 98FX4A084CA - 86AG3A331AA</p> <p>KIT DE FOLE DO CARDAN LADO DA CAIXA</p> <p>FORD ESCORT 1.3 - 1.4 - 1.6 16V - 1.8D - 1.8i 16V - 1.8 TD APÓS 1995 (CAIXA (4 VELOCIDADES))</p> <p>d88x83mm 1f-d73mm 1f-d21mm</p>
	<p><b>KL1066-I</b> NO. 6189055</p> <p>KIT DO PEDAL DA EMBRAIAGEM</p> <p>FORD ESCORT - ORION (2ª SÉRIE)</p> <p>123x70x20mm NULL</p>		<p><b>L0221</b> NO.</p> <p>CASQUILHO DE MOLAS</p> <p>FORD ESCORT</p> <p>d24x35mm d20mm 1f-d12mm</p>
	<p><b>L0262</b> NO.</p> <p>CASQUILHO</p> <p>FORD ESCORT</p> <p>d30x40mm d25mm 1f-d9mm</p>		<p><b>L1030</b> NO. 1412951 - 6100095 - 1421951</p> <p>CASQUILHO DE BRAÇOS DE SUSPENSÃO</p> <p>FORD ESCORT 1.3 (1986 A 1990) - 1.4 (1985 A 1990) - 1.6 (1986 A 1990) - 1.6D (1986 A 1989) - 1.8D (1989 A 1990) - FORD ORION 1.3 - 1.6 - 1.6i (1983 A 1986) - 1.6D (1984 A 1986)</p> <p>d41x37mm 1f-d20mm</p>
	<p><b>L1044</b> NO. 1619120 - 81AB.3063.BB</p> <p>CASQUILHO INTERNO DO BRAÇO DA SUSPENSÃO</p> <p>FORD ESCORT 0.9 - 1.1 - 1.3 - 1.6 - ESCORT DIESEL 1.6 - 1.8 (APÓS 8-1980) - ORION 1.1 - 1.4 - 1.6 - ORION DIESEL 1.6 - 1.8 (APÓS 5-1983)</p> <p>d30x43mm d25mm 1f-d11mm</p>		<p><b>L3004</b> NO. 5021661 - 6107025 - 1652910 - 81AB5K897BA - 81AB.5K897.BB</p> <p>CASQUILHO DA BARRA ESTABILIZADORA DA FRENTE</p> <p>FORD ESCORT 0.9 - 1.1 - 1.3 - ESCORT DIESEL 1.6 - 1.8 - ORION 1.3 - 1.4 - 1.6 - ORION DIESEL 1.6 - 1.8</p> <p>d45x20mm d42mm 1f-d16mm</p>
	<p><b>L3005</b> NO. 6076533 - 1568682</p> <p>CASQUILHO DA EXTREMIDADE DA CREMALHEIRA DA DIRECÇÃO</p> <p>FORD ESCORT 0.9 - 1.1 - 1.3 - 1.6 - ESCORT DIESEL 1.6 - 1.8 - ORION 1.1 - 1.4 - 1.6 - ORION DIESEL 1.6 - 1.8</p> <p>32x32x18mm 1f-d22mm</p>		<p><b>L3008</b> NO. 1610371</p> <p>CASQUILHO DA DIRECÇÃO</p> <p>FORD ESCORT - ORION</p> <p>35x35x18mm 1f-d22mm</p>

	<p><b>M6002</b> NO. 6616584 - 6688868 - 6166244 - 6201608 - 6156722 - 1656281</p> <p>JUNTA DE ESCAPE</p> <p>FORD ESCORT (1990 A 1992) - ORION (APÓS 1990)</p> <p>d66x14mm 1f-d50mm</p>		<p><b>M6037</b> NO. 6065962 - 1565558 - 6115136 - 6134623 - 6615275 - 6134622 - 81AB9451AA</p> <p>JUNTA DE ESCAPE</p> <p>FORD ESCORT (1975 A 1994) - ORION (1983 A 1993)</p> <p>107x80mm 2f-d42mm</p>
	<p><b>M6043</b> NO. 6134624 - 6120664 - 1630835 - 6120644 - 6163389</p> <p>JUNTA DE ESCAPE</p> <p>FORD ESCORT (1983 A 1986) - ORION (1984 A 1993)</p> <p>120x80mm 2f-d42mm</p>		<p><b>M6057</b> NO. 6797187 - 6692784 - 6993854</p> <p>JUNTA DE ESCAPE</p> <p>FORD ESCORT (APÓS 1991)</p> <p>132x75mm 1f-d61.3mm</p>
	<p><b>M6067</b> NO. 6692741 - 6642508</p> <p>JUNTA DE ESCAPE</p> <p>FORD ESCORT (APÓS 1991) - ORION (APÓS 1991)</p> <p>117x70mm 1f-d58mm</p>		<p><b>M6069</b> NO. 6645622</p> <p>JUNTA DE ESCAPE</p> <p>FORD ESCORT (1983 A 1992) - ORION (1984 A 1993)</p> <p>120x65mm 2f-d42mm</p>
	<p><b>M6070</b> NO. 1664671</p> <p>JUNTA DE ESCAPE</p> <p>FORD ESCORT (APÓS 1989) - ORION (1990 A 1992)</p> <p>120x71mm 1f-d55mm</p>		<p><b>M6071</b> NO. 6168647 - 6645621</p> <p>JUNTA DE ESCAPE</p> <p>FORD ESCORT (APÓS 1989) - ORION (1990 A 1992)</p> <p>124x75mm 2f-d45mm</p>
	<p><b>M6079</b> NO. 6027648 - 1709852 - 749451BA</p> <p>JUNTA DE ESCAPE</p> <p>FORD ESCORT (1974 A 1980)</p> <p>54x13mm 1f-d41mm</p>		<p><b>M6087</b> NO. 6745092 - 6634401 - 6616586 - 1654627</p> <p>JUNTA DE ESCAPE</p> <p>FORD ESCORT (1986 A 1990)</p> <p>d76x13mm 1f-d60mm</p>
	<p><b>M6095</b> NO. 6789153 - 7398780</p> <p>JUNTA DE ESCAPE</p> <p>FORD ESCORT (APÓS 1992) - ORION (1991 A 1993)</p> <p>d95x13mm 1f-d75mm</p>		<p><b>M6096</b> NO. 6688869 - 6745091 - 6616185 - 6504754</p> <p>JUNTA DE ESCAPE</p> <p>FORD ESCORT (1990 A 1992) - ORION (1990 A 1992)</p> <p>d70x13mm 1f-d55mm</p>
	<p><b>M6102</b> NO. 6162279 - 6692744 - 6642511 - 6159982</p> <p>JUNTA DE ESCAPE</p> <p>FORD ESCORT (1995 A 2000) - ORION (1983 A 1991)</p> <p>127x70x2mm 1f-d56mm</p>		<p><b>M6108</b> NO. 6026339</p> <p>JUNTA DE ESCAPE</p> <p>FORD ESCORT (74-83) - ORION (APÓS 81)</p> <p>57x14mm 1f-d43mm</p>
	<p><b>N1617</b> NO.</p> <p>ANEL DE ESCAPE</p> <p>FORD ESCORT</p> <p>d65x13mm 1f-d40mm</p>		<p><b>N2002</b> NO. 1719466 - 113E5381B</p> <p>ANEL DE ESCAPE</p> <p>FORD ESCORT (1968 A 1999)</p> <p>d43x12mm 1f-d19mm</p>

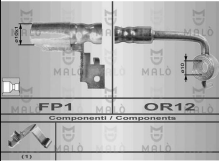
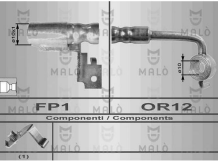
	<p><b>P1010</b> NO. 1526242 - 72EB2457BA</p> <p>CAPA DE PEDAL DO TRAVÃO E EMBRAIAGEM</p> <p>FORD ESCORT (0.9 - 1.1 - 1.3 - 1.6) - ESCORT DIESEL (1.6 - 1.8) - ORION (1.3 - 1.4 - 1.6) - ORION DIESEL (1.6 - 1.8)</p> <p>70x50x18mm NULL</p>		<p><b>P1026</b> NO. 6168375 - 89FB.2457.AA</p> <p>CAPA DE PEDAL TRAVÃO E EMBRAIAGEM</p> <p>FORD ESCORT - ORION (MODERNOS)</p> <p>68x54x14mm NULL</p>
	<p><b>R0685</b> NO.</p> <p>TUBO DA CHAUFAGE</p> <p>FORD ESCORT (APÓS 1977)</p> <p>B570-d13/11mm 40-265-500-80mm</p>		<p><b>R220440</b> NO. 1459488 - 1546885</p> <p>TUBO DE RADIADOR INFERIOR</p> <p>FORD ESCORT I 1100 (1968 A 1976) - ESCORT II 1.1 (1974 A 1980) - ESCORT III 1.1 (1980 A 1985) - ESCORT IV 1.1 (1985 A 1990)</p> <p>B240-d33/33mm 145-170-90mm</p>
	<p><b>R220441</b> NO. 1595579 - 6115579</p> <p>TUBO DE RADIADOR INFERIOR</p> <p>FORD ESCORT I - II 1.1 (1968 A 1980) - ESCORT III 1.1 (1980 A 1985) - ESCORT IV 1.1 (1985 A 1990)</p> <p>B430-d32/32mm 80-70-240-140mm</p>		<p><b>R220442</b> NO. 1465390</p> <p>TUBO DE RADIADOR SUPERIOR</p> <p>FORD ESCORT I - II 1.1 (1968 A 1980) - ESCORT III 1.1 (1980 A 1985) - ESCORT IV 1.1 (1985 A 1990)</p> <p>B190-d31/38mm 40-150-150mm</p>
	<p><b>R220443</b> NO. 6088586</p> <p>TUBO DE RADIADOR SUPERIOR</p> <p>FORD ESCORT (1.1) (81 A 1-86)</p> <p>B280-d31/33mm 120-90-70-70mm</p>		<p><b>R220445</b> NO. 6094482</p> <p>TUBO DE ENVIO DE ÁGUA AO AQUECIMENTO</p> <p>FORD ESCORT (1.1) (81 A 8-83)</p> <p>B330-d16/16mm 80-90-190-75mm</p>
	<p><b>R220447</b> NO. 6070349 - 6070359</p> <p>TUBO DE RETORNO DA ÁGUA DO AQUECIMENTO</p> <p>FORD ESCORT I - II 1.1 (1968 A 1980) - ESCORT III 1.1 (1980 A 1985) - ESCORT IV 1.1 (1985 A 1990)</p> <p>B410-d16/16mm 80-380-285-75mm</p>		<p><b>R220501</b> NO. 6079523 - 6115575</p> <p>TUBO DE RADIADOR SUPERIOR</p> <p>FORD ESCORT I - II 1.3 - 1.6 (ATÉ 1980) - ESCORT III 1.3 - 1.6 (1980 A 1985) - ESCORT IV 1.3 - 1.6 (1985 A 1999)</p> <p>B285-d32/32mm 70-135-65-50mm</p>
	<p><b>R220501</b> NO. 6079523 - 6115575</p> <p>TUBO DE RADIADOR SUPERIOR</p> <p>FORD ORION 1.3 - 1.6 (APÓS 1986)</p> <p>B285-d32/32mm 70-135-65-50mm</p>		<p><b>R220502</b> NO. 1595546 - 6099727</p> <p>TUBO DE RADIADOR INFERIOR</p> <p>FORD ESCORT I - II 1.3 (ATÉ 1980) - ESCORT 1.8 TURBO D MOTOR RVA (1995 A 2001) - ESCORT III 1.3 - 1.6 (1980 A 1985) - ESCORT IV 1.3 - 1.6 (1986 A 1985) - ESCORT IV 1.3 - 1.6 (1986 A 1990) - ESCORT V 1.3 - 1.6 (1990 A 1992) - ESCORT VI 1.3 (</p> <p>B300-d32/32mm 80-120-200-70mm</p>
	<p><b>R220504</b> NO. 6119164</p> <p>TUBO DE RADIADOR INFERIOR</p> <p>FORD ESCORT I - II 1.3 - 1.6 (ATÉ 1980) ESCORT III 1.3 - 1.6 (1980 A 1985) - ESCORT IV 1.3 - 1.6 (1985 A 1990) - ORION (1.3 - 1.6) (APÓS 1986)</p> <p>B300-d32/33mm 60-120-165-50-60mm</p>		<p><b>R220505</b> NO. 1604864 - 6146420</p> <p>TUBO DE ENVIO DE ÁGUA AO AQUECIMENTO</p> <p>FORD ESCORT I - II 1.3 - 1.6 (ATÉ 1980) ESCORT III 1.3 - 1.6 (1980 A 1985) ESCORT IV 1.3 - 1.6 (1985 A 1990) - ORION 1.3 - 1.6 (APÓS 1986)</p> <p>B180-d15/15mm 55-265-385-115-105mm</p>
	<p><b>R221301</b> NO. 6165328</p> <p>TUBO 4 VIAS INFERIOR DO RADIADOR</p> <p>FORD ESCORT III 1.6 (1980 A 1986) - ESCORT IV 1.6 (1986 A 1990) - ESCORT V 1.6 (1990 A 1992) - ORION I 1.6 (1983 A 1986) - ORION II 1.4 - 1.6 (1985 A 1990) - ORION III 1.4 - 1.6 (1990 A 1993)</p> <p>B305-d33/32mm B315-d32/33mm+ch760-d15mm+ch310-d</p>		<p><b>R2473</b> NO.</p> <p>TUBO DA CHAUFAGE</p> <p>FORD ESCORT 1100 APÓS 1980</p> <p>B410-d19/19mm 200-125-160mm</p>

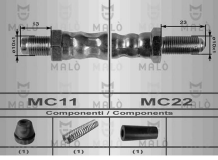
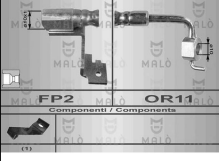
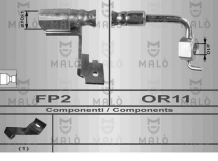
	<p><b>R8070</b> NO. 6557103 - 7405635 - 1015693 - 91AB.8260.FG - 91AB.8260.FC - 93AB.8B274.EC - 93AB.8B274.EB</p> <p>TUBO SUPERIOR DO RADIADOR</p> <p>FORD ESCORT 1.4 - 1.6 - 1.8 C- AR CONDICIONADO - ORION 1.4 - 1.6 - 1.8 C- AR CONDICIONADO</p> <p>B330-d32/32mm 1r-d22mm 75-90-155-55mm</p>		<p><b>R8071</b> NO. 92AB8260AG - 6827019 - 2000018 - 6047976 - 6595567 - 6609706 - 6728929 - 6789090 - 7405637 - 7405638...</p> <p>TUBO SUPERIOR DO RADIADOR</p> <p>FORD ESCORT 1.4 - 1.6 - 1.8 16 VÁLVULAS</p> <p>B380-d31/31mm 1r-d22mm 100-245-95mm</p>
	<p><b>R8140</b> NO. 6170465</p> <p>TUBO LIGAÇÃO CARBURADOR</p> <p>FORD ESCORT I (AFH, ATH) 1100 06.68 - 06.71 29 40 1098 três volumes FORD ESCORT I (AFH, ATH) 1100 01.68 - 12.74 32 45 1098 três volumes FORD ESCORT I (AFH, ATH) 1100 06.68 - 06.71 33 45 1098 três volumes FORD ESCORT I (AFH, ATH) 1100 06.70 - 02.76 35 48 1098 três volumes FORD ESCORT I Turnier (ADH) 1100 06.68 - 06.71 29 40 1098 Combi FORD ESCORT I Turnier (ADH) 1100 06.70 - 02.76 32 44 1098 Combi FORD ESCORT I Turnier (ADH) 1100 06.70 - 02.76...etc.</p> <p>B165-15/15mm 100-90-60mm</p>		<p><b>R8140</b> NO. 6170465</p> <p>TUBO LIGAÇÃO CARBURADOR</p> <p>FORD ESCORT II (ATH) 1.1 12.74 - 08.80 32 45 1098 três volumes FORD ESCORT II (ATH) 1.1 06.75 - 08.80 34 46 1098 três volumes FORD ESCORT II (ATH) 1.1 12.74 - 08.80 35 48 1098 três volumes FORD ESCORT II Turnier 1.1 04.75 - 08.80 32 44 1097 Combi FORD ESCORT II Turnier 1.1 04.75 - 08.80 35 48 1097 Combi</p> <p>B165-15/15mm 100-90-60mm</p>
	<p><b>R8140</b> NO. 6170465</p> <p>TUBO LIGAÇÃO CARBURADOR</p> <p>FORD ESCORT III (GAA) 1.1 08.83 - 12.85 37 50 1117 Hatchback FORD ESCORT III (GAA) 1.1 09.80 - 08.83 40 55 1117 Hatchback FORD ESCORT III (GAA) 1.1 09.80 - 08.83 43 59 1117 Hatchback FORD ESCORT III Turnier (AWA) 1.1 08.83 - 12.85 37 50 1117 Combi FORD ESCORT III Turnier (AWA) 1.1 09.80 - 08.83 40 54 1117 Comb</p> <p>B165-15/15mm 100-90-60mm</p>		<p><b>R8140</b> NO. 6170465</p> <p>TUBO LIGAÇÃO CARBURADOR</p> <p>FORD ESCORT III (GAA) 1.3 (09.80 A 12.85) 69cv 1296cc Hatchback - FORD ESCORT III (GAA) 1.6 (09.80 A 12.85) 79cv 1597cc Hatchback</p> <p>B165-15/15mm 100-90-60mm</p>
	<p><b>R8140</b> NO. 6170465</p> <p>TUBO LIGAÇÃO CARBURADOR</p> <p>FORD ESCORT IV (GAF, AWF, ABFT) 1.1 12.85 - 07.90 37 50 1117 Hatchback</p> <p>B165-15/15mm 100-90-60mm</p>		<p><b>R8140</b> NO. 6170465</p> <p>TUBO LIGAÇÃO CARBURADOR</p> <p>FORD ESCORT IV (GAF, AWF, ABFT) 1.4 (01.86 A 07.90) 73cv 1392cc Hatchback - FORD ESCORT IV (GAF, AWF, ABFT) 1.4 (01.86 A 07.90) 75cv 1392cc Hatchback - FORD ESCORT IV (GAF, AWF, ABFT) 1.6 (04.89 A 07.90) 88cv 1598cc Hatchback</p> <p>B165-15/15mm 100-90-60mm</p>
	<p><b>R8140</b> NO. 6170465</p> <p>TUBO LIGAÇÃO CARBURADOR</p> <p>FORD ORION I (AFD) 1.3 (07.83 A 03.86) 69cv 1296cc três volumes - FORD ORION I (AFD) 1.6 (07.83 A 03.86) 79cv 1597cc três volumes</p> <p>B165-15/15mm 100-90-60mm</p>		<p><b>R8140</b> NO. 6170465</p> <p>TUBO LIGAÇÃO CARBURADOR</p> <p>FORD ORION II (AFF) 1.4 (03.86 A 07.90) 72cv 1392cc três volumes - FORD ORION II (AFF) 1.4 (01.86 A 07.90) 73cv 1392cc três volumes - FORD ORION II (AFF) 1.4 (12.85 A 07.90) 75cv 1392cc três volumes - FORD ORION II (AFF) 1.6 (12.85 A 07.90) 90cv 1597cc três volumes</p> <p>B165-15/15mm 100-90-60mm</p>
	<p><b>RT08578</b> NO. 7111983 - 92AB2078CC</p> <p>TUBO DE TRAVÃO FRENTE RH</p> <p>FORD ESCORT 1.6 16V(MOD 90) (-SW) (11-1994 A 12-1994) - TT (MOD 90) (-1.6 16V) (-TT-SW) (09-1990 A 1992) - TT SW (MOD 90) (09-1990 A 12-1994)</p> <p>450mm FP1 - OR12</p>		<p><b>RT08578</b> NO. 7111983 - 92AB2078CC</p> <p>TUBO DE TRAVÃO FRENTE RH</p> <p>FORD ORION TT (08-1990 A 03-1993)</p> <p>450mm FP1 - OR12</p>
	<p><b>RT08580</b> NO. 1666294 - 6667473 - 91AB2282AD</p> <p>TUBO DE TRAVÃO TRÁS LH-RH</p> <p>FORD ESCORT 1.1 (12-1974 A 02-1986) - 1.3 (03-1981 A 02-1999) - 1.4 (01-1986 A 02-1999) - 1.4i (02-1986 A 07-1990) - 1.6 (05-1983 A 12-1992) - 1.6 16V (01-1995 A 02-1999) - 1.6 16V X R3i (12-1992 A 01-1995) - 1.8D (07-1998 A 02-1999) - 1.8TD (02-1993 A 06)</p> <p>490mm MC11 - MC22</p>		<p><b>RT08580</b> NO. 1666294 - 6667473 - 91AB2282AD</p> <p>TUBO DE TRAVÃO TRÁS LH-RH</p> <p>FORD ORION 1.3 (07-1983 A 03-1986)</p> <p>490mm MC11 - MC22</p>
	<p><b>RT08582</b> NO. 1041775 - 1075807</p> <p>TUBO DE TRAVÃO FRENTE LH</p> <p>FORD ESCORT TT ESCORT VI (1992 A 1995)</p> <p>405mm FP2 - OR11</p>		<p><b>RT08582</b> NO. 1041775 - 1075807</p> <p>TUBO DE TRAVÃO FRENTE LH</p> <p>FORD ESCORT TT ESCORT VII(1995 A 1999)</p> <p>405mm FP2 - OR11</p>

 <p><b>FP1 OR12</b> Component / Componente</p>	<p><b>RT08583</b> NO. 1041774 - 1075806</p> <p>TUBO DE TRAVÃO FRENTE RH</p> <p>FORD ESCORT VI (1992 A 1995) TT</p>	 <p><b>FP1 OR12</b> Component / Componente</p>	<p><b>RT08583</b> NO. 1041774 - 1075806</p> <p>TUBO DE TRAVÃO FRENTE RH</p> <p>FORD ESCORT VII (1995 A 1999)</p>
 <p><b>MC11 MC42</b> Component / Componente</p>	<p><b>RT08584</b> NO. 1013455 - 7397508 - 95AB2282DB</p> <p>TUBO DE TRAVÃO FRENTE LH-RH</p> <p>FORD ESCORT V XR3i RS 2000(MOD.VII) (01-1995 A 09-1998)</p>	 <p><b>MC11 MC42</b> Component / Componente</p>	<p><b>RT08585</b> NO. 7402895</p> <p>TUBO DE TRAVÃO TRÁS LH-RH</p> <p>FORD ESCORT TT ESCORT VI (1992 A 1995) (EXCEPTO SW E VAN)</p>
 <p><b>MC11 MC42</b> Component / Componente</p>	<p><b>RT08585</b> NO. 7402895</p> <p>TUBO DE TRAVÃO TRÁS LH-RH</p> <p>FORD ESCORT TT ESCORT VII (1995 A 1999)</p>	 <p><b>MC11 MC22</b> Component / Componente</p>	<p><b>RT08587</b> NO. 6508658 - 6639159 - 91AB2282BA</p> <p>TUBO DE TRAVÃO TRÁS LH-RH</p> <p>FORD ESCORT V TT (MOD.90) (09-1990 A 11-1990)</p>
 <p><b>MC11 MC40</b> Component / Componente</p>	<p><b>RT08600</b> NO. 6125634 - 1638393 - 1666247 - 1666460</p> <p>TUBO DE TRAVÃO TRÁS LH-RH</p> <p>FORD ESCORT V TT SW (MOD.90) (12-1990 A 09-1991)</p>	 <p><b>MC40 MC40</b> Component / Componente</p>	<p><b>RT08689</b> NO. 1664958 - 6714709 - D91AB2282CB - 91AB2282CB - 6599243</p> <p>TUBO DE TRAVÃO TRÁS LH-RH</p> <p>FORD ESCORT V III TT (APÓS 01-1995)</p>
 <p><b>MC11 MC42</b> Component / Componente</p>	<p><b>RT08922</b> NO. 1011293</p> <p>TUBO DE TRAVÃO TRÁS LH-RH</p> <p>FORD ESCORT V-VI (90-92) - ESCORT VI (92-95) - ESCORT VII (APÓS 95) TT APÓS 01-1995</p>		<p><b>S1047</b> NO. 6099529 - 81BB.5K790.AA</p> <p>SILENT-BLOC DO TRIANGULO DA SUSPENSÃO</p> <p>FORD ESCORT</p>
	<p><b>S1096</b> NO. 6042743 - 77FB3432AB</p> <p>SILENT-BLOC - CASQUILHO DO BRAÇO DA SUSPENSÃO DA FRENTE</p> <p>FORD ESCORT I 1100 (06-1968 A 06-1971)</p>		<p><b>S1097</b> NO. 6042740 - 77FB3036AE - 81AB3063BA - 1619120 - 3240198 - 3246127 - 5021729 - 6087890 - 6090611 - 81AB...</p> <p>SILENT-BLOC DO TIRANTE DO BRAÇO DA SUSPENSÃO DA FRENTE</p> <p>FORD ESCORT II 1.1 (ATÉ 1980) - ESCORT III 1.1 (1980 A 1985) - ESCORT IV 1.1 (1985 A 1990)</p>
	<p><b>S1109</b> NO. 6193085-86 - 91AB3A262AA - 1035929</p> <p>SILENT-BLOC DO BRAÇO FRENTE</p> <p>FORD ESCORT 0.9 - 1.1 - 1.3 - 1.6 - ESCORT DIESEL 1.6 - 1.8 - ORION 1.3 - 1.4 - 1.6 - ORION DIESEL 1.6 - 1.8</p>		<p><b>S1110</b> NO. 6193885-86 - 89FB3063ADB492A - 89FB.3063.A1D - T128417 - 89FB.3063.AD - 1000445 - 1829508</p> <p>SILENT-BLOC DO BRAÇO FRENTE</p> <p>FORD ESCORT 0.9 - 1.1 - 1.3 - 1.6 - ESCORT DIESEL 1.6 - 1.8 - ORION 1.3 - 1.4 - 1.6 - ORION DIESEL 1.6 - 1.8</p>
	<p><b>S1219</b> NO. 6087890</p> <p>SILENT-BLOC DO BRAÇO DA SUSPENSÃO DA FRENTE</p> <p>FORD ESCORT (I - II) 1.1 - 1.3 (1968 A 1980) - ESCORT (III - IV) 1.3 - 1.6 - 1.6D (1980 A 1990) - ESCORT V 1.3 - 1.6 (1990 A 1992) - ESCORT VI 1.3 (1992 A 1995) - ESCORT VII 1.3 - 1.8TD (1995 A 1999) - ORION I 1.3 - 1.6 - 1.6D (1983 A 1990)</p>		<p><b>S1259</b> NO. 6745350 - 91AB.5K653.BB - 6163419</p> <p>SILENT-BLOC DA SUSPENSÃO DE TRÁS</p> <p>FORD ESCORT (V - VI - VII) 1.3 - -1.4 - 1.4i - 1.6 - 1.6i 16V - 1.8i 16V - 1.8 16V XR3 - 1.8D - 1.8TD - 2.0 RS COSWORTH 4x4 (1990 A 1999) - ORION I 1.3 - 1.6 - 1.6D (1983 A 1986) - ORION II 1.3 - 1.4 - 1.6 - 1.6D - 1.8D (1985 A 1990) - ORION III</p>



	<p><b>S1263</b> NO. 1041979 - 97AG5K653AA</p> <p>SILENT-BLOC DA SUSPENSÃO DE TRÁS</p> <p>FORD ESCORT (I - II - III) 1.3 (1968 A 1985) - ESCORT (IV - V) 1.3 - 1.4 . 1.8D (1986 A 1992) - ESCORT (VI - VII) 1.3 - 1.4 - 1.8 - 1.8D - 1.8TD (1992 A 1999)</p> <p>d68x70mm d64mm 1f-d12mm</p>		<p><b>S1267</b> NO. 84A05K896A</p> <p>SILENT-BLOC DO BRAÇO DA SUSPENSÃO FRENTE</p> <p>FORD ESCORT</p> <p>d45x45mm d38mm 1f-d12mm</p>
	<p><b>S1477</b> NO. 7371059 - 95AB6K653CA - 1S65K653AA - 4377687 - 1041979 - 7215747 - 97AG5K653AA - ABSK653AC</p> <p>SILENT BLOC DO EIXO TRASEIRO</p> <p>FORD ESCORT IV 1.8D (1989 A 1990) - ESCORT V 1.8D (1990 A 1992) - ESCORT VI 1.6i 16V - 1.8D (1992 A 1995) - ESCORT VII 1.3 - 1.4 - 1.6i 16V - 1.6 16V 4X4 - 1.8 16V - 1.8D - 1.8TD - RS 2000 4X4 - RS COSWORTH 4X4 (1995 A 2000)</p> <p>d75x70mm d64mm 1f-d12mm</p>		<p><b>T0003</b> NO. 204460 - 0204460</p> <p>BATENTE DA BARRA ESTABILIZADORA</p> <p>FORD ESCORT</p> <p>41x39x36mm 1f-d18mm</p>
	<p><b>T0605-I</b> NO. 6532212 - 90BB.3025.AA - 97FU.3025.AA</p> <p>BATENTE DA SUSPENSÃO DA FRENTE</p> <p>FORD ESCORT 1.3 - 1.4 - 1.4i - 1.6 16V XR3i - 1.6 16V - 1.8 16V - 1.8D - 1.8TD (1968 A 2000) - FORD ORION 1.3 - 1.4 - 1.6 - 1.6i 16V - 1.8i 16V - 1.8D - 1.8TD (1983 A 1993)</p> <p>d50x69mm 1f-d22mm 1f-d18mm</p>		<p><b>T1050</b> NO. 7102392 - 94AB.5484.AA - 98AB.5484.AB - 1145272 - 1128725 - 6543416 - 6185809 - YS81.5484.AA - 1E00-...</p> <p>BATENTE DO CENTRO DA BARRA ESTABILIZADORA</p> <p>FORD ESCORT (APÓS 1990) - ORION (APÓS 1991)</p> <p>39x35x30mm 1f-d15mm</p>
	<p><b>U7003</b> NO. 6577961 - 82AB.B46812.ABY</p> <p>CORDÃO DA PRATELEIRA DA BAGAGEIRA</p> <p>FORD ESCORT 3-5 PORTAS (APÓS 1995)</p> <p>d5x300mm NULL</p>		<p><b>W5035</b> NO. 1135052</p> <p>POLIE DA CAMBOTA (6 PISTAS)</p> <p>FORD ORION III 1.6 (07-1990 A 12-1992) - 1.6i 16V - 1.8i 16V (1992 A 1993)</p> <p>d132mm d28mm</p>
	<p><b>W5036</b> NO. 6811202</p> <p>POLIE DA CAMBOTA (5 PISTAS)</p> <p>FORD ESCORT 1.8TD GT - GHIA - GLX - 16V 95D - TD - TDI</p> <p>d134mm d42mm</p>		<p><b>W5135</b> NO. 6186295</p> <p>POLIE DA CAMBOTA 4 PISTAS</p> <p>FORD ESCORT IV (GAF - AWF - ABFT) 1.8 D (01.89 A 07.90) 60cv 1753cc Hatchback - FORD ESCORT IV Combi (AWF - AVF) 1.8 D (01.89 A 07.90) 60cv 1753cc Combi</p> <p>d120/130mm d20,6mm</p>
	<p><b>Z80251</b> NO.</p> <p>Mola de friso</p> <p>FORD ESCORT</p> <p>18x17x14mm 1p-d6-5.5mm</p>		<p><b>Z80598</b> NO. 6725950</p> <p>Mola de painel</p> <p>FORD ESCORT (Após 1995)</p> <p>d18x18.5mm 1p-d9.5-16mm</p>
	<p><b>Z80617</b> NO. 6117693</p> <p>Mola de painel</p> <p>FORD ESCORT</p> <p>d18x16.5mm 1p-d7.4-11mm</p>		<p><b>Z80623</b> NO.</p> <p>Mola de painel</p> <p>FORD ESCORT</p> <p>d25x30.6mm 1p-d12-14.5mm</p>
	<p><b>Z80687</b> NO. 6448410</p> <p>Mola de painel</p> <p>FORD ESCORT (Após 1995)</p> <p>d25x14.5mm 1p-d9.3-12.5mm</p>		<p><b>Z80704</b> NO. 6176723 - 500326189</p> <p>Mola de painel</p> <p>FORD ESCORT (Após 1995)</p> <p>d18x21mm 1p-d8.2-15mm</p>

# FORD ESCORT-ORION



*Rafpi, Lda.*

	<b>Z80717</b>	NO. 6150260		<b>Z9005</b>	NO. 1640227 - 6156718 - 6688870
	Mola de fixação FORD ESCORT			MOLA DE ESCAPE FORD ESCORT (APÓS 1983) - ORION (1986 A 1993)	
d20x12.5mm		1p-8x11-10mm 1f-d5.5mm	d25x28mm		NULL
	<b>Z9009</b>	NO. 6142854 - 6146512			
	MOLA DE ESCAPE FORD ESCORT (APÓS 1984) - ORION (1984 A 1993)				
d14x69mm		NULL			

# FORD FIESTA-COURIER-FUSION-PUMA

	<b>A0075</b>	NO. 6049904 - 77FB6038FD - 89FB6038FA - 6164624 - 6194624		<b>A1036</b>	NO. 6845223 - 6845225 - 91AB.6L028.CB
	SUPPORTO FRETE DO MOTOR FORD FIESTA (0.9- 1.1- 1.3- 1.4- 1.6) (1976 A 1995) - 1.6D - 1.8D (1984 A 1996)			APOIO INFERIOR DA FRETE DO MOTOR LADO CAIXA FORD FIESTA 1.1 (1981 A 1983) - 1.3 (APÓS 1996) - 1.8 16V (1992 A 1995)	
72x56x40mm		2p-d10-25mm	NULL		NULL
	<b>A1037</b>	NO. 86AB6038DB - 6160229 - 6157620		<b>A1057</b>	NO. 1640021 - 6133904 - 6161628 - 84FB6038CD
	APOIO DIREITO DO MOTOR FORD FIESTA - COURIER 1.6 DIESEL - 1.8 (1976 A 1996)			SUPPORTO DIREITO FRETE DO MOTOR FORD FIESTA 1.1 (83 A 89) - FIESTA (0.9-1.1-1.3-1.4-1.6) - FIESTA 1117cc 84 - FIESTA DIESEL (ATÉ 1-86)	
152x85x60mm		1f-d12mm	130x110x50mm		3p-d10-27mm 1r-d6mm
	<b>A1058</b>	NO. 6155714 - 6170427		<b>A1068</b>	NO. 6160228
	APOIO DA CAIXA DE VELOCIDADES FRETE E TRÁS FORD FIESTA 1.0 - 1.1 - 1.3 (1989 A 1995)			SUPPORTO DIREITO FRETE DO MOTOR FORD FIESTA 0.9 (05-1976 A 08-1983)	
97x75x40mm		2p-d10-22mm	160x100x65mm		1f-d12mm 1r-d10mm 1p-d10-20mm
	<b>A1077-I</b>	NO. 6049904 - 77FB6038FD - 6164624 - 6194624		<b>A1078-I</b>	NO. 6045281 - 77FB6030EC
	APOIO DO MOTOR FRETE E TRÁS FORD FIESTA GASOLINA 0.9 - 1.1 - 1.3 - 1.4 - 1.6 (1976 A 1995) - 1.6D - 1.8D (1984 A 1996)			SUPPORTO FRETE DO MOTOR (77FB6030EC) FORD FIESTA (0.9-1.1-1.3) GASOLINA (ATÉ 8-83)	
70x55x39mm		2p-d10-24mm	75x66x63mm		1p-d10-40mm 1f-d12mm 1f-d18mm
	<b>A1188</b>	NO. 6203710 - 89AB6B049AD		<b>A1318</b>	NO. 6172938
	APOIO TRASEIRO SUPERIOR ESQUERDO DO MOTOR FORD FIESTA DIESEL - 1800 DIESEL (1989 A 1996)			SUPPORTO DE TRÁS DO MOTOR FORD FIESTA 1.6D (1984 A 1989)	
97x75x40mm		2p-d10-22mm	140x109x105mm		1p-d10-35mm

















	<p><b>A1380</b> NO. 7350847 - 95AB3K155AD</p> <p>APOIO DA SUSPENSÃO DA FRENTE</p> <p>FORD FIESTA 1.3 (APÓS 1996) - 1.8 16V (1992 A 1995)</p> <p>145x145x40mm 3p-d8-17mm</p>		<p><b>A1383</b> NO. 1013794 - 96FB 3K155AG - 96AB.3K155.AG - 1E00-34-380 - 96FB3K155AG</p> <p>APOIO DA SUSPENSÃO DA FRENTE</p> <p>FORD FIESTA 1.0i - 1.25i 16V - 1.3i - 1.4i 16V - 1.6 - 16V SPORT - 1.8D - 1.8Di (1995 A 2002) - FORD KA 1.0i - 1.3i (1996 A 2002)</p> <p>d105x49mm 1f-d23mm</p>
	<p><b>A1384</b> NO. 1040404 - 94AB 6B049CF - 94AB.6B049.CF - 1012895</p> <p>APOIO DO MOTOR DE TRÁS</p> <p>FORD FIESTA 1.8 16V (1992 A 1995)</p> <p>160x100x70mm 1p-d12-30mm</p>		<p><b>A1385</b> NO. 6179974 - 77BM6K255AC - 1113176 - 77BM.6K255.AF</p> <p>APOIO DO TENSOR DE EMBRAIAGEM</p> <p>FORD FIESTA OHV - KA (APÓS 1996)</p> <p>63x16x13mm NULL</p>
	<p><b>A1395</b> NO. 6172298 - 83EF6038EA - 6156316</p> <p>SUPORTE DE MOTOR DIREITO</p> <p>FORD FIESTA DIESEL - ESCORT DIESEL (APÓS 1991)</p> <p>150x107x79mm 1p-d12-50mm</p>		<p><b>A1399</b> NO. 6793344</p> <p>SUPORTE DE MOTOR DIREITO</p> <p>FORD FIESTA 1.3 (APÓS 02-1996)</p> <p>142x120x68mm 1f-d12mm 2p-d10-26mm 2p-d12-37mm</p>
	<p><b>A1594</b> NO. 1253168 - 1146153 - 2S61.3K155.AG - 1697347 - 2S613K155AE - 1469224</p> <p>APOIO DO AMORTECEDOR DA FRENTE</p> <p>FORD FIESTA V (JH-) 1.25 16V (APÓS 05-2002) - 1.3 - 1.4 16V - 1.4 TDCi - 1.6 16V (APÓS 11-2001) - FUSION (JU-) 1.25 (APÓS 08-2004) - 1.4 - 1.4 TDCi - 1.6 (APÓS 08-1982)</p> <p>108x108x34mm 3p-d8-22mm</p>		<p><b>A1637</b> NO. 1010530</p> <p>APOIO DO MOTOR LADO DA CAIXA</p> <p>FORD FIESTA 4 96 A 01-99 1.8D R-96</p> <p>170x155x110mm 2r-d10mm</p>
	<p><b>A1638</b> NO. 1021268 - 1060402 - 1099548 - 96FB6038BJ - 96FB6038BK - XS616038FA</p> <p>APOIO DO MOTOR PARTE DA FRENTE</p> <p>FORD FIESTA 4 APÓS 1996 1.8D R-96</p> <p>170x150x100mm 1p-d10-42mm</p>		<p><b>A1639</b> NO. 1060401</p> <p>APOIO DO MOTOR PARTE DA FRENTE</p> <p>FORD FIESTA 4 APÓS 03-1998 1.0 R-96 - 1.2 16V R-96 - 1.3 R-96 - 1.4 16V R-96</p> <p>170x145x90mm 1p-d10-40mm</p>
	<p><b>A1678</b> NO. 1301965 - 2S616F012GC - 2S6116F012GC - 1232031 - 1202576 - 1214677</p> <p>APOIO DO MOTOR</p> <p>FORD FIESTA (APÓS 2002)</p> <p>160x110x105mm NULL</p>		<p><b>A1817</b> NO. 1641111 - 7V2Q6030BB</p> <p>APOIO BASE DE REPARAÇÃO DO APOIO DO MOTOR</p> <p>FORD FIESTA (APÓS 2008)</p> <p>130x70x30mm NULL</p>
	<p><b>A1818</b> NO. 1526778S1 - 1526778 - 8V513K155BA</p> <p>APOIO DOS AMORTECEDORES DA FRENTE</p> <p>FORD FIESTA VI 1.0 Hatchback (APÓS 01.13) 65cv 998cc - FORD FIESTA VI 1.0 Hatchback (APÓS 10.12) 80cv 998cc - FORD FIESTA VI 1.0 EcoBoost Hatchback (APÓS 01.13) 100cv 998cc - FORD FIESTA VI 1.0 EcoBoost Hatchback (APÓS 09.12) 125cv 998cc - FORD FIESTA VI</p> <p>106x114x35mm 1f-d12.5mm 3p-d8x22mm</p>		<p><b>A1828</b> NO. 1141479 - 1141478 - 2S6H8125BA</p> <p>APOIO DO RADIADOR</p> <p>FORD FIESTA V (JH_ - JD_) 1.25 16V Hatchback (03.03 - 06.08) 70cv 1242cc - FORD FIESTA V (JH_ - JD_) 1.25 16V Hatchback (05.02 - 06.08) 75cv 1242cc - FORD FIESTA V (JH_ - JD_) 1.3 Hatchback (11.01 - 06.08) 44 60 1299 - FORD FIESTA V Hatchback (JH_ - JD_) 1.3</p> <p>38x33x30mm 1f-d15mm</p>
	<p><b>A1924</b> NO. 1519590 - 1526663 - 1536951 - 1546649 - 1676770 - 1692614 - 1778550 - 8V516F012BB - 8V516F012BC - 8V...etc.</p> <p>APOIO MOTOR LADO DIREITO</p> <p>FORD FIESTA VI 1.25 (A Partir de 06.08) 60cv 1242cc Hatchback - FORD FIESTA VI 1.25 (A Partir de 06.08) 82cv 1242cc Hatchback - FORD FIESTA VI 1.4 (A Partir de 06.08) 97cv 1388cc Hatchback - FORD FIESTA VI 1.4 LPG (A partir de 01.09) 92cv 1388cc Hatchback - FORD FIESTA VI 1.4 LPG (A Partir de 01.09) 97cv 1388cc Hatchback - FORD FIESTA VI 1.6 Ti (A Partir de 06.08) 120cv 1596cc Hatchback - FORD FIESTA VI 1.6 Ti (A Partir de 12.10) 134...etc.</p> <p>190x170x130mm 3f-d18mm 3f-d12mm</p>		<p><b>A1925</b> NO. 1519602 - 1526662 - 1536950 - 1546648 - 1675990 - 1685701 - 1778911 - 8V516F012AB - 8V516F012AC - 8V...etc.</p> <p>APOIO MOTOR PARTE FRENTE</p> <p>FORD FIESTA VI 1.4 TDCi (A Partir de 01.09) 68cv 1399cc Hatchback - FORD FIESTA VI 1.4 TDCi (A Partir de 07.10) 70cv 1399cc Hatchback - FORD FIESTA VI 1.6 TDCi (A Partir de 06.08) 75cv 1560cc Hatchback - FORD FIESTA VI 1.6 TDCi (A Partir de 06.08) 90cv 1560cc Hatchback - FORD FIESTA VI 1.6 TDCi (A Partir de 02.10) 95cv 1560cc Hatchback</p> <p>180x170x150mm 2f-d18mm 2f-d14mm</p>







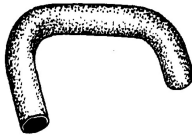





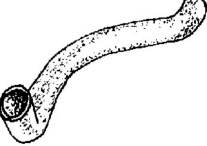



	<p><b>A1938</b> NO. 1526664 - 1529438 - 1536197 - 1513112 - 8V517M121AB - 8V517M121AC - 8V517M121AD - 8V517M121AE</p> <p>APOIO DO MOTOR LADO ESQUERDO CAIXA DE VELOCIDADES</p> <p>FORD FIESTA VI 1.25 (A Partir de 06.08) 60cv 1242cc Hatchback - FORD FIESTA VI 1.25 (A Partir de 06.08) 82cv 1242cc Hatchback - FORD FIESTA VI 1.4 (A Partir de 06.08) 97cv 1388cc Hatchback - FORD FIESTA VI 1.4 LPG (A Partir de 01.09) 97cv 1388cc Hatchback - FORD FIESTA VI 1.6 Ti (A Partir de 06.08) 120cv 1596cc Hatchback - FORD FIESTA VI 1.6 Ti (A Partir de 12.10) 134cv 1596cc Hatchback - FORD FIESTA VI 1.4 TDCi (A Partir de 01.09) ...etc.</p> <p>185x70x170mm 4f-20x12mm 2f-8mm 2p-M6x12mm</p>		<p><b>BB22</b> NO. 1003610</p> <p>ABRAÇADEIRA DA BARRA ESTABILIZADORA</p> <p>FORD FIESTA (1996)</p> <p>NULL NULL</p>
	<p><b>BB23</b> NO. 6788739</p> <p>ABRAÇADEIRA DA BARRA ESTABILIZADORA</p> <p>FORD FIESTA (1989 A 1996) - KA</p> <p>NULL NULL</p>		<p><b>C0231</b> NO. 6483712 - 91AB.16C618.AA</p> <p>BOTÃO DE AFINAÇÃO DE CAPOT</p> <p>FORD FIESTA (1989 A 1996)</p> <p>d27x44mm NULL</p>
	<p><b>C1002</b> NO. 89FBA40452AD - 6198161 - 6483712</p> <p>BOTÃO DE CAPOT</p> <p>FORD FIESTA - KA (APÓS 1996)</p> <p>d21x39mm NULL</p>		<p><b>E0010</b> NO. 6048886 - 6053849 - 6111692 - 77FB5A262CA - 77FB5A262BD</p> <p>ESTICADOR DE ESCAPE</p> <p>FORD FIESTA - FIESTA DIESEL (ATÉ 8-83)</p> <p>73x47x38mm NULL</p>
	<p><b>E0023</b> NO. 6120254 - 6136012 - 6122002 - 81AB5A262AC - 93BB5A262HA - 6162002 - 6111691</p> <p>ESTICADOR DE ESCAPE</p> <p>FORD FIESTA (0.9 - 1.1 - 1.3 - 1.4 - 1.6) - FIESTA DIESEL(APÓS 8-83)</p> <p>92x58x38mm NULL</p>		<p><b>E0100</b> NO. 1130273 - 1661237 - 1061631 - 1071336 - 89FB3B438A1E - 98AG3B438AB - 1067818 - 1S61.3B438.AA</p> <p>ESTICADOR DA BARRA ESTABILIZADORA DA FRENTE</p> <p>FORD FIESTA III TT (1989 A 1995 - FIESTA IV TT APÓS 1996 - PUMA 1.7 - KA 1.3)</p> <p>275x34x34mm 2p-d10-20mm</p>
	<p><b>E0101</b> NO. 1135077 - 1209035</p> <p>ESTICADOR DA BARRA ESTABILIZADORA DA FRENTE</p> <p>FORD FIESTA III 1.8 D (1989 A 1995 - FIESTA IV 1.8 D APÓS 1996)</p> <p>265x25x25mm 2p-d10-30mm</p>		<p><b>E0102</b> NO. 1146150 - 2S613B438AC - Y125613B438AC - DD3234170 - 2S61.3B438.AD - 2S61.3B438.AE - 1761200 - 146921...</p> <p>ESTICADOR DA BARRA ESTABILIZADORA DA FRENTE</p> <p>FORD FIESTA V TT APÓS 11-2001 - FUSION TT</p> <p>320x34x34mm 2p-d10-28mm</p>
	<p><b>E0203-M</b> NO. 1055171 - 96FB6PO82AE</p> <p>ESTICADOR DO MOTOR</p> <p>FORD FIESTA COURIER 1.2 - 1.3 - 1.4D (APÓS 1996)</p> <p>260x97x65mm 1f-d11mm 1f-d10mm</p>		<p><b>E0221-M</b> NO. 1313587 - 3S616P082AA - 1141459 - 1526696</p> <p>ESTICADOR DO MOTOR PARTE INFERIOR</p> <p>FORD FIESTA (APÓS 2002)</p> <p>155x95x85mm NULL</p>
	<p><b>E0256-M</b> NO. 1526696 - 8V51.6P082.AC - DD32-39-060 - 1141459 - 1313587</p> <p>ESTICADOR DO MOTOR LADO DA CAIXA</p> <p>FORD FIESTA VI 1.25 (SNJA - SNJB) 82CV (APÓS 06-2008) - 1.25 (STJA - STJB) 60CV (APÓS 06-2008) - 1.4 (SPJA - SPJC) 97CV (APÓS 06-2008) - 1.4 LPG (RTJA - RTJB) 97CV (APÓS 01-2009) - 1.4 TDCi (F6JB) 68CV (APÓS 01-2009) - 1.6 TDCi (HHJC - HHJD - HHJE) 90CV (APÓS 06-2008)</p> <p>170x90x85mm 1f-d10,5mm 3f-d11mm</p>		<p><b>E0258</b> NO. D65134170 - 1513343 - 8V513B438AB - 8V51.3B438.BA - 8V51.3B438.BB - 1790310 - 1745924 - 1905043</p> <p>ESTICADOR DA BARRA ESTABILIZADORA DA FRENTE</p> <p>FORD - FIESTA V Van 1.4 TDCi (10.03 - 12.10) 68cv 1399cc - FORD - FIESTA VI - 1.25 EFI (APÓS 06.08) 60cv 1242cc - FORD - FIESTA VI - 1.25 EFI (APÓS 06.08) 82cv 1242cc - FORD - FIESTA VI - 1.4 PFI (APÓS 06.08) 97cv 1388cc - FORD - FIESTA VI 1.4 LPG PFI (AP)</p> <p>290x36x35mm 2p-d10x25mm</p>
	<p><b>E1029</b> NO. 6882943 - 6827033</p> <p>ESTICADOR DE ESCAPE</p> <p>FORD FIESTA 0.9 - 1.1 - 1.3 - 1.4 - 1.6 XR2 - 1.6D (1977 A 1989)</p> <p>63x47x18mm NULL</p>		<p><b>E1070</b> NO. 1016405 - 1003890</p> <p>ESTICADOR DE ESCAPE</p> <p>FORD FIESTA D (APÓS 1996)</p> <p>70x50x27mm NULL</p>

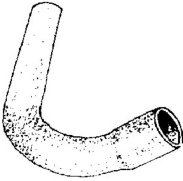









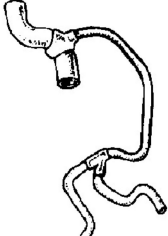



	<p><b>E1087</b> NO. 1022729</p> <p>ESTICADOR DO ESCAPE</p> <p>FORD FIESTA (1995 A 2002) - PUMA (1997)</p> <p>70x50x25mm NULL</p>		<p><b>F0386-I</b> NO. 6047901 - 6079916 - 1470870</p> <p>FOLE DA CREMALHEIRA DA DIREÇÃO ESQ. E DIR.</p> <p>FORD FIESTA TT (1976 A 1989)</p> <p>d59x157mm 1f-d30mm 1f-d10mm</p>
	<p><b>F0387-I</b> NO. 6047900 - 6047904</p> <p>FOLE DA CREMALHEIRA DA DIREÇÃO ESQ. E DIR.</p> <p>FORD FIESTA I 0.9 - 1.1 - 1.3 - 1.6 - (1976 A 1986) - FIESTA II 1.0 - 1.1 - 1.3 - 1.4 . 1.6 . 1.6D (1983 A 1989)</p> <p>d58x127mm 1f-d47mm 1f-d8mm</p>		<p><b>F0538-I</b> NO. 6043191 - 77TTA331FA - 98AX.4A084.BA - 1073846</p> <p>FOLE DO SEMI-EIXO JUNTO À RODA OU CAIXA DE VELOCIDADES</p> <p>FORD FIESTA TT (1976 A 2001) - FORD PUMA 1.4 - 1.7 (APÓS 1997)</p> <p>d92x100mm 1f-d75mm 1f-d20mm</p>
	<p><b>F0539-I</b> NO. 77TT3A331AA - 6028724 - 556021105 - 1016756</p> <p>FOLE DO SEMI-EIXO JUNTO À RODA</p> <p>FORD FIESTA 0.9 - 1.0 - 1.1 (1976 A 1995)</p> <p>d81x100mm 1f-d68mm 1f-d20mm</p>		<p><b>F0547-I</b> NO. 6028751 - 77TT3A331BA - 1073802 - 1016758 - 6161378 - 86AG3A331AA - 98FX4A084CA - 98FX4A084BA - 1072...</p> <p>FOLE DO SEMI-EIXO JUNTO À CAIXA DE VELOCIDADES</p> <p>FORD FIESTA 0.9 - 1.0 - 1.1 (1976 A 1995)</p> <p>d63x93mm 1f-d72mm 1f-d19mm</p>
	<p><b>F1043-18</b> NO. 1450821 - 69AB3025BA</p> <p>FOLE DO AMORTECEDOR DA SUSPENSÃO FRENTE</p> <p>FORD FIESTA (0.9 - 1.1 - 1.3 - 1.4 - 1.6) - FIESTA DIESEL</p> <p>d75x145mm 1f-d68mm 1f-d18mm</p>		<p><b>F1183-I</b> NO. 6676140 - 92AG003L537AA</p> <p>FOLE JUNTO À CAIXA DE VELOCIDADES</p> <p>FORD FIESTA III 1.8 16V (02-1992 A 12-1993)</p> <p>d100x103mm 1f-d85mm 1f-d23mm</p>
	<p><b>F1444-I</b> NO. 6676136 - 92TT3A331</p> <p>FOLE DA TRANSMISSÃO JUNTO À RODA</p> <p>FORD FIESTA III 1.25i 16V - 1.3i - 1.4i 16V - 1.6i SPORT 16V - 1.8 D - 1.8 DI (1989 A 1995)</p> <p>d104x92mm 1f-d87mm 1f-d23mm</p>		<p><b>F1444-I</b> NO. 6676136 - 92TT3A331</p> <p>FOLE DA TRANSMISSÃO JUNTO À RODA</p> <p>FORD FIESTA IV 1.2i 16V - 1.3i - 1.4i 16V - 1.6i SPORT 16V - 1.8 D - 1.8 DI (1995 A 2001)</p> <p>d104x92mm 1f-d87mm 1f-d23mm</p>
	<p><b>F1615-I</b> NO. 1016772 - 1073804 - 98FX4A084DA</p> <p>FOLE DA TRANSMISSÃO JUNTO À CAIXA</p> <p>FORD FIESTA III (89 A 95) 1.1i - 1.25i 16V - 1.3i - 1.4i</p> <p>d87x114mm 1f-d77mm 1f-d23mm</p>		<p><b>F1615-I</b> NO. 1016772 - 1073804 - 98FX4A084DA</p> <p>FOLE DA TRANSMISSÃO JUNTO À CAIXA</p> <p>FORD FIESTA IV (95 A 01) 1.25i - 1.3i - COURIER (APÓS 1996) 1.3i - 1.4i</p> <p>d87x114mm 1f-d77mm 1f-d23mm</p>
	<p><b>F1623-I</b> NO. 1142813 - 2S61-4A084-AA - 2S61-4A084-BA</p> <p>FOLE DA TRANSMISSÃO JUNTO À RODA</p> <p>FORD FIESTA V 1.4 TDCi - 1.6i 16V (APÓS 2001)</p> <p>d82x86mm 1f-d69mm 1f-d21mm</p>		<p><b>F1623-I</b> NO. 1142813 - 2S61-4A084-AA - 2S61-4A084-BA</p> <p>FOLE DA TRANSMISSÃO JUNTO À RODA</p> <p>FORD FUSION 1.4 TDCi - 1.6i (APÓS 2002)</p> <p>d82x86mm 1f-d69mm 1f-d21mm</p>
	<p><b>F1649-I</b> NO. 1012814 - 3043575 - 7138554 - 94FB3K661AC</p> <p>FOLE DA DIREÇÃO ASSISTIDA LADO DIREITO E ESQUERDO</p> <p>FORD FIESTA III (1989 A 1995) 1.1i - 1.25i 16V - 1.3i - 1.4i - 1.4i 16V - 1.6i SPORT 16V - 1.8 D - 1.8 DI - FIESTA IV (1995 A 2001) 1.25i - 1.3i - 1.4i - 1.6i - 1.8 D - 1.8 DI - COURIER APÓS 1996 1.3i - 1.4i - 1.8 D - PUMA APÓS 1997 1.4 16V - 1.7 16</p> <p>d70x190mm 1f-d55mm 1f-d12mm</p>		<p><b>F1668-I</b> NO. 1619061 - 83BB.3K661.BD</p> <p>FOLE DA DIREÇÃO DIREITO E ESQUERDO</p> <p>FORD FIESTA (1989 A 1992)</p> <p>d62x200mm 1f-d37mm 1f-d10mm</p>





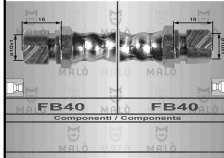
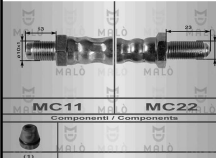
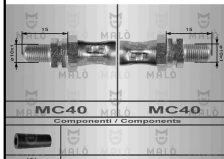

	<p><b>F1820-I</b> NO. 2S614A084AA - 1142813</p> <p>FOLE DA TRANSMISSÃO JUNTO À CAIXA</p> <p>FORD FIESTA V 1.4TDCi (APÓS 2001)</p> <p>d85x88mm 1f-d73mm 1f-d19mm</p>		<p><b>F1820-I</b> NO. 2S614A084AA - 1142813</p> <p>FOLE DA TRANSMISSÃO JUNTO À CAIXA</p> <p>FORD FUSION 1.4 TDCi (APÓS 2002)</p> <p>d85x88mm 1f-d73mm 1f-d19mm</p>
	<p><b>F1844-I</b> NO. 1026905 - 1073806 - 1304000 - 1S5W3L537AA - 1S5W4A084AA - 1S5W4A084BA - 4453301 - 97FG3L537AB</p> <p>FOLE DA TRANSMISSÃO JUNTO À CAIXA</p> <p>FORD FIESTA IV 1.25i 16V - 1.3i - 1.4i 16V - 1.6i SPORT 16V - 1.8D - 1.8Di (95 A 01)</p> <p>d91x102mm 1f-d80mm 1f-d22mm</p>		<p><b>H312</b> NO.</p> <p>PALA ORIGINAL</p> <p>FORD FIESTA</p> <p>360x195mm NULL</p>
	<p><b>KF1606</b> NO. 1142813 - 2S61-4A084-AA - 2S61-4A084-BA</p> <p>KIT DE FOLE DO CARDAN JUNTO À RODA</p> <p>FORD FIESTA V 1.4 TDCi - 1.6i 16V (APÓS 2001) - FUSION 1.4 TDCi - 1.6i (APÓS 2002)</p> <p>d90x85mm 1f-d66mm 1f-21mm</p>		<p><b>KF1800</b> NO. 6028724 - 77TT3A331AA - 556021105 - 1016756</p> <p>FOLE DO LADO DA RODA (DIAM. 68mm)</p> <p>FORD FIESTA 1.0 - 1.1 - N. FIESTA - FIESTA VAN</p> <p>d89x100mm 1f-d20mm 1f-d68mm</p>
	<p><b>KF1810</b> NO. 1638320 - 6043191 - 1073846 - 98AX.4A084.BA - 77TT3A331FA</p> <p>FOLE DO LADO DA RODA (DIAM. 78mm)</p> <p>FORD FIESTA 1.3 - 1.6 - NEW FIESTA</p> <p>d93x103mm 1f-d20mm 1f-d78mm</p>		<p><b>KF9003</b> NO. 1073804 - 98FX4A084DA</p> <p>KIT DE FOLE DO CARDAN LADO DA CAIXA</p> <p>FORD FIESTA APÓS 1995</p> <p>d82x110mm 1f-d71mm 1f-d21mm</p>
	<p><b>KF9005</b> NO. XS4J4A084DA - 1349165</p> <p>KIT DE FOLE DO CARDAN LADO DA RODA</p> <p>FORD FIESTA APÓS 1995 - FOCUS APÓS 1998</p> <p>d96x112mm 1f-d80mm 1f-d31mm</p>		<p><b>KF9008</b> NO. 1142817 - 2S614A084DA</p> <p>KIT DE FOLE DO LADO DA RODA</p> <p>FORD FIESTA APÓS 2002</p> <p>d80x80mm 1f-d67mm 1f-d21mm</p>
	<p><b>KF9009</b> NO. 1142816 - 2S614A084CA</p> <p>KIT DE FOLE DA LADO DA CAIXA</p> <p>FORD FIESTA APÓS 2002</p> <p>d76x83mm 1f-d66mm 1f-d16mm</p>		<p><b>KF9010</b> NO. 2S614A084AA - 1142811</p> <p>KIT DE FOLE DO CARDAN JUNTO À RODA E CAIXA</p> <p>FORD FIESTA APÓS 2002 - FUSION</p> <p>d82x80mm d76x83mm 1f-d68mm 1f-d22mm 1f-d65mm 1f-d16mm</p>
	<p><b>KL1066-I</b> NO. 6189055</p> <p>KIT DO PEDAL DA EMBRAIAGEM</p> <p>FORD FIESTA (2ª SÉRIE)</p> <p>123x70x20mm NULL</p>		<p><b>L3005</b> NO. 6076533 - 1568682</p> <p>CASQUILHO DA EXTREMIDADE DA CREMALHEIRA DA DIRECÇÃO</p> <p>FORD FIESTA 0.9 - 1.1 - 1.3 - 1.4 - 1.6 - FIESTA DIESEL</p> <p>32x32x18mm 1f-d22mm</p>
	<p><b>L3008</b> NO. 1610371</p> <p>CASQUILHO DA DIRECÇÃO</p> <p>FORD FIESTA I 0.9 - 1.1 - 1.3 - 1.6 XR2 (1976 A 1983) - FIESTA II 1.1 - 1.3 - 1.4 - 1.6D (1983 A 1989)</p> <p>35x35x18mm 1f-d22mm</p>		<p><b>L3012</b> NO. 6140086 - 1621933 - 6100905</p> <p>CASQUILHO DA BARRA ESTABILIZADORA</p> <p>FORD FIESTA I 0.9 - 1.1 - 1.3 - 1.6 XR2 (1976 A 1983) - FIESTA II 1.1 - 1.3 - 1.4 - 1.6D - 1.6XR2 (1983 A 1989)</p> <p>d45x15mm 1f-17mm</p>

	<p><b>L3105</b> NO. 1204698 - 2S6Q9A510AA</p> <p>CASQUILHO DO INJECTOR</p> <p>FORD FIESTA (APÓS 2002)</p> <p>d24x10mm 1f-d20mm</p>		<p><b>M6002</b> NO. 6616584 - 6688868 - 6166244 - 6201608 - 6156722 - 1656281</p> <p>JUNTA DE ESCAPE</p> <p>FORD FIESTA (1989 A 1992)</p> <p>d66x14mm 1f-d50mm</p>
	<p><b>M6037</b> NO. 6065962 - 1565558 - 6115136 - 6134623 - 6615275 - 6134622 - 81AB9451AA</p> <p>JUNTA DE ESCAPE</p> <p>FORD FIESTA (1981 A 1995)</p> <p>107x80mm 2f-d42mm</p>		<p><b>M6043</b> NO. 6134624 - 6120664 - 1630835 - 6120644 - 6163389</p> <p>JUNTA DE ESCAPE</p> <p>FORD FIESTA (1983 A 1995)</p> <p>120x80mm 2f-d42mm</p>
	<p><b>M6069</b> NO. 6645622</p> <p>JUNTA DE ESCAPE</p> <p>FORD FIESTA (1983 A 1989)</p> <p>120x65mm 2f-d42mm</p>		<p><b>M6070</b> NO. 1664671</p> <p>JUNTA DE ESCAPE</p> <p>FORD FIESTA (1989 A 1992)</p> <p>120x71mm 1f-d55mm</p>
	<p><b>M6071</b> NO. 6168647 - 6645621</p> <p>JUNTA DE ESCAPE</p> <p>FORD FIESTA (1989 A 1992)</p> <p>124x75mm 2f-d45mm</p>		<p><b>M6095</b> NO. 6789153 - 7398780</p> <p>JUNTA DE ESCAPE</p> <p>FORD FIESTA (1992 A 1995)</p> <p>d95x13mm 1f-d75mm</p>
	<p><b>M6102</b> NO. 6162279 - 6692744 - 6642511 - 6159982</p> <p>JUNTA DE ESCAPE</p> <p>FORD FIESTA (1995 A 1999)</p> <p>127x70x2mm 1f-d56mm</p>		<p><b>M6108</b> NO. 6026339</p> <p>JUNTA DE ESCAPE</p> <p>FORD FIESTA (81-84)</p> <p>57x14mm 1f-d43mm</p>
	<p><b>N2002</b> NO. 1719466 - 113E5381B</p> <p>ANEL DE ESCAPE</p> <p>FORD FIESTA (1981 A 1996)</p> <p>d43x12mm 1f-d19mm</p>		<p><b>P1010</b> NO. 1526242 - 72EB2457BA</p> <p>CAPA DE PEDAL DO TRAVÃO E EMBRAIAGEM</p> <p>FORD FIESTA (0.9 - 1.1 - 1.3 - 1.4 - 1.6) - FIESTA DIESEL</p> <p>70x50x18mm NULL</p>
	<p><b>P1026</b> NO. 6168375 - 89FB.2457.AA</p> <p>CAPA DE PEDAL TRAVÃO E EMBRAIAGEM</p> <p>FORD FIESTA III 1.1 - 1.4 - 1.6 - 1.6i 16V (1989 A 1995) - FIESTA IV 1.0i - 1.25i 16V - 1.3i - 1.4i 16V - 1.8D (1995 A 2002) - FORD KA 1.0i - 1.3i (1996 A 2002)</p> <p>68x54x14mm NULL</p>		<p><b>R220196</b> NO. 6047976 - 6827019</p> <p>TUBO DE RADIADOR INFERIOR</p> <p>FORD FIESTA 0.9 - 1.1 (1976 A 1983) - FIESTA II 1.1 (1983 A 1989)</p> <p>B300-d31/31mm 120-250mm</p>
	<p><b>R220440</b> NO. 1459488 - 1546885</p> <p>TUBO DE RADIADOR INFERIOR</p> <p>FORD FIESTA I 1.1 (1981 A 1983)</p> <p>B240-d33/33mm 145-170-90mm</p>		<p><b>R220441</b> NO. 1595579 - 6115579</p> <p>TUBO DE RADIADOR INFERIOR</p> <p>FORD FIESTA I 1.1 (1981 A 1983)</p> <p>B430-d32/32mm 80-70-240-140mm</p>

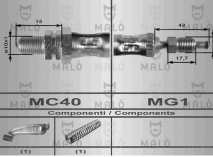
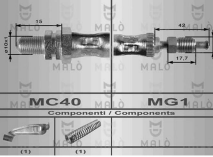
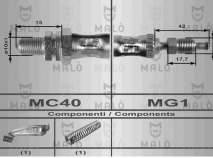
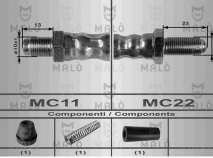
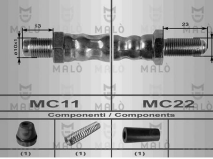
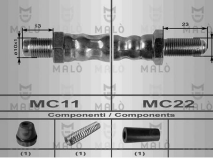
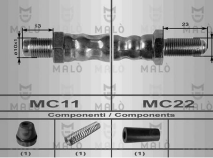
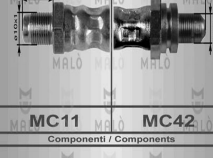
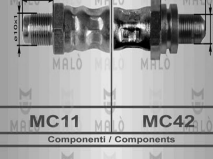
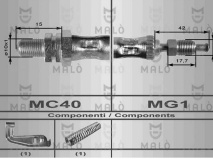
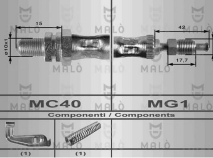
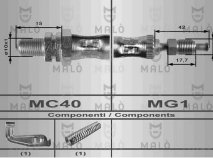
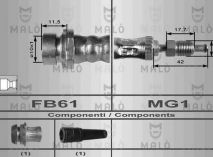
	<b>R220442</b> NO. 1465390 TUBO DE RADIADOR SUPERIOR FORD FIESTA I 1.1 (1981 A 1983) B190-d31/38mm 40-150-150mm		<b>R220447</b> NO. 6070349 - 6070359 TUBO DE RETORNO DA ÁGUA DO AQUECIMENTO FORD FIESTA I 1.1 (1981 A 1983) B410-d16/16mm 80-380-285-75mm
	<b>R220502</b> NO. 1595546 - 6099727 TUBO DE RADIADOR INFERIOR FORD FIESTA 1.3 MOTOR J4C (APÓS 02-1996) B300-d32/32mm 80-120-200-70mm		<b>R220510</b> NO. 6112689 TUBO DE RADIADOR SUPERIOR FORD FIESTA (0.9 - 1.1) (9-83 A 89) B280-d32/32mm 80-145-145mm
	<b>R220511</b> NO. 6139472 - 60603082 - 6133570 TUBO DE RADIADOR INFERIOR FORD FIESTA (0.9 - 1.1) (9-83 A 89) B335-d31/31mm 85-225-70mm		<b>R220512</b> NO. 4464791 - 6126535 TUBO DE RADIADOR SUPERIOR FORD FIESTA II 1.4 (09-1983 A 02-1989) B240-d32/35mm 50-110-140mm
	<b>R220514</b> NO. 6114422 TUBO DE ENVIO DE ÁGUA AO AQUECIMENTO FORD FIESTA 1.3 - 1.4 (1977 A 1989) B220-d15/15mm 145-140-80mm		<b>R220515</b> NO. 6114432 TUBO DE RETORNO DA ÁGUA DO AQUECIMENTO FORD FIESTA 1.3 - 1.4 (1977 A 1989) B435-d15/15mm 85-60-200-220-75mm
	<b>R220910</b> NO. 6182772 - 6895396 - 89FB.8260.AC TUBO DE RADIADOR SUPERIOR FORD FIESTA III 1.0 - 1.1 - 1.3 (03-1989 A 12-1995) B270-d30/30mm 70-85-210mm		<b>R220911</b> NO. 6182778 TUBO DE RADIADOR INFERIOR FORD FIESTA III 1.0 - 1.1 (03-1989 A 12-1995) B280-d27/27mm 75-125-135-65mm
	<b>R220912</b> NO. 6187709 - 6895399 TUBO DO DEPÓSITO DE REFRIGERAÇÃO AO RADIADOR FORD FIESTA III 1.0 - 1.1 (03-1989 A 12-1995) B465-d15/20mm 80-95-135-60-155-28mm		<b>R220913</b> NO. 6182763 - 6711500 TUBO DE LIGAÇÃO DO DEPÓSITO DE ARREFECIMENTO À BOMBA DE ÁGUA FORD FIESTA III 1.0 - 1.1 (03-1989 A 12-1995) B330-d9/7mm 100-175-90-75-50mm
	<b>R220914</b> NO. 6186538 TUBO DO AQUECIMENTO FORD FIESTA III 1.0 - 1.1 (03-1989 A 12-1995) B265-d15/15mm 70-160-90-90-75mm		<b>R220915</b> NO. 6178704 - 6895394 TUBO DE RETORNO DA ÁGUA AO DEPÓSITO DE ARREFECIMENTO FORD FIESTA III 1.0 - 1.1 (03-1989 A 12-1995) B135-d16/16mm 55-55-50mm
	<b>R220916</b> NO. 6178705 - 6895393 TUBO DE RETORNO DE ÁGUA AO DEPÓSITO DE ARREFECIMENTO FORD FIESTA III 1.0 - 1.1 (03-1989 A 12-1995) B290-d17/16mm 65-130-70-130-80-70mm		<b>R220926</b> NO. 6198870 TUBO 4 VIAS INFERIOR DA SAÍDA DE ÁGUA DO RADIADOR FORD FIESTA III 1.4 (03-1989 A 12 1995) B250-d34/31mm 80-100-100-90mm+ch101-d16mm+ch410-d7mm

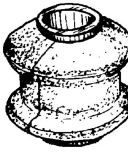
	<p><b>R220927</b> NO. 6198871</p> <p>TUBO DE RADIADOR INFERIOR COM 4 VIAS</p> <p>FORD FIESTA III 1.6 (01-1989 A 01-1994)</p> <p>B230-d32/32mm 75-110-75mm + ch d16mm 65-155-140-1</p>		<p><b>R221359</b> NO. 1040654 - 96FB8B274AG</p> <p>TUBO SUPERIOR DO RADIADOR</p> <p>FORD FIESTA IV 1.0i - 1.3i</p> <p>B390-d30/32mm 70-150-110-100mm + ch-d10mm 500mm</p>
	<p><b>R222400</b> NO. 1059164 - 98FB8B874AB</p> <p>TUBO SUPERIOR DO RADIADOR</p> <p>FORD FIESTA IV 1.0i - 1.3i (08-1995 A 01_2002) - FORD KA 1.0i (07-1997 A 09-1999)</p> <p>B295-d25/30mm 85-80-160mm</p>		<p><b>R222401</b> NO. 1037315 - 96FB8B274BE</p> <p>TUBO SUPERIOR DO RADIADOR</p> <p>FORD FIESTA IV 1.2 16V - 1.4 16V (APÓS 1996)</p> <p>B390-d30/33mm 75-95-115-120-70mm</p>
	<p><b>R222401</b> NO. 1037315 - 96FB8B274BE</p> <p>TUBO SUPERIOR DO RADIADOR</p> <p>FORD PUMA 1.7 16V (MOTOR MHB - MHA) (APÓS 03-1997)</p> <p>B390-d30/33mm 75-95-115-120-70mm</p>		<p><b>R222403</b> NO. 1037314 - 96FB8B273CD - 1010323 - 1023262</p> <p>TUBO INFERIOR DO RADIADOR</p> <p>FORD FIESTA IV 1.2 16V R-96 COM A-C (APÓS 1996) - 1.4 16V R-96 COM A-C - FORD PUMA 1.7</p> <p>B300-d34/32mm 80-50-210-95mm</p>
	<p><b>R222405</b> NO. 1049440 - 96FB8B274DB</p> <p>TUBO SUPERIOR DO RADIADOR</p> <p>FORD FIESTA 4 1.8D R-96 (APÓS 1996)</p> <p>B380-d32/32mm 80-160-100-50-80mm</p>		<p><b>R222406</b> NO. 1049439 - 1086229 - XS6I8B273HA</p> <p>TUBO INFERIOR DO RADIADOR</p> <p>FORD FIESTA 4 APÓS 96 1.8D R-96</p> <p>B255-d32/32mm 70-100-100-80-80-110mm</p>
	<p><b>R222407</b> NO. 1040652 - 96FB8B273DD</p> <p>TUBO INFERIOR DO RADIADOR</p> <p>FORD FIESTA IV 1.2 16V (1995 A 2002) 1.4 16v (1995 A 2002)</p> <p>B245-d32/32mm 100-145-120mm</p>		<p><b>R8135</b> NO. 6202491</p> <p>TUBO ACOPLAMENTO RADIADOR AQUECIMENTO</p> <p>FORD FIESTA III (GFJ) 1.8 D (03.89 A 12.95) 60cv 1753cc Hatchback</p> <p>B360-16/16mm 60-40-150-180-100-60-90mm</p>
	<p><b>R8140</b> NO. 6170465</p> <p>TUBO LIGAÇÃO CARBURADOR</p> <p>FORD FIESTA II (FBD) 1.3 (FBD) (09.83 A 01.87) 69cv 1296cc Hatchback - FORD FIESTA II (FBD) 1.4 (FBD) (10.86 A 02.89) 71cv 1392cc Hatchback - FORD FIESTA II (FBD) 1.6 XR2 (FBD) (03.84 A 02.89) 95cv 1597cc Hatchback - FORD FIESTA II (FBD) 1.6 XR2 (FBD) (04.84 A 02.89) 97cv 1597cc Hatchback</p> <p>B165-15/15mm 100-90-60mm</p>		<p><b>R8140</b> NO. 6170465</p> <p>TUBO LIGAÇÃO CARBURADOR</p> <p>FORD FIESTA III (GFJ) 1.4 (03.89 A 12.95) 71cv 1391cc Hatchback</p> <p>B165-15/15mm 100-90-60mm</p>
	<p><b>RT08222</b> NO. 1613347 - 1613348 - 5007396 - 6047604 - 6049556 - 77FB228KC</p> <p>TUBO DE TRAVÃO TRÁS LH-RH</p> <p>FORD FIESTA - FIESTA III 1.4 (03-1989 A 12-1995) - FIESTA III 1.4 CAT. (03-1989 A 12-1995) - FIESTA III 1.6 (01-1989 A 01-1994) - FIESTA III 1.6i 16V (01-1994 A 12-1995) - FIESTA III 1.6 TURBO (03-1990 A 10-1992) - FIESTA III 1.6 XR2i (03-1989 A 01-1994)</p> <p>315mm FB40 - FB40</p>		<p><b>RT08460</b> NO. 6114613</p> <p>TUBO DE TRAVAO FRENTE LH-RH</p> <p>FORD FIESTA 0.9 (05-1976 A 081983) - 1.0 (09-1983 A 02-1989) - 1.1 (05-1976 A 08-1983) - 1.3 (08-1977 A 01-1987) - 1.4 (09-1983 A 11-1989) - 1.6 XR2 (08-1981 A 02-1989) - 1.6D (04-1984 A 02-1989)</p> <p>385mm MC11 - MC22</p>
	<p><b>RT08565</b> NO. 6179304 - 6714710 - 1027745 - 6132910 - 91FB2282AA</p> <p>TUBO DE TRAVÃO TRÁS LH-RH</p> <p>FORD FIESTA III - FIESTA IV TT (1989 A 07-1995)</p> <p>340mm MC40 - MC40</p>		<p><b>RT08580</b> NO. 1666294 - 6667473 - 91AB2282AD</p> <p>TUBO DE TRAVÃO TRÁS LH-RH</p> <p>FORD FIESTA 1.1 (02-1981 A 08-1983) - 1.8 16V (02-1992 A 12-1995)</p> <p>490mm MC11 - MC22</p>

 <p>MC40 MG1 Component / Components</p>	<p><b>RT08604</b> NO. 1021841 - 1033252 - 1066801 - 1109679 - 96FB2078CG - 96FB2078EA - 96FB2078JA - XS612078DA - 1036500 ...</p> <p><b>TUBO DE TRAVÃO FRENTE RH</b></p> <p>FORD FIESTA Furgonato (J5_ - J3_) 1.3(JAC) 60CV (APÓS 02-1996) - 1.4 i (FHA) 90CV (04-1996 A 10-1999) - 1.8 D (RTK) 60CV (APÓS 02-1996) - 1.8 DI (RTN - RTP) 75CV (APÓS 09-2000) - (JV) D 1.8 (RTJ - RTK) 60CV (APÓS 05-1998) - TD 1.8 (RTN - RTP - RTQ) 75CV (APÓS 03-20)</p> <p>415mm MC40 - MG1</p>	 <p>MC40 MG1 Component / Components</p>	<p><b>RT08604</b> NO. 1021841 - 1033252 - 1066801 - 1109679 - 96FB2078CG - 96FB2078EA - 96FB2078JA - XS612078DA - 1036500 ...</p> <p><b>TUBO DE TRAVÃO FRENTE LH</b></p> <p>FORD FIESTA IV (JA_ - JB_) 1.0 i (MOTORE GENERICO) 65CV (09-1999 A 01-2002) - 1.0 i (ZH10JRB) 52CV (02-1997 A 09-1999) - 1.25 i 16V (DHA - DHB - DHC - DHD - DHE - DHF - DHG) 75CV (08-1995 A 01-2002) - 1.3 i (J4C - J4J - J4L - J4Q - J4R - J4T - JBC) 60CV (08-1995 A 01-2002) - 1.3 i</p> <p>415mm MC40 - MG1</p>
 <p>MC40 MG1 Component / Components</p>	<p><b>RT08604</b> NO. 1021841 - 1033252 - 1066801 - 1109679 - 96FB2078CG - 96FB2078EA - 96FB2078JA - XS612078DA - 1036500 ...</p> <p><b>TUBO DE TRAVÃO FRENTE RH</b></p> <p>FORD PUMA (EC_) 1.4 16V (FHD - FHF) 90CV (11-1997 A 10-2000) - 1.6 16V (L1W) 103CV (08-2000 A 06-2002) - 1.7 16V (MHA - MHB) 125CV (03-1997 A 06-2002) - ST 160 (MOTORE GENÉRICO) 160CV (06-1999 A 06-2002)</p> <p>415mm MC40 - MG1</p>	 <p>MC11 MC22 Component / Components</p>	<p><b>RT08605</b> NO. 1013815</p> <p><b>TUBO DE TRAVÃO FRENTE LH-RH</b></p> <p>FORD FIESTA III 1.0 (03-1989 A 12-1995) - 1.1 (03-1989 A 12-1995) - 1.3 (03-1989 A 12-1992) - 1.4 (03-1989 A 12-1995) - 1.6 (01-1989 A 01-1994) - 1.6i 16V (01-1994 A 12-1995) 1.6XRRI (03-1989 A 01-1994) - 1.8D (03-1989 A 12-1995)</p> <p>435mm MC11 - MC22</p>
 <p>MC11 MC22 Component / Components</p>	<p><b>RT08605</b> NO. 1013815</p> <p><b>TUBO DE TRAVÃO TRÁS LH</b></p> <p>FORD PUMA 1.4 16V (11-1997 A 10-2000) - 1.6 16V (APÓS 08-2000) - 1.7 16V (APÓS 03-1997)</p> <p>435mm MC11 - MC22</p>	 <p>MC11 MC22 Component / Components</p>	<p><b>RT08605</b> NO. 1013815 - 1034192 - 6569119 - 7271916 - 96FB2078DA</p> <p><b>TUBO DE TRAVÃO FRENTE LH</b></p> <p>FORD COUGAR 2.0 16V (08-1998 A 12-2001) - COUGAR 2.5 ST 200 (01-2000 A 12-2001) - COUGAR 2.5 V6 24V (08-1998 A 12-2001)</p> <p>435mm MC11 - MC22</p>
 <p>MC11 MC22 Component / Components</p>	<p><b>RT08605</b> NO. 1013815 - 1034192 - 6569119 - 7271916 - 96FB2078DA</p> <p><b>TUBO DE TRAVÃO FRENTE LH</b></p> <p>FORD FIESTA FURGONATO 1.0 (10-1977 A 11-1989) - 1.1 (10-1977 A 11-1986) - FIESTA I 0.9 (05-1976 A 08-1983) - 1.1 (05-1976 A 08-1983) - 1.3 (08-1977 A 08-1983) - 1.6 XR2 (08-1981 A 08-1983) - FIESTA II 1.0 (09-1983 A 11-1989) - 1.1 (09-1983 A 02-1989) - 1.</p> <p>435mm MC11 - MC22</p>	 <p>MC11 MC42 Component / Components</p>	<p><b>RT08607</b> NO. 1011342 - 1014204 - 96FB2282AC</p> <p><b>TUBO DE TRAVÃO TRÁS LH-RH</b></p> <p>FORD FIESTA IV (JA_ - JB_) 1.25 i 16V (DHC - DHB - DHF - DHD - DHE - DHA - DHG) 75CV (08-1995 A 01-2002) - 1.3 i (J4J - J4R - J4L - JBC - J4Q - J4T - J4C) 60CV (08-1995 A 01-2002) - 1.3 i (JJC - JJE - JJK - JJJ - JJM - JJA) 50CV (08-1995 A 01-2002) - 1.6 16V Sport (L1T - L1V) 103CV (02-2000 A</p> <p>335mm MC11 - MC42</p>
 <p>MC11 MC42 Component / Components</p>	<p><b>RT08607</b> NO. 1011342 - 1014204 - 96FB2282AC</p> <p><b>TUBO DE TRAVÃO TRÁS LH-RH</b></p> <p>FORD PUMA (EC_) 1.7 16V (MHB - MHA) 125CV (03-1997 A 06-2002) - 1.4 16V (FHD - FHF) 90CV (11-1997 A 10-2000) - ST 160 (MOTORE GENERICO) 160CV (06-1999 A 06-2002)</p> <p>335mm MC11 - MC42</p>	 <p>MC40 MG1 Component / Components</p>	<p><b>RT08687</b> NO. 1021839 - 1066796 - 1109678 - 96FB2078BG - 96FB2078HA - XS612078CA - 1034192 - 1014201 - 1016623 - ...</p> <p><b>TUBO DE TRAVÃO FRENTE LH</b></p> <p>FORD FIESTA Furgonato 1.3 (j5_ - j3_)(j4c) 60CV (APÓS 02-1996) - 1.4 i (FHA) 90CV (04-1996 A 10-1999) - 1.8 D (RTK) 60CV (APÓS 02-2996) - 1.8 DI (RTN - RTP) 75CV (APÓS 09-2000) - D 1.8 (RTJ - RTK) 60CV (APÓS 05-1998) - TD 1.8 (RTN - RTP - RTQ) 75CV (APÓS 03-2003)</p> <p>415mm MC40 - MG1</p>
 <p>MC40 MG1 Component / Components</p>	<p><b>RT08687</b> NO. 1021839 - 1066796 - 1109678 - 96FB2078BG - 96FB2078HA - XS612078CA - 1034192 - 1014201 - 1016623 - ...</p> <p><b>TUBO DE TRAVÃO FRENTE LH</b></p> <p>FORD FIESTA IV (JA_ - JB_) 1.0 i (MOTORE GENÉRICO) 65CV (09-1999 A 01-2002) - 1.0 i (ZH10JRB) 52CV (02-1997 A 09-1999) - 1.25 i 16V (DHA - DHB - DHC - DHD - DHE - DHF - DHG) 75CV (08-1995 A 01-2002) - 1.3 i (J4C - J4J - J4L - J4Q - J4R - J4T - JBC) 60CV (08-1995 A 01-2002) - 1.3 i</p> <p>415mm MC40 - MG1</p>	 <p>MC40 MG1 Component / Components</p>	<p><b>RT08687</b> NO. 1021839 - 1066796 - 1109678 - 96FB2078BG - 96FB2078HA - XS612078CA - 1034192 - 1014201 - 1016623 - ...</p> <p><b>TUBO DE TRAVÃO FRENTE LH</b></p> <p>FORD PUMA (EC_) 1.4 16V (FHD - FHF) 90CV (11-1997 A 10-2000) - 1.6 16V (L1W) 103CV (08-2000 A 06-2002) - 1.7 16V (MHA - MHB) 125CV (03-1997 A 06-2002) - ST 160 (MOTORE GENÉRICO) 160CV (06-1999 A 06-2002)</p> <p>415mm MC40 - MG1</p>
 <p>FB61 MG1 Component / Components</p>	<p><b>RT08914</b> NO. 1201141 - 1437504 - D43643980</p> <p><b>TUBO DE TRAVÃO FRENTE LH-RH</b></p> <p>FORD FIESTA V TT (APÓS 11-2001)</p> <p>520mm FB61 - MG1</p>	 <p>FB69 FB69 Component / Components</p>	<p><b>RT08970</b> NO. 1151027 - 1217819</p> <p><b>TUBO DE TRAVÃO TRÁS LH-RH</b></p> <p>FORD FIESTA V (APÓS 11-01) TT</p> <p>325mm FB69 - FB69</p>
	<p><b>S1096</b> NO. 6042743 - 77FB3432AB</p> <p><b>SILENT-BLOC - CASQUILHO DO BRAÇO DA SUSPENSÃO DA FRENTE</b></p> <p>FORD FIESTA 0.9 - 1.1 - 1.3 - 1.4 - 1.6 (ATÉ 1989)</p> <p>d39x46mm d31mm 1f-d14mm</p>		<p><b>S1097</b> NO. 6042740 - 77FB3036AE - 81AB3063BA - 1619120 - 3240198 - 3246127 - 5021729 - 6087890 - 6090611 - 81AB... </p> <p><b>SILENT-BLOC DO TIRANTE DO BRAÇO DA SUSPENSÃO DA FRENTE</b></p> <p>FORD FIESTA 0.9 - 1.1 - 1.3 - 1.4 - 1.6 (ATÉ 1989)</p> <p>d37x51mm d32mm 1f-d10mm</p>



	<p><b>S1109</b> NO. 6193085-86 - 91AB3A262AA - 1035929</p> <p>SILENT-BLOC DO BRAÇO FRENTE</p> <p>FORD FIESTA 0.9 - 1.1 - 1.3 - 1.4 - 1.6 - FIESTA DIESEL (APÓS 1989) - FORD KA 1.3i (1996 A 2002)</p> <p>d61x46mm d54mm 1f-d12mm</p>		<p><b>S1110</b> NO. 6193885-86 - 89FB3063ADB492A - 89FB.3063.A1D - T128417 - 89FB.3063.AD - 1000445 - 1829508</p> <p>SILENT-BLOC DO BRAÇO FRENTE</p> <p>FORD FIESTA (0.9 - 1.1 - 1.3 - 1.4 - 1.6) - FIESTA DIESEL DESDE 89</p> <p>d46x46mm 1f-d12mm</p>
	<p><b>S1259</b> NO. 6745350 - 91AB.5K653.BB - 6163419</p> <p>SILENT-BLOC DA SUSPENSÃO DE TRÁS</p> <p>FORD FIESTA III 1.1 - 1.3 - 1.4 - 1.6 - 1.6i 16V - 1.6 XR2i 16V - 1.8D - 1.8 XR2i 16V (1989 A 1997)</p> <p>d59x70mm d52mm 1f-d12mm</p>		<p><b>S1264</b> NO. 1014654 - 96FB3A262AD - 98FB.3A262.AA - 1063372 - 1E01-34-153A</p> <p>SILENT-BLOC DO BRAÇO DA SUSPENSÃO FRENTE PARTE DE TRÁS</p> <p>FORD FIESTA (APÓS 1995) - FORD KA 1.0i (07-1997 A 09-1999) - FORD PUMA 1.7 16V (APÓS 03-1997)</p> <p>d66x50mm c30mm 1f-d12mm</p>
	<p><b>S1265</b> NO. 1010037 - 96FB3063AB - 98FB.3063.AA - 1055191 - 1E00-34-153A</p> <p>SILENT-BLOC DO BRAÇO DA SUAPENSÃO FRENTE PARTE DA FRENTE</p> <p>FORD FIESTA (APÓS 1995) - FORD KA 1.0i (07-1997 A 09-1999) - FORD PUMA 1.7 16V (APÓS 03-1997)</p> <p>d37x62mm c44mm 1f-d11.5mm</p>		<p><b>S1274</b> NO. 77TT7L259AF</p> <p>SILENT-BLOC REPARAÇÃO DA CAIXA DE VELOCIDADES</p> <p>FORD FIESTA</p> <p>d28x38mm c32mm 1f-d11.5mm</p>
	<p><b>S1418</b> NO. 1204338 - 2S61.5K653.AA - 2S61.5K653.AB - 2S61.5K653.AE - 2S61.5K653.AF - 2S61.5K653.AG - 5S61.5K653.AH</p> <p>SILENT BLOC DA SUSPENSÃO DE TRÁS</p> <p>FORD FIESTA V (APÓS 11-2001) - FUSION</p> <p>d69x70mm d60mm 1f-12mm</p>		<p><b>S1442</b> NO. 2S613A262AD - 1146131 - 1207448 - 1212809 - 121280752</p> <p>SILENT-BLOC DO BRAÇO DA SUSPENSÃO DA FRENTE PARTE EXTERNA</p> <p>FORD FIESTA (APÓS 2002) - FORD FUSION (APÓS 2002)</p> <p>150x73x65mm 1f-d22mm</p>
	<p><b>S1449</b> NO. 2S613063CA - 1212807 - 121280751</p> <p>SILENT-BLOC DO BRAÇO DA SUSPENSÃO DA FRENTE PARTE INTERNA</p> <p>FORD FIESTA (APÓS 2002) - FORD FUSION (APÓS 2002)</p> <p>d50x55mm c39mm d41mm 1f-12.2mm</p>		<p><b>S1477</b> NO. 7371059 - 95ABS653CA - 1S655K653AA - 4377687 - 1041979 - 7215747 - 97AG5K653AA - ABSK653AC</p> <p>SILENT BLOC DO EIXO TRASEIRO</p> <p>FORD FIESTA IV 1.0i - 1.25i 16V - 1.3i - 1.4i 16V - 1.6 16V SPORT - 1.8D - 1.8Di (1995 A 2002)</p> <p>d75x70mm d64mm 1f-d12mm</p>
	<p><b>S1576</b> NO. 1805815 - 8V515K653BA - 8V515K653AA - 1535296 - 1775568 - 8V513K155AA - D65128460</p> <p>SILENTBLOC SUSPENSÃO TRÁS</p> <p>FORD FIESTA VI 1.0 (A Partir de 01.13) 65cv 998cc Hatchback - FORD FIESTA VI 1.0 (A Partir de 10.12) 80cv 998cc Hatchback - FORD FIESTA VI 1.0 EcoBoost (A Partir de 01.13) 100cv 998cc Hatchback - FORD FIESTA VI 1.0 EcoBoost (A Partir de 09.12) 125cv 998cc Hatchback - FORD FIESTA VI 1.0 Sport (A Partir de 05.14) 140cv 998cc Hatchback - FORD FIESTA VI 1.25 (A Partir de 06.08) 60cv 1242cc Hatchback - FORD FIESTA VI 1.25 (A Partir de 06.0...etc.</p> <p>d80x78mm c49mm d77mm 1f-d12mm</p>		<p><b>T0034</b> NO. 6543416</p> <p>BATENTE DA BARRA ESTABILIZADORA DA SUSPENSÃO TRÁS DIAM. 16mm</p> <p>FORD FIESTA III 1.0 - 1.1 - 1.3 - 1.4 - 1.6 - 1.6i 16V - 1.8 16V - 1.8D (1989 A 2002) - FORD PUMA 1.7 16V (APÓS 03-1997)</p> <p>41x38x32mm 1f-d16mm</p>
	<p><b>T0605-I</b> NO. 6532212 - 90BB.3025.AA - 97FU.3025.AA</p> <p>BATENTE DA SUSPENSÃO DA FRENTE</p> <p>FORD FIESTA III 1.1 - 1.4 - 1.6 - 1.6i 16V (1989 A 1995) - FIESTA IV 1.0i - 1.25i 16V - 1.3i - 1.4i 16V - 1.8D (1995 A 2002) - FORD KA 1.0i (1997 A 1999) - FORD PUMA 1.7 16V (APÓS 03-1997)</p> <p>d50x69mm 1f-d22mm 1f-d18mm</p>		<p><b>T1030F11</b> NO. 6046476</p> <p>BATENTE BARRA ESTABILIZADORA (CENTRO)</p> <p>FORD FIESTA 1.0 - 1.1 - 1.3 - 1.4 - 1.6 - 1.6i 16V - 1.8D (1989 A 1995) - FORD COURIER 1.8D (09-1991 - A 02-1996)</p> <p>32x32x27mm 1f-d11mm</p>
	<p><b>T1030F12</b> NO. 1652936</p> <p>BATENTE BARRA ESTABILIZADORA (CENTRO)</p> <p>FORD FIESTA III 1.0 - 1.1 - 1.3 - 1.4 - 1.6 - 1.6i 16V - 1.8D (1989 A 1995) - FORD COURIER 1.8D (09-1991 A 02-1996)+F525</p> <p>32x32x27mm 1f-d12mm</p>		<p><b>T1030F15</b> NO. 6154572 - 7144201 - 934A037EA</p> <p>BATENTE DA BARRA ESTABILIZADORA</p> <p>FORD FIESTA - MONDEO (APÓS 1996)</p> <p>32x32x27mm 1f-d15mm</p>

	<b>T1045</b> NO. 1003609 - 96FB5484CA BATENTE DA BARRA ESTABILIZADORA FRENTE CENTRO FORD FIESTA IV 1.0i - 1.25i 16V - 1.3i - 1.4i 16V - 1.6 16V SPORT - 1.8D (1995 A 2002) - FORD KA 1.0i - 1.3i (1996 A 2002)		<b>T1050</b> NO. 7102392 - 94AB.5484.AA - 98AB.5484.AB - 1145272 - 1128725 - 6543416 - 6185809 - YS81.5484.AA - 1E00-... BATENTE DO CENTRO DA BARRA ESTABILIZADORA FORD FIESTA 1.0 - 1.1 - 1.3 - 1.4 - 1.6 - 1.6i 16V - 1.8 16V - 1.8D (1989 A 1995) - FIESTA IV 1.4i 16V - 1.8D (1995 A 2002) - FORD PUMA 1.7 16V (APOS 03-1997)
39x37x30mm	1f-d15mm	39x35x30mm	1f-d15mm
	<b>T1053F14</b> NO. 6154572 BATENTE DA BARRA ESTABILIZADORA FORD FIESTA		<b>T1111</b> NO. 1152852 - 2S615484DA - DD32-34-156 - 1334004 BATENTE DA BARRA ESTABILIZADORA DA FRENTE FORD FIESTA V (APÓS 11-01) - FUSION (APÓS 2002)
34x31x28mm	1f-d14mm	47x46x38mm	1f-d16.6mm
	<b>T1135</b> NO. 1528314 - 1514536 - 1514533 - 8V515484AB - 8V515484BA - 8V515484AA BATENTE DA BARRA ESTABILIZADORA DA FRENTE FORD FIESTA VI 1.25 Hatchback (APÓS 06.08) 60cv 1242cc - FORD FIESTA VI 1.25 Hatchback (APÓS 06.08) 82cv 1242cc - FORD FIESTA VI 1.4 Hatchback (APÓS 06.08) 97cv 1388cc - FORD FIESTA VI 1.4 LPG Hatchback (APÓS 01.09) 97cv 1388cc - FORD FIESTA VI 1.6 Ti Hat		<b>W5015</b> NO. 1319519 - 1369546 - 1473366 - 1485765 - 1517975 - 1517976 - 1147683 - 1369548 - 3M5Q6B319CC - 2S6QGB... POLIE DA CAMBOTA (6 pistas) FORD FIESTA V 1.4 TDCi (APÓS 11-2001) - 1.6 TDCi (APÓS 11-2004)
92x48x45mm	48x38x42mm 1f-d22mm 2f-d12mm	d152.8mm	d30mm
	<b>W5015</b> NO. 1319519 - 1369546 - 1473366 - 1485765 - 1517975 - 1517976 - 1147683 - 1369548 - 3M5Q6B319CC - 2S6QGB... POLIE DA CAMBOTA (6 pistas) FORD FUSION 1.4 TDCi (APÓS 08-2002) - 1.6 TDCi (APÓS 11-2004)		<b>W5025</b> NO. 1005817 POLIE DA CAMBOTA (5 pistas) FORD FIESTA 1.8D - COURIER 1996
d152.8mm	d30mm	d134.3mm	d42mm
	<b>W5026</b> NO. 1135052 POLIE DA CAMBOTA (6 pistas) FORD FIESTA 1.8D 1996		<b>W5035</b> NO. 1135052 POLIE DA CAMBOTA (6 PISTAS) FORD FIESTA III 1.6i 16V (1994 A 12-1995) - 1.8 16V - 1.8 XR2i 16V (02-1992 A 12-1995) - 1.8 16V - 1.8 XR2i 16V (02-1992 A 12-1995) - FIESTA IV 1.6i 16V (APÓS 1996) - FIESTA IV 1.8 16V (APÓS 1996)
d131.3mm	d28mm	d132mm	d28mm
	<b>W5120</b> NO. 1147683 - 1319519 - 1369546 - 1473366 - 1485765 - 1517975 - 1517976 - 2S606B319AD - 2S6QGB319AB - 2S... POLIE DA CAMBOTA (6 PISTAS) FORD - FIESTA V (JH_ - JD_) - 1.4 TDCi (11.01 - 06.08) 68cv 1399cc Hatchback - FORD - FIESTA V (JH_ - JD_) - 1.6 TDCi (11.04 - 06.08) 90cv 1560cc Hatchback - FORD - FIESTA V Van - 1.4 TDCi (10.03 - 12.10) 68cv 1399cc Caixa		<b>W5120</b> NO. 1147683 - 1319519 - 1369546 - 1473366 - 1485765 - 1517975 - 1517976 - 2S606B319AD - 2S6QGB319AB - 2S... POLIE DA CAMBOTA (6 PISTAS) FORD - FIESTA VI - 1.4 TDCi Ano fabric. até: (12.09) (APÓS 01.09) 68cv 1399cc Hatchback - FORD - FIESTA VI - 1.6 TDCi Ano fabric. até: (12.09) (APÓS 06.08) 75cv 1560cc Hatchback - FORD - FIESTA VI - 1.6 TDCi Ano fabric. até: (12.09) (APÓS 06.08) 90cv 156
d150/162mm	d29,5mm	d150/162mm	d29,5mm
	<b>W5120</b> NO. 1147683 - 1319519 - 1369546 - 1473366 - 1485765 - 1517975 - 1517976 - 2S606B319AD - 2S6QGB319AB - 2S... POLIE DA CAMBOTA (6 PISTAS) FORD - FUSION (JU_) - 1.4 TDCi Mod. t ipo: Fusion - ou: - Mod. t ipo: Ecosport (08.02 - 07.05) 68cv 1399cc Combi - FORD - FUSION (JU_) - 1.6 TDCi (11.04 - 12.12) 90cv 1560cc Combi		<b>W5135</b> NO. 6186295 POLIE DA CAMBOTA 4 PISTAS FORD FIESTA III (GFJ) 1.8 D (03.89 A 12.95) 60cv 1753cc Hatchback
d150/162mm	d29,5mm	d120/130mm	d20,6mm
	<b>Z80487</b> NO. 6040784 Mola de friso FORD FIESTA		<b>Z80553</b> NO. 1443038 Mola de painel FORD FIESTA
10x9.3x5mm	NULL	d14x13mm	1p-d8-11mm

	<p><b>Z80598</b> NO. 6725950</p> <p><i>Mola de painel</i></p> <p>FORD FIESTA (De 1989 A 1996)</p> <p>d18x18.5mm 1p-d9.5-16mm</p>		<p><b>Z80616</b> NO. 6099812</p> <p><i>Mola de painel</i></p> <p>FORD FIESTA</p> <p>d18x20.5mm 1p-d7.6-12mm</p>
	<p><b>Z80617</b> NO. 6117693</p> <p><i>Mola de painel</i></p> <p>FORD FIESTA</p> <p>d18x16.5mm 1p-d7.4-11mm</p>		<p><b>Z80623</b> NO.</p> <p><i>Mola de painel</i></p> <p>FORD FIESTA</p> <p>d25x30.6mm 1p-d12-14.5mm</p>
	<p><b>Z80647</b> NO. 14222380</p> <p><i>Mola de fixação</i></p> <p>FORD FIESTA (Após 1989)</p> <p>12.5x12.5x19.2mm 1p-9.5x9.5-18mm 1f-d4.8mm</p>		<p><b>Z80673</b> NO. 6142786</p> <p><i>Mola de painel</i></p> <p>FORD FIESTA (Após 1989)</p> <p>d25x17mm 1p-d12-15.5mm</p>
	<p><b>Z80687</b> NO. 6448410</p> <p><i>Mola de painel</i></p> <p>FORD PUMA (Após 1997)</p> <p>d25x14.5mm 1p-d9.3-12.5mm</p>		<p><b>Z80687</b> NO. 6448410</p> <p><i>Mola de painel</i></p> <p>FORD FIESTA (De 1989 A 1996)</p> <p>d25x14.5mm 1p-d9.3-12.5mm</p>
	<p><b>Z80697</b> NO. 1047847 - 1047848</p> <p><i>Mola de fixação</i></p> <p>FORD FIESTA (De 1989 A 1996)</p> <p>NULL NULL</p>		<p><b>Z80698</b> NO. 1051701</p> <p><i>Mola de fixação</i></p> <p>FORD FIESTA (Após 1996)</p> <p>d16.4x25mm 1p-d7-8.5mm</p>
	<p><b>Z80699</b> NO. 1007932</p> <p><i>Mola de fixação</i></p> <p>FORD FIESTA (Após 1996)</p> <p>d16x29mm 1p-d6.5-18mm</p>		<p><b>Z80700</b> NO. 6181023</p> <p><i>Mola de fixação</i></p> <p>FORD FIESTA (De 1989 A 1996)</p> <p>12.5x10x30mm 1p-10x8-15.5mm</p>
	<p><b>Z80704</b> NO. 6176723 - 500326189</p> <p><i>Mola de painel</i></p> <p>FORD PUMA</p> <p>d18x21mm 1p-d8.2-15mm</p>		<p><b>Z80704</b> NO. 6176723 - 500326189</p> <p><i>Mola de painel</i></p> <p>FORD FIESTA (De 1989 A 1996)</p> <p>d18x21mm 1p-d8.2-15mm</p>
	<p><b>Z80714</b> NO. A0069884378 - E865220S - 6177722</p> <p><i>Mola de painel</i></p> <p>FORD FIESTA (De 1989 A 1996)</p> <p>d18x18mm 1p-d9-12mm</p>		<p><b>Z80717</b> NO. 6150260</p> <p><i>Mola de fixação</i></p> <p>FORD PUMA</p> <p>d20x12.5mm 1p-8x11-10mm 1f-d5.5mm</p>

	<b>Z80717</b> NO. 6150260 <i>Mola de fixação</i> FORD FIESTA (De 1989 A 1996) d20x12.5mm 1p-8x11-10mm 1f-d5.5mm		<b>Z80718</b> NO. 6634877 <i>Mola de retenção</i> FORD FIESTA (Após 1989) d14x10mm 1f-d3.9mm
	<b>Z80787</b> NO. 1039463 - 8E0825267 <i>Mola de fixação</i> FORD FUSION d20x34mm 1p-d8.5-21mm		<b>Z80787</b> NO. 1039463 - 8E0825267 <i>Mola de fixação</i> FORD FIESTA d20x34mm 1p-d8.5-21mm
	<b>Z80845</b> NO. 1028521 - W701054S300 <i>Rebite</i> FORD FUSION d25x42.5mm 1p-d8-24.5mm		<b>Z80845</b> NO. 1028521 - W701054S300 <i>Rebite</i> FORD FIESTA (De 2002 A 2008) d25x42.5mm 1p-d8-24.5mm
	<b>Z9005</b> NO. 1640227 - 6156718 - 6688870 <i>MOLA DE ESCAPE</i> FORD FIESTA (1986 A 1995) d25x28mm NULL		<b>Z9009</b> NO. 6142854 - 6146512 <i>MOLA DE ESCAPE</i> FORD FIESTA (1984 A 1995) d14x69mm NULL

## FORD FOCUS

	<b>A1387</b> NO. 1070136 - 98AB8125EC - 1061194 <i>APOIO DO RADIADOR</i> FORD FOCUS d54x40mm d41mm d38mm 1f-d25mm 1f-d13mm		<b>A1569</b> NO. 1061722 - 1087177 - 98AG3K155AF - 98AG.3K155.AE - 98AG.3K155.AB - YS41.3K155.AB - 1106874 - 1480525 ... <i>APOIO SUPERIOR DO AMORTECEDOR DA FRENTE</i> FORD FOCUS 1.4 - 1.6 - 1.8 - 1.8TDDi - 2.0 APÓS 1998 - CONNECT APÓS 1998 110x110x30mm 3p-d8-23mm
	<b>A1589</b> NO. 1092270 - 1092271 - 1133019 - 1061131 - 1133020 - 1066070 - 98AB.7M121.NB - 1355149 - 1309644 <i>APOIO DO MOTOR LADO ESQUERDO CAIXA DE VELOCIDADES</i> FORD FOCUS (DAW - DBW) 1.4 16V - 1.6 16V - 1.8 16V 10-98 A 11-04 - 1.8 DI - 1.8 TDDi - 1.8 TDCi - 2.0 16V - RS - ST 170 10-98 A 11-04 FOCUS COMBI (DNW) 1.4 16V - 1.6 16V - 1.8 16V - 1.8 DI - 1.8 TDDi - 1.8 TDCi - 2.0 16V - RS - ST 170 02-99 A 11-04 FOCUS 165x130x65mm 1f-d15mm		<b>A1590</b> NO. 1139257 - 1072571 - 1105997 - 1061107 - 98AB.6038.CK - 98AB6038CH - 98AB6038CJ - 98AB6038CG - 110597... <i>APOIO DO MOTOR LADO DIREITO</i> FORD FOCUS (DAW - DBW) 1.4 16V - 1.6 16V 10-98 A 11-04 FOCUS COMBI (DNW) 1.4 16V - 1.6 16V 02-99 A 11-04 FOCUS TRÊS VOLUMES (DFW) 1.4 16V - 1.6 16V 02-99 A 11-04 138x107x92mm 1p-d12-31mm
	<b>A1680</b> NO. 1000941 - 1104173 - 1M516F012AD - 1M516F012BA - 1M51.6F012.BB - 1332880 - 5224617 - 1142702 - 110094... <i>APOIO DO MOTOR LADO DIREITO</i> FORD CONNECT FOCUS 1.8 TDCi (APÓS 2001) 235x130x120mm NULL		<b>A1690</b> NO. 1100941 - 1332880 - 5224617 - 1000941 - 1104173 - 1142702 - 1M51.6F012.AD - 1M51.6F012.BA - 1M51.6F0... <i>APOIO DO MOTOR PARTE DA FRENTE</i> FORD FOCUS 1.8 TDDi 145x120x77mm 1f-d10mm



	<p><b>A1780</b> NO. 1345657 - 1567937 - 3M51.6F012.BH - 31277669 - 3M516F012BG - 1437549 - 123092 - 1250618</p> <p><b>APOIO DO MOTOR FRENTE</b></p> <p>FORD FOCUS II 1.6 TDCi (G8DA - G8DB) 109CV (APÓS 11-2004) - 1.6 TDCi (G8DC - MTDA) 100CV (APÓS 11-2004) - 1.6 TDCi (HHDA - HHDB) 90CV (APÓS 01-2005)</p> <p>256x140x120mm 1f-d12mm 1f-d13mm 2f-18x20mm</p>		<p><b>A1780</b> NO. 1345657 - 1567937 - 3M51.6F012.BH - 31277669 - 3M516F012BG - 1437549 - 123092 - 1250618</p> <p><b>APOIO DO MOTOR FRENTE</b></p> <p>FORD FOCUS II STATION WAGON 1.6 TDCi (G8DA - G8DB) 109CV (APÓS 11-2004) - 1.6 TDCi (G8DC - MTDA) 100CV (APÓS 11-2004)</p> <p>256x140x120mm 1f-d12mm 1f-d13mm 2f-18x20mm</p>
	<p><b>A1780</b> NO. 1345657 - 1567937 - 3M51.6F012.BH - 31277669 - 3M516F012BG - 1437549 - 123092 - 1250618</p> <p><b>APOIO DO MOTOR FRENTE</b></p> <p>FORD FOCUS II TRE VOLUMI 1.6 TDCi (G8DA - G8DB) 109CV (APÓS 04-2005) - FOCUS II TRE VOLUMI 1.6 TDCi (HHDA - HHDB) 90CV (APÓS 04-2005)</p> <p>256x140x120mm 1f-d12mm 1f-d13mm 2f-18x20mm</p>		<p><b>A1784</b> NO. 1224049 - 1404996 - 1533046 - 1420044 - 1355357 - 1370874 - 3M516P082AF - AV616P082AB - 3M516P082AD ...</p> <p><b>APOIO DA CAIXA VELOCIDADES</b></p> <p>FORD FOCUS II 1.4 (HATCHBACK) 80CV 1388cc (APÓS 11-2004) - 1.6 (HATCHBACK) 100CV 1596cc (APÓS 11-2004) - 1.6 Ti (HATCHBACK) 115CV 1596cc (APÓS 11-2004) - 1.8 (HATCHBACK) 125CV 1798cc (APÓS 03-2006) - 1.8 Flexfuel (HATCHBACK) 125CV 1798cc (APÓS 01-2006) -</p> <p>160x1005x45mm 2f-d12mm 1f-M12</p>
	<p><b>A1822</b> NO. 1454284 - 1690298 - 1801350 - 3M517M121JC - AV617M121CB - 1377471 - 1377612 - 1320605 - ...</p> <p><b>APOIO DA CAIXA DE VELOCIDADES</b></p> <p>FORD FOCUS C-MAX 1.6 TDCi (02.05 - 03.07) 90cv 1560cc - FORD FOCUS C-MAX 1.6 TDCi (10.03 - 03.07) 109cv 1560cc - FORD FOCUS II (DA_) 1.6 TDCi (01.05 - 09.12) 90cv 1560cc - FORD FOCUS II (DA_) 1.6 TDCi Hatchback (11.04 - 09.12) 109cv 1560cc - FORD FOCUS II</p> <p>230x160x70mm 4f-16x19mm 1f-d15mm</p>		<p><b>A1827</b> NO. 1308719 - 1308718 - 1334230 - 1230960 - 1305954 - 1365854 - 1255747 - 1377471 - 1377612 - 1320605 - ...</p> <p><b>APOIO DO AMORTECEDOR DA FRENTE DIREITO E ESQUERDO</b></p> <p>FORD FOCUS C-MAX 1.6 (10.03 - 03.07) 100cv 1596cc Veículo multiuso - FORD FOCUS C-MAX 1.6 Ti (08.04 - 03.07) 115cv 1596cc Veículo multiuso - FORD FOCUS C-MAX 1.8 (10.03 - 03.07) 120cv 1798cc Veículo multiuso - FORD FOCUS C-MAX 1.8 (09.05 - 03.07) 122cv 17</p> <p>140x32mm 1f-d12mm 3r-d8mm</p>
	<p><b>A1827</b> NO. 1308719 - 1308718 - 1334230 - 1230960 - 1305954 - 1365854 - 1255747 - 1377471 - 1377612 - 1320605 - ...</p> <p><b>APOIO DO AMORTECEDOR DA FRENTE DIREITO E ESQUERDO</b></p> <p>FORD FOCUS II (DA_) 1.4 (07.04 - 09.12) 80cv 1388cc Hatchback - FORD FOCUS II (DA_) 1.6 Código do mot or: 1 - 6 PFI (07.04 - 09.12) 100cv 1596cc Hatchback - FORD FOCUS II (DA_) 1.6 Ti Código do mot or: 1 - 6 TI-VCT (07.04 - 09.12) 115cv 1596cc Hatchback - FOR</p> <p>140x32mm 1f-d12mm 3r-d8mm</p>		<p><b>A1924</b> NO. 1519590 - 1526663 - 1536951 - 1546649 - 1676770 - 1692614 - 1778550 - 8V516F012BB - 8V516F012BC - 8V...</p> <p><b>APOIO MOTOR LADO DIREITO</b></p> <p>FORD B-MAX (JK) 1.4 (a Partir de 10.12) 90cv 1388cc Veículo multiuso - FORD B-MAX (JK) 1.6 Ti (A Partir de 10.12) 105cv 1596cc Veículo multiuso</p> <p>190x170x130mm 3f-d18mm 3f-d12mm</p>
	<p><b>A1926</b> NO. 1112025 - YS416038BA - 98AB6038DG - 98AB6038DH - 1S416038BA - 1072572 - 1102456 - 11102572</p> <p><b>APOIO MOTOR LADO DIREITO</b></p> <p>FORD FOCUS (DAW_DBW) 1.6 16V (10.98 A 11.04) 100cv 1596cc Hatchback - FORD FOCUS (DAW, DBW) 1.8 16V Local de montagem: à frente (10.98 A 11.04) 115cv 1796cc Hatchback - FORD FOCUS (DAW, DBW) 2.0 16V (10.98 A 11.04) 131cv 1988cc Hatchback - FORD FOCUS (DAW, DBW) ST170 Local de montagem: à frente (03.02 A 11.04) 173cv 1988cc Hatchback - FORD FOCUS três volumes (DFW) 1.6 16V (02.99 A 11.04) 100cv 1596cc três volumes - FORD FOCUS três...etc.</p> <p>120x120x100mm 1p-d12x38mm</p>		<p><b>A1927</b> NO. 1322569 - 4M516P093FA</p> <p><b>APOIO CAIXA VELOCIDADES</b></p> <p>FORD FOCUS C-MAX 1.8 Ano fabric. a partir de: 05.04 10.03 - 03.07 88 120 1798 Veículo multiuso FORD FOCUS C-MAX 1.8 Ano fabric. a partir de: 05.04 04.04 - 03.07 92 125 1798 Veículo multiuso FORD FOCUS C-MAX 2.0 Ano fabric. a partir de: 05.04 03.04 - 03.07 107 145 1999 Veículo multiuso</p> <p>160x100x110mm 3f-d12mm 1f-d10mm</p>
	<p><b>A1927</b> NO. 1322569 - 4M516P093FA</p> <p><b>APOIO CAIXA VELOCIDADES</b></p> <p>FORD FOCUS II (DA_) 2.0 07.04 - 09.12 107 145 1999 Hatchback FORD FOCUS II três volumes (DA_) 2.0 04.05 - 07.11 107 145 1999 três volumes FORD FOCUS II Turnier (DA_) 2.0 07.04 - 09.12 107 145 1999 Combi</p> <p>160x100x110mm 3f-d12mm 1f-d10mm</p>		<p><b>C0231</b> NO. 6483712 - 91AB.16C618.AA</p> <p><b>BOTÃO DE AFINAÇÃO DE CAPOT</b></p> <p>FORD FOCUS (APÓS 1998)</p> <p>d27x44mm NULL</p>
	<p><b>E0086</b> NO. 1203093 - 2M515E494AA - 2M51.5E494.AB - 1487402 - 8M515E494AB - 1719542 - 1500682</p> <p><b>ESTICADOR DA BARRA ESTABILIZADORA</b></p> <p>FORD FOCUS (DAW - DBW) 1.4 16V - 1.6 16V - 1.8 16V - 1.8 Di - 1.8 TDDi - 1.8 TDCi - 2.0 16V - RS - ST 170 10-98 A11-04 - FOCUS COMBI (DNW) 1.4 16V - 1.6 16V - 1.8 16V - 1.8 Di - 1.8 TDDi - 2.0 16V 02-99 A 11-04 - FOCUS TRÊS VOLUMES (DFW) 1.4 16V - 1.6 16V</p> <p>d31x95mm 1p-d8-120mm</p>		<p><b>E0088</b> NO. 1209035 - 1107068 - 1111769 - YS413B438AB - 1061631 - 1135077 - 1471446 - 98AG3B438AD - YS413B438BB ...</p> <p><b>ESTICADOR DA BARRA ESTABILIZADORA</b></p> <p>FORD FOCUS (DAW - DBW) 1.4 16V - 1.6 16V - 1.8 16V - 1.8 Di - 1.8 TDDi - 1.8 TDCi - 2.0 16V - RS - ST 170 10-98 A11-04 - FOCUS COMBI (DNW) 1.4 16V - 1.6 16V 1.8 16V - 1.8 Di - 1.8 TDDi - 1.8 TDCi - 2.0 16V - ST 170 02-99 A 11-04 - FOCUS TRÊS VOLUMES (DFW)</p> <p>260x25x20mm 2p-d10-27mm</p>
	<p><b>E0101</b> NO. 1135077 - 1209035</p> <p><b>ESTICADOR DA BARRA ESTABILIZADORA DA FRENTE</b></p> <p>FORD FOCUS TT</p> <p>265x25x25mm 2p-d10-30mm</p>		<p><b>E0108</b> NO. 1203093 - 2M515E594AA - 2M51.5E494.AB - 98AG.5495.AB - 98AG.5495.AC - 1061703 - 1487402 - 1061702 ...</p> <p><b>ESTICADOR DA BARRA ESTABILIZADORA DE TRÁS</b></p> <p>FORD FOCUS TT</p> <p>d31x90mm 1p-d8-110mm</p>

	<p><b>E1015</b> NO. 4420546 - 2T145C486AD - 1332463</p> <p>ESTICADOR DA BARRA ESTABILIZADORA DE TRÁS</p> <p>FORD CONNECT</p> <p>170x40x40mm 2p-d12-26mm</p>		<p><b>E1015</b> NO. 4367012 - 2T143B438BA - 1332453 - 2T14.3B438.BB</p> <p>ESTICADOR DA BARRA ESTABILIZADORA DA FRENTE</p> <p>FORD CONNECT</p> <p>270x32x37mm 2p-d10-24mm</p>
	<p><b>E1017</b> NO. 1223792 - 1230909 - 3M513B438AB - 3M51.3B438.AC - 1762149 - 1851900 - 1686594 - AV61.3B438.AA</p> <p>ESTICADOR DA BARRA ESTABILIZADORA DA FRENTE</p> <p>FORD FOCUS C-MAX TT - FOCUS II TT</p> <p>325x30x35mm 2p-d10-22mm</p>		<p><b>E1019</b> NO. 1469208 - 1310333 - 3M515C486BE - 3M515C486BC - 3M51.5C486.BF - 3M15.5C486.BD - 1734686 - 1335548 - ...</p> <p>ESTICADOR DA BARRA ESTABILIZADORA DE TRÁS</p> <p>FORD FOCUS MKII (07-2004 A 12-2007) - FOCUS MKIII (APÓS 12-2007) - FOCUS C-MAX (06-2003 A 01-2008) - C-MAX</p> <p>90x50x40mm 1p-d10-287mm 1p-d10-22mm</p>
	<p><b>E1021-M</b> NO. 1061205 - 1094591 - 98AB.6P082.AH - 9T16.6P082.BB - 1102416 - 1070177</p> <p>ESTICADOR DO MOTOR PARTE TRÁS</p> <p>FORD FOCUS 1.4 - 1.6 - 1.8 - 1.8 TDDi (APÓS 1998)</p> <p>160x85x45mm NULL</p>		<p><b>E1025</b> NO. 1061668 - 1105524 - 98AG.5K743.AF - 1231455 - 1253735</p> <p>ESTICADOR DA SUSPENSÃO DE TRÁS</p> <p>FORD FOCUS (DAW-DBW) 1.4 16V - 1.6 16V - 1.8 16V - 1.8 Di - TDDi - 1.8 TDCi - TURBO Di - TDDi - 2.0 16V - RS - ST 170 10-98 A11-04 - FOCUS C-MAX 1.6 APÓS 10-03 - C-MAX 1.6 TDCi - 1.8 - 2.0 TDCi APÓS 10-03 - C-MAX 1.6 Ti APÓS 08-04 - C-MAX 2.0 APÓS 04-04 -</p> <p>280x58x35mm 2d-32mm 2f-11.2mm</p>
	<p><b>E1069</b> NO.</p> <p>ESTICADOR DE ESCAPE</p> <p>FORD FOCUS (APÓS 1998)</p> <p>75x50x34mm NULL</p>		<p><b>E1087</b> NO. 1022729</p> <p>ESTICADOR DO ESCAPE</p> <p>FORD FOCUS (1998)</p> <p>70x50x25mm NULL</p>
	<p><b>F1662-I</b> NO. 1061879 - 1061881 - 1117223 - 1119227 - 1349166 - XS4J.4A084.BB</p> <p>FOLE DA TRANSMISSÃO LADO DA CAIXA</p> <p>FORD FOCUS 1.4i - 1.6i - 1.8i - 1.8 TDCi - 1.8 TDDi - 2.0i (1998 A 2004)</p> <p>d78x85mm 1f-d70mm 1f-d28mm</p>		<p><b>F1663-I</b> NO. 1061881 - 1061879 - 1349166 - 1119227 - 1117223 - XS4J.4A084.BB - XS4C3L537A1A - 1117220</p> <p>FOLE TRANSMISSÃO LADO DA CAIXA</p> <p>FORD FOCUS 1.8 - 1.8 TD - 2.0 (APÓS 1998)</p> <p>d86x88mm 1f-d77mm 1f-d28mm</p>
	<p><b>F1664-I</b> NO. 102321 - 1061867 - 1073947 - XS4C3A331B1A - 1061864</p> <p>FOLE DA TRANSMISSÃO LADO DA RODA</p> <p>FORD FOCUS 1.4i - 1.6i - 1.8i - 1.8 TDDi 2.0i (1998 A 2004)</p> <p>d96x102mm 1f-d78mm 1f-d28mm</p>		<p><b>F1716-I</b> NO. 6182818 - 1085517 - 3043575 - 87BB3K661AA</p> <p>FOLE DA DIRECÇÃO ASSISTIDA DIREITO E ESQUERDO</p> <p>FORD FOCUS (APÓS 1998) 1.4 - 1.6 - 1.8 - 1.8 TDDi - 2.0</p> <p>d61x190mm 1f-d46mm 1f-d13mm</p>
	<p><b>F1821-I</b> NO. 1061879 - 1119227 - XS4J4A084DA - XS4J.4A084.BB - 1349166 - 1061881 - 1117223 - XS4C3L537A1A - 11172...</p> <p>FOLE DA TRANSMISSÃO JUNTO À CAIXA</p> <p>FORD FOCUS I 1.4i 16V - 1.6i 16V - 1.8TDCi - 1.8TDDi - 1.8i 16V - 2.0i 16V (98 A 04)</p> <p>d77x85mm 1f-d72mm 1f-d28mm</p>		<p><b>F4037</b> NO. 4059921 - YC153K661AA</p> <p>FOLE DA DIRECÇÃO LADO DIREITO E ESQUERDO</p> <p>FORD FOCUS APÓS 1998 - 1.4 - 1.6 - 1.8 - 1.8 TDDi - 2.0</p> <p>d72/54x240mm 1f-d68mm 1f-d10mm</p>
	<p><b>F4038</b> NO. 1061720 - 98AG3K036AB</p> <p>FOLE DOS AMORTECEDORES DA FRENTE</p> <p>FORD FOCUS APÓS 1998 - 1.4 - 1.6 - 1.8 - 1.8 TDDi - 2.0</p> <p>d90/65x180mm 1f-d61mm 1f-d21mm</p>		<p><b>KF1607</b> NO. 1329826 - 3M514A084-MA</p> <p>KIT DE FOLE DO CARDAN JUNTO À RODA</p> <p>FORD FOCUS 1.6 TDCi - 1.8i - 2.0i (APÓS 2004) - FOCUS C-MAX 1.6 TDCi - 1.8i (APÓS 2003)</p> <p>d90x90mm 1f-d78mm 1f-d21mm</p>

	<p><b>KF1685-T</b> NO. 3M514C062BA KIT DE FOLE DO CARDAN JUNTO À RODA FORD FOCUS II (APÓS 2004) 1.6i</p>		<p><b>KF2271-T</b> NO. 2M5V4A084-AA - 4371803 - 4511120 - 2T14.4A084.CA KIT DE FOLE DO CARDAN JUNTO À RODA FORD FOCUS I 2.0i ST170 (1998 A 2004) - TRANSIT CONNECT 1.8 Di (APÓS 2002)</p>
	<p><b>KF9004</b> NO. 1117223 - XS4J4A084BA - XS4J.4A084.BB - 1061879 - 1349166 - 1119227 - 1061881 - XS4C3L537A1A - 11172... KIT DE FOLE DO CARDAN LADO DA CAIXA FORD FOCUS APÓS 1998</p>		<p><b>KF9005</b> NO. XS4J4A084DA - 1349165 KIT DE FOLE DO CARDAN LADO DA RODA FORD FOCUS (APÓS 1998)</p>
	<p><b>KF9006</b> NO. 1113729 - XS414A084HA - XS41.4A084.HB - 1063498 - 1152464 - XS4C.3B413.BA KIT DE FOLE DO CARDAN LADO DA RODA FORD FOCUS (APÓS 1998)</p>		<p><b>KF9018</b> NO. 7M514C062EA KIT DE FOLE DO CARDAN LADO DA RODA FORD FOCUS (APÓS 2007)</p>
	<p><b>KF9019</b> NO. 1501167 - 7M514C062AA KIT DE FOLE DO CARDAN LADO DA RODA FORD FOCUS II (DA_) 2.0 TDCi Hatchback(02.08 - 07.11) 110cv 1997cc - FORD FOCUS II (DA_) 2.0 TDCi Hatchback (11.04 - 01.08) 133cv 1997cc - FORD FOCUS II (DA_) 2.0 TDCi Hatchback (11.04 - 09.12) 136cv 1997cc - FORD FOCUS II Combi (DA_) 2.0 TDCi (02.08 - 07</p>		<p><b>L3080</b> NO. 11503258 - 1M5Q5776AA - 98AG.5776.AB - YS4Z.5495.AA - 1061703 - 1150358 CASQUILHO DA BARRA ESTABILIZADORA DE TRÁS FORD FOCUS APÓS 1998</p>
	<p><b>P1048</b> NO. 6789917 - 1076899 - 1029040 - 98AB.7A624.AA - 97KB.2457.AB - 94BB.7A624.AA - 94BB7A642AA CAPA DE PEDAL DO TRAVÃO E EMBRAIAGEM FORD FOCUS 1.4 - 1.6 - 1.8 - 1.8 TDDi - 2.0 (1998 A 2004)+F377</p>		<p><b>R221362</b> NO. 1061215 - 1085687 - 98AB8B273EF - 1134580 - 98AB8B273EE - 98AB8B273EG TUBO INFERIOR DO RADIADOR FORD FOCUS 1.4 - 1.6 (1998 A 2004)</p>
	<p><b>R222414</b> NO. 1061214 - 1134579 - 1311177 - 98AB8B273DG - 98AB8B273DH TUBO INFERIOR DO RADIADOR FORD FOCUS 1.8 TDDi (1999 A 2004)</p>		<p><b>R222415</b> NO. 1061209 - 1072458 - 98AB8B273AF TUBO INFERIOR DO RADIADOR FORD FOCUS 1.4 COM A-C - 1.6 COM A-C (1998 A 2004)</p>
	<p><b>R222425</b> NO. 1061220 - 1134058 - 98AB8B274DG TUBO SUPERIOR DO RADIADOR FORD FOCUS 1.8 TDDi (1999 A 2004)</p>		<p><b>R222426</b> NO. 1076923 - 1096829 - 1134581 - 98AB8B274AH - 98AB8B274AJ TUBO SUPERIOR DO RADIADOR FORD FOCUS 1.4 16V (MOTOR FXDA - FXDD - FXDB - FXDC) (1998 A 2004) 1.6 16V (MOTOR FYDD - FYDC - FYDA - FYDB) (1998 A 2004)</p>
	<p><b>R224130</b> NO. 1673571 - 7M519A673EJ - 1448610 - 1475090 - 1485712 - 1486600 - 1493258 - 1511205 - 1543828 - 160748... TUBO DO FILTRO DE AR (ADMISSÃO) FORD FOCUS C-MAX - 1.6 TDCi 109CV (10-2003 A 03-2007)</p>		<p><b>R224130</b> NO. 1673571 - 7M519A673EJ - 1448610 - 1475090 - 1485712 - 1486600 - 1493258 - 1511205 - 1543828 - 160748... TUBO DO FILTRO DE AR (ADMISSÃO) FORD FOCUS II 1.6 TDCi 100CV (APÓS 11-2004) - FOCUS II 109CV (APÓS 11-2004)</p>



	<p><b>R224131</b> NO. 1336611 - 3M519A673MG - 1233195 - 1300470 - 1324641 - 1324908 - 3M519A673MC - 3M519A673MD - 3M519A673</p> <p>TUBO DE ADMISSÃO DO FILTRO DE AR</p> <p>FORD FOCUS C MAX 1.6 TDCI (10-2003 A 03-2007) 109CV 1560CC - FORD FOCUS II (DA) 1.6 TDCI (APÓS 11-2004) 100CV 1560CC - FORD FOCUS II (DA) 1.6 TDCI (APÓS 11-2004) 109CV 1560CC</p>		<p><b>R8118</b> NO. T136082 - 5T166N650AB - 2T1Q.6N650.AB - 3S4Q.6N650.AB - 5T16.6N650.BA - 1229499 - 1201165 - 1417829 ...</p> <p>TUBO DO FILTRO DE AR</p> <p>FORD CONNECT (APÓS 2002)</p>
	<p><b>RT08608</b> NO. 1068964</p> <p>TUBO DE TRAVÃO FRENTE LH-RH</p> <p>FORD FOCUS TT (APÓS 10-1998)</p>		<p><b>RT08609</b> NO. 1064257</p> <p>TUBO DE TRAVÃO TRÁS LH-RH</p> <p>FORD FOCUS TT (APÓS 10-1998)</p>
	<p><b>RT08923</b> NO. 1068975</p> <p>TUBO DE TRAVÃO TRÁS LH-RH</p> <p>FORD FOCUS TT APÓS 10-1998</p>		<p><b>RT08246</b> NO. 1361292 - 1328519 - 1405497</p> <p>TUBO DE TRAVÃO TRÁS LH-RH (COM TRAVÃO DE MÃO ELECTRICO)</p> <p>FORD FOCUS C-MAX TT (01-2004 A 03-2007)</p>
	<p><b>RT80246</b> NO. 1361292 - 1328519 - 1405497</p> <p>TUBO DE TRAVÃO TRÁS LH-RH (COM TRAVÃO DE MÃO ELECTRICO)</p> <p>FORD FOCUS II TT (APÓS 01-2004)</p>		<p><b>RT80267</b> NO. 1124059 - 1148270</p> <p>TUBO DE TRAVÃO TRÁS LH-RH</p> <p>FORD FOCUS TT (APÓS 09-2000)</p>
	<p><b>RT80306</b> NO. 1405494</p> <p>TUBO DE TRAVÃO TRÁS LH-RH</p> <p>FORD FOCUS C-MAX TT (11-2004 A 03-2007)</p>		<p><b>RT80306</b> NO. 1405494</p> <p>TUBO DE TRAVÃO TRÁS LH-RH</p> <p>FORD FOCUS II TT (APÓS 11-2004)</p>
	<p><b>RT80321</b> NO. 1309224 - 1387272</p> <p>TUBO DE TRAVÃO TRÁS LH-RH</p> <p>FORD FIESTA FURGONATO 1.3 (09-1991 A 02-1996) - FURGONATO 1.8 D (03-1989 A 02-1996) - FIESTA III 1.0 (03-1989 A 12-1995) - FIESTA III 1.1 (03-1989 A 12-1995) - FIESTA III 1.3 (03-1989 A 12-1992) - FIESTA III 1.3 CAT.(05-1991 A 01-1997)</p>		<p><b>RT80321</b> NO. 1309224 - 1387272</p> <p>TUBO DE TRAVÃO TRÁS LH-RH</p> <p>FORD FOCUS C-MAX 1.6 (10-2003 A 03-2007) - 1.6 TDCi (10-2003 A 03-2007) - 1.6 Ti (08-2004 A 03-2007) - 1.8 (10-2003 A 03-2007) - 2.0 (04-2004 A 03-2007) - 2.0 TDCi (10-2003 A 03-2007)</p>
	<p><b>RT80388</b> NO. 1387264</p> <p>TUBO DE TRAVÃO FRENTE LH-RH</p> <p>FORD FOCUS C-MAX TT (10-2003 A 03-2007)</p>		<p><b>RT80388</b> NO. 1387264</p> <p>TUBO DE TRAVÃO FRENTE LH-RH</p> <p>FORD FOCUS II TT (APÓS 06-2003)</p>
	<p><b>RT80450</b> NO. 1379911 - 1671020</p> <p>TUBO DE TRAVÃO FRENTE LH-RH</p> <p>FORD FOCUS II 1.4 (APÓS 11-2004) - 1.6 (APÓS 11-2004) - 1.6 TDCi (APÓS 11-2004) - 1.6 Ti (APÓS 11-2004) - 2.0 (APÓS 11-2004) - 2.0 TDCi (APÓS 11-2004) - FOCUS II TRE VOLUMI 1.8 FLUXIFUEL (APÓS 06-2006) - FOCUS II TURNIER 1.4 (APÓS 11-2004) - 1.6 (APÓS 11-2004)</p>		<p><b>S1261</b> NO. 1061570 - 98AG3063AE</p> <p>SILENT-BLOC DO BRAÇO DA SUSPENSÃO DA FRENTE CENTRO</p> <p>FORD FOCUS 1.4 16V - 1.6 16V - 1.8 16V - 1.8 TDDi - 1.8 TDCi - 2.0 16V (1998 A 2004)</p>

	<p><b>S1262</b> NO. 1067918 - 98AG 3A262AG - 2T14.3A262.AA - T123256 - 98AG.3A262.AG - 98AG3A262AGAH - 1097918 - 1090730...</p> <p>SILENT-BLOC DO BRAÇO DA SUSPENSÃO FRENTE (PONTAS) FORD FOCUS 1.4 16V - 1.6 16V - 1.8 16V - 1.8 TDDi - 1.8 TDCi - 2.0 16V (1998 A 2004)</p> <p>155x75x65mm 1f-d22mm</p>		<p><b>S1376</b> NO. 1061670 - 98AG.5K896.AB - C2Y6-28-46X</p> <p>SILENT-BLOC DA SUSPENSÃO DE TRÁS</p> <p>FORD FOCUS (DAW - DBW) 1.4 16V - 1.6 16V - 1.8 16V - 1.8 Di - 1.8 TDDi - 1.8 TDCi - 1.8 TURBO Di - 2.0 16V - RS - ST 170 10-98 A 11-04 - FOCUS C-MAX 1.6 - 1.6 TDCi - 1.6 Ti - 1.8 - 1.8 TDCi - 2.0 - 2.0TDCi APÓS 10-03 - FOCUS COMBI (DNW) 02-99 A 11-04 - FO</p> <p>d60x140mm NULL</p>
	<p><b>S1443</b> NO. 98AG5K792AA</p> <p>SILENT-BLOC DO BRAÇO DA SUSPENSÃO DE TRÁS PARTE DA FRENTE FORD FOCUS (APÓS 1998)</p> <p>d36.4x45mm c35mm 1f-12.2mm</p>		<p><b>S1444</b> NO. 98AG5K790AA</p> <p>SILENT-BLOC DO BRAÇO DA SUSPENSÃO DE TRÁS PARTE DE TRÁS FORD FOCUS (APÓS 1998)</p> <p>d32.6x55mm c45mm 1f-d12.2mm</p>
	<p><b>S1448</b> NO. 2M513A262AD - 2M51.3A262.CA</p> <p>SILENT-BLOC DO BRAÇO DA SUSPENSÃO DA FRENTE PARTE EXTERNA FORD FOCUS (APÓS 2001)</p> <p>160x75x80mm 1f-d21.6mm</p>		<p><b>S1505</b> NO. 1570748 - 1570750 - 1723324 - 1723323 - 1420795 - 1420858 - 1234375 - 1234371 - 1355151 - 1355149 - ...</p> <p>SILENT BLOC DO BRAÇO DA SUSPENSÃO DA FRENTE</p> <p>FORD - FOCUS C-MAX - 1.6 Veículo multiuso 100CV 1596cc (10-2003 A 03-2007) - 1.6 Ti Veículo multiuso 115CV 1596cc (08-2004 A 03-2007) - 1.8 Veículo multiuso 120CV 1798cc (10-2003 A 03-2007) - 1.8 Veículo multiuso 125CV 1798cc (04-2004 A 03-2007) - 1.8 Fle</p> <p>d45x65mm d40.5mm 1f-d14mm</p>
	<p><b>S1505</b> NO. 1570748 - 1570750 - 1723324 - 1723323 - 1420795 - 1420858 - 1234375 - 1234371 - 1355151 - 1355149 - ...</p> <p>SILENT BLOC DO BRAÇO DA SUSPENSÃO DA FRENTE</p> <p>FORD - FOCUS II (DA_) - 1.4 Hatchback 80CV 1388cc (APÓS 11-2004) - 1.6 Hatchback 100CV 1596cc (APÓS 11-2004) - 1.6 Ti Hatchback 115CV 1596cc (APÓS 11-2004) - 1.6 LPG Hatchback 115CV 1596cc (APÓS 10-2009) - 1.8 Hatchback 125CV 1798cc (APÓS 03-2006) - 1.8 F</p> <p>d45x65mm d40.5mm 1f-d14mm</p>		<p><b>S1506</b> NO. 1477858 - 1477858S1 - 4M51.3A262.AA</p> <p>SILENT BLOC DO BRAÇO SUSPENSÃO FRENTE PARTE DE TRÁS</p> <p>FORD FOCUS II (DA_) 1.4 (ASDA - ASDB) 80CV (APÓS 11-2004) - 1.6 (HWDA - HWDB) 100CV (APÓS 11-2004) - 1.6 LPG (SIDA)115CV (APÓS 10-2009) - 1.6 TDCi (G8DA - G8DB) 109CV (APÓS 11-2004) - 1.6 TDCi (HHDA - HHDB) 90CV (APÓS 01-2005) - 1.6 Ti (HXDA) 115CV (APÓS 11-2004)</p> <p>123x82x93mm 1f-d21.7mm 2f-d13mm 2r-d12mm</p>
	<p><b>T0610-I</b> NO. 1064069 - 98AG3025AD</p> <p>BATENTE DA SUSPENSÃO DA FRENTE FORD FOCUS (98 A 2004)</p> <p>d50x55mm 1f-d21/17mm</p>		<p><b>T1042</b> NO. 1073249 - 98AG4A037BA - 1067976</p> <p>BATENTE DA BARRA ESTABILIZADORA (CENTRO DE TRÁS) FORD FOCUS (1998 A 2004)</p> <p>45x46x32mm 1f-d20mm</p>
	<p><b>T1075</b> NO. 1073217 - 1061626 - 98AG5484DA</p> <p>BATENTE DA BARRA ESTABILIZADORA DA FRENTE FORD FOCUS (1998 A 2004)</p> <p>48x48x39mm 1f-d18-19mm</p>		<p><b>T1128</b> NO. 1305960 - 3M51.5484.CA - 30666266</p> <p>BATENTE DA BARRA ESTABILIZADORA DA FRENTE</p> <p>FORD FOCUS C-MAX 1.6 (HWDA - HWDB) 100CV (10-2003 A 03-2007) - 1.6 TDCi (G8DA - G8DB) 109CV (10-2003 A 03-2007) - 1.6 TDCi (HHDA - HHDB) 90CV (02-2005 A 03-2007) - 1.6 Ti (HXDA - SIDA) 115CV (08-2004 A 03-2007) - 1.8 (CSDA - CSDB) 120CV (10-2003 A 03-2007) - 1.8 (</p> <p>47x47x48mm 1f-d18mm</p>
	<p><b>W5015</b> NO. 1319519 - 1369546 - 1473366 - 1485765 - 1517975 - 1517976 - 1147683 - 1369548 - 3M50Q6B319CC - 2S6QG8...</p> <p>POLIE DA CAMBOTA (6 pistas)</p> <p>FORD FOCUS C-MAX 1.6 TDCi (10-2003 A 03-2007) - FOCUS 1.6 Ti - 1.6 TDCi (APÓS 11-2004)</p> <p>d152.8mm d30mm</p>		<p><b>W5035</b> NO. 1135052</p> <p>POLIE DA CAMBOTA (6 PISTAS)</p> <p>FORD FOCUS 1.8 16V - 2.0 16V</p> <p>d132mm d28mm</p>
	<p><b>W5055</b> NO. 1079188 - 1100051 - XS4Q6B319FC - XS4Q6B319FD - 1S4Q6A345M - XS4Q6A345AC - XS4Q6A345AD</p> <p>POLIE DA CAMBOTA (6 PISTAS)</p> <p>FORD FOCUS 1.8 Di (08-1999 A 11-2004 - Mtr BHDA - BHDB (75CV) - FOCUS 1.8 TDDi (10-1998 A 11-2004 - Mtr C9DA - DB - DC (90CV)</p> <p>d140/145mm d14mm</p>		<p><b>W5081</b> NO. 1151392 - 1143413 - 1S4Q6B319AE - 1S4Q6B319AF - 1S4Q6B318AE - 1S4Q6A345AA - XS4Q6A345AC - XS4Q6A345AD</p> <p>POLIE DA CAMBOTA (6 PISTAS)</p> <p>FORD FOCUS 1.8 TDCi (APÓS 03-2001) - Mtr FFDA - F9DB - F9DA (110-115CV)</p> <p>d140/153mm d14.6mm</p>

# FORD FOCUS

	<p><b>W5081</b> NO. 1151392 - 1143413 - 1S4Q6B319AE - 1S4Q6B319AF - 1S4Q6B318AE - 1S4Q6A345AA - XS4Q6A345AC - XS4Q6A345...</p> <p><i>POLIE DA CAMBOTA (6 PISTAS)</i></p> <p>FORD FOCUS 1.8 TDCi (APÓS 03-2001) - Mtr FFDA - F9DB - F9DA (110-115CV) - TRANSIT CONNECT 1.8 TDCi (APÓS 06-2002) - Mtr HCPA (90CV)</p> <p>d140/153mm d14.6mm</p>		<p><b>W5085</b> NO. 1232958</p> <p><i>POLIE DA CAMBOTA (6 PISTAS)</i></p> <p>FORD FOCUS CAX 2.0 TDCi (136CV) (APÓS 10-2004) - FOCUS II 2.0 TDCi (136CV) (APÓS 06-2006)</p> <p>d153/158mm d16mm</p>
	<p><b>W5085</b> NO. 1232958</p> <p><i>POLIE DA CAMBOTA (6 PISTAS)</i></p> <p>FORD FOCUS C-MAX 2.0 TDCi (136CV) (APÓS 10-2004) - FOCUS II 2.0 TDCi (136CV) (APÓS 06-2006)</p> <p>d153/158mm d16mm</p>		<p><b>W5120</b> NO. 1147683 - 1319519 - 1369546 - 1473366 - 1485765 - 1517975 - 1517976 - 2S606B319AD - 2S60GB319AB - 2S...</p> <p><i>POLIE DA CAMBOTA (6 PISTAS)</i></p> <p>FORD - FOCUS C-MAX - 1.6 TDCi (02.05 - 03.07) 90cv 1560cc Veículo multiuso - FORD - FOCUS C-MAX - 1.6 TDCi (10.03 - 03.07) 109cv 1560cc Veículo multiuso - FORD - FOCUS II (DA_) - 1.6 TDCi Ano fabric. até: (12.09) (01.05 - 09.12) 90cv 1560cc Hatchback -</p> <p>d150/162mm d29.5mm</p>
	<p><b>W5120</b> NO. 1147683 - 1319519 - 1369546 - 1473366 - 1485765 - 1517975 - 1517976 - 2S606B319AD - 2S60GB319AB - 2S...</p> <p><i>POLIE DA CAMBOTA (6 PISTAS)</i></p> <p>FORD - FOCUS II (DA_) - 1.6 TDCi Ano fabric. até: (12.09) (01.05 - 09.12) 90cv 1560cc Hatchback - FORD - FOCUS II (DA_) - 1.6 TDCi Ano fabric. até: (12.09) (11.04 - 09.12) 100cv 1560cc Hatchback - FORD - FOCUS II (DA_) - 1.6 TDCi Ano fabric. até: (12.09)</p> <p>d150/162mm d29.5mm</p>		<p><b>Z80696</b> NO. 6758612</p> <p><i>Mola de fixação</i></p> <p>FORD FOCUS</p> <p>d20.4x27mm 1p-d9-9mm</p>
	<p><b>Z80706</b> NO. 1070107</p> <p><i>Mola de painel</i></p> <p>FORD FOCUS</p> <p>d18x25.4mm 1p-d8.5-15.9mm</p>		<p><b>Z80750</b> NO. 51471904317 - N90201601H - 2207713 - 6998849</p> <p><i>Mola de painel</i></p> <p>FORD FOCUS (De 1998 A 2005)</p> <p>d20x23mm 1p-d9-20mm</p>
	<p><b>Z80845</b> NO. 1028521 - W701054S300</p> <p><i>Rebite</i></p> <p>FORD FOCUS (De 2002 A 2005)</p> <p>d25x42.5mm 1p-d8-24.5mm</p>		<p><b>Z80848</b> NO. 1257376</p> <p><i>Mola de painel</i></p> <p>FORD FOCUS (Após 2004)</p> <p>d18x27.5mm 1p-d8.5-10.5mm</p>

# FORD GALAXY

	<p><b>A1640</b> NO. 7403748 - 95VW5K818BC</p> <p><i>APOIO DO AMORTECEDOR DE TRÁS PARTE SUPERIOR</i></p> <p>FORD GALAXY 1.9 TDi - 2.0 - 2.3 - 2.8</p> <p>170x85x65mm 1r-d16mm 1f-d17mm</p>		<p><b>A1937-C</b> NO. 1J0412249 - 1J0412331 - 1J0412331B - 1J0412331BS</p> <p><i>APOIO DO AMORTECEDOR</i></p> <p>FORD GALAXY (WGR) 2.0 i Posição/grau: 1 ° (11.95 A 05.08) 116cv 1998cc Veículo multiuso - FORD GALAXY (WGR) 2.3 16V Posição/grau: 1 ° (09.01 A 05.06) 140cv 2295cc Veículo multiuso - FORD GALAXY (WGR) 2.3 16V Posição/grau: 1 ° (01.97 A 05.06) 146cv 2295cc Veículo multiuso - FORD GALAXY (WGR) 2.8 i V6 Posição/grau: 1 ° (11.95 A 04.00) 174cv 2792cc Veículo multiuso - FORD GALAXY (WGR) 2.8 i V6 4x4 Posição/grau: 1 ° (04.96 A ...etc.</p> <p>d82x55mm 1f-d14mm</p>
	<p><b>E0107</b> NO. 1009591 - 1141774 - 1232756 - 95VW5489AC</p> <p><i>ESTICADOR DA BARRA ESTABILIZADORA DA FRENTE</i></p> <p>FORD GALAXY TT (APÓS 03-195)</p> <p>245x35x35mm 2p-d12-25mm</p>		<p><b>E0259</b> NO. 1377416 - 1425853 - 6G915C486XAB - 6G915C486XAA</p> <p><i>ESTICADOR DA BARRA ESTABILIZADORA DE TRÁS</i></p> <p>FORD - GALAXY (WA6) 2.0 PFI (05.06 - 06.15) 145cv 1999cc - FORD - GALAXY (WA6) 2.0 EcoBoost (03.10 - 06.15) 203cv 1999cc - FORD - GALAXY (WA6) 2.3 (09.07 - 06.15) 160cv 2261cc - FORD - GALAXY (WA6) 1.8 TDCi (05.06 - 06.15) 100cv 1753cc - FORD - GALAXY (WA</p> <p>200x36x36mm 1p-d10x20mm 1p-d8x22mm</p>

	<p><b>E260</b> NO. 1377849 - 6G9N3B438BA - 30648461</p> <p>ESTICADOR DA BARRA ESTABILIZADORA DA FRENTE</p> <p>FORD - GALAXY (WA6) - 2.0 (05.06 - 06.15) 145cv 1999cc - FORD - GALAXY (WA6) - 2.0 EcoBoost (03.10 - 06.15) 203cv 1999cc - FORD - GALAXY (WA6) - 1.8 TDCi (05.06 - 06.15) 100cc 1753cv - FORD - GALAXY (WA6) - 1.8 TDCi (05.06 - 06.15) 125cv 1753cc - FORD - G</p> <p>330x36x36mm 2p-d10x25mm</p>		<p><b>F1669-I</b> NO. 7398680</p> <p>FOLE DA DIRECÇÃO ASSISTIDA LADO DIREITO E ESQUERDO</p> <p>FORD GALAXY TT (APÓS 03-1995)</p> <p>d77x180mm 1f-d50mm 1f-d10mm</p>
	<p><b>F1825-I</b> NO. 1008225 - 1008228</p> <p>FOLE DA TRANSMISSÃO JUNTO À CAIXA</p> <p>FORD GALAXY 1.9 TDi - 1.9 TDi PD - 2.0i - 2.3i 16V - 2.8i VR6 (APÓS 1995)</p> <p>d95x120mm 1f-d80mm 1f-d23mm</p>		<p><b>F9039H-I</b> NO. 1446300</p> <p>FOLE DO CARDAN LADO DA RODA</p> <p>FORD GALAXY 1.8 TDCi (FFWA) 0100CV (APÓS 05-2006) - 1.8 TDCi (QYWA) 125CV (APÓS 05-2006) - 2.0 (AOWA - AOWB) 145CV (APÓS 05-2006) - 2.0 EcoBoost (TNWA) 203CV (APÓS 03-2010) - 2.0 Flexifuel (TBWA - TBWB) 145CV (APÓS 05-2006) - 2.0 TDCi (AZWA) 130CV (APÓS 05-2006)</p> <p>d96x130mm 1f-d29mm 1f-d94mm</p>
	<p><b>KF1473-T</b> NO.</p> <p>KIT DE FOLE DO CARDAN JUNTO À RODA</p> <p>FORD GALAXY 1.9 TDi - 2.0i - 2.3i 16V - 2.8i VR6 - 2.8i VR6 4X4 (APÓS 1995)</p> <p>d110x150mm 1f-d98mm 1f-d29mm</p>		<p><b>KF2539-T</b> NO. 1075638 - 95VW7L606AB</p> <p>KIT DE FOLE DO CARDAN JUNTO À RODA</p> <p>FORD GALAXY 1.9 TDi - 1.9 TDi PD - 2.0i - 2.3i 16V - 2.8i VR6 (APÓS 1995)</p> <p>d110x150mm 1f-d98mm 1f-d30mm</p>
	<p><b>KF8020-T</b> NO.</p> <p>KIT DE FOLE DO CARDAN JUNTO À RODA</p> <p>FORD GALAXY 1.9 TDi - 2.0i - 2.3i 16V - 2.8i VR6 - 2.8i VR6 4X4 (APÓS 1995)</p> <p>d110x150mm 1f-d98mm 1f-d29mm</p>		<p><b>KL2763</b> NO. 028103638G - 028103665 - 028103937</p> <p>KIT CASQUILHOS REPARAÇÃO CAIXA FILTRO OLEO</p> <p>FORD GALAXY (WGR) 2.0 i (11.95 A 05.06) 116cv 1998cc Veiculo multiuso - FORD GALAXY (WGR) 2.3 16V (09.01 A 05.06) 140cv 2295cc Veiculo multiuso - FORD GALAXY (WGR) 2.3 16V (01.97 A 05.06) 146cv 2295cc Veiculo multiuso - FORD GALAXY (WGR) 2.8 i V6 (11.95 A 04.00) 174cv 2792cc Veiculo multiuso - FORD GALAXY (WGR) 2.8 i V6 4x4 (04.96 A 04.00) 174cv 2792cc Veiculo multiuso - FORD GALAXY (WGR) 2.8 V6 (04.00 A 05.06) 204cv 2792cc Veiculo multiuso...etc.</p> <p>d28x19mm 1f-d9mm</p>
	<p><b>M6109</b> NO. 1005891</p> <p>JUNTA DE ESCAPE</p> <p>FORD GALAXY (APÓS 08-97)</p> <p>82x41mm 1f-38/27mm</p>		<p><b>R221912</b> NO.</p> <p>TUBO DE LIGAÇÃO DO AR AO TURBO</p> <p>FORD GALAXY (WGR) 1.9 TDi (03.95 - 05.06) 90cv 1896cc Veiculo multiuso - FORD GALAXY (WGR) 1.9 TDi (08.97 - 04.00) 110cv 1896cc Veiculo multiuso</p> <p>B55-50/50mm 55mm</p>
	<p><b>RT08924</b> NO. 7335771</p> <p>TUBO DE TRAVÃO FRENTE LH-RH</p> <p>FORD GALAXY TT (APÓS 11-1995)</p> <p>500mm FB54 - MCL</p>		<p><b>RT80244</b> NO. 7335770 - 95VW2282AD - 7M0611775C - 7M0611775E</p> <p>TUBO DE TRAVÃO TRÁS LH-RH</p> <p>FORD GALAXY TT (APÓS 11-1995)</p> <p>400mm F - FB54</p>
	<p><b>RT80258</b> NO. 1304007 - 1121359</p> <p>TUBO DE TRAVÃO FRENTE LH-RH</p> <p>FORD GALAXY TT (APÓS 04-2000)</p> <p>480mm F5 - FB24</p>		<p><b>S1367</b> NO. 7201717 - 95VW5A638CA</p> <p>SILENT-BLOC DO BRAÇO DA SUSPENSÃO DA FRENTE</p> <p>FORD GALAXY 1.9 TDi - 2.0 - 2.3 - 2.8</p> <p>d60x50mm c28mm 1f-d18mm</p>
	<p><b>T1096</b> NO. 1009649</p> <p>BATENTE DA BARRA ESTABILIZADORA DE TRÁS LADO LATERAL</p> <p>FORD GALAXY (1995 A 2000) 1.9 TDi - 2.0 - 2.3 - 2.8</p> <p>d35x30mm 1f-d21mm</p>		<p><b>W5008</b> NO. 95VW6B321CA - 1069593 - 1100674 - 1669807 - 7198528 - 95VW6B321CB - XM216316AA</p> <p>POLIE DA CÂMBOTA (6 pistas)</p> <p>FORD GALAXY 1.9 TDi MTr 1Z - AFN - AHU - AHV - ANU - AVG (APÓS 03-1995)</p> <p>d155.5mm d30mm</p>

	<b>W5048</b>	NO. 1315782 - 3M216B320AA - MN980049 - 68001304AA		
	POLIE DA CAMBOTA (6 PISTAS)			
	FORD GALAXY 1.9 TDi Mtr ASZ 3M21-6B320AA (115-130-150CV) (APÓS 09-2003)			
	d143mm	d30mm		

## FORD KA



	<b>A1382</b>	NO. 6548783 - 91AB8125AC		<b>A1679</b>	NO. 1032120 - 97KB6038AD
	APOIO DO RADIADOR			APOIO DO MOTOR PARTE DA FRENTE	
	FORD KA (APÓS 09-1996) - FORD PUMA (06-1997 A 12-2001) - FORD FIESTA (08-1995 A 01-2002)			FORD KA 1.3 (APÓS 1996)	
	d32x33mm	1f-d13mm		185x140x58mm	NULL
	<b>E1055</b>	NO. 1025233		<b>F1844-I</b>	NO. 1026905 - 1073806 - 1304000 - 1S5W3L537AA - 1S5W4A084AA - 1S5W4A084BA - 4453301 - 97FG3L537AB
	ESTICADOR DE ESCAPE			FOLE DA TRANSMISSÃO JUNTO À CAIXA	
	FORD KA 1.3i (APÓS 09-1999)			FORD KA 1.3i (APÓS 96)	
	54x50x30mm	1f-d10mm		d91x102mm	1f-d80mm 1f-d22mm
	<b>M6090</b>	NO. 1030977 - 1953210		<b>T1055</b>	NO. 1035515 - 97KB5484AA
	JUNTA DE ESCAPE			BATEANTE DA BARRA ESTABILIZADORA CENTRO FRENTE	
	FORD KA (APÓS 1997)			FORD KA 1.3i (APÓS 1997)	
	d53x4mm	1f-d45mm		40x37x31mm	1f-d14mm
	<b>Z80677</b>	NO. 6786759		<b>Z80704</b>	NO. 6176723 - 500326189
	Mola de painel			Mola de painel	
	FORD KA			FORD KA (Após 1997)	
	d15x14.5mm	1p-d9.3-12.5mm		d18x21mm	1p-d8.2-15mm
	<b>Z80717</b>	NO. 6150260			
	Mola de fixação				
	FORD KA				
	d20x12.5mm	1p-8x11-10mm 1f-d5.5mm			

	<b>A1784</b> NO. 1224049 - 1404996 - 1533046 - 1420044 - 1355357 - 1370874 - 3M516P082AF - AV616P082AB - 3M516P082AD ...		<b>T1128</b> NO. 1305960 - 3M51.5484.CA - 30666266
	<b>APOIO DA CAIXA VELOCIDADES</b>  FORD KUGA 2.5 4X4 (VEÍCULO TODO TERRENO FECHADO) 200CV 2522cc (APÓS 03-2009) - 2.0 TDCi (VEÍCULO TODO TERRENO) 136CV 1997cc (APÓS 03-2008) - 2.0 TDCi 4X4 (VEÍCULO TODO TERRENO) 136CV 1997cc (APÓS 03-2008) - 2.0 TDCi (VEÍCULO TODO TERRENO) 140CV 1997cc (A)		<b>BATENTE DA BARRA ESTABILIZADORA DA FRENTE</b>  FORD KUGA I 2.0 TDCi (G6DG - UKDA) 136CV (APÓS 03-2008) - 2.0 TDCi (UFDA) 140CV (APÓS 03-2010) - 2.0 TDCi 4X4 (G6DG - UKDA) 136CV (APÓS 03-2008) - 2.0 TDCi 4X4 (TXDA) 163CV (APÓS 03-2010) - 2.0 TDCi 4X4 (UFDA) 140CV (APÓS 03-2010) - 2.5 (HYDB) 200CV (APÓS 03-2010)
160x1005x45mm	2f-d12mm 1f-M12	47x47x48mm	1f-d18mm

















FORD MAVERICK

	<b>A1369</b> NO. 1953204 - 1953205		<b>F1202-I</b> NO. 39241-10E02
	<b>APOIO DE ESCAPE</b>  FORD MAVERICK (APÓS 1993)		<b>FOLE DE TRANSMISSÃO JUNTO À RODA</b>  FORD MAVERICK 2.7 TD (1993 A 1998)
130x50x35mm	NULL	d109x96mm	1f-d95mm 1f-d23mm
	<b>F1223-I</b> NO. 39241-41W25 - 39741-31G25 - 39741-41W25		<b>KF1890</b> NO.
	<b>FOLE JUNTO À CAIXA</b>  FORD MAVERICK 2.4i (02-1993 A 04-1998)		<b>KIT DE FOLE DO CARDAN LADO DA RODA</b>  FORD MAVERICK 2.7TD (08-1993 A 10-1997) - MAVERICK 2.7TDIC (07-1996 A 10-1997)
d100x102mm	1f-d26mm	d108x92mm	1f-d95mm 1f-d23mm
	<b>KF9001</b> NO. 6757617 - 93BG3A331CA - 98BX.4A084.AA - 1073933 - 6757618		<b>M6070</b> NO. 1664671
	<b>KIT DO FOLE DO LADO DA RODA</b>  FORD MAVERICK 2.4i (1993 A 1998)		<b>JUNTA DE ESCAPE</b>  FORD MAVERICK (APÓS 1993)
d103x140mm	1f-d87mm 1f-d17mm	120x71mm	1f-d55mm
	<b>M6090</b> NO. 1030977 - 1953210		
	<b>JUNTA DE ESCAPE</b>  FORD MAVERICK (APÓS 1993)		
d53x4mm	1f-d45mm		

FORD MONDEO















	<b>A1388</b> NO. 6838725 - 93BB.18198.BC		<b>A1591</b> NO. 1024959 - 1097914 - 98BB.6P082.AA - 6803993 - 6911968
	<b>APOIO DA SUSPENSÃO DE TRÁS (AMORTECEDOR)</b>  FORD MONDEO (APÓS 1993)		<b>APOIO DO MOTOR PARTE DE TRÁS CAIXA DE VELOCIDADES</b>  FORD MONDEO I (GBP) 1.6 i 16V - 1.8 i 16V - 2.0 i 16V 02-93 A 08-96 MONDEO I COMBI (BNP) 1.6 i 16V - 1.8 i 16V - 2.0 i 16V 04-93 A 08-96 MONDEO I TRÊS VOLUMES (GBP) 1.6 i 16V - 1.8 i 16V - 2.0 i 16V 02-93 A 08-96 MONDEO II (BAP) 1.6 i - 1.6i 16V - 1.8
174x172x44mm	1f-d12mm 2f-d8mm	140x130x125mm	1f-d20mm

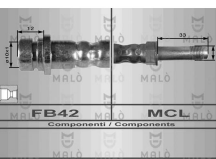
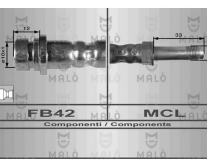

	<p><b>A1595</b> NO. 7324691 - 948125 - 94BB.8125.BB - 6704254</p> <p>APOIO DO RADIADOR PARTE INFERIOR</p> <p>FORD MONDEO (APÓS 1996)</p> <p>d41x38mm 1f-d18-14mm</p>		<p><b>A1596</b> NO. 7324692 - 1354636 - 94BB.8125.CA</p> <p>APOIO DO RADIADOR PARTE SUPERIOR</p> <p>FORD MONDEO (APÓS 1996)</p> <p>d53x50mm d29mm 1f-d14mm</p>
	<p><b>A1779</b> NO. 1117880 - 1212003 - 1213618 - 1220636 - 1332838</p> <p>APOIO DO MOTOR FRENTE PARTE SUPERIOR</p> <p>FORD MONDEO III 2.0 16V Di - TDDi - TDCi (D5BA - SDBA) 90CV (11-2000 A 08-2007) - 2.0 16V TDDi - TDCi (D6BA - HJBA - HJBB - HJBC) 115CV (11-2000 A 08-2007) - 2.0 TDCi (FMBA - N7BA) 130CV (10-2001 A 08-2007) - 2.2 TDCi (QJBA - QJBB) 155CV (09-2004 A 08-2007)</p> <p>195x140x130mm 2f-d8mm 2f-d13mm 2f-16x20mm</p>		<p><b>A1779</b> NO. 1117880 - 1212003 - 1213618 - 1220636 - 1332838</p> <p>APOIO DO MOTOR FRENTE PARTE SUPERIOR</p> <p>FORD MONDEO III STATION WAGON 2.0 16V Di - TDDi - TDCi (D5BA - SDBA) 90CV (11-2000 A 08-2007) - 2.0 16V TDDi - TDCi (D6BA - HJBA - HJBB - HJBC) 115CV (11-2000 A 08-2007) - 2.0 TDCi (FMBA - N7BA) 130CV (10-2001 A 08-2007) - 2.2 TDCi (QJBA - QJBB) 155CV (09-2004 A 08-2007)</p> <p>195x140x130mm 2f-d8mm 2f-d13mm 2f-16x20mm</p>
	<p><b>A1779</b> NO. 1117880 - 1212003 - 1213618 - 1220636 - 1332838</p> <p>APOIO DO MOTOR FRENTE PARTE SUPERIOR</p> <p>FORD MONDEO III TRE VOLUMI 2.0 16V Di - TDDi - TDCi (D5BA - SDBA) 90CV (11-2000 A 08-2007) - 2.0 16V TDDi - TDCi (D6BA - HJBA - HJBB - HJBC) 115CV (11-2000 A 08-2007) - 2.0 TDCi (FMBA - N7BA) 130CV (10-2001 A 08-2007) - 2.2 TDCi (QJBA - QJBB) 155CV (09-2004 A 08-2007)</p> <p>195x140x130mm 2f-d8mm 2f-d13mm 2f-16x20mm</p>		<p><b>A1831</b> NO. 1205834 - 1205835 - 1303625 - 1S7118198AF - 1S7118198AG - 1S7118198AH</p> <p>APOIO DOS AMORTECEDORES DE TRÁS</p> <p>FORD MONDEO III (B5Y) 1.8 16V Hatchback (10.00 - 03.07) 110cv 1798cc - FORD MONDEO III (B5Y) 1.8 16V Hatchback (10.00 - 03.07) 125cv 1798cc - FORD MONDEO III (B5Y) 1.8 SCi Hatchback (06.03 - 03.07) 130cv 1798cc - FORD MONDEO III (B5Y) 2.0 16V Hatchback (1</p> <p>170x160x70mm 2f-d10mm 1f-d12mm</p>
	<p><b>C0231</b> NO. 6483712 - 91AB.16C618.AA</p> <p>BOTÃO DE AFINAÇÃO DE CAPOT</p> <p>FORD MONDEO (1992 A 2000)</p> <p>d27x44mm NULL</p>		<p><b>D0037</b> NO. 1515117 - 1638947 - 6518778 - 83BG4684BA - 83GB4684BA - 88GG4684BA - GAF41</p> <p>CARDAN TRANSMISSÃO</p> <p>FORD MONDEO I (GBP) 1.6 i 16V (07.94 A 08.96) 88cv 1597cc Hatchback</p> <p>120x135x40x46mm 6f-12x12mm</p>
	<p><b>E0087</b> NO. 1219697 - 1117698 - 1S713B438AB - 1S71.3B438.BA</p> <p>ESTICADOR DA BARRA ESTABILIZADORA</p> <p>FORD MONDEO III (B5Y) 1.8 16V - 2.0 16V - 2.016V Di - 2.0 16V TDDi - 2.016 TDCi - 2.5 V6 24V - ST 220 APÓS 11-2000 - MONDEO III COMBI (BWY) 1.8 16V - 2.0 16V - 2.0 16V Di - 2.0 16V TDDi - 2.0 16V TDCi - 2.5 V6 24V - ST 220 APÓS 11-2000 - MONDEO III TRÊS</p> <p>285x35x35mm 2p-d10-25mm</p>		<p><b>E0103</b> NO. 1106269 - 6960036 - 93BB3B438CA - YS713B438AA - YS71.3B438.AB - 5106965 - 5106995</p> <p>ESTICADOR DA BARRA ESTABILIZADORA DA FRENTE</p> <p>FORD MONDEO I TT (ATÉ 08-1996) - MONDEO II TT (09-1996 A 11-2000)</p> <p>265x26x26mm 2p-d10-30mm</p>
	<p><b>E0104</b> NO. 1054209 - 1039511 - 93BB5K566AH - 93BB5K566AG - 1022358 - 1035911 - 7230373 - 7365613</p> <p>ESTICADOR DA BARRA ESTABILIZADORA DE TRÁS</p> <p>FORD MONDEO I TT (ATÉ 08-1996) - MONDEO II TT (09-1996 A 11-2000)</p> <p>120x32x22mm 1p-d10x45mm 1f-d10mm</p>		<p><b>E0105</b> NO. 1127646 - 1S71.3B438.AC - C2S3248</p> <p>ESTICADOR DA BARRA ESTABILIZADORA DA FRENTE</p> <p>FORD MONDEO III TT (APÓS 11-2000)</p> <p>290x36x36mm 2p-d10-28mm</p>
	<p><b>E0106</b> NO. 1117800 - 1127648 - 1S715C486AD</p> <p>ESTICADOR DA BARRA ESTABILIZADORA DA FRENTE</p> <p>FORD MONDEO III TT (APÓS 11-2000)</p> <p>290x40x40mm 2p-d10-23mm</p>		<p><b>E0137</b> NO. 7014210 - 93BB5K566AC - 6701505 - 6783835 - 6931610</p> <p>ESTICADOR DA BARRA ESTABILIZADORA DE TRÁS</p> <p>FORD MONDEO I TT A 08-1996 - FORD MONDEO II TT (09-1996 A 11-2000)</p> <p>102x30x30mm 1p-d10-30mm 1f-d7mm</p>
	<p><b>E0157</b> NO. 1219697 - 1S713B438BA - C2S39552</p> <p>ESTICADOR DA BARRA ESTABILIZADORA</p> <p>FORD MONDEO (1993 A 1996)</p> <p>290x40x40mm 2p-d10-24mm</p>		<p><b>E0158</b> NO. 1130452 - 1S715C486BE</p> <p>ESTICADOR DA BARRA ESTABILIZADORA DE TRÁS</p> <p>FORD MONDEO (APÓS 2000)</p> <p>100x35x45x38mm 2p-d10-23mm</p>



	<p><b>E1018</b> NO. 6831302 - 6866417 - 93B85A262F - 93B85A262G</p> <p>ESTICADOR DE ESCAPE</p> <p>FORD MONDEO (02-1993 A 08-1996)</p>		<p><b>F1444-I</b> NO. 6676136 - 92TT3A331</p> <p>FOLE DA TRANSMISSÃO JUNTO À RODA</p> <p>FORD MONDEO I 2.0 - 2.5 (APÓS 2003)</p>
	<p><b>F1618-I</b> NO. 3904122 - 6772173 - F6RC.3K661.AA - 157C3K661AB - 4119193</p> <p>FOLE DA DIRECÇÃO ASSISTIDA LADO DIREITO E ESQUERDO</p> <p>FORD MONDEO I (1993 A 1996 1.6i - 1.6i 16V - 1.8 TD - 1.8i - 1.8i 16V - 2.0i - 2.0i 16V - 2.0i 16V 4X4 - 2.5i 24V - 2.5i ST200 - MONDEO II (1996 A 2000 1.6i - 1.8i - 1.8 TD - 2.0i - 2.5i</p>		<p><b>F1659E-I</b> NO. 6757645</p> <p>FOLE DA TRANSMISSÃO JUNTO À CAIXA</p> <p>FORD MONDEO 1.6i 16V - 1.8i 16V - 1.8i 16V 4X4 - 2.0i 16V - 2.0i 16V 4X4 - 2.5i 24V (93 A 96)</p>
	<p><b>F1834-T</b> NO. 1016768 - 6757646</p> <p>FOLE DA TRANSMISSÃO JUNTO À CAIXA</p> <p>FORD MONDEO I 1.6i 16V - 1.8i 16V - 1.8i 16V 4X4 - 1.8TD - 2.0i 16V - 2.0i 16V 4X4 - 2.5i 24V (1993 A 1996)</p>		<p><b>F1835-T</b> NO. 1073937 - 3940332 - F8RZ3A331C</p> <p>FOLE DA TRANSMISSÃO JUNTO À RODA</p> <p>FORD MONDEO I 1.6i 16V - 1.8i 16V - 2.0i 16V - 2.0i 16V 4X4 - 2.5i 24V (1993 A 1996)</p>
	<p><b>F1843-I</b> NO. 1S714A084BC - 1S714A084DB - 1S714A084EB - 1S7W3L537AA - 1S7W3L537AB - 4106429 - 1361247 - 1363797</p> <p>FOLE DA TRANSMISSÃO JUNTO À CAIXA</p> <p>FORD MONDEO III (APÓS 2000) 1.8i 16V - 2.0i 16V - 2.5i V6 24V</p>		<p><b>F4021</b> NO. F33.3K661.AA - 3904122 - F6RC3K661AA</p> <p>FOLE DA DIRECÇÃO ASSISTIDA DIREITO E ESQUERDO</p> <p>FORD MONDEO 1.6i - 1.8i - 1.8TD - 2.0i - 2.5i (1993 A 2000)</p>
	<p><b>F9039H-I</b> NO. 1446300</p> <p>FOLE DO CARDAN LADO DA RODA</p> <p>FORD MONDEO IV 1.8 TDCi (FFBA) 100CV (APÓS 03-2007) - 1.8 TDCi (KHBA - QYBA) 125CV (APÓS 06-2007) - 2.0 (AOBA - AOBC - TBBA) 145CV (APÓS 03-2007) - 2.0 TDCi (AZBA) 130CV (APÓS 03-2007) - 2.0 TDCi (KLBA - LPBA - TYBA) 115CV (APÓS 11-2007) - 2.0 TDCi 8QXBA - QXBB - UFBA)</p>		<p><b>KF9000</b> NO. 1073937 - 3940332 - F8RZ3A331C</p> <p>KIT DE FOLE LADO DA RODA</p> <p>FORD MONDEO 1.6i - 1.8i - 2.0i - 2.5i (1993 A 1996)</p>
	<p><b>KF9001</b> NO. 6757617 - 93BG3A331CA - 98BX.4A084.AA - 1073933 - 6757618</p> <p>KIT DO FOLE DO LADO DA RODA</p> <p>FORD MONDEO 1.6i - 1.8i - 1.8TD - 2.0i - 2.5i - (1993 A 1996)</p>		<p><b>KF9022</b> NO. 1023221 - 1073947 - 96BG3A331AA - 98BX4A084EA - 1061867</p> <p>KIT DE FOLE DO LADO DA RODA</p> <p>FORD MONDEO II (BAP) 1.6i Hatchback (08-1996 A 09-2000) 90CV 1597CC - FORD MONDEO II (BAP) 1.6 i 16V Hatchback (05-1998 A 09-2000) 95CV 1597CC - FORD MONDEO II (BAP) 1.8i (08-1996 A 09-2000) 115CV 1796CC - FORD MONDEO II (BAP) 2.0i (08-1996 A 09-2000) 131</p>
	<p><b>L3042</b> NO. 6915411 - 93BB.5C493.AC - 6915411</p> <p>CASQUILHO DA BARRA ESTABILIZADORA DE TRÁS (PONTAS)</p> <p>FORD MONDEO (1996 A 1998)</p>		<p><b>M6057</b> NO. 6797187 - 6692784 - 6993854</p> <p>JUNTA DE ESCAPE</p> <p>FORD MONDEO (1993 A 1996)</p>
	<p><b>M6078</b> NO. 6827023 - 0004920581 - 91516522 - 91537797 - 96038954 - 96033780 - 0004920081 - GEX7864 - 171228 - 9...</p> <p>JUNTA DE ESCAPE</p> <p>FORD MONDEO TD (06-1993 A 08-1996)</p>		<p><b>P1048</b> NO. 6789917 - 1076899 - 1029040 - 98AB.7A624.AA - 97KB.2457.AB - 94BB.7A624.AA - 94BB7A624AA</p> <p>CAPA DE PEDAL DO TRAVÃO E EMBRAIAGEM</p> <p>FORD MONDEO I (APÓS 08-1996) - MONDEO II 1.6 - 1.8 - 1.8 I 16V - 1.8 TD - 2.0 - 2.0i 16V (9-1996 A 11-2000)</p>

	<p><b>R224141</b> NO. 1222831 - 2S7Q6N696AA</p> <p>TUBO ADMISSÃO FILTRO DE AR</p> <p>FORD MONDEO III (B5Y) 2.0 TDCi (10.01 A 03.07) 130cv 1998cc Hatchback - FORD MONDEO III três volumes (B4Y) 2.0 TDCi (10.01 A 03.07) 130cv 1998cc três volumes - FORD MONDEO III Turnier (BWY) 2.0 TDCi (10.01 A 03.07) 130cv 1998cc Combi</p> <p>B340-38/50mm 70-60-140-90mm</p>		<p><b>RT08648</b> NO. 1025018 - 1071639</p> <p>TUBO DE TRAVÃO TRÁS LH-RH</p> <p>FORD GALAXI 1.8 TDCi (APÓS 05-2006) - GALAXI 2.0 (APÓS 05-2006) - GALAXI 2.0 TDCi (APÓS 05-2006) - GALAXY 2.2 TDCi (APÓS 03-2008) - GALAXI 2.3 (APOS 07-2007)</p> <p>580mm NULL</p>
	<p><b>RT08648</b> NO. 1025018 - 1071639</p> <p>TUBO DE TRAVÃO TRÁS LH-RH</p> <p>FORD MONDEO II 1.6i (09-1996 A 11-2000) - MONDEO II 1.6 i 16V (05-1998 A 11-2000) - MONDEO II 1.8 i (09-1996 A 11-2000) - MONDEO II 1.8 TD (09-1996 A 11-2000) - MONDEO II 2.0 i (09-1996 A 11-2000) - MONDEO II 2.5 24V (09-1996 A 11-2000)</p> <p>580mm NULL</p>		<p><b>RT08648</b> NO. 1025018 - 1071639</p> <p>TUBO DE TRAVÃO TRÁS LH-RH</p> <p>FORD MONDEO II TRE VOLUMI 1.8i (09-1996 A 11-2000) - MONDEO II TRE VOLUMI 2.0i (09-1996 A 11-2000) - MONDEO II TRE VOLUMI 2.5 24V (09-1996 A 11-2000) - MONDEO II TRE VOLUMI 2.5 ST 200 (05-1999 A 11-2000)</p> <p>580mm NULL</p>
	<p><b>RT08649</b> NO. 6922621 - 93BB2282DD</p> <p>TUBO DE TRAVÃO TRÁS LH-RH</p> <p>FORD MONDEO I 1.8i 16V (02-1993 A 08-1996) - MONDEO I 1.8i 16V 4X4 (02-1993 A 08-1996) - MONDEO I 1.8 TD (06-1993 A 08-1996) - MONDEO I 2.5i 24V (07-1994 A 08-1996) - MONDEO I TRE VOLUMI 2.0i 16V (02-1993 A 08-1996) - MONDEO I TRE VOLUMI 2.0i 16V 4X4 (12-08-1996)</p> <p>325mm FB42 - OR20</p>		<p><b>RT08649</b> NO. 6922621 - 93BB2282DD</p> <p>TUBO DE TRAVÃO TRÁS LH-RH</p> <p>FORD MONDEO I STATION WAGON 2.0i 16V (01-1993 A 08-1996) - MONDEO I STATION WAGON 2.0i 16V 4X4 (04-1993 A 08-1996) - MONDEO I STATION WAGON 2.5i 24V (07-1994 A 08-1996)</p> <p>325mm FB42 - OR20</p>
	<p><b>RT08649</b> NO. 6922621 - 93BB2282DD</p> <p>TUBO DE TRAVÃO TRÁS LH-RH</p> <p>FORD MONDEO II STATION WAGON 1.6i (09-1996 A 11-2000) - MONDEO II STATION WAGON 1.6i 16V (05-1998 A 11-2000) - MONDEO II STATION WAGON 1.8i (09-1996 A 11-2000) - MONDEO II STATION WAGON 1.8 TD (09-1996 A 11-2000)</p> <p>325mm FB42 - OR20</p>		<p><b>RT08649</b> NO. 6922621 - 93BB2282DD</p> <p>TUBO DE TRAVÃO TRÁS LH-RH</p> <p>FORD MONDEO II STATION WAGON 2.0i (09-1996 A 11-2000) - MONDEO II STATION WAGON 2.5 24V (09-1996 A 11-2000) - MONDEO II STATION WAGON 2.5 ST 200 (05-1999 A 11-2000)</p> <p>325mm FB42 - OR20</p>
	<p><b>RT08686</b> NO. 6758587 - 93BB2282CA</p> <p>TUBO DE TRAVÃO TRÁS LH-RH</p> <p>FORD MONDEO I STATION WAGON 1.6 i 16V (04-1993 A 08-1996) - MONDEO I STATION WAGON 1.8 i 16V (04-1993 A 08-1996) - MONDEO I STATION WAGON 1.8i 16V 4X4 (04-1993 A 08-1996) - MONDEO I STATION WAGON 1.8 TD (06-1993 A 08-1996) - MONDEO I STATION WAGON 2.0i 16V</p> <p>345mm FB42 - MCL</p>		<p><b>RT08686</b> NO. 6758587 - 93BB2282CA</p> <p>TUBO DE TRAVÃO TRÁS LH-RH</p> <p>FORD MONDEO I STATION WAGON 1.6i 16V (04-1993 A 08-1996) - MONDEO I STATION WAGON 1.8i 16V (04-1993 A 08-1996) - MONDEO I STATION WAGON 1.8i 16V 4X4 (04-1993 A 08-1996) - MONDEO I STATION WAGON 1.8 TD (06-1993 A 08-1996)</p> <p>345mm FB42 - MCL</p>
	<p><b>RT08686</b> NO. 6758587 - 93BB2282CA</p> <p>TUBO DE TRAVÃO TRÁS LH-RH</p> <p>FORD MONDEO II STATION WAGON 1.6i (09-1996 A 11-2000) - MONDEO II STATION WAGON 1.6i 16V (05-1998 A 11-2000) - MONDEO II STATION WAGON 1.8i (09-1996 A 11-2000) - MONDEO II STATION WAGON 1.8TD (09-1996 A 11-2000) - MONDEO II STATION WAGON 2.0i (09-1996 A 11-2000)</p> <p>345mm FB42 - MCL</p>		<p><b>RT08686</b> NO. 6758587 - 93BB2282CA</p> <p>TUBO DE TRAVÃO TRÁS LH-RH</p> <p>FORD MONDEO II STATION WAGON 1.6i (09-1996 A 11-2000) - MONDEO II STATION WAGON 1.6i 16V (05-1998 A 11-2000) - MONDEO II STATION WAGON 1.8i (09-1996 A 11-2000) - MONDEO II STATION WAGON 1.8 TD (09-1996 A 11-2000) - MONDEO II STATION WAGON 2.0i (09-1996 A 11-2000)</p> <p>345mm FB42 - MCL</p>
	<p><b>RT08999</b> NO. 1114758 - 1117107 - 1121635 - 1444731</p> <p>TUBO DE TRAVÃO TRÁS LH-RH</p> <p>FORD MONDEO II STATION WAGON 2.5 24V (09-1996 A 11-2000) - MONDEO II STATION WAGON 2.5 ST 200 (05-1999 A 11-2000)</p> <p>310mm FB42 - MC53</p>		<p><b>RT08999</b> NO. 1114758 - 1117107 - 1121635 - 1444731</p> <p>TUBO DE TRAVÃO TRÁS LH-RH</p> <p>FORD MONDEO III 1.8 16V (11-2000 A 08-2007) - MONDEO III 1.8 Sci (06-2003 A 08-2007) - MONDEO III 2.0 16V (11-2000 A 08-2007) - MONDEO III 2.0 16V Di - TDDi - TDCi (11-2000 A 08-2007) - MONDEO III 2.0 16V TDDi - TDCi (11-2000 A 08-2007) - MONDEO III 2.0 T</p> <p>310mm FB42 - MC53</p>
	<p><b>RT08999</b> NO. 1114758 - 1117107 - 1121635 - 1444731</p> <p>TUBO DE TRAVÃO TRÁS LH-RH</p> <p>FORD MONDEO III 2.2 TDCi (09-2004 A 08-2007) - MONDEO III 2.5 V6 24V (11-2000 A 08-2007) - MONDEO III 3.0 V6 24V (09-2004 A 08-2007) - MONDEO III ST220 (04-2002 A 08-2007) - MONDEO III STATION WAGON 1.8 16V (11-2000 A 08-2007) - MONDEO III STATION WAGON 1</p> <p>310mm FB42 - MC53</p>		<p><b>RT08999</b> NO. 1114758 - 1117107 - 1121635 - 1444731</p> <p>TUBO DE TRAVÃO TRÁS LH-RH</p> <p>FORD MONDEO III STATION WAGON 2.0 16V (11-2000 A 08-2007) - MONDEO III STATION WAGON 2.0 16V Di - TDDi - TDCi (11-2000 A 08-2007) - MONDEO III STATION WAGON 2.0 16V TDDi - TDCi (11-2000 A 08-2007) - MONDEO III STATION WAGON 2.0 TDCi (10-2001 A 08-2007)</p> <p>310mm FB42 - MC53</p>

	<p><b>RT08999</b> NO. 1114758 - 1117107 - 1121635 - 1444731</p> <p>TUBO DE TRAVÃO TRÁS LH-RH</p> <p>FORD MONDEO III STATION WAGON 2.2 TDCi (09-2004 A 08-2007) - MONDEO III STATION WAGON 2.5 V6 24V (11-2000 A 08-2007) - MONDEO III STATION WAGON 3.0 V6 24V (09-2004 A 08-2007) - MONDEO III STATION WAGON ST220 (04-2002 A 08-2007)</p> <p>310mm FB42 - MC53</p>		<p><b>RT08999</b> NO. 1114758 - 1117107 - 1121635 - 1444731</p> <p>TUBO DE TRAVÃO TRÁS LH-RH</p> <p>FORD MONDEO III TRE VOLUMI 1.8 16V (11-2000 A 08-2007) - MONDEO III TRE VOLUMI 1.8 SCI (06-2003 A 08-2007) - MONDEO III TRE VOLUMI 2.0 16V (11-2000 A 08-2007) - MONDEO III TRE VOLUMI 2.0 16V Di - TDDi - TDCi (11-2000 A 08-2007) - MONDEO III TRE VOLUMI 2.</p> <p>310mm FB42 - MC53</p>
	<p><b>RT08999</b> NO. 1114758 - 1117107 - 1121635 - 1444731</p> <p>TUBO DE TRAVÃO TRÁS LH-RH</p> <p>FORD MONDEO III TRE VOLUMI 2.0 TDCi (10-2001 A 08-2007) - MONDEO III TRE VOLUMI 2.2 TDCi (09-2004 A 08-2007) - MONDEO III TRE VOLUMI 2.5 V6 24V (11-2000 A 08-2007) - MONDEO III TRE VOLUMI 3.0 V6 24V (09-2004 A 08-2007) - MONDEO III TRE VOLUMI ST220 (04-2002 A 08-2007)</p> <p>310mm FB42 - MC53</p>		<p><b>RT80234</b> NO. 1051093 - 1071941</p> <p>TUBO DE TRAVÃO TRÁS LH-RH</p> <p>FORD MONDEO II 1.6i (09-1996 A 11-2000) - MONDEO II 1.6i 16V (05-1998 A 11-2000) - MONDEO II 1.8i (09-1996 A 11-2000) - MONDEO II 1.8 TD (09-1996 A 11-2000) - MONDEO II 2.0i (09-1996 A 11-2000) - MONDEO II 2.5 24V (09-1996 A 11-2000) - MONDEO II 2.5 ST 20</p> <p>340mm FB61 - OR20</p>
	<p><b>RT80263</b> NO. 4510813</p> <p>TUBO DE TRAVÃO TRÁS LH-RH</p> <p>FORD TOURNEO CONNECT 1.8 16V (APÓS 06-2002) - TOURNEO CONNECT 1.8 Di (APÓS 06-2002) - TOURNEO CONNECT 1.8 TURBO Di (APÓS 06-2002)</p> <p>345mm FB42 - MC54</p>		<p><b>RT80307</b> NO. 1071939 - 91071939</p> <p>TUBO DE TRAVÃO TRÁS LH-RH</p> <p>FORD MONDEO I STATION WAGON 2.0i 16V 4X4 (04-1993 A 08-1996) - MONDEO I STATION WAGON 2.5i 24V (07-1994 A 08-1996)</p> <p>575mm MC45 - MC55</p>
	<p><b>RT80307</b> NO. 1071939 - 91071939</p> <p>TUBO DE TRAVÃO TRÁS LH-RH</p> <p>FORD MONDEO II STATION WAGON 2.5 24V (10-1999 A 11-2000)</p> <p>575mm MC45 - MC55</p>		<p><b>RT80450</b> NO. 1379911 - 1671020</p> <p>TUBO DE TRAVÃO FRENTE LH-RH</p> <p>FORD MONDEO IV 1.6 Ti (APÓS 03-2007) - MONDEO IV 1.8 TDCi (APÓS 03-2007) - MONDEO IV 2.0 (APÓS 03-2007) - MONDEO IV 2.0 TDCi (APÓS 03-2007) - MONDEO IV 2.3 (APÓS 07-2007) - MONDEO IV 2.5 (APÓS 03-2007)</p> <p>420mm FB76 - MC64</p>
	<p><b>S1131</b> NO. 6870549 - 93BB.3A262.BA</p> <p>SILENT-BLOC DA SUSPENSÃO DA FRENTE PARTE DE TRÁS</p> <p>FORD MONDEO 1.6 - 1.6i 16V - 1.8TD - 1.8i - 1.8i 16V - 2.0i - 2.0i 16V (1993 A 2000)</p> <p>d46x46mm c25mm 1f-d12mm</p>		<p><b>S1178</b> NO. 6790115 - 93BB.3063.AA</p> <p>SILENT-BLOC DA SUSPENSÃO DA FRENTE PARTE DA FRENTE</p> <p>FORD MONDEO 1.6i - 1.6i 16V - 1.8TD - 1.8i - 1.8i 16V - 2.0i - 16V (1993 A 2000)</p> <p>d47x45.5mm c28mm 1f-d12mm</p>
	<p><b>S1257</b> NO. 1023058 - 95BG3A262AA - 95BG.3A262.BA - 1074262</p> <p>SILENT-BLOC DO BRAÇO DA SUSPENSÃO FRENTE PARTE DE TRÁS</p> <p>FORD MONDEO (APÓS 1996)</p> <p>d60x46mm c25mm 1f-d12mm</p>		<p><b>S1375</b> NO. 6901534 - 93BB.5K896.AC</p> <p>SILENT-BLOC DA SUSPENSÃO DE TRÁS</p> <p>FORD MONDEO (APÓS 1996)</p> <p>d39x45mm c30mm 1f-d12mm</p>
	<p><b>S1445</b> NO. 6829045 - 935K653AB - 39BB-5500-AC - 93BB-5500-AD - 1S71-5500-AA - 93BB-5K653-AB - 1S71-5K743-CA - 1...</p> <p>SILENT-BLOC DO BRAÇO DA SUSPENSÃO</p> <p>FORD MONDEO I (93 A 96) - MONDEO II (96 A 2000)</p> <p>d36.5x35mm c28mm 1f-12.2mm</p>		<p><b>S1446</b> NO. 1S713063AA</p> <p>SILENT-BLOC DO BRAÇO DA SUSPENSÃO DA FRENTE PARTE INTERNA</p> <p>FORD MONDEO (APÓS 2001)</p> <p>d47x69mm c41mm d35mm 1f-d12.2mm</p>
	<p><b>S1447</b> NO. 1S713A262AA - 1102951 - 1116578 - 1129483</p> <p>SILENT-BLOC DO BRAÇO DA SUSPENSÃO DA FRENTE PARTE EXTERNA</p> <p>FORD MONDEO (APÓS 2001)</p> <p>d85x78mm c41mm d78mm 1f-d13mm</p>		<p><b>T0606-I</b> NO. 7284774 - 945K570AA</p> <p>BATENTE DA SUSPENSÃO DE TRÁS</p> <p>FORD MONDEO VAN SW (APÓS 1993)</p> <p>d76x130mm d63mm 1f-d15mm 1f-d32mm</p>

	<p><b>T0607-I</b> NO. 6817759 - 1106853 - 93BB.5K570.AC - 93BB.5K570.AD</p> <p>BATENTE DA SUSPENSÃO DA FRENTE</p> <p>FORD MONDEO (APÓS 1993)</p> <p>d64x142mm d62mm 1f-d22mm 1f-d27mm</p>		<p><b>T0640-I</b> NO. 4453303 - 1S7W3025AD - 1123541 - 1118919 - 1S713025AC - 1116577 - 1S713025AD - 1S713025AB - 4453969...</p> <p>BATENTE SUSPENSÃO DA FRENTE</p> <p>FORD MONDEO III (B5Y) 1.8 16V (10.00 A 03.07) 110cv 1798cc Hatchback - FORD MONDEO III (B5Y) 1.8 16V (10.00 A 03.07) 125cv 1798cc Hatchback - FORD MONDEO III (B5Y) 1.8 SCi (06.03 A 03.07) 130cv 1798cc Hatchback - FORD MONDEO III (B5Y) 2.0 16V (10.00 A 03.07) 146cv 1999cc Hatchback - FORD MONDEO III (B5Y) 2.5 V6 24V (10.00 A 03.07) 170cv 2495cc Hatchback - FORD MONDEO III (B5Y) 3.0 V6 24V (09.04 A 03.07) 204cv 2967cc Hatchback - FORD MONDEO ...etc.</p> <p>d69x69mm 1f-d28mm 1f-d28mm</p>
	<p><b>T1044</b> NO. 6714195 - 93 5484AB - 93BB5484AB - 1128725</p> <p>BATENTE DA BARRA ESTABILIZADORA CENTRO FRENTE</p> <p>FORD MONDEO (APÓS 1993)</p> <p>43x42x30mm 1f-d20mm</p>		<p><b>T1051</b> NO. 6714195</p> <p>BATENTE DO CENTRO DA BARRA ESTABILIZADORA (FURO DIÂMETRO 20mm)</p> <p>FORD MONDEO 1.6i - 1.6i 16V - 1.8TD - 1.8i - 1.8i 16V - 2.0i - 16V - 2.5TD - 2.5 ST200 (1993 A 2000)</p> <p>43x39x30mm 1f-d20mm</p>
	<p><b>T1090</b> NO. 1124418 - 1S71.4A037.DC</p> <p>BATENTE DA BARRA ESTABILIZADORA DE TRÁS</p> <p>FORD MONDEO III COMBI (BWY) 2.0 16V TDDi - 2.0 16V TDCi APÓS 11-2000 - MONDEO III TRÊS VOLUMES (B4Y) 1.8 16V - 2.0 16V - 2.0 16V Di - 2.0 16V TDDi - 2.0 16V TDCi - 2.5 V6 24V APÓS 11-2000 - 1.8 SCi APÓS 06-03 - 2.0 TDCi APÓS 10-2001 - ST 220 APÓS 04-02</p> <p>45x43x40mm 1f-d19mm</p>		<p><b>T1091</b> NO. 1118695 - 1307891 - 1116602 - 1S715484AC - 1S71.5484.AD</p> <p>BATENTE DA BARRA ESTABILIZADORA DA FRENTE</p> <p>FORD MONDEO III(B5Y) 1.8 16V - 2.0 16V - 2.0 16V Di-TDDi-TDCi 2.5 V6 24V - APÓS 11-2000 - 1.8 SCi APÓS 06-03 - ST 220 APÓS 04-02 MONDEO III COMBI (BWY)1.8 16V - 2.0 16V - 2.0 16V Di-TDDi-TDCi - 2.5 V6 24V APÓS 11-2000 - 1.8 SCi APÓS 06-03 - ST 220 APÓS 4</p> <p>46x47x40mm NULL</p>
	<p><b>W5035</b> NO. 1135052</p> <p>POLIE DA CAMBOTA (6 PISTAS)</p> <p>FORD MONDEO 1.6i - 1.8i - 2.0i (APÓS 2000)</p> <p>d132mm d28mm</p>		<p><b>W5090</b> NO. 1351731 - 1315530 - 1385506 - 1124891 - 1151394 - 1226637 - 1226638 - 1329203 - 1349993 - 1594853 - ...</p> <p>POLIE DA CAMBOTA (6 PISTAS)</p> <p>FORD MONDEO III 2.0 TDCi MOTOR D5BA 90CV (APÓS 11-2000) - 2.0 TDCi MOTOR D6BA 115CV (APÓS 11-2000)</p> <p>d160mm d5mm</p>
	<p><b>W5090</b> NO. 1351731 - 1315530 - 1385506 - 1124891 - 1151394 - 1226637 - 1226638 - 1329203 - 1349993 - 1594853 - ...</p> <p>POLIE DA CAMBOTA (6 PISTAS)</p> <p>FORD MONDEO III APÓS 11-2000 MOTOR (D5BA) 2.0 TDCi (90CV) - MOTOR (D6BA) APÓS 11-2000 2.0 TDCi (115CV) - TRANSIT MODELO 2000 MOTOR (ABFA - D3FA) 2.0 DI</p> <p>d160mm d5mm</p>		<p><b>Z80717</b> NO. 6150260</p> <p>Mola de fixação</p> <p>FORD MONDEO</p> <p>d20x12.5mm 1p-8x11-10mm 1f-d5.5mm</p>
	<p><b>Z80750</b> NO. 51471904317 - N90201601H - 2207713 - 6998849</p> <p>Mola de painel</p> <p>FORD MONDEO</p> <p>d20x23mm 1p-d9-20mm</p>		<p><b>Z80787</b> NO. 1039463 - 8E0825267</p> <p>Mola de fixação</p> <p>FORD MONDEO</p> <p>d20x34mm 1p-d8.5-21mm</p>

## FORD P100

	<p><b>A0725</b> NO. 508E6038</p> <p>SUPOORTE DO MOTOR</p> <p>FORD TRADLER 1500</p> <p>91x72x105mm 1f-d13mm</p>		<p><b>A1386</b> NO. 1576279 - 71BG.4826.DB</p> <p>APOIO DA TRANSMISSÃO</p> <p>FORD P100</p> <p>175x93x73mm 1f-d32mm</p>
--	--	--	---



	<p><b>F0463-I</b> NO. 1568355</p> <p>FOLE DA DIRECÇÃO ESQUERDO</p> <p>FORD P100 PICK UP</p> <p>d62x205mm 1f-d26mm 1f-d10mm</p>		<p><b>F0538-I</b> NO. 6043191 - 77TTA331FA - 98AX.4A084.BA - 1073846</p> <p>FOLE DO SEMI-EIXO JUNTO Á RODA OU CAIXA DE VELOCIDADES</p> <p>FORD P100 1.6 (1982 A 1987)</p> <p>d92x100mm 1f-d75mm 1f-d20mm</p>
	<p><b>F1081-I</b> NO. 617346 - 617347 - 1610365 - 84AB.3K661.AA</p> <p>FOLE DA DIRECÇÃO</p> <p>FORD P100 1.8TD - 2.0 (1987 A 1992)</p> <p>d60x230mm 1f-d48mm 1f-d10mm</p>		<p><b>F1081-I</b> NO. 617346 - 617347 - 1610365 - 84AB.3K661.AA</p> <p>FOLE DA DIRECÇÃO</p> <p>FORD P100 1.8TD - 2.0 (1987 A 1992)</p> <p>d60x230mm 1f-d48mm 1f-d10mm</p>
	<p><b>F1668-I</b> NO. 1619061 - 83BB.3K661.BD</p> <p>FOLE DA DIRECÇÃO DIREITO E ESQUERDO</p> <p>FORD P100 1.8TD - 2.0 (1987 A 1992)</p> <p>d62x200mm 1f-d37mm 1f-d10mm</p>		<p><b>F4022</b> NO. 1568353</p> <p>FOLE DA DIRECÇÃO ESQUERDO</p> <p>FORD P100</p> <p>d65x140mm 1f-d48mm 1f-d10mm</p>
	<p><b>F4023</b> NO. 1568355</p> <p>FOLE DA DIRECÇÃO DIREITO</p> <p>FORD P100</p> <p>d62x210mm d44mm 1f-d27mm 1f-d10mm</p>		<p><b>KF1810</b> NO. 1638320 - 6043191 - 1073846 - 98AX.4A084.BA - 77TT3A331FA</p> <p>FOLE DO LADO DA RODA (DIAM. 78mm)</p> <p>FORD P100 PICK-UP</p> <p>d93x103mm 1f-d20mm 1f-d78mm</p>
	<p><b>L3032</b> NO. 92PT5718</p> <p>CASQUILHO MOLAS TRÁS OLHAL TRÁS (PEQUENO)</p> <p>FORD P100</p> <p>d37x26mm c14mm 1f-d1.5mm</p>		<p><b>L3033</b> NO. 92PT5719</p> <p>CASQUILHO MOLAS TRÁS OLHAL TRÁS (GRANDE)</p> <p>FORD P100</p> <p>d38x54mm d29.5mm 1f-d12mm</p>
	<p><b>L3043</b> NO. 1481463 - 71BB.5K498.BB</p> <p>CASQUILHO DAS PONTAS DA BARRA ESTABILIZADORA</p> <p>FORD P100</p> <p>d28x42mm 1f-d10mm</p>		<p><b>RT08600</b> NO. 6125634 - 1638393 - 1666247 - 1666460</p> <p>TUBO DE TRAVÃO TRÁS LH-RH</p> <p>FORD P100 TT (01-1998 A 1994)</p> <p>355mm MC11 - MC40</p>
	<p><b>RT08691</b> NO. 6149181 - 6577425 - 92VB2282AA</p> <p>TUBO DE TRAVÃO TRÁS LH-RH</p> <p>FORD P100 TT (01-1998 A 1994)</p> <p>420mm EF297 - FC3</p>		<p><b>S1239</b> NO. 92PT5719AA - 88PB.5781.AA - 1646319</p> <p>SILENT-BLOC DAS MOLAS DE TRÁS (PARTE DA FRENTE)</p> <p>FORD P100</p> <p>d38x73mm c60mm 1f-d12mm</p>
	<p><b>S1240</b> NO. 90PT5K570AA - 88PB5719AA - 1646309</p> <p>SILENT-BLOC DAS MOLAS DE TRÁS (PARTE DA FRENTE)</p> <p>FORD P100</p> <p>d30x72mm c57mm 1f-d12mm</p>		<p><b>S1241</b> NO. 90PT5L021AA - 1626132</p> <p>SILENT-BLOC DO MOTOR PARTE SUPERIOR</p> <p>FORD P100</p> <p>d70x74mm 1f-d12mm</p>

## FORD P100

Rafpi, Lda.

	<b>S1242</b>	NO. 90PT5A103AA - 1610788		<b>S1384</b>	NO. 72GB3068AC - 1520587
	SILENT-BLOC DO MOTOR PARTE INFERIOR FORD P100			SILENT-BLOC DO BRAÇO DA SUSPENSÃO DA FRENTE PARTE SUPERIOR FORD P100	
d65x67mm		1f-d12mm	d45x42mm		d32mm 1f-d14mm
	<b>S1417</b>	NO. 6009976 - 74BB.3069.AB			
	SILENT BLOC DO BRAÇO DA SUSPENSÃO DA FRENTE PARTE INFERIOR FORD P100				
d32x69mm		d30 - 5mm 1f-d12mm			

## FORD PROBE

	<b>M6047</b>	NO. 3884326 - 3728338 - 6130841 - 852803 - 94328352 - 30879938 - 0K2K140305 - 0K52Y40305 - 6692742 - 206...		<b>M6088</b>	NO. 3728332
	JUNTA DE ESCAPE FORD PROBE (APÓS 1993)			JUNTA DE ESCAPE FORD PROBE (APÓS 1993)	
118x80mm		1f-d67mm	d68x15mm		1f-d54mm
	<b>M6089</b>	NO. 3250969 - 3846629			
	JUNTA DE ESCAPE FORD PROBE (APÓS 1993)				
108x68x1.5mm		1f-d58mm			

## FORD RANGER

	<b>A1497</b>	NO.		<b>A1663</b>	NO. UH74-39-33X
	APOIO DO VEIO DA TRANSMISSÃO FORD RANGER			APOIO DO MOTOR PARTE DE TRÁS FORD RANGER 4WD	
190x115x65mm		1f-d30mm	47x39x32mm		2p-d10-24mm
	<b>A1664</b>	NO. UH74-39-34X		<b>A1674</b>	NO. 3M346038AA
	APOIO DO MOTOR FORD RANGER 4WD			APOIO DO MOTOR PARTE DA FRENTE FORD RANGER 4WD	
111x66x44mm		2p-d10-22mm	110x55x43mm		2p-d10-22mm



	<p><b>A1742</b> NO. UH74-34-110</p> <p>APOIO BATENTE DA SUSPENSÃO DA FRENTE INFERIOR</p> <p>FORD RANGER 4WD</p>		<p><b>A1895</b> NO. 5031497</p> <p>APOIO DA TRANSMISSÃO</p> <p>FORD RANGER (ER - EQ) 2.5 TD Pick-up (04-2002 A 06-2006) 84CV 2500CC - FORD RANGER (ER - EQ) 2.5 TD 4x4 Pick-up (04-2002 A 06-2006) 84CV 2500CC - FORD RANGER (ER - EQ) 2.5 TD 4x4 Pick-up (10-1999 A 06-2006) 109CV 2500CC</p>
	<p><b>KF2362-T</b> NO. 4119973 - 4371800 - 4410860 - 2T144A084AA - 1603232 - 1603278</p> <p>KIT DE FOLE DO CARDAN JUNTO À RODA</p> <p>FORD RANGER (APÓS 1999) 2.5D</p>		<p><b>L3147</b> NO. 1729345 - UH7128470</p> <p>CASQUILHO SUPERIOR MOLA LAMINA TRÁS</p> <p>FORD RANGER (TKE) 2.2 TDCi (A Partir de 04.11) 120cv 2198cc Pick-up - FORD RANGER (TKE) 2.2 TDCi (A Partir de 04.11) 125cv 2198cc Pick-up - FORD RANGER (TKE) 2.2 TDCi 4x4 (A Partir de 04.11) 125cv 2198cc Pick-up - FORD RANGER (TKE) 2.2 TDCi (A Partir de 05.15) 131cv 2198cc Pick-up - FORD RANGER (TKE) 2.2 TDCi 4x4 (A Partir de 05.15) 131cv 2198cc Pick-up - FORD RANGER (TKE) 2.2 TDCi 4x4 (A Partir de 04.11) 150cv 2198cc Pick-up - FORD R...etc.</p>
	<p><b>L3148</b> NO. 1729347 - UH7128480</p> <p>CASQUILHO INFERIOR MOLA LAMINA TRÁS</p> <p>FORD RANGER (TKE) 2.2 TDCi (A Partir de 04.11) 120cv 2198cc Pick-up - FORD RANGER (TKE) 2.2 TDCi (A Partir de 04.11) 125cv 2198cc Pick-up - FORD RANGER (TKE) 2.2 TDCi 4x4 (A Partir de 04.11) 125cv 2198cc Pick-up - FORD RANGER (TKE) 2.2 TDCi (A Partir de 05.15) 131cv 2198cc Pick-up - FORD RANGER (TKE) 2.2 TDCi 4x4 (A Partir de 05.15) 131cv 2198cc Pick-up - FORD RANGER (TKE) 2.2 TDCi 4x4 (A Partir de 04.11) 150cv 2198cc Pick-up - FORD R...etc.</p>		<p><b>S1373</b> NO. 3665627 - XM343A493AA</p> <p>SILENT-BLOC DO BRAÇO DA SUSPENSÃO DA FRENTE PARTE INFERIOR</p> <p>FORD RANGER APÓS 1998</p>
	<p><b>S1419</b> NO. UH71-34-470 - 3665685 - XM34.3069.BA</p> <p>SILENT-BLOC DO BRAÇO DA SUSPENSÃO DA FRENTE PARTE SUPERIOR</p> <p>FORD RANGER (4WD)</p>		<p><b>S1422</b> NO. 3871868 - 4441372 - 4521291 - 1451499</p> <p>SILENT-BLOC DO BRAÇO DA SUSPENSÃO DA FRENTE PARTE INFERIOR</p> <p>FORD RANGER (4WD)</p>
	<p><b>S1543</b> NO. 1456059 - 6M343069BA</p> <p>SILENT-BLOC DO BRAÇO SUPERIOR DA SUSPENSÃO DA FRENTE</p> <p>FORD RANGER (ES - ET) 2.5 TDCi 4x4 Pick-up (05.06 A 07.12) 143CV 2499CC - FORD RANGER (ES - ET) 3.0 TDCi Pick-up (05.06 A 07.12) 156CV 2953CC - FORD RANGER (ES - ET) 3.0 TDCi 4x4 Pick-up (05.06 A 07.12) 156CV 2953CC - FORD RANGER (TKE) 2.2 TDCi Pick-up (APÓS</p>		<p><b>S1554</b> NO. UR5828450A</p> <p>SILENT-BLOC DO BRAÇO DA SUSPENSÃO DA FRENTE</p> <p>FORD RANGER (ES - ET) 2.5 TDCi 4x4 Pick-up (05.06 A 07.12) 143CV 2499CC - FORD RANGER (ES - ET) 3.0 TDCi 4x4 Pick-up (05.06 A 07.12) 156CV 2953CC</p>
	<p><b>W5116</b> NO. 1226639 - 1329202 - 1377588 - 1675115 - 1708966 - 4C106B319AA - 4C106B319BA - 9C106B319AA - 9C106B319BA</p> <p>POLIE DA CAMBOTA (7 PISTAS)</p> <p>FORD RANGER (TKE) 2.2 TDCi (APÓS 04-2011) 120CV 2198CC - FORD RANGER (TKE) 2.2 TDCi (APÓS 04-2011) 125CV 2198CC - FORD RANGER (TKE) 2.2 TDCi 4x4 (APÓS 04-2011) 125CV 2198CC - FORD RANGER (TKE) 2.2 TDCi 4x4 (APÓS 04-2011) 150CV 2198CC</p>		





FORD SCORPIO-SIERRA-SAPPHIRE-TAUNUS

	<p><b>A0405</b> NO. 11550756 - 1454274 - 711F.6038.AA - 1470480</p> <p>SUPORTE DO MOTOR</p> <p>FORD TAUNUS 17M</p>		<p><b>A1381</b> NO. 6141919 - 83BB.5K817.BA - 6094239 - 6120493 - 6122229</p> <p>APOIO AS SUSPENSÃO DE TRÁS</p> <p>FORD SIERRA - SCORPIO (APÓS 1982)</p>
	<p>d75x38mm 1p-d10-23mm 1p-d10-23mm</p>		<p>d100x85mm 1f-d13mm</p>

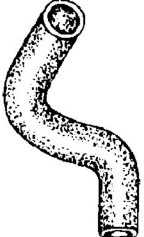
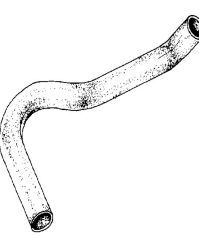
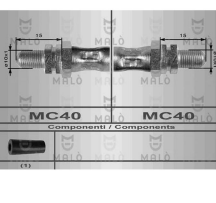
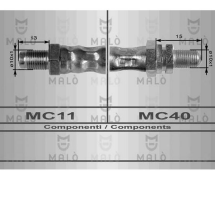

	<p><b>A1389</b> NO. 6155997 - 85GB 6068AA - 85GB.6068.AA - 6165106</p> <p>APOIO DA CAIXA DE VELOCIDADES</p> <p>FORD SIERRA (1985 A 1988) - SCORPIO (1985 A 1988)</p> <p>167x110x56mm 2f-d8mm 1f-d13x18mm</p>		<p><b>D0012</b> NO. 72GG4684BA</p> <p>CARDAN DA TRANSMISSÃO</p> <p>FORD SIERRA 2.0 (1987 A 1993) - 2.0 16V COSWORTH 4x4 CAT (1990 A 1993)</p> <p>146x146x46mm 6f-12mm</p>
	<p><b>D0036</b> NO. 1563500 - 76BG4684AA</p> <p>CARDAN TRANSMISSÃO</p> <p>FORD SIERRA Hatchback (GBC) 1.3 (08.82 A 12.86) 60cv 1294cc Hatchback</p> <p>110x110x35x43mm 6f-12x12mm</p>		<p><b>D0036</b> NO. 1563500 - 76BG4684AA</p> <p>CARDAN TRANSMISSÃO</p> <p>FORD TAUNUS 12M (11G) 1.3 (08.66 A 06.71) 50cv 1305cc três volumes - FORD TAUNUS 12M Turnier (15G) 1.3 (09.66 A 06.71) 50cv 1305cc Combi - FORD TAUNUS 12M Coupé (13G) 1.3 (08.66 A 06.71) 50cv 1305cc Coupé</p> <p>110x110x35x43mm 6f-12x12mm</p>
	<p><b>D0037</b> NO. 1515117 - 1638947 - 6518778 - 83BG4684BA - 83GB4684BA - 88GG4684BA - GAF41</p> <p>CARDAN TRANSMISSÃO</p> <p>FORD SCORPIO I (GAE, GGE) 2.0 Ano fabric. até: 05.89, (04.85 A 08.89) 105cv 1993cc Hatchback - FORD SCORPIO I (GAE, GGE) 2.0 i (02.92 A 09.94) 115cv 1993cc Hatchback - FORD SCORPIO I (GAE, GGE) 2.0 i Ano fabric. até: 05.89, (05.89 A 09.94) 120cv 1998cc Hatchback - FORD SCORPIO I (GAE, GGE) 2.4 i (10.88 A 02.92) 125cv 2394cc Hatchback - FORD SCORPIO I (GAE, GGE) 2.4 i Ano fabric. até: 06.88, (09.86 A 09.88) 130cv 2394cc Hatchback - FO...etc.</p> <p>120x135x40x46mm 6f-12x12mm</p>		<p><b>D0037</b> NO. 1515117 - 1638947 - 6518778 - 83BG4684BA - 83GB4684BA - 88GG4684BA - GAF41</p> <p>CARDAN TRANSMISSÃO</p> <p>FORD SIERRA Hatchback (GBC, GBG) 2.0 Ano fabric. a part ir de: 08.90, CÂºdigo do mot or: 2,0 HC, Tipo t rans.: Traco integral (01.87 A 02.93) 105cv 1993cc Hatchback - FORD SIERRA Hatchback (GBC, GBG) 2.0 i DOHC Ano fabric. a part ir de: 06.92, (12.91 A 02.93) 115cv 1998cc Hatchback - FORD SIERRA Hatchback (GBC, GBG) 2.0 i Ano fabric. a part ir de: 08.90, (06.89 A 02.93) 120cv 1998cc Hatchback - FORD SIERRA Hatchback (GBC, GBG) 2.0 i...etc.</p> <p>120x135x40x46mm 6f-12x12mm</p>
	<p><b>E0010</b> NO. 6048886 - 6053849 - 6111692 - 77FB5A262CA - 77FB5A262BD</p> <p>ESTICADOR DE ESCAPE</p> <p>FORD SIERRA (1.3-1.6-2.0) - SIERRA DIESEL - SIERRA (APS 82) - SCORPIO (APS 85)</p> <p>73x47x38mm NULL</p>		<p><b>E0012</b> NO. 553769 - 69AB5281BA - 6030483</p> <p>ESTICADOR DE ESCAPE</p> <p>FORD SIERRA (1.3-1.6-2.0) - SIERRA DIESEL (1987 A 1993) - FORD SCORPIO (1985 A 1994)</p> <p>d47x42mm NULL</p>
	<p><b>E0012</b> NO. 553769 - 69AB5281BA - 6030483</p> <p>ESTICADOR DE ESCAPE</p> <p>FORD TAUNUS (70-83)</p> <p>d47x42mm NULL</p>		<p><b>E0023</b> NO. 6120254 - 6136012 - 6122002 - 81AB5A262AC - 83BB5A262HA - 6162002 - 6111691</p> <p>ESTICADOR DE ESCAPE</p> <p>FORD SIERRA (1.3-1.6-2.0) - SIERRA DIESEL (2.3) - SCORPIO (APS 89)</p> <p>92x58x38mm NULL</p>
	<p><b>F0687-I</b> NO. 1610365 - 83BB3K661AA - 1160365</p> <p>FOLE DA DIRECO</p> <p>FORD SIERRA MANUAL (1982 A 1986) - SCORPIO (APS 1985)</p> <p>d60x230mm 1f-d48mm 1f-d10mm</p>		<p><b>F0687-I</b> NO. 1610365 - 83BB3K661AA - 1160365</p> <p>FOLE DA DIRECO</p> <p>FORD SIERRA MANUAL (1982 A 1986) - SCORPIO (APS 1985)</p> <p>d60x230mm 1f-d48mm 1f-d10mm</p>
	<p><b>F1081-I</b> NO. 617346 - 617347 - 1610365 - 84AB.3K661.AA</p> <p>FOLE DA DIRECO</p> <p>FORD SIERRA (1982 A 1986)</p> <p>d60x230mm 1f-d48mm 1f-d10mm</p>		<p><b>F1081-I</b> NO. 617346 - 617347 - 1610365 - 84AB.3K661.AA</p> <p>FOLE DA DIRECO</p> <p>FORD SIERRA (1982 A 1986)</p> <p>d60x230mm 1f-d48mm 1f-d10mm</p>
	<p><b>F1087-I</b> NO. 1627950</p> <p>FOLE DA TRANSMISSO LADO DA CAIXA</p> <p>FORD SCORPIO 2.8 4WD (1985 A 1998) - SIERRA 4WD 2.0i - 2.8i - 2.9i - (1982 A 1993)</p> <p>d82x116 1f-d64mm 1f-d18mm</p>		<p><b>F1668-I</b> NO. 1619061 - 83BB.3K661.BD</p> <p>FOLE DA DIRECO DIREITO E ESQUERDO</p> <p>FORD SIERRA 1.3 - 1.6 - 1.8 - 1.8TD (1982 A 1993) - FORD SCORPIO 1.8 - 2.0 - 2.0i - 2.4i - 2.5D - 2.5TD - 2.8i - 2.9i (1985 A 1994)</p> <p>d62x200mm 1f-d37mm 1f-d10mm</p>

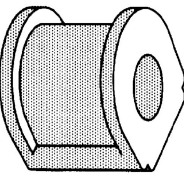
	<p><b>F4023</b> NO. 1568355</p> <p>FOLE DA DIREÇÃO DIREITO</p> <p>FORD TAUNUS 12M 1.3 (1966 A 1971)</p>		<p><b>F4037</b> NO. 4059921 - YC153K661AA</p> <p>FOLE DA DIREÇÃO LADO DIREITO E ESQUERDO</p> <p>FORD SIERRA 1.6 82-86</p>
	<p><b>KF1810</b> NO. 1638320 - 6043191 - 1073846 - 98AX.4A084.BA - 77TT3A331FA</p> <p>FOLE DO LADO DA RODA (DIAM. 78mm)</p> <p>FORD SCORPIO - SIERRA - SAPPHIRE 4x4</p>		<p><b>L1044</b> NO. 1619120 - 81AB.3063.BB</p> <p>CASQUILHO INTERNO DO BRAÇO DA SUSPENSÃO</p> <p>FORD SIERRA (8-1982 A 12-1986)</p>
	<p><b>L3041</b> NO. 6005983 - 74BB.3B197.AA</p> <p>CASQUILHO DA BARRA ESTABILIZADORA</p> <p>FORD TAUNUS (1976 A 1992)</p>		<p><b>L3043</b> NO. 1481463 - 71BB.5K498.BB</p> <p>CASQUILHO DAS PONTAS DA BARRA ESTABILIZADORA</p> <p>FORD SIERRA</p>
	<p><b>L3043</b> NO. 1481463 - 71BB.5K498.BB</p> <p>CASQUILHO DAS PONTAS DA BARRA ESTABILIZADORA</p> <p>FORD TAUNUS</p>		<p><b>M6031</b> NO. 6159188 - 6615274 - 6157398</p> <p>JUNTA DE ESCAPE</p> <p>FORD SCORPIO (1985 A 1994) - SIERRA (1984 A 1994)</p>
	<p><b>M6037</b> NO. 6065962 - 1565558 - 6115136 - 6134623 - 6615275 - 6134622 - 81AB9451AA</p> <p>JUNTA DE ESCAPE</p> <p>FORD SCORPIO (1985 A 1989) - SIERRA (1982 A 1992)</p>		<p><b>M6043</b> NO. 6134624 - 6120664 - 1630835 - 6120644 - 6163389</p> <p>JUNTA DE ESCAPE</p> <p>FORD SIERRA (1986 A 1994)</p>
	<p><b>M6055</b> NO. 6172323</p> <p>JUNTA DE ESCAPE</p> <p>FORD SCORPIO (1985 A 1994) - SIERRA (1984 A 1994)</p>		<p><b>M6069</b> NO. 6645622</p> <p>JUNTA DE ESCAPE</p> <p>FORD SIERRA (1987 A 1989)</p>
	<p><b>M6079</b> NO. 6027648 - 1709852 - 749451BA</p> <p>JUNTA DE ESCAPE</p> <p>FORD TAUNUS (1976 A 1985)</p>		<p><b>M6101</b> NO. 6158920 - 11621317264 - 9004430225 - 9004430270 - 9004430224 - 6579536 - 854954 - GEX7763 - DAR1816 ...</p> <p>JUNTA DE ESCAPE</p> <p>FORD SIERRA DIESEL (1982 A 1993) - SCORPIO DIESEL (1985 A 1992)</p>
	<p><b>M6102</b> NO. 6162279 - 6692744 - 6642511 - 6159982</p> <p>JUNTA DE ESCAPE</p> <p>FORD SCORPIO (1986 A 1994) - SIERRA (1988 A 1994)</p>		<p><b>R220522</b> NO. 6112785</p> <p>TUBO DE RADIADOR SUPERIOR</p> <p>FORD SIERRA 2.0 (1982 A 1993)</p>

	<b>R220523</b> NO. 6098166 TUBO DE RADIADOR INFERIOR FORD SIERRA 2.0 (1982 A 1993)  B250-d33/33mm 160-95-90mm		<b>R2472</b> NO. 6123800 - 6123124 - M-220520 TUBO SUPERIOR DO RADIADOR FORD SIERRA-1300-1600  B400-d31/31mm 225-120-140-70mm
	<b>RT08565</b> NO. 6179304 - 6714710 - 1027745 - 6132910 - 91FB2282AA TUBO DE TRAVÃO TRÁS LH-RH FORD SIERRA TT (07-1982 A 02-1993)  340mm MC40 - MC40		<b>RT08600</b> NO. 6125634 - 1638393 - 1666247 - 1666460 TUBO DE TRAVÃO TRÁS LH-RH FORD SIERRA TT (08-1985 a 02-1993)  355mm MC11 - MC40
	<b>S1197</b> NO. 5021729 - 6122507 - 6129161 - 6144628 - 1656752 - 85GB.5493.AB - 85GB.5493.BA - 88GB.5493.AA - 88GB... SILENT-BLOC CENTRAL DO BRAÇO DA SUSPENSÃO DIANTEIRO FORD SIERRA (1982 A 1993)  d65x48mm c23mm d4+E33758mm 1f-d16mm		<b>T0003</b> NO. 204460 - 0204460 BATENTE DA BARRA ESTABILIZADORA FORD TAUNUS  41x39x36mm 1f-d18mm
	<b>T1051</b> NO. 6714195 BATENTE DO CENTRO DA BARRA ESTABILIZADORA (FURO DIÂMETRO 20mm) FORD SCORPIO 2.0i 16V - 2.0i - 2.5TD - 2.9i 24V - 2.9i (1994 A 1998)  43x39x30mm 1f-d20mm		<b>W5135</b> NO. 6186295 POLIE DA CAMBOTA 4 PISTAS FORD SIERRA Hatchback (GBC - GBG) 1.8 TD (08.88 A 02.93) 75cv 1753cc Hatchback - FORD SIERRA (GBG - GB4) 1.8 TD (08.88 A 02.93) 75cv 1753cc três volumes - FORD SIERRA Combi (BNG) 1.8 TD (08.88 A 02.93) 75cv 1753cc Combi  d120/130mm d20,6mm

## FORD TOURNEO-TOURNEO CONNECT

	<b>A1830</b> NO. 1351703 - 1201167 - 2T1Q9A39AA - 2T1Q9A393AB - 2T1Q.9A393.AA APOIO DO RADIADOR DO AR DE SOBREALIMENTAÇÃO FORD TOURNEO CONNECT 1.8 TDCi /TDDi /DI (06.02 - 12.13) 75cv 1753cc - FORD TOURNEO CONNECT 1.8 TDCi (06.02 - 12.13) 90cv 1753cc - FORD TOURNEO CONNECT 1.8 TDCi (08.06 - 12.13) 110cv 1753cc - FORD TRANSIT CONNECT (P65_ - P70_ - P80_) 1.8 Di Caixa (06.02 - 12  d20x14mm 2p-d6x10mm		<b>A1926</b> NO. 1112025 - YS416038BA - 98AB6038DG - 98AB6038DH - 1S416038BA - 1072572 - 1102456 - 11102572 APOIO MOTOR LADO DIREITO FORD TOURNEO CONNECT 1.8 16V (06.02 A 12.13) 116cv 1796cc Veículo multiuso  120x120x100mm 1p-d12x38mm
	<b>E1028</b> NO. 7092700 - 95VB.5A262.BA SUPORTE DE ESCAPE FORD TOURNEO (1994 A 1996)  82x75x25mm 3f-d10mm		<b>KF1686-T</b> NO. 4371800 - 2T144A084AA - 1603232 - 1603278 - 4410860 KIT DE FOLIE DO CARDAN JUNTO À RODA FORD TOURNEO CONNECT 1.8 Di (APÓS 2002)  d105x130mm 1f-d90mm 1f-d27mm
	<b>KF9011</b> NO. 2T144A084AA - 4371800 - 1603232 - 1603278 - 4410860 - 4371801 - 2T144A084BA KIT DE FOLIE DO CARDAN JUNTO À RODA E CAIXA FORD TOURNEO CONNECT 1.8Di (APÓS 2002)  d102x125mm d92x85mm 1f-d92mm 1f-d25mm 1fd82mm 1f-d25mm		<b>KF9012</b> NO. 2T144A084DA - 4371804 - 2T14.4A084.AA KIT DE FOLIE DO CARDAN JUNTO À CAIXA FORD TOURNEO CONNECT 1.8Di (APÓS 2002)  d93x85mm 1f-d86mm 1f-d21mm

	<p><b>KF9024</b> NO. 4371804 - 4371803 - 2T144A084AA</p> <p>KIT DE FOLE TRANSMISSÃO JUNTO CAIXA</p> <p>FORD TOURNEO CONNECT 1.8 TDCi /TDDi /DI (06.02 - 12.13) 75cv 1753cc Veículo multiuso</p>		<p><b>M6057</b> NO. 6797187 - 6692784 - 6993854</p> <p>JUNTA DE ESCAPE</p> <p>FORD TOURNEO D (1994 A 1996)</p>
	<p><b>RT80261</b> NO. 4447742 - 4370933</p> <p>TUBO DE TRAVÃO TRÁS LH-RH (SEM ABS)</p> <p>FORD TOURNEO CONNECT TT (APÓS 06-2002)</p>		<p><b>RT80354</b> NO. 4447381</p> <p>TUBO DE TRAVÃO FRENTE LH-RH</p> <p>FORD TOURNEO CONNECT 1.8 16V (APÓS 06-2002) - TOURNEO CONNECT 1.8 Di (APÓS 06-2002) - TOURNEO CONNECT 1.8 TURBO Di (APÓS 06-2002)</p>
	<p><b>S1385</b> NO. 2T1418016AA - 4410223</p> <p>SILENT-BLOC DOS AMORTECEDORES</p> <p>FORD TOURNEO CONNECT</p>		<p><b>S1386</b> NO. 2T145791AA - 4408458</p> <p>SILENT-BLOC DAS MOLAS DE TRÁS OLHAL DE TRÁS</p> <p>FORD TOURNEO CONNECT</p>
	<p><b>S1387</b> NO. 2T145781AA - 4367046</p> <p>SILENT-BLOC DAS MOLAS DE TRÁS OLHAL FRENTE</p> <p>FORD TOURNEO CONNECT</p>		<p><b>S1388</b> NO. 2T145719BA - 4367044 - 4418511 - 4401266</p> <p>SILENT-BLOC DAS MOLAS TRÁS OLHAL DE TRÁS</p> <p>FORD TOURNEO CONNECT</p>
	<p><b>S1389</b> NO. 2T143063AA - 4366976</p> <p>SILENT-BLOC DO BRAÇO DA SUSPENSÃO DA FRENTE PARTE INFERIOR</p> <p>FORD TOURNEO CONNECT</p>		<p><b>T0609-I</b> NO. 2T145K570BC - 4411872 - 2T145K570B - 2T145K570BA - 2T145K570BB - 4379529 - 1344760 - 4T165K570AA - 4...</p> <p>BATENTE DA SUSPENSÃO DE TRÁS</p> <p>FORD TOURNEO CONNECT (APÓS 2002)</p>
	<p><b>T1097</b> NO. 2T144A037AC - 4419557 - 2T144037AC - 4379900</p> <p>BATENTE DA BARRA ESTABILIZADORA DE TRÁS</p> <p>FORD TOURNEO CONNECT (APÓS 2002)</p>		<p><b>T1098</b> NO. 2T145484BD - 4419559 - 4964972 - 2T14.5484.CA - 4385316</p> <p>BATENTE DA BARRA ESTABILIZADORA DA FRENTE</p> <p>FORD TOURNEO CONNECT (APÓS 2002)</p>
	<p><b>T1137</b> NO. 1892603 - BK215484AC</p> <p>BATENTE BARRA ESTABILIZADORA FRENTE</p> <p>FORD TOURNEO CUSTOM Autocarro 2.0 TDCi (A Partir de 12.15) 105cv 1995cc Autocarro - FORD TOURNEO CUSTOM Autocarro 2.0 TDCi (A Partir de 12.15) 130cv 1995cc Autocarro - FORD TOURNEO CUSTOM Autocarro 2.0 TDCi (A Partir de 12.15) 170cv 1995cc Autocarro - FORD TOURNEO CUSTOM Autocarro 2.2 TDCi (A Partir de 04.12) 100cv 2198cc Autocarro - FORD TOURNEO CUSTOM Autocarro 2.2 TDCi (A Partir de 04.12) 125cv 2198cc Autocarro - FORD TOURNEO CUSTOM ...etc.</p>		<p><b>W5035</b> NO. 1135052</p> <p>POLIE DA CAMBOTA (6 PISTAS)</p> <p>FORD TOURNEO CONNECT 1.8 16V (APÓS 06-2002)</p>
	<p><b>W5113</b> NO. 1434432 - 1386188 - 1539837 - 1723700 - 6C106B319AF - BU306B319AA - 6C106B319AD - 6C106B319AE</p> <p>POLIE DA CAMBOTA (6+4 PISTAS)</p> <p>FORD TOURNEO CUSTOM Autocarro - 2.2 TDCi 100CV 2198cc (APÓS 12-2012) - 125CV 2198cc (APÓS 12-2012) - 155CV 2198cc (APÓS 12-2012) - 100CV 2198cc (APÓS 12-2012) - 125CV 2198cc (APÓS 12-2012) - 155CV 2198cc (APÓS 12-2012)</p>		

	<p><b>A0125</b> NO. 6177036 - 88VB6068AB - 1045715</p> <p>APOIO DA CAIXA</p> <p>FORD TRANSIT (1.6- 2.0) - TRANSIT DIESEL (2.4- 2.5)</p> <p>130x90x70mm 2p-d10-25mm 2p-d10-25mm</p>		<p><b>A0139</b> NO. 72GB8125AA - 1519545</p> <p>APOIO DO RADIADOR</p> <p>FORD TRANSIT (APÓS 1984)</p> <p>d25x20mm 1p-d6-18mm 1p-d6-18mm</p>
	<p><b>A0405</b> NO. 11550756 - 1454274 - 711F.6038.AA - 1470480</p> <p>SUPORTE DO MOTOR</p> <p>FORD TRANSIT GASOLINA (1977 A 2000)</p> <p>d75x38mm 1p-d10-23mm 1p-d10-23mm</p>		<p><b>A0532</b> NO.</p> <p>SUPORTE DO MOTOR</p> <p>FORD TRANSIT PERKINS</p> <p>102x52x44mm 1p-d9-16mm</p>
	<p><b>A0960</b> NO. 1454275 - 1515124 - 72HF.6068.AB - 72HF6068AA - 711F6068AB</p> <p>SUPORTE TRÁS DO MOTOR</p> <p>FORD TRANSIT 1.6 - 2.0 (1985 A 1994) - TRANSIT DIESEL 2.4 - 2.5 (1977 A 1986)</p> <p>166x97x55mm 1f-d13mm</p>		<p><b>A0988</b> NO.</p> <p>SUPORTE DA TRANSMISSÃO</p> <p>FORD TRANSIT F32 CAIXA ABERTA (1980 A 1986)</p> <p>117x112x47mm d64mm</p>
	<p><b>A0997</b> NO. 6152795 - 7055286 - 86VB.6038.BB</p> <p>SUPORTE FRENTE DO MOTOR</p> <p>FORD TRANSIT DIESEL 2.4 (1977 A 1986)</p> <p>d90x57mm 1p-d10-26mm 1p-d10-26mm</p>		<p><b>A1337D</b> NO. 95VB6038BF - 7354179 - 7280607 - 7128520 - 7240354 - 95VB6038BE - 95VB6038BC - 95VB6038BD</p> <p>APOIO DIREITO DO MOTOR</p> <p>FORD TRANSIT 2.5 TD (1992 A 1994) - 2.5D (1983 A 1992) - 2.5Di (1991 A 2000)</p> <p>d103x92mm 1p-d12-32mm 1p-d12-55mm</p>
	<p><b>A1338E</b> NO. 95VB6B032BD - 7354180 - 7240357 - 7280608 - 95VB6B032BC - 95VB6B032BB</p> <p>APOIO ESQUERDO DO MOTOR</p> <p>FORD TRANSIT 2.5 TD (1992 A 1994) - 2.5D (1983 A 1992) - 2.5Di (1991 A 2000)</p> <p>d103x92mm 1p-d12-32mm 1p-d12-55mm</p>		<p><b>A1339</b> NO. 92VB3K155AA - 92VB5349-AB - 6763456 - 92VB.3K155.AD - 6675788</p> <p>APOIO DO AMORTECEDOR DA FRENTE DIREITO E ESQUERDO</p> <p>FORD TRANSIT 2.5 TD (1992 A 2000) - 2.5D (1983 A 1992) - 2.5Di (1991 A 2000)</p> <p>142x130x45mm 3p-d10-32mm 1f-d11.5mm</p>
	<p><b>A1340</b> NO. 88VB4826 - 6635542 - 4060617 - 4104708 - 7239265 - 8C11.4826.AB - 95VB.4826.AA - 99VB.4826.AB - YC1W...</p> <p>APOIO DA TRANSMISSÃO</p> <p>FORD TRANSIT 2.5 Di (1991 A 2000) - 2.5D (1983 A 1992) - 2.5TD (1992 A 1994)</p> <p>175x120x50mm 1f-d30mm</p>		<p><b>A1341</b> NO. 924F4826 - 6649122 - 6649122S2 - T128995 - 1447370 - 92VB.4826.BB - 98VB.4826.A1B - 95VB4826AA - 98V...</p> <p>APOIO DA TRANSMISSÃO</p> <p>FORD TRANSIT 2.5 TD (1992 A 2000) - 2.5Di (1991 A 2000) - 2.5D (1983 A 1992)</p> <p>180x125x49mm 1f-d45mm</p>
	<p><b>A1342</b> NO. 6111851 - 84VB.8124AA</p> <p>APOIO DO RADIADOR</p> <p>FORD TRANSIT 2.5D (ATÉ 1986)</p> <p>d44x48mm d23.5mm d20mm 1f-d7mm</p>		<p><b>A1347</b> NO.</p> <p>SEPARADOR DAS MOLAS</p> <p>FORD TRANSIT (APÓS 1986)</p> <p>d41x100mm NULL</p>
	<p><b>A1351</b> NO. 2400E-3020 - 2400E40444</p> <p>APOIO BATENTE DO CHASSIS</p> <p>FORD TRANSIT TR</p> <p>105x80x45mm NULL</p>		<p><b>A1379</b> NO. 6163548 - 88VB4K080AA - 88VB.4826.AA - T105472 - 440890 - 0440890 - 1596242 - 6163548</p> <p>APOIO DA TRANSMISSÃO</p> <p>FORD TRANSIT 2.4 - 2.5 (1965 A 1985)</p> <p>160x100x72mm 1f-d30mm</p>











	<p><b>A1515</b> NO. 1330122 - 3C166068AA - YC15.6068.AA - YC1536068AF - 4059109</p> <p>APOIO DO MOTOR</p> <p>FORD TRANSIT V184 (2001)</p> <p>d50x34mm 2p-d18-15mm</p>		<p><b>A1568</b> NO. 4094280 - YC1518183AG - YC11.18183.AA - 5C11.18183.AA - 4041955 - 4053300 - 4070497 - 4360393 - 4766...</p> <p>APOIO SUPERIOR DO AMORTECEDOR DA FRENTE</p> <p>FORD TRANSIT 2.0Di (APÓS 08-2000) - 2.0 TDCi (APÓS 08-2002) - 2.4 Di (APÓS 2000) - 2.4 TDE (APÓS 07-2000) - 2.4 TDCi (APÓS 03-2004) - 2.5 Di (1997 A 2000)+F147</p> <p>d120x40mm 3p-d8-26mm</p>
	<p><b>A1595</b> NO. 7324691 - 948125 - 94BB.8125.BB - 6704254</p> <p>APOIO DO RADIADOR PARTE INFERIOR</p> <p>FORD TRANSIT V184 (2000 A 2006)</p> <p>d41x38mm 1f-d18-14mm</p>		<p><b>A1596</b> NO. 7324692 - 1354636 - 94BB.8125.CA</p> <p>APOIO DO RADIADOR PARTE SUPERIOR</p> <p>FORD TRANSIT V184 (2000 A 2006)</p> <p>d53x50mm d29mm 1f-d14mm</p>
	<p><b>A1820</b> NO. 1510905 - 1824066 - 8C114826AA</p> <p>APOIO DA TRANSMISSÃO</p> <p>FORD TRANSIT Autocarro 2.2 TDCi (04.06 - 08.14) 85cv 2198cc - FORD TRANSIT Autocarro 2.2 TDCi (04.06 - 08.14) 110cv 2198cc - FORD TRANSIT Autocarro 2.2 TDCi (10.08 - 08.14) 115cv 2198cc - FORD TRANSIT Autocarro 2.2 TDCi (04.06 - 08.14) 130cv 2198cc - FORD</p> <p>175x120x50mm 1f-d35mm</p>		<p><b>A1821</b> NO. YC156038AA - 3C166F014BA - YC156B014AF - YC156B014BC - 4638390 - 4409223 - 4055199</p> <p>APOIO BATENTE DA SUSPENSÃO</p> <p>FORD TRANSIT V184 (2001 A 2006)</p> <p>95x90x72mm 2p-d12x30mm</p>
	<p><b>A1826</b> NO. 1377973 - 1488960 - 6C1118183AB - 6C1118183AC - BK2118183AA</p> <p>APOIO DO AMORTECEDOR DA FRENTE DIREITO E ESQUERDO</p> <p>FORD TRANSIT Autocarro 2.2 TDCi (04.06 - 08.14) 85cv 2198cc - FORD TRANSIT Autocarro 2.2 TDCi (10.11 - 08.14) 100cv 2198cc - FORD TRANSIT Autocarro 2.2 TDCi [RWD] (10.11 - 08.14) 100cv 2198cc - FORD TRANSIT Autocarro 2.2 TDCi (04.06 - 08.14) 110cv 2198cc</p> <p>120x33mm 1f-d12mm 3p-d8x27mm</p>		<p><b>A1897</b> NO. 1461881 - 6005152 - 78VB6038AA</p> <p>APOIO DO MOTOR</p> <p>FORD TRANSIT Autocarro (V_) 2.4D (VAS - VBL - VIL - VUL - VZS) (12-1977 A 10-1986) 63CV 2358CC - FORD TRANSIT Caixa (V_) 2.4 D (VVS) (11-1977 A 10-1986) 63CV 2358CC - FORD TRANSIT Camião de plataforma/chassis (V_) 2.4 D (VGL - VSL - VTL - VCS - VDS) (11-1977</p> <p>d75x46mm 1p-d10x23mm 1p-d10x23mm</p>
	<p><b>A1923</b> NO. 1494924 - 6C116068CB - 1371180</p> <p>APOIO CAIXA VELOCIDADES</p> <p>FORD TRANSIT Autocarro (FD_ FB_ FS_ FZ_ FC_) 2.4 DI [RWD] (F_B_ F_C_) (01.00 - 05.06) 75cv 2402cc Autocarro - FORD TRANSIT Autocarro (FD_ FB_ FS_ FZ_ FC_) 2.4 DI (F_B_ F_C_ F_A_) (01.00 - 05.06) 90cv 2402cc Autocarro - FORD TRANSIT Autocarro (FD_ FB_ FS_ FZ_ FC_) 2.4 TDE (03.04 - 05.06) 115cv 2402cc Autocarro - FORD TRANSIT Autocarro (FD_ FB_ FS_ FZ_ FC_) 2.4 DI [RWD] (F_B_ F_C_ F_A_) (01.00 - 05.06) 120cv 2402cc Autocarro - FORD TRANSIT Autocarr...etc.</p> <p>170x80x65mm 2r-M10 1f-d10mm</p>		<p><b>A1926</b> NO. 1112025 - YS416038BA - 98AB6038DG - 98AB6038DH - 1S416038BA - 1072572 - 1102456 - 11402572</p> <p>APOIO MOTOR LADO DIREITO</p> <p>FORD TRANSIT CONNECT (P65_ P70_ P80_) 1.8 16V (06.02 A 12.13) 116cv 1796cc Caixa</p> <p>120x120x100mm 1p-d12x38mm</p>
	<p><b>C0231</b> NO. 6483712 - 91AB.16C618.AA</p> <p>BOTÃO DE AFINAÇÃO DE CAPOT</p> <p>FORD TRANSIT (APÓS 1992) - FORD TRANSIT CONNECT (APÓS 2002)</p> <p>d27x44mm NULL</p>		<p><b>C1003</b> NO. 96VTT302K41AA - 70AB.T302K41.AB - 1478341 - 96VTT032K419AA</p> <p>BOTÃO DE CAPOT</p> <p>FORD TRANSIT T12 - T15</p> <p>36x17x17mm NULL</p>
	<p><b>C1004</b> NO. 1583675 - 81AB16C618AA</p> <p>BOTÃO DE CAPOT</p> <p>FORD TRANSIT T12 - T15 (APÓS 1991)</p> <p>d30x18mm NULL</p>		<p><b>D0021</b> NO. 4393343 - YC1W4684AA</p> <p>CARDAN DA TRANSMISSÃO</p> <p>FORD TRANSIT V184 (APÓS 2001)</p> <p>d135x30mm 6f-d12mm</p>
	<p><b>D0037</b> NO. 1515117 - 1638947 - 6518778 - 83BG4684BA - 83GB4684BA - 88GG4684BA - GAF41</p> <p>CARDAN TRANSMISSÃO</p> <p>FORD TRANSIT Autocarro (T_) 2.0 Cat (TBS, TCL, TCS) Ano fabric. até: 10.88, (12.85 A 09.92) 78cv 1993cc Autocarro - FORD TRANSIT Caixa (T_) 2.0 (TAL, TAS, TGL, TWS) Ano fabric. até: 10.88, (09.85 A 09.92) 78cv 1994cc Caixa - FORD TRANSIT Caixa (T_) 2.5 D (TAL, TAS, TGL, TWS) (01.86 A 09.91) 68cv 2496cc Caixa - FORD TRANSIT Caixa (T_) 2.5 D (TAL, TAS, TGL, TWS) (10.88 A 09.91) 71cv 2496cc Caixa - FORD TRANSIT Camião de plataform...etc.</p> <p>120x135x40x46mm 6f-12x12mm</p>		<p><b>E0010</b> NO. 6048886 - 6053849 - 6111692 - 77FB5A262CA - 77FB5A262BD</p> <p>ESTICADOR DE ESCAPE</p> <p>FORD TRANSIT (1.6-2.0) - TRANSIT DIESEL(2.4-2.5)</p> <p>73x47x38mm NULL</p>

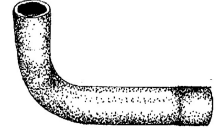



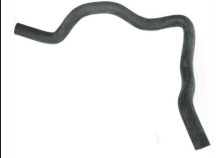
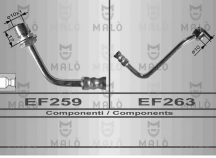
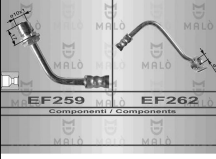
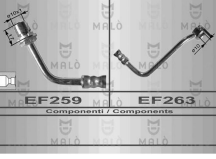

	<p><b>E0012</b> NO. 553769 - 69AB5281BA - 6030483</p> <p>ESTICADOR DE ESCAPE</p> <p>FORD TRANSIT (APÓS 84)</p> <p>d47x42mm NULL</p>		<p><b>E0023</b> NO. 6120254 - 6136012 - 6122002 - 81AB5A262AC - 93BB5A262HA - 6162002 - 6111691</p> <p>ESTICADOR DE ESCAPE</p> <p>FORD TRANSIT (APÓS 88)</p> <p>92x58x38mm NULL</p>
	<p><b>E0084</b> NO. 1099259 - 3736028 - 3933468 - 1099260 - 98VB.5K483.AA - YC155495AA - 4041494</p> <p>ESTICADOR DA BARRA ESTABILIZADORA DA FRENTE</p> <p>FORD TRANSIT (APÓS 1998) - V184 2001</p> <p>d31x200mm NULL</p>		<p><b>E0153</b> NO. 1495685 - 4519467 - 3C113B438AC - 3C113B438AD - BK21.3B438.AA - BK21.3B438.AC - 1763714</p> <p>ESTICADOR DA BARRA ESTABILIZADORA DE TRÁS</p> <p>FORD TRANSIT V184 (APÓS 2001)</p> <p>385x40x42mm 1p-d12-30mm 1f-d12mm</p>
	<p><b>E0156</b> NO. 1669212 - V92VB5C486AA</p> <p>ESTICADOR DA BARRA ESTABILIZADORA DE TRÁS</p> <p>FORD TRANSIT (1998 A 2000)</p> <p>250x42x40mm 2p-d12-33mm</p>		<p><b>E0261</b> NO. 4531299 - YC155C486AE - YC15.5C486.AF - 4346344 - 4709303 - 4440885</p> <p>ESTICADOR DA BARRA ESTABILIZADORA DA FRENTE</p> <p>FORD TRANSIT Autocarro (FD_ - FB_ - FS_ - FZ_ - FC_ ) - 2.0 DI (F_E_ - F_F_ - F_G_ ) Serie 330/350 (08.00 - 05.06) 75cv 1998cc - FORD - TRANSIT Autocarro (FD_ - FB_ - FS_ - FZ_ - FC_ ) - 2.0 DI (F_E_ - F_F_ - F_G_ ) Serie 330/350 (08.00 - 05.06) 86cv</p> <p>330x40x42mm 2p-d12x30mm</p>
	<p><b>E1028</b> NO. 7092700 - 95VB.5A262.BA</p> <p>SUPORE DE ESCAPE</p> <p>FORD TRANSIT (APÓS 1994)</p> <p>82x75x25mm 3f-d10mm</p>		<p><b>E1063</b> NO. 95VB5A262CA - 6866412</p> <p>ESTICADOR DE ESCAPE DO MEIO</p> <p>FORD TRANSIT M12 - M15 TUO - T12 TURBO - T15 TURBO</p> <p>77x62x24mm 2f-d10mm</p>
	<p><b>E1087</b> NO. 1022729</p> <p>ESTICADOR DO ESCAPE</p> <p>FORD TRANSIT (APÓS 2002)</p> <p>70x50x25mm NULL</p>		<p><b>F0885-I</b> NO. 6160070 - 86VB.3K661.A1C - 86VB.3K661.AC - 6156467</p> <p>FOLE DA DIRECÇÃO DIREITO E ESQUERDO</p> <p>FORD TRANSIT 2.4D - 2.5D - 2.5Di - 2.5 TD (1976 A 200)</p> <p>d63x190mm 1f-d50mm 1f-d15mm</p>
	<p><b>F0885-T</b> NO. 86VB.3K661.AC - 6160070 - 86VB.3K661.A1C - 6156467</p> <p>FOLE DA DIRECÇÃO DIREITO E ESQUERDO (TERMOPLÁSTICO)</p> <p>FORD TRANSIT 2.4D - 2.5D - 2.5Di - 2.5 TD (1976 A 200)</p> <p>d66x195mm d56mm 1f-d50mm 1f-d16mm</p>		<p><b>F1027</b> NO. 1649554 - 0440888 - 83BG.4846.AA</p> <p>FOLE DA TRANSMISSÃO</p> <p>FORD TRANSIT</p> <p>d94x62mm 1f-d54mm</p>
	<p><b>F1033</b> NO. 78VB7277</p> <p>FOLE DA ALAVANCA DE VELOCIDADES</p> <p>FORD TRANSIT</p> <p>205x140x40 1f-d14mm</p>		<p><b>F1854-I</b> NO. 36020096A - 4059922 - 4568245 - X1248A01 - YC153K661BA</p> <p>FOLE DA DIRECÇÃO LADO DIREITO E ESQUERDO</p> <p>FORD TRANSIT 2.0 Di - 2.0 TDCi - 2.0i - 2.5 Di - 2.5 TD - 2.5 TDi (1991 A 2000)</p> <p>d80x280mm 1f-d55mm 1f-d15mm</p>
	<p><b>F4014</b> NO. 88VB7277VA - 88VB7277BA - 6172863</p> <p>FOLE DA ALAVANCA DE VELOCIDADES</p> <p>FORD TRANSIT M12 - M15 (APÓS 1986)</p> <p>180X150X140mm 1f-d18mm</p>		<p><b>F4015</b> NO.</p> <p>FOLE TRAVÃO DE MÃO</p> <p>FORD TRANSIT (APÓS 1986)</p> <p>185x85x65mm 1f-d15mm</p>

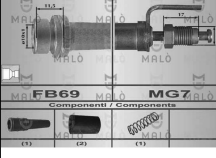
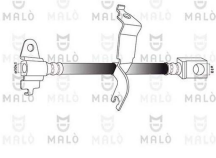
	<p><b>F4016</b> NO. 70VB-7K148 - 70VB.7K148.AA - 1646081</p> <p>FOLE DA ALAVANCA DE VELOCIDADES (PARTE DE BAIXO DO SECTOR DE VELOCIDADES) FORD TRANSIT DZ TT</p> <p>d82x55mm 1f-d70mm 1f-d14mm</p>		<p><b>F4020</b> NO. 6869950 - 92VB3K661AA - 92VB.3K661.BA</p> <p>FOLE DIREÇÃO DIREITO E ESQUERDO (DIREÇÃO ASSISTIDA) FORD TRANSIT M15 - T15 (APÓS 1991)</p> <p>d66x210mm d56mm 1f-d60mm 1f-d15mm</p>
	<p><b>F4020-T</b> NO. 6869950 - 92VB3K661BA - 92VB.3K661.AA</p> <p>FOLE DIREÇÃO ASSISTIDA DIREITO E ESQUERDO (TERMOPLÁSTICO) FORD TRANSIT M15 - T15 (APÓS 1991)</p> <p>d66x210mm d56mm 1f-d60mm 1f-d15mm</p>		<p><b>F4037</b> NO. 4059921 - YC153K661AA</p> <p>FOLE DA DIREÇÃO LADO DIREITO E ESQUERDO FORD TRANSIT 2.0 TDCI - 2.0 Di (APÓS 2000)</p> <p>d72/54x240mm 1f-d68mm 1f-d10mm</p>
	<p><b>F4039</b> NO. 4059922 - YC153K661BA</p> <p>FOLE DA DIREÇÃO LADO DIREITO</p> <p>FORD TRÂNSIT 2.0i (1991 A 1994) - 2.0i - 2.5 Tdi - 2.5 Di - 2.5 TD (1994 A 2000) - 2.0 Di - 2.0 TDCi (APÓS 2000)+F254</p> <p>d65/54x180mm 1f-d67mm 1f-d15mm</p>		<p><b>F4078</b> NO. 211E7277</p> <p>FOLE DA ALAVANCA DE VELOCIDADES FORD TRANSIT</p> <p>130x50mm 1f-d10mm</p>
	<p><b>H118</b> NO.</p> <p>PALA ORIGINAL FRENTE FORD TRANSIT</p> <p>450x430mm NULL</p>		<p><b>H119</b> NO.</p> <p>PALA ORIGINAL TRÁS FORD TRANSIT</p> <p>500x250mm NULL</p>
	<p><b>KF9011</b> NO. 2T144A084AA - 4371800 - 1603232 - 1603278 - 4410860 - 4371801 - 2T144A084BA</p> <p>KIT DE FOLE DO CARDAN JUNTO À RODA E CAIXA FORD TRANSIT CONNECT 1.8Di (APÓS 2002)</p> <p>d102x125mm d92x85mm 1f-d92mm 1f-d25mm 1fd82mm 1f-d25mm</p>		<p><b>KF9012</b> NO. 2T144A084DA - 4371804 - 2T14.4A084.AA</p> <p>KIT DE FOLE DO CARDAN JUNTO À CAIXA FORD TRANSIT CONNECT 1.8Di (APÓS 2002)</p> <p>d93x85mm 1f-d86mm 1f-d21mm</p>
	<p><b>KF9024</b> NO. 4371804 - 4371803 - 2T144A084AA</p> <p>KIT DE FOLE TRANSMISSÃO JUNTO CAIXA</p> <p>FORD TRANSIT CONNECT (P65_ P70_ P80_) 1.8 Di (06.02 - 12.13) 75cv 1753cc Caixa - FORD TRANSIT CONNECT (P65_ P70_ P80_) 1.8 TDCi (06.02 - 12.13) 90cv 1753cc Caixa</p> <p>d90x90mm 1f-d2mm 1f-80mm</p>		<p><b>KL1094-I</b> NO. 6183031 - 6183028 - 6108031</p> <p>KIT DO PEDAL DA EMBRAIAGEM</p> <p>FORD TRANSIT 2.4D (1977 A 1986) - 2.5D (1983 A 1992) - 2.5TD (1992 A 1944) - 2.5 Di (1991 A 2000)</p> <p>119x70x17mm NULL</p>
	<p><b>KL1097-I</b> NO. 1030879 - 95VB7L583AB</p> <p>CATRACA DA EMBRAIAGEM</p> <p>FORD TRANSIT Autocarro (V_) 1.6 (VAS_ VLS_ VZS) (12.77 A 10.86) 65cv 1593cc Autocarro - FORD TRANSIT Autocarro (V_) 2.0 (VAS, VBLVIL, VLS, VUL, VZS) (12.77 A 07.82) 59cv 1993cc Autocarro - FORD TRANSIT Autocarro (V_) 2.0 (VAS, VLS, VZS) (11.77 A 10.86) 75cv 1993cc Autocarro - FORD TRANSIT Autocarro (V_) 2.0 (VAS, VIL, VLS, VUL, VZS) (11.77 A 10.86) 78cv 1993cc Autocarro - FORD TRANSIT Autocarro (V_) 2.4 D (VAS, VBL, VIL, VUL, VZS) (12.77 ...etc.</p> <p>120x85x46mm 1f-d27mm</p>		<p><b>L0016</b> NO. 1499259 - 70VB18174DA</p> <p>CASQUILHO DO AMORTECEDOR</p> <p>FORD TRANSIT</p> <p>d36x22mm d32mm 1f-d20mm</p>
	<p><b>L0246</b> NO. 1521097 - 84VB5719AA</p> <p>CASQUILHO DE MOLA</p> <p>FORD TRANSIT (ATÉ 1982)</p> <p>d33x43mm d27mm 1f-d16mm</p>		<p><b>L1019</b> NO. 1499260 - 70VB.18174.CA - 70VB18174DA</p> <p>CASQUILHO DO AMORTECEDOR DUPL0</p> <p>FORD TRANSIT</p> <p>d37x32mm 1f-d16mm</p>

	<p><b>L1045</b> NO. 1631072 - 84VB.5719.AA - 1631788</p> <p>CASQUILHO DE MOLAS FORD TRANSIT (APÓS 1982)</p> <p>d35x41mm d27mm 1f-d12mm</p>		<p><b>L3023</b> NO. 1575214 - 78VB5A546 - 78VB5A546AA</p> <p>CASQUILHO DAS MOLAS DE TRÁS PARTE DE TRÁS SUPERIOR FORD TRANSIT (APÓS 1982)</p> <p>d45x43mm d42/37mm 1f-d16mm</p>
	<p><b>L3081</b> NO. 1631619 - 86VB5K498AA</p> <p>CASQUILHO DA BARRA ESTABILIZADORA FORD TRANSIT TURBO APÓS 1998</p> <p>d27x31mm d17mm 1f-d10mm</p>		<p><b>M6037</b> NO. 6065962 - 1565558 - 6115136 - 6134623 - 6615275 - 6134622 - 81AB9451AA</p> <p>JUNTA DE ESCAPE FORD TRANSIT (1991 A 1994)</p> <p>107x80mm 2f-d42mm</p>
	<p><b>M6057</b> NO. 6797187 - 6692784 - 6993854</p> <p>JUNTA DE ESCAPE FORD TRANSIT (1994 - 1996)</p> <p>132x75mm 1f-d61.3mm</p>		<p><b>M6096</b> NO. 6688869 - 6745091 - 6616185 - 6504754</p> <p>JUNTA DE ESCAPE FORD TRANSIT (1991 A 1994)</p> <p>d70x13mm 1f-d55mm</p>
	<p><b>M6101</b> NO. 6158920 - 11621317264 - 9004430225 - 9004430270 - 9004430224 - 6579536 - 854954 - GEX7763 - DAR1816 ...</p> <p>JUNTA DE ESCAPE FORD TRANSIT 91-94</p> <p>103x72x2mm 1f-d49mm</p>		<p><b>M6108</b> NO. 6026339</p> <p>JUNTA DE ESCAPE FORD TRANSIT (78-86)</p> <p>57x14mm 1f-d43mm</p>
	<p><b>P1028</b> NO. 86VB245AA - 1631037 - 86VB.2454.AA</p> <p>CAPA DE PEDAL TRAVÃO E EMBRAIAGEM FORD TRANSIT+F379 (1986 A 2000)</p> <p>70x45x9mm NULL</p>		<p><b>P1029</b> NO. 2400E-2454C - 2400E2445</p> <p>CAPA DE PEDAL TRAVÃO E EMBRAIAGEM FORD TRANSIT TR (ATÉ 1986)</p> <p>73x48x13mm NULL</p>
	<p><b>R0498</b> NO.</p> <p>TUBO INFERIOR DO RADIADOR FORD TRANSIT MOTOR PERKINS</p> <p>B220-d30/41mm 125-135-90mm</p>		<p><b>R0685</b> NO.</p> <p>TUBO DA CHAUFAGE FORD TRANSIT</p> <p>B570-d13/11mm 40-265-500-80mm</p>
	<p><b>R220156</b> NO. 6152859 - 86VB-8260AB</p> <p>TUBO SUPERIOR DO RADIADOR FORD TRANSIT 2.4D (1977 A 1986) - 2.5D (1983 A 1992) - 2.5TD (1992 A 1944) - 2.5 Di (1991 A 2000)</p> <p>B250-d37/42mm 75-105-165mm</p>		<p><b>R220157</b> NO. 1631363 - 86VB8286AA</p> <p>TUBO INFERIOR DO RADIADOR FORD TRANSIT 2.4D (1977 A 1986) - 2.5D (1983 A 1992) - 2.5Di (1991 A 2000) - 2.5TD (1992 A 1994)</p> <p>B290-d36/36mm 100-70-95-95mm</p>
	<p><b>R220160</b> NO. 1590405 - 6056449</p> <p>TUBO DE RADIADOR SUPERIOR FORD TRANSIT V184 2.4D (1977 A 1986)</p> <p>B320-d42/38mm 115-160-150-70mm</p>		<p><b>R220162</b> NO. 1575162</p> <p>TUBO INFERIOR DO RADIADOR (LADO DO MOTOR) FORD TRANSIT V184 2.4 (1977 A 1986)</p> <p>B225-d38/36mm 110-75-60mm</p>

	<p><b>R220163</b> NO. 6065514</p> <p>TUBO DE LIGAÇÃO DO DEPÓSITO AO RADIADOR</p> <p>FORD TRANSIT V184 2.4D (1977 A 1986)</p>		<p><b>R220164</b> NO. 1510935</p> <p>TUBO DE RADIADOR SUPERIOR</p> <p>FORD TRANSIT 2.4D (1977 A 1986) - 2.5D (1983 A 1992) - 2.5Di (1991 A 2000) - 2.5TD (1992 A 1994)</p>
	<p><b>R221380</b> NO. 6777718 - 92VB.8260.BA</p> <p>TUBO INFERIOR E SUPERIOR DO RADIADOR</p> <p>FORD TRANSIT 2.5D (1983 A 1992) - 2.5Di (1991 A 2000) - 2.5TD (1992 A 1994)</p>		<p><b>R221381</b> NO. 6777407 - 92VB.8286.AB</p> <p>TUBO INFERIOR DA SAÍDA DE ÁGUA DO RADIADOR</p> <p>FORD TRANSIT 2.5D (1983 A 1992) - 2.5Di (1991 A 2000) - 2.5TD (1992 A 1994)</p>
	<p><b>R8076</b> NO.</p> <p>TUBO DE CHAUFAGEM</p> <p>FORD TRANSIT 2.4 DIESEL</p>		<p><b>R8077</b> NO.</p> <p>TUBO DE CHAUFAGEM</p> <p>FORD TRANSIT 2.4 DIESEL</p>
	<p><b>R8138</b> NO. 6726178</p> <p>TUBO PERMUTADOR AQUECIMENTO</p> <p>FORD TRANSIT Caixa (T_) 2.5 D (TAL, TAS, TGL, TWS) (01.86 A 09.91) 68cv 2496cc Caixa - FORD TRANSIT Caixa (T_) 2.5 D (TAL, TAS, TGL, TWS) (10.88 A 09.91) 71cv 2496cc Caixa - FORD TRANSIT Caixa (E_) 2.5 DI (EAL, EAS) (05.91 A 06.94) 70cv 2496cc Caixa</p>		<p><b>RT08398</b> NO. 1631046</p> <p>TUBO DE TRAVÃO FRENTE LH</p> <p>FORD TRANSIT AUTOBUS 2.0 (11-1977 A 10-1986) - AUTOBUS 2.3 D FT 100 (11-1971 A 09-1978) - AUTOBUS 2.4 D (12-1977 A 10-1986) - FURGONATO 2.0 (11-1977 A 10-1986) - FURGONATO 2.4 D (11-1977 A 10-1986) - PIANALE PIATTO-TELAIO 2.0 (11-1977 A 10-1986) - PIANALE</p>
	<p><b>RT08466</b> NO. 1655850 - 6142527</p> <p>TUBO DE TRAVÃO FRENTE RH</p> <p>FORD TRANSIT 100L (03-1986 A 1991) - 130L (03-1986 A 1991)</p>		<p><b>RT08467</b> NO. 1655851 - 6142528</p> <p>TUBO DE TRAVÃO FRENTE LH</p> <p>FORD TRANSIT 100L (03-1986 A 1991) - 130L (03-1986 A 1991)</p>
	<p><b>RT08691</b> NO. 6149181 - 6577425 - 92VB2282AA</p> <p>TUBO DE TRAVÃO TRÁS LH-RH</p> <p>FORD TRANSIT 130L (03-1986 A 1991) (PINÇA (2 PISTÕES) 130 - 160 - 190 (2.0 - 2.5D - 2.5TD) (03-1986 A 1991) (PINÇA (4 PISTÕES) - TT (APÓS 91) (TUBOS SEPARADOS VERTICALMENTE)</p>		<p><b>RT08699</b> NO. 1655854 - 6577426 - 1089437 - 6149182</p> <p>TUBO DE TRAVÃO TRÁS LH-RH (TUBOS SEPARADOS DIAGONALMENTE)</p> <p>FORD TRANSIT TT (APÓS 1991)</p>
	<p><b>RT80261</b> NO. 4447742 - 4370933</p> <p>TUBO DE TRAVÃO TRÁS LH-RH (SEM ABS)</p> <p>FORD TRANSIT CONNECT TT (APÓS 06-2002)</p>		<p><b>RT80263</b> NO. 4510813</p> <p>TUBO DE TRAVÃO TRÁS LH-RH</p> <p>FORD TRANSIT CONNECT 1.8 16V (APÓS 06-2002) - TRANSIT CONNECT 1.8 Di (APÓS 06-2002) - TRANSIT CONNECT 1.8 TDCi (APÓS 06-2002)</p>
	<p><b>RT80354</b> NO. 4447381</p> <p>TUBO DE TRAVÃO FRENTE LH-RH</p> <p>FORD TRANSIT CONNECT 1.8 16V (APÓS 06-2002) - TRANSIT CONNECT 1.8 Di (APÓS 06-2002) - TRANSIT CONNECT 1.8 TDCi (APÓS 06-2002)</p>		<p><b>RT80452</b> NO. 4447739</p> <p>TUBO DE TRAVÃO FRENTE LH</p> <p>FORD TRANSIT AUTOBUS 2.0 Di (08-2000 A 05-2006) - TRANSIT AUTOBUS 2.3 16V (08-2000 A 05-2006) - TRANSIT AUTOBUS 2.4 Di (01-2000 A 05-2006) - TRANSIT AUTOBUS 2.4 TDE (07-2001 A 05-2006)</p>

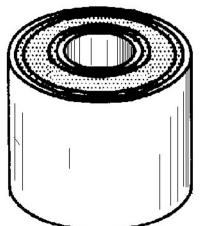
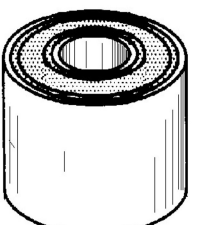
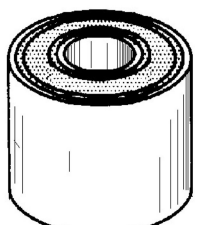
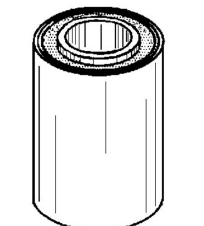
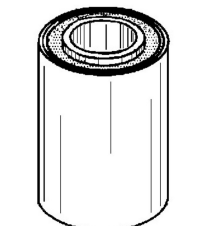
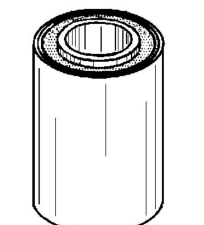
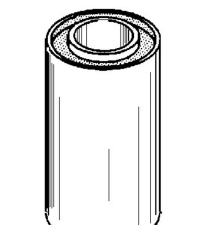
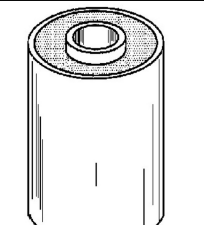
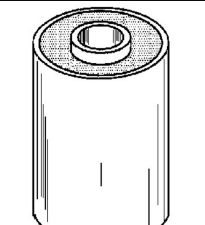
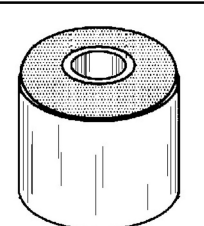
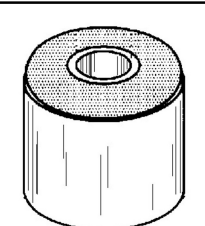









	<p><b>RT80452</b> NO. 4447739</p> <p>TUBO DE TRAVÃO FRENTE LH</p> <p>FORD TRANSIT FURGONATO 2.0 Di (08-2000 A 05-2006) - TRANSIT FURGONATO 2.0 TDCi (08-2002 A 05-2006) - TRANSIT FURGONATO 2.3 16V (04-2001 A 05-2006) - TRANSIT FURGONATO 2.4 Di (01-2000 A 05-2006) - TRANSIT FURGONATO 2.4 TDE (07-2001 A 05-2006)</p> <p>465mm NULL</p>		<p><b>RT80452</b> NO. 4447739</p> <p>TUBO DE TRAVÃO FRENTE LH</p> <p>FORD TRANSIT PIANALE PIATTO-TELAIO 2.0 Di (08-2000 A 05-2006) - TRANSIT PIANALE PIATTO-TELAIO 2.0 TDCi (08-2002 A 05-2006) - TRANSIT PIANALE PIATTO-TELAIO 2.3 16V (04-2001 A 05-2006) - TRANSIT PIANALE PIATTO-TELAIO 2.4 Di (01-2000 A 05-2006) - TRANSIT PIA</p> <p>465mm NULL</p>
	<p><b>RT80453</b> NO. 4409343</p> <p>TUBO DE TRAVÃO TRÁS LH-RH</p> <p>FORD TRANSIT AUTOBUS 2.0 Di (08-2000 A 05-2006) - TRANSIT AUTOBUS 2.0 TDCi (08-2002 A 05-2006) - TRANSIT AUTOBUS 2.3 16V (08-2000 A 05-2006) - TRANSIT AUTOBUS 2.4 Di (01-2000 A 05-2006) - TRANSIT AUTOBUS 2.4 TDE (07-2001 A 05-2006)</p> <p>365mm NULL</p>		<p><b>RT80453</b> NO. 4409343</p> <p>TUBO DE TRAVÃO TRÁS LH-RH</p> <p>FORD TRANSIT FURGONATO 2.0 Di (08-2000 A 05-2006) - TRANSIT FURGONATO 2.0 TDCi (08-2002 A 05-2006) - TRANSIT FURGONATO 2.3 16V (04-2001 A 05-2006) - TRANSIT FURGONATO 2.4 Di (01-2000 A 05-2006) - TRANSIT FURGONATO 2.4 TDE (07-2001 A 05-2006)</p> <p>365mm NULL</p>
	<p><b>RT80454</b> NO. 4409342</p> <p>TUBO DE TRAVÃO TRÁS LH-RH</p> <p>FORD TRANSIT PIANALE PIATTO /TELAIO 2.0 Di (08-2000 A 05-2006) - TRANSIT PIANALE PIATTO /TELAIO 2.0 TDCi (08-2002 A 05-2006) - TRANSIT PIANALE PIATTO/TELAIO 2.3 16V (04-2001 A 05-2006) - TRANSIT PIANALE PIATTO/TELAIO 2.4 Di (01-2000 A 05-2006) - TRANSIT P</p> <p>415mm NULL</p>		<p><b>S1006</b> NO. 78VB.5781.AA - 86VB5781AA - 6152113</p> <p>SILENT-BLOC DE MOLAS TRÁS</p> <p>FORD TRANSIT FORGÃO (ATÉ 1982)</p> <p>d46.5x68mm c60mm 1f-d18mm</p>
	<p><b>S1006-A</b> NO. 78VB.5781.AA - 86VB5781AA - 6152113</p> <p>SILENT-BLOC DE MOLAS TRÁS</p> <p>FORD TRANSIT FORGÃO (ATÉ 1982)</p> <p>d46.5x68mm c60mm 1f-d18mm</p>		<p><b>S1006-B</b> NO. 78VB.5781.AA - 86VB5781AA - 6152113</p> <p>SILENT-BLOC DE MOLAS TRÁS</p> <p>FORD TRANSIT FORGÃO (ATÉ 1982)</p> <p>d46.5x68mm c60mm 1f-d18mm</p>
	<p><b>S1007</b> NO. 78VB5781CB - 78VB5781DA - 6052013 - 1476728</p> <p>SILENT-BLOC DE MOLAS TRÁS</p> <p>FORD TRANSIT CX. ABERTA RODADO DUPLO (1982 A 1989)</p> <p>d46.5x67mm c61mm 1f-d20mm</p>		<p><b>S1007-A</b> NO. 78VB5781CB - 78VB5781DA - 6052013 - 1476728</p> <p>SILENT-BLOC DE MOLAS TRÁS</p> <p>FORD TRANSIT CX. ABERTA RODADO DUPLO (1982 A 1989)</p> <p>d46.5x67mm c61mm 1f-d20mm</p>
	<p><b>S1007-B</b> NO. 78VB5781CB - 78VB5781DA - 6052013 - 1476728</p> <p>SILENT-BLOC DE MOLAS TRÁS</p> <p>FORD TRANSIT CX. ABERTA RODADO DUPLO (1982 A 1989)</p> <p>d46.5x67mm c61mm 1f-d20mm</p>		<p><b>S1009</b> NO. RVT5781AA</p> <p>SILENT-BLOC DE MOLAS FRENTE (FURO 19mm)</p> <p>FORD TRANSIT FORGÃO (ATÉ 1982) - CAIXA ABERTA RODADO DUPLO (1982 A 1989)</p> <p>d38x69mm c62mm 1f-d19mm</p>
	<p><b>S1019</b> NO. 78VB5719BA - 1575045</p> <p>SILENT-BLOC DE MOLAS TRÁS</p> <p>FORD TRANSIT FURGÃO RODADO DUPLO FURO 16 mm</p> <p>d46.5x67mm c61mm 1f-d16mm</p>		<p><b>S1019-A</b> NO. 78VB5719BA - 1575045</p> <p>SILENT-BLOC DE MOLAS TRÁS</p> <p>FORD TRANSIT FURGÃO RODADO DUPLO FURO 16 mm</p> <p>d46.5x67mm c61mm 1f-d16mm</p>
	<p><b>S1038</b> NO. 78VB5781DA - 6052013 - 78VB.5781.CB - 78VB5719CB - 6054238</p> <p>SILENT-BLOC DE MOLAS TRÁS RODADO SIMPLES (FURO 16mm)</p> <p>FORD TRANSIT FORGÃO (ATÉ 1982)</p> <p>d47.5x83mm c64mm 1f-d16mm</p>		<p><b>S1038-B</b> NO. 78VB5781DA - 6052013 - 78VB.5781.CB - 78VB5719CB - 6054238</p> <p>SILENT-BLOC DE MOLAS TRÁS RODADO SIMPLES (FURO 16mm)</p> <p>FORD TRANSIT FORGÃO (ATÉ 1982)</p> <p>d47.5x83mm c64mm 1f-d16mm</p>



	<p><b>S1054</b> NO. 76VB5781AA - 1575577</p> <p>SILENT-BLOC DE MOLAS FRENTE FURO 18 mm</p> <p>FORD TRANSIT FORGÃO (APÓS 1982)</p> <p>d37x66.5mm c60mm 1f-d18mm</p>		<p><b>S1054-B</b> NO. 76VB5781AA - 1575577</p> <p>SILENT-BLOC DE MOLAS FRENTE FURO 18 mm</p> <p>FORD TRANSIT FORGÃO (APÓS 1982)</p> <p>d37x66.5mm c60mm 1f-d18mm</p>
	<p><b>S1083</b> NO. 6152113 - 86VB5781AA</p> <p>SILENT-BLOC DE MOLA DE TRÁS</p> <p>FORD TRANSIT FORGÃO (APÓS 1982)</p> <p>d46.5x72mm c61mm 1f-d18mm</p>		<p><b>S1083-B</b> NO. 6152113 - 86VB5781AA</p> <p>SILENT-BLOC DE MOLA DE TRÁS</p> <p>FORD TRANSIT FORGÃO (APÓS 1982)</p> <p>d46.5x72mm c61mm 1f-d18mm</p>
	<p><b>S1134</b> NO. 92VB5781AA - 7328510 - 6197149</p> <p>SILENT-BLOC DAS MOLAS TRASEIRAS (OLHAL DA FRENTE)</p> <p>FORD TRANSIT MODERNA RODADO DUPLO (APÓS 1989)</p> <p>d57x72mm c60mm 1f-d18mm</p>		<p><b>S1134-B</b> NO. 92VB5781AA - 7328510 - 6197149</p> <p>SILENT-BLOC DAS MOLAS TRASEIRAS (OLHAL DA FRENTE)</p> <p>FORD TRANSIT MODERNA RODADO DUPLO (APÓS 1989)</p> <p>d57x72mm c60mm 1f-d18mm</p>
	<p><b>S1135</b> NO. 6197146 - 92VB5719AA</p> <p>SILENT-BLOC DAS MOLAS TRASEIRAS (OLHAL DE TRÁS)</p> <p>FORD TRANSIT MODERNA RODADO DUPLO (APÓS 1989)</p> <p>d50x82mm c61mm 1f-d16mm</p>		<p><b>S1135-B</b> NO. 6197146 - 92VB5719AA</p> <p>SILENT-BLOC DAS MOLAS TRASEIRAS (OLHAL DE TRÁS)</p> <p>FORD TRANSIT MODERNA RODADO DUPLO (APÓS 1989)</p> <p>d50x82mm c61mm 1f-d16mm</p>
	<p><b>S1231</b> NO. 92VB-18016AB - 1076408 - 6562752 - 92VB.18016.AB</p> <p>SILENT-BLOC DOS AMORTECEDORES</p> <p>FORD TRANSIT 2.5D (1983 A 1992) - 2.5Di (1991 A 2000) - 2.5TD (1992 A 1994)</p> <p>d45x40mm c28mm 1f-d12mm</p>		<p><b>S1232</b> NO. 92VB3432AA - 6608818</p> <p>SILENT-BLOC DO BRAÇO DA SUSPENSÃO FRENTE</p> <p>FORD TRANSIT 2.5D (1983 A 1992) - 2.5Di (1991 A 2000) - 2.5TD (1992 A 1994)</p> <p>d61x52mm d52mm 1f-d16mm</p>
	<p><b>S1233</b> NO. 92VB3069AA - 6517356</p> <p>SILENT-BLOC DO BRAÇO DA SUSPENSÃO FRENTE</p> <p>FORD TRANSIT 2.5D (1983 A 1992) - 2.5Di (1991 A 2000) - 2.5TD (1992 A 1994)</p> <p>d46x92mm d41mm 1f-d16mm</p>		<p><b>S1258</b> NO. 6154667 - 86VB3069AA - 86VB3069AB</p> <p>SILENT-BLOC DO BRAÇO DA SUSPENSÃO FRENTE INFERIOR</p> <p>FORD TRANSIT (1986 A 1991)</p> <p>d41x83mm d37mm 1f-d14mm</p>
	<p><b>S1260</b> NO. 6149013 - 86VB3C716AA</p> <p>SILENT-BLOC DA DIRECÇÃO</p> <p>FORD TRANSIT M12 - M15 - T12 - T15 (APÓS 1991)</p> <p>d29x63mm d25mm 1f-d11mm</p>		<p><b>S1293</b> NO. 4041521 - YC15.5719.AA</p> <p>SILENT-BLOC DAS MOLAS TRÁS OLHAL TRÁS</p> <p>FORD TRANSIT (APÓS 2001) V184</p> <p>d51x68mm c61mm 1f-d14mm</p>
	<p><b>S1294</b> NO. 4055743 - YC15.5781.AC - YC15.5781.BB</p> <p>SILENT-BLOC DAS MOLAS TRÁS OLHAL TRÁS</p> <p>FORD TRANSIT M12-M15 - TRANSIT (APÓS 2001) V184</p> <p>d57x72mm c60mm 1fd-16mm</p>		<p><b>S1349</b> NO. 4042024 - YC153A262AD - 6C163A262AA - 4372132 - 4540787</p> <p>SILENT-BLOC DO BRAÇO DA SUSPENSÃO FRENTE</p> <p>FORD TRANSIT 2.0Di (APÓS 08-2000) - 2.0 TDCi (APÓS 08-2002) - 2.4 Di (APÓS 2000) - 2.4 TDE (APÓS 07-2000) - 2.4 TDCi (APÓS 03-2004) - 2.5 Di (1997 A 2000)</p> <p>d66x72mm c40mm 1f-d16mm</p>



	<b>S1350</b> NO. 4131788 - YC153069AG - 4041450 SILENT-BLOC FORD TRANSIT 2.0Di (APÓS 08-2000) - 2.0 TDCi (APÓS 08-2002) - 2.4 Di (APÓS 2000) - 2.4 TDE (APÓS 07-2000) - 2.4 TDCi (APÓS 03-2004) - 2.5 Di (1997 A 2000)+F147		<b>S1374</b> NO. 1076408 - 97VB18016AA SILENT-BLOC DA SUSPENSÃO DE TRÁS FORD TRANSIT TURBO
d44x68mm	d38mm 1f-d14mm	d48x40mm	d43mm 1f-d12mm
	<b>S1383</b> NO. 80VB5A546AA - 6102898 SILENT-BLOC DO CHASSI FORD TRANSIT		<b>S1385</b> NO. 2T1418016AA - 4410223 SILENT-BLOC DOS AMORTECEDORES FORD TRANSIT CONNECT
d47x75mm	c65mm 1f-d16mm	d37x40mm	d34mm 1f-d12mm
	<b>S1386</b> NO. 2T145791AA - 4408458 SILENT-BLOC DAS MOLAS DE TRÁS OLHAL DE TRÁS FORD TRANSIT CONNECT		<b>S1387</b> NO. 2T145781AA - 4367046 SILENT-BLOC DAS MOLAS DE TRÁS OLHAL FRENTE FORD TRANSIT CONNECT
d37x80mm	d29mm 1f-d14mm	d60x74mm	d54mm 1f-d14mm
	<b>S1388</b> NO. 2T145719BA - 4367044 - 4418511 - 4401266 SILENT-BLOC DAS MOLAS TRÁS OLHAL DE TRÁS FORD TRANSIT CONNECT		<b>S1389</b> NO. 2T143063AA - 4366976 SILENT-BLOC DO BRAÇO DA SUSPENSÃO DA FRENTE PARTE INFERIOR FORD TRANSIT CONNECT
d61x74mm	d50mm 1f-d14mm	d50x65mm	d43mm 1f-d14mm
	<b>S1451</b> NO. 1S4Q.10C382.AB - 154Q10C382AC - 1133969 - 1151207 - 1423796 SILENT-BLOC DO ALTERNADOR FORD TRANSIT CONNECT (APÓS 2005)		<b>S1510</b> NO. 6C115719AA - 6C165781BA - 1431018 - 1453844 - 1453842 - 6C165719AA - 6C115719AB - 1720477 SILENTBLOC DA MOLLA DE TRÁS FORD TRANSIT V347 (APÓS 2006) 2 - 2 TDCI - 2 - 2 TDCI 4X4 - 2 - 3 16V - 2 - 4 TDCI - 2 - 4 TDCI 4X4 - 3 - 2 TDCI
d87x49mm	c30mm 1f-d16.8mm	d66x72mm	c49mm d56mm 1f-d14mm
	<b>S1534</b> NO. 1431075 - 1453842 - 6C115781BA - 6C165719AA - 1453843 - 6C165781BA - 1431019 - 1720481 - 6C115781AB SILENTE BLOC DAS MOLAS DE TRÁS FORD TRANSIT (V347)		<b>T0033</b> NO. 86VB5484AB - 6150977 BATERIA DA BARRA ESTABILIZADORA FORD TRANSIT MODERNO (APÓS 86)
d84x36mm	c29mm d60,5mm 1f-d15,8mm	40x40x36mm	1f-d16mm
	<b>T0604-I</b> NO. 6142480 - 86VB3020AA BATERIA DA SUSPENSÃO FRENTE FORD TRANSIT M12 - M15 -T12-T15 (APÓS 1991)		<b>T0609-I</b> NO. 2T145K570BC - 4411872 - 2T145K570B - 2T145K570BA - 2T145K570BB - 4379529 - 1344760 - 4T165K570AA - 4... BATERIA DA SUSPENSÃO DE TRÁS FORD TRANSIT CONNECT (APÓS 2002)
d59x67mm	1f-d30mm 1f-d17mm	d75x80mm	1f-d14mm 1f-d28mm
	<b>T0639-I</b> NO. 4346508 - 1C154002BA - 4356664 - 2C114002AA - 4519477 - 3C114002AA - 4531298 - 3C114002BA BATERIA SUSPENSÃO DE TRÁS FORD TRANSIT (2000 A 2006) (FY)		<b>T0640-I</b> NO. 4453303 - 1S7W3025AD - 1123541 - 1118919 - 1S713025AC - 1116577 - 1S713025AD - 1S713025AB - 4453303... BATERIA SUSPENSÃO DA FRENTE FORD TRANSIT CONNECT (P65_ - P70_ - P80_) 1.8 16V (06.02 A 12.13) 116cv 1796cc Caixa - FORD TRANSIT CONNECT (P65_ - P70_ - P80_) 1.8 Di (06.02 A 12.13) 75cv 1753cc Caixa - FORD TRANSIT CONNECT (P65_ - P70_ - P80_) 1.8 TDCi (06.02 A 12.13) 90cv 1753cc Caixa - FORD TRANSIT CONNECT (P65_ - P70_ - P80_) 1.8 TDCi (08.06 A 12.13) 110cv 1753cc Caixa
d85x96mm	1f-d20mm 1p-d10x17mm	d69x69mm	1f-d28mm 1f-d28mm

	<p><b>T0670-I</b> NO. 1383523 - 6C113025AB - YC153025AC - 4041449</p> <p>BATENTE SUSPENSÃO DA FRENTE</p> <p>FORD TRANSIT Autocarro 2.2 TDCi (04.06 - 08.14) 85cv 2198cc Autocarro - FORD TRANSIT Autocarro 2.2 TDCi (10.11 - 08.14) 100cv 2198cc Autocarro - FORD TRANSIT Autocarro 2.2 TDCi (04.06 - 08.14) 110cv 2198cc Autocarro - FORD TRANSIT Autocarro 2.2 TDCi (10.08 - 08.14) 115cv 2198cc Autocarro - FORD TRANSIT Autocarro 2.2 TDCi (10.11 - 08.14) 125cv 2198cc Autocarro - FORD TRANSIT Autocarro 2.2 TDCi (04.06 - 08.14) 130cv 2198cc Autocarro - FORD TRANSIT ...etc.</p> <p>d65x105mm 1f-d30mm 1f-d22mm</p>		<p><b>T0671-I</b> NO. 1388271 - 6C113025BC - 1434150</p> <p>BATENTE SUSPENSÃO DA FRENTE</p> <p>FORD TRANSIT Autocarro 2.2 TDCi (04.06 - 08.14) 85cv 2198cc Autocarro - FORD TRANSIT Autocarro 2.2 TDCi (10.11 - 08.14) 100cv 2198cc Autocarro - FORD TRANSIT Autocarro 2.2 TDCi (04.06 - 08.14) 110cv 2198cc Autocarro - FORD TRANSIT Autocarro 2.2 TDCi (10.08 - 08.14) 115cv 2198cc Autocarro - FORD TRANSIT Autocarro 2.2 TDCi (10.11 - 08.14) 125cv 2198cc Autocarro - FORD TRANSIT Autocarro 2.2 TDCi (04.06 - 08.14) 130cv 2198cc Autocarro - FORD TRANSIT ...etc.</p> <p>d65x105mm 1f-d30mm 1f-d27mm</p>
	<p><b>T0672-I</b> NO. BK213025AA</p> <p>BATENTE SUSPENSÃO DA FRENTE</p> <p>FORD TRANSIT</p> <p>d64x85mm 1f-d31mm 1f-d31mm</p>		<p><b>T0673-I</b> NO. BK213025BA - BK213025BB - 1804552</p> <p>BATENTE SUSPENSÃO DA FRENTE</p> <p>FORD TRANSIT 2 TON</p> <p>d65x80mm 1f-d31mm 1f-d32mm</p>
	<p><b>T0676-I</b> NO. 040605027 - 1327526 - 1330184 - 1349805 - 40605027 - 4C106K682BD - 4C106K682BE - 4937700500 - 493770...</p> <p>BATENTE SUSPENSÃO DA FRENTE</p> <p>FORD TRANSIT Autocarro 2.4 TDCi (03.04 A 05.06) 137cv 2402cc Autocarro - FORD TRANSIT Caixa 2.4 TDCi (03.04 A 05.06) 137cv 2402cc Caixa - FORD TRANSIT Camião de plataforma/chassis 2.4 TDCi (03.04 A 05.06) 137cv 2402cc Camião de plataforma/chassis</p> <p>d55x47mm 1f-d26mm 1p-d8x18mm</p>		<p><b>T1041</b> NO. 6521812 - 92VB5484BA</p> <p>BATENTE DA BARRA ESTABILIZADORA (FRENTE CENTRO)</p> <p>FORD TRANSIT M15 - T15</p> <p>39x39x36mm 1f-d20mm</p>
	<p><b>T1043</b> NO. 6521811 - 92VB5484AA</p> <p>BATENTE DA BARRA ESTABILIZADORA (CENTRO FRENTE)</p> <p>FORD TRANSIT M12 - T12</p> <p>39x39x36mm 1f-d18mm</p>		<p><b>T1046</b> NO. 6141942 - 86VB.5484.BA</p> <p>BATENTE DA BARRA ESTABILIZADORA TRÁS</p> <p>FORD TRANSIT M15 2.5TD</p> <p>70x50x58mm 1f-d30mm</p>
	<p><b>T1046-C</b> NO. 86VB.5484.BA - YC15.5486.AA - 6141942 - 4041491</p> <p>BATENTE DA BARRA ESTABILIZADORA TRÁS(COMPLETO)</p> <p>FORD TRANSIT M12 - M15 (APÓS 1986) - V184 (2001)</p> <p>142x64x61mm 1f-d31mm</p>		<p><b>T1074</b> NO. 4041489 - YC15.5484AC - 3C11.5484.CB</p> <p>BATENTE DA BARRA ESTABILIZADORA DA FRENTE</p> <p>FORD TRANSIT V184 2001</p> <p>52x50x36mm 1f-d24mm</p>
	<p><b>T1089</b> NO. 4041490 - YC155484BD</p> <p>BATENTE DA BARRA ESTABILIZADORA DE TRÁS</p> <p>FORD TRANSIT V184 APÓS 2000</p> <p>70x62x50mm 1f-d29mm</p>		<p><b>T1097</b> NO. 2T144A037AC - 4419557 - 2T144037AC - 4379900</p> <p>BATENTE DA BARRA ESTABILIZADORA DE TRÁS</p> <p>FORD TRANSIT CONNECT (APÓS 2002)</p> <p>49x46x42mm 1f-d22mm</p>
	<p><b>T1098</b> NO. 2T145484BD - 4419559 - 4964972 - 2T14.5484.CA - 4385316</p> <p>BATENTE DA BARRA ESTABILIZADORA DA FRENTE</p> <p>FORD TRANSIT CONNECT</p> <p>49x46x42mm 1f-26x21mm</p>		<p><b>U0304</b> NO. 92VB5349AB - 6609198</p> <p>ANILHA SUSPENSÃO</p> <p>FORD TRANSIT T12 - T15 (APÓS 1991)</p> <p>d160x37mm 1f-d87mm</p>
	<p><b>U7001</b> NO. 71VB-7K520</p> <p>TAPA FURO</p> <p>FORD TRANSIT DZ</p> <p>126x92x12mm NULL</p>		<p><b>U7005</b> NO. 6191553 - 88VB7W262AB</p> <p>SUPORTE DE PROTECÇÃO DO FOLE DA ALAVANCA DE VELOCIDADES</p> <p>FORD TRANSIT M15 - T12 - T15 (APÓS 1991)</p> <p>175x172x53mm NULL</p>

	<p><b>W5035</b> NO. 1135052</p> <p>POLIE DA CAMBOTA (6 PISTAS)</p> <p>FORD TRANSIT CONNECT 1.8 16V (APÓS 06-2002)</p> <p>d132mm d28mm</p>		<p><b>W5081</b> NO. 1151392 - 1143413 - 1S4Q6B319AE - 1S4Q6B319AF - 1S4Q6B318AE - 1S4Q6A345AA - XS4Q6A345A - XS4Q6A345A</p> <p>POLIE DA CAMBOTA (6 PISTAS)</p> <p>FORD TRANSIT CONNECT 1.8 TDCi Mtr HCPA 90CV (APÓS 06-2002)</p> <p>d140/153mm d14.6mm</p>
	<p><b>W5090</b> NO. 1351731 - 1315530 - 1385506 - 1124891 - 1151394 - 1226637 - 1226638 - 1329203 - 1349993 - 1594853 - ...</p> <p>POLIE DA CAMBOTA (6 PISTAS)</p> <p>FORD TRANSIT 2.0 TDCi (APÓS 08-2002)</p> <p>d160mm d5mm</p>		<p><b>W5100</b> NO. 1372756 - 1376475 - 1387095 - 1731716 - 6C1Q6B319CA - 6C1Q6B319CB</p> <p>POLIE DA CAMBOTA</p> <p>FORD TRANSIT 2.2 TDCi</p> <p>d159.8-139.8mm d59mm</p>
	<p><b>W5112</b> NO. 1727140 - 1748942 - 1379766 - BK3Q6B319CB - BK3Q6B319CA - 6C1Q6B319EA</p> <p>POLIE DA CAMBOTA (7 PISTAS)</p> <p>FORD TRANSIT Autocarro - 2.4 TDCi 100CV 2402cc (APÓS 04-2006) - 115CV 2402cc (APÓS 04-2006) - 140CV 2402cc (APÓS 04-2006) - 2.4 TDCi 4X4 140CV 2402cc (APÓS 11-2006)</p> <p>d167mm 3f-d13mm</p>		<p><b>W5112</b> NO. 1727140 - 1748942 - 1379766 - BK3Q6B319CB - BK3Q6B319CA - 6C1Q6B319EA</p> <p>POLIE DA CAMBOTA (7 PISTAS)</p> <p>FORD TRANSIT Caixa 2.4 TDCi 100CV 2402cc (APÓS 04-2006) - 115CV 2402cc (APÓS 04-2006) - 140CV 2402cc (APÓS 04-2006) - 2.4 TDCi 4X4 140CV 2402cc (APÓS 11-2006)</p> <p>d167mm 3f-d13mm</p>
	<p><b>W5112</b> NO. 1727140 - 1748942 - 1379766 - BK3Q6B319CB - BK3Q6B319CA - 6C1Q6B319EA</p> <p>POLIE DA CAMBOTA (7 PISTAS)</p> <p>FORD TRANSIT Camião de plataforma - chassis - 2.4 TDCi 100CV 2402cc (APÓS 04-2006) - 115CV 2402cc (APÓS 04-2006) - 140CV 2402cc (APÓS 04-2006)</p> <p>d167mm 3f-d13mm</p>		<p><b>W5113</b> NO. 1434432 - 1386188 - 1539837 - 1723700 - 6C1Q6B319AF - BU3Q6B319AA - 6C1Q6B319AD - 6C1Q6B319AE</p> <p>POLIE DA CAMBOTA (6+4 PISTAS)</p> <p>FORD TRANSIT Autocarro 2.2 TDCi 85CV 2198cc (APÓS 04-2006) 100CV 2198cc (APÓS 10-2011) - FORD TRANSIT Autocarro - 2.2 TDCi (RWD) 100CV 2198cc (APÓS 10-2011) - 2.2 TDCi 110CV 2198cc (APÓS 04-2006) - 115CV 2198cc (APÓS 10-2008) - 125CV 2198cc (APÓS 10-2011)</p> <p>d167mm 3f-d13mm</p>
	<p><b>W5113</b> NO. 1434432 - 1386188 - 1539837 - 1723700 - 6C1Q6B319AF - BU3Q6B319AA - 6C1Q6B319AD - 6C1Q6B319AE</p> <p>POLIE DA CAMBOTA (6+4 PISTAS)</p> <p>FORD TRANSIT TOURNEO - 2.2 TDCi Autocarro 110CV 2198cc (APÓS 07-2006) - 115CV 2198cc (APÓS 10-2008) - 131CV 2198cc (APÓS 07-2006) - 140CV 2198cc (APÓS 10-2007)</p> <p>d167mm 3f-d13mm</p>		<p><b>W5113</b> NO. 1434432 - 1386188 - 1539837 - 1723700 - 6C1Q6B319AF - BU3Q6B319AA - 6C1Q6B319AD - 6C1Q6B319AE</p> <p>POLIE DA CAMBOTA (6+4 PISTAS)</p> <p>FORD TRANSIT CAIXA 2.2 TDCi 85CV 2198cc (APÓS 04-2006) - 100CV 2198cc (APÓS 10-2011) - FORD TRANSIT Caixa 2.2 TDCi (RWD) 100CV 2198cc (APÓS 10-2011) - 110CV 2198cc (APÓS 04-2006) - 115CV 2198cc (APÓS 10-2008) - 125CV 2198cc (APÓS 10-2011) - 125CV 2198cc</p> <p>d167mm 3f-d13mm</p>
	<p><b>W5113</b> NO. 1434432 - 1386188 - 1539837 - 1723700 - 6C1Q6B319AF - BU3Q6B319AA - 6C1Q6B319AD - 6C1Q6B319AE</p> <p>POLIE DA CAMBOTA (6+4 PISTAS)</p> <p>FORD TRANSIT Camião de plataforma - chassis 2.2 TDCi 85CV 2198cc (APÓS 04-2006) - 100CV 2198cc (APÓS 10-2011) - 2.2 TDCi (RWD) 100CV 2198cc (APÓS 10-2011) - 110CV 2198cc (APÓS 04-2006) - 115CV 2198cc (APÓS 10-2008) - 125CV 2198cc (APÓS 10-2011) - 2.2 TDCi</p> <p>d167mm 3f-d13mm</p>		<p><b>W5113</b> NO. 1434432 - 1386188 - 1539837 - 1723700 - 6C1Q6B319AF - BU3Q6B319AA - 6C1Q6B319AD - 6C1Q6B319AE</p> <p>POLIE DA CAMBOTA (6+4 PISTAS)</p> <p>FORD TRANSIT CUSTOM Caixa 2.2 TDCi 100CV 2198cc (APÓS 12-2012) - 125CV 2198cc (APÓS 12-2012) - 155CV 2198cc (APÓS 12-2012)</p> <p>d167mm 3f-d13mm</p>
	<p><b>W5116</b> NO. 1226639 - 1329202 - 1377588 - 1675115 - 1708966 - 4C1Q6B319AA - 4C1Q6B319BA - 9C1Q6B319AA - 9C1Q6B319BA</p> <p>POLIE DA CAMBOTA (7 PISTAS)</p> <p>FORD TRANSIT AUTOCARRO (E) 2.5 TD (10-1992 A 07-1994) 85CV 2496CC - FORD TRANSIT CAIXA (E) 2.5 DI (10-1992 A 06-1994) 85CV 2496CC - FORD TRANSIT AUTOCARRO (FD FB FS FZ FC) 2.4 DI (01-2000 A 05-2006) 75CV 2402CC - FORD TRANSIT AUTOCARRO (FD FB FS FZ FC)</p> <p>d167mm 3f-d13mm</p>		<p><b>W5116</b> NO. 1226639 - 1329202 - 1377588 - 1675115 - 1708966 - 4C1Q6B319AA - 4C1Q6B319BA - 9C1Q6B319AA - 9C1Q6B319BA</p> <p>POLIE DA CAMBOTA (7 PISTAS)</p> <p>FORD TRANSIT CAIXA (FA) 2.4 DI (RWD) (01-2000 A 05-2006) 75CV 2402CC - FORD TRANSIT CAIXA (FA) 2.4 DI (01-2000 A 05-2006) 90CV 2402CC - FORD TRANSIT CAIXA (FA) 2.4 TDE (03-2004 A 05-2006) 115CV 2402CC - FORD TRANSIT CAIXA (FA) 2.4 DI (RWD) (01-2000 A 05-2006)</p> <p>d167mm 3f-d13mm</p>
	<p><b>W5116</b> NO. 1226639 - 1329202 - 1377588 - 1675115 - 1708966 - 4C1Q6B319AA - 4C1Q6B319BA - 9C1Q6B319AA - 9C1Q6B319BA</p> <p>POLIE DA CAMBOTA (7 PISTAS)</p> <p>FORD TRANSIT CAMIAO PLATAFORMA (FM FN) 2.4 DI (01-2000 A 05-2006) 75CV 2402CC - FORD TRANSIT CAMIAO PLATAFORMA (FM FN) 2.4 DI (01-2000 A 05-2006) 90CV 2402CC - FORD TRANSIT CAMIAO PLATAFORMA (FM FN) 2.4 TDE (03-2004 A 05-2006) 115CV 2402CC - FORD TRANSIT</p> <p>d167mm 3f-d13mm</p>		<p><b>W5139</b> NO. 1469722 - 1776624 - 7C166B319AB</p> <p>POLIE DA CAMBOTA 7 PISTAS</p> <p>FORD TRANSIT Autocarro 3.2 TDCi (02.08 A 08.14) 200cv 3199cc Autocarro</p> <p>d161mm d13mm</p>

	<table border="1"> <tr> <td><b>Z80733</b></td> <td>NO. 4069907</td> </tr> <tr> <td colspan="2"><i>Mola de fixação</i></td> </tr> <tr> <td colspan="2">FORD TRANSIT</td> </tr> <tr> <td>26x14x16mm</td> <td>1p-10x8-7mm</td> </tr> </table>	<b>Z80733</b>	NO. 4069907	<i>Mola de fixação</i>		FORD TRANSIT		26x14x16mm	1p-10x8-7mm		<table border="1"> <tr> <td><b>Z80734</b></td> <td>NO. 4069906</td> </tr> <tr> <td colspan="2"><i>Mola de fixação</i></td> </tr> <tr> <td colspan="2">FORD TRANSIT</td> </tr> <tr> <td>26x14x25mm</td> <td>1p-11x7,4-16mm</td> </tr> </table>	<b>Z80734</b>	NO. 4069906	<i>Mola de fixação</i>		FORD TRANSIT		26x14x25mm	1p-11x7,4-16mm
<b>Z80733</b>	NO. 4069907																		
<i>Mola de fixação</i>																			
FORD TRANSIT																			
26x14x16mm	1p-10x8-7mm																		
<b>Z80734</b>	NO. 4069906																		
<i>Mola de fixação</i>																			
FORD TRANSIT																			
26x14x25mm	1p-11x7,4-16mm																		
	<table border="1"> <tr> <td><b>Z9005</b></td> <td>NO. 1640227 - 6156718 - 6688870</td> </tr> <tr> <td colspan="2"><i>MOLA DE ESCAPE</i></td> </tr> <tr> <td colspan="2">FORD TRANSIT (1991 A 1994)</td> </tr> <tr> <td>d25x28mm</td> <td>NULL</td> </tr> </table>	<b>Z9005</b>	NO. 1640227 - 6156718 - 6688870	<i>MOLA DE ESCAPE</i>		FORD TRANSIT (1991 A 1994)		d25x28mm	NULL										
<b>Z9005</b>	NO. 1640227 - 6156718 - 6688870																		
<i>MOLA DE ESCAPE</i>																			
FORD TRANSIT (1991 A 1994)																			
d25x28mm	NULL																		