













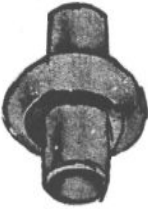
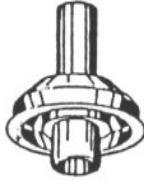



























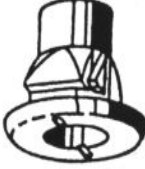









	H516	NO.		H550	NO.
	PALA ORIGINAL FIAT			PALA ORIGINAL LINEACCESSORI FIAT	
	275x210mm NULL			370x205mm NULL	
	U04073	NO. 849128		UBV8011	NO.
	ANILHA DE AMORTECEDOR FIAT			BOMBA VACUO (KIT REPARAÇÃO MODELO INCLINADO) (41x51mm) FIAT (DIESEL)	
	d37x11mm 1f-d13mm			41x51mm 2f-d5mm	
	UBV8013	NO.		UBV8014	NO.
	BOMBA VACUO (KIT REPARAÇÃO NOVO MODELO) (LARG. 51mm) FIAT (DIESEL)			BOMBA VACUO (KIT REPARAÇÃO) (NOVO MODELO) FIAT (DIESEL)	
	51x51mm 2f-d5mm			d105x2mm 9f-d5mm	
	Z10700	NO.		Z10701	NO.
	Mola de friso Fiat			Mola de friso Fiat	
	NULL NULL			NULL NULL	
	Z10790	NO.		Z10892	NO. 698681 - 14570180 - 7703079072 - A0009957644
	Mola de fixação Fiat			Mola de fixação FIAT (TODOS)	
	NULL NULL			22x8.4x26mm 1f-17mm	
	Z10901	NO.		Z29785	NO. 92061009
	Mola de fixação Fiat			Mola de fixação FIAT (TODOS)	
	NULL NULL			13x8.5x4.8mm NULL	
	Z29787	NO. 14184074		Z33733	NO.
	Mola de fixação FIAT (TODOS)			Mola de friso Fiat 1300 - 1500	
	13x8.2x4.9mm NULL			20x9.5x11mm NULL	
	Z59906	NO.		Z80340	NO. 14591686 - 14591687 - 17887187
	Mola de fixação Fiat			Mola de painel FIAT (TODOS)	
	NULL NULL			d15x14.5mm 1p-d8-12.5mm	







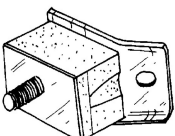
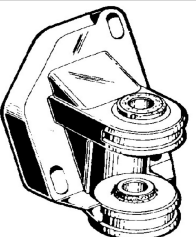

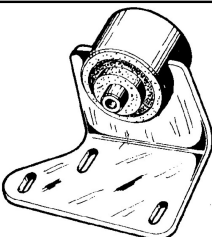
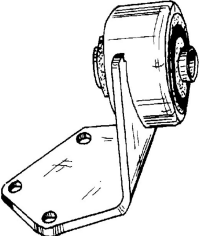
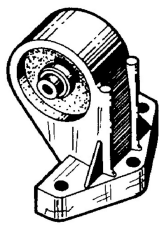
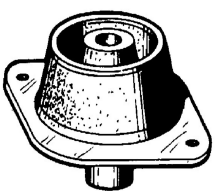
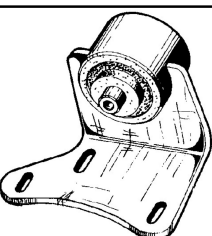
	Z80353 NO. 14591787 - 17887287 <i>Mola de painel</i> FIAT (TODOS) d15x19mm 1p-d8-17mm		Z80355 NO. 4292906 - 17887787 - 14591487 <i>Mola de painel</i> FIAT (TODOS) d16x19mm 1p-d9.5-17mm
	Z80425 NO. 14592086 - 14592087 - 735284886 <i>Mola de painel</i> FIAT (TODOS) d20x25mm 1p-d8-23mm		Z80470 NO. 164361 - 7703072177 <i>Mola de fixação</i> FIAT (TODOS) d5x45mm NULL
	Z80479 NO. 14568987 <i>Mola de painel</i> FIAT (TODOS) d24x33mm 1p-d11-29mm		Z80502 NO. 5757553 <i>Mola de retenção</i> FIAT MARENGO d16x9.5mm 1p-7x7-8.5mm 1f-d4.8mm
	Z80504 NO. 7600779 <i>Mola de fixação</i> FIAT SIENA d16x25mm 1p-d8-13mm		Z80518 NO. 14115980 - 155809966 - 6992G2 <i>Mola de retenção</i> FIAT (TODOS) d13x9mm 1p-7x7-8mm 1f-d4.8mm
	Z80532 NO. 5998258 <i>Mola de friso</i> FIAT SIENA 20x7x5mm NULL		Z80578 NO. 14569580 - 14569680 <i>Mola de fixação</i> FIAT SIENA 20x8x15mm 1f-8mm
	Z80579 NO. 14569880 <i>Mola de fixação</i> FIAT (TODOS) 19.6x8x20mm 1f-11mm		Z80588 NO. 7637466 <i>Mola de painel</i> FIAT SIENA d24x16.5mm 1p-d16.5-14mm
	Z80588 NO. 7637466 <i>Mola de painel</i> FIAT MARENGO d24x16.5mm 1p-d16.5-14mm		Z80590 NO. 14569187 <i>Mola de painel</i> FIAT SIENA d22x22.5mm 1p-d10.4-20mm
	Z80604 NO. 7739801 - 500382985 <i>Mola de painel</i> FIAT SIENA d18.2x21.6mm 1p-d6.4-16.1mm		Z80612 NO. 7569468 <i>Mola de fixação</i> FIAT MARENGO d10x33.7mm 1p-d6-18.5mm

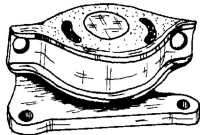
	<p>Z80619 NO. 7677865</p> <p><i>Mola de painel</i></p> <p>FIAT MARENGO</p> <p>d14x12mm 1p-d7.5-10mm</p>		<p>Z80625 NO. 82421028 - 504056662</p> <p><i>Mola de fixação</i></p> <p>FIAT MARENGO</p> <p>d18x42.5mm 1p-d8-19mm</p>
	<p>Z80631 NO. 14591887</p> <p><i>Mola de painel</i></p> <p>FIAT (TODOS)</p> <p>d15x25mm 1p-d8-23mm</p>		<p>Z80635 NO. 14216080 - 14216087</p> <p><i>Mola de fixação</i></p> <p>FIAT MARENGO</p> <p>d18x14mm 1p-10x10-12.5mm 1f-d4.8mm</p>
	<p>Z80643 NO. 7771637</p> <p><i>Mola de fixação</i></p> <p>FIAT MARENGO</p> <p>20x16x15.8mm 1p-d12.8-15mm</p>		<p>Z80645 NO. 7663916</p> <p><i>Mola de fixação</i></p> <p>FIAT (TODOS)</p> <p>16x14x16mm 1p-8x12-14mm 1f-d6.3mm</p>
	<p>Z80646 NO. 7578051</p> <p><i>Mola de fixação</i></p> <p>FIAT MARENGO</p> <p>13x17.8x15mm 1p-9x14-14mm 1f-d5.5mm</p>		<p>Z80664 NO. 14575380 - 17868880</p> <p><i>Mola de fixação</i></p> <p>FIAT (TODOS)</p> <p>25x25x13.2mm 1f-8mm</p>
	<p>Z80666 NO. 5962559</p> <p><i>Mola de fixação</i></p> <p>FIAT MARENGO</p> <p>d11x20mm 1p-d6.2-10mm</p>		<p>Z80667 NO. 4264257 - 14215282</p> <p><i>Mola de retenção</i></p> <p>FIAT (TODOS)</p> <p>11x11x9mm 1p-8x8-7.5mm 1f-d3.5mm</p>
	<p>Z80668 NO. 735266957</p> <p><i>Mola de painel</i></p> <p>FIAT SIENA</p> <p>d20x15.5mm 1p-d8.2-13mm</p>		<p>Z80669 NO. 7768047</p> <p><i>Mola de painel</i></p> <p>FIAT MARENGO</p> <p>d14x9.8mm 1p-d7.5-7.8mm</p>
	<p>Z80675 NO. 182911680</p> <p><i>Mola de painel</i></p> <p>FIAT MARENGO</p> <p>d20x24.4mm 1p-d9.5-10.6mm</p>		<p>Z80702 NO. 46408953 - 46748771</p> <p><i>Mola de fixação</i></p> <p>FIAT MARENGO</p> <p>d16x25.5mm 1p-8x8-24mm 1f-d4.8mm</p>
	<p>Z80703 NO. 5988006</p> <p><i>Mola de fixação</i></p> <p>FIAT MARENGO</p> <p>d15x24mm 1p-d6.5-12mm</p>		<p>Z80708 NO. 7630854</p> <p><i>Mola de fixação</i></p> <p>FIAT MARENGO</p> <p>d15x8.2mm 1p-6x6-6.6mm 1f-d4.8mm</p>







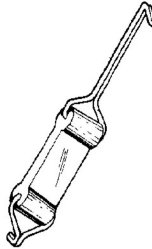
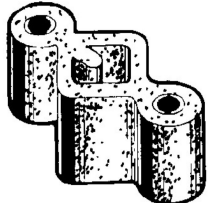
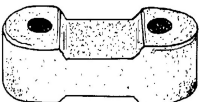
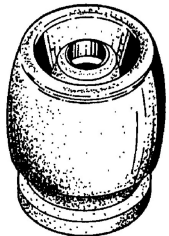
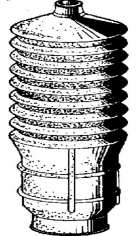
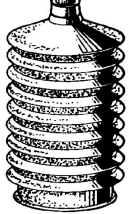
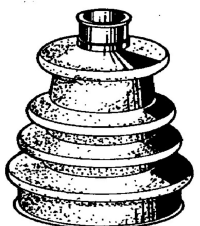
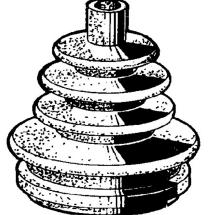



	<p>Z80727 NO. 7798971</p> <p>Mola de fixação</p> <p>FIAT SIENA</p> <p>d18x19mm 1p-d7.5-12mm</p>		<p>Z80804 NO. 7078732</p> <p>MOLA DE FRISO LATERAL PORTA FIAT</p> <p>FIAT</p> <p>28x10x6mm NULL</p>
	<p>Z80813 NO. 71742342</p> <p>NULL</p> <p>FIAT SEDICI</p> <p>d15.7x16.8mm 1p-d9.5-12.8mm</p>		<p>Z80829 NO. 940907332 - 9046707164 - 71741883</p> <p>NULL</p> <p>FIAT SEDICI</p> <p>d20x23.5mm 1p-d7.5-10.5mm</p>
	<p>Z80831 NO. 14189071</p> <p>Mola porca rápida</p> <p>FIAT LINEA</p> <p>22.3x15x8.5mm 1f-d6mm</p>		

FIAT 124-125-126-127-128













	<p>A0249 NO. 986678</p> <p>SUPORTE FRENTE DO MOTOR</p> <p>FIAT 126 - 126 TT</p> <p>65x38x34mm 1p-d8-17mm</p>		<p>A0605-I NO. 991293 - 4272883 - 4322578</p> <p>SUPORTE DA DIRECÇÃO</p> <p>FIAT 126 TT</p> <p>140x89x75mm 2f-d13mm</p>
	<p>A0614-I NO. 52007036</p> <p>SUPORTE DO MOTOR FRENTE E TRÁS</p> <p>FIAT 127 900cc (APÓS 5-1980) - 127 1.3 SPORT II SÉRIE</p> <p>115x90x53mm 1f-12mm</p>		<p>A0659-I NO. 4342689</p> <p>SUPORTE TRÁS DO MOTOR</p> <p>FIAT 127 900cc (DA VIAT. 8001421 A 8048805)</p> <p>158x117x88mm 1f-d12mm</p>
	<p>A0660-I NO. 4342563 - HB-00452301</p> <p>SUPORTE DIREITO DO MOTOR</p> <p>FIAT 127 900 cc</p> <p>130x115x95mm 1f-d11mm</p>		<p>A0661-I NO. 4194434</p> <p>SUPORTE FRENTE DO MOTOR</p> <p>FIAT 127 TT (900 CC A VIAT. 8001420)</p> <p>110x106x90mm 1f-d10mm</p>
	<p>A0662-I NO. 4404603</p> <p>SUPORTE FRENTE DO MOTOR E CAIXA</p> <p>FIAT 127 900cc (DA VIAT. 8048806 A 4-80)- 127 1050cc (DA VIAT. 8048806 A 11-1981) - 127 TT (3ª SÉRIE DESDE 12-1981)</p> <p>112x86x53mm 1f-d12mm</p>		<p>A0664-I NO. 4364544</p> <p>SUPORTE TRÁS DO MOTOR</p> <p>FIAT 127 1050cc (ATÉ VIATURA 8048805)</p> <p>155x120x76mm 1f-d12mm</p>

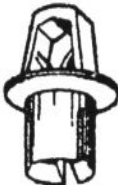
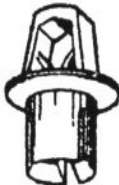
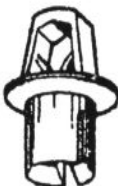
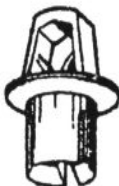

	<p>A0944 NO. 4368836 - 4235588 - 4235589 - 4204386 - 4204387 - 4448747</p> <p>SUPORTE DO MOTOR</p> <p>FIAT 127 (900 cm3 A VIATURA 2231088) - 128</p>		<p>A1948 NO. 4234725 - 5950748 - 4181556</p> <p>APOIO DA TRANSMISSÃO</p> <p>FIAT 124 (124_) 1200 (TA) (07.66 A 10.73) 60cv 1197cc três volumes - FIAT 124 (124_) 1200 (02.73 A 07.75) 65cv 1197cc três volumes - FIAT 124 (124_) 1400 (12.68 A 12.72) 70cv 1438cc três volumes - FIAT 124 (124_) 1500 (01.73 A 07.75) 75cv 1438cc três volumes - FIAT 124 (124_) 1500 (01.71 A 07.75) 80cv 1438cc três volumes - FIAT 124 (124_) 1600 (01.73 A 07.75) 95cv 1592cc três volumes - FIAT 124 Coupé (124_) 1400 Sport (06.67 A ...etc.</p>
	<p>A1948 NO. 4234725 - 5950748 - 4181556</p> <p>APOIO DA TRANSMISSÃO</p> <p>FIAT 125 (125_) 1.6 (TA) N.Â° VET a part ir de: 231901 (05.69 A 10.73) 100cv 1608cc três volumes</p>	 <p>ESC: 1/2</p>	<p>C0229 NO. 100816 - 4276430</p> <p>BOTÃO DE AFINAÇÃO DO CAPOT (GRANDE)</p> <p>FIAT 124 (124_) 1200 (TA) Local de montagem: à frente 44kW 60CV 1197cc três volumes (DE 07-66 ATÉ 10-73) FIAT 124 (124_) 1200 Local de montagem: à frente 48kW 65CV 1197cc três volumes (DE 02-73 ATÉ 07-75) FIAT 124 (124_) 1500 Local de montagem: à frente 59kW 80CV 1438cc três volumes (DE 01-71 ATÉ 07-75) FIAT 124 (124_) 1600 Local de montagem: à frente 70kW 95CV 1592cc três volumes (DE 01-73 ATÉ 07-75)</p>
 <p>ESC: 1/2</p>	<p>C0229 NO. 100816 - 4276430</p> <p>BOTÃO DE AFINAÇÃO DO CAPOT (GRANDE)</p> <p>FIAT 128 (128_) 1.1 Local de montagem: à frente 33kW 45CV 1116cc três volumes (DE 02-75 ATÉ 09-81) FIAT 128 (128_) 1.1 Local de montagem: à frente 40kW 55CV 1116cc três volumes (DE 03-69 ATÉ 12-84) FIAT 128 (128_) 1.3 Sport Local de montagem: à frente 44kW 60CV 1290cc três volumes (DE 08-74 ATÉ 12-84) FIAT 128 (128_) 1.3 Rally (AR) Local de montagem: à frente 49kW 67CV 1290cc três volumes (DE 09-71 ATÉ 02-76)</p>		<p>D0014 NO. 4516081 - 4516801</p> <p>CARDAN DA TRANSMISSÃO</p> <p>FIAT 124 TT - 124 SPORT TT - 125 TT</p>
	<p>D0046 NO. 4137179 - 6660030</p> <p>CARDAN VEIO LONGITUDINAL</p> <p>FIAT 126 (126_) 600 Local de montagem: traseira (09.72 A 06.77) 23cv 594cc Formato especial - FIAT 126 (126_) 650 Local de montagem: traseira (07.77 A 09.87) 23cv 652cc Formato especial - FIAT 126 (126_) 650 Local de montagem: traseira (07.81 A 09.00) 24cv 652cc Formato especial - FIAT 126 (126_) 700 Local de montagem: traseira (09.87 A 06.96) 26cv 704cc Formato especial</p>		<p>E0001 NO. 4126729 - 4373254</p> <p>ESTICADOR DE ESCAPE</p> <p>FIAT 127 (77-88) - 125 TT - 128 C - CL</p>
	<p>E0002 NO. 4214979</p> <p>ESTICADOR DE ESCAPE</p> <p>FIAT 128 TT</p>		<p>E0003 NO. 4296059 - 4312280 - 4306054 - 4422065 - 4297082 - 421281 - 4296060</p> <p>ESTICADOR DE ESCAPE</p> <p>FIAT 127 (71 A 88) - 128 (68 A 76) - 124 (67 A 74) - 124 SPECIAL (68 A 74) - 131 L - CL</p>
	<p>E0108-I NO. 4112293</p> <p>ESTICADOR DE ESCAPE</p> <p>FIAT 124 - 125 - 126 - 127 - 128</p>		<p>F0057-I NO. 4294117</p> <p>FOLE DO DIFERENCIAL LADO DA CAIXA (F1012)</p> <p>FIAT 127 - 128</p>
	<p>F0060-I NO. 4239459 - 4371156</p> <p>FOLE DA CREMALHEIRA DA DIRECÇÃO DIREITO (F1038)</p> <p>FIAT 126 TT - 127 TT - 128 TT</p>		<p>F0061-I NO. 4371155</p> <p>FOLE DA CREMALHEIRA DA DIRECÇÃO ESQUERDO</p> <p>FIAT 126 TT - 127 TT - 128 TT</p>
	<p>F0062-I NO. 4215015</p> <p>FOLE DO SEMI-EIXO JUNTO À RODA (F1005)</p> <p>FIAT 127 TT - 128 X1-9 (ATÉ 10-77)</p>		<p>F0077-I NO. 4093279 - 4454572</p> <p>FOLE DA ALAVANCA DA CAIXA DE VELOCIDADES</p> <p>FIAT 127 TT - 128 TT</p>

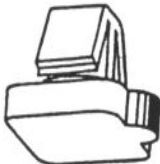
	<p>F0403-I NO. 4383758</p> <p>FOLE DO SEMI-EIXO JUNTO À RODA</p> <p>FIAT 127 - 128 - X1-9 (11-77 A 12-83)</p> <p>d80x80mm 1f-d70mm 1f-d20mm</p>		<p>F0468-I NO. 92601216</p> <p>FOLE ESQUERDO E DIREITO DO DIFERENCIAL COM CASQUILHO EM NYLON</p> <p>FIAT 127 (APÓS 10-82)</p> <p>d95x70mm 1f-d63mm 1f-d23mm</p>
	<p>F0479-I NO. HH-14153100</p> <p>FOLE DA TRANSMISSÃO JUNTO À CAIXA (COM CASQUILHO DE NYLON LISO FURO 25mm)</p> <p>FIAT 127 - 128</p> <p>d96x72mm 1f-d66mm 1f-d25mm</p>		<p>F0514-I NO. 5987092</p> <p>FOLE DO SEMI-EIXO JUNTO À RODA</p> <p>FIAT 127 (APÓS 1-84)</p> <p>d86x82mm 1f-d71mm 1f-d20mm</p>
	<p>F1822-I NO. 4315444 - 46307029</p> <p>FOLE DA TRANSMISSÃO JUNTO À CAIXA</p> <p>FIAT126 0.7 700 (72 A 00)</p> <p>d102x94mm 1f-d99mm 1f-d25mm</p>		<p>KF1730 NO. 5966569 - 5987092</p> <p>KIT FOLE DO LADO DA RODA</p> <p>FIAT 126 - 127 - 128 - X1-9</p> <p>d82x80mm 1f-d20mm 1f-d68mm</p>
	<p>KL0880-I NO.</p> <p>KIT DE REPARAÇÃO DA ALAVANCA À CAIXA DE VELOCIDADES</p> <p>FIAT 127 (III SÉRIE)</p> <p>NULL NULL</p>		<p>L0419-I NO. 4330731</p> <p>CASQUILHO DE NYLON CREMALHEIRA DA DIRECÇÃO</p> <p>FIAT 126 - 127</p> <p>28x28x18mm 1f-d21mm</p>
	<p>L1001 NO. 4292059</p> <p>CASQUILHO DO BRAÇO DA SUSPENSÃO FRENTE</p> <p>FIAT 127 TT (APÓS 1972) - 128 TT (APÓS VIAT.1024896)</p> <p>d30x39mm d25mm 1f-d9mm</p>		<p>L1011 NO. 4240587 - 4207922</p> <p>CASQUILHO DO BRAÇO DA SUSPENSÃO (PONTAS DA BARRA ESTABILIZADORA)</p> <p>FIAT 127 - 128 TT</p> <p>d34x21mm 1f-d16mm</p>
	<p>L1022 NO. 4227114 - 4223535</p> <p>CASQUILHO DE AMORTECEDOR TRASEIRO</p> <p>FIAT 127 TT (DIESEL - GASOLINA) - 128</p> <p>d43x20mm 1f-12mm</p>		<p>L3009 NO. SE138162130A</p> <p>CASQUILHO DA EXTREMIDADE DA CREMALHEIRA DA DIRECÇÃO</p> <p>FIAT 127</p> <p>32x32x18mm d28mm 1f-d22mm</p>
	<p>P0009-R NO. 4144275</p> <p>CAPA DE PEDAL TRAVÃO E EMBRAIAGEM</p> <p>FIAT 127 - 124 TT - 124 SPORT TT - 125 - 1100 R - 128 TT - 850 TT</p> <p>63x50x12mm NULL</p>		<p>P1016 NO. 4144275</p> <p>CAPA DE PEDAL DO TRAVÃO E EMBRAIAGEM</p> <p>FIAT 127 TT</p> <p>65x50x10mm NULL</p>
	<p>P1018 NO. SE021110044A - 4187379</p> <p>CAPA DO PEDAL DO ACELARADOR</p> <p>FIAT 127</p> <p>96x43x6mm NULL</p>		<p>P1052 NO. 4144275</p> <p>CAPA DE PEDAL DO TRAVÃO E EMBRAIAGEM</p> <p>FIAT 124 - 127 - 128</p> <p>67x53x12mm NULL</p>









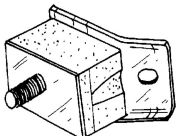

	<p>R021813 NO. 4196726 - 4291934 - 7533916 - 7604290</p> <p>TUBO DE LIGAÇÃO DA BOMBA DE ÁGUA À TUBAGEM RÍGIDA DO RADIADOR FIAT 128 TT</p> <p>B110-d31/35mm 60-80mm</p>		<p>R021814 NO. 4200511</p> <p>TUBO INFERIOR DO RADIADOR FIAT 128 (ATÉ VIAT. 1180651)</p> <p>B295-d31/32mm 75-100-165mm</p>
	<p>R021815 NO. 4216049</p> <p>TUBO SUPERIOR DO RADIADOR FIAT 128 RALLY</p> <p>B240-d34/30mm 145-95-110mm</p>		<p>R021819 NO. 4202357</p> <p>TUBO DE LIGAÇÃO AO DEPÓSITO FIAT 128 TT</p> <p>B185-d50/50mm 130-65mm</p>
	<p>S0003 NO. 4251331</p> <p>SILENT-BLOC DO TRIÂNGULO DA SUSPENSÃO TRASEIRO (CURTO) FIAT 127</p> <p>d38x32mm d27mm 1f-d13mm</p>		<p>S0004 NO. 4434652 - 4404623 - 557001105</p> <p>SILENT-BLOC DO TRIÂNGULO DA SUSPENSÃO TRASEIRO (COMPRIDO) FIAT 127(APÓS 10-77)</p> <p>d38x39mm d27mm 1f-d13mm</p>
	<p>T0002 NO. 4233062 - HB-15623500</p> <p>BATENTE CENTRAL DA BARRA ESTABILIZADORA DA SUSPENSÃO FRENTE FIAT 127 TT</p> <p>43x40x32mm 1f-d19mm</p>		<p>T0002-E NO.</p> <p>BATENTE DE ESCAPE FIAT 127 (71-82) - FIAT 128 (69-76)</p> <p>d34x34mm 1f-d5mm</p>
	<p>Z10348 NO. 14587570</p> <p>Mola de painel FIAT 126</p> <p>30x14x16.5mm 1p-d8.4-8.5mm</p>		<p>Z10408 NO.</p> <p>Mola de retenção Fiat 128</p> <p>NULL NULL</p>
	<p>Z10409 NO.</p> <p>Mola de fixação Fiat 125</p> <p>d13x11mm 1p-d9.5-9mm 1f-d6mm</p>		<p>Z10422 NO.</p> <p>Mola de painel Fiat 128</p> <p>9x6x12.5mm 1p-d4.5-11.5mm</p>
	<p>Z10703 NO.</p> <p>Mola de friso Fiat 124</p> <p>NULL NULL</p>		<p>Z10705 NO.</p> <p>Mola de friso Fiat 128</p> <p>NULL NULL</p>
	<p>Z10845 NO. 14203080</p> <p>Mola de fixação Fiat 126 - 127 -128</p> <p>15x15x21mm 1p-11x11-19.5mm 1f-d5.5mm</p>		<p>Z80230 NO. 4343591</p> <p>Mola de friso Fiat 127 - 128</p> <p>NULL NULL</p>

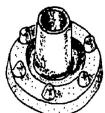

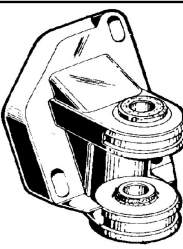
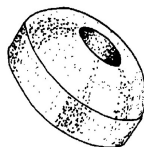



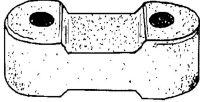

	Z80241 NO. 4395881 <i>Mola de friso</i> Fiat 127 L - 127 C - 127 CL NULL NULL		Z80243 NO. 14187880 <i>Mola de painel</i> FIAT 128 d17x17.5mm 1p-d8-11.5mm
	Z80243 NO. 14187880 <i>Mola de painel</i> FIAT 127 d17x17.5mm 1p-d8-11.5mm		Z80243 NO. 14187880 <i>Mola de painel</i> FIAT 126 d17x17.5mm 1p-d8-11.5mm
	Z80243 NO. 14187880 <i>Mola de painel</i> FIAT 125 d17x17.5mm 1p-d8-11.5mm		Z80245 NO. 4241451 <i>Mola de fixação</i> FIAT 128 d14x18mm 1p-7.5x6-9mm
	Z80245 NO. 4241451 <i>Mola de fixação</i> FIAT 127 d14x18mm 1p-7.5x6-9mm		Z80245 NO. 4241451 <i>Mola de fixação</i> FIAT 126 d14x18mm 1p-7.5x6-9mm
	Z80245 NO. 4241451 <i>Mola de fixação</i> FIAT 125 d14x18mm 1p-7.5x6-9mm		Z80247 NO. 14188380 <i>Mola de painel</i> FIAT 127 d16x18.6mm 1p-d7.5-12.6mm
	Z80247 NO. 14188380 <i>Mola de painel</i> FIAT 126 d16x18.6mm 1p-d7.5-12.6mm		Z80345 NO. 4303883 <i>Mola de painel</i> FIAT 126 d15x24mm 1p-d8-21.5mm
	Z80346 NO. 4310258 <i>Mola de painel</i> FIAT 126 d12x15mm 1p-d7-13.5mm		Z80346 NO. 4310258 <i>Mola de painel</i> FIAT 125 d12x15mm 1p-d7-13.5mm
	Z80350 NO. 4294167 <i>Mola de friso</i> FIAT 127 NULL NULL		Z80352 NO. 14567187 - 17886087 <i>Mola de painel</i> FIAT 127 d15x19mm 1p-d8-16.5mm

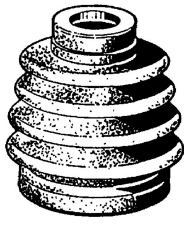
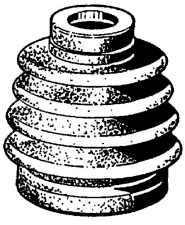
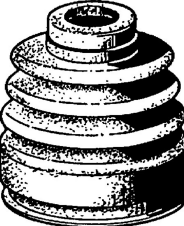

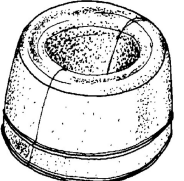
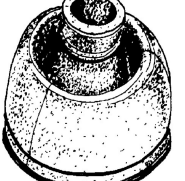
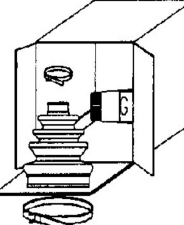
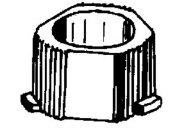
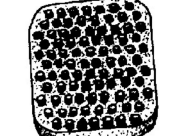
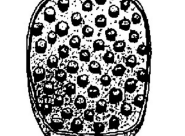





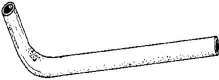

	<p>Z80352 NO. 14567187 - 17886087</p> <p>Mola de painel</p> <p>FIAT 126</p> <p>d15x19mm 1p-d8-16.5mm</p>		<p>Z80352 NO. 14567187 - 17886087</p> <p>Mola de painel</p> <p>FIAT 125</p> <p>d15x19mm 1p-d8-16.5mm</p>
	<p>Z80430 NO. 1118730</p> <p>Mola de painel</p> <p>FIAT 128</p> <p>d18x24.5mm 1p-d11.2-22mm</p>		<p>Z80469 NO. 5938663</p> <p>Mola de painel</p> <p>FIAT 127</p> <p>27x16.4x17mm 1p-d8.3-9.5mm</p>
	<p>Z80478 NO. 7696564</p> <p>Mola de fixação</p> <p>FIAT 127</p> <p>13x13x12.5mm 1p-10x10-11mm 1f-d3.9mm</p>		<p>Z80502 NO. 5757553</p> <p>Mola de retenção</p> <p>FIAT 126</p> <p>d16x9.5mm 1p-7x7-8.5mm 1f-d4.8mm</p>
	<p>Z80513 NO. 7544349</p> <p>Mola de fixação</p> <p>FIAT 128</p> <p>NULL NULL</p>		<p>Z80513 NO. 7544349</p> <p>Mola de fixação</p> <p>FIAT 127</p> <p>NULL NULL</p>
	<p>Z80513 NO. 7544349</p> <p>Mola de fixação</p> <p>FIAT 126</p> <p>NULL NULL</p>		<p>Z80513 NO. 7544349</p> <p>Mola de fixação</p> <p>FIAT 125</p> <p>NULL NULL</p>
	<p>Z80519 NO. 4358789</p> <p>Mola de fixação</p> <p>FIAT 128</p> <p>d11x9mm 1p-d8.5-7.8mm 1f-d3mm</p>		<p>Z80549 NO. 5938665</p> <p>Mola de friso</p> <p>FIAT 127</p> <p>NULL NULL</p>
	<p>Z80549 NO. 5938665</p> <p>Mola de friso</p> <p>FIAT 127 3ª série</p> <p>NULL NULL</p>		<p>Z80590 NO. 14569187</p> <p>Mola de painel</p> <p>FIAT 127</p> <p>d22x22.5mm 1p-d10.4-20mm</p>
	<p>Z80653 NO. 14211580</p> <p>Mola de fixação</p> <p>FIAT 126</p> <p>9x9x10mm 1p-7x7-9mm 1f-d4.2mm</p>		<p>Z80653 NO. 14211580</p> <p>Mola de fixação</p> <p>FIAT 125</p> <p>9x9x10mm 1p-7x7-9mm 1f-d4.2mm</p>



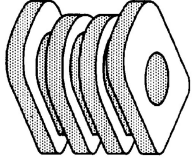



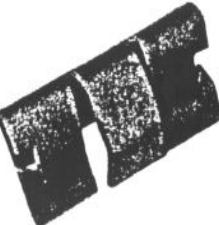



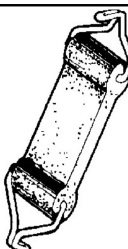

	Z80666	NO. 5962559		Z80666	NO. 5962559
	Mola de fixação FIAT 127			Mola de fixação FIAT 126	
	d11x20mm	1p-d6.2-10mm		d11x20mm	1p-d6.2-10mm

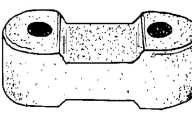
FIAT 500-600-850-1100

	A0249	NO. 986678		A0290	NO. 4108581 - 870286
	SUPPORTO FRENTA DO MOTOR FIAT 500 TT			SUPPORTO FRENTA DO MOTOR FIAT 600 M - D - DM	
	65x38x34mm	1p-d8-17mm		64x37x37mm	1p-d8-17mm
	A0558	NO. 4112339		A0559	NO. 4218483 - 4218479
	SUPPORTO DO MOTOR COMPLEMENTO FIAT 850			SUPPORTO DO MOTOR COMPLEMENTO FIAT 850 TT	
	d62x36mm	1f-d13mm		d51x38mm	1f-d9mm 1f-d15mm
	A0560	NO. 878166		A0605-I	NO. 991293 - 4272883 - 4322578
	SUPPORTO DO MOTOR SUPERIOR TRÁS COMPLEMENTO FIAT 600 TT - 850			SUPPORTO DA DIRECCÃO FIAT 500 TT - 850 TT	
	d53x18mm	1f-d20mm		140x89x75mm	2f-d13mm
	A0777	NO. 878165		D0046	NO. 4137179 - 6660030
	SUPPORTO DO MOTOR INFERIOR TRÁS COMPLEMENTO FIAT 600 TT			CARDAN VEIO LONGITUDINAL FIAT 500 0.5 Ano fabric. a part ir de: 06.61, Local de montagem: traseira (01.57 A 12.61) 15cv 476cc Formato especial - FIAT 500 0.5 Local de montagem: traseira (01.65 A 01.76) 18cv 499cc Formato especial - FIAT 500 0.6 Local de montagem: traseira (08.68 A 01.76) 18cv 594cc Formato especial	
	d60x28mm	d20mm		d78x45mm	1f-d22mm 4r-d8mm
	D0046	NO. 4137179 - 6660030		D0046	NO. 4137179 - 6660030
	CARDAN VEIO LONGITUDINAL FIAT 600 0.8 (D) Tipo de motor: M TT, Local de montagem: traseira (10.60 A 02.71) 23cv 767cc Formato especial			CARDAN VEIO LONGITUDINAL FIAT 850 0.8 Special (GB) N.º VET at é: 187047, Local de montagem: traseira (03.68 A 10.72) 48cv 843cc três volumes - FIAT 850 Coupé (100_) 0.9 Sport N.º VET at é: 187047, Local de montagem: traseira (02.68 A 10.72) 52cv 903cc Coupé - FIAT 850 Spider 0.8 N.º VET at é: 187047, Local de montagem: traseira (10.65 A 10.68) 49cv 843cc Cabriolet - FIAT 850 Spider 0.9 Sport N.º VET at é: 187047, Local de montagem: traseira (03.68 A ...etc.	
	d78x45mm	1f-d22mm 4r-d8mm		d78x45mm	1f-d22mm 4r-d8mm
	E0108-I	NO. 4112293		E0176	NO. 50700941 - 50700464
	ESTICADOR DE ESCAPE FIAT 1100D			ESTICADOR DA BARRA ESTABILIZADORA DA FRENTA FIAT 500 (MOD.2007) TT	
	90x35x24mm	2f-d12mm		320x35x35mm	2p-d10-25mm















	<p>F0834-I NO. 7621245</p> <p>FOLE DO DIFERENCIAL SEMI-EIXO DIREITO</p> <p>FIAT 500 (APÓS 2-86)</p> <p>d91x82mm 1f-d65mm 1f-d32mm</p>		<p>F0834A-I NO. 7621245</p> <p>FOLE DO DIFERENCIAL SEMI-EIXO DIREITO COM ROLAMENTO d23mm</p> <p>FIAT 500 (APÓS 2-86)</p> <p>d93x90mm 1f-d23mm</p>
	<p>F0835-I NO. 7625541</p> <p>FOLE ESQUERDO DO DIFERENCIAL LADO CAIXA</p> <p>FIAT 500 (APÓS 2-86)</p> <p>d90x85mm 1f-d77mm 1f-d22.8mm</p>		<p>F0835A-I NO. 7625541</p> <p>FOLE ESQUERDO DO DIFERENCIAL LADO CAIXA COM ROLAMENTO</p> <p>FIAT 500</p> <p>d90x85mm 1f-d77mm 1f-d22.8mm</p>
	<p>F9244 NO. 4084637</p> <p>FOLE - RESGUARDO DA TRANSMISSÃO</p> <p>FIAT 600 D - 850</p> <p>d90x50mm 1f-d28mm</p>		<p>F9245 NO. 899992</p> <p>FOLE - RESGUARDO DA TRANSMISSÃO</p> <p>FIAT 600</p> <p>d64x53mm 1f-d16mm</p>
	<p>KF1775 NO. 7642776</p> <p>KIT FOLE DO LADO DA RODA</p> <p>FIAT 500</p> <p>d90x79mm 1f-d21mm 1f-d76mm</p>		<p>L0419-I NO. 4330731</p> <p>CASQUILHO DE NYLON CREMALHEIRA DA DIRECÇÃO</p> <p>FIAT 500</p> <p>28x28x18mm 1f-d21mm</p>
	<p>P0009-R NO. 4144275</p> <p>CAPA DE PEDAL TRAVÃO E EMBRAIAGEM</p> <p>FIAT 850 TT - 1100 R</p> <p>63x50x12mm NULL</p>		<p>P0084 NO.</p> <p>CAPA DE PEDAL</p> <p>FIAT 850</p> <p>65x46x10mm NULL</p>
	<p>P1052 NO. 4144275</p> <p>CAPA DE PEDAL DO TRAVÃO E EMBRAIAGEM</p> <p>FIAT 850 - 850 T - 1100R</p> <p>67x53x12mm NULL</p>		<p>P1099 NO. 4079787</p> <p>CAPA DO PEDAL DO TRAVÃO E EMBRAIAGEM</p> <p>FIAT 500 0.5 (01.65 A 01.76) 18cv 499cc Formato especial - FIAT 500 0.6 (05.73 A 01.76) 18cv 594cc Formato especial - FIAT 850 0.8 (07.64 A 10.72) 37cv 843cc três volumes</p> <p>59x45x10mm 46-40mm</p>
	<p>R017245 NO. 51787531</p> <p>TUBO SUPERIOR RADIADOR</p> <p>FIAT 500 (312_) 1.3 D Multijet (A Partir 10.07) 75cv 1248cc Hatchback</p> <p>B370-26/28mm 160-100-130-70mm</p>		<p>R019110 NO. 46407689</p> <p>TUBO INFERIOR DO RADIADOR</p> <p>FIAT SEICENTO / 600 (187_) 1.1 (187AXB, 187AXB1A) Mod. tipo: SUITE - SPORTING, Tubagem de ref. rigeração: do radiador do aquecimento para o motor (01.98 A 01.10) 54cv 1108cc Hatchback</p> <p>NULL NULL</p>
	<p>R021101 NO. 4057134 - 102283 - 60502989 - 7595759 - 11530788160 - 11531258300 - 1818521</p> <p>TUBO DE LIGAÇÃO DA BOMBA DE ÁGUA AO COLECTOR</p> <p>FIAT 1100 D - R - 1200</p> <p>B165-d14/14mm 55-145mm</p>		<p>R0311 NO.</p> <p>TUBO SUPERIOR DO RADIADOR</p> <p>FIAT 850</p> <p>B160-d32/34mm 80-80mm</p>



	R0495 NO. TUBO DA CHAUFAGE PEQUENO FIAT 850 B320-d15/15mm 90-280mm		R0496 NO. TUBO INFERIOR DO RADIADOR FIAT 850 (1966-1968) B315-d30/30mm 210-170mm
	R220001 NO. 32126 TUBO INFERIOR DO RADIADOR FIAT 1100 TT B250-d30/30mm 95-160-60mm		S1595 NO. 50511650 - 50521486 - 51783056 - 51783057 SILENT-BLOC BRAÇO SUPERIOR FRENTE FIAT 500L (351_, 352_) 0.9 (A partir de 09.12) 105cv 875cc Hatchback d53x67mm d41mm 1f-d14mm
	T0009 NO. 4132370 - 4101897 BATENTE CENTRAL DA BARRA ESTABILIZADORA DA SUSPENSÃO FRENTE E TRÁS (SÓ FRENTE NO 850) FIAT 850 - 850 S - 850 SPORT 40x40x30mm 1f-d14mm		U10489 NO. 4109523 - 2101-2945450 - FA-15662600 CASQUILHO DE AMORTECEDOR FIAT 850 d40x14mm 1f-d13mm
	W5054 NO. 46819147 - 55200498 POLIE DA CAMBOTA (6 PISTAS) FIAT 500 (MOD 2007) 1.3 16V JTDM APÓS 07-2007 - Mtr 169A1000 (75CV) d165mm d35mm		W5145 NO. 55210310 - 0614359 - 614359 - 93192547 POLIE DA CAMBOTA 6 PISTAS FIAT 500L (199_) 1.6 D Multijet (APÓS 09.12) 105cv 1598cc Hatchback - FIAT 500L (199_) 1.6 D Multijet (APOS 09.13) 120cv 1598cc Hatchback d169mm d30,5mm
	Z10348 NO. 14587570 Mola de painel FIAT 500 30x14x16.5mm 1p-d8.4-8.5mm		Z29783 NO. Mola de friso Fiat 600 NULL NULL
	Z29796 NO. 883480 Mola de fixação FIAT 600 NULL NULL		Z29824 NO. Mola de friso Fiat 1100 23x19.7x18mm NULL
	Z30906 NO. 141870176 Mola de painel FIAT 600 15x10x21mm NULL		Z30906 NO. 141870176 Mola de painel FIAT 500 15x10x21mm NULL
	Z32004 NO. 4053933 Mola de friso FIAT 600 22x17x17mm NULL		Z80243 NO. 14187880 Mola de painel FIAT 500 d17x17.5mm 1p-d8-11.5mm

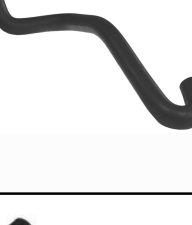
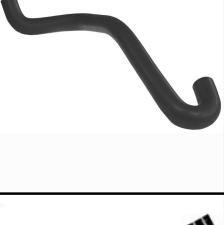

 <p>ESC: 1/2</p>	<p>C0229 NO. 100816 - 4276430</p> <p><i>BOTÃO DE AFINAÇÃO DO CAPOT (GRANDE)</i></p> <p>FIAT 132 (132_) 1.6 Local de montagem: à frente 65kW 88CV 1585cc três volumes (DE 05-77 ATÉ 09-82) FIAT 132 (132_) 1.6 Local de montagem: à frente 66kW 90CV 1585cc três volumes (DE 03-77 ATÉ 12-81) FIAT 132 (132_) 1.6 Local de montagem: à frente 72kW 98CV 1585cc três volumes (DE 01-76 ATÉ 12-82) FIAT 132 (132_) 1.6 Local de montagem: à frente 72kW 98CV 1592cc três volumes (DE 04-72 ATÉ 01-76) FIAT 132 (132_) 1.7 Special NULL etc.</p>		<p>D0014 NO. 4516081 - 4516801</p> <p><i>CARDAN DA TRANSMISSÃO</i></p> <p>FIAT 132 TT - ARGENTA TT</p> <p>140x130x80mm 6f-d12mm</p>
	<p>E0001 NO. 4126729 - 4373254</p> <p><i>ESTICADOR DE ESCAPE</i></p> <p>FIAT ARGENTA TT - 132 TT</p> <p>130x32x15mm NULL</p>		<p>E0041 NO. 4393777</p> <p><i>ESTICADOR DE ESCAPE</i></p> <p>FIAT ARGENTA (81-86) - FIAT 132 (78-84)</p> <p>76x64x15mm NULL</p>
	<p>E0108-I NO. 4112293</p> <p><i>ESTICADOR DE ESCAPE</i></p> <p>FIAT 132 GASOLINA</p> <p>90x35x24mm 2f-d12mm</p>		<p>M6042 NO. 4152873 - 4166914 - 82460789 - 4177919 - 7681460</p> <p><i>JUNTA DE ESCAPE</i></p> <p>FIAT ARGENTA (1981 A 1986)</p> <p>115x72mm 2f-d40mm</p>
	<p>N3727 NO.</p> <p><i>ANEL DE ESCAPE</i></p> <p>FIAT 132 DIESEL - ARGENTA</p> <p>d55x12mm 1f-d31mm</p>		<p>Z80230 NO. 4343591</p> <p><i>Mola de friso</i></p> <p>Fiat 132</p> <p>NULL NULL</p>
	<p>Z80243 NO. 14187880</p> <p><i>Mola de painel</i></p> <p>FIAT 132</p> <p>d17x17.5mm 1p-d8-11.5mm</p>		<p>Z80245 NO. 4241451</p> <p><i>Mola de fixação</i></p> <p>FIAT 132</p> <p>d14x18mm 1p-7.5x6-9mm</p>
	<p>Z80346 NO. 4310258</p> <p><i>Mola de painel</i></p> <p>FIAT 132</p> <p>d12x15mm 1p-d7-13.5mm</p>		<p>Z80352 NO. 14567187 - 17886087</p> <p><i>Mola de painel</i></p> <p>FIAT 132</p> <p>d15x19mm 1p-d8-16.5mm</p>
	<p>Z80499 NO. 4399987</p> <p><i>Mola de painel</i></p> <p>FIAT 132</p> <p>d19.5x18mm 1p-d8-10.8mm</p>		<p>Z80513 NO. 7544349</p> <p><i>Mola de fixação</i></p> <p>FIAT 132</p> <p>NULL NULL</p>
	<p>Z80653 NO. 14211580</p> <p><i>Mola de fixação</i></p> <p>FIAT 132</p> <p>9x9x10mm 1p-7x7-9mm 1f-d4.2mm</p>		

	<p>A1642 NO. 46407326</p> <p>APOIO DO MOTOR LADO DA CAIXA</p> <p>FIAT BRAVO-BRAVA 1.9D - 1.9 TD 75CV-100CV - FIAT BRAVO-BRAVA GAMMA 98 1.2 FIAT MAREA 1.9 TD 75CV-100CV - FIAT MAREA GAMMA 99 1.2 16V FIAT MULTIPLA 1.9 JTD</p> <p>170x110x80mm 1r-d12mm 1f-d12 - 6mm</p>		<p>A1687 NO. 46444057 - 464467329</p> <p>APOIO DO MOTOR LADO DO DIFERENCIAL</p> <p>FIAT BRAVO - BRAVA 1.6 - 1.9TD (75CV) - BRAVO - BRAVA GAMA 98 1.6 1.9TD (100CV) - 1.9 TD (75CV) - MAREA 2.4 TD - MAREA GAMA 99 1.9 JTD (105CV) - 1.9 TD (75CV) - 2.4 JTD (136CV)</p> <p>170x105x58mm 1f-d12mm</p>
	<p>A1688 NO. 46781213</p> <p>APOIO DO MOTOR PARTE DE TRÁS</p> <p>FIAT BRAVO-BRAVA GAMA 98 1.9 JTD (105CV) - 1.9 TD (105CV) - 1.9 TD (75CV) - MAREA GAMA 99 1.9 JTD (105CV) - 2.4 JTD (136CV)</p> <p>170x109x95mm 1f-d11mm</p>		<p>A1745 NO. 50702841</p> <p>APOIO DO AMORTECEDOR DA FRENTE</p> <p>FIAT BRAVO 1.4 - 1.9D MULTIJET (APÓS 04-2007)</p> <p>122x54mm 1f-d12mm</p>
	<p>E0176 NO. 50700941 - 50700464</p> <p>ESTICADOR DA BARRA ESTABILIZADORA DA FRENTE</p> <p>FIAT BRAVO (MOD.2007) TT</p> <p>320x35x35mm 2p-d10-25mm</p>		<p>E1051 NO. 60811810</p> <p>ESTICADOR DE ESCAPE</p> <p>FIAT BRAVA (APÓS 1995) - BRAVO (APÓS 1996)</p> <p>67x48x19mm NULL</p>
data-bbox="41 418 175 491"/>	<p>E1085 NO. 7749062</p> <p>ESTICADOR DE ESCAPE (PARTE CENTRO)</p> <p>FIAT BRAVA - BRAVO (APÓS 1998) - MAREA (APÓS 1999)</p> <p>65x55x25mm NULL</p>	data-bbox="494 418 628 491"/>	<p>E1106 NO. 4629211 - 46546376</p> <p>ESTICADOR DO ESCAPE PARTE DE TRÁS</p> <p>FIAT - BRAVO II (198) 1.6 D MULTIJET Hatchback 105CV 1598cc (APÓS 03-2008) - 1.9 D MULTIJET Hatchback 116cv 1910Ccc (APÓS 11-2006) - 1.9 D MULTIJET Hatchback 120CV 1910cc (APÓS 04-2007) - 1.9 D MULTIJET Hatchback 150CV 1910cc (APÓS 04-2007)</p> <p>55x45x25mm 2f-d10mm</p>
	<p>E1152-C NO. 60809242 - 7601647</p> <p>ESTICADOR DA BARRA ESTABILIZADORA DA FRENTE</p> <p>FIAT BRAVA - BRAVO TT</p> <p>120x35x32mm 1f-d12mm</p>		<p>F0469-I NO. 43307029 - 82282140</p> <p>FOLE DA TRANSMISSÃO LADO DA CAIXA</p> <p>FIAT BRAVA 1.8 - BRAVO 1.8 - 2.0</p> <p>d85x80mm 1f-d61mm 1f-d23mm</p>
	<p>F0799B-I NO. 46307462</p> <p>FOLE DA TRANSMISSÃO JUNTO À CAIXA</p> <p>FIAT MAREA 2.4 JTD - 2.4 TD (1996 A 2001) - STILO 1.9 JTD 16V (APÓS 2001)</p> <p>d80x100mm 1f-d58mm 1f-d23mm</p>		<p>F0835-I NO. 7625541</p> <p>FOLE ESQUERDO E DIREITO DO DIFERENCIAL LADO CAIXA</p> <p>FIAT BRAVA - BRAVO - 1.6 (1580, 16V 103 CV 75 Kw) (1580 16V 90 CV 66 Kw) (APÓS 9-95) - BRAVO - BRAVA DIESEL 1930 cc. (APÓS 9-95)</p> <p>d90x85mm 1f-d77mm 1f-d22.8mm</p>
	<p>F0835A-I NO. 7625541</p> <p>FOLE ESQUERDO DO DIFERENCIAL LADO CAIXA COM ROLAMENTO</p> <p>FIAT BRAVA - BRAVO - 1.6 - BRAVO - BRAVA DIESEL 1930 cc. (APÓS 9-95)</p> <p>d90x85mm 1f-d77mm 1f-d22.8mm</p>		<p>F0835A5I NO. 46307071 - 46307436 - 46307503 - 46307784 - 60813077</p> <p>FOLE DA TRANSMISSÃO JUNTO À CAIXA</p> <p>FIAT BRAVA (03-1996 A 10-2001) 1.6 i 16V - 1.9 TD - BRAVO 1 (03-1996 A10-2001) 1.6i 16V - 1.9 TD</p> <p>d93x87mm 1f-d79mm 1f-d24.4mm</p>
	<p>F0835A5I NO. 46307071 - 46307436 - 46307503 - 46307784 - 60813077</p> <p>FOLE DA TRANSMISSÃO JUNTO À CAIXA</p> <p>FIAT MAREA (09-1996 A 09-2001) 1.6i 16V - 1.6i CNG BIPOWER 16V</p> <p>d93x87mm 1f-d79mm 1f-d24.4mm</p>		<p>F0897-I NO. 82483504</p> <p>FOLE JUNTO À RODA</p> <p>FIAT BRAVA 1.8 (APÓS 9-1995) - BRAVO 1.8 - 2.0 (APÓS 9-1995)</p> <p>d100x98mm 1f-d86mm 1f-d26mm</p>

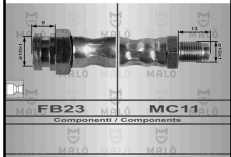
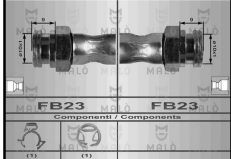











	<p>F1127H-I NO. 9947369 - 9941582</p> <p>FOLE DA DIRECÇÃO ESQUERDO E DIREITO</p> <p>FIAT BRAVO - BRAVA (APÓS 95)</p> <p>d62x210mm 1f-d58mm 1f-d10mm</p>		<p>F1137-I NO. 7746232 - 7715294 - 46307644 - 51704105</p> <p>FOLE DO LADO DA CAIXA</p> <p>FIAT BRAVA 1.4 (APÓS 9-95) - BRAVO 1.4 (APÓS 9-95)</p> <p>d76x90mm 1f-d60mm 1f-d19mm</p>
	<p>F1181-I NO. 7545579 - 9945564</p> <p>FOLE DA DIRECÇÃO ESQUERDO E DIREITO</p> <p>FIAT BRAVA 1.4 (APÓS 9-95) - BRAVO 1.4 (APÓS 9-95)</p> <p>d63x155mm 1f-d45mm 1f-d10mm</p>		<p>F1822-I NO. 4315444 - 46307029</p> <p>FOLE DA TRANSMISSÃO JUNTO À CAIXA</p> <p>FIAT BRAVA 1.8iGT 16V - 1.9JTD (95 A 01)</p> <p>d102x94mm 1f-d99mm 1f-d25mm</p>
	<p>F1822-I NO. 4315444 - 46307029</p> <p>FOLE DA TRANSMISSÃO JUNTO À CAIXA</p> <p>FIAT BRAVO 1.8iGT - 1.9JTD - 2.0IHGT 20 V (95 A 01)</p> <p>d102x94mm 1f-d99mm 1f-d25mm</p>		<p>F1822-I NO. 4315444 - 46307029</p> <p>FOLE DA TRANSMISSÃO JUNTO À CAIXA</p> <p>FIAT MAREA 1.8i 16V - 1.9JTD - 1.9TD - 2.0i 20V (96 A 01)</p> <p>d102x94mm 1f-d99mm 1f-d25mm</p>
	<p>F1824-I NO. 46307841</p> <p>FOLE DA TRANSMISSÃO JUNTO À CAIXA</p> <p>FIAT BRAVA 1.9 JTD - 1.9 TD S (1995 A 2001) - BRAVO 1.9 JTD - 1.9 TD S (1995 A 2001) - MAREA 1.8i 16V - 1.9 JTD - 1.9 TD (1996 A 2001) - MULTIPLA 1.9 JTD (APÓS 1999) - PUNTO II 1.3 JTD 16V - 1.9 JTD (APÓS 1999) - STRADA 1.9 JTD (APÓS 1999)</p> <p>d85x110mm 1f-d70mm 1f-d21mm</p>		<p>F1910-T NO. 40308383 - 46308480 - 1607740880 - LR003160 - 39242EB30B - C9241EB30A</p> <p>FOLE DO EIXO DE TRANSMISSÃO LADO DA RODA</p> <p>FIAT BRAVO II (198_) 1.4 16V (A Partir de 03.08) 140cv 1368cc Hatchback - FIAT BRAVO II (198_) 2.0 D Multijet (A Partir de 09.08) 165cv 1956cc Hatchback</p> <p>d120x150mm 1f-d28mm 1f-d100mm</p>
	<p>F9052H-I NO. 46308465</p> <p>FOLE DO CARDAN LADO DA RODA</p> <p>FIAT BRAVO II (198) 1.6 D Multijet (198 A2.000) 120CV (APÓS 03-2008) - 1.6 D Multijet (198 A3.000) 105CV (APÓS 03-2008) - 1.9 D Multijet (192 A8.000) 120CV (APÓS 04-2007)</p> <p>d105x125mm 1f-d28mm 1f-d88mm</p>		<p>F9052H-I NO. 46308465</p> <p>FOLE DO CARDAN LADO DA RODA</p> <p>FIAT LINEA (323) 1.3 D Multijet (199 A3.000) 90CV (APÓS 06-2007) - 1.4 T-Jet 198 A4.000 120CV (APÓS 09-2007) - 1.6 D Multijet (198 A3.000) 105CV (APÓS 06-2009)</p> <p>d105x125mm 1f-d28mm 1f-d88mm</p>
	<p>KT0503 NO. 51792434</p> <p>KIT DE BATENTE SUSPENSÃO FRENTE</p> <p>FIAT LINEA (323_) 1.4 (APÓS 06.07) 77cv 1368cc três volumes - FIAT LINEA (323_) 1.4 T-Jet (APÓS 09.07) 120cv 1368cc três volumes - FIAT LINEA (323_) 1.3 D Multijet (APÓS 06.07) 90cv 1248cc três volumes - FIAT LINEA (323_) 1.6 D Multijet (APÓS 06.09) 105cv 1598cc três volumes</p> <p>d62x268mm 1f-d14mm 1f-d60mm</p>		<p>M6074 NO. 82473208 - 82423525</p> <p>JUNTA DE ESCAPE</p> <p>FIAT BRAVO (APÓS 1995) - BRAVA (APÓS 1995)</p> <p>96x96mm 1f-d53.5mm</p>
	<p>P1065 NO. 7777407</p> <p>CAPA DE PEDAL DO TRAVÃO</p> <p>FIAT BRAVA - BRAVO I (182) 1.2 16V 80 (10-2000 A 10-2001) 80CV 1242CC - FIAT BRAVA - BRAVO I (182) 1.2 16V 80 (12-1998 A 12-2002) 82CV 1242CC - FIAT BRAVA - BRAVO I (182) 1.4 (182.BG) (10-1995 A 10-2001) 75CV 1370CC - FIAT BRAVA (182) 1.4 12V (182.BA) (10</p> <p>79x61x9mm NULL</p>		<p>P1065 NO. 7777407</p> <p>CAPA DE PEDAL DO TRAVÃO</p> <p>FIAT BRAVA - BRAVO I (182) 1.2 16V 80 (10-2000 A 10-2001) 80CV 1242CC - FIAT BRAVA - BRAVO I (182) 1.2 16V 80 (12-1998 A 12-2002) 82CV 1242CC - FIAT BRAVA - BRAVO I (182) 1.4 (182.BG) (10-1995 A 10-2001) 75CV 1370CC - FIAT BRAVO I (182) 1.4 (182.AA) (10-1</p> <p>79x61x9mm NULL</p>
	<p>P1065 NO. 7777407</p> <p>CAPA DE PEDAL DO TRAVÃO</p> <p>FIAT MAREA (185) 1.2 16V (10-1998 A 05-2002) 82CV 1242CC - FIAT MAREA (185) 1.4 80 12V (09-1996 A 05-2002) 80CV 1370CC - FIAT MAREA (185) 1.6 100 16V (09-1996 A 05-2002) 103CV 1581CC - FIAT MAREA (185) 1.6 100 16V BIPOWER (04-1999 A 05-2002) 103CV 1581CC</p> <p>79x61x9mm NULL</p>		<p>P1066 NO. 82478183</p> <p>CAPA DE PEDAL DA EMBRAIAGEM</p> <p>FIAT BRAVA - BRAVO I (182) 16V 80 (10-2000 A 10-2001) 80CV 1242CC - FIAT BRAVA - BRAVO I (182) 1.2 16V 80 (12-1998 A 12-2002) 82CV 1242CC - FIAT BRAVA (182) 1.4 (182.BG) (10-1995 A 10-2001) 75CV 1370CC - FIAT BRAVA (182) 1.4 12V (182.BA) (10-1995 A 08-19</p> <p>80x61x8mm NULL</p>















	P1066 NO. 82478183 CAPA DE PEDAL DA EMBRAIAGEM FIAT BRAVA - BRAVO I (182) 16V 80 (10-2000 A 10-2001) 80CV 1242CC - FIAT BRAVA - BRAVO I (182) 1.2 16V 80 (12-1998 A 12-2002) 82CV 1242CC - FIAT BRAVO I (182) 1.4 (182.AG) (10-1995 A 10-2001) 75CV 1370CC - FIAT BRAVO I (182) 1.4 (182.AA) (10-1995 A 10-2)		P1066 NO. 82478183 CAPA DE PEDAL DA EMBRAIAGEM FIAT MAREA (185) 1.2 16V (10-1998 A 05-2002) 82CV 1242CC - FIAT MAREA (185) 1.4 80 12V (09-1996 A 05-2002) 80CV 1370CC - FIAT MAREA (185) 1.6 100 16V (09-1996 A 05-2002) 103CV 1581CC - FIAT MAREA (185) 1.8 115 16V (09-1996 A 05-2002) 113CV 1747CC - FIAT M
80x61x8mm	NULL	80x61x8mm	NULL
	P1072 NO. 46828744 - 71748374 CAPA DE PEDAL DO TRAVÃO FIAT BRAVO II 1.4 (APÓS 04-2007) 90CV 1368CC - FIAT BRAVO II 1.9 D MULTIJET (APÓS 04-2007) 1910CCN 1.8 16V (01-2003 A 08-2008) 133CV 1747CC - FIAT STILO MULTI WAGON 1.9 JTD (01-2003 A 08-2008) 115CV 1910CC		P1079 NO. 7744827 CAPA DO PEDAL DO TRAVÃO E EMBRAIAGEM FIAT BRAVA 1.9 JTD 105 (12-1998 A 10-2001) 105CV 1910CC
78x54x9mm	NULL	88x64x10mm	NULL
	P1079 NO. 7744827 CAPA DO PEDAL DO TRAVÃO E EMBRAIAGEM FIAT BRAVO I 2.0 HGT 20V (182AD) (10-1995 A 07-1998) 147CV 1998CC - FIAT BRAVO I 1.9 JTD 105 (12-1998 A 10-2001) 105CV 1910CC		P1079 NO. 7744827 CAPA DO PEDAL DO TRAVÃO E EMBRAIAGEM FIAT MAREA 2.0 150 20V (09-1996 A 04-1999) 147CV 1998CC - FIAT MAREA 2.0150 20V (01-2001 A 05-2002) 150CV 1998CC - FIAT MAREA 2.0 155 20V (04-1999 A 01-2001) 154CV 1998CC - FIAT MAREA 2.4 TD 125 (09-1996 A 04-1999) 125CV 2387CC - FIAT MAREA 2.4 JTD 130 (
88x64x10mm	NULL	88x64x10mm	NULL
	P1080 NO. 7777342 CAPA DE PEDAL DO TRAVÃO FIAT BRAVA 1.9 JTD 105 (12-1998 A 10-2001) 105CV 1910CC		P1080 NO. 7777342 CAPA DE PEDAL DO TRAVÃO FIAT BRAVO I 2.0 HGT 20V (182AD) (10-1995 A 07-1998) 147CV 1998CC - FIAT BRAVO I 2.0 HGT 20V (182AQ) (07-1998 A 10-2001) 154CV 1998CC - FIAT BRAVO I 1.9 JTD 105 (12-1998 A 10-2001) 105CV 1910CC
84x64x10mm	NULL	84x64x10mm	NULL
	P1080 NO. 7777342 CAPA DE PEDAL DO TRAVÃO FIAT MAREA 2.0 150 20V (09-1996 A 04-1999) 147CV 1998CC - FIAT MAREA 2.0 150 20V (01-2001 A 05-2002) 150CV 1998CC - FIAT MAREA 2.0 155 20V (04-1999 A 01-2001) 154CV 1998CC - FIAT MAREA 1.9 JTD 105 (04-1999 A 01-2001) 105CV 1910CC - FIAT MAREA 2.4 TD 125		R01990 NO. 46405738 TUBO SUPERIOR DO RADIADOR FIAT BRAVA - BRAVO 1.4 - MAREA 1.4
84x64x10mm	NULL	B255-d33/33mm	80-100-90mm
	R01990 NO. 46405739 TUBO INFERIOR DO RADIADOR FIAT BRAVA - BRAVO 1.4 - MAREA 1.4		R01995 NO. 46467615 - 46467618 TUBO SUPERIOR DO RADIADOR FIAT BRAVA - BRAVO TD (1910 75 CV) - MAREA TD 1.9 75 CV
B310-d33/33mm	85-140-125mm	B420-d33/33mm	70-135-245-70mm
	R01996 NO. 46417331 TUBO INFERIOR DO RADIADOR FIAT BRAVA 1.9 D (10-1995 A 10-2001)		R01996 NO. 46417331 TUBO INFERIOR DO RADIADOR FIAT BRAVO 1.9 D (10-1995 A 10-2001)
80-60-260-210-140-80	B550-d32/33mm	80-60-260-210-140-80	B550-d32/33mm
	R01996 NO. 46462540 TUBO RADIADOR SUPERIOR FIAT MAREA (APÓS 1999) - 1.9 TD (75 CV) (100 CV)		R01996 NO. 46462541 TUBO INFERIOR DO RADIADOR FIAT BRAVA - BRAVO TD (1910 100CV) - MAREA TD (1.9 100CV)
B355-d32/32mm	60-85-85-90-100-55mm	B360-d33/33mm	60-165-100-75-60mm

	<p>RT08417 NO. 7667806</p> <p>TUBO DE TRAVÃO TRÁS LH-RH</p> <p>FIAT BRAVA - BRAVO 1.2 - 1.4 - 1.6 - 1.9D - 1.9TD - 1.9JTD (10-1996 A 10-2001) - 1.8 (10-1997 A 10-2001) - 2.0 (10-1997 A 10-2001) - FIAT MAREA TT (APOS 07-1996)</p> <p>240mm FB23 - FB23</p>		<p>RT08459 NO. 46786435 - 7586907</p> <p>TUBO DE TRAVÃO TRÁS LH-RH</p> <p>FIAT BRAVO I 2.0 HGT 20V (10-1995 A 07-1998)</p> <p>182mm FB23 - MC11</p>
	<p>RT08459 NO. 46786435 - 7586907</p> <p>TUBO DE TRAVÃO TRÁS LH-RH</p> <p>FIAT MAREA 1.6 100 16V (APÓS 09-1996) - 2.0 150 20V (APOS 09-1996) - 2.0 155 20V (04-1999 A 01-2001) - 2.4 JTD 130 (APOS 04-1999) - 2.4 TD 125 (09-1996 A 04-1999)</p> <p>182mm FB23 - MC11</p>		<p>RT08459 NO. 46786435 - 7586907</p> <p>TUBO DE TRAVÃO TRÁS LH-RH</p> <p>FIAT MAREA WEEKEND 1.6 100 16V (APÓS 09-1996) - 1.8 115 16V (APÓS 09-1996) - 2.0 150 20V (APOS 09-1996) - 2.0 155 20V (04-1999 A 01-2001) - 2.4 JTD 130 (APÓS 04-1999) - 2.4 TD 125 (09-1996 A 04-1999)</p> <p>182mm FB23 - MC11</p>
	<p>RT08486 NO. 7670215</p> <p>TUBO DE TRAVÃO TRÁS LH-RH (COM ABS)</p> <p>FIAT BRAVA 1.8GT 16V - BRAVO 1.8GT - 2.0HGT 20V</p> <p>245mm FB23 - FB23</p>		<p>RT08486 NO. 7670215</p> <p>TUBO DE TRAVÃO TRÁS LH-RH (COM TAMBOR)</p> <p>FIAT MAREA 1.4 80 12V - 1.6 100 16V - 1.8 115 16V - 1.9 TD 100 - 1.9TD 75 - 1.9JTD 105 - 2.0 150 20V - 2.4TD 125 - 2.4JTD 130 (1995 A 2001)</p> <p>245mm FB23 - FB23</p>
	<p>RT08552 NO. 46448591 - 46448893 - 60812250 - 7674977 - 46421964 - 46421966 - 71736921 - 71736923</p> <p>TUBO DE TRAVÃO FRENTE LH-RH</p> <p>FIAT BRAVA - BRAVO TT (EXCEPTO 2.0) (10-1996 A 10-2001)</p> <p>415mm FB23 - MC11</p>		<p>RT08554 NO. 45454003 - 71736924</p> <p>TUBO DE TRAVÃO FRENTE LH-RH</p> <p>FIAT BRAVA - BRAVO 2.0 (10-1997 A 10-2001) - FIAT MAREA 109 JTD - 1.9 TD - TT GASOLINA E (EXCEPTO 2.0) (APÓS 07-1996)</p> <p>435mm FB23 - MC11</p>
	<p>S1161D20 NO. 7601065</p> <p>SILENT- BLOC CENTRAL DO BRAÇO DA SUSPENSÃO DIANTEIRO (DIREITO)</p> <p>FIAT BRAVA 1.2 16V 80 80CV (10-2000 A 10-2001) - 1.2 16V 80 82CV (12-1998 A 10-2000) - 1.4 75CV (10-1995 A 10-2001) - 1.4 12V 80CV (10-1995 A 08-1998) - 1.6 16V 90CV (10-1995 A 10-2001) - 1.6 16V 103CV (02-1996 A 10-2001) - 1.8 GT 16V 113CV (10-1995 A 10)</p> <p>120x60x50mm 1f-d20mm 2r-d10mm</p>		<p>S1161D20 NO. 7601065</p> <p>SILENT- BLOC CENTRAL DO BRAÇO DA SUSPENSÃO DIANTEIRO (DIREITO)</p> <p>FIAT BRAVO I 1.2 16V 80 80CV (10-2000 A 10-2001) - 1.2 16V 80 82CV (12-1998 A 10-2000) - 1.4 75CV (10-1995 A 10-2001) - 1.4 80CV (10-1995 A 10-2001) - 1.6 16V 90CV (10-1995 A 10-2001) - 1.6 16V 103CV (03-1996 A 10-2001) - 1.8 GT 113CV (10-1995 A 10-2001)</p> <p>120x60x50mm 1f-d20mm 2r-d10mm</p>
	<p>S1161D20 NO. 7601065</p> <p>SILENT- BLOC CENTRAL DO BRAÇO DA SUSPENSÃO DIANTEIRO (DIREITO)</p> <p>FIAT MAREA 1.2 16V 82CV (10-1998 A 05-2002) - 1.4 80 12V 80CV (09-1996 A 05-2002) - 1.6 100 16V 103CV (09-1996 A 05-2002) - 1.6 100 16V BIPOWER 103CV (04-1999 A 05-2002) - 1.8 115 16V 113CV (09-1996 A 05-2002) - 2.0 150 20V 147CV (09-1996 A 04-1999) - 2.0</p> <p>120x60x50mm 1f-d20mm 2r-d10mm</p>		<p>S1161D21 NO. 60603027</p> <p>SILENT-BLOC CENTRAL DO BRAÇO DA SUSPENSÃO DIANTEIRO (DIREITO)</p> <p>FIAT BRAVA 1.2 16V 80 80CV (10-2000 A 10-2001) - 1.2 16V 80 82CV (12-1998 A 10-2000) - 1.4 75CV (10-1995 A 10-2001) - 1.4 12V 80CV (10-1995 A 08-1998) - 1.6 16V 90CV (10-1995 A 10-2001) - 1.6 16V 103CV (02-1996 A 10-2001) - 1.8 GT 16V 113CV (10-1995 A 10)</p> <p>120x60x50mm 1f-d21mm 2r-d10mm</p>
	<p>S1161D21 NO. 60603027</p> <p>SILENT-BLOC CENTRAL DO BRAÇO DA SUSPENSÃO DIANTEIRO (DIREITO)</p> <p>FIAT BRAVO I 1.2 16V 80 80CV (10-2000 A 10-2001) - 1.2 16V 80 82CV (12-1998 A 10-2000) - 1.4 75CV (10-1995 A 10-2001) - 1.4 80CV (10-1995 A 10-2001) - 1.6 16V 90CV (10-1995 A 10-2001) - 1.6 16V 103CV (03-1996 A 10-2001) - 1.8 GT 113CV (10-1995 A 10-2001)</p> <p>120x60x50mm 1f-d21mm 2r-d10mm</p>		<p>S1161D21 NO. 60603027</p> <p>SILENT-BLOC CENTRAL DO BRAÇO DA SUSPENSÃO DIANTEIRO (DIREITO)</p> <p>FIAT MAREA 1.2 16V 82CV (10-1998 A 05-2002) - 1.4 80 12V 80CV (09-1996 A 05-2002) - 1.6 100 16V 103CV (09-1996 A 05-2002) - 1.6 100 16V BIPOWER 103CV (04-1999 A 05-2002) - 1.8 115 16V 113CV (09-1996 A 05-2002) - 2.0 150 20V 147CV (09-1996 A 04-1999) - 2.0</p> <p>120x60x50mm 1f-d21mm 2r-d10mm</p>
	<p>S1162E20 NO. 7601068</p> <p>SILENT- BLOC CENTRAL DO BRAÇO DA SUSPENSÃO DIANTEIRO(ESQUERDO)</p> <p>FIAT BRAVA 1.2 16V 80 80CV (10-2000 A 10-2001) - 1.2 16V 80 82CV (12-1998 A 10-2000) - 1.4 75CV (10-1995 A 10-2001) - 1.4 12V 80CV (10-1995 A 08-1998) - 1.6 16V 90CV (10-1995 A 10-2001) - 1.6 16V 103CV (02-1996 A 10-2001) - 1.8 GT 16V 113CV (10-1995 A 10)</p> <p>120x60x50mm 1f-d20mm 2r-d10mm</p>		<p>S1162E20 NO. 7601068</p> <p>SILENT- BLOC CENTRAL DO BRAÇO DA SUSPENSÃO DIANTEIRO(ESQUERDO)</p> <p>FIAT BRAVO I 1.2 16V 80 80CV (10-2000 A 10-2001) - 1.2 16V 80 82CV (12-1998 A 10-2000) - 1.4 75CV (10-1995 A 10-2001) - 1.4 80CV (10-1995 A 10-2001) - 1.6 16V 90CV (10-1995 A 10-2001) - 1.6 16V 103CV (03-1996 A 10-2001) - 1.8 GT 113CV (10-1995 A 10-2001)</p> <p>120x60x50mm 1f-d20mm 2r-d10mm</p>

	S1162E20 NO. 7601068 <i>SILENT- BLOC CENTRAL DO BRAÇO DA SUSPENSÃO DIANTEIRO(ESQUERDO)</i> FIAT MAREA 1.2 16V 82CV (10-1998 A 05-2002) - 1.4 80 12V 80CV (09-1996 A 05-2002) - 1.6 100 16V 103CV (09-1996 A 05-2002) - 1.6 100 16V BIPOWER 103CV (04-1999 A 05-2002) - 1.8 115 16V 113CV (09-1996 A 05-2002) - 2.0 150 20V 147CV (09-1996 A 04-1999) - 2.0		S1162E21 NO. 60603028 <i>SILENT- BLOC CENTRAL DO BRAÇO DA SUSPENSÃO DIANTEIRO(ESQUERDO)</i> FIAT BRAVA 1.2 16V 80 80CV (10-2000 A 10-2001) - 1.2 16V 80 82CV (12-1998 A 10-2000) - 1.4 75CV (10-1995 A 10-2001) - 1.4 12V 80CV (10-1995 A 08-1998) - 1.6 16V 90CV (10-1995 A 10-2001) - 1.6 16V 103CV (02-1996 A 10-2001) - 1.8 GT 16V 113CV (10-1995 A 10
120x60x50mm	1f-d20mm 2r-d10mm	120x60x50mm	1f-d21mm 2r-d10mm
	S1162E21 NO. 60603028 <i>SILENT- BLOC CENTRAL DO BRAÇO DA SUSPENSÃO DIANTEIRO(ESQUERDO)</i> FIAT BRAVO I 1.2 16V 80 80CV (10-2000 A 10-2001) - 1.2 16V 80 82CV (12-1998 A 10-2000) - 1.4 75CV (10-1995 A 10-2001) - 1.4 80CV (10-1995 A 10-2001) - 1.6 16V 90CV (10-1995 A 10-2001) - 1.6 16V 103CV (03-1996 A 10-2001) - 1.8 GT 113CV (10-1995 A 10-2001)		S1162E21 NO. 60603028 <i>SILENT- BLOC CENTRAL DO BRAÇO DA SUSPENSÃO DIANTEIRO(ESQUERDO)</i> FIAT MAREA 1.2 16V 82CV (10-1998 A 05-2002) - 1.4 80 12V 80CV (09-1996 A 05-2002) - 1.6 100 16V 103CV (09-1996 A 05-2002) - 1.6 100 16V BIPOWER 103CV (04-1999 A 05-2002) - 1.8 115 16V 113CV (09-1996 A 05-2002) - 2.0 150 20V 147CV (09-1996 A 04-1999) - 2.0
120x60x50mm	1f-d21mm 2r-d10mm	120x60x50mm	1f-d21mm 2r-d10mm
	S1189F20 NO. 7601064 <i>SILENT- BLOC CENTRAL DO BRAÇO DA SUSPENSÃO DIANTEIRO</i> FIAT BRAVA 1.2 16V 80 80CV (10-2000 A 10-2001) - 1.2 16V 80 82CV (12-1998 A 10-2000) - 1.4 75CV (10-1995 A 10-2001) - 1.4 12V 80CV (10-1995 A 08-1998) - 1.6 16V 90CV (10-1995 A 10-2001) - 1.6 16V 103CV (02-1996 A 10-2001) - 1.8 GT 16V 113CV (10-1995 A 10		S1189F20 NO. 7601064 <i>SILENT- BLOC CENTRAL DO BRAÇO DA SUSPENSÃO DIANTEIRO</i> FIAT BRAVO I 1.2 16V 80 82CV (12-1998 A 10-2000) - 1.4 75CV (10-1995 A 10-2001) - 1.4 80CV (10-1995 A 10-2001) - 1.6 16V 90CV (10-1995 A 10-2001) - 1.6 16V 103CV (03-1996 A 10-2001) - 1.8 GT 113CV (10-1995 A 10-2001) - 2.0 HGT 20V 147CV (10-1995 A 07-1998
100x51x46mm	1f-d20mm 2r-d10mm	100x51x46mm	1f-d20mm 2r-d10mm
	S1189F20 NO. 7601064 <i>SILENT- BLOC CENTRAL DO BRAÇO DA SUSPENSÃO DIANTEIRO</i> FIAT MAREA 1.2 16V 82CV (10-1998 A 05-2002) - 1.4 80 12V 80CV (09-1996 A 05-2002) - 1.6 100 16V 103CV (09-1996 A 05-2002) - 1.6 100 16V BIPOWER 103CV (04-1999 A 05-2002) - 1.8 115 16V 113CV (09-1996 A 05-2002) - 2.0 150 20V 147CV (09-1996 A 04-1999) - 2.0		S1189F21 NO. <i>SILENT- BLOC CENTRAL DO BRAÇO DA SUSPENSÃO DIANTEIRO</i> FIAT BRAVA 1.2 16V 80 80CV (10-2000 A 10-2001) - 1.2 16V 80 82CV (12-1998 A 10-2000) - 1.4 75CV (10-1995 A 10-2001) - 1.4 12V 80CV (10-1995 A 08-1998) - 1.6 16V 90CV (10-1995 A 10-2001) - 1.6 16V 103CV (02-1996 A 10-2001) - 1.8 GT 16V 113CV (10-1995 A 10
100x51x46mm	1f-d20mm 2r-d10mm	100x51x46mm	1f-d21mm 2r-d10mm
	S1189F21 NO. <i>SILENT- BLOC CENTRAL DO BRAÇO DA SUSPENSÃO DIANTEIRO</i> FIAT BRAVO I 1.2 16V 80 82CV (12-1998 A 10-2000) - 1.4 75CV (10-1995 A 10-2001) - 1.4 80CV (10-1995 A 10-2001) - 1.6 16V 90CV (10-1995 A 10-2001) - 1.6 16V 103CV (03-1996 A 10-2001) - 1.8 GT 113CV (10-1995 A 10-2001) - 2.0 HGT 20V 147CV (10-1995 A 07-1998		S1189F21 NO. <i>SILENT- BLOC CENTRAL DO BRAÇO DA SUSPENSÃO DIANTEIRO</i> FIAT MAREA 1.2 16V 82CV (10-1998 A 05-2002) - 1.4 80 12V 80CV (09-1996 A 05-2002) - 1.6 100 16V 103CV (09-1996 A 05-2002) - 1.6 100 16V BIPOWER 103CV (04-1999 A 05-2002) - 1.8 115 16V 113CV (09-1996 A 05-2002) - 2.0 150 20V 147CV (09-1996 A 04-1999) - 2.0
100x51x46mm	1f-d21mm 2r-d10mm	100x51x46mm	1f-d21mm 2r-d10mm
	S1595 NO. 50511650 - 50521486 - 51783056 - 51783057 <i>SILENT-BLOC BRAÇO SUPERIOR FRENTE</i> FIAT BRAVO II (198_) 1.4 (A partir de 04.07) 90cv 1368cc Hatchback - FIAT BRAVO II (198_) 1.4 T-Jet (A partir de 09.07) 120cv 1368cc Hatchback - FIAT BRAVO II (198_) 1.4 16V (A partir de 03.08) 140cv 1368cc Hatchback - FIAT BRAVO II (198_) 1.4 T-Jet (A partir de 09.07) 150cv 1368cc Hatchback - FIAT BRAVO II (198_) 1.6 D Multijet (A partir de 09.07) 105cv 1598cc Hatchback - FIAT BRAVO II (198_) 1.6 D Multijet (A partir de 03.08) 120cv ...etc.		S1595 NO. 50511650 - 50521486 - 51783056 - 51783057 <i>SILENT-BLOC BRAÇO SUPERIOR FRENTE</i> FIAT LINEA (323_) 1.4 (A partir de 06.07) 77cv 1368cc três volumes - FIAT LINEA (323_) 1.4 T-Jet (A partir de 09.07) 120cv 1368cc três volumes - FIAT LINEA (323_) 1.6 (A partir de 07.08) 109cv 1597cc três volumes - FIAT LINEA (323_) 1.9 16V (A partir de 07.08) 128cv 1855cc três volumes - FIAT LINEA (323_) 1.3 D Multijet (A partir de 06.07) 90cv 1248cc três volumes - FIAT LINEA (323_) 1.6 D Multijet (A partir de 06.09) 105cv 1598cc...etc.
d53x67mm	d41mm 1f-d14mm	d53x67mm	d41mm 1f-d14mm
	T0647-I NO. 7588036 <i>BATENTE SUSPENSÃO DA FRENTE</i> FIAT BRAVA (182_) 1.2 16V 80 (10.00 A 10.01) 80cv 1242cc Hatchback - FIAT BRAVA (182_) 1.2 16V 80 (12.98 A 12.02) 82cv 1242cc Hatchback - FIAT BRAVA (182_) 1.6 16V (182.BH) (10.95 A 10.01) 90cv 1581cc Hatchback - FIAT BRAVA (182_) 1.6 16V (182.BB) (02.96 A 10.01) 103cv 1581cc Hatchback - FIAT BRAVA (182_) 1.8 GT 16V (182.BC) (10.95 A 10.01) 113cv 1747cc Hatchback		T0647-I NO. 7588036 <i>BATENTE SUSPENSÃO DA FRENTE</i> FIAT BRAVO II (198_) 1.6 D Multijet (APÓS 03.08) 90cv 1598cc Hatchback - FIAT BRAVO II (198_) 1.6 D Multijet (APÓS 09.07) 105cv 1598cc Hatchback - FIAT BRAVO II (198_) 1.6 D Multijet (APÓS 03.08) 120cv 1598cc Hatchback
d56x104mm	1f-d27mm 1f-d21mm	d56x104mm	1f-d27mm 1f-d21mm
	T0656-I NO. 51775545 - 51866009 <i>BATENTE SUSPENSÃO DA FRENTE</i> FIAT LINEA (323_) 1.4 06.07 - 57 77 1368 três volumes FIAT LINEA (323_) 1.4 T-Jet 09.07 - 88 120 1368 três volumes FIAT LINEA (323_) 1.3 D Multijet 06.07 - 66 90 1248 três volumes FIAT LINEA (323_) 1.6 D Multijet 06.09 - 77 105 1598 três volumes		W5013 NO. 73501275 - 46447843 - 55185409 - 55190424 - 55185403 <i>POLIE DA CAMBOTA (6 pistas)</i> FIAT BRAVO - MAREA 1.9 JTD (12-1998 A 2001)
d63x65mm	1f-d27mm 1f-d20mm	d164.5mm	d30.5mm

	<p>W5023 NO. 55187707 - 55184474 - 55217328 - 46544615 - 46427969 - 60815929 - 46742884 - 71747798 - 55215574</p> <p>POLIE DA CAMBOTA (6 pistas)</p> <p>FIAT MAREA 2.4 D (09-1996 A 04-1999) - FIAT MAREA 2.4 JTD (APOS 04-1999)</p>		<p>W5093 NO. 55208280 - 55196974 - 93191381 - 614571 - 2005302 - 2005758 - 20000281 - 93191382 - 1261019J50 - 551...</p> <p>POLIE DA CAMBOTA (6 PISTAS)</p> <p>FIAT BRAVA 1.9 JTD (09-2000 A 10-2001) - 1.9 JTD 105 (12-1998 A 10-2001) - 1.9 TD 755 (03-1996 A 10-2001) - 1.9 TD 100S (03-1996 A 10-2001)</p>
	<p>W5093 NO. 55208280 - 55196974 - 93191381 - 614571 - 2005302 - 2005758 - 20000281 - 93191382 - 1261019J50 - 551...</p> <p>POLIE DA CAMBOTA (6 PISTAS)</p> <p>FIAT BRAVO 1.9 JTD (09-2000 A10-2001) - 1.9 JTD 105 (12-1998 A 10-2001) 1.9 TD 753 (03-1996 A 10-2001) - 1.9 TD 100S (03-1996 A 10-2001)</p>		<p>W5093 NO. 55208280 - 55196974 - 93191381 - 614571 - 2005302 - 2005758 - 20000281 - 93191382 - 1261019J50 - 551...</p> <p>POLIE DA CAMBOTA (6 PISTAS)</p> <p>FIAT MAREA 1.9 TD 75 (APÓS 09-1996) - 1.9 JTD 105 (04-1999 A 01-2001) - 1.9 JTD 110 (APÓS 01-2001) - WEEKEND 1.9 TD 75 (APÓS 09-1996) - WEEKEND 1.9 JTD 105 (APÓS 04-1999) - WEEKEND 1.9 JTD 110 (APÓS 01-2001)</p>
	<p>W5104 NO. 55182506</p> <p>POLIE DA CAMBOTA (6+4 PISTAS)</p> <p>FIAT LINEA 1.3 D MULTIJET (APÓS 06-2007)</p>		<p>W5105 NO. 7778028 - 46516096 - 71711983 - 71723808</p> <p>POLIE DA CAMBOTA (4+3 PISTAS)</p> <p>FIAT BRAVA 1.2 16V (12-1998 A 10-2000)</p>
	<p>W5105 NO. 7778028 - 46516096 - 71711983 - 71723808</p> <p>POLIE DA CAMBOTA (4+3 PISTAS)</p> <p>FIAT BRAVO 1.2 16V (12-1998 A 10-2000)</p>		<p>W5105 NO. 7778028 - 46516096 - 71711983 - 71723808</p> <p>POLIE DA CAMBOTA (4+3 PISTAS)</p> <p>FIAT MAREA 1.2 (04-1996 A 02-2001)</p>
	<p>W5145 NO. 55210310 - 0614359 - 614359 - 93192547</p> <p>POLIE DA CAMBOTA 6 PISTAS</p> <p>FIAT BRAVO II (198_) 1.6 D Multijet (APÓS 03.08) 120cv 1598cc Hatchback - FIAT BRAVO II (198_) 2.0 D Multijet (APÓS 09.08) 163cv 1956cc Hatchback - FIAT BRAVO II (198_) 2.0 D Multijet (APÓS 09.08) 165cv 1956cc Hatchback</p>		<p>Z80476 NO. 14188282 - 46306526 - 60507749</p> <p>Mola de painel</p> <p>FIAT MAREA</p>
	<p>Z80502 NO. 5757553</p> <p>Mola de retenção</p> <p>FIAT MAREA</p>		<p>Z80588 NO. 7637466</p> <p>Mola de painel</p> <p>FIAT MAREA</p>
	<p>Z80588 NO. 7637466</p> <p>Mola de painel</p> <p>FIAT BRAVO</p>		<p>Z80588 NO. 7637466</p> <p>Mola de painel</p> <p>FIAT BRAVA</p>
	<p>Z80604 NO. 7739801 - 500382985</p> <p>Mola de painel</p> <p>FIAT MAREA</p>		<p>Z80604 NO. 7739801 - 500382985</p> <p>Mola de painel</p> <p>FIAT BRAVO</p>

	Z80604 NO. 7739801 - 500382985 <i>Mola de painel</i> FIAT BRAVA		Z80610 NO. 712113631 <i>Mola de painel</i> FIAT BRAVA
	d18.2x21.6mm 1p-d6.4-16.1mm		d16x19mm 1p-d7.2-17mm
	Z80610 NO. 712113631 <i>Mola de painel</i> FIAT BRAVA (Após 1998)		Z80615 NO. 46436251 <i>Mola de fixação</i> FIAT BRAVO (Após 1998)
	d16x19mm 1p-d7.2-17mm		d16x24mm NULL
	Z80619 NO. 7677865 <i>Mola de painel</i> FIAT MAREA		Z80619 NO. 7677865 <i>Mola de painel</i> FIAT BRAVO
	d14x12mm 1p-d7.5-10mm		d14x12mm 1p-d7.5-10mm
	Z80619 NO. 7677865 <i>Mola de painel</i> FIAT BRAVA		Z80637 NO. 7788400 <i>Mola de fixação</i> FIAT MAREA
	d14x12mm 1p-d7.5-10mm		d30x31.7mm 1p-d19-29mm
	Z80637 NO. 7788400 <i>Mola de fixação</i> FIAT BRAVO		Z80637 NO. 7788400 <i>Mola de fixação</i> FIAT BRAVA
	d30x31.7mm 1p-d19-29mm		d30x31.7mm 1p-d19-29mm
	Z80638 NO. 7638283 <i>Mola de painel</i> FIAT MAREA		Z80642 NO. 60605082 <i>Mola de fixação</i> FIAT MAREA
	d25x19.5mm 1p-d8-17mm		NULL NULL
	Z80643 NO. 7771637 <i>Mola de fixação</i> FIAT MAREA		Z80643 NO. 7771637 <i>Mola de fixação</i> FIAT BRAVO
	20x16x15.8mm 1p-d12.8-15mm		20x16x15.8mm 1p-d12.8-15mm
	Z80643 NO. 7771637 <i>Mola de fixação</i> FIAT BRAVA		Z80651 NO. 82426359 <i>Mola de fixação</i> FIAT BRAVO
	20x16x15.8mm 1p-d12.8-15mm		d18x42mm 1p-d10-19mm

	<p>Z80651 NO. 82426359</p> <p><i>Mola de fixação</i></p> <p>FIAT BRAVA</p> <p>d18x42mm 1p-d10-19mm</p>		<p>Z80668 NO. 735266957</p> <p><i>Mola de painel</i></p> <p>FIAT MAREA (Após 1998)</p> <p>d20x15.5mm 1p-d8.2-13mm</p>
	<p>Z80668 NO. 735266957</p> <p><i>Mola de painel</i></p> <p>FIAT BRAVO</p> <p>d20x15.5mm 1p-d8.2-13mm</p>		<p>Z80668 NO. 735266957</p> <p><i>Mola de painel</i></p> <p>FIAT BRAVA (Após 1998)</p> <p>d20x15.5mm 1p-d8.2-13mm</p>
	<p>Z80669 NO. 7768047</p> <p><i>Mola de painel</i></p> <p>FIAT MAREA</p> <p>d14x9.8mm 1p-d7.5-7.8mm</p>		<p>Z80669 NO. 7768047</p> <p><i>Mola de painel</i></p> <p>FIAT BRAVO</p> <p>d14x9.8mm 1p-d7.5-7.8mm</p>
	<p>Z80669 NO. 7768047</p> <p><i>Mola de painel</i></p> <p>FIAT BRAVA</p> <p>d14x9.8mm 1p-d7.5-7.8mm</p>		<p>Z80686 NO. 7770156</p> <p><i>Mola de friso</i></p> <p>FIAT MAREA</p> <p>NULL NULL</p>
	<p>Z80686 NO. 7770156</p> <p><i>Mola de friso</i></p> <p>FIAT BRAVO</p> <p>NULL NULL</p>		<p>Z80686 NO. 7770156</p> <p><i>Mola de friso</i></p> <p>FIAT BRAVO (Após 2007)</p> <p>NULL NULL</p>
	<p>Z80686 NO. 7770156</p> <p><i>Mola de friso</i></p> <p>FIAT BRAVA</p> <p>NULL NULL</p>		<p>Z80702 NO. 46408953 - 46748771</p> <p><i>Mola de fixação</i></p> <p>FIAT MAREA</p> <p>d16x25.5mm 1p-8x8-24mm 1f-d4.8mm</p>
	<p>Z80702 NO. 46408953 - 46748771</p> <p><i>Mola de fixação</i></p> <p>FIAT BRAVO</p> <p>d16x25.5mm 1p-8x8-24mm 1f-d4.8mm</p>		<p>Z80702 NO. 46408953 - 46748771</p> <p><i>Mola de fixação</i></p> <p>FIAT BRAVA</p> <p>d16x25.5mm 1p-8x8-24mm 1f-d4.8mm</p>
	<p>Z80793 NO. 14203480</p> <p><i>Mola de retenção</i></p> <p>FIAT MAREA</p> <p>d16x5mm 1p-d10-7mm 1f-d4.5mm</p>		

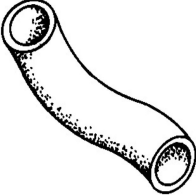
	R021179 NO. 4452016		
	TUBO DE LIGAÇÃO DO FILTRO DE AR AO COLECTOR FIAT CAMPAGNOLA 1107 A DIESEL		
	NULL	NULL	

FIAT CINQUECENTO-SEICENTO

	A1699 NO. 46411024		A1953 NO. 46400905 - 7692317
APOIO DO MOTOR LADO DA CAIXA FIAT CINQUECENTO 1.1		APOIO MOTOR LADO ESQUERDO FIAT CINQUECENTO (170_) 0.9 i.e. S (170AF, 170CF) Local de montagem: traseira (07.91 A 07.99) 40cv 899cc Hatchback - FIAT CINQUECENTO (170_) 0.9 (170AB) Local de montagem: traseira (07.91 A 12.93) 41cv 903cc Hatchback - FIAT CINQUECENTO (170_) 0.9 i.e. (170AC) Local de montagem: traseira (07.91 A 12.93) 41cv 903cc Hatchback	
130x90x80mm	1r-d10mm 1f-d11mm	135x80x90mm	2f-15x8mm 1r-d10mm
	F0898F65 NO. 7682886		F1171-I NO. 7700064
FOLE JUNTO À RODA FIAT CINQUECENTO SUITE 900 (10-92)		FOLE DA DIRECÇÃO LADO DIREITO E ESQUERDO FIAT CINQUECENTO (1991 A 1998 0.7 - 0.9 - 0.9 i.e. S - 1.1i SPORTING - SEICENTO APÓS 1998 0.9i - 1.1i	
d91x80mm	1f-d65mm 1f-d19mm	d63x135mm	1f-d38mm 1f-d7mm
	F1172A-I NO. 7664080		R019110 NO. 46407689
FOLE DA TRANSMISSÃO JUNTO À CAIXA FIAT CINQUECENTO 1.1i SPORTING (10-94 A 01-98) - 700 (12-91 A 01-96) - 700i (07-94 A 01-98)		TUBO INFERIOR DO RADIADOR FIAT CINQUECENTO (170_) 1.1 Sporting (170AH) Tubagem de refrigeração: do radiador do aquecimento para o motor (10.94 A 01.98) 54cv 1108cc Hatchback	
d100x72mm	1f-d80mm 1f-d25.8mm	NULL	NULL
	R020438 NO. 7700651 - 7724730		RT08564 NO. 46481635
TUBO DO FILTRO DO AR FIAT CINQUECENTO (170) 0.9 (170AB) 41CV (07-1991 A 12/1993)		TUBO DE TRAVÃO FRENTE LH-RH FIAT CINQUECENTO 1.1 SPORTING (170AH) 176 B2.000 54CV (10-1994 A 01-1998)	
B240-d45/47mm	110x240x80/d14mm 400/5mm	470mm	FB23 - MC11
	S0752-I NO. 5927293		S0752-I NO. 5927293
SILENT-BLOC DO BRAÇO DA SUSPENSÃO DA FRENTE FIAT CINQUECENTO 170 0.7 - 0.7i - 0.9 - 0.9e - 1.1		SILENT-BLOC DO BRAÇO DA SUSPENSÃO DA FRENTE FIAT SEICENTO 187 0.9 - 1.1 - ELEKTRA - VAN 1.1	
58x50x49mm	1f-d21/5mm	58x50x49mm	1f-d21/5mm
	S0753-I NO. 5927292		S0753-I NO. 5927292
SILENT-BLOC BRAÇO DA SUSPENSÃO FRENTE FIAT CINQUECENTO 170 0.7 - 0.7i - 0.9 - 0.9e - 1.1		SILENT-BLOC BRAÇO DA SUSPENSÃO FRENTE FIAT SEICENTO 187 0.9 - 1.1 - ELEKTRA - VAN 1.1	
d35x55mm	d31mm d19mm 1f-d12mm	d35x55mm	d31mm d19mm 1f-d12mm

	<p>Z80465 NO. 4389939</p> <p><i>Mola de fixação</i></p> <p>FIAT CINQUECENTO</p> <p>14x11x15mm 1p-10.5x6-8mm</p>		<p>Z80519 NO. 4358789</p> <p><i>Mola de fixação</i></p> <p>FIAT CINQUECENTO</p> <p>d11x9mm 1p-d8.5-7.8mm 1f-d3mm</p>
	<p>Z80528 NO. 7603826 - 16400631250</p> <p><i>Mola de painel</i></p> <p>FIAT CINQUECENTO</p> <p>d18x21.5mm 1p-d6-16mm</p>		<p>Z80529 NO. 7603826</p> <p><i>Mola de fixação</i></p> <p>Fiat Cinquecento</p> <p>d18.5x20mm 1p-d9-18mm 1f-d6mm</p>
	<p>Z80533 NO. 7543023 - 7703081019 - 9759904480</p> <p><i>Mola de retenção</i></p> <p>FIAT SEICENTO</p> <p>10x17x10mm 1p-7.2x14-9mm 1f-d4.2mm</p>		<p>Z80533 NO. 7543023 - 7703081019 - 9759904480</p> <p><i>Mola de retenção</i></p> <p>FIAT CINQUECENTO</p> <p>10x17x10mm 1p-7.2x14-9mm 1f-d4.2mm</p>
	<p>Z80578 NO. 14569580 - 14569680</p> <p><i>Mola de fixação</i></p> <p>FIAT SEICENTO</p> <p>20x8x15mm 1f-8mm</p>		<p>Z80605 NO. 7745194</p> <p><i>Mola de fixação</i></p> <p>FIAT SEICENTO</p> <p>d20x20.5mm 1p-d9-18.5mm 1f-7x7mm</p>
	<p>Z80647 NO. 14222380</p> <p><i>Mola de fixação</i></p> <p>FIAT SEICENTO</p> <p>12.5x12.5x19.2mm 1p-9.5x9.5-18mm 1f-d4.8mm</p>		<p>Z80647 NO. 14222380</p> <p><i>Mola de fixação</i></p> <p>FIAT CINQUECENTO</p> <p>12.5x12.5x19.2mm 1p-9.5x9.5-18mm 1f-d4.8mm</p>
	<p>Z80651 NO. 82426359</p> <p><i>Mola de fixação</i></p> <p>FIAT CINQUECENTO</p> <p>d18x42mm 1p-d10-19mm</p>		<p>Z80666 NO. 5962559</p> <p><i>Mola de fixação</i></p> <p>FIAT CINQUECENTO</p> <p>d11x20mm 1p-d6.2-10mm</p>
	<p>Z80668 NO. 735266957</p> <p><i>Mola de painel</i></p> <p>FIAT SEICENTO</p> <p>d20x15.5mm 1p-d8.2-13mm</p>		<p>Z80686 NO. 7770156</p> <p><i>Mola de friso</i></p> <p>FIAT SEICENTO</p> <p>NULL NULL</p>
	<p>Z80702 NO. 46408953 - 46748771</p> <p><i>Mola de fixação</i></p> <p>FIAT SEICENTO</p> <p>d16x25.5mm 1p-8x8-24mm 1f-d4.8mm</p>		

	E1152-C NO. 60809242 - 7601647 ESTICADOR DA BARRA ESTABILIZADORA DA FRENTE FIAT COUPÉ TT 120x35x32mm 1f-d12mm		F0469-I NO. 43307029 - 82282140 FOLE DA TRANSMISSÃO LADO DA CAIXA FIAT BARCHETTA COUPÉ d85x80mm 1f-d61mm 1f-d23mm
	F1822-I NO. 4315444 - 46307029 FOLE DA TRANSMISSÃO JUNTO À CAIXA FIAT BARCHETTA 1.8 16V (APÓS 95) d102x94mm 1f-d99mm 1f-d25mm		F1822-I NO. 4315444 - 46307029 FOLE DA TRANSMISSÃO JUNTO À CAIXA FIAT COUPE 1.8i 16V - 2.0i 16V - 2.0i 20V - 2.0iT 16V (APÓS 93) d102x94mm 1f-d99mm 1f-d25mm
	KF1060 NO. 82436966 - 82483504 - 82443750 - 824629961 KIT DE FOLE DO CARDAN JUNTO À RODA FIAT BARCHETTA 1.8 16V (APÓS 1995) - BRAVA 1.8i GT 16V - 1.9 JTD - 1.9 TD S (1995 A 2001) - BRAVO 1.8i GT - 1.9 JTD - 1.9 TD S (1995 A 2001) - COUPE 2.0i 16V (APÓS 1993) - CROMA 1.6 1600 - 1.9 TD iD 1900 TURBO DIESEL - 2.0 2000 CHT - 2.0 i.e 2000 - d100x100mm 1f-d78mm 1f-d24mm		KF1797-T NO. 46429633 - 60812755 KIT DO FOLE DO CARDAN JUNTO À RODA FIAT BARCHETTA 1.8 16V (APÓS 1995) - BRAVO 2.0i HGT 20V (1995 A 2001) - COUPE 1.8i 16V - 2.0i 16V - 2.0i 20V (APÓS 1993) - MAREA 1.8i 16V - 1.9 JTD - 1.9 TD - 2.0i 20V (1996 A 2001) - MULTIPLA 1.9 JTD (APÓS 1999) - PUNTO II 1.3 JTD 16V - 1.8i HGT d110x102mm 1f-d87mm 1f-d27mm
	M6028 NO. 82407143 JUNTA DE ESCAPE FIAT COUPE (APÓS 1993) d57x10mm 1f-d47mm		M6033 NO. 7578742 JUNTA DE ESCAPE FIAT COUPE (APÓS 1993) 85x85mm 1f-d54mm
	M6074 NO. 82473208 - 82423525 JUNTA DE ESCAPE FIAT COUPÉ (APÓS 1993) 96x96mm 1f-d53.5mm		N2331 NO. 4422885 - 7610077 - 4437668 ANEL ESCAPE FIAT COUPE (APÓS 1993) d58x14mm 1f-d31mm
	P1079 NO. 7744827 CAPA DO PEDAL DO TRAVÃO E EMBRAIAGEM FIAT COUPE (FA175) 1.8 16V (03-1996 A 08-2000) 131CV 1747CC - FIAT COUPE (FA175) 2.0 16V (11-1993 A 08-1996) 139CV 1995CC - FIAT COUPE (FA175) 2.0 16V TURBO (11-1993 A 08-1996) 190CV 1995CC 88x64x10mm NULL		RT08417 NO. 7667806 TUBO DE TRAVÃO TRÁS LH-RH FIAT COUPÉ TT (1993 A 1996) 240mm FB23 - FB23
	RT08427 NO. 7563852 - 7603330 TUBO DE TRAVÃO TRÁS LH-RH FIAT BARCHETTA 1.8 16V (APÓS 1994) - 1.2 16V (1997 A 09-1999) 217mm FB23 - FB23		RT08459 NO. 46786435 - 7586907 TUBO DE TRAVÃO TRÁS LH-RH FIAT BARCHETTA 1.8 16V (APÓS 04-1995) 182mm FB23 - MC11
	RT08459 NO. 46786435 - 7586907 TUBO DE TRAVÃO TRÁS LH-RH FIAT COUPE 1.8 16V (03-1996 A 08-2000) - 2.0 16V (11-1993 A 08-1996) - 2.0 16V TURBO (11-1993 A 08-1996) - 2.0 20V (08-1996 A 08-2000) - 2.0 20V TURBO (08-1996 A 08-2000) 182mm FB23 - MC11		RT08486 NO. 7670215 TUBO DE TRAVÃO TRÁS LH-RH (COM ABS) FIAT COUPÉ 1.8 16V - 2.0 16V - 2.0 20V - 2.0 20V TURBO (1993 A 2000) 245mm FB23 - FB23

	<p>RT08560 NO. 46423178 - 46423179</p> <p>TUBO DE TRAVÃO FRENTE LH-RH</p> <p>FIAT BARCHETTA 1.8 16V (APÓS 1994)</p>		<p>S1161D20 NO. 7601065</p> <p>SILENT- BLOC CENTRAL DO BRAÇO DA SUSPENSÃO DIANTEIRO (DIREITO)</p> <p>FIAT COUPE 1.8 16V 131CV (03-1996 A 08-2000) - 2.0 16V 139CV (11-1993 A 08-1996) - 2.0 20V 147CV (08-1996 A 04-1998) - 2.0 20V 154CV (04-1998 A 08-2000) - 2.0 16V TURBO 190CV (11-1993 A 08-1996) - 2.0 20V TURBO 220CV (08-1996 A 08-2000)</p>
	<p>S1161D21 NO. 60603027</p> <p>SILENT-BLOC CENTRAL DO BRAÇO DA SUSPENSÃO DIANTEIRO (DIREITO)</p> <p>FIAT COUPE 1.8 16V 131CV (03-1996 A 08-2000) - 2.0 16V 139CV (11-1993 A 08-1996) - 2.0 20V 147CV (08-1996 A 04-1998) - 2.0 20V 154CV (04-1998 A 08-2000) - 2.0 16V TURBO 190CV (11-1993 A 08-1996) - 2.0 20V TURBO 220CV (08-1996 A 08-2000)</p>		<p>S1162E20 NO. 7601068</p> <p>SILENT- BLOC CENTRAL DO BRAÇO DA SUSPENSÃO DIANTEIRO(ESQUERDO)</p> <p>FIAT COUPE 1.8 16V 131CV (03-1996 A 08-2000) - 2.0 16V 139CV (11-1993 A 08-1996) - 2.0 20V 147CV (08-1996 A 04-1998) - 2.0 20V 154CV (04-1998 A 08-2000) - 2.0 16V TURBO 190CV (11-1993 A 08-1996) - 2.0 20V TURBO 220CV (08-1996 A 08-2000)</p>
	<p>S1162E21 NO. 60603028</p> <p>SILENT- BLOC CENTRAL DO BRAÇO DA SUSPENSÃO DIANTEIRO(ESQUERDO)</p> <p>FIAT COUPE 1.8 16V 131CV (03-1996 A 08-2000) - 2.0 16V 139CV (11-1993 A 08-1996) - 2.0 20V 147CV (08-1996 A 04-1998) - 2.0 20V 154CV (04-1998 A 08-2000) - 2.0 16V TURBO 190CV (11-1993 A 08-1996) - 2.0 20V TURBO 220CV (08-1996 A 08-2000)</p>		<p>S1189F20 NO. 7601064</p> <p>SILENT- BLOC CENTRAL DO BRAÇO DA SUSPENSÃO DIANTEIRO</p> <p>FIAT COUPE 1.8 16V 131CV (03-1996 A 08-2000) - 2.0 16V 139CV (11-1993 A 08-1996) - 2.0 20V 147CV (08-1996 A 04-1998) - 2.0 20V 154CV (04-1998 A 08-2000) - 2.0 16V TURBO 190CV (11-1993 A 08-1996) - 2.0 20V TURBO 220CV (08-1996 A 08-2000)</p>
	<p>S1189F21 NO.</p> <p>SILENT- BLOC CENTRAL DO BRAÇO DA SUSPENSÃO DIANTEIRO</p> <p>FIAT COUPE 1.8 16V 131CV (03-1996 A 08-2000) - 2.0 16V 139CV (11-1993 A 08-1996) - 2.0 20V 147CV (08-1996 A 04-1998) - 2.0 20V 154CV (04-1998 A 08-2000) - 2.0 16V TURBO 190CV (11-1993 A 08-1996) - 2.0 20V TURBO 220CV (08-1996 A 08-2000)</p>		<p>Z80447 NO. 14211880</p> <p>Mola de fixação</p> <p>FIAT COUPE</p>
	<p>Z80476 NO. 14188282 - 46306526 - 60507749</p> <p>Mola de painel</p> <p>FIAT COUPE</p>		<p>Z80541 NO. 46305824</p> <p>Mola de painel</p> <p>FIAT COUPE</p>
	<p>Z80605 NO. 7745194</p> <p>Mola de fixação</p> <p>FIAT BARCHETTA</p>		<p>Z80612 NO. 7569468</p> <p>Mola de fixação</p> <p>FIAT COUPE</p>
	<p>Z80634 NO. 7777069</p> <p>Mola de friso</p> <p>FIAT COUPE</p>		<p>Z80647 NO. 14222380</p> <p>Mola de fixação</p> <p>FIAT BARCHETTA</p>
	<p>Z80669 NO. 7768047</p> <p>Mola de painel</p> <p>FIAT BARCHETTA</p>		<p>Z80705 NO. 14191280 - 82377183</p> <p>Mola de painel</p> <p>FIAT BARCHETTA</p>

	Z80727	NO. 7798971		
	Mola de fixação FIAT BARCHETTA			
	d18x19mm	1p-d7.5-12mm		

FIAT CROMA









	F0060-I	NO. 4239459 - 4371156		F0388-I	NO. 4315444
	FOLE DA CREMALHEIRA DA DIRECÇÃO DIREITO (F1038) FIAT CROMA			FOLE DO DIFERENCIAL FIAT CROMA	
	d59x180mm	d47mm 1f-d1f-d26mm 1f-d10mm		d77x85mm	1f-d62mm 1f-d24mm
	F0469-I	NO. 43307029 - 82282140		F0867-I	NO. 9939555
	FOLE DA TRANSMISSÃO LADO DA CAIXA FIAT CROMA (APÓS 1992)			FOLE DA DIRECÇÃO ASSISTIDA LADO DIREITO E ESQUERDO FIAT CROMA 1.6 - 1.9 TDID - 2.0 CHT - 2.0 ie - 2.0 ie TURBO - 2.4 TD - 2.5 D (85 A 96)	
	d85x80mm	1f-d61mm 1f-d23mm		d60x200mm	1f-d50mm 1f-d10mm
	F0897-I	NO. 82483504		F1118-I	NO. 60760026 - 9938779
	FOLE JUNTO Á RODA FIAT CROMA (APÓS 10-1986)			FOLE DA DIRECÇÃO LADO DIREITO FIAT CROMA (DIRECÇÃO ASSISTIDA) (1985 A 1996)	
	d100x98mm	1f-d86mm 1f-d26mm		d65x210mm	1f-d45mm 1f-d10mm
	F1119-I	NO. 9943835 - 9938779		F1335-I	NO. 36020064
	FOLE DA DIRECÇÃO LADO ESQUERDO FIAT CROMA (DIRECÇÃO ASSISTIDA)			FOLE DA DIRECÇÃO LADO DIREITO FIAT CROMA (APÓS 1994)	
	d65x165mm	1f-d46mm 1f-d10mm		130x75x225mm	1f-100/47mm 1f-d18mm 1f-d10mm
	F1336-I	NO. 36020065 - 9943835		F1822-I	NO. 4315444 - 46307029
	FOLE DA DIRECÇÃO DO LADO ESQUERDO FIAT CROMA DIRECÇÃO ASSISTIDA (APÓS 1994)			FOLE DA TRANSMISSÃO JUNTO Á CAIXA FIAT CROMA 1.6 1600 - 1.9TD i.d.1900 Turbo Diesel - 2.0 2000 CHT - 2.0 i.e. 2000 - 2.0 i.e.T 2000 Turbo - 2.0i 2000 16V - 2.5TD i.d. 2500 (85 A 96)	
	87x81x170mm	1f-d45mm 1f-d10mm		d102x94mm	1f-d99mm 1f-d25mm
	M6028	NO. 82407143		M6038	NO. 7646609 - 7664769 - 7678282 - 4147260 - 5891207 - 4211272
	JUNTA DE ESCAPE FIAT CROMA (1985 A 1996)			JUNTA DE ESCAPE FIAT CROMA (1985 A 1990)	
	d57x10mm	1f-d47mm		104x76mm	2f-d37mm

	<p>M6042 NO. 4152873 - 4166914 - 82460789 - 4177919 - 7681460</p> <p>JUNTA DE ESCAPE</p> <p>FIAT CROMA (1986 A 1996)</p> <p>115x72mm 2f-d40mm</p>		<p>M6074 NO. 82473208 - 82423525</p> <p>JUNTA DE ESCAPE</p> <p>FIAT CROMA (1986 A 1996)</p> <p>96x96mm 1f-d53.5mm</p>
	<p>P1063 NO. 71740375</p> <p>CAPA DE PEDAL DA EMBRAIAGEM</p> <p>FIAT CROMA (194) 1.8 16V (APÓS 12-2005) 140CV 1796CC - FIAT CROMA (194) 2.2 16V (APÓS 06-2005) 147CV 2198CC - FIAT CROMA (194) 1.9 D MULTIJET (APÓS 06-2005) 120CV 1910CC - FIAT CROMA (194) 1.9 D MULTIJET (APÓS 06-2005) 150CV 1910CC - FIAT CROMA (194) 2.4</p> <p>65x64x12mm NULL</p>		<p>P1064 NO. 71740374</p> <p>CAPA DE PEDAL DO TRAVÃO</p> <p>FIAT CROMA (194) 1.8 16V (APÓS 12-2005) 140CV 1796CC - FIAT CROMA (194) 2.2 16V (APÓS 06-2005) 147CV 2198CC - FIAT CROMA (194) 1.9 D MULTIJET (APÓS 06-2005) 120CV 1910CC - FIAT CROMA (194) 1.9 D MULTIJET (APÓS 06-2005) 150CV 1910CC - FIAT CROMA (194) 2.4</p> <p>66x64x12mm NULL</p>
	<p>W5023 NO. 55187707 - 55184474 - 55217328 - 46544615 - 46427969 - 60815929 - 46742884 - 71747796 - 55215574</p> <p>POLIE DA CAMBOTA (6 pistas)</p> <p>FIAT CROMA (MOD. 2005) 2.4D MULTIJET</p> <p>d181mm d30.5mm</p>		<p>W5093 NO. 55208280 - 55196974 - 93191381 - 614571 - 2005302 - 2005758 - 20000281 - 93191382 - 1261019J50 - 551...</p> <p>POLIE DA CAMBOTA (6 PISTAS)</p> <p>FIAT CROMA 1.9 D MULTIJET (APÓS 06-2005)</p> <p>d165mm d30.5mm</p>
	<p>W5145 NO. 55210310 - 0614359 - 614359 - 93192547</p> <p>POLIE DA CAMBOTA 6 PISTAS</p> <p>FIAT CROMA (194_) 1.9 D Multijet (APÓS 06.05) 115cv 1910cc Combi - FIAT CROMA (194_) 1.9 D Multijet (APÓS 06.05) 120cv 1910cc Combi - FIAT CROMA (194_) 1.9 D Multijet (APÓS 12.05) 136cv 1910cc Combi - FIAT CROMA (194_) 1.9 D Multijet (APÓS 06.05) 150cv 1910cc Combi</p> <p>d169mm d30,5mm</p>		<p>Z80466 NO. 5944525</p> <p>Mola de fixação</p> <p>FIAT CROMA</p> <p>15x9x14mm 1p-d5.5-5mm</p>
	<p>Z80502 NO. 5757553</p> <p>Mola de retenção</p> <p>FIAT CROMA</p> <p>d16x9.5mm 1p-7x7-8.5mm 1f-d4.8mm</p>		<p>Z80547 NO. 82407538</p> <p>Mola de friso</p> <p>FIAT CROMA</p> <p>NULL NULL</p>
	<p>Z80612 NO. 7569468</p> <p>Mola de fixação</p> <p>FIAT CROMA</p> <p>d10x33.7mm 1p-d6-18.5mm</p>		<p>Z80619 NO. 7677865</p> <p>Mola de painel</p> <p>FIAT CROMA</p> <p>d14x12mm 1p-d7.5-10mm</p>
	<p>Z80625 NO. 82421028 - 504056662</p> <p>Mola de fixação</p> <p>FIAT CROMA</p> <p>d18x42.5mm 1p-d8-19mm</p>		<p>Z80651 NO. 82426359</p> <p>Mola de fixação</p> <p>FIAT CROMA</p> <p>d18x42mm 1p-d10-19mm</p>
	<p>Z80686 NO. 7770156</p> <p>Mola de friso</p> <p>FIAT CROMA (Após 2005)</p> <p>NULL NULL</p>		<p>Z80703 NO. 5988006</p> <p>Mola de fixação</p> <p>FIAT CROMA</p> <p>d15x24mm 1p-d6.5-12mm</p>

	Z80814	NO. 51761163 - 7703072361		
	NULL			
	FIAT CROMA (Após 2005)			
	d12x24mm	1p-d6.5-12mm		





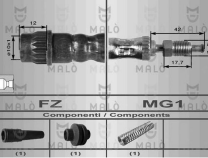
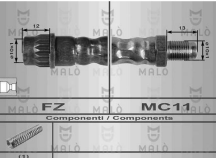
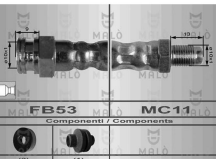







FIAT DOBLO-SCUDO

	A1588	NO. 9618154180		A1641	NO. 46759568
	APOIO DO MOTOR PARTE DE TRÁS			APOIO DO MOTOR PARTE DA FRENTE	
	FIAT SCUDO 1.9 TD			FIAT DOBLÓ 1.9D - 1.9 JTD - DOBLÓ (2004-2005) 1.9 DS ASP CF3 - 1.9 JTD CF3 105CV - DOBLÓ APOS 2005 1910 JTD	
	140x98x92mm	NULL		240x180x150mm	NULL
	A1689	NO. 467597737		E0144	NO. 1317425080 - 1308664080
	APOIO DO MOTOR PARTE DE TRÁS			ESTICADOR DA BARRA ESTABILIZADORA DA FRENTE	
	FIAT DOBLÓ 1.9D - 1.9 JTD - DOBLÓ (2004-2005) 1.9 DS ASP CF3 - 1.9 JTD CF3 (105CV) - 1250 MJTD 51 KW - DOBLÓ APOS 2005 1.3 MJTD - 1910 JTD			FIAT SCUDO TT - ULYSSE TT	
	230x140x140mm	1f-d19mm		120x40x40mm	1p-d12-25mm 1f-d12mm
	E0177	NO. 46799278 - 46767267		E0215-M	NO. 46759739 - 46767476
	ESTICADOR DA BARRA ESTABILIZADORA DE TRÁS			ESTICADOR DO MOTOR PARTE DE TRÁS	
	FIAT DOBLO (2000-2005) TT - DOBLO RESTYLING (2005) TT			FIAT DOBLÓ 1.2 - 1.9D - 1.9 JTD - DOBLÓ (2004-2005) 1.2 8V CF3 - 1.9 DS ASP CF3 - 1.9 JTD CF3 105CV - 1250 MJTD 51 KW - DOBLÓ APOS 2005 1.3 MJTD - 1910 JTD	
	145x25x30mm	2p-d10-21mm		200x100x60mm	1f-d12/20mm 1f-d12mm
	E0265-M	NO. 51837816		F0835A5I	NO. 46307071 - 46307436 - 46307503 - 46307784 - 60813077
	ESTICADOR DO MOTOR PARTE DE TRÁS			FOLE DA TRANSMISSÃO JUNTO À CAIXA	
	FIAT DOBLO Veículo multiuso (263_) 1.3 D Multijet (APÓS 02.10) 90cv 1248cc Veículo multiuso - FIAT DOBLO Caixa/Combi (263_) 1.3 D Multijet (APÓS 02.10) 90cv 1248cc Caixa/Combi - FIAT DOBLO Camião de plataforma/chassis (263_) 1.3 D Multijet (APÓS 02.10) 90cv 1248cc Camião de plataforma/chassis			FIAT DOBLO (APÓS 03-2001) 1.2 i - 1.9D	
	230x110x50mm	1f-18x12mm 1f-19x14mm		d93x87mm	1f-d79mm 1f-d24.4mm
	F1356-I	NO. 9564479480		F1667-I	NO. 9404066418
	FOLE DO LADO DA CAIXA			FOLE DIREÇÃO ASSISTIDA LADO DIREITO E ESQUERDO	
	FIAT SCUDO 1905 cc. TURBO DIESEL (APÓS 9-94)			FIAT SCUDO 1.6i - 1.9 d - 1.9 TD - 2.0 JTD (APÓS 1996)	
	d85x90mm	1f-d76mm 1f-d28mm		d65x200mm	1f-d58mm 1f-d10mm
	F1781-I	NO. 272441		F1910-T	NO. 40308383 - 46308480 - 1607740880 - LR003160 - 39242EB30B - C9241EB30A
	FOLE DA TRANSMISSÃO JUNTO À CAIXA			FOLE DO EIXO DE TRANSMISSÃO LADO DA RODA	
	FIAT DOBLO & CARGO 1.3 MJTD 16V (APÓS 2001)			FIAT DOBLO Veículo multiuso (263_) 2.0 D Multijet (A Partir de 02.10) 135cv 1956cc Veículo multiuso - FIAT DOBLO Caixa/Combi (263_) 2.0 D Multijet (A Partir de 02.10) 135cv 1956cc Caixa/Combi - FIAT DOBLO Camião de plataforma/chassis (263_) 2.0 D Multijet (A Partir de 02.10) 135cv 1956cc Camião de plataforma/chassis	
	d88x83mm	1f-d82mm 1f-d22mm		d120x150mm	1f-d28mm 1f-d100mm

	<p>F4037 NO. 9404066418</p> <p>FOLE DA DIRECÇÃO LADO DIREITO E ESQUERDO</p> <p>FIAT SCUDO 1.6 i - 1.9 D - 1.9 TD - 2.0 JTD (APÓS 96)</p> <p>d72/54x240mm 1f-d68mm 1f-d10mm</p>		<p>F4048 NO. 98845034</p> <p>FOLE DA DIRECÇÃO LADO ESQUERDO E DIREITO</p> <p>FIAT DOBLO & CARGO (APÓS 2001) 1.2i - 1.6i 16V - 1.9 D - 1.9 JTD</p> <p>d61x190mm 1f-d53mm 1f-d14mm</p>
	<p>F9052H-I NO. 46308465</p> <p>FOLE DO CARDAN LADO DA RODA</p> <p>FIAT DOBLO Cassone - Furgonato - promiscuo(263) 1.3 D Multijet (199 A3.000 - 263 A2.000) 90CV (APÓS 02-2010) - MPV - Space wagon (152 - 263) 1.3 D Multijet 199 A3.000 - 263 A2000) 90CV (APÓS 02-2010) - DOBLO Pianale piatto-telaio (263) 1.3 Multijet (199 A3.000</p> <p>d105x125mm 1f-d28mm 1f-d88mm</p>		<p>KF1406-T NO. 9567504880</p> <p>KIT DE FOLE DO CARDAN JUNTO À RODA</p> <p>FIAT SCUDO 2.0 JTD - 2.0 JTD 16V (APÓS 1996) - ULYSSE I 1.9 TD - 2.0 JTD - 2.0i T - 2.1 TD - 2.2 JTD - 3.0i V6 (1994 A 2002) - ULISSE II 2.0 JTD - 2.2 JTD - 3.0i (APÓS 2002)</p> <p>d110x120mm 1f-d99mm 1f-d30mm</p>
	<p>KF1477-T NO. 9464383788</p> <p>KIT DE FOLE DO CARDAN JUNTO À RODA</p> <p>FIAT DOBLO (APÓS 2001) 1.9 JTD - CARGO (APÓS 2001) 1.9 JTD</p> <p>d116x149mm 1f-d97mm 1f-d29mm</p>		<p>KF1798-T NO.</p> <p>KIT DE FOLE DO CARDAN JUNTO À RODA</p> <p>FIAT DOBLO & CARGO 1.2i - 1.9D (APÓS 2001) - IDEA 1.2i - 1.4i - 1.4i 16V (APÓS 2004) - PALIO 1.9D (APÓS 1996) - PUNTO II 1.2i - 1.2i 16V - 1.2i CNG NATURAL POWER - 1.4i - 1.9D (APÓS 1999) - STILO 1.2i 16V - 1.6i 16V (APÓS 2001)</p> <p>d95x95mm 1f-d74mm 1f-d22mm</p>
	<p>KF2271-T NO. 46307716</p> <p>KIT DE FOLE DO CARDAN JUNTO À RODA</p> <p>FIAT DOBLO & CARGO 1.9 JTD (APÓS 2001) - STRADA 1.9 JTD (APÓS 1999)</p> <p>d105x125mm 1f-d83mm 1f-d25mm</p>		<p>KF3788-T NO. 46307716</p> <p>KIT DE FOLE DO CARDAN JUNTO À RODA</p> <p>FIAT DOBLO CARGO 1.3 MJTD 16V (APÓS 2001)</p> <p>d100x122mm 1f-d83mm 1f-d25mm</p>
	<p>P1082 NO. 4213235</p> <p>CAPA DE PEDAL DO ACELARADOR</p> <p>FIAT SCUDO CAIXA (220L) 1.6 (02-1996 A 12-2006) 79CV 1581CC</p> <p>104x45x8mm NULL</p>		<p>P1098 NO. 71736224</p> <p>CAPA DO PEDAL DO TRAVÃO E EMBRAIAGEM</p> <p>FIAT DOBLO Veículo multiuso (119_ - 223_) 1.2 (223AXA1A) (APÓS 03.01) 65cv 1242cc Veículo multiuso - FIAT DOBLO Veículo multiuso (119_ - 223_) 1.4 (APÓS 10.05) 77cv 1368cc Veículo multiuso - FIAT DOBLO Veículo multiuso (119_ - 223_) 1.6 16V (223AXD1A) (APÓS 10.01) 103cv 1596cc Veículo multiuso - FIAT DOBLO Veículo multiuso (119_ - 223_) 1.6 Natural Power (APÓS 09.02) 103cv 1596cc Veículo multiuso - FIAT DOBLO Veículo multiuso (11...etc.</p> <p>83x48x10mm 74-40mm</p>
	<p>Q2009 NO.</p> <p>UNIÃO DE ESCAPE 48/45x80mm</p> <p>FIAT - SCUDO Combinato (220P) - 1.6 (02.96 - 12.06) 79cv 1581cc Combi - FIAT - SCUDO Combinato (220P) - 1.9 D (04.98 - 12.06) 69cv 1868cc Combi - FIAT - SCUDO Combinato (220P) - 1.9 D (02.96 - 04.98) 69cv 1905cc Combi - FIAT - SCUDO Caixa (220L) - 1.6 (</p> <p>80x77x55mm 1f-d45/48mm</p>		<p>RT08569 NO. 147919080 - 480682</p> <p>TUBO DE TRAVÃO FRENTE LH-RH</p> <p>FIAT SCUDO TT (APÓS 07-1995)</p> <p>515mm FZ - MG1</p>
	<p>RT08570 NO. 1472155080 - 480668</p> <p>TUBO DE TRAVÃO TRÁS LH-RH</p> <p>FIAT SCUDO TT (APÓS 07-1995)</p> <p>325mm FZ - MC11</p>		<p>RT08573 NO. 1472157080 - 480667</p> <p>TUBO DE TRAVÃO TRÁS LH-RH</p> <p>FIAT SCUDO TT (APÓS 07-1995)</p> <p>275mm FZ - FZ</p>
	<p>RT08915 NO. 46738613</p> <p>TUBO DE TRAVÃO FRENTE LH-RH</p> <p>FIAT DOBLO (2000 A 2004) TT APÓS 2001</p> <p>500mm FB53 - MC11</p>		<p>RT08916 NO. 46749271</p> <p>TUBO DE TRAVÃO TRÁS LH-RH</p> <p>FIAT DOBLO (2000 A 2004) TT APÓS 2001</p> <p>465mm FB42 - FB42</p>

 	RT80318 NO. 1401070380 TUBO DE TRAVÃO TRÁS LH-RH FIAT SCUDO TT (APÓS 01-2007)	 	RT80329 NO. 1401070480 TUBO DE TRAVÃO TRÁS LH-RH FIAT SCUDO TT (APÓS 01-2007)
	270mm FZ2 - FZ2		380mm FZ2 - FZ2
 	RT80361 NO. 1498442080 TUBO DE TRAVÃO FRENTE LH-RH FIAT SCUDO TT (APÓS 01-2007)		S1468 NO. 1313083080 - 1305551080 SILENT BLOC ESQUERDO DO BRAÇO DA SUSPENSÃO DA FRENTE FIAT SCUDO 1.6 - 1.9D - 1.9TD - 1.9TD ECO - 2.0 - 2.0JTD (APÓS 1996)
	510mm F22 - MG9		130x132x85mm d60mm c62mm 1f-d22.8mm
	S1469 NO. 1313084080 - 1305552080 SILENT BLOC DIREITO DO BRAÇO DA SUSPENSÃO DA FRENTE FIAT SCUDO 1.6 - 1.9D - 1.9TD - 1.9TD ECO - 2.0 - 2.0JTD (APÓS 1996)		S1470 NO. 1312317080 SILENT BLOC CENTRAL DO BRAÇO DA SUSPENSÃO DA FRENTE FIAT SCUDO 1.6 - 1.9D - 1.9TD - 1.9TD ECO - 2.0 - 2.0JTD (APÓS 1996)
	130x132x85mm d60mm c62mm 1f-d22.8mm		126x50x62mm 1f-d22.8mm 2f-d12mm
	S1530 NO. 46473041 SILENT BLOC DA MOLA DE LÂMINA DO EIXO TRASEIRO FIAT - DOBLO (223 - 119) - 1.2 (223AXA1A) (APÓS 03.01) 65cv 1242cc - FIAT - DOBLO (223 - 119) - 1.4 (APÓS 10.05) 77cv 1368cc - FIAT - DOBLO (223 - 119) - 1.6 16V (223AXD1A) (APÓS 10.01) 103cv 1596cc - FIAT - DOBLO (223 - 119) - 1.6 Natural Power (APÓS 09.02)		S1591 NO. 46766963 SILENTBLOC OLHAL MOLA LAMINA FIAT DOBLO Veículo multiuso (119_ - 223_) 1.2 (223AXA1A) (A Partir de 03.01) 65cv 1242cc Veículo multiuso - FIAT DOBLO Veículo multiuso (119_ - 223_) 1.4 (A Partir de 10.05) 77cv 1368cc Veículo multiuso - FIAT DOBLO Veículo multiuso (119_ - 223_) 1.6 16V (223AXD1A) (A Partir de 10.01) 103cv 1596cc Veículo multiuso - FIAT DOBLO Veículo multiuso (119_ - 223_) 1.6 (A Partir de 09.02) 103cv 1596cc Veículo multiuso - FIAT DOBLO Veículo multiuso...etc.
	d38x77mm c60mm d35mm 1f-d14mm		d56x77mm c70mm 1f-d16mm
	S1594 NO. 5131F4 - 1400171280 SILENT-BLOC SUSPENSÃO EIXO TRASEIRO FIAT SCUDO (270_ - 272_) 1.6 D Multijet (A partir de 01.07) 90cv 1560cc Veículo multiuso - FIAT SCUDO (270_ - 272_) 2.0 D Multijet (A partir de 01.07) 120cv 1997cc Veículo multiuso - FIAT SCUDO (270_ - 272_) 2.0 D Multijet (A partir de 04.11) 128cv 1997cc Veículo multiuso - FIAT SCUDO (270_ - 272_) 2.0 D Multijet (A partir de 01.07) 136cv 1997cc Veículo multiuso - FIAT SCUDO (270_ - 272_) 2.0 D Multijet (A partir de 07.10) 163cv 1997cc Ve...etc.		S1595 NO. 50511650 - 50521486 - 51783056 - 51783057 SILENT-BLOC BRAÇO SUPERIOR FRENTE FIAT DOBLO Veículo multiuso (263_) 1.4 (A Partir de 02.10) 95cv 1368cc Veículo multiuso - FIAT DOBLO Veículo multiuso (263_) 1.4 (A Partir de 10.11) 120cv 1368cc Veículo multiuso - FIAT DOBLO Veículo multiuso (263_) 1.4 Natural Power (A partir de 02.10) 120cv 1368cc Veículo multiuso - FIAT DOBLO Veículo multiuso (263_) 1.3 D Multijet (A Partir de 02.10) 90cv 1248cc Veículo multiuso - FIAT DOBLO Veículo multiuso (263_) 1.6 D Multi...etc.
	d68x70mm c46mm 1f-d16mm		d53x67mm d41mm 1f-d14mm
	T0650-I NO. 46751548 - 5166751 BATENTE SUSPENSÃO DE TRÁS FIAT DOBLO Veículo multiuso (119_ - 223_) 1.2 (223AXA1A) (APÓS 03.01) 65cv 1242cc Veículo multiuso - FIAT DOBLO Veículo multiuso (119_ - 223_) 1.4 (APÓS 10.05) 77cv 1368cc Veículo multiuso - FIAT DOBLO Veículo multiuso (119_ - 223_) 1.6 16V (223AXD1A) (APÓS 10.01) 103cv 1596cc Veículo multiuso - FIAT DOBLO Veículo multiuso (119_ - 223_) 1.6 Natural Power (APÓS 09.02) 103cv 1596cc Veículo multiuso - FIAT DOBLO Veículo multiuso (11...etc.		T0651-I NO. 46817717 BATENTE SUSPENSÃO DE TRÁS FIAT DOBLO Veículo multiuso (119_ - 223_) 1.2 (223AXA1A) (APÓS 03.01) 65cv 1242cc Veículo multiuso - FIAT DOBLO Veículo multiuso (119_ - 223_) 1.4 (APÓS 10.05) 77cv 1368cc Veículo multiuso - FIAT DOBLO Veículo multiuso (119_ - 223_) 1.6 16V (223AXD1A) (APÓS 10.01) 103cv 1596cc Veículo multiuso - FIAT DOBLO Veículo multiuso (119_ - 223_) 1.6 (APÓS 09.02) 103cv 1596cc Veículo multiuso - FIAT DOBLO Veículo multiuso (119_ - 223_) 1.3...etc.
	d85x141mm 1f-d23mm 1p-d10x19mm		d85x152mm 1f-d23mm 1p-d9x17mm
	T0652-I NO. 51759794 - 51755085 BATENTE SUSPENSÃO DE TRÁS FIAT DOBLO Cargo (223_) 1.2 (APÓS 03.01) 65cv 1242cc Caixa/Combi - FIAT DOBLO Cargo (223_) 1.4 (APÓS 10.05) 77cv 1368cc Caixa/Combi - FIAT DOBLO Cargo (223_) 1.6 16V (APÓS 10.01) 103cv 1596cc Caixa/Combi - FIAT DOBLO Cargo (223_) 1.6 (APÓS 09.02) 103cv 1596cc Caixa/Combi - FIAT DOBLO Cargo (223_) 1.3 JTD 16V (05.04 A 12.06) 70cv 1248cc Caixa/Combi - FIAT DOBLO Cargo (223_) 1.3 D Multijet (10.05 A 01.10) 75cv 1248cc Caixa/Combi - FIAT DO...etc.		T0653-I NO. 51755085 - 51759794 BATENTE SUSPENSÃO DE TRÁS FIAT DOBLO Veículo multiuso (119_ - 223_) 1.4 (APÓS 10.05) 77cv 1368cc Veículo multiuso - FIAT DOBLO Veículo multiuso (119_ - 223_) 1.6 Natural Power (APÓS 09.02) 103cv 1596cc Veículo multiuso - FIAT DOBLO Veículo multiuso (119_ - 223_) 1.3 D Multijet (APÓS 10.05) 84cv 1248cc Veículo multiuso - FIAT DOBLO Veículo multiuso (119_ - 223_) 1.9 D Multijet (APÓS 10.05) 120cv 1910cc Veículo multiuso - FIAT DOBLO Cargo (223_) 1.4 (APÓS 1...etc.
	d87x167mm 1f-d26mm 1p-d10x18mm		d87x166mm 1f-d26mm 1p-d10x18mm
	T0654-I NO. 51759794 BATENTE SUSPENSÃO DE TRÁS FIAT DOBLO Cargo (223_) 1.2 (APÓS 03.01) 65cv 1242cc Caixa/Combi - FIAT DOBLO Cargo (223_) 1.4 (APÓS 10.05) 77cv 1368cc Caixa/Combi - FIAT DOBLO Cargo (223_) 1.6 16V (APÓS 10.01) 103cv 1596cc Caixa/Combi - FIAT DOBLO Cargo (223_) 1.6 (APÓS 09.02) 103cv 1596cc Caixa/Combi - FIAT DOBLO Cargo (223_) 1.3 JTD 16V (05.04 A 12.06) 70cv 1248cc Caixa/Combi - FIAT DOBLO Cargo (223_) 1.3 D Multijet (10.05 A 01.10) 75cv 1248cc Caixa/Combi - FIAT DO...etc.		T0655-I NO. 51755085 BATENTE SUSPENSÃO DE TRÁS FIAT DOBLO Veículo multiuso (119_ - 223_) 1.4 (APÓS 10.05) 77cv 1368cc Veículo multiuso - FIAT DOBLO Veículo multiuso (119_ - 223_) 1.6 Natural Power (APÓS 09.02) 103cv 1596cc Veículo multiuso - FIAT DOBLO Veículo multiuso (119_ - 223_) 1.3 D Multijet (APÓS 10.05) 84cv 1248cc Veículo multiuso - FIAT DOBLO Veículo multiuso (119_ - 223_) 1.9 D Multijet (APÓS 10.05) 120cv 1910cc Veículo multiuso - FIAT DOBLO Cargo (223_) 1.4 (APÓS 1...etc.
	d85x162mm 1f-d10mm 1p-d10x18mm		d85x161mm 1f-d23mm 1p-d10x17mm



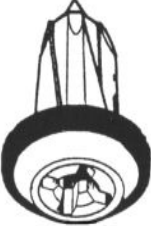
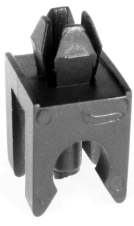









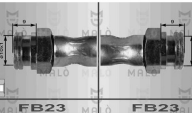

	<p>T0660-I NO. 51810447 - 51810447A</p> <p>BATENTE SUSPENSÃO DA FRENTE</p> <p>FIAT DOBLO Veículo multiuso (263_) 1.4 (APÓS 02.10) 95cv 1368cc Veículo multiuso - FIAT DOBLO Veículo multiuso (263_) 1.4 (APÓS 10.11) 120cv 1368cc Veículo multiuso - FIAT DOBLO Veículo multiuso (263_) 1.4 Natural Power (APÓS 02.10) 120cv 1368cc Veículo multiuso - FIAT DOBLO Veículo multiuso (263_) 1.3 D Multijet (APÓS 02.10) 90cv 1248cc Veículo multiuso - FIAT DOBLO Veículo multiuso (263_) 1.6 D Multijet (APÓS 02.10) 90cv 1598cc Ve...etc.</p> <p>d63x86mm 1f-d31mm 1f-d23mm</p>		<p>T0661-I NO. 51851802 - 51851802A</p> <p>BATENTE SUSPENSÃO DE TRÁS</p> <p>FIAT DOBLO Veículo multiuso (263_) 1.4 (APÓS 02.10) 95cv 1368cc Veículo multiuso - FIAT DOBLO Veículo multiuso (263_) 1.4 (APÓS 10.11) 120cv 1368cc Veículo multiuso - FIAT DOBLO Veículo multiuso (263_) 1.4 Natural Power (APÓS 02.10) 120cv 1368cc Veículo multiuso - FIAT DOBLO Veículo multiuso (263_) 1.3 D Multijet (APÓS 02.10) 90cv 1248cc Veículo multiuso - FIAT DOBLO Veículo multiuso (263_) 1.6 D Multijet (APÓS 02.10) 90cv 1598cc Ve...etc.</p> <p>d63x99mm 1f-d27mm 1f-d23mm</p>
	<p>T0665-I NO. 503339 - 1307021080</p> <p>BATENTE SUSPENSÃO DA FRENTE</p> <p>FIAT SCUDO Combinato (220_) 1.6 (02.96 A 12.06) 79cv 1581cc Combi - FIAT SCUDO Combinato (220_) 2.0 16V (06.00 A 12.06) 136cv 1997cc Combi - FIAT SCUDO Combinato (220_) 1.9 D (04.98 A 12.06) 69cv 1868cc Combi - FIAT SCUDO Combinato (220_) 1.9 D (02.96 A 04.98) 69cv 1905cc Combi - FIAT SCUDO Combinato (220_) 1.9 TD Eco (02.96 A 12.06) 90cv 1905cc Combi - FIAT SCUDO Combinato (220_) 1.9 TD (02.96 A 12.06) 92cv 1905cc Combi - FIAT SCUDO Combin...etc.</p> <p>d54x107mm 1f-d25mm 1f-d20mm</p>		<p>T1095 NO. 7750990</p> <p>BATENTE DA BARRA ESTABILIZADORA DA FRENTE</p> <p>FIAT DOBLO APÓS 2000 1.2 - 1.6(16V) - 1.9D - 1.9 JTD</p> <p>87x31x34mm NULL</p>
	<p>T1123 NO. 1305782080</p> <p>BATENTE DA BARRA ESTABILIZADORA DA FRENTE</p> <p>FIAT SCUDO 1.6 D MULTIJET 9HU 90CV (APÓS 01-2007) - 2.0 D MULTIJET MOTORE GENERICO 128CV (APÓS 04-2011) - 2.0 D MULTIJET RHH 163CV (APÓS 07-2010) - 2.0 D MULTIJET RHK 120CV (APÓS 01-2007) - 2.0 D MULTIJET RHR 136CV (APÓS 01-2007) - FIAT SCUDO COMBINATO 1.</p> <p>64x53x45x50mm 1f-d24.5mm</p>		<p>T1123 NO. 1305782080</p> <p>BATENTE DA BARRA ESTABILIZADORA DA FRENTE</p> <p>FIAT SCUDO FURGONATO 1.6 220 A 2.000 79CV (APÓS 02-1996) - 1.9 D D9B 69CV (APÓS 02-1996) - 1.9 D WJZ (DW8) 69CV (APÓS 04-1998) - 1.9 TD D8B 92CV (APÓS 02-1998) - 1.9 TD DHX (XUD9TF/L) 90CV (APÓS 02-1996) - 2.0 RFN 136CV (APÓS 05-2000) - 2.0 JTD RHX 94CV (</p> <p>64x53x45x50mm 1f-d24.5mm</p>
	<p>W5013 NO. 73501275 - 46447843 - 55185409 - 55190424 - 55185403</p> <p>POLIE DA CAMBOTA (6 pistas)</p> <p>FIAT DOBLO</p> <p>d164.5mm d30.5mm</p>		<p>W5085 NO. 9643354180</p> <p>POLIE DA CAMBOTA (6 PISTAS)</p> <p>FIAT SCUDO (MOD 2007) 2.0 JTD (120-140CV) (APÓS 01-2007)</p> <p>d153/158mm d16mm</p>
	<p>W5093 NO. 55208280 - 55196974 - 93191381 - 614571 - 2005302 - 2005758 - 20000281 - 93191382 - 1261019J50 - 551...</p> <p>POLIE DA CAMBOTA (6 PISTAS)</p> <p>FIAT DOBLO 1.9 D (APÓS 03-2001) - 1.9 D MULTIJET (APÓS 06-2005) - 1.9 JTD (APÓS 10-2001)</p> <p>d165mm d30.5mm</p>		<p>W5101 NO. 9681761480</p> <p>POLIE DA CAMBOTA</p> <p>FIAT SCUDO 1.9 JTD - 2.0 JTD</p> <p>d152.8mm d30mm</p>
	<p>W5104 NO. 55182506</p> <p>POLIE DA CAMBOTA (6+4 PISTAS)</p> <p>FIAT DOBLO 1.3 D MULTIJET (APÓS 10-2005)</p> <p>d165/144.6mm d35mm</p>		<p>W5104 NO. 55182506</p> <p>POLIE DA CAMBOTA (6+4 PISTAS)</p> <p>FIAT DOBLO CARGO 1.3 D MULTIJET (APÓS 10-2005)</p> <p>d165/144.6mm d35mm</p>
	<p>W5104 NO. 55182506</p> <p>POLIE DA CAMBOTA (6+4 PISTAS)</p> <p>FIAT DOBLO CARGO 1.3 JTD 16V (APÓS 05-2004)</p> <p>d165/144.6mm d35mm</p>		<p>W5105 NO. 7778028 - 46516096 - 71711983 - 71723808</p> <p>POLIE DA CAMBOTA (4+3 PISTAS)</p> <p>FIAT DOBLO 1.2 (APÓS 03-2001) - DOBLO CARGO 1.2 (APÓS 03-2001)</p> <p>d150/129mm d23mm</p>
	<p>W5134 NO. 46747308 - 46770939 - 46809889 - 55190581 - 46747308 - 46747308 - 46809886 - 46777308</p> <p>POLIE DA CAMBOTA (6 PISTAS)</p> <p>FIAT DOBLO Veículo multiuso (119_ - 223_) 1.9D (223AXB1A) (APÓS 03-2001) 63CV 1910CC - FIAT DOBLO Cargo (223_) 1.9D (223XB1A) Caixa/Combi (03-2001) 63CV 1910CC - FIAT PALIO Weekend (178_) 1.9D (178DYD1A07) Combi (APÓS 03-2001) 63CV 1910CC - FIAT PUNTO (188</p> <p>d168,7mm 1f-d30,3mm</p>		<p>Z80476 NO. 14188282 - 46306526 - 60507749</p> <p>Mola de painel</p> <p>FIAT DOBLO</p> <p>d18x20.5mm 1p-d8-14mm</p>

	Z80502	NO. 5757553		Z80533	NO. 7543023 - 7703081019 - 9759904480
	<i>Mola de retenção</i> FIAT DOBLO			<i>Mola de retenção</i> FIAT SCUDO	
	d16x9.5mm 1p-7x7-8.5mm 1f-d4.8mm			10x17x10mm 1p-7.2x14-9mm 1f-d4.2mm	
	Z80578	NO. 14569580 - 14569680		Z80586	NO. 82448727
	<i>Mola de fixação</i> FIAT DOBLO			<i>Mola de fixação</i> FIAT DOBLO	
	20x8x15mm 1f-8mm			d12.8x22.5mm 1p-d6.5-8.5mm	
	Z80604	NO. 7739801 - 500382985		Z80607	NO. 500358569 - 9621837480
	<i>Mola de painel</i> FIAT DOBLO			<i>Mola de fixação</i> FIAT SCUDO	
	d18.2x21.6mm 1p-d6.4-16.1mm			d16x21mm 1p-d5.5-10mm	
	Z80619	NO. 7677865		Z80653	NO. 14211580
	<i>Mola de painel</i> FIAT DOBLO			<i>Mola de fixação</i> FIAT DOBLO	
	d14x12mm 1p-d7.5-10mm			9x9x10mm 1p-7x7-9mm 1f-d4.2mm	
	Z80654	NO. 7556533		Z80668	NO. 735266957
	<i>Mola de fixação</i> FIAT DOBLO			<i>Mola de painel</i> FIAT DOBLO	
	d12.8x28mm 1p-d6.2-11.5mm			d20x15.5mm 1p-d8.2-13mm	
	Z80686	NO. 7770156		Z80690	NO. 699783 - 9621385880
	<i>Mola de friso</i> FIAT DOBLO			<i>Mola de fixação</i> FIAT SCUDO	
	NULL NULL			d22x28mm 1p-d6.5-14mm	
	Z80702	NO. 46408953 - 46748771		Z80816	NO. 46789809
	<i>Mola de fixação</i> FIAT DOBLO			NULL FIAT DOBLO	
	d16x25.5mm 1p-8x8-24mm 1f-d4.8mm			15.5x13.5x22mm 1p-d8.5-7mm	

	<p>A1012 NO. 4456819</p> <p>APOIO TRASEIRO DO MOTOR (CAIXA DE VELOCIDADES)</p> <p>FIAT DUCATO FURGÃO (ANTIGA) - IVECO</p> <p>150x96x73mm 1f-d12mm</p>		<p>A1126 NO. 7663999</p> <p>APOIO DA CAIXA</p> <p>FIAT DUCATO MODERNA</p> <p>180x115x72mm 1f-d14mm</p>
	<p>A1184 NO. 5934176 - 1843.80</p> <p>SUPORTE TRASEIRO DO MOTOR</p> <p>FIAT DUCATO 1.9D - 1.9TD - 2.0 (1988 A 1994) - TALENTO 1.9D - 1.9TD - 2.0 (1989 A 1994)</p> <p>148x89x57mm 1f-d28mm</p>		<p>A1476 NO. 1307242080 - 1323166080 - 5031.25 - 5031.55 - 5031.71 - 5038.19 - 5038.29 - 5038.42 - 5038.74</p> <p>APOIO SUPERIOR DO AMORTECEDOR SUSPENSÃO DA FRENTE (DIREITO)</p> <p>FIAT DUCATO TT</p> <p>160x160x80mm 1f-d15mm</p>
	<p>A1477 NO. 1307241080 - 1302443080 - 1307628080 - 1318573080 - 1320987080 - 1323165080 - 5038.18 - 5035.30 - 50...</p> <p>APOIO SUPERIOR DO AMORTECEDOR SUSPENSÃO DA FRENTE (ESQUERDO)</p> <p>FIAT DUCATO TT</p> <p>160x160x80mm 1f-d15mm</p>		<p>A1499 NO. 1308696080</p> <p>APOIO MOTOR TRÁS ESQUERDO (CAIXA)</p> <p>FIAT DUCATO TTD R-94</p> <p>160x65x65mm 1f-d15mm 2r-d15mm</p>
	<p>A1500 NO. 1310575080</p> <p>APOIO MOTOR TRÁS DIREITO</p> <p>FIAT DUCATO TTD R-94</p> <p>93x70x55mm 1f-d14mm</p>		<p>A1524 NO. 7550024-7601889</p> <p>APOIO MOTOR DA FRENTE</p> <p>FIAT DUCATO D - NOVO DUCATO TT (APÓS 6-87) (APÓS 0198096)</p> <p>148x80x80mm 1p-d12/26mm</p>
	<p>A1552 NO. 7599694</p> <p>APOIO DO MOTOR LADO DA CAIXA</p> <p>FIAT NOVO DUCATO R-90 2.5D - TD</p> <p>150x103x60mm NULL</p>		<p>A1588 NO. 9618154180</p> <p>APOIO DO MOTOR PARTE DE TRÁS</p> <p>FIAT ULYSSE 1.9 TD - 2.0 IE TURBO - 2.1 TD</p> <p>140x98x92mm NULL</p>
	<p>A1648 NO. 1307905080</p> <p>APOIO DO MOTOR PARTE DE TRÁS</p> <p>FIAT DUCATO R-94 1.9D - 1.9D W3 - 1.9 TD - 1.9 TD W3 - 2.0 iE - 2.5D - 2.8 ASP - 2.8 TD</p> <p>150x70x65mm 1p-d12-30mm</p>		<p>A1649 NO. 1307908080</p> <p>APOIO DO MOTOR PARTE DE TRÁS</p> <p>FIAT DUCATO R-94 1.9D - 1.9D W3 - 1.9 TD - 1.9 TD W3 - 2.0 iE - 2.5D - 2.5 TD - 2.8 ASP - 2.8 TD</p> <p>150x75x70mm 1p-d12-32mm</p>
	<p>A1650 NO. 1307906080 - 1307907080</p> <p>APOIO DO MOTOR PARTE DA FRENTE</p> <p>FIAT DUCATO R-94 1.9D - 1.9D W3 - 1.9 TD - 1.9 TD W3 - 2.0 iE - 2.5D - 2.5 TD - 2.8 ASP - 2.8 TD</p> <p>155x80x65mm 1p-d12-32mm</p>		<p>A1922 NO. 1714E3 - 9642742880 - 1755E4 - 17565YV010</p> <p>APOIO DO ESCAPE</p> <p>FIAT ULYSSE (179_) 3.0 Local de montagem: à frente (08.02 A 06.11) 204cv 2946cc Veículo multiuso</p> <p>53x39x45mm 2p-d6-18mm</p>
	<p>A1945 NO. 180691 - 1348993080</p> <p>APOIO CAIXA VELOCIDADES</p> <p>FIAT DUCATO Autocarro (250_, 290_) 140 Natural Power (A Partir de 04.09) 136cv 2999cc Autocarro - FIAT DUCATO Autocarro (250_, 290_) 100 Multijet 2,2 D (A Partir de 07.06) 100cv 2198cc Autocarro - FIAT DUCATO Autocarro (250_, 290_) 120 Multijet 2,3 D (A Partir de 07.06) 120cv 2287cc Autocarro - FIAT DUCATO Autocarro (250_, 290_) 130 Multijet 2,3 D (A Partir de 01.11) 131cv 2287cc Autocarro - FIAT DUCATO Caixa (250_, 290_) 140 Natural Pow...etc.</p> <p>150x105x50mm 1f-d16mm 3f-d14mm 3r-d12mm</p>		<p>A1956 NO. 1339629080 - 1345897080 - 935019160 - 9405031789</p> <p>APOIO AMORTECEDOR FRENTE LADO ESQUERDO</p> <p>FIAT DUCATO Autocarro (244_) 2.0 (A Partir de 04.02) 110cv 1998cc Autocarro - FIAT DUCATO Autocarro (244_) 2.0 Bipower (A Partir de 11.02) 110cv 1998cc Autocarro - FIAT DUCATO Autocarro (244_) 2.0 JTD (A Partir de 04.02) 84cv 1997cc Autocarro - FIAT DUCATO Autocarro (244_) 2.3 JTD (A Partir de 04.02) 110cv 2286cc Autocarro - FIAT DUCATO Autocarro (244_) 2.8 JTD (A Partir de 04.02) 128cv 2798cc Autocarro - FIAT DUCATO Autocarro (244_) 2....etc.</p> <p>160x170x80mm 1f-d14mm 3r-d10mm</p>

	<p>BE16 NO. 5433461 - 5483762</p> <p>ABRAÇADEIRA DE ESCAPE CÔNCAVA 66mm</p> <p>FIAT 242</p> <p>116x64x16mm 66mm</p>		<p>BE22 NO. 9624037280 - 9401713699</p> <p>ABRAÇADEIRA ESCAPE</p> <p>FIAT ULYSSE (APÓS 1994)</p> <p>96x100x18mm 1p-d10-75mm</p>
	<p>E0001 NO. 4126729 - 4373254</p> <p>ESTICADOR DE ESCAPE</p> <p>FIAT 238</p> <p>130x32x15mm NULL</p>		<p>E0003 NO. 4296059 - 4312280 - 4306054 - 4422065 - 4297082 - 421281 - 4296060</p> <p>ESTICADOR DE ESCAPE</p> <p>FIAT DUCATO (81 A 82) - 238 (APÓS 68) - 242</p> <p>80x35x37mm NULL</p>
	<p>E0089 NO. 1300716080</p> <p>ESTICADOR DA BARRA ESTABILIZADORA DA FRENTE</p> <p>FIAT DUCATO (MOD.2002) 2.0 Mpi - DUCATO (MOD.2002) 2.8 JTD - DUCATO (MOD.94) TT (DIESEL)</p> <p>155x42x35mm 1f-d14mm</p>		<p>E0089-C NO. 1300716080</p> <p>ESTICADOR DA BARRA ESTABILIZADORA DA FRENTE</p> <p>FIAT DUCATO (MOD. 2002) 2.0 MPI - 2.8 JTD - DUCATO (MOD. 1994) TT (DIESEL)</p> <p>155x35x43mm 1f-d14mm 1p-d12-23mm</p>
	<p>F0869-I NO. 5412899 - 5488095 - 95532944</p> <p>FOLE DO SEMI-EIXO LADO DO CARDAN</p> <p>FIAT 242</p> <p>d115x83mm 1f-d109mm 1f-d24mm</p>		<p>F0870-I NO. 95569341</p> <p>FOLE DO SEMI-EIXO LADO DO DIFERENCIAL</p> <p>FIAT DUCATO TT</p> <p>d104x98mm 1f-d96mm 1f-d24mm</p>
	<p>F0871-I NO. 95569342</p> <p>FOLE DO SEMI-EIXO LADO DA RODA</p> <p>FIAT DUCATO TT</p> <p>d100x145mm 1f-d92mm 1f-d24mm</p>		<p>F0897-I NO. 82483504</p> <p>FOLE JUNTO À RODA</p> <p>FIAT ULYSSE 1998 cm3 (APÓS 9-1994)</p> <p>d100x98mm 1f-d86mm 1f-d26mm</p>
	<p>F0902-I NO. 9750000380</p> <p>FOLE DA DIRECÇÃO LADO DIREITO</p> <p>FIAT DUCATO - NOVO DUCATO - DUCATO MAXI - TALENTO</p> <p>d64-220mm 1f-d37mm 1f-d11mm</p>		<p>F0924-I NO. 9750000280 - 975000280</p> <p>FOLE DA DIRECÇÃO LADO ESQUERDO</p> <p>FIAT DUCATO - NOVO DUCATO - DUCATO MAXI - TALENTO</p> <p>d65x155mm 1f-d49mm 1f-d10mm</p>
	<p>F1296-I NO. 9941077 - 9943623 - 4066.31 - 4066.35 - 4018.A5 - 4006.22 - 4018.15</p> <p>FOLE DA DIRECÇÃO ASSISTIDA LADO DIREITO E ESQUERDO</p> <p>FIAT DUCATO I 1.8 - 1.9D - 1.9TD - 2.0 - 2.4D - 2.5D - 2.5TD (82 A 90) DUCATO II 1.9TD - 2.0 - 2.5D - 2.5TD(89 A 94) TALENTO 1.9D - 2.0 (89 A 94)</p> <p>d70x260mm 1f-d55mm 1f-d13mm</p>		<p>F1356-I NO. 9564479480</p> <p>FOLE DO LADO DA CAIXA</p> <p>FIAT DUCATO 1400Kg (APÓS 9-94) - ULYSSE 1998 cc. TURBO (APÓS 9-94) - ULYSSE</p> <p>d85x90mm 1f-d76mm 1f-d28mm</p>
	<p>F1361-I NO. 9564478680</p> <p>FOLE DO LADO DA RODA</p> <p>FIAT NOVO DUCATO 1400kg (APÓS 9-1994)</p> <p>d127x150mm 1f-d110mm 1f-d32mm</p>		<p>F1633-I NO. 9567468588</p> <p>FOLE DA TRANSMISSÃO JUNTO À CAIXA</p> <p>FIAT ULYSSE I (APÓS 06-98) - 1.8 - 2.0</p> <p>d87x104mm 1f-d80mm 1f-d34mm</p>

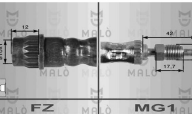
	<p>F1667-I NO. 9404066418</p> <p>FOLE DIREÇÃO ASSISTIDA LADO DIREITO E ESQUERDO FIAT ULYSSE 1.8i - 1.9 TD - 2.0i - 2.0i T - 2.0 JTD - 2.1 TD (1994 A 2002)</p> <p>d65x200mm 1f-d58mm 1f-d10mm</p>		<p>F1854-I NO. 9945837</p> <p>FOLE DA DIREÇÃO LADO DIREITO E ESQUERDO FIAT DUCATO IV 2.0 JTD - 2.0i - 2.3 JTD - 2.8 JTD - 2.8 JTD 4X4 (APÓS 2002)</p> <p>d80x280mm 1f-d55mm 1f-d15mm</p>
	<p>F4008 NO. 1307021080 - 5947829</p> <p>FOLE DO AMORTECEDOR FIAT DUCATO - DUCATO MAXI - TALENTO</p> <p>d113x185mm 1f-d104 1f-d38mm</p>		<p>F4037 NO. 9404066418</p> <p>FOLE DA DIREÇÃO LADO DIREITO E ESQUERDO FIAT ULYSSE 1.8i - 1.9 TD - 2.0i - 2.0iT - 2.0 JTD - 2.1 TD 94-02</p> <p>d72/54x240mm 1f-d68mm 1f-d10mm</p>
	<p>F4039 NO. 9945837</p> <p>FOLE DA DIREÇÃO LADO DIREITO FIAT DUCATO IV (APÓS 2002) 2.0i - 2.0 JTD - 2.3 JTD - 2.8 JTD</p> <p>d65/54x180mm 1f-d67mm 1f-d15mm</p>		<p>KF1407-T NO. 9464383680 - 9464383688 - 9567512880</p> <p>KIT DE FOLE DO CARDAN JUNTO À RODA FIAT DUCATO III 2.0i - 2.3 JTD - 2.5D - 2.5 TD iD - 2.8D - 2.8 JTD - 2.8 JTD4X4 - 2.8 TD iD (1994 A 2002) - DUCATO IV 2.0i - 2.3 JTD - 2.8 JTD (APÓS 2002)</p> <p>d130x170mm 1f-d112mm 1f-d33mm</p>
	<p>KF1473-T NO. 9564478680</p> <p>KIT DE FOLE DO CARDAN JUNTO À RODA FIAT DUCATO III 1.9D - 1.9 TD - 2.0i - 2.5D - 2.5 TD iD. - 2.8D - 2.8 TD iD (1994 A 2002)</p> <p>d110x150mm 1f-d98mm 1f-d29mm</p>		<p>KF2539-T NO. 9464383788</p> <p>KIT DE FOLE DO CARDAN JUNTO À RODA FIAT DUCATO IV 2.0 JTD - 2.0i - 2.3 JTD - 2.8 JTD - 2.8 JTD 4X4 (APÓS 2002)</p> <p>d110x150mm 1f-d98mm 1f-d30mm</p>
	<p>KF8020-T NO. 9564478680</p> <p>KIT DE FOLE DO CARDAN JUNTO À RODA FIAT DUCATO III 1.9D - 1.9 TD - 2.0i - 2.5D - 2.5 TD iD. - 2.8D - 2.8 TD iD (1994 A 2002)</p> <p>d110x150mm 1f-d98mm 1f-d29mm</p>		<p>KT0504 NO. 503341 - 1313045080 - 503341</p> <p>KIT DE BATENTE SUSPENSÃO DA FRENTE FIAT DUCATO Autocarro (230_) 2.0 Panorama/Combinato (03.94 A 04.02) 109cv 1998cc Autocarro - FIAT DUCATO Autocarro (230_) 2.0 4x4 (11.94 A 11.01) 109cv 1998cc Autocarro - FIAT DUCATO Autocarro (230_) 1.9 D (04.98 A 04.02) 68cv 1905cc Autocarro - FIAT DUCATO Autocarro (230_) 1.9 TD (04.98 A 04.02) 90cv 1905cc Autocarro - FIAT DUCATO Autocarro (230_) 1.9 D Combinato (06.95 A 04.02) 69cv 1929cc Autocarro - FIAT DUCATO Autocarro (230_) 1.9 TD Co...etc.</p> <p>d86x211mm 1f-d22mm 1f-d81mm</p>
	<p>KT0507 NO. 503392 - 1340928080</p> <p>KIT DE BATENTE SUSPENSÃO DA FRENTE FIAT DUCATO Autocarro (244_) 2.0 (APÓS 04.02) 110cv 1998cc Autocarro - FIAT DUCATO Caixa (244_) 2.0 (APÓS 04.02) 110cv 1998cc Caixa</p> <p>d83x191mm 1f-d26mm 1f-d81mm</p>		<p>L3062 NO. 1300507080 - 1320348080</p> <p>CASQUILHO CENTRAL DO BRAÇO OSCILANTE DA SUSPENSÃO FRENTE FIAT DUCATO TT (DIESEL)</p> <p>d58x55mm d44mm 1f-d26mm</p>
	<p>L3063 NO.</p> <p>CASQUILHO CENTRAL DO BRAÇO OSCILANTE DA SUSPENSÃO FRENTE FIAT DUCATO TT (DIESEL) (ATÉ 1994)</p> <p>d49x41mm d35mm 1f-d18mm</p>		<p>M6012 NO. 9603895480</p> <p>JUNTA DE ESCAPE FIAT DUCATO (APÓS 1994) - ULYSSE (APÓS 1994)</p> <p>d79x14mm 1f-d66mm</p>
	<p>P0009-R NO. 4144275</p> <p>CAPA DE PEDAL TRAVÃO E EMBRAIAGEM FIAT DUCATO - TALENTO</p> <p>63x50x12mm NULL</p>		<p>P1052 NO. 4144275</p> <p>CAPA DE PEDAL DO TRAVÃO E EMBRAIAGEM FIAT DUCATO - N. DUCATO - TALENTO</p> <p>67x53x12mm NULL</p>

	<p>P1071 NO. 71747697</p> <p>CAPA DE PEDAL DO TRAVÃO</p> <p>FIAT DUCATO CAMIAO PLATAFORMA (250) 100 MULTIJET 2.2D (APÓS 07-2006) 100CV 2198CC - FIAT DUCATO CAMIAO PLATAFORMA (250) 120 MULTIJET 2.3 D (APÓS 07-2006) 120CV 2287CC</p> <p>67x55x10mm NULL</p>		<p>P1078 NO. 9640228180</p> <p>CAPA DE PEDAL DO TRAVÃO</p> <p>FIAT ULYSSE (179AX) 2.0 (08-2002 A 06-2011) 136CV 1997CC - FIAT ULYSSE (179AX) 3.0 (08-2002 A 06-2011) 204CV 2946CC - FIAT ULYSSE (179AX) 2.0 JTD (05-2003 A 08-2006) 107CV 1997CC - FIAT ULYSSE (179AX) 2.0 JTD (05-2003 A 08-2006) 107CV 1997CC - FIAT ULYSSE</p> <p>76x55x13mm NULL</p>
	<p>P1094 NO. 71747698</p> <p>CAPA DE PEDAL DA EMBRAIAGEM</p> <p>FIAT - DUCATO Camião de plataforma/chassis (250 - 290) - 100 Multijet 2 - 2 D (APÓS 07.06) 100cv 2198cc - FIAT - DUCATO Camião de plataforma/chassis (250 - 290) - 120 Multijet 2 - 3 D (APÓS 07.06) 120cv 2287cc</p> <p>69x53x10mm NULL</p>		<p>R021123 NO. 5933431</p> <p>TUBO SUPERIOR DO RADIADOR</p> <p>FIAT NOVO DUCATO R-90 1.9D</p> <p>B510-d38/38mm 80-400-70mm</p>
	<p>R021134 NO. 9555522980</p> <p>TUBO SUPERIOR DO RADIADOR</p> <p>FIAT DUCATO D (MOTOR CITROËN)</p> <p>B420-d30/38mm 110-240-110-70mm</p>		<p>R221593 NO. 95572893</p> <p>TUBO DE RADIADOR INFERIOR</p> <p>FIAT DUCATO - NOVO DUCATO 2.5D MOTOR CRD</p> <p>B370-d45/33mm 120-190-110-90mm</p>
	<p>R8134 NO. 1192E3</p> <p>TUBO VALVULA REGULADORA DE VELOCIDADE</p> <p>FIAT DUCATO Autocarro (230_) 1.9 TD (04.98 A 04.02) 90cv 1905cc Autocarro - FIAT DUCATO Autocarro (230_) 1.9 TD Combinato (08.94 A 04.02) 80cv 1929cc Autocarro - FIAT DUCATO Autocarro (230_) 1.9 TD Panorama/Combinato (03.94 A 04.02) 82cv 1929cc Autocarro - FIAT DUCATO Caixa (230_) 1.9 TD (04.98 A 04.02) 90cv 1905cc Caixa - FIAT DUCATO Caixa (230_) 1.9 TD (03.94 A 04.02) 82cv 1929cc Caixa - FIAT DUCATO Camião de plataforma/chassis (230_ ...etc.</p> <p>B115-d18/16mm 40-40-40mm</p>		<p>RT08417 NO. 1306893080 - 480673</p> <p>TUBO DE TRAVÃO TRÁS RH</p> <p>FIAT DUCATO (MOD.94) TT(+ABS) (APÓS 02-1994)</p> <p>240mm FB23 - FB23</p>
	<p>RT08425 NO. 481636 - 7569593 - 5967970 - 71736956 - 7649589</p> <p>TUBO DE TRAVÃO TRÁS LH</p> <p>FIAT DUCATO (MOD.94) TT(+ABS) (APÓS 02-1994)</p> <p>335mm FB23 - MC11</p>		<p>RT08425 NO. 481636 - 7569593 - 5967970 - 71736956 - 7649589</p> <p>TUBO DE TRAVÃO TRÁS LH-RH</p> <p>FIAT TALENTO TT (APÓS 09-1888)</p> <p>335mm FB23 - MC11</p>
	<p>RT08459 NO. 46786435 - 7586907</p> <p>TUBO DE TRAVÃO TRÁS LH-RH</p> <p>FIAT DUCATO AUTOBUS 2.0 JTD (10-2001 A 04-2002) - 2.0 PANORAMA/COMBINATO (03-1994 A 04-2002) - 2.8 D (02-1998 A 04-2002) - 2.8 JTD (11-2000 A 04-2002) - 2.8 JTD 4X4 (11-2000 A 04-2002) - 2.8 TDI (10-1997 A 04-2002) - 2.8 TDI 4X4 (07-1999 A 04-2002) - 2.0</p> <p>182mm FB23 - MC11</p>		<p>RT08459 NO. 46786435 - 7586907</p> <p>TUBO DE TRAVÃO TRÁS LH-RH</p> <p>FIAT DUCATO FURGONATO 2.0 (03-1994 A 04-2002) - 2.0 JTD (10-2001 A 04-2002) - 2.8 D (05-1998 A 04-2002) - 2.8 D 4X4 (08-1998 A 04-2002) - 2.8 JTD (11-2000 A 04-2002) - 2.8 JTD 4X4 (11-2000 A 04-2002) - 2.8 TDI (10-1997 A 04-2002) - 2.8 TDI 4X4 (06-1999 A</p> <p>182mm FB23 - MC11</p>
	<p>RT08459 NO. 46786435 - 7586907</p> <p>TUBO DE TRAVÃO TRÁS LH-RH</p> <p>FIAT DUCATO PIANALE PIATTO/TELAIO 2.0 (06-1998 A 04-2002) - 2.8 D (02-1998 A 04-2002) - 2.8 JTD (11-2000 A 04-2002) - 2.8 TDI (12-1998 A 04-2002) - 2.0 JTD (APÓS 04-2002) - 2.3 JTD (APÓS 04-2002) - 2.8 JTD (APÓS 04-2002) - 2.8 JTD 4X4 (APÓS 10-2002)</p> <p>182mm FB23 - MC11</p>		<p>RT08531 NO. 71736963 - 7662724</p> <p>TUBO DE TRAVÃO TRÁS LH-RH</p> <p>FIAT DUCATO (MOD.94) TT(-ABS) (APÓS 02-1994)</p> <p>350mm FB23 - MC11</p>
	<p>RT08569 NO. 147919080 - 480682</p> <p>TUBO DE TRAVÃO FRENTE LH-RH</p> <p>FIAT ULYSSE TT (1994 A 2002)</p> <p>515mm FZ - MG1</p>		<p>RT08570 NO. 1472155080 - 480668</p> <p>TUBO DE TRAVÃO TRÁS LH-RH</p> <p>FIAT ULYSSE TT (1994 A 2002)</p> <p>325mm FZ - MC11</p>

	<p>RT08571 NO. 1311401080 - 1311457080 - 71736976</p> <p>TUBO DE TRAVÃO FRENTE LH-RH</p> <p>FIAT DUCATO TT (APÓS 02-1994)</p>		<p>RT08573 NO. 1472157080 - 480667</p> <p>TUBO DE TRAVÃO TRÁS LH-RH</p> <p>FIAT NUOVO ULYSSE TT (APÓS 09-2002) - FIAT ULYSSE TT (1994 A 2002)</p>
	<p>RT80007 NO. 1484536080</p> <p>TUBO DE TRAVÃO FRENTE LH-RH</p> <p>FIAT ULISSE (MOD.2001) TT (APÓS 09-2002)</p>		<p>RT80177 NO. 46833121</p> <p>TUBO DE TRAVÃO CENTRAL</p> <p>FIAT DUCATO (MOD 2002) TT APÓS (11-2001)</p>
	<p>RT80243 NO. 51725095</p> <p>TUBO DE TRAVÃO FRENTE LH-RH</p> <p>FIAT DUCATO 100 MULTIJET 2.2 D (APÓS 07-2006) - 120 MULTIJET 2.3 D (APÓS 07-2006) - 160 MULTIJET POWER 3.0 D (APÓS 07-2006)</p>		<p>RT80284 NO. 51725096 - 1367814080</p> <p>TUBO DE TRAVÃO TRÁS LH-RH</p> <p>FIAT DUCATO TT (APÓS 07-2006)</p>
	<p>RT80285 NO. 51782767</p> <p>TUBO DE TRAVÃO TRÁS LH-RH</p> <p>FIAT DUCATO TT (APÓS 07-2006)</p>		<p>S1288 NO. 1308694080 - 3523.94 - 1320755080 - 1320756080 - 1320786080 - 1320787080 - 1331937080 - 1331938080 - ...</p> <p>SILENT-BLOC PARTE FRENTE DO BRAÇO OSCILANTE DA SUSPENSÃO DE TRÁS</p> <p>FIAT DUCATO TT R-90</p>
	<p>S1468 NO. 1313083080 - 1305551080</p> <p>SILENT BLOC ESQUERDO DO BRAÇO DA SUSPENSÃO DA FRENTE</p> <p>FIAT ULYSSE 1.8 - 1.9TD - 2.0 - 2.0 16V - 2.0 TURBO - 2.1TD (1994 A 2002)</p>		<p>S1469 NO. 1313084080 - 1305552080</p> <p>SILENT BLOC DIREITO DO BRAÇO DA SUSPENSÃO DA FRENTE</p> <p>FIAT ULYSSE 1.8 - 1.9TD - 2.0 - 2.0 16V - 2.0 TURBO - 2.1TD (1994 A 2002)</p>
	<p>S1470 NO. 1312317080</p> <p>SILENT BLOC CENTRAL DO BRAÇO DA SUSPENSÃO DA FRENTE</p> <p>FIAT ULYSSE 1.8 - 1.9TD - 2.0 - 2.0 16V - 2.0 TURBO - 2.1TD (1994 A 2002)</p>		<p>S1514 NO. 513172</p> <p>SILENT BLOC DAS MOLAS DE TRÁS</p> <p>FIAT - DUCATO Autocarro (230) - 2.0 Panorama/Combinato Eixo: Suspensão da roda reforçada - não para a variant e de equip.: SOSPENS. RINFORZATE (03.94 - 04.02) 109cv 1998cc - FIAT - DUCATO Autocarro (230) - 1.9 D Eixo: Suspensão da roda reforçada - não para</p>
	<p>T0611-I NO. 1311826080 - 1311858080 - 467515470</p> <p>BATENTE DA SUSPENSÃO EIXO TRASEIRO</p> <p>FIAT - DUCATO Autocarro (230) - 2.0 Panorama/Combinato (03.94 - 04.02) 109cv 1998cc - FIAT - DUCATO Autocarro (230) - 1.9 D (04.98 - 04.02) 68cv 1905cc - FIAT - DUCATO Autocarro (230) - 1.9 TD(04.98 - 04.02) 90cv 1905cc - FIAT - DUCATO Autocarro (230) - 1</p>		<p>T0662-I NO. 1613189980 - 5033.A7 - 5033.A9 - 5033.E6 - 50706737 - 93501847</p> <p>BATENTE SUSPENSÃO DE TRÁS</p> <p>FIAT DUCATO Autocarro (250_ - 290_) 100 Multijet 2 - 2 D (APÓS 07.06) 100cv 2198cc Autocarro - FIAT DUCATO Autocarro (250_ - 290_) 120 Multijet 2 - 3 D (APÓS 07.06) 120cv 2287cc Autocarro - FIAT DUCATO Autocarro (250_ - 290_) 160 Multijet 3 - 0 D (APÓS 07.06) 158cv 2999cc Autocarro - FIAT DUCATO Caixa (250_ - 290_) 100 Multijet 2 - 2 D (APÓS 07.06) 100cv 2198cc Caixa - FIAT DUCATO Caixa (250_ - 290_) 120 Multijet 2 - 3 D (APÓS 07.06) 12...etc.</p>
	<p>T0663-I NO. 1613190080 - 5033C2 - 50705234 - 50707856</p> <p>BATENTE SUSPENSÃO DA FRENTE</p> <p>FIAT DUCATO Autocarro (250_ - 290_) 100 Multijet 2 - 2 D (APÓS 07.06) 100cv 2198cc Autocarro - FIAT DUCATO Autocarro (250_ - 290_) 120 Multijet 2 - 3 D (APÓS 07.06) 120cv 2287cc Autocarro - FIAT DUCATO Autocarro (250_ - 290_) 160 Multijet 3 - 0 D (APÓS 07.06) 158cv 2999cc Autocarro - FIAT DUCATO Caixa (250_ - 290_) 100 Multijet 2 - 2 D (APÓS 07.06) 100cv 2198cc Caixa - FIAT DUCATO Caixa (250_ - 290_) 120 Multijet 2 - 3 D (APÓS 07.06) 12...etc.</p>		<p>T0664-I NO. 1613189980 - 5033A7 - 5033A9 - 5033E6 - 50706737 - 935001847</p> <p>BATENTE SUSPENSÃO DA FRENTE</p> <p>FIAT DUCATO Autocarro (250_ - 290_) 100 Multijet 2 - 2 D (APÓS 07.06) 100cv 2198cc Autocarro - FIAT DUCATO Autocarro (250_ - 290_) 120 Multijet 2 - 3 D (APÓS 07.06) 120cv 2287cc Autocarro - FIAT DUCATO Autocarro (250_ - 290_) 160 Multijet 3 - 0 D (APÓS 07.06) 158cv 2999cc Autocarro - FIAT DUCATO Caixa (250_ - 290_) 100 Multijet 2 - 2 D (APÓS 07.06) 100cv 2198cc Caixa - FIAT DUCATO Caixa (250_ - 290_) 120 Multijet 2 - 3 D (APÓS 07.06) 12...etc.</p>

	<p>T0665-I NO. 503339 - 1307021080</p> <p>BATENTE SUSPENSÃO DA FRENTE</p> <p>FIAT ULYSSE (220_) 1.8 (220.BB5) (05.97 A 08.02) 99cv 1761cc Veículo multiuso - FIAT ULYSSE (220_) 2.0 (220.AC5) (06.94 A 08.02) 121cv 1998cc - Veículo multiuso FIAT ULYSSE (220_) 2.0 16V (05.98 A 09.00) 132cv 1998cc Veículo multiuso - FIAT ULYSSE (220_) 2.0 16V (09.00 A 08.02) 136cv 1997cc Veículo multiuso - FIAT ULYSSE (220_) 2.0 Turbo (220.AD5) (06.94 A 08.02) 147cv 1998cc Veículo multiuso - FIAT ULYSSE (220_) 1.9 TD (220.AH5) (02.95 ...etc.</p> <p>d54x107mm 1f-d25mm 1f-d20mm</p>		<p>T0694-I NO. 50709890</p> <p>BATENTE SUSPENSÃO DE TRÁS</p> <p>FIAT DUCATO 2.0 JTD - 2.2 JTD - 2.3 JTD (APÓS 2006)</p> <p>d70x101mm 1f-d31mm 1f-d28mm</p>
	<p>T1123 NO. 1305782080</p> <p>BATENTE DA BARRA ESTABILIZADORA DA FRENTE</p> <p>FIAT ULYSSE 1.8 (220.BB5) LFW 99CV (05-1997 A 08-2002) - 1.9 TD (220AH5) DHX (XUD9TF/L) 90CV (02-1995 A 08-2002) - 2.0 (220.AC5) RFU (XU10J2C) 121CV (06-1994 A 08-2002) - 2.0 16V RFN 136CV (09-2000 A 08-2002) - 2.0 16V RFV 132CV (05-1998 A 09-2000) - 2.0</p> <p>64x53x45x50mm 1f-d24.5mm</p>		<p>W5010 NO. 46413115 - 9608938980 - 9666471189 - 9634848980 - 9464471289</p> <p>POLIE DA CAMBOTA (6 pistas)</p> <p>FIAT DUCATO mod. 94 (1.9 D mot. DW8 - s-clima)</p> <p>d152.8mm d30mm</p>
	<p>W5085 NO. 9643354180</p> <p>POLIE DA CAMBOTA (6 PISTAS)</p> <p>FIAT NUOVO ULYSSE 2.0 JTD 16V (136CV) (APÓS 2001)</p> <p>d153/158mm d16mm</p>		<p>W5094 NO. 500332292 - 500312310 - 0515.N2 - 0515.N4 - 0515.N5 - 0515.N8 - 0515.N9 - 0515.P3 - 0515.P9 - 440310...</p> <p>POLIE DA CAMBOTA</p> <p>FIAT DUCATO 2.8 HDI 128CV-AC - 2.8 JTD(230L)(11-2000 A 04-2002)</p> <p>d146mm d21mm</p>
	<p>W5101 NO. 9681761480</p> <p>POLIE DA CAMBOTA</p> <p>FIAT DUCATO 2.0 JTD</p> <p>d152.8mm d30mm</p>		<p>W5101 NO. 9681761480</p> <p>POLIE DA CAMBOTA</p> <p>FIAT ULISSE - BERLINGO 2.0 JTD - 2.2 JTD</p> <p>d152.8mm d30mm</p>
	<p>W5149 NO. 504076697 - 504012367</p> <p>POLIE DA CAMBOTA</p> <p>FIAT DUCATO Autocarro (244_) 2.3 JTD (APÓS 04.02) 110cv 2286cc Autocarro - FIAT DUCATO Caixa (244_) 2.3 JTD (APÓS 04.02) 110cv 2286cc Caixa - FIAT DUCATO Camião de plataforma/chassis (244_) 2.3 JTD (04.02 A 07.06) 110cv 2286cc Camião de plataforma/chassis - FIAT DUCATO Autocarro (250_ - 290_) 120 Multijet 2 - 3 D (APÓS 07.06) 120cv 2287cc Autocarro - FIAT DUCATO Autocarro (250_ - 290_) 130 Multijet 2 - 3 D (APÓS 01.07) 131cv 2287cc Aut...etc.</p> <p>d143,6/165mm d31,7mm</p>		<p>W5151 NO. 504017415 - 504078435</p> <p>POLIE DA CAMBOTA (7 PISTAS)</p> <p>FIAT DUCATO Autocarro (244_) 2.3 JTD (A Partir de 04.02) 110cv 2286cc Autocarro - FIAT DUCATO Caixa (244_) 2.3 JTD (A Partir de 04.02) 110cv 2286cc Caixa - FIAT DUCATO Camião de plataforma/chassis (244_) 2.3 JTD (04.02 A 07.06) 110cv 2286cc Camião de plataforma/chassis - FIAT DUCATO Autocarro (250_ - 290_) 110 Multijet 2,3 D (A Partir de 10.11) 113cv 2287cc Autocarro - FIAT DUCATO Autocarro (250_ - 290_) 120 Multijet 2,3 D (A Partir de 0...etc.</p> <p>d138mm d32mm</p>
	<p>Z80243 NO. 14187880</p> <p>Mola de painel</p> <p>FIAT DUCATO</p> <p>d17x17.5mm 1p-d8-11.5mm</p>		<p>Z80504 NO. 7600779</p> <p>Mola de fixação</p> <p>FIAT DUCATO</p> <p>d16x25mm 1p-d8-13mm</p>
	<p>Z80528 NO. 7603826 - 16400631250</p> <p>Mola de painel</p> <p>FIAT DUCATO</p> <p>d18x21.5mm 1p-d6-16mm</p>		<p>Z80529 NO. 7603826</p> <p>Mola de fixação</p> <p>Fiat Ducato</p> <p>d18.5x20mm 1p-d9-18mm 1f-d6mm</p>
	<p>Z80532 NO. 5998258</p> <p>Mola de friso</p> <p>FIAT DUCATO</p> <p>20x7x5mm NULL</p>		<p>Z80533 NO. 7543023 - 7703081019 - 9759904480</p> <p>Mola de retenção</p> <p>FIAT ULYSSE</p> <p>10x17x10mm 1p-7.2x14-9mm 1f-d4.2mm</p>







	Z80607 NO. 500358569 - 9621837480		Z80611 NO. 1301019808
	Mola de fixação FIAT ULYSSE (Após 2002)		Mola de fixação FIAT DUCATO (Após 1994)
	d16x21mm 1p-d5.5-10mm		d22x23.2mm 1p-d9.5-19.5mm
	Z80619 NO. 7677865		Z80620 NO. 833640
	Mola de painel FIAT DUCATO		Mola de painel FIAT DUCATO (Após 1994)
	d14x12mm 1p-d7.5-10mm		d18x18.4mm 1p-d9.5-11.8mm
	Z80646 NO. 7578051		Z80646 NO. 7578051
	Mola de fixação FIAT TALENTO		Mola de fixação FIAT DUCATO
	13x17.8x15mm 1p-9x14-14mm 1f-d5.5mm		13x17.8x15mm 1p-9x14-14mm 1f-d5.5mm
	Z80668 NO. 735266957		Z80690 NO. 699783 - 9621385880
	Mola de painel FIAT DUCATO (Após 1994)		Mola de fixação FIAT ULYSSE
	d20x15.5mm 1p-d8.2-13mm		d22x28mm 1p-d6.5-14mm
	Z80702 NO. 46408953 - 46748771		Z80793 NO. 14203480
	Mola de fixação FIAT DUCATO		Mola de retenção FIAT DUCATO (Após 1991)
	d16x25.5mm 1p-8x8-24mm 1f-d4.8mm		d16x5mm 1p-d10-7mm 1f-d4.5mm
	Z80805 NO. 71726806 - 71728806		Z80838 NO. 6991.Y8 - 7703077468 - 7703077469 - 820112162
	MOLA DE FIXAÇÃO FRISO LATERAL FIAT DUCATO (APÓS 2001)		Mola FIAT ULYSSE
	F-7.6 - T-20 - L-11 - H-17 - 18116		d17x18.5mm 1p-d7.5-10.5mm

FIAT GRANDE PUNTO

	E0161 NO. 55700753 - 350616		KF1713-T NO. 71745014
	ESTICADOR DA BARRA ESTABILIZADORA DA FRENTE FIAT GRANDE PUNTO TT (APÓS 10-2005)		KIT DE FOLE DO CARDAN JUNTO À RODA FIAT GRANDE PUNTO (APÓS 2005) 1.9 JTDM
	335x35x35mm 2p-d10-24mm		d92x115mm 1f-d80mm 1f-d27mm



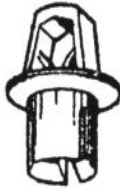



	<p>KT0505 NO. 51800004</p> <p><i>KIT DE BATENTE SUSPENSÃO DE TRÁS</i></p> <p>FIAT GRANDE PUNTO (199_) 1.2 (APÓS 10.05) 65cv 1242cc Hatchback - FIAT GRANDE PUNTO (199_) 1.2 (APÓS 09.10) 69cv 1242cc Hatchback - FIAT GRANDE PUNTO (199_) 1.4 (APÓS 06.06) 75cv 1368cc Hatchback - FIAT GRANDE PUNTO (199_) 1.4 (APÓS 10.05) 77cv 1368cc Hatchback - FIAT GRANDE PUNTO (199_) 1.4 LPG (APÓS 12.08) 78cv 1368cc Hatchback - FIAT GRANDE PUNTO (199_) 1.4 Natural Power (APÓS 07.08) 78cv 1368cc Hatchback - FIAT GRANDE PUNTO (199_)...etc.</p> <p>d63x268mm 1f-d13mm 1f-d60mm</p>		<p>KT0506 NO. 55701429</p> <p><i>KIT DE BATENTE SUSPENSÃO DA FRENTE</i></p> <p>FIAT GRANDE PUNTO (199_) 1.2 (APÓS 10.05) 65cv 1242cc Hatchback - FIAT GRANDE PUNTO (199_) 1.4 (APÓS 10.05) 77cv 1368cc Hatchback - FIAT GRANDE PUNTO (199_) 1.3 D Multijet (APÓS 10.05) 75cv 1248cc Hatchback - FIAT GRANDE PUNTO (199_) 1.3 D Multijet (APÓS 10.05) 90cv 1248cc Hatchback - FIAT GRANDE PUNTO (199_) 1.9 D Multijet (APÓS 10.05) 120cv 1910cc Hatchback - FIAT GRANDE PUNTO (199_) 1.9 D Multijet (APÓS 10.05) 130cv 1910cc Hatchback...etc.</p> <p>d62x285mm 1f-d13mm 1f-d60mm</p>
	<p>P1087 NO. 71746348</p> <p><i>CAPA DE PEDAL DA EMBRAIAGEM</i></p> <p>FIAT - GRANDE PUNTO (199) - 1.2 (APÓS 10.05) 65cv 1242cc Hatchback - FIAT - GRANDE PUNTO (199) - 1.4 (APÓS 10.05) 77cv 1368cc Hatchback - FIAT - GRANDE PUNTO (199) - 1.4 16V (APÓS 10.05) 95cv 1368cc Hatchback - FIAT - GRANDE PUNTO (199) - 1.4 T-Jet (APÓS 09.07) 120cv 1368cc - FIAT - G</p> <p>84x48x9mm 1 pino 14x10mm</p>		<p>P1093 NO. 71746347</p> <p><i>CAPA DE PEDAL DO TRAVÃO</i></p> <p>FIAT - GRANDE PUNTO (199) - 1.2 (APÓS 10.05) 65cv 1242cc - FIAT - GRANDE PUNTO (199) - 1.4 (APÓS 10.05) 77cv 1368cc - FIAT - GRANDE PUNTO (199) - 1.4 16V (APÓS 10.05) 95cv 1368cc - FIAT - GRANDE PUNTO (199) - 1.4 T-Jet (APÓS 09.07) 120cv 1368cc - FIAT - G</p> <p>86x50x41mm 1-Pino 15x10mm</p>
	<p>P1102 NO. 71747801</p> <p><i>CAPA DO PEDAL DO TRAVÃO</i></p> <p>ABARTH GRANDE PUNTO (199_) 1.4 (199.AXN1B) (12.07 A 06.10) 155cv 1368cc Hatchback</p> <p>110x90x40mm NULL</p>		<p>P1102 NO. 71747801</p> <p><i>CAPA DO PEDAL DO TRAVÃO</i></p> <p>FIAT GRANDE PUNTO (199_) 1.2 (APÓS 10.05) 65cv 1242cc Hatchback - FIAT GRANDE PUNTO (199_) 1.4 (APÓS 10.05) 77cv 1368cc Hatchback - FIAT GRANDE PUNTO (199_) 1.4 16V (APÓS 10.05) 95cv 1368cc Hatchback - FIAT GRANDE PUNTO (199_) 1.4 T-Jet (APÓS 09.07) 120cv 1368cc Hatchback - FIAT GRANDE PUNTO (199_) 1.3 D Multijet (APÓS 10.05) 75cv 1248cc Hatchback - FIAT GRANDE PUNTO (199_) 1.3 D Multijet (APÓS 10.05) 90cv 1248cc Hatchback - FIAT GRANDE PUNTO (199_)...etc.</p> <p>110x90x40mm NULL</p>
	<p>R017113 NO. 55185382</p> <p><i>TUBO DO INTERCOOLER</i></p> <p>FIAT GRANDE PUNTO (199_) 1.3 D Multijet (A Partir de 10.05) 75cv 1248cc Hatchback - FIAT GRANDE PUNTO (199_) 1.3 D Multijet (A Partir de 10.05) 90cv 1248cc Hatchback</p> <p>B155-d18/18mm 40-40-70-30mm</p>		<p>RT80186 NO.</p> <p><i>TUBO DE TRAVÃO TRÁS LH-RH</i></p> <p>FIAT GRANDE PUNTO 1.9D MULTIJET (120 - 130 CV) (APÓS 10-2005)</p> <p>162mm FB23 - MC11</p>
	<p>RT80188 NO. 55701047 - 562275 - 51835425 - 13352127 - 13363239 - 562239 - 562244 - 55700975 - 562274 - 4806J9 - ...</p> <p><i>TUBO DE TRAVÃO FRENTE LH-RH</i></p> <p>FIAT GRANDE PUNTO 1.2 (APÓS 10-2005) - 1.3 D MULTIJET (APÓS 10-2005) - 1.4 (APÓS 10-2005) - 1.4 16V (APÓS 10-2005) - 1.9 D MULTIJET (APÓS 10-2005)</p> <p>425mm FB23 - MC11</p>		<p>S1595 NO. 50511650 - 50521486 - 51783056 - 51783057</p> <p><i>SILENT-BLOC BRAÇO SUPERIOR FRENTE</i></p> <p>ABARTH GRANDE PUNTO (199_) 1.4 (199.AXN1B) (12.07 A 06.10) 155cv 1368cc Hatchback - ABARTH GRANDE PUNTO (199_) 1.4 (199.AXX1B) (12.07 A 12.12) 180cv 1368cc Hatchback - ABARTH PUNTO (199_) 1.4 (199.AXX1B) (A Partir de 04.10) 163cv 1368cc Hatchback - ABARTH PUNTO (199_) 1.4 (199.AXX1B) (A Partir de 05.08) 180cv 1368cc Hatchback</p> <p>d53x67mm d41mm 1f-d14mm</p>
	<p>S1595 NO. 50511650 - 50521486 - 51783056 - 51783057</p> <p><i>SILENT-BLOC BRAÇO SUPERIOR FRENTE</i></p> <p>FIAT GRANDE PUNTO (199_) 1.2 (A Partir de 10.05) 65cv 1242cc Hatchback - FIAT GRANDE PUNTO (199_) 1.4 (A Partir de 06.06) 75cv 1368cc Hatchback - FIAT GRANDE PUNTO (199_) 1.4 (A partir de 10.05) 77cv 1368cc Hatchback 2 / 3 - FIAT GRANDE PUNTO (199_) 1.4 LPG (A partir de 12.08) 78cv 1368cc Hatchback - FIAT GRANDE PUNTO (199_) 1.4 Natural Power (A partir de 07.08) 78cv 1368cc Hatchback - FIAT GRANDE PUNTO (199_) 1.4 16 V (A Partir de 10.05)...etc.</p> <p>d53x67mm d41mm 1f-d14mm</p>		<p>T0656-I NO. 51775545 - 51866009</p> <p><i>BATENTE SUSPENSÃO DA FRENTE</i></p> <p>FIAT GRANDE PUNTO (199_) 1.2 10.05 - 48 65 1242 Hatchback FIAT GRANDE PUNTO (199_) 1.4 10.05 - 57 77 1368 Hatchback FIAT GRANDE PUNTO (199_) 1.3 D Multijet 10.05 - 55 75 1248 Hatchback FIAT GRANDE PUNTO (199_) 1.3 D Multijet 10.05 - 66 90 1248 Hatchback FIAT GRANDE PUNTO (199_) 1.9 D Multijet 10.05 - 88 120 1910 Hatchback FIAT GRANDE PUNTO (199_) 1.9 D Multijet 10.05 - 96 130 1910 Hatchback</p> <p>d63x65mm 1f-d27mm 1f-d20mm</p>
	<p>T0666-I NO. 51799996</p> <p><i>BATENTE SUSPENSÃO DA FRENTE</i></p> <p>ABARTH GRANDE PUNTO (199_) 1.4 (12.07 A 06.10) 155cv 1368cc Hatchback - ABARTH PUNTO (199_) 1.4 (APÓS 04.10) 163cv 1368cc Hatchback - ABARTH PUNTO (199_) 1.4 (APÓS 05.08) 180cv 1368cc Hatchback</p> <p>d63x56mm 1f-d28mm 1f-d24mm</p>		<p>W5054 NO. 46819147 - 55200498</p> <p><i>POLIE DA CAMBOTA (6 PISTAS)</i></p> <p>FIAT GRANDE PUNTO 1.3D MULTIJET APÓS 09-2005 - Mtr 199A2000 - 199A3000 (75-90CV) - IDEA 1.3 JTD APÓS 2003 - Mtr 188A9000 (70-90CV) - PUNTO FL (MOD 2003) 1.3 JTDAPÓS 09-2003 - Mtr 188A9000 (70CV)</p> <p>d165mm d35mm</p>
	<p>Z80686 NO. 7770156</p> <p><i>Mola de friso</i></p> <p>FIAT GRANDE PUNTO</p> <p>NULL NULL</p>		<p>Z80831 NO. 14189071</p> <p><i>Mola porca rápida</i></p> <p>FIAT GRANDE PUNTO</p> <p>22.3x15x8.5mm 1f-d6mm</p>

	<p>A1948 NO. 4234725 - 5950748 - 4181556</p> <p>APOIO DA TRANSMISSÃO</p> <p>FIAT 131 (131_) 1.4 Super Mirafiori (04.81 A 12.83) 75cv 1367cc três volumes - FIAT 131 (131_) 1.3 Super Mirafiori (03.78 A 12.80) 78cv 1297cc três volumes - FIAT 131 (131_) 1.6 (S) (10.74 A 09.81) 75cv 1585cc três volumes - FIAT 131 (131_) 1.6 Super Mirafiori (A) (03.79 A 03.82) 98cv 1585cc três volumes - FIAT 131 (131_) 2.0 Racing (06.78 A 12.81) 115cv 1995cc três volumes - FIAT 131 (131_) 2.0 Abarth Rally (01.76 A 07.80) 140cv ...etc.</p> <p>110x100x28x40mm 1f-d25mm</p>	 <p>ESC: 1/2</p>	<p>C0229 NO. 100816 - 4276430</p> <p>BOTÃO DE AFINAÇÃO DO CAPOT (GRANDE)</p> <p>FIAT 131 (131_) 1.4 Super Mirafiori Mod. tipo: 1 tipo, Local de montagem: à frente 55kW 75CV 1367cc três volumes (DE 04-81 ATÉ 12-83)</p> <p>FIAT 131 (131_) 1.3 Super Mirafiori Mod. tipo: 1 tipo, Local de montagem: à frente 57kW 78CV 1297cc três volumes (DE 03-78 ATÉ 12-80)</p> <p>FIAT 131 (131_) 1.6 (S) Mod. tipo: 1 tipo, Local de montagem: à frente 55kW 75CV 1585cc três volumes (DE 10-74 ATÉ 09-81)</p> <p>FIAT 131 (131_) 1.6 Super Mirafiori (A) Mo...etc.</p>
	<p>E0003 NO. 4296059 - 4312280 - 4306054 - 4422065 - 4297082 - 421281 - 4296060</p> <p>ESTICADOR DE ESCAPE</p> <p>FIAT SUPERMIRAFIORE</p> <p>80x35x37mm NULL</p>		<p>E0041 NO. 4393777</p> <p>ESTICADOR DE ESCAPE</p> <p>FIAT 131 (78-87)</p> <p>76x64x15mm NULL</p>
	<p>E0108-I NO. 4112293</p> <p>ESTICADOR DE ESCAPE</p> <p>FIAT 131 - 131 DIESEL</p> <p>90x35x24mm 2f-d12mm</p>		<p>L1011 NO. 4240587 - 4207922</p> <p>CASQUILHO DO BRAÇO DA SUSPENSÃO (PONTAS DA BARRA ESTABILIZADORA)</p> <p>FIAT 131 TT</p> <p>d34x21mm 1f-d16mm</p>
	<p>P1019 NO. 4395061</p> <p>CAPA DE PEDAL DA EMBRAIAGEM</p> <p>FIAT SUPERMIRAFIORE</p> <p>100x50x8mm NULL</p>		<p>P1020 NO. 4395064</p> <p>CAPA DE PEDAL DO TRAVÃO</p> <p>FIAT SUPERMIRAFIORE</p> <p>100x48x8mm NULL</p>
	<p>P1089 NO. 4395058</p> <p>CAPA DE PEDAL DO ACELADOR</p> <p>FIAT - 131 - 1.3 Mirafiori (10.74 A 12.82) 65cv 1297cc três volumes - FIAT - 131 - 1.4 Super Mirafiori (04.81 A 12.83) 75cv 1367cc três volumes - FIAT - 131 - 1.3 Super Mirafiori (03.78 A 12.80) 78cv 1297cc três volumes - FIAT - 131 - 1.6 (S) (10.74 A 0</p> <p>130x47x7mm NULL</p>		<p>R021752 NO. 4338482 - 4338483</p> <p>TUBO INFERIOR DO RADIADOR</p> <p>FIAT 131 1.6 (11-1976 A 12-1984) - 1.6 (S) (10-1974 A 09-1981) - 1.6 SUPER (03-1978 A 01-1984) - 2.0 ABARTH RALLY (01-1976 A 07-1980) - 2.0 RACING (06-1978 A 12-1981) - 2.0 SUPER (01-1981 A 12-1984) - 2.5 DIESEL (06-1978 A 02-1984) - 2.0. D (07-1978 A 08-1</p> <p>B265-d35/35mm 120-100-100mm</p>
	<p>R021752 NO. 4338482 - 4338483</p> <p>TUBO INFERIOR DO RADIADOR</p> <p>FIAT MIRAFIORI 1.3 (10-1974 A 12-1982)-1.3 SUPER MIRAFIORI (03-1978 A 12-1980) - 1.4 MIRAFIORI (11-1980 A 01-1984) - 1.4 SUPER MIRAFIORI (04-1981 A 12-1983) - 1.6 SUPER MIRAFIORI (A) (03-1979 A 03-1982)</p> <p>B265-d35/35mm 120-100-100mm</p>		<p>R021753 NO. 4338484 - 4338482</p> <p>TUBO SUPERIOR DO RADIADOR</p> <p>FIAT 131 S - L - CL</p> <p>B200-d35/35mm 95-110-100mm</p>
	<p>Z80230 NO. 4343591</p> <p>Mola de friso</p> <p>FIAT 131</p> <p>NULL NULL</p>		<p>Z80231 NO. 4401310</p> <p>Mola de friso</p> <p>FIAT 131</p> <p>22x16x15.6mm 1p-d7-8.6mm</p>
	<p>Z80243 NO. 14187880</p> <p>Mola de painel</p> <p>FIAT 131</p> <p>d17x17.5mm 1p-d8-11.5mm</p>		<p>Z80245 NO. 4241451</p> <p>Mola de fixação</p> <p>FIAT 131</p> <p>d14x18mm 1p-7.5x6-9mm</p>

	Z80345	NO. 4303883		Z80346	NO. 4310258
	<i>Mola de painel</i> FIAT 131			<i>Mola de painel</i> FIAT 131	
d15x24mm		1p-d8-21.5mm	d12x15mm		1p-d7-13.5mm
	Z80352	NO. 14567187 - 17886087		Z80464	NO.
	<i>Mola de painel</i> FIAT 131			<i>Mola de painel</i> Fiat 131	
d15x19mm		1p-d8-16.5mm	d15x19.5mm		1p-d6-16.5mm
	Z80513	NO. 7544349		Z80653	NO. 14211580
	<i>Mola de fixação</i> FIAT 131			<i>Mola de fixação</i> FIAT 131	
NULL		NULL	9x9x10mm		1p-7x7-9mm 1f-d4.2mm

FIAT MULTIPLA

	F0835A5I	NO. 46307071 - 46307436 - 46307503 - 46307784 - 60813077		F1822-I	NO. 4315444 - 46307029
	<i>FOLE DA TRANSMISSÃO JUNTO À CAIXA</i> FIAT MULTIPLA (APÓS 04-1999) 1.6i 16V - 1.6i CNG BIPOWER 16V - BLUPOWER 16V			<i>FOLE DA TRANSMISSÃO JUNTO À CAIXA</i> FIAT MULTIPLA 1.9JTD (APÓS 99)	
d93x87mm		1f-d79mm 1f-d24.4mm	d102x94mm		1f-d99mm 1f-d25mm
	RT08417	NO. 7667806		RT08459	NO. 46786435 - 7586907
	<i>TUBO DE TRAVÃO TRÁS LH-RH</i> FIAT MULTIPLA TT (APÓS 12-1998)			<i>TUBO DE TRAVÃO TRÁS LH-RH</i> FIAT MULTIPLA 1.6 10016V (APÓS 04-1999) - 1.6 16V BIPOWER (APÓS 04-1999) - 1.9 JTD 105 (APÓS 04-1999) - 1.9 JTD 110 (03-2001 A 07-2002) - 1.9 JTD 115 (APÓS 07-2002)	
240mm		FB23 - FB23	182mm		FB23 - MC11
	W5013	NO. 73501275 - 46447843 - 55185409 - 55190424 - 55185403		W5093	NO. 55208280 - 55196974 - 93191381 - 614571 - 2005302 - 2005758 - 20000281 - 93191382 - 1261019J50 - 551...
	<i>POLIE DA CAMBOTA (6 pistas)</i> FIAT MULTIPLA 1.9 JTD MOTORES 105 - 110 - 120cv			<i>POLIE DA CAMBOTA (6 PISTAS)</i> FIAT MULTIPLA 1.9 JTD (APÓS 4-1999) - 1.9 JTD 110 (03-2001 A 07-2002) - 1.9 JTD 115 (APÓS 07-2002)	
d164.5mm		d30.5mm	d165mm		d30.5mm
	Z80502	NO. 5757553		Z80533	NO. 7543023 - 7703081019 - 9759904480
	<i>Mola de retenção</i> FIAT MULTIPLA			<i>Mola de retenção</i> FIAT MULTIPLA	
d16x9.5mm		1p-7x7-8.5mm 1f-d4.8mm	10x17x10mm		1p-7.2x14-9mm 1f-d4.2mm

	Z80605 NO. 7745194 <i>Mola de fixação</i> FIAT MULTIPLA		Z80615 NO. 46436251 <i>Mola de fixação</i> FIAT MULTIPLA
	d20x20.5mm 1p-d9-18.5mm 1f-7x7mm		d16x24mm NULL
	Z80641A NO. 1H0853586 <i>Mola de fixação</i> FIAT MULTIPLA		Z80653 NO. 14211580 <i>Mola de fixação</i> FIAT MULTIPLA
	d13x13mm 1p-d10-12mm 1f-d8.5mm		9x9x10mm 1p-7x7-9mm 1f-d4.2mm
	Z80686 NO. 7770156 <i>Mola de friso</i> FIAT MULTIPLA		Z80702 NO. 46408953 - 46748771 <i>Mola de fixação</i> FIAT MULTIPLA
	NULL NULL		d16x25.5mm 1p-8x8-24mm 1f-d4.8mm

FIAT OM

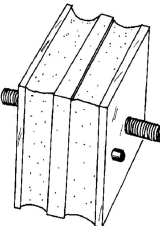
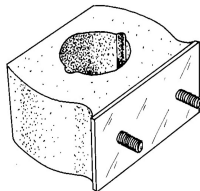
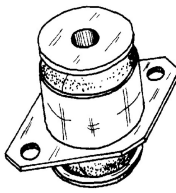
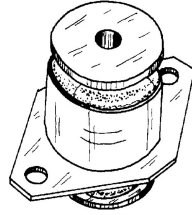













	A0880 NO. 8573593 <i>SUPORTE DO MOTOR</i> FIAT OM		A0881 NO. 4534879 <i>SUPORTE DA SUSPENSÃO</i> FIAT OM
	113x92x67mm 2p-d11-29mm		132x102x60mm 2p-d10-22mm
	A0904 NO. 9054727 <i>SUPORTE DA CABINA</i> FIAT OM		A0905 NO. 9054823 <i>SUPORTE DA CABINA</i> FIAT OM
	102x68x65mm 1f-d14mm		122x81x72mm 1f-d12mm

FIAT PALIO-STRADA-SIENA

	A1936 NO. 46803521 <i>APOIO DO MOTOR LADO DIREITO</i> FIAT STRADA Pick-up (178_) 1.9 JTD Local de montagem: à direita (A Partir de 04.03) 80cv 1910cc Pick-up		E1107 NO. 51708152 - 46548015 - 55208963 <i>ESTICADOR DO ESCAPE PARTE DE TRÁS</i> FIAT PALIO (178BX) - 1.0 Hatchback 61CV 994cc (APÓS 04-1996) - 1.0 Hatchback 77CV 994cc (APÓS 04-1996) - 1.2 Hatchback 73CV 1242cc (APÓS 06-1998) - 1.4 Hatchback 69CV 1372cc (APÓS 04-1996) - 1.4 CAT Hatchback 69cv 1372cc (APÓS 04-1996) - 1.5 Hatchback 77
	120x95x100mm 2f-12mm 2f-11mm 1r-d12mm		82x55x31mm 3f-d10mm

	F0060-I NO. 4239459 - 4371156 FOLE DA CREMALHEIRA DA DIREÇÃO DIREITO (F1038) FIAT STRADA d59x180mm d47mm 1f-d1f-d26mm 1f-d10mm		F0388-I NO. 4315444 FOLE DO DIFERENCIAL FIAT STRADA 105 TC-130TC d77x85mm 1f-d62mm 1f-d24mm
	F0389-I NO. 4433969 FOLE DO DIFERENCIAL LADO DA RODA FIAT STRADA 1.6 (APÓS 4-86) d90x82mm 1f-d76mm 1f-22mm		F0403-I NO. 4383758 FOLE DO SEMI-EIXO JUNTO À RODA FIAT STRADA (ATÉ 12-83) d80x80mm 1f-d70mm 1f-d20mm
	F0468-I NO. 92601216 FOLE ESQUERDO E DIREITO DO DIFERENCIAL COM CASQUILHO EM NYLON FIAT STRADA 60-75 (10-82 A 12-83) d95x70mm 1f-d63mm 1f-d23mm		F0468B-I NO. 92601255 FOLE DO DIFERENCIAL SEMI-EIXO ESQUERDO COM CASQUILHO EM NYLON FIAT STRADA (4-85 A 2-86) d95x73mm 1f-d71mm 1f-d23mm
	F0514-I NO. 5987092 FOLE DO SEMI-EIXO JUNTO À RODA FIAT STRADA (ATÉ 9-87) d86x82mm 1f-d71mm 1f-d20mm		F0787-I NO. 92601366 FOLE JUNTO À CAIXA FIAT STRADA (3-1986 A 9-1987) d94x76mm 1f-d80mm 1f-d22mm
	F0834-I NO. 7621245 FOLE DO DIFERENCIAL SEMI-EIXO DIREITO FIAT STRADA (APÓS 10-87) d91x82mm 1f-d65mm 1f-d32mm		F0834A-I NO. 7621245 FOLE DO DIFERENCIAL SEMI-EIXO DIREITO COM ROLAMENTO d23mm FIAT STRADA (APÓS 10-87) d93x90mm 1f-d23mm
	F0835-I NO. 7625541 FOLE ESQUERDO DO DIFERENCIAL LADO CAIXA FIAT STRADA (APÓS 10-87) d90x85mm 1f-d77mm 1f-d22.8mm		F0835A-I NO. 7625541 FOLE ESQUERDO DO DIFERENCIAL LADO CAIXA COM ROLAMENTO FIAT STRADA d90x85mm 1f-d77mm 1f-d22.8mm
	F0835A5I NO. 46307071 - 46307436 - 46307503 - 46307784 - 60813077 FOLE DA TRANSMISSÃO JUNTO À CAIXA FIAT PALIO 1.6i 16V (04-96 A 02-01) - 1.9D (APÓS 03-01) d93x87mm 1f-d79mm 1f-d24.4mm		RT08606 NO. 46448474 TUBO DE TRAVÃO FRENTE LH-RH FIAT PALIO 1.2 (APÓS 06-1998) - PALIO WEEKEND 1.6 16V (04-1996 A 02-2001) - 1.7 TD (04-1996 A 03-2001) - 1.9 D (APÓS 03-2001) 485mm FB23 - MC11
	RT08606 NO. 46448474 TUBO DE TRAVÃO FRENTE LH-RH FIAT SIENA 1.2 (APÓS 09-1998) - 1.4 (APÓS 04-1996) - 1.4 CAT (APÓS 04-1996) 485mm FB23 - MC11		S1325 NO. 46421522 SILENT-BLOC DO BRAÇO DA SUSPENSÃO DA FRENTE FIAT PALIO TT 1.2 - 1.6 16V 1.7 TD (VIATURAS COM E SEM DIREÇÃO ASSISTIDA) d45x55mm d30mm 1f-d12mm

	<p>S1326-D NO. 46454077 - 46748579</p> <p>SILENT-BLOC DIREITO DO BRAÇO DA SUSPENSÃO DA FRENTE FIAT PALIO TT 1.2 - 1.6 16 V - 1.7 TD (VIATURAS COM DIRECÇÃO ASSISTIDA)</p>		<p>S1326-E NO. 46454078 - 46748578</p> <p>SILENT-BLOC ESQUERDO DO BRAÇO SUSPENSÃO DA FRENTE FIAT PALIO TT 1.2 - 1.6 16 V - 1.7 TD (VIATURAS COM DIRECÇÃO ASSISTIDA)</p>
	160x175x55mm NULL		160x175x55mm NULL
	<p>S1327-D NO. 46450462</p> <p>SILENT-BLOC DIREITO DO BRAÇO DA SUSPENSÃO DA FRENTE FIAT PALIO TT 1.2 - 1.6 16 V - 1.7 TD (VIATURAS SEM DIRECÇÃO ASSISTIDA)</p>		<p>S1327-E NO. 46450461</p> <p>SILENT-BLOC ESQUERDO DO BRAÇO SUSPENSÃO DA FRENTE FIAT PALIO TT 1.2 - 1.6 16 V 1.7 TD (VIATURAS SEM DIRECÇÃO ASSISTIDA)</p>
	160x52x52mm NULL		160x52x52mm NULL
	<p>T0648-I NO. 46466617</p> <p>BATENTE SUSPENSÃO DA FRENTE</p> <p>FIAT PALIO (178BX) 1.2 (07.97 A 08.02) 60cv 1242cc Hatchback - FIAT PALIO (178BX) 1.2 (06.99 A 10.00) 68cv 1242cc Hatchback - FIAT PALIO (178BX) 1.2 (APÓS 06.98) 73cv 1242cc Hatchback - FIAT PALIO Weekend (178_) 1.2 (178DYA1A) (APÓS 02.01) 60cv 1242cc Combi - FIAT PALIO Weekend (178_) 1.2 (178DX.G1A) (04.96 A 02.01) 73cv 1242cc Combi - FIAT PALIO Weekend (178_) 1.2 (APÓS 09.01) 80cv 1242cc Combi</p>		<p>T0649-I NO. 46464298</p> <p>BATENTE SUSPENSÃO DA FRENTE</p> <p>FIAT PALIO (178BX) 1.0 (04.96 A 10.03) 61cv 994cc Hatchback - FIAT PALIO (178BX) 1.2 (APÓS 06.98) 73cv 1242cc Hatchback - FIAT PALIO (178BX) 1.4 (04.96 A 10.02) 69cv 1372cc Hatchback - FIAT PALIO (178BX) 1.4 Cat (04.96 A 08.01) 69cv 1372cc Hatchback - FIAT PALIO (178BX) 1.6 16V (04.96 A 10.02) 100cv 1581cc Hatchback - FIAT PALIO Weekend (178_) 1.2 (178DYA1A) (APÓS 02.01) 60cv 1242cc Combi - FIAT PALIO Weekend (178_) 1.2 (178DX.G1A) (04.9...etc.</p>
	d55x90mm 1f-d16mm 1f-d8mm		d57x93mm 1f-d21mm 1f-d20mm
	<p>T1095 NO. 7750990</p> <p>BATENTE DA BARRA ESTABILIZADORA DA FRENTE</p> <p>FIAT COMERCIAL STRADA APÓS 06-2001 1.2 (8V) - 1.7 TD - 1.9D - 1.9 JTD</p>		<p>U7025 NO. 71719148 - 7078610 - 7078602</p> <p>BASE DA ALAVANCA DE VELOVIDADES</p> <p>FIAT PALIO</p>
	87x31x34mm NULL		100x70x60mm 1f-d12mm 4f-d6mm
	<p>U7025 NO. 71719148 - 7078610 - 7078602</p> <p>BASE DA ALAVANCA DE VELOVIDADES</p> <p>FIAT SIENA</p>		<p>W5013 NO. 73501275 - 46447843 - 55185409 - 55190424 - 55185403</p> <p>POLIE DA CAMBOTA (6 PISTAS)</p> <p>FIAT PALIO 1.9 (APÓS 09-2000) - 1.9 D WEEKEND (APÓS 03-2001) - 1.9 JTD WEEKEND (APÓS 09-2001)+F33</p>
	100x70x60mm 1f-d12mm 4f-d6mm		d164.5mm d30.5mm
	<p>W5093 NO. 55208280 - 55196974 - 93191381 - 614571 - 2005302 - 2005758 - 20000281 - 93191382 - 1261019J50 - 551...</p> <p>POLIE DA CAMBOTA (6 PISTAS)</p> <p>FIAT PALIO WEEKEND 1.9D (APÓS 03-2001)</p>		<p>W5104 NO. 55182506</p> <p>POLIE DA CAMBOTA (6+4 PISTAS)</p> <p>FIAT STRADA 1.3 D MULTIJET (APÓS 05-2006)</p>
	d165mm d30.5mm		d165/144.6mm d35mm
	<p>W5105 NO. 7778028 - 46516096 - 71711983 - 71723808</p> <p>POLIE DA CAMBOTA (4+3 PISTAS)</p> <p>FIAT PALIO WEEKEND 1.2 (04-1996 A 02-2011)</p>		<p>W5105 NO. 7778028 - 46516096 - 71711983 - 71723808</p> <p>POLIE DA CAMBOTA (4+3 PISTAS)</p> <p>FIAT SIENA 1.2 MPI (04-1996 A 02-2001)</p>
	d150/129mm d23mm		d150/129mm d23mm
	<p>W5105 NO. 7778028 - 46516096 - 71711983 - 71723808</p> <p>POLIE DA CAMBOTA (4+3 PISTAS)</p> <p>FIAT STRADA 1.2 (APÓS 06-1999)</p>		<p>Z80352 NO. 14567187 - 17886087</p> <p>Mola de painel</p> <p>FIAT STRADA</p>
	d150/129mm d23mm		d15x19mm 1p-d8-16.5mm

	Z80352	NO. 14567187 - 17886087		Z80504	NO. 7600779
	<i>Mola de painel</i> FIAT PALIO			<i>Mola de fixação</i> FIAT PALIO	
	d15x19mm	1p-d8-16.5mm		d16x25mm	1p-d8-13mm
	Z80532	NO. 5998258		Z80532	NO. 5998258
	<i>Mola de friso</i> FIAT STRADA			<i>Mola de friso</i> FIAT PALIO	
	20x7x5mm	NULL		20x7x5mm	NULL
	Z80578	NO. 14569580 - 14569680		Z80588	NO. 7637466
	<i>Mola de fixação</i> FIAT PALIO			<i>Mola de painel</i> FIAT PALIO	
	20x8x15mm	1f-8mm		d24x16.5mm	1p-d16.5-14mm
	Z80590	NO. 14569187		Z80604	NO. 7739801 - 500382985
	<i>Mola de painel</i> FIAT PALIO			<i>Mola de painel</i> FIAT STRADA	
	d22x22.5mm	1p-d10.4-20mm		d18.2x21.6mm	1p-d6.4-16.1mm
	Z80604	NO. 7739801 - 500382985		Z80605	NO. 7745194
	<i>Mola de painel</i> FIAT PALIO			<i>Mola de fixação</i> FIAT STRADA	
	d18.2x21.6mm	1p-d6.4-16.1mm		d20x20.5mm	1p-d9-18.5mm 1f-7x7mm
	Z80605	NO. 7745194		Z80612	NO. 7569468
	<i>Mola de fixação</i> FIAT PALIO			<i>Mola de fixação</i> FIAT PALIO	
	d20x20.5mm	1p-d9-18.5mm 1f-7x7mm		d10x33.7mm	1p-d6-18.5mm
	Z80619	NO. 7677865		Z80637	NO. 7788400
	<i>Mola de painel</i> FIAT PALIO			<i>Mola de fixação</i> FIAT STRADA	
	d14x12mm	1p-d7.5-10mm		d30x31.7mm	1p-d19-29mm
	Z80637	NO. 7788400		Z80643	NO. 7771637
	<i>Mola de fixação</i> FIAT PALIO			<i>Mola de fixação</i> FIAT PALIO	
	d30x31.7mm	1p-d19-29mm		20x16x15.8mm	1p-d12.8-15mm

	Z80666 NO. 5962559		Z80668 NO. 735266957
	Mola de fixação FIAT STRADA d11x20mm 1p-d6.2-10mm		Mola de painel FIAT PALIO d20x15.5mm 1p-d8.2-13mm
	Z80669 NO. 7768047		Z80702 NO. 46408953 - 46748771
	Mola de painel FIAT STRADA d14x9.8mm 1p-d7.5-7.8mm		Mola de fixação FIAT STRADA d16x25.5mm 1p-8x8-24mm 1f-d4.8mm
	Z80702 NO. 46408953 - 46748771		Z80727 NO. 7798971
	Mola de fixação FIAT PALIO d16x25.5mm 1p-8x8-24mm 1f-d4.8mm		Mola de fixação FIAT PALIO d18x19mm 1p-d7.5-12mm



FIAT PANDA-YOUNG

	A0614-I NO. 52007036		A0926-I NO. 7543418 - 7613889
	SUPORTE DO MOTOR FRENTE E TRÁS FIAT PANDA 45 115x90x53mm 1f-12mm		SUPORTE TRÁS DO MOTOR FIAT PANDA YOUNG - 4x4 (APÓS 1986) (APOIO TRÁS) - FIAT PANDA 750 - 1000 - 4x4 (APÓS 1986) (APOIO FRENTE) 116x80x62mm 1f-d10mm
	A0927-I NO. 7544643 - 7544644		A0996 NO. 5974775
	SUPORTE TRÁS DO MOTOR FIAT PANDA 750-1000 135x80x60mm 1f-d9mm		SUPORTE DO MOTOR LADO DA CAIXA FIAT PANDA 150x80x48mm 1f-d8mm
	A1878 NO. 46407936 - 7541164 - 46407936 - 7541164 - 46407936 - 7541164		A1879 NO. 808682
	APOIO DA TRANSMISSÃO FIAT PANDA (141) 950 4x4 Hatchback (09-1983 A 12-1986) 48CV 965CC - FIAT PANDA (141) 1000 4x4 Hatchback (01-1986 A 07-1989) 44CV 999CC - FIAT PANDA (141) 1000 4x4 Hatchback (05-1986 A 12-1994) 45CV 999CC - FIAT PANDA (141) 1000 4x4 Hatchback (01-1986 A 1		APOIO DA TRANSMISSÃO FIAT PANDA (169) 1.2 4x4 Hatchback (APÓS 10-04) 60CV 1242CC - FIAT PANDA (169) 1.2 4x4 Hatchback (APÓS 11-09) 69CV 1242CC - FIAT PANDA (169) 1.3 D Multijet 4x4 Hatchback (APÓS 10-04) 70CV 1248CC - FIAT PANDA (169) 1.3 D Multijet 4x4 Hatchback (APÓS 09-1
	A1957 NO. 4400895 - 4400905 - 7635775		BE18 NO. 4092067 - 4143428 - 4263436
	APOIO AMORTECEDOR FRENTE DIREITO ESQUERDO FIAT PANDA (141_) 650 Posição/grau: 1 ° (01.82 A 07.04) 30cv 652cc Hatchback - FIAT PANDA (141_) 750 Posição/grau: 1 ° (01.86 A 10.03) 34cv 770cc Hatchback - FIAT PANDA (141_) 800 Posição/grau: 1 ° (02.81 A 12.85) 34cv 843cc Hatchback - FIAT PANDA (141_) 900 Posição/grau: 1 ° (04.92 A 12.96) 40cv 899cc Hatchback - FIAT PANDA (141_) 900 Posição/grau: 1 ° (10.80 A 06.94) 45cv 903cc Hatchback - FIAT PANDA (141_) 950 Posição...etc. 120x100x38mm 1f-d12mm 2p-d8x18mm		ABRAÇADEIRA DE ESCAPE CÔNCAVA FIAT PANDA (1979 A 1992) 99x62x26mm 2p-d8-60mm



 ESC: 1/2	C0229 NO. 100816 - 4276430 BOTÃO DE AFINAÇÃO DO CAPOT (GRANDE) FIAT PANDA (141_) 1000 4x4 33kW 45CV 999cc Hatchback (DE 05-86 ATÉ 12-94) FIAT PANDA (141_) 1100 4x4 40kW 54CV 1108cc Hatchback (DE 02-95 ATÉ 07-04) FIAT PANDA (141_) 1300 D 27kW 37CV 1302cc Hatchback (DE 04-86 ATÉ 12-92)		E0003 NO. 4296059 - 4312280 - 4306054 - 4422065 - 4297082 - 421281 - 4296060 ESTICADOR DE ESCAPE FIAT PANDA (APÓS 79)
	E0017 NO. 4387293 ESTICADOR DE ESCAPE FIAT PANDA 4x4 (APÓS 86)		E0041 NO. 4393777 ESTICADOR DE ESCAPE FIAT PANDA (APÓS 79)
	E1005 NO. 71719148 ESTICADOR DE ESCAPE FIAT PANDA		E1106 NO. 4629211 - 46546376 ESTICADOR DO ESCAPE PARTE DE TRÁS FIAT PANDA (169) - 1.3 D Multijet Hatchback 70CV 1248cc (APÓS 09-2003)
	F0057-I NO. 4294117 FOLE DO DIFERENCIAL LADO DA CAIXA (F1012) FIAT PANDA 45		F0403-I NO. 4383758 FOLE DO SEMI-EIXO JUNTO À RODA FIAT PANDA 30 - 45 (ATÉ 12-83)
	F0468-I NO. 92601216 FOLE ESQUERDO E DIREITO DO DIFERENCIAL COM CASQUILHO EM NYLON FIAT PANDA 45 (10-82 A 11-84)		F0468B-I NO. 92601255 FOLE DO DIFERENCIAL SEMI-EIXO ESQUERDO COM CASQUILHO EM NYLON FIAT PANDA 45 (APÓS 12-84) - PANDA 750 - 1000 - YONG DIESEL (ATÉ 2-86)
	F0479-I NO. 92601217 FOLE DA TRANSMISSÃO JUNTO À CAIXA (COM CASQUILHO DE NYLON LISO FURO 25mm) FIAT PANDA 45		F0514-I NO. 5987092 FOLE DO SEMI-EIXO JUNTO À RODA FIAT PANDA (1-84 A 9-87)
	F0710-I NO. 4409263 - SE141156212A FOLE DO AMORTECEDOR FIAT PANDA T.T.		F0787-I NO. 92601366 FOLE JUNTO À CAIXA FIAT PANDA 750 - 1000 - YOUNG DIESEL 3.86 (ATÉ 9-1987)
	F0834-I NO. 7621245 FOLE DO DIFERENCIAL SEMI-EIXO DIREITO FIAT PANDA 750 - 1000		F0834-I NO. 7621245 FOLE DO DIFERENCIAL SEMI-EIXO DIREITO FIAT PANDA YOUNG DIESEL (APÓS 10-87)

	<p>F0834A-I NO. 7621245</p> <p>FOLE DO DIFERENCIAL SEMI-EIXO DIREITO COM ROLAMENTO d23mm FIAT PANDA 750 - 1000</p> <p>d93x90mm 1f-d23mm</p>		<p>F0834A-I NO. 7621245</p> <p>FOLE DO DIFERENCIAL SEMI-EIXO DIREITO COM ROLAMENTO d23mm FIAT PANDA YOUNG DIESEL (APÓS 10-87)</p> <p>d93x90mm 1f-d23mm</p>
	<p>F0835-I NO. 7625541</p> <p>FOLE ESQUERDO DO DIFERENCIAL LADO CAIXA FIAT PANDA 750 - 1000 - YOUNG DIESEL (APÓS 10-87)</p> <p>d90x85mm 1f-d77mm 1f-d22.8mm</p>		<p>F0835A-I NO. 7625541</p> <p>FOLE ESQUERDO DO DIFERENCIAL LADO CAIXA COM ROLAMENTO FIAT PANDA - YOUNG DIESEL</p> <p>d90x85mm 1f-d77mm 1f-d22.8mm</p>
	<p>F0898F65 NO. 7682886</p> <p>FOLE JUNTO À RODA FIAT PANDA 30-750 (10-87 A 10-89) - 45 CL-S - L - CL - CLX - 4x4-50 AUTOMATIC 1100 IE - 4x4</p> <p>d91x80mm 1f-d65mm 1f-d19mm</p>		<p>F0898F76 NO. 7642776</p> <p>FOLE DO SEMI-EIXO JUNTO À RODA FIAT PANDA (APÓS 10-87)</p> <p>d89x83mm 1f-d76mm 1f-d21mm</p>
	<p>F1820-I NO. 328797</p> <p>FOLE DA TRANSMISSÃO JUNTO À CAIXA FIAT PANDA II 1.2i 8V 4X4 (APÓS 2003)</p> <p>d85x88mm 1f-d73mm 1f-d19mm</p>		<p>KF1408-T NO. 46308003</p> <p>KIT DE FOLE DO CARDAN JUNTO À RODA FIAT PANDA II (APÓS 2003) 1.1i 8V - 1.2i 8V</p> <p>d86x113mm 1f-d70mm 1f-d21mm</p>
	<p>KF1730 NO. 5966569 - 5987092</p> <p>KIT FOLE DO LADO DA RODA FIAT PANDA 0.65 - 0.8 - 0.9 (APÓS 1980)</p> <p>d82x80mm 1f-d20mm 1f-d68mm</p>		<p>KF1775 NO. 7642776</p> <p>KIT FOLE DO LADO DA RODA FIAT PANDA 1.0 - 1.0 ie - 1.1 (APÓS 1980)</p> <p>d90x79mm 1f-d21mm 1f-d76mm</p>
	<p>KL0877-I NO.</p> <p>KIT DE REPARAÇÃO DA ALAVANCA VELOCIDADES À CAIXA FIAT PANDA 45 (APÓS N°6130101)</p> <p>70x60x57mm NULL</p>		<p>L0419-I NO. 4330731</p> <p>CASQUILHO DE NYLON CREMALHEIRA DA DIRECÇÃO FIAT PANDA 30-45</p> <p>28x28x18mm 1f-d21mm</p>
	<p>L1011 NO. 4240587 - 4207922</p> <p>CASQUILHO DO BRAÇO DA SUSPENSÃO (PONTAS DA BARRA ESTABILIZADORA) FIAT PANDA</p> <p>d34x21mm 1f-d16mm</p>		<p>L3009 NO. 4179805 - 4330731</p> <p>CASQUILHO DA EXTREMIDADE DA CREMALHEIRA DA DIRECÇÃO FIAT PANDA 750 - 900 - 100 4x4 - 1100 4x4 - 1300 D</p> <p>32x32x18mm d28mm 1f-d22mm</p>
	<p>M6049 NO. 7669581</p> <p>JUNTA DE ESCAPE FIAT PANDA (APÓS 1986)</p> <p>113x60mm 2f-d35mm</p>		<p>M6094 NO. 7544692 - 7690882</p> <p>JUNTA DE ESCAPE FIAT PANDA (1986 A 1992)</p> <p>d60x13mm 1f-d45mm</p>

	<p>P0009-R NO. 4144275</p> <p>CAPA DE PEDAL TRAVÃO E EMBRAIAGEM</p> <p>FIAT PANDA TT</p> <p>63x50x12mm NULL</p>		<p>P1052 NO. 4144275</p> <p>CAPA DE PEDAL DO TRAVÃO E EMBRAIAGEM</p> <p>FIAT PANDA</p> <p>67x53x12mm NULL</p>
	<p>R021885 NO. 4443820</p> <p>TUBO DO TERMOSTATO</p> <p>FIAT PANDA 45</p> <p>B110-d9/9mm 35-65-35mm</p>		<p>R021908 NO. 5972403</p> <p>TUBO SUPERIOR DE LIGAÇÃO DO TERMOSTATO À BOMBA DE ÁGUA</p> <p>FIAT PANDA 45</p> <p>B245-d30/30mm 45-135-100mm</p>
	<p>R2466 NO. 4405595 - M-21880</p> <p>TUBO INFERIOR DO RADIADOR</p> <p>FIAT PANDA 45</p> <p>B270-d34/34mm 95-180-60mm</p>		<p>RT08353 NO. 5959715 - 5985827 - 5986091 - 71736949 - 7569592 - 7569595</p> <p>TUBO DE TRAVÃO FRENTE LH-RH</p> <p>FIAT PANDA (141A_) 1000 (156 A2.100) 44CV (01-1986 A 04-1992) - 1000 (156 A3.000) 50CV (01-1985 A 12-1992) - 100 i.e Cat. (141 C2.000 - 156 A2.246) 45CV (10-1987 A 08-1998) - 1300 D (156 A5.000) 37CV 804-1986 A 12-1992) - 650 (141 A.000) 30CV (01-1982 A 07</p> <p>470mm FB23 - MC11</p>
	<p>RT08425 NO. 481636 - 7569593 - 5967970 - 71736956 - 7649589</p> <p>TUBO DE TRAVÃO TRÁS LH-RH</p> <p>FIAT PANDA 4X4 (APÓS 07-1983)</p> <p>335mm FB23 - MC11</p>		<p>RT08426 NO. 7598927</p> <p>TUBO DE TRAVÃO FRENTE LH-RH</p> <p>FIAT PANDA 1000 4X4 (01-1986 A 12-1994) - 1000 i.e. Cat.(10-1987 A 08-1998) - 1100 (05-1991 A 09-2003) - 1100 4X4 (02-1995 A 07-2004) - 1100 Trekking 4X4 (10-1991 A 07-2004) - 750 Cat.(01-1995 A 12-1997) - 900 (04-1992 A 12-1996) - 950 4X4 (09-1983 A 12-1</p> <p>408mm FB23 - MC11</p>
	<p>RT08426 NO. 7598927</p> <p>TUBO DE TRAVÃO FRENTE LH-RH</p> <p>FIAT PANDA VAN 1000 i.e (08-1992 A 02-2004) - 750 (01-1986 A 07-1992)</p> <p>408mm FB23 - MC11</p>		<p>S1364 NO. 46761279 - 46741920</p> <p>SILENT-BLOC DA SUSPENSÃO DE TRÁS</p> <p>FIAT PANDA 2003 1.1 8V - 1.2 8V - 1.3 JTD MJ 16V</p> <p>d59x53mm d54mm 1f-d12mm</p>
	<p>W5054 NO. 46819147 - 55200498</p> <p>POLIE DA CAMBOTA (6 PISTAS)</p> <p>FIAT PANDA (MOD 2003) 1.3 JTD APÓS 06-2003 - Mtr 188A9000 (70CV)</p> <p>d165mm d35mm</p>		<p>W5084 NO. 55181620 - 55197953</p> <p>POLIE DA CAMBOTA (5 PISTAS)</p> <p>FIAT PANDA</p> <p>d140/150mm d23mm</p>
	<p>Z10430 NO. 4198690</p> <p>Mola de fixação</p> <p>FIAT PANDA</p> <p>11x11x13mm 1p-8x8-11.3mm 1f-d4.2mm</p>		<p>Z10672 NO. 5757381</p> <p>Mola de fixação</p> <p>FIAT PANDA</p> <p>d8.5x19mm 1p-d5.5-8mm</p>
	<p>Z10845 NO. 14203080</p> <p>Mola de fixação</p> <p>FIAT PANDA (APÓS 1986)</p> <p>15x15x21mm 1p-11x11-19.5mm 1f-d5.5mm</p>		<p>Z80442 NO. 5755291</p> <p>Mola de painel</p> <p>FIAT PANDA (De 1986 A 1991)</p> <p>d19.5x25mm 1p-d7-18mm</p>

	Z80465 NO. 4389939		Z80478 NO. 7696564
	Mola de fixação FIAT PANDA		Mola de fixação FIAT PANDA
	14x11x15mm 1p-10.5x6-8mm		13x13x12.5mm 1p-10x10-11mm 1f-d3.9mm
	Z80483 NO. 4484226		Z80519 NO. 4358789
	Mola de painel FIAT PANDA		Mola de fixação FIAT PANDA
	d18x17mm 1p-d7.5-15mm		d11x9mm 1p-d8.5-7.8mm 1f-d3mm
	Z80530 NO. 4484838		Z80578 NO. 14569580 - 14569680
	Mola de fixação FIAT PANDA		Mola de fixação FIAT PANDA (Após 2003)
	d17x20mm 1p-10x10-17mm 1f-d4.2mm		20x8x15mm 1f-8mm
	Z80602 NO. 4368201		Z80619 NO. 7677865
	Mola de painel FIAT PANDA		Mola de painel FIAT PANDA
	d12x12mm 1p-d7-9.5mm		d14x12mm 1p-d7.5-10mm
	Z80666 NO. 5962559		Z80828 NO. 90467-11063
	Mola de fixação FIAT PANDA		NULL FIAT PANDA (Até 2003)
	d11x20mm 1p-d6.2-10mm		d18x17.7mm 1p-10.4x9-8.5mm
	Z80831 NO. 14189071		Z9002 NO. 7619712 - 7681592 - 82372840
	Mola porca rápida FIAT PANDA (Até 2003)		MOLA DE ESCAPE 34mm FIAT PANDA (1983 A 1992)
	22.3x15x8.5mm 1f-d6mm		d21x34mm NULL

FIAT PUNTO

	A1307 NO. 7753635 - 46431619		A1308 NO. 7765891
	SUPORTE DA FRENTE DO MOTOR FIAT PUNTO TD		SUPORTE DIREITO DO MOTOR DO LADO DA CAIXA FIAT PUNTO 55 - 60
	187x110x90mm d12-74mm		170x120x77 1p-d10-70mm











	<p>A1309 NO. 7748666</p> <p>SUPORTE TRÁS DO MOTOR</p> <p>FIAT PUNTO TD</p> <p>125x110x85mm 1f-d17mm 1r-d10mm</p>		<p>A1310 NO. 7765892</p> <p>SUPORTE INTERMÉDIO DO MOTOR</p> <p>FIAT PUNTO TD</p> <p>170x120x77 1p-d10-70mm</p>
	<p>A1322 NO. 7784313</p> <p>SUPORTE DE MOTOR DO LADO DA CAIXA</p> <p>FIAT PUNTO 55 - 60</p> <p>125x113x80mm 1f-d18mm 1r-d10mm</p>		<p>A1326 NO. 7793944</p> <p>SUPORTE DO MOTOR LADO DA CAIXA (COMPLETO)</p> <p>FIAT PUNTO 55 - 60</p> <p>410x170x100mm 1p-d10mm</p>
	<p>A1327 NO. 7793945</p> <p>SUPORTE DO MOTOR LADO DA CAIXA (COMPLETO)</p> <p>FIAT PUNTO 6 VELOCIDADES</p> <p>410x170x100mm 1p-d10mm</p>		<p>A1410 NO.</p> <p>SUPORTE FRENTE DO MOTOR LADO DA CAIXA (Complemento do a1326)</p> <p>FIAT PUNTO 55 - 60 (6 velocidades) - 75 (6 velocidades)</p> <p>135x80x60mm 1f-d10mm</p>
	<p>A1478 NO. 7775940</p> <p>APOIO SUPERIOR DO AMORTECEDOR DA SUSPENSÃO DA FRENTE</p> <p>FIAT PUNTO TT</p> <p>190x116x49mm 1f-d12mm</p>		<p>A1618 NO. 46541086</p> <p>APOIO DO AMORTECEDOR DA FRENTE</p> <p>FIAT PUNTO APÓS 1999 - 1.9D - 1.9JTD - 130(1.8 16V) - 60(1.2 8V) - 80(1.2 16V)</p> <p>d77x19mm 1f-d12mm</p>
	<p>A1619 NO. 46528865</p> <p>APOIO DO MOTOR PARTE DE TRÁS</p> <p>FIAT PUNTO (APÓS 1999) - 130 1.8 16V - 60 1.2 8V - 80 1.2 16V</p> <p>260x140x120mm NULL</p>		<p>A1620 NO. 46528853 - 46809632</p> <p>APOIO DO MOTOR PARTE DA FRENTE</p> <p>FIAT PUNTO (APÓS 1999) - 130 1.8 16V - 60 1.2 8V - 80 1.2 16V</p> <p>230x190x110mm NULL</p>
	<p>A1686 NO. 46528869</p> <p>APOIO DO MOTOR PARTE DE TRÁS</p> <p>FIAT NOVO PUNTO 1.9D - 1.9JTD - 130 1.8 (16V) - PUNTO FL-2003 1.8 16V - 1.9JTD (85CV)</p> <p>265x110x143mm 1f-d19mm</p>		<p>A1896 NO. 7758211</p> <p>APOIO DO MOTOR PARTE DA FRENTE</p> <p>FIAT PUNTO (176_) 1.4 GT Turbo 09.96 - 09.99 96 131 1372 Hatchback FIAT PUNTO (176_) 1.4 GT Turbo 01.94 - 09.96 98 133 1372 Hatchback</p> <p>NULL NULL</p>
	<p>E0213-M NO. 46528871 - 46844208</p> <p>ESTICADOR DO MOTOR PARTE DE TRÁS</p> <p>FIAT PUNTO 60 1.2 8V - 80 1.2 16V - 130 1.8 16V (APÓS 1999) - FIAT PUNTO 1.2 8V - 1.2 16V - 1.4 16V (APÓS 2003)</p> <p>210x100x35mm 1f-d24mm 1f-d12mm</p>		<p>E0214-M NO. 46552759</p> <p>ESTICADOR DO MOTOR PARTE DE TRÁS</p> <p>FIAT PUNTO MODELO 99 1.9D - 1.9 JTD 130 (1.8 16V) - PUNTO FL 2003 1.8 16V - 1.9 JTD 85CV</p> <p>200x110x60mm 1f-d20mm 1f-d12 - 6mm</p>
	<p>E1027 NO. 7718578</p> <p>ESTICADOR DE ESCAPE PARTE DE TRÁS</p> <p>FIAT PUNTO 55 - 60 - TD</p> <p>95x35x25mm NULL</p>		<p>E1048 NO. 7740653 - 7718577 - 1755.65</p> <p>ESTICADOR DE ESCAPE FRENTE</p> <p>FIAT PUNTO 55 - 60 TD</p> <p>57x39x25mm 2f-d9mm</p>

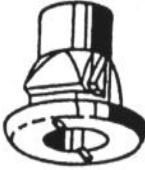

	<p>F0469-I NO. 43307029 - 82282140</p> <p>FOLE DA TRANSMISSÃO LADO DA CAIXA</p> <p>FIAT PUNTO GT DIESEL - TURBO DIESEL</p> <p>d85x80mm 1f-d61mm 1f-d23mm</p>		<p>F0835A5I NO. 46307071 - 46307436 - 46307503 - 46307784 - 60813077</p> <p>FOLE DA TRANSMISSÃO JUNTO À CAIXA</p> <p>FIAT PUNTO I 1.7 TD (09-96 A 09-99) - PUNTO II 1.9D (APÓS 09-99)</p> <p>d93x87mm 1f-d79mm 1f-d24.4mm</p>
	<p>F1127H-I NO. 9947369 - 9941582</p> <p>FOLE DA DIRECÇÃO ESQUERDO E DIREITO</p> <p>FIAT PUNTO (APÓS 93)</p> <p>d62x210mm 1f-d58mm 1f-d10mm</p>		<p>F1137-I NO. 7746232 - 7715294 - 46307644 - 51704105</p> <p>FOLE DO LADO DA CAIXA</p> <p>FIAT PUNTO (APÓS 9-93)</p> <p>d76x90mm 1f-d60mm 1f-d19mm</p>
	<p>F1138H-I NO. 7761570 - 46307555 - 46429633 - 82483204 - 46307067 - 46307575 - 60813074 - 60813077 - 46307060</p> <p>FOLE DA TRANSMISSÃO JUNTO À RODA</p> <p>FIAT PUNTO TT</p> <p>d92x88mm 1f-d80mm 1f-d23mm</p>		<p>F1181-I NO. 7545579 - 9945564</p> <p>FOLE DA DIRECÇÃO ESQUERDO E DIREITO</p> <p>FIAT PUNTO (APÓS 9-93)</p> <p>d63x155mm 1f-d45mm 1f-d10mm</p>
	<p>F1327-I NO. 7762158</p> <p>FOLE DE AMORTECEDOR DA FRENTE</p> <p>FIAT PUNTO</p> <p>d70x200mm 1f-d60mm 1f-d18mm</p>		<p>F1666-I NO. 9945564</p> <p>FOLE DIRECÇÃO ASSISTIDA LADO ESQUERDO E DIREITO</p> <p>FIAT PUNTO 1ª SÉRIE</p> <p>d64x165mm 1f-d46mm 1f-d10mm</p>
	<p>F1781-I NO. 272441</p> <p>FOLE DA TRANSMISSÃO JUNTO À CAIXA</p> <p>FIAT PUNTO II 1.9 JTD 8V (APÓS 1999)</p> <p>d88x83mm 1f-d82mm 1f-d22mm</p>		<p>F1822-I NO. 4315444 - 46307029</p> <p>FOLE DA TRANSMISSÃO JUNTO À CAIXA</p> <p>FIAT PUNTO 1.3JTD 16V - 1.4iT GT Turbo - 1.7TD - 1.8i HGT - 1.9 JTD - 1.3 JTDM 16V (93 A 00)</p> <p>d102x94mm 1f-d99mm 1f-d25mm</p>
	<p>F9052H-I NO. 46308465</p> <p>FOLE DO CARDAN LADO DA RODA</p> <p>FIAT PUNTO - GRANDE PUNTO (199) 1.4 T-Jet (198 A4.000) 120CV (APÓS 09-2007)</p> <p>d105x125mm 1f-d28mm 1f-d88mm</p>		<p>F9052H-I NO. 46308465</p> <p>FOLE DO CARDAN LADO DA RODA</p> <p>FIAT PUNTO EVO (199) 1.3 D Multijet (199 B1.000) 95CV (10-2009 A 02-2012) - (199 B4.000 - 223 A9.000) 84CV (10-2009 A 02-2012) - 1.4 (199 A7.000) 75CV (07-2009 A 02-2012) - 1.4 (350 A1.000) 77CV (10-2009 A 02-2012)</p> <p>d105x125mm 1f-d28mm 1f-d88mm</p>
	<p>KF1727-T NO. 51733779</p> <p>KIT DE FOLE DO CARDAN JUNTO À RODA</p> <p>FIAT PUNTO II (APÓS 99) 1.2i CNG NATURAL POWER</p> <p>d84x108mm 1f-d74mm 1f-d23mm</p>		<p>KF1796-T NO. 4630767 - 46307575 - 7761570 - 46307555 - 46429633 - 82483204 - 46307067 - 60813074 - 60813077 - 463...</p> <p>KIT DE FOLE</p> <p>FIAT PUNTO I 1.1i - 1.2i - 1.4iT - 1.6i - 1.7D - 1.7TD</p> <p>d90x85mm 1f-d78mm 1f-d22mm</p>
	<p>KF3788-T NO. 46307716</p> <p>KIT DE FOLE DO CARDAN JUNTO À RODA</p> <p>FIAT PUNTO 2 1.9 JTD 8V (APÓS 1999)</p> <p>d100x122mm 1f-d83mm 1f-d25mm</p>		<p>KT0500 NO. 46531017</p> <p>KIT DE BATENTE DA SUSPENSÃO DA FRENTE</p> <p>FIAT PUNTO APÓS 1999 - 1.9D - 1.9JTD - 130(1.8 16V) - 60(1.2 8V) - 80(1.2 16V) - PUNTO FL 2003 - 1.2(16V) - 1.2(8V) - 1.3JTD MJ(70CV) - 1.4(16V) - 1.8(16V) - 1.9JTD(85CV) - 1.9JTD MJ(100CV)</p> <p>d75x210mm 1f-d60mm 1f-d22mm</p>

	<p>KT0505 NO. 51800004</p> <p>KIT DE BATENTE SUSPENSÃO DE TRÁS</p> <p>FIAT PUNTO (199_) 0.9 Twinair Turbo (APÓS 03.12) 86cv 875cc Hatchback - FIAT PUNTO (199_) 0.9 Bifuel (APÓS 03.12) 86cv 875cc Hatchback - FIAT PUNTO (199_) 0.9 (APÓS 12.13) 101cv 875cc Hatchback - FIAT PUNTO (199_) 0.9 (APÓS 07.13) - 105cv 875cc Hatchback - FIAT PUNTO (199_) 1.2 (APÓS 02.14) 67cv 1242cc Hatchback - FIAT PUNTO (199_) 1.2 (APÓS 03.12) 69cv 1242cc Hatchback - FIAT PUNTO (199_) 1.4 (APÓS 03.12) 75cv 1368cc Hatchback - FIA...etc.</p> <p>d63x268mm 1f-d13mm 1f-d60mm</p>		<p>KT0505 NO. 51800004</p> <p>KIT DE BATENTE SUSPENSÃO DE TRÁS</p> <p>FIAT PUNTO EVO (199_) 1.2 (10.09 A 02.12) 65cv 1242cc Hatchback - FIAT PUNTO EVO (199_) 1.2 (10.09 A 02.12) 69cv 1242cc Hatchback - FIAT PUNTO EVO (199_) 1.4 (07.09 A 02.12) 75cv 1368cc Hatchback - FIAT PUNTO EVO (199_) 1.4 (10.09 A 02.12) 77cv 1368cc Hatchback - FIAT PUNTO EVO (199_) 1.4 LPG (06.09 A 02.12) 78cv 1368cc Hatchback - FIAT PUNTO EVO (199_) 1.4 Natural Power (10.09 A 02.12) 78cv 1368cc Hatchback - FIAT PUNTO EVO (199_) 1.4 16V ...etc.</p> <p>d63x268mm 1f-d13mm 1f-d60mm</p>
	<p>KT0506 NO. 55701429</p> <p>KIT DE BATENTE SUSPENSÃO DA FRENTE</p> <p>ABARTH PUNTO (199_) 1.4 (APÓS 04.10) 163cv 1368cc Hatchback - ABARTH PUNTO (199_) 1.4 (APÓS 05.08) 180cv 1368cc Hatchback</p> <p>d62x285mm 1f-d13mm 1f-d60mm</p>		<p>KT0506 NO. 55701429</p> <p>KIT DE BATENTE SUSPENSÃO DA FRENTE</p> <p>FIAT PUNTO (199_) 0.9 (APÓS 12.13) 101cv 875cc Hatchback - FIAT PUNTO (199_) 0.9 (APÓS 07.13) 105cv 875cc Hatchback - FIAT PUNTO (199_) 1.2 (APÓS 02.14) 67cv 1242cc Hatchback - FIAT PUNTO (199_) 1.4 (APÓS 03.12) 75cv 1368cc Hatchback - FIAT PUNTO (199_) 1.3 D Multijet (APÓS 12.13) 80cv 1248cc Hatchback</p> <p>d62x285mm 1f-d13mm 1f-d60mm</p>
	<p>KT0506 NO. 55701429</p> <p>KIT DE BATENTE SUSPENSÃO DA FRENTE</p> <p>FIAT PUNTO EVO (199_) 1.2 (10.09 A 02.12) 65cv 1242cc Hatchback - FIAT PUNTO EVO (199_) 1.2 (10.09 A 02.12) 69cv 1242cc Hatchback - FIAT PUNTO EVO (199_) 1.4 (07.09 A 02.12) 75cv 1368cc Hatchback - FIAT PUNTO EVO (199_) 1.4 (10.09 A 02.12) 77cv 1368cc Hatchback - FIAT PUNTO EVO (199_) 1.4 LPG (06.09 A 02.12) 78cv 1368cc Hatchback - FIAT PUNTO EVO (199_) 1.4 Natural Power (10.09 A 02.12) 78cv 1368cc Hatchback - FIAT PUNTO EVO (199_) 1.4 16V ...etc.</p> <p>d62x285mm 1f-d13mm 1f-d60mm</p>		<p>M6049 NO. 7669581</p> <p>JUNTA DE ESCAPE</p> <p>FIAT PUNTO (1993 A 1995)</p> <p>113x60mm 2f-d35mm</p>
	<p>M6058 NO. 46459258 - 7737712</p> <p>JUNTA DE ESCAPE</p> <p>FIAT PUNTO (APÓS 1993)</p> <p>125x78mm 1f-d55.5mm</p>		<p>P1061 NO. 46554492</p> <p>CAPA DE PEDAL DA EMBRAIAGEM</p> <p>FIAT PUNTO 1.2 (APÓS 09-2003) - 1.3 JTD 16V (APÓS 06-2003) - 1.4 (APÓS 09-2003) - 1.9 DS 60 (APÓS 09-1999) - 1.9 JTD (10-2001 A 06-2003) - 1.9 JTD 80 (APÓS 09-1999)</p> <p>91x46x10mm NULL</p>
	<p>P1062 NO. 46554487</p> <p>CAPA DE PEDAL DO TRAVÃO</p> <p>FIAT PUNTO 1.2 (APÓS 09-2003) - 1.3 JTD 16V (APÓS 06-2003) - 1.4 (APÓS 09-2003) - 1.9 DS 60 (APÓS 09-1999) - 1.9 JTD (10-2001 A 06-2003) - 1.9 JTD 80 (APÓS 09-1999)</p> <p>94x48x10mm NULL</p>		<p>P1083 NO. 7653555</p> <p>CAPA DE PEDAL DO ACELARADOR</p> <p>FIAT PUNTO 1.2 60 (188 030 050 130 150 230 250) (APÓS 09-1999) 60CV 1242CC - FIAT PUNTO 1.2 16V 80 (188 233 235 253 255 333 353 639) (APÓS 09-1999) 80CV 1242CC - FIAT PUNTO 1.8 130 HGT (188 738 718) (APÓS 09-1999) 130CV 1747CC - FIAT PUNTO 1.9 DS 60 (188</p> <p>97x43x8mm NULL</p>
	<p>P1090 NO. 51736089</p> <p>CAPA DO PEDAL DO TRAVÃO</p> <p>FIAT - PUNTO (188) - 1.2 60 (188.030 - .050 - .130 - .150 - .230 - .250) Tipo de caixa de velocidades: Caixa de velocidades sequencial (APÓS 09.99) 60cv 1242cc - FIAT - PUNTO (188) - 1.2 16V 80 (188.233 - .235 - .253 - .255 - .333 - .353 - .639...) Tipo de caixa de</p> <p>94x50x8mm 1pino 18x9mm</p>		<p>Q2009 NO.</p> <p>UNIÃO DE ESCAPE 48/45x80mm</p> <p>FIAT - PUNTO (188) - 1.4 (APÓS 09.03) 95cv 1368cc Hatchback</p> <p>80x77x55mm 1f-d45/48mm</p>
	<p>R019772 NO. 7746122</p> <p>TUBO SUPERIOR DO RADIADOR</p> <p>FIAT PUNTO 60 SELECTA (1.2 SPi CF2 17684000)</p> <p>B280-d27/27mm 50-70-160-50-90mm</p>		<p>R020350 NO. 7718664 - 7745653 - 7770566 - 46441019 - 46441020</p> <p>TUBO SUPERIOR DO RADIADOR</p> <p>FIAT PUNTO 55</p> <p>B312-d26/26mm 55-80-175-105mm</p>
	<p>R020352 NO. 7797503 - 7722856 - 7760969 - 7770567 - 7772356 - 7772358 - 7773449</p> <p>TUBO INFERIOR DO RADIADOR</p> <p>FIAT PUNTO 55 - 55 6 velocidades - 60 - 60 CABRIO</p> <p>B315-d26/28mm d14mm 50-80-155-95mm 250-85-210-120-95-110</p>		<p>R020365 NO. 7730814 - 46417778</p> <p>TUBO SUPERIOR DO RADIADOR</p> <p>FIAT PUNTO TD</p> <p>B400-d32/32mm 60-40-55-95-175-55-55mm</p>



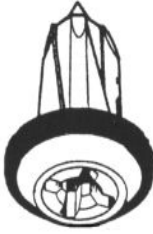

 <p>Component / Componente</p>	<p>RT08264 NO. 46760308 - 71736927</p> <p>TUBO DE TRAVÃO FRENTE LH-RH</p> <p>FIAT PUNTO (MOD.99) (APÓS 09-1999)</p>	 <p>Component / Componente</p>	<p>RT08265 NO. 46542040 - 46834651</p> <p>TUBO DE TRAVÃO TRÁS LH-RH</p> <p>FIAT PUNTO (MOD.99) TT APÓS 9-1999</p>
 <p>Component / Componente</p>	<p>RT08427 NO. 7563852 - 7603330</p> <p>TUBO DE TRAVÃO TRÁS LH-RH</p> <p>FIAT PUNTO 1.4 GT TURBO - 1.6 (66kw) - FIAT PUNTO SELECTA (09-1993 A 09-1999)</p>	 <p>Component / Componente</p>	<p>RT08459 NO. 46786435 - 7586907</p> <p>TUBO DE TRAVÃO TRÁS LH-RH</p> <p>FIAT PUNTO 1.4 GT TURBO (01-1994 A 09-1999)</p>
 <p>Component / Componente</p>	<p>RT08481 NO. 7735009 - 46423177 - 71736967</p> <p>TUBO DE TRAVÃO FRENTE LH-RH</p> <p>FIAT PUNTO TT (EXCEPTO ABS - SELECTA - 1.2 16V) (09-1993 A 09-1999)</p>	 <p>Component / Componente</p>	<p>RT08482 NO. 46423176 - 7735008 - 71736966</p> <p>TUBO DE TRAVÃO FRENTE LH</p> <p>FIAT PUNTO TT (09-1993 A 09-1999)</p>
 <p>Component / Componente</p>	<p>RT08484 NO. 46423178 - 7735010 - 71736922</p> <p>TUBO DE TRAVÃO FRENTE LH</p> <p>FIAT PUNTO 1.2 16V (+ABS) (1997 A 09-1999) - 1.4 GT TURBO (09-1993 A 09-1999) - 1.6(66KW) (09-1993 A 09-1999) - 1.7 TD(+ABS) (03-1996 A 09-1999) -SELECTA (09-1993 A 09-1999) -TT (+ABS) (-SELECTA - 1.2 16V - 1.4 GT) (09-1993 A 02-1996)</p>	 <p>Component / Componente</p>	<p>RT08560 NO. 46423178 - 46423179</p> <p>TUBO DE TRAVÃO FRENTE LH-RH</p> <p>FIAT PUNTO 1.2 16V (-ABS) (1997 A 09-1999)</p>
	<p>S0753-I NO. 5927292</p> <p>SILENT-BLOC BRAÇO DA SUSPENSÃO FRENTE</p> <p>FIAT PUNTO TT (1993 A 1999)</p>		<p>S1205 NO. 7755671</p> <p>SILENT-BLOC DA SUSPENSÃO TRÁS (PEQUENO)</p> <p>FIAT PUNTO TT</p>
	<p>S1206 NO. 7756218</p> <p>SILENT-BLOC DA SUSPENSÃO DE TRÁS (GRANDE)</p> <p>FIAT PUNTO TT</p>		<p>S1207-D NO. 7775344</p> <p>SILENT-BLOC DO BRAÇO DA SUSPENSÃO FRENTE DIREITO</p> <p>FIAT PUNTO</p>
	<p>S1207-E NO. 7775343</p> <p>SILENT-BLOC DO BRAÇO DA SUSPENSÃO FRENTE ESQUERDO</p> <p>FIAT PUNTO</p>		<p>S1323 NO. 46559890</p> <p>SILENT-BLOC DO BRAÇO DA SUSPENSÃO DA FRENTE</p> <p>FIAT PUNTO 1.2 16V (APÓS 2000)</p>
	<p>S1324 NO. 46748800</p> <p>SILENT-BLOC DO BRAÇO DA SUSPENSÃO DA FRENTE</p> <p>FIAT PUNTO 1.2 16V (APÓS 2000)</p>		<p>S1364 NO. 46761279 - 46741920</p> <p>SILENT-BLOC DA SUSPENSÃO DE TRÁS</p> <p>FIAT PUNTO GAMA 97 - 1.4 GT TURBO - 1.7D - 1.7TD - 55 (1.1 SP1) - 60 (1 - 2 SPi) - 75 (1.2 MPI 8V) - 90 (1.2 MPI 16V) - FIAT PUNTO 99 A 2003 60 (1 - 2 8V) - 80 (1.2 16V) - 130 (1.8 16V) - 1.9D - 1.9 JTD</p>

	S1595 NO. 50511650 - 50521486 - 51783056 - 51783057 <i>SILENT-BLOC BRAÇO SUPERIOR FRENTE</i> FIAT PUNTO (199) 0.9 Twin air Turbo (A partir de 03.12) 86cv 875cc Hatchback - FIAT PUNTO (199) 0.9 Bifuel (A partir de 03.12) 86cv 875cc Hatchback - FIAT PUNTO (199) 0.9 (A partir de 12.13) 101cv 875cc Hatchback - FIAT PUNTO (199) 0.9 (A partir de 07.1.3) 105cv 875cc Hatchback - FIAT PUNTO (199) 1.2 (A partir de 02.14) 67cv 1242cc Hatchback - FIAT PUNTO (199) 1.2 (A partir de 03.12) 69cv 1242cc Hatchback - FIAT PUNTO (199) 1.4 (A ...etc.		S1595 NO. 50511650 - 50521486 - 51783056 - 51783057 <i>SILENT-BLOC BRAÇO SUPERIOR FRENTE</i> FIAT PUNTO EVO (199) 1.2 (10.09 A 02.12) 65cv 1242cc Hatchback - FIAT PUNTO EVO (199) 1.2 (10.09 A 02.12) 69cv 1242cc Hatchback - FIAT PUNTO EVO (199) 1.4 (07.09 A 02.12) 75cv 1368cc Hatchback - FIAT PUNTO EVO (199) 1.4 (10.09 A 02.12) 77cv 1368cc Hatchback - FIAT PUNTO EVO (199) 1.4 LPG (06.09 A 02.12) 78cv 1368cc Hatchback - FIAT PUNTO EVO (199) 1.4 Natural Power (10.09 A 02.12) 78cv 1368cc Hatchback - FIAT PUNTO EVO (199) 1.4 16 V ...etc.
	d53x67mm d41mm 1f-d14mm		d53x67mm d41mm 1f-d14mm
	T0656-I NO. 51775545 - 51866009 <i>BATENTE SUSPENSÃO DA FRENTE</i> ABARTH PUNTO (199_) 1.4 (APÓS 04.10) 163cv 1368cc Hatchback		T0656-I NO. 51775545 - 51866009 <i>BATENTE SUSPENSÃO DA FRENTE</i> FIAT PUNTO (199_) 0.9 (APÓS 07.13) 105cv 875cc Hatchback - FIAT PUNTO (199_) 1.4 (APÓS 03.12) 75cv 1368cc Hatchback
	d63x65mm 1f-d27mm 1f-d20mm		d63x65mm 1f-d27mm 1f-d20mm
	T0656-I NO. 51775545 - 51866009 <i>BATENTE SUSPENSÃO DA FRENTE</i> FIAT PUNTO EVO (199_) 1.2 (10.09 A 02.12) 65cv 1242cc Hatchback - FIAT PUNTO EVO (199_) 1.2 (10.09 A 02.12) 69cv 1242cc Hatchback - FIAT PUNTO EVO (199_) 1.4 (07.09 A 02.12) 75cv 1368cc Hatchback - FIAT PUNTO EVO (199_) 1.4 (10.09 A 02.12) 77cv 1368cc Hatchback - FIAT PUNTO EVO (199_) 1.4 Natural Power (10.09 A 02.12) 78cv 1368cc Hatchback - FIAT PUNTO EVO (199_) 1.4 16V (10.09 A 02.12) 105cv 1368cc Hatchback - FIAT PUNTO EVO (199_) 1.4 16V...etc.		T0707-I NO. 46529067 - 46819935 <i>BATENTE DA SUSPENSÃO DE TRÁS</i> FIAT PUNTO (188_) 1.2 60 (188.030_ .050, .130, .150, .230, .250) (09.99 A 12.10) 60cv 1242cc Hatchback - FIAT PUNTO (188_) 1.2 16V 80 (188.233, .235, .253, .255, .333, .353, .639,... 09.99 - 12.06 59 80 1242 Hatchback FIAT PUNTO (188_) 1.4 (09.03 A 03.12) 95cv 1368cc Hatchback - FIAT PUNTO (188_) 1.8 130 HGT (188.738, .718) 09.99 - 03.12 96 130 1747 Hatchback FIAT PUNTO (188_) 1.3 JTD 16V (06.03 A 03.12) 70cv 1248cc Hatchback - FIAT PUNTO (...etc.
	d63x65mm 1f-d27mm 1f-d20mm		d92x135mm 3-molas-encaixe-d8mm
	T1095 NO. 7750990 <i>BATENTE DA BARRA ESTABILIZADORA DA FRENTE</i> FIAT PUNTO APÓS 1999 1.9D - 1.9 JTD - 60 (1.2 8V) - 80(1.2 16V) - 130(1.8 16V) - FIAT PUNTO APÓS 2003 1.2 (16V) - 1.2(8V) - 1.3 JTD MJ (70 CV) - 1.4(16V) - 1.8(16V) - 1.9 JTD (85CV) 1.9 JTD MJ (100CV)		W5013 NO. 73501275 - 46447843 - 55185409 - 55190424 - 55185403 <i>POLIE DA CAMBOTA (6 PISTAS)</i> FIAT NUOVA PUNTO (19 JTD - DIESEL - TURBO DIESEL)
	87x31x34mm NULL		d164.5mm d30.5mm
	W5084 NO. 55181620 - 55197953 <i>POLIE DA CAMBOTA (5 PISTAS)</i> FIAT PUNTO 1.2 16V 80 (APÓS 09-1999)		W5105 NO. 7778028 - 46516096 - 71711983 - 71723808 <i>POLIE DA CAMBOTA (4+3 PISTAS)</i> FIAT PUNTO 1.2 (03-1994 A 09-1999) - 1.2 16V (10-1993 A 09-1999) - PUNTO CABRIOLET 1.2 16V (04-1997 A 09-1999) - 1.2 (05-1995 A 06-2000)
	d140/150mm d23mm		d150/129mm d23mm
	Z80502 NO. 5757553 <i>Mola de retenção</i> FIAT PUNTO		Z80578 NO. 14569580 - 14569680 <i>Mola de fixação</i> FIAT PUNTO (Após 2003)
	d16x9.5mm 1p-7x7-8.5mm 1f-d4.8mm		20x8x15mm 1f-8mm
	Z80588 NO. 7637466 <i>Mola de painel</i> FIAT PUNTO		Z80588 NO. 7637466 <i>Mola de painel</i> FIAT PUNTO (Após 2003)
	d24x16.5mm 1p-d16.5-14mm		d24x16.5mm 1p-d16.5-14mm
	Z80604 NO. 7739801 - 500382985 <i>Mola de painel</i> FIAT PUNTO		Z80604 NO. 7739801 - 500382985 <i>Mola de painel</i> FIAT PUNTO (Após 2003)
	d18.2x21.6mm 1p-d6.4-16.1mm		d18.2x21.6mm 1p-d6.4-16.1mm

	<p>Z80605 NO. 7745194</p> <p><i>Mola de fixação</i></p> <p>FIAT PUNTO</p> <p>d20x20.5mm 1p-d9-18.5mm 1f-7x7mm</p>		<p>Z80605 NO. 7745194</p> <p><i>Mola de fixação</i></p> <p>FIAT PUNTO (Após 2003)</p> <p>d20x20.5mm 1p-d9-18.5mm 1f-7x7mm</p>
	<p>Z80619 NO. 7677865</p> <p><i>Mola de painel</i></p> <p>FIAT PUNTO</p> <p>d14x12mm 1p-d7.5-10mm</p>		<p>Z80625 NO. 82421028 - 504056662</p> <p><i>Mola de fixação</i></p> <p>FIAT PUNTO</p> <p>d18x42.5mm 1p-d8-19mm</p>
	<p>Z80634 NO. 7777069</p> <p><i>Mola de friso</i></p> <p>FIAT PUNTO</p> <p>d18.5x16mm 1p-d8.5-9mm</p>		<p>Z80635 NO. 14216080 - 14216087</p> <p><i>Mola de fixação</i></p> <p>FIAT PUNTO</p> <p>d18x14mm 1p-10x10-12.5mm 1f-d4.8mm</p>
	<p>Z80638 NO. 7638283</p> <p><i>Mola de painel</i></p> <p>FIAT PUNTO</p> <p>d25x19.5mm 1p-d8-17mm</p>		<p>Z80651 NO. 82426359</p> <p><i>Mola de fixação</i></p> <p>FIAT PUNTO</p> <p>d18x42mm 1p-d10-19mm</p>
	<p>Z80668 NO. 735266957</p> <p><i>Mola de painel</i></p> <p>FIAT PUNTO (Após 1999)</p> <p>d20x15.5mm 1p-d8.2-13mm</p>		<p>Z80668 NO. 735266957</p> <p><i>Mola de painel</i></p> <p>FIAT PUNTO (Após 2003)</p> <p>d20x15.5mm 1p-d8.2-13mm</p>
	<p>Z80669 NO. 7768047</p> <p><i>Mola de painel</i></p> <p>FIAT PUNTO</p> <p>d14x9.8mm 1p-d7.5-7.8mm</p>		<p>Z80674 NO. 46776091</p> <p><i>Mola de painel</i></p> <p>FIAT PUNTO</p> <p>d18.5x23.5mm 1p-d12-15.5mm</p>
	<p>Z80674 NO. 46776091</p> <p><i>Mola de painel</i></p> <p>FIAT PUNTO (Após 2003)</p> <p>d18.5x23.5mm 1p-d12-15.5mm</p>		<p>Z80676 NO. 46558337</p> <p><i>Mola de fixação</i></p> <p>FIAT PUNTO</p> <p>d18x17mm 1p-8x8-13.7mm 1f-d4.8mm</p>
	<p>Z80676 NO. 46558337</p> <p><i>Mola de fixação</i></p> <p>FIAT PUNTO (Após 2003)</p> <p>d18x17mm 1p-8x8-13.7mm 1f-d4.8mm</p>		<p>Z80695 NO. 46537978</p> <p><i>Mola de friso</i></p> <p>FIAT PUNTO</p> <p>17x15x18.7mm 1p-8x8-15mm</p>

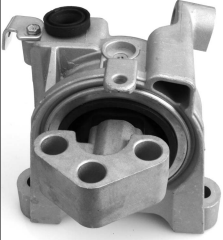





	Z80695 NO. 46537978		Z80702 NO. 46408953 - 46748771
	Mola de friso FIAT PUNTO (Após 2003)		Mola de fixação FIAT PUNTO
	17x15x18.7mm 1p-8x8-15mm		d16x25.5mm 1p-8x8-24mm 1f-d4.8mm
	Z80707 NO. 60660554		Z80727 NO. 7798971
	Mola de fixação FIAT PUNTO		Mola de fixação FIAT PUNTO
	12x9.7x21.6mm 1p-11.5x3-19.4mm		d18x19mm 1p-d7.5-12mm

FIAT STILO-IDEA

	A1745 NO. 50702841		A1785 NO. 51776850 - 51776846 - 46847853 - 46847852
	APOIO DO AMORTECEDOR DA FRENTE FIAT STILO 1.2 16V - 1.4 16V - 1.6 16V - 1.8 16V - 1.9D MULTIJET - 1.9JTD - 2.4 20V - (APÓS 10-2001) - MULTI WAGON 1.4 16V - 1.6 16V - 1.8 16V - 1.9D MULTIJET - 1.9JTD (APÓS 2003)		APOIO DO MOTOR PARTE DA FRENTE LADO DIREITO FIAT - STILO (192) - 1.9 JTD (192_XF1A) Hatchback 80CV 1910cc (02-2002 A 11-2006) - 1.9 JTD (192_XE1A) Hatchback 115cv 1910cc (10-2001 A 11-2006) - STILO Multi Wagon (192) - 1.9 JTD Combi 80cv 1910cc (01-2003 A 08-2008) - 1.9 D Multijet Combi 100cv 1910
	122x54mm 1f-d12mm		160x170x170mm 2f-d15.5mm 3f-d16.5mm
	E0176 NO. 50700941 - 50700464		E0213-M NO. 46528871 - 46844208
	ESTICADOR DA BARRA ESTABILIZADORA DA FRENTE FIAT STILO 1.2 - 1.6 - 1.8 16V - 2.4 20V - 1.9 JTD		ESTICADOR DO MOTOR PARTE DE TRÁS FIAT IDEA 1.2 16V (APÓS 01-2004) - 1.4 16V (APÓS 01-2004)
	320x35x35mm 2p-d10-25mm		210x100x35mm 1f-d24mm 1f-d12mm
	E1100 NO. 46810305		E1106 NO. 4629211 - 46546376
	ESTICADOR DE ESCAPE FIAT STILO 1.2 16V (APÓS 02-2002) - 1.6 16V (APÓS 10-2001) - 1.8 16V (APÓS 10-2001) - 1.9 JTD (APÓS 10-2001) - 2 - 4 20V (APÓS 10-2001) - 1.6 16V MULTI WAGON (APÓS 02-2003) - 1.8 16V MULTI WAGON (APÓS 01-2003) - 1.9 JTD MULTI WAGON (APÓS 01-2003)		ESTICADOR DO ESCAPE PARTE DE TRÁS FIAT - IDEA - 1.2 16V Veículo multiuso 80cv 1242cc (APÓS 01-2004) - 1.4 16V 95CV Veículo multiuso 1368cc (APÓS 01-2004) - 1.3 JTD Veículo multiuso 70CV 1248cc (APÓS 01-2004) - 1.3 D Multijet Veículo multiuso 90CV 1248cc (APÓS 10-2005)
	85x94x60mm NULL		55x45x25mm 2f-d10mm
	E1106 NO. 4629211 - 46546376		F1822-I NO. 4315444 - 46307029
	ESTICADOR DO ESCAPE PARTE DE TRÁS FIAT STILO (192) - 1.2 16V (192_XA1B) Hatchback 80CV 1242cc (02-2002 A 11-2006) - 1.4 16V Hatchback 90cv 1368cc (03-1995 A 11-2006) - 1.4 16V Hatchback 95CV 1368cc (01-2004 A 11-2006) - 1.6 16V Hatchback 103CV 1596cc (10-2001 A 11-2006) - 1.8 16V (192_XC1)		FOLE DA TRANSMISSÃO JUNTO À CAIXA FIAT IDEA 1.3JTD16V (APÓS 04)
	55x45x25mm 2f-d10mm		d102x94mm 1f-d99mm 1f-d25mm
	F1822-I NO. 4315444 - 46307029		F1825-I NO. 46307840
	FOLE DA TRANSMISSÃO JUNTO À CAIXA FIAT STILO 1.8i 16V - 1.9JTD (APÓS 2001)		FOLE DA TRANSMISSÃO JUNTO À CAIXA FIAT STILO 1.9 JTD - 2.4i 20V (APÓS 2001)
	d102x94mm 1f-d99mm 1f-d25mm		d95x120mm 1f-d80mm 1f-d23mm

	<p>F9052H-I NO. 46308465</p> <p>FOLE DO CARDAN LADO DA RODA</p> <p>FIAT STILO (192) 1.4 16V (192 B2.000) 90CV (03-2005 A 11-2006)</p> <p>d105x125mm 1f-d28mm 1f-d88mm</p>		<p>KF1752-T NO. 46307733</p> <p>KIT DE FOLE DO CARDAN JUNTO À CAIXA</p> <p>FIAT STILO 1.9 JTD - 1.9 JTD 16V - 2.4i 20V (APÓS 2001)</p> <p>d113x102mm 1f-d87mm 1f-d27mm</p>
	<p>KF3788-T NO. 46307716</p> <p>KIT DE FOLE DO CARDAN JUNTO À RODA</p> <p>FIAT IDEA 1.9 JTD (APÓS 2004)</p> <p>d100x122mm 1f-d83mm 1f-d25mm</p>		<p>P1072 NO. 46828744 - 71748374</p> <p>CAPA DE PEDAL DO TRAVÃO</p> <p>FIAT STILO 1.2 16V (02-2002 A 11-2006) 80CV 1242CC - FIAT STILO 1.6 16V (10-2001 A 11-2006) 103CV 1596CC - FIAT STILO 1.8 16V (10-2001 A 11-2006) 133CV 1747CC - FIAT STILO 1.9 JTD (10-2001 A 11-2006) 115CV 1910CC - FIAT STILO MULTI WAGON 1.6 16V (01-2003)</p> <p>78x54x9mm NULL</p>
	<p>RT08917 NO. 46784455 - 46554126 - 60816986</p> <p>TUBO DE TRAVÃO FRENTE LH-RH</p> <p>FIAT STILO TT APÓS 2001</p> <p>435mm FB53 - MC11</p>		<p>RT08918 NO. 46809898</p> <p>TUBO DE TRAVÃO TRÁS LH-RH</p> <p>FIAT STILO TT APÓS 2001</p> <p>210mm FB23 - MC11</p>
	<p>RT08919 NO. 46809897</p> <p>TUBO DE TRAVÃO INTERMÉDIO</p> <p>FIAT STILO TT APÓS 2001</p> <p>305mm FB23 - FB23</p>		<p>S1143 NO. 50702649</p> <p>SILENT-BLOC DA SUSPENSÃO DE TRÁS</p> <p>FIAT STILO 1.2 (16V) - 1.6 (16V) - 1.8 (16V) - 1.9 JTD (115 CV) - 1.9 JTD (136 CV) - 2.4 (20V)</p> <p>d81x98mm d67mm 1f-d14mm</p>
	<p>S1378 NO. 50700778</p> <p>SILENT-BLOC DO BRAÇO DA SUSPENSÃO DA FRENTE</p> <p>FIAT STILO 1.2(16V) - 1.6(16V) - 1.8(16V) - 1.9 JTD(115CV) - 1.9 JTD(136CV) - 2.4(20V)</p> <p>d60.5x65mm c20mm 1f-d12mm</p>		<p>S1379 NO. 50700443</p> <p>SILENT-BLOC DO BRAÇO DA SUSPENSÃO DA FRENTE</p> <p>FIAT STILO 1.2(16V) - 1.6(16V) - 1.8(16V) - 1.9 JTD(115CV) - 1.9 JTD(136CV) - 2.4(20V)</p> <p>d52x67mm d42mm 1f-d12mm</p>
	<p>S1595 NO. 50511650 - 50521486 - 51783056 - 51783057</p> <p>SILENT-BLOC BRAÇO SUPERIOR FRENTE</p> <p>FIAT STILO (192) 1.2 16 V (192_X A 1 B) (02.02 A 11.06) 80cv 1242cc Hatchback - FIAT STILO (192) 1.4 16 V (03.05 A 11.06) 90cv 1368cc Hatchback - FIAT STILO (192) 1.4 16 V (01.04 A 11.06) 95cv 1368cc Hatchback - FIAT STILO (192) 1.6 16 V (192_X B 1 A) (10.01 A 11.06) 103cv 1596cc Hatchback - FIAT STILO (192_) 1.6 16 V (05.05 A 11.06) 105cv 1598cc Hatchback - FIAT STILO (192) 1.8 16 V (192_X C 1 A) (10.01 A 11.06) 133cv 1747cc Ha...etc.</p> <p>d53x67mm d41mm 1f-d14mm</p>		<p>W5013 NO. 73501275 - 46447843 - 55185409 - 55190424 - 55185403</p> <p>POLIE DA CAMBOTA (6 pistas)</p> <p>FIAT IDEA 1.9 JTD (APÓS 01-2004) - STILO 1.9 JTD (APÓS 10-2001) - STILO 1.9D (APÓS 09-2005)+F108</p> <p>d164.5mm d30.5mm</p>
	<p>W5054 NO. 46819147 - 55200498</p> <p>POLIE DA CAMBOTA (6 PISTAS)</p> <p>FIAT IDEA 1.3 JTD APÓS 2003 - Mtr 188A9000 (70-90CV)</p> <p>d165mm d35mm</p>		<p>W5093 NO. 55208280 - 55196974 - 93191381 - 614571 - 2005302 - 2005758 - 20000281 - 93191382 - 1261019J50 - 551...</p> <p>POLIE DA CAMBOTA (6 PISTAS)</p> <p>FIAT IDEA 1.9 JTD (APÓS 01-2004)</p> <p>d165mm d30.5mm</p>
	<p>Z80502 NO. 5757553</p> <p>Mola de retenção</p> <p>FIAT STILO</p> <p>d16x9.5mm 1p-7x7-8.5mm 1f-d4.8mm</p>		<p>Z80590 NO. 14569187</p> <p>Mola de painel</p> <p>FIAT STILO</p> <p>d22x22.5mm 1p-d10.4-20mm</p>

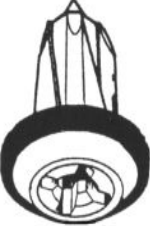
FIAT STILO-IDEA











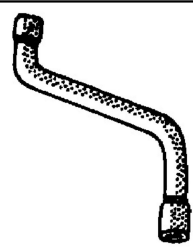

	Z80604	NO. 7739801 - 500382985		Z80605	NO. 7745194
	<i>Mola de painel</i> FIAT STILO			<i>Mola de fixação</i> FIAT STILO	
d18.2x21.6mm		1p-d6.4-16.1mm	d20x20.5mm		1p-d9-18.5mm 1f-7x7mm
	Z80666	NO. 5962559		Z80668	NO. 735266957
	<i>Mola de fixação</i> FIAT STILO			<i>Mola de painel</i> FIAT STILO	
d11x20mm		1p-d6.2-10mm	d20x15.5mm		1p-d8.2-13mm
	Z80674	NO. 46776091		Z80686	NO. 7770156
	<i>Mola de painel</i> FIAT STILO			<i>Mola de friso</i> FIAT STILO	
d18.5x23.5mm		1p-d12-15.5mm	NULL		NULL
	Z80702	NO. 46408953 - 46748771		Z80830	NO. 156070584
	<i>Mola de fixação</i> FIAT STILO			NULL FIAT IDEA	
d16x25.5mm		1p-8x8-24mm 1f-d4.8mm	NULL		NULL

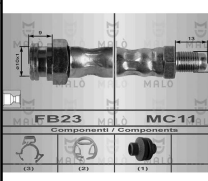
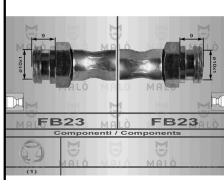
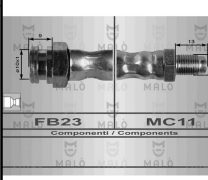
FIAT TEMPRA-REGATA

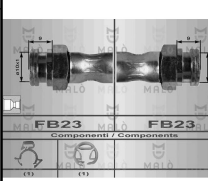











	E0015	NO. 60586017 - 5983764		E0017	NO. 4387293 - 4387294
	<i>ESTICADOR DE ESCAPE</i> FIAT REGATA TT			<i>ESTICADOR DE ESCAPE</i> FIAT REGATA (APÓS 83)	
87x31x26.5mm		NULL	55x45x28mm		NULL
	E0034	NO. 7637572		E0041	NO. 4393777
	<i>ESTICADOR DE ESCAPE</i> FIAT TEMPRA (APÓS 90)			<i>ESTICADOR DE ESCAPE</i> FIAT REGATA (83-86)	
64x33x13mm		NULL	76x64x15mm		NULL
	E1024	NO. 7698769		E1085	NO. 7749062
	<i>ESTICADOR DE ESCAPE</i> FIAT TEMPRA (APÓS 1990)			<i>ESTICADOR DE ESCAPE (PARTE CENTRO)</i> FIAT TEMPRA (1993 A 1996)	
68x43x41mm		2f-d14mm	65x55x25mm		NULL

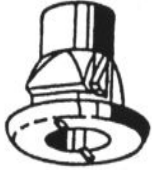

	<p>E1105-I NO. 8052553001401</p> <p>ESTICADOR DE ESCAPE</p> <p>FIAT TEMPRA DIESEL (APÓS 02-1990) - TEMPRA TT (1990 A 07-1992)</p> <p>72x58x43mm NULL</p>		<p>E1152-C NO. 60809242 - 7601647</p> <p>ESTICADOR DA BARRA ESTABILIZADORA DA FRENTE</p> <p>FIAT TEMPRA TT</p> <p>120x35x32mm 1f-d12mm</p>
	<p>E1152-I NO. 7601647 - 60570627 - 60809242</p> <p>ESTICADOR DA BARRA ESTABILIZADORA</p> <p>FIAT TEMPRA TT</p> <p>d36x31mm 1f-d12mm 1p-d10-80mm</p>		<p>F0060-I NO. 4239459 - 4371156</p> <p>FOLE DA CREMALHEIRA DA DIRECÇÃO DIREITO (F1038)</p> <p>FIAT REGATA TT - REGATA TT DIESEL</p> <p>d59x180mm d47mm 1f-d1f-d26mm 1f-d10mm</p>
	<p>F0388-I NO. 4315444</p> <p>FOLE DO DIFERENCIAL</p> <p>FIAT REGATA 100 TURBO DIESEL</p> <p>d77x85mm 1f-d62mm 1f-d24mm</p>		<p>F0389-I NO. 4433969</p> <p>FOLE DO DIFERENCIAL LADO DA RODA</p> <p>FIAT REGATA 85 AUT. - REGATA DIESEL - REGATA 100S (100 cv)</p> <p>d90x82mm 1f-d76mm 1f-22mm</p>
	<p>F0468-I NO. 92601216</p> <p>FOLE ESQUERDO E DIREITO DO DIFERENCIAL COM CASQUILHO EM NYLON</p> <p>FIAT REGATA - 70 - 85 - 100 - DIESEL (ATÉ 3-85)</p> <p>d95x70mm 1f-d63mm 1f-d23mm</p>		<p>F0468B-I NO. 92601255</p> <p>FOLE DO DIFERENCIAL SEMI-EIXO ESQUERDO COM CASQUILHO EM NYLON</p> <p>FIAT REGATA - 70 - 85 - 100 - DIESEL (4-85 A 2-86)</p> <p>d95x73mm 1f-d71mm 1f-d23mm</p>
	<p>F0469-I NO. 43307029 - 82282140</p> <p>FOLE DA TRANSMISSÃO LADO DA CAIXA</p> <p>FIAT TEMPRA 1.8 TURBO DIESEL</p> <p>d85x80mm 1f-d61mm 1f-d23mm</p>		<p>F0514-I NO. 5987092</p> <p>FOLE DO SEMI-EIXO JUNTO À RODA</p> <p>FIAT REGATA 70 - 85</p> <p>d86x82mm 1f-d71mm 1f-d20mm</p>
	<p>F0787-I NO. 92601366</p> <p>FOLE JUNTO À CAIXA</p> <p>FIAT REGATA (3-1986 A 9-1987)</p> <p>d94x76mm 1f-d80mm 1f-d22mm</p>		<p>F0834-I NO. 7621245</p> <p>FOLE DO DIFERENCIAL SEMI-EIXO DIREITO</p> <p>FIAT REGATA (APÓS 10-87)</p> <p>d91x82mm 1f-d65mm 1f-d32mm</p>
	<p>F0834A-I NO. 7621245</p> <p>FOLE DO DIFERENCIAL SEMI-EIXO DIREITO COM ROLAMENTO d23mm</p> <p>FIAT REGATA (APÓS 10-87)</p> <p>d93x90mm 1f-d23mm</p>		<p>F0835-I NO. 7625541</p> <p>FOLE ESQUERDO DO DIFERENCIAL LADO CAIXA</p> <p>FIAT REGATA (APÓS 10-87) - TEMPRA 1370 - 1580 - DIESEL</p> <p>d90x85mm 1f-d77mm 1f-d22.8mm</p>
	<p>F0835A-I NO. 7625541</p> <p>FOLE ESQUERDO DO DIFERENCIAL LADO CAIXA COM ROLAMENTO</p> <p>FIAT REGATA - TEMPRA 1370 - 1580 - DIESEL</p> <p>d90x85mm 1f-d77mm 1f-d22.8mm</p>		<p>F0835A-I NO. 7625541</p> <p>FOLE ESQUERDO DO DIFERENCIAL LADO CAIXA COM ROLAMENTO</p> <p>FIAT TEMPRA 1370 - 1580 - DIESEL</p> <p>d90x85mm 1f-d77mm 1f-d22.8mm</p>

	<p>F0898F65 NO. 7682886</p> <p>FOLE JUNTO À RODA</p> <p>FIAT REGATA 58 DIESEL 1700 MS - PS - 85 S WEEKEND 1600 MAN - POWER 1500 - 1600 - 90 1600 MS - PS - 100 - 1600MS (10-87 A 3-89) - 751 - MANUAL 1500 - TEMPRA 70 - 1400 AUTOMATIC MS - PS (APOS 6-93) - 78 - 1600 AUTOMATIC POWER (12-90 A 6-93) - 113 IE</p> <p>d91x80mm 1f-d65mm 1f-d19mm</p>		<p>F0898F76 NO. 7642776</p> <p>FOLE DO SEMI-EIXO JUNTO À RODA</p> <p>FIAT REGATA (APÓS 10-87)</p> <p>d89x83mm 1f-d76mm 1f-d21mm</p>
	<p>F0903-I NO. 82443745</p> <p>FOLE DO DIFERENCIAL LADO DA RODA</p> <p>FIAT REGATA TURBO DIESEL - TEMPRA 1750 TURBO DIESEL</p> <p>d90x82mm 1f-d76mm 1f-d25mm</p>		<p>F1127H-I NO. 9947369 - 9941582</p> <p>FOLE DA DIREÇÃO ESQUERDO E DIREITO</p> <p>FIAT TEMPRA 1.4ie - 1.6ie - 1.8ie - 1.9D - 1.9TD - 2.0ie (1990 A 1997)</p> <p>d62x210mm 1f-d58mm 1f-d10mm</p>
	<p>F1175-I NO. 7545579 - 7602437</p> <p>FOLE DA DIREÇÃO LADO DIREITO</p> <p>FIAT REGATA 1.3 - 1.5 - 1.5 i.e - 1.6 - 1.6 i.e 1.7 D - 1.9 TD (1983 A 1991)</p> <p>d63x180mm 1f-d45mm 1f-d10mm</p>		<p>F1822-I NO. 4315444 - 46307029</p> <p>FOLE DA TRANSMISSÃO JUNTO À CAIXA</p> <p>FIAT TEMPRA 1.8 i.e. - 1.9TD - 2.0 i.e. - 2.0 i.e.4 X4 (90 A 97)</p> <p>d102x94mm 1f-d99mm 1f-d25mm</p>
	<p>KF1730 NO. 5966569 - 5987092</p> <p>KIT FOLE DO LADO DA RODA</p> <p>FIAT REGATA 70-8 - R86</p> <p>d82x80mm 1f-d20mm 1f-d68mm</p>		<p>KF1775 NO. 7642776</p> <p>KIT FOLE DO LADO DA RODA</p> <p>FIAT REGATA R86 - TEMPRA AUT.</p> <p>d90x79mm 1f-d21mm 1f-d76mm</p>
	<p>L1022 NO. 4227114 - 4223535</p> <p>CASQUILHO DE AMORTECEDOR TRASEIRO</p> <p>FIAT REGATA 70 TT - REGATA 85 S - REGATA 100 S</p> <p>d43x20mm 1f-12mm</p>		<p>M6028 NO. 82407143</p> <p>JUNTA DE ESCAPE</p> <p>FIAT TEMPRA (1993 A 1997)</p> <p>d57x10mm 1f-d47mm</p>
	<p>M6033 NO. 7578742</p> <p>JUNTA DE ESCAPE</p> <p>FIAT REGATA (1987 A 1990) - TEMPRA (1990 A 1997)</p> <p>85x85mm 1f-d54mm</p>		<p>M6038 NO. 7646609 - 7664769 - 7678282 - 4147260 - 5891207 - 4211272</p> <p>JUNTA DE ESCAPE</p> <p>FIAT REGATA (1983 A 1990) - TEMPRA (1990 A 1997)</p> <p>104x76mm 2f-d37mm</p>
	<p>M6042 NO. 4152873 - 4166914 - 82460789 - 4177919 - 7681460</p> <p>JUNTA DE ESCAPE</p> <p>FIAT REGATA (1984 A 1990) - TEMPRA (1990 - A 1992)</p> <p>115x72mm 2f-d40mm</p>		<p>M6074 NO. 82473208 - 82423525</p> <p>JUNTA DE ESCAPE</p> <p>FIAT TEMPRA (1993 A 1997)</p> <p>96x96mm 1f-d53.5mm</p>
	<p>M6094 NO. 7544692 - 7690882</p> <p>JUNTA DE ESCAPE</p> <p>FIAT REGATA (1985 A 1990)</p> <p>d60x13mm 1f-d45mm</p>		<p>N2331 NO. 4422885 - 7610077 - 4437668</p> <p>ANEL ESCAPE</p> <p>FIAT REGATA (1983 A 1990) - TEMPRA (1990 A 1997)</p> <p>d58x14mm 1f-d31mm</p>







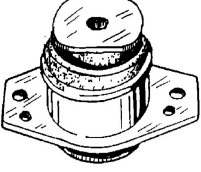
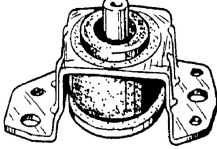
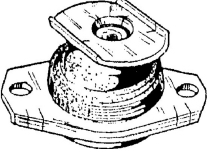

	<p>N3727 NO.</p> <p>ANEL DE ESCAPE</p> <p>FIAT REGATA TT</p> <p>d55x12mm 1f-d31mm</p>		<p>R020802 NO. 7609904</p> <p>TUBO SUPERIOR DO RADIADOR (EXCEPTO VIATURAS C/ AR CONDICIONADO)</p> <p>FIAT TEMPRA (1375 - 1580)</p> <p>B335-d28/32mm 60-190-140mm</p>
	<p>R021813 NO. 4196726 - 4291934 - 7533916 - 7604290</p> <p>TUBO DE LIGAÇÃO DA BOMBA DE ÁGUA À TUBAGEM RÍGIDA DO RADIADOR</p> <p>FIAT REGATA 70 - 70 S - ES - 85 S - R-86 70 - 85 TT</p> <p>B110-d31/35mm 60-80mm</p>		<p>R021916 NO. 5970714</p> <p>TUBO DE LIGAÇÃO DO CORPO AO FILTRO DO AR</p> <p>FIAT REGATA 70 - 70 S - ES - 85S - R-86 70 TT (APOS MOT.5974941=85 DESDE MOT. 6086844) - 85S</p> <p>B300-d20/20mm 40-60-165-110mm</p>
	<p>RF5013 NO. 7596811</p> <p>TUBO DE FERRO RADIADOR</p> <p>FIAT TEMPRA - 1100 - 1370 - 1580</p> <p>B345-d28/28mm 125-220mm+ch30-d13mm+ch25-d10mm</p>		<p>RT08415 NO. 7609087 - 7655156 - 71736962</p> <p>TUBO DE TRAVÃO FRENTE LH-RH</p> <p>FIAT TEMPRA 1.4 - 1.6 8 (-ABS-SW) (03-1990 A 03-1993) - 1.8 - 1.9D - 1.9TD (03-1990 A 04-1995)</p> <p>405mm FB23 - MC11</p>
	<p>RT08417 NO. 7667806</p> <p>TUBO DE TRAVÃO TRÁS LH-RH</p> <p>FIAT TEMPRA TT (03-1990 A 08-1996)</p> <p>240mm FB23 - FB23</p>		<p>RT08459 NO. 46786435 - 7586907</p> <p>TUBO DE TRAVÃO TRÁS LH-RH</p> <p>FIAT TEMPRA 1.4 i.e (03-1991 A 08-1996) - 1.6 (03-1990 A 04-1993) - 1.6 i.e (06-1990 A 08-1996) - 1.8 i.e (03-1992 A 08-1996) - 1.9 D (07-1991 A 08-1996) - 1.9 TD (03-1992 A 06-1993) - 2.0 i.e (01-1991 A 03-1995)</p> <p>182mm FB23 - MC11</p>
	<p>RT08459 NO. 46786435 - 7586907</p> <p>TUBO DE TRAVÃO TRAS LH-RH</p> <p>FIAT TEMPRA S.W. 1.4 i.e. (03-1991 A 08-1996) - 1.6 (12-1990 A 04-1993) - 1.6 i.e. (10-1990 A 08-1996) - 1.8 i.e. (03-1990 A 08-1996) - 1.9 D (07-1991 A 08-1996) - 1.9 TD (03-1992 A 06-1993) - 2.0 i.e. (01-1991 A 03-1995)</p> <p>182mm FB23 - MC11</p>		<p>RT08486 NO. 7670215</p> <p>TUBO DE TRAVÃO TRÁS LH-RH (COM ABS)</p> <p>FIAT TEMPRA 1.4iE - 1.6 - 1.6iE - 1.9D - 1.9TD - 2.0iE (1990 A 1996) - TEMPRA SW (1990 A 1996)</p> <p>245mm FB23 - FB23</p>
	<p>S1161D20 NO. 7601065</p> <p>SILENT-BLOC CENTRAL DO BRAÇO DA SUSPENSÃO DIANTEIRO (DIREITO)</p> <p>FIAT TEMPRA 1.4 i.e. 69CV (03-1992 A 08-1996) - 1.4 i.e. 78CV (03-1991 A 08-1996) - 1.6 i.e 75CV (06-1992 A 08-1996) - 1.6 i.e 78CV (06-1990 A 07-1992) - 1.6 86CV (03-1990 A 04-1993) - 1.6 i. e 90CV (06-1994 A 08-1996) - 1.8 i.e 90CV (09-1993 A 08-1996)</p> <p>120x60x50mm 1f-d20mm 2r-d10mm</p>		<p>S1161D21 NO. 60603027</p> <p>SILENT-BLOC CENTRAL DO BRAÇO DA SUSPENSÃO DIANTEIRO (DIREITO)</p> <p>FIAT TEMPRA 1.4 i.e. 69CV (03-1992 A 08-1996) - 1.4 i.e. 78CV (03-1991 A 08-1996) - 1.6 i.e 75CV (06-1992 A 08-1996) - 1.6 i.e 78CV (06-1990 A 07-1992) - 1.6 86CV (03-1990 A 04-1993) - 1.6 i. e 90CV (06-1994 A 08-1996) - 1.8 i.e 90CV (09-1993 A 08-1996)</p> <p>120x60x50mm 1f-d21mm 2r-d10mm</p>
	<p>S1162E20 NO. 7601068</p> <p>SILENT-BLOC CENTRAL DO BRAÇO DA SUSPENSÃO DIANTEIRO(ESQUERDO)</p> <p>FIAT TEMPRA 1.4 i.e. 69CV (03-1992 A 08-1996) - 1.4 i.e. 78CV (03-1991 A 08-1996) - 1.6 i.e 75CV (06-1992 A 08-1996) - 1.6 i.e 78CV (06-1990 A 07-1992) - 1.6 86CV (03-1990 A 04-1993) - 1.6 i. e 90CV (06-1994 A 08-1996) - 1.8 i.e 90CV (09-1993 A 08-1996)</p> <p>120x60x50mm 1f-d20mm 2r-d10mm</p>		<p>S1162E21 NO. 60603028</p> <p>SILENT-BLOC CENTRAL DO BRAÇO DA SUSPENSÃO DIANTEIRO(ESQUERDO)</p> <p>FIAT TEMPRA 1.4 i.e. 69CV (03-1992 A 08-1996) - 1.4 i.e. 78CV (03-1991 A 08-1996) - 1.6 i.e 75CV (06-1992 A 08-1996) - 1.6 i.e 78CV (06-1990 A 07-1992) - 1.6 86CV (03-1990 A 04-1993) - 1.6 i. e 90CV (06-1994 A 08-1996) - 1.8 i.e 90CV (09-1993 A 08-1996)</p> <p>120x60x50mm 1f-d21mm 2r-d10mm</p>
	<p>S1189F20 NO. 7601064</p> <p>SILENT-BLOC CENTRAL DO BRAÇO DA SUSPENSÃO DIANTEIRO</p> <p>FIAT TEMPRA 1.4 i.e. 69CV (03-1992 A 08-1996) - 1.4 i.e. 78CV (03-1991 A 08-1996) - 1.6 i.e 75CV (06-1992 A 08-1996) - 1.6 i.e 78CV (06-1990 A 07-1992) - 1.6 86CV (03-1990 A 04-1993) - 1.6 i. e 90CV (06-1994 A 08-1996) - 1.8 i.e 90CV (09-1993 A 08-1996) -</p> <p>100x51x46mm 1f-d20mm 2r-d10mm</p>		<p>S1189F21 NO.</p> <p>SILENT-BLOC CENTRAL DO BRAÇO DA SUSPENSÃO DIANTEIRO</p> <p>FIAT TEMPRA 1.4 i.e. 69CV (03-1992 A 08-1996) - 1.4 i.e. 78CV (03-1991 A 08-1996) - 1.6 i.e 75CV (06-1992 A 08-1996) - 1.6 i.e 78CV (06-1990 A 07-1992) - 1.6 86CV (03-1990 A 04-1993) - 1.6 i. e 90CV (06-1994 A 08-1996) - 1.8 i.e 90CV (09-1993 A 08-1996) -</p> <p>100x51x46mm 1f-d21mm 2r-d10mm</p>

	S1252	NO. 7659867		T0647-I	NO. 7588036
	<i>SILENT-BLOC DO CHARRIOT TRASEIRO</i>			<i>BATENTE SUSPENSÃO DA FRENTE</i>	
	FIAT TEMPRA			FIAT TEMPRA (159_) 1.8 i.e. (159.AZ) (09.93 A 08.96) 90cv 1756cc três volumes - FIAT TEMPRA (159_) 1.8 i.e. (159.BY) (10.94 A 08.96) 101cv 1756cc três volumes - FIAT TEMPRA (159_) 1.8 i.e. (159.AV) (09.93 A 08.96) 103cv 1756cc três volumes - FIAT TEMPRA (159_) 1.8 i.e. (159.AN) (03.92 A 08.96) 105cv 1756cc três volumes - FIAT TEMPRA (159_) 2.0 i.e. (159.AP) (10.90 A 08.96) 113cv 1995cc três volumes - FIAT TEMPRA (159_) 1.9 D (159.AG) (0...etc.	
d78x50mm		1f-d12mm	d56x104mm		1f-d27mm 1f-d21mm
	Z10845	NO. 14203080		Z80243	NO. 14187880
	<i>Mola de fixação</i>			<i>Mola de painel</i>	
	FIAT REGATA			FIAT REGATA	
15x15x21mm		1p-11x11-19.5mm 1f-d5.5mm	d17x17.5mm		1p-d8-11.5mm
	Z80245	NO. 4241451		Z80247	NO. 14188380
	<i>Mola de fixação</i>			<i>Mola de painel</i>	
	FIAT REGATA			FIAT REGATA	
d14x18mm		1p-7.5x6-9mm	d16x18.6mm		1p-d7.5-12.6mm
	Z80466	NO. 5944525		Z80499	NO. 4399987
	<i>Mola de fixação</i>			<i>Mola de painel</i>	
	FIAT REGATA			FIAT REGATA	
15x9x14mm		1p-d5.5-5mm	d19.5x18mm		1p-d8-10.8mm
	Z80510	NO. 7538675		Z80513	NO. 7544349
	<i>Mola de painel</i>			<i>Mola de fixação</i>	
	FIAT REGATA			FIAT REGATA	
d16x17mm		1p-d8.8-11mm	NULL		NULL
	Z80519	NO. 4358789		Z80528	NO. 7603826 - 16400631250
	<i>Mola de fixação</i>			<i>Mola de painel</i>	
	FIAT REGATA			FIAT TEMPRA	
d11x9mm		1p-d8.5-7.8mm 1f-d3mm	d18x21.5mm		1p-d6-16mm
	Z80529	NO. 7603826		Z80547	NO. 82407538
	<i>Mola de fixação</i>			<i>Mola de friso</i>	
	FIAT Temptra			FIAT TEMPRA	
d18.5x20mm		1p-d9-18mm 1f-d6mm	NULL		NULL
	Z80548	NO. 7658893		Z80552	NO.
	<i>Mola de painel</i>			<i>Mola de fixação</i>	
	FIAT TEMPRA			FIAT Temptra	
d16x22.5mm		1p-d7.4-17.1mm	NULL		NULL

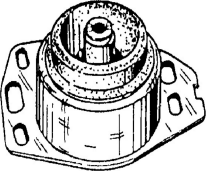
	<p>Z80586 NO. 82448727</p> <p>Mola de fixação</p> <p>FIAT TEMPRA</p> <p>d12.8x22.5mm 1p-d6.5-8.5mm</p>		<p>Z80588 NO. 7637466</p> <p>Mola de painel</p> <p>FIAT TEMPRA</p> <p>d24x16.5mm 1p-d16.5-14mm</p>
	<p>Z80612 NO. 7569468</p> <p>Mola de fixação</p> <p>FIAT TEMPRA</p> <p>d10x33.7mm 1p-d6-18.5mm</p>		<p>Z80625 NO. 82421028 - 504056662</p> <p>Mola de fixação</p> <p>FIAT TEMPRA</p> <p>d18x42.5mm 1p-d8-19mm</p>
	<p>Z80635 NO. 14216080 - 14216087</p> <p>Mola de fixação</p> <p>FIAT TEMPRA</p> <p>d18x14mm 1p-10x10-12.5mm 1f-d4.8mm</p>		<p>Z80638 NO. 7638283</p> <p>Mola de painel</p> <p>FIAT TEMPRA</p> <p>d25x19.5mm 1p-d8-17mm</p>
	<p>Z80646 NO. 7578051</p> <p>Mola de fixação</p> <p>FIAT TEMPRA</p> <p>13x17.8x15mm 1p-9x14-14mm 1f-d5.5mm</p>		<p>Z80647 NO. 14222380</p> <p>Mola de fixação</p> <p>FIAT TEMPRA</p> <p>12.5x12.5x19.2mm 1p-9.5x9.5-18mm 1f-d4.8mm</p>
	<p>Z80651 NO. 82426359</p> <p>Mola de fixação</p> <p>FIAT TEMPRA</p> <p>d18x42mm 1p-d10-19mm</p>		<p>Z80653 NO. 14211580</p> <p>Mola de fixação</p> <p>FIAT REGATA</p> <p>9x9x10mm 1p-7x7-9mm 1f-d4.2mm</p>
	<p>Z80654 NO. 7556533</p> <p>Mola de fixação</p> <p>FIAT TEMPRA</p> <p>d12.8x28mm 1p-d6.2-11.5mm</p>		<p>Z80666 NO. 5962559</p> <p>Mola de fixação</p> <p>FIAT TEMPRA</p> <p>d11x20mm 1p-d6.2-10mm</p>
	<p>Z80675 NO. 182911680</p> <p>Mola de painel</p> <p>FIAT TEMPRA</p> <p>d20x24.4mm 1p-d9.5-10.6mm</p>		<p>Z80703 NO. 5988006</p> <p>Mola de fixação</p> <p>FIAT TEMPRA</p> <p>d15x24mm 1p-d6.5-12mm</p>
	<p>Z80705 NO. 14191280 - 82377183</p> <p>Mola de painel</p> <p>FIAT TEMPRA</p> <p>d21x22.5mm 1p-d7.5-15.5mm</p>		<p>Z80708 NO. 7630854</p> <p>Mola de fixação</p> <p>FIAT TEMPRA</p> <p>d15x8.2mm 1p-6x6-6.6mm 1f-d4.8mm</p>

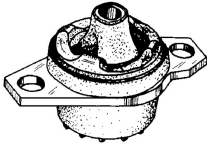



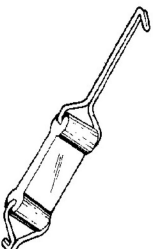
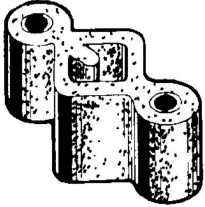





	Z80851	NO. 7688808		Z9002	NO. 7619712 - 7681592 - 82372840
	Mola Fiat Tempra			MOLA DE ESCAPE 34mm FIAT REGATA (1968 A 1990) - TEMPRA (1990 A 1992)	
	22x12.3x13mm	1p-d6.5-10mm		d21x34mm	NULL

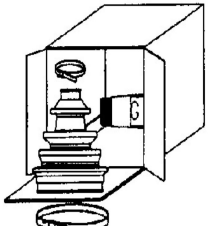
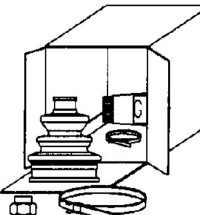
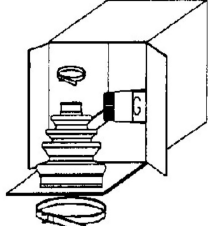
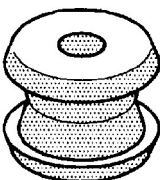
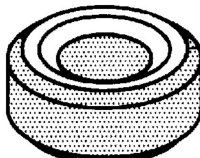
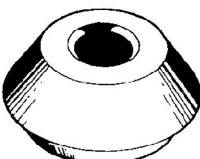









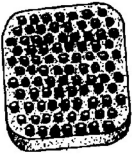

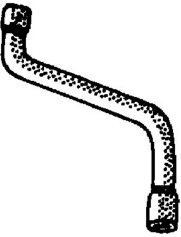

FIAT TIPO-RITMO

	A0963-I	NO. 7594993		A0964-I	NO. 7610541
	SUPORTE FRENTE DO MOTOR FIAT TIPO 1100			APOIO FRENTE DO MOTOR (LADO DISTRIBUIÇÃO) FIAT TIPO 1400 - 1600	
	135x80x67mm	1f-d10mm		166x87x72mm	1f-d10mm
	A0966-I	NO. 7629021		A0967-I	NO. 7642540 - 7652240 - 60808861
	SUPORTE DO MOTOR CENTRAL FIAT TIPO 1100 - 1400 - 1600			SUPORTE TRÁS DO MOTOR FIAT TIPO D - TD - TT	
	170x104x66mm	1f-d16mm 1f-d10.4mm		170x103x68mm	1f-d16mm 1r-d11mm
	A0968-I	NO. 7610157		A1001	NO. 4433964 - 4394531
	SUPORTE TRÁS DO MOTOR FIAT TIPO 1100 - 1400 - 1600 - DIESEL			SUPORTE DE MOTOR LADO DA CAIXA FIAT RITMO DIESEL	
	170x110x60mm	1f-d10mm		138x80x48mm	1f-d12mm
	A1003	NO. 5972162 - 4433965 - 4394538		A1005	NO. 4433963 - 4394522
	SUPORTE DO MOTOR LADO DIFERENCIAL FIAT RITMO 1.6 - 2.0 (GASOLINA) - 1.7 (DIESEL)			SUPORTE DE MOTOR LADO DA CORREIA FIAT RITMO	
	130x80x65mm	1f-d12mm		135x80x48mm	1f-d12/15mm
	A1957	NO. 4400895 - 4400905 - 7635775		C0229	NO. 100816 - 4276430
	APOIO AMORTECEDOR FRENTE DIREITO ESQUERDO FIAT RITMO Cabriolet (138_) 85 1.5 Ano fabric. at é: 09.82, Posição/grau: 1 ° (01.80 A 07.89) 86cv 1498cc Cabriolet - FIAT RITMO (138_) 1.0 Posição/grau: 1 ° (09.78 A 09.82) 60cv 1049cc Hatchback - FIAT RITMO (138_) 1.3 Posição/grau: 1 ° (01.78 A 08.85) 65cv 1301cc Hatchback - FIAT RITMO (138_) 1.3 Posição/grau: 1 ° (01.81 A 09.82) 75cv 1301cc Hatchback - FIAT RITMO (138_) 1.5 Posição/grau: 1 ° (01.81 A 05.87) 85cv 1498cc...etc.			BOTÃO DE AFINAÇÃO DO CAPOT (GRANDE) FIAT ABARTH RITMO (138A_) 130 TC 2.0 Local de montagem: à frente e atrás 96kW 130CV 1995cc Hatchback (DE 04-83 ATÉ 12-87)	
	120x100x38mm	1f-d12mm 2p-d8x18mm		d18x44mm	NULL
	E0002	NO. 4214979		E0003	NO. 4296059 - 4312280 - 4306054 - 4422065 - 4297082 - 421281 - 4296060
	ESTICADOR DE ESCAPE FIAT RITMO			ESTICADOR DE ESCAPE FIAT RITMO	
	190x30x15mm	NULL		80x35x37mm	NULL

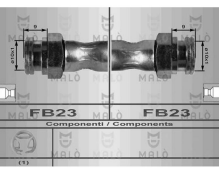

	<p>E0017 NO. 4387293 - 4387294</p> <p>ESTICADOR DE ESCAPE</p> <p>FIAT RITMO (78 A 83) - TIPO</p> <p>55x45x28mm NULL</p>		<p>E0034 NO. 7637572</p> <p>ESTICADOR DE ESCAPE</p> <p>FIAT TIPO (APÓS 88)</p> <p>64x33x13mm NULL</p>
	<p>E0041 NO. 4393777</p> <p>ESTICADOR DE ESCAPE</p> <p>FIAT RITMO 11 (82-83) - FIAT RITMO II - 111 (83-89)</p> <p>76x64x15mm NULL</p>		<p>E0042 NO. 7600807</p> <p>ESTICADOR DE ESCAPE</p> <p>FIAT TIPO (APÓS 88)</p> <p>73x45x40mm NULL</p>
	<p>E1005 NO. 068198821A</p> <p>ESTICADOR DE ESCAPE</p> <p>FIAT RITMO - TIPO</p> <p>60x45x14mm NULL</p>		<p>E1024 NO. 7698769</p> <p>ESTICADOR DE ESCAPE</p> <p>FIAT TIPO</p> <p>68x43x41mm 2f-d14mm</p>
	<p>E1105-I NO. 7L6868243</p> <p>ESTICADOR DE ESCAPE</p> <p>FIAT TIPO</p> <p>72x58x43mm NULL</p>		<p>E1152-C NO. 60809242 - 7601647</p> <p>ESTICADOR DA BARRA ESTABILIZADORA DA FRENTE</p> <p>FIAT TIPO TT</p> <p>120x35x32mm 1f-d12mm</p>
	<p>E1152-I NO. 7601647 - 60570627 - 60809242</p> <p>ESTICADOR DA BARRA ESTABILIZADORA</p> <p>FIAT TIPO</p> <p>d36x31mm 1f-d12mm 1p-d10-80mm</p>		<p>F0057-I NO. 4294117</p> <p>FOLE DO DIFERENCIAL LADO DA CAIXA (F1012)</p> <p>FIAT RITMO TT</p> <p>d95x85mm 1f-d65mm 1f-d23mm</p>
	<p>F0060-I NO. 4239459 - 4371156</p> <p>FOLE DA CREMALHEIRA DA DIRECÇÃO DIREITO (F1038)</p> <p>FIAT RITMO</p> <p>d59x180mm d47mm 1f-d1f-d26mm 1f-d10mm</p>		<p>F0388-I NO. 4315444</p> <p>FOLE DO DIFERENCIAL</p> <p>FIAT TIPO TURBO DIESEL - RITMO 105 - NOVO RITMO - RITMO TURBO DIESEL</p> <p>d77x85mm 1f-d62mm 1f-d24mm</p>
	<p>F0389-I NO. 4433969</p> <p>FOLE DO DIFERENCIAL LADO DA RODA</p> <p>FIAT RITMO</p> <p>d90x82mm 1f-d76mm 1f-22mm</p>		<p>F0403-I NO. 4383758</p> <p>FOLE DO SEMI-EIXO JUNTO À RODA</p> <p>FIAT RITMO</p> <p>d80x80mm 1f-d70mm 1f-d20mm</p>
	<p>F0468-I NO. 92601216</p> <p>FOLE ESQUERDO E DIREITO DO DIFERENCIAL COM CASQUILHO EM NYLON</p> <p>FIAT RITMO</p> <p>d95x70mm 1f-d63mm 1f-d23mm</p>		<p>F0468B-I NO. 92601255</p> <p>FOLE DO DIFERENCIAL SEMI-EIXO ESQUERDO COM CASQUILHO EM NYLON</p> <p>FIAT NOVO RITMO FL 25</p> <p>d95x73mm 1f-d71mm 1f-d23mm</p>



	F0469-I NO. 43307029 - 82282140 FOLE DA TRANSMISSÃO LADO DA CAIXA FIAT TIPO 1.6 2ACT - SPORT 1.6 16Vie - 2.0 TURBO DIESEL (APÓS 1990)		F0479-I NO. HH-14153100 FOLE DA TRANSMISSÃO JUNTO À CAIXA (COM CASQUILHO DE NYLON LISO FURO 25mm) FIAT RITMO 60 - RITMO 65
d85x80mm	1f-d61mm 1f-d23mm	d96x72mm	1f-d66mm 1f-d25mm
	F0514-I NO. 5987092 FOLE DO SEMI-EIXO JUNTO À RODA FIAT RITMO (APÓS 1-84) - NOVO RITMO		F0787-I NO. 92601366 FOLE JUNTO À CAIXA FIAT RITMO FL 85
d86x82mm	1f-d71mm 1f-d20mm	d94x76mm	1f-d80mm 1f-d22mm
	F0834-I NO. 7621245 FOLE DO DIFERENCIAL SEMI-EIXO DIREITO FIAT RITMO FL 85		F0834A-I NO. 7621245 FOLE DO DIFERENCIAL SEMI-EIXO DIREITO COM ROLAMENTO d23mm FIAT RITMO FL 85
d91x82mm	1f-d65mm 1f-d32mm	d93x90mm	1f-d23mm
	F0835-I NO. 7625541 FOLE ESQUERDO DO DIFERENCIAL LADO CAIXA FIAT RITMO FL 85		F0835-I NO. 7625541 FOLE ESQUERDO DO DIFERENCIAL LADO CAIXA FIAT TIPO 1100 - 1370 - 1580 DIESEL
d90x85mm	1f-d77mm 1f-d22.8mm	d90x85mm	1f-d77mm 1f-d22.8mm
	F0835A-I NO. 7625541 FOLE ESQUERDO DO DIFERENCIAL LADO CAIXA COM ROLAMENTO FIAT RITMO FL 85 - TIPO 1100 - 1370 - 1580 DIESEL		F0897-I NO. 82483504 FOLE JUNTO À RODA FIAT TIPO TURBO DIESEL
d90x85mm	1f-d77mm 1f-d22.8mm	d100x98mm	1f-d86mm 1f-d26mm
	F0898F65 NO. 7682886 FOLE JUNTO À RODA FIAT TIPO 77 IES - SX SUT. POWER 1600 (APÓS 6-93)		F0903-I NO. 82443745 FOLE DO DIFERENCIAL LADO DA RODA FIAT TIPO TD (SEM ANTIDISK)
d91x80mm	1f-d65mm 1f-d19mm	d90x82mm	1f-d76mm 1f-d25mm
	F0972-I NO. 7607086 FOLE DO AMORTECEDOR FIAT TIPO T.T.		F1043-18 NO. 5963824 FOLE DO AMORTECEDOR DA SUSPENSÃO FRENTE FIAT RITMO TT (EXCPT. 130TC)(SDE 10-82)
d74x196mm	1f-d61mm 1f-d16mm	d75x145mm	1f-d68mm 1f-d18mm
	F1057 NO. 4382001 FOLE DO DEPÓSITO DE GASOLINA FIAT RITMO TT (ATÉ 9-82)		F1126-I NO. 7566840 FOLE DA DIREÇÃO DIREITO E ESQUERDO (VIAT. SEM DIR. ASSISTIDA) FIAT TIPO
d73x73mm	2f-d49mm	d63x120mm	1f-d41mm 1f-d9mm

	<p>F1127H-I NO. 9947369 - 9941582</p> <p>FOLE DA DIREÇÃO ESQUERDO E DIREITO</p> <p>FIAT TIPO 1.4 - 1.6ie 1.7D - 1.8ie - 1.9D - 1.9TD - 2.0ie - 2.0</p> <p>d62x210mm 1f-d58mm 1f-d10mm</p>		<p>F1822-I NO. 4315444 - 46307029</p> <p>FOLE DA TRANSMISSÃO JUNTO À CAIXA</p> <p>FIAT TIPO 1.4 - 1.6 i.e. - 1.8 i.e. - 1.9TD - 2.0 16V - 2.0 i.e. - 2.0 i.e. SPORT 16V (87 A 95)</p> <p>d102x94mm 1f-d99mm 1f-d25mm</p>
	<p>H305 NO.</p> <p>PALA ORIGINAL FIAT TIPO</p> <p>FIAT TIPO</p> <p>370x205mm NULL</p>		<p>KF1715 NO. 7635255</p> <p>KIT FOLE DO LADO DA RODA</p> <p>FIAT TIPO - TEMPRA</p> <p>d92x105mm 1f-d20mm 1f-d75mm</p>
	<p>KF1730 NO. 5966569 - 5987092</p> <p>KIT FOLE DO LADO DA RODA</p> <p>FIAT RITMO 60 - 65 - DIESEL - NUOVA RITMO</p> <p>d82x80mm 1f-d20mm 1f-d68mm</p>		<p>KF1775 NO. 7642776</p> <p>KIT FOLE DO LADO DA RODA</p> <p>FIAT TIPO AUT.</p> <p>d90x79mm 1f-d21mm 1f-d76mm</p>
	<p>L1001 NO. 4292059</p> <p>CASQUILHO DO BRAÇO DA SUSPENSÃO FRENTE</p> <p>FIAT RITMO TT - NOVO RITMO TT</p> <p>d30x39mm d25mm 1f-d9mm</p>		<p>L1011 NO. 4240587 - 4207922</p> <p>CASQUILHO DO BRAÇO DA SUSPENSÃO (PONTAS DA BARRA ESTABILIZADORA)</p> <p>FIAT RITMO</p> <p>d34x21mm 1f-d16mm</p>
	<p>L1022 NO. 4227114 - 4223535</p> <p>CASQUILHO DE AMORTECEDOR TRASEIRO</p> <p>FIAT RITMO TT - RITMO DIESEL</p> <p>d43x20mm 1f-12mm</p>		<p>M6028 NO. 82407143</p> <p>JUNTA DE ESCAPE</p> <p>FIAT TIPO (1993 A 1995)</p> <p>d57x10mm 1f-d47mm</p>
	<p>M6033 NO. 7578742</p> <p>JUNTA DE ESCAPE</p> <p>FIAT RITMO (1987 A 1988) - TIPO (1989 A 1995)</p> <p>85x85mm 1f-d54mm</p>		<p>M6038 NO. 7646609 - 7664769 - 7678282 - 4147260 - 5891207 - 4211272</p> <p>JUNTA DE ESCAPE</p> <p>FIAT RITMO (1978 A 1989) - TIPO (1988 A 1995)</p> <p>104x76mm 2f-d37mm</p>
	<p>M6042 NO. 4152873 - 4166914 - 82460789 - 4177919 - 7681460</p> <p>JUNTA DE ESCAPE</p> <p>FIAT TIPO (1988 A 1995)</p> <p>115x72mm 2f-d40mm</p>		<p>M6074 NO. 82473208 - 82423525</p> <p>JUNTA DE ESCAPE</p> <p>FIAT TIPO (1993 A 1995)</p> <p>96x96mm 1f-d53.5mm</p>
	<p>M6094 NO. 7544692 - 7690882</p> <p>JUNTA DE ESCAPE</p> <p>FIAT RITMO (1985 A 1988)</p> <p>d60x13mm 1f-d45mm</p>		<p>N2331 NO. 4422885 - 4437668 - 7610077</p> <p>ANEL ESCAPE</p> <p>FIAT TIPO (1988 A 1995)</p> <p>d58x14mm 1f-d31mm</p>

	<p>P0009-R NO. 4144275</p> <p>CAPA DE PEDAL TRAVÃO E EMBRAIAGEM</p> <p>FIAT RITMO 60CL - 65CL - 75 SUPER - 85 - DIESEL(APOS 7-79)</p> <p>63x50x12mm NULL</p>		<p>P1016 NO. 4144275</p> <p>CAPA DE PEDAL DO TRAVÃO E EMBRAIAGEM</p> <p>FIAT RITMO</p> <p>65x50x10mm NULL</p>
	<p>P1052 NO. 4144275</p> <p>CAPA DE PEDAL DO TRAVÃO E EMBRAIAGEM</p> <p>FIAT RITMO 60 - 65 - 75 - 75 S 1A SÉRIE</p> <p>67x53x12mm NULL</p>		<p>R020802 NO. 7609904</p> <p>TUBO SUPERIOR DO RADIADOR (EXCEPTO VIATURAS C/ AR CONDICIONADO)</p> <p>FIAT TIPO (1370 - 1580)</p> <p>B335-d28/32mm 60-190-140mm</p>
	<p>R021813 NO. 4196726 - 4291934 - 7533916 - 7604290</p> <p>TUBO DE LIGAÇÃO DA BOMBA DE ÁGUA À TUBAGEM RÍGIDA DO RADIADOR</p> <p>FIAT RITMO TT - N. RITMO - FL85 60 - 70 - 85 TT</p> <p>B110-d31/35mm 60-80mm</p>		<p>R021916 NO. 5970714</p> <p>TUBO DE LIGAÇÃO DO CORPO AO FILTRO DO AR</p> <p>FIAT N. RITMO 60- ES - SUPER (70 - 85) - RITMO FL85 60 - 70 - 85(APOS MOTOR 5974941 - 85 A MOT. 6114921)</p> <p>B300-d20/20mm 40-60-165-110mm</p>
	<p>R2468 NO. 5959468 - M-21917</p> <p>TUBO SUPERIOR DO RADIADOR</p> <p>FIAT RITMO TT 60/70</p> <p>B360-d33/33mm 85-115-115-105mm</p>		<p>RF5013 NO. 7596811</p> <p>TUBO DE FERRO RADIADOR</p> <p>FIAT TIPO 1.4 - 1.6 - 1.4ie - 1.6ie</p> <p>B345-d28/28mm 125-220mm+ch30-d13mm+ch25-d10mm</p>
	<p>RT08352 NO. 5955862 - 5971061 - 7563849 - 7569161 - 7729198 - 5965862 - 71736965</p> <p>TUBO DE TRAVÃO FRENTE LH-RH</p> <p>FIAT RITMO 1.5 - 105 TC (05-1978 A 10-1982)</p> <p>436mm FB23 - MC11</p>		<p>RT08415 NO. 7609087 - 7655156 - 71736962</p> <p>TUBO DE TRAVÃO FRENTE LH-RH</p> <p>FIAT TIPO 1.6 - 1.8 - 1.9TD - 2.0 (02-1988 A 1995)</p> <p>405mm FB23 - MC11</p>
	<p>RT08417 NO. 7667806</p> <p>TUBO DE TRAVÃO TRÁS LH-RH</p> <p>FIAT TIPO 1.7D (02-1988 A 02-1993)- 1.8 (02-1988 A 02-1993) - 1.8 16V - 2.0 16V - (02-1988 A 02-1993) - 1.8 - 1.8 16V - 2.0 - 2.0 16V - 1.7D - 1.9D - 1.9 TD - 2.0 (02-1988 A 02-1993) - TT (03-1993 A 04-1995)</p> <p>240mm FB23 - FB23</p>		<p>RT08459 NO. 46786435 - 7586907</p> <p>TUBO DE TRAVÃO TRÁS LH-RH</p> <p>FIAT TIPO 1.4 (07-1987 A 12-1989) - 1.4 i.e.(05-1989 A 04-1995) - 1.6 (01-1988 A 10-1991) - 1.6 i.e (02-1988 A 04-1995) - 1.7 D (01-1988 A 10-1995) - 1.8 i.e (10-1990 A 04-1995) - 1.8 i.e. 16V SPORT (11-1989 A 06-1992) - 1.9 D (07-1991 A 08-1996) - 1.9 TD</p> <p>182mm FB23 - MC11</p>
	<p>RT08486 NO. 7670215</p> <p>TUBO DE TRAVÃO TRÁS LH-RH (COM ABS)</p> <p>FIAT TIPO 1.4 - 1.4iE - 1.6 - 1.6iE - 1.7D - 1.9D - 1.9TD (1987 A 1995)</p> <p>245mm FB23 - FB23</p>		<p>S1161D20 NO. 7601065</p> <p>SILENT-BLOC CENTRAL DO BRAÇO DA SUSPENSÃO DIANTEIRO (DIREITO)</p> <p>FIAT TIPO 1.1 56CV (01-1988 A 10-1991) - 1.4 i.e. 70CV (05-1989 A 04-1995) - 1.4 71CV (07-1987 A 12-1989) - 1.4 i.e. 78CV (05-1989 A 04-1995) - 1.6 i.e. 75CV (10-1992 A 04-1995) - 1.6 i.e. 78CV (07-1990 A 01-1993) - 1.6 83CV (01-1988 A 10-1991) - 1.6 i.e</p> <p>120x60x50mm 4f-d20mm 2r-d10mm</p>
	<p>S1161D21 NO. 60603027</p> <p>SILENT-BLOC CENTRAL DO BRAÇO DA SUSPENSÃO DIANTEIRO (DIREITO)</p> <p>FIAT TIPO 1.1 56CV (01-1988 A 10-1991) - 1.4 i.e. 70CV (05-1989 A 04-1995) - 1.4 71CV (07-1987 A 12-1989) - 1.4 i.e. 78CV (05-1989 A 04-1995) - 1.6 i.e. 75CV (10-1992 A 04-1995) - 1.6 i.e. 78CV (07-1990 A 01-1993) - 1.6 83CV (01-1988 A 10-1991) - 1.6 i.e</p> <p>120x60x50mm 1f-d21mm 2r-d10mm</p>		<p>S1162E20 NO. 7601068</p> <p>SILENT-BLOC CENTRAL DO BRAÇO DA SUSPENSÃO DIANTEIRO(ESQUERDO)</p> <p>FIAT TIPO 1.1 56CV (01-1988 A 10-1991) - 1.4 i.e. 70CV (05-1989 A 04-1995) - 1.4 71CV (07-1987 A 12-1989) - 1.4 i.e. 78CV (05-1989 A 04-1995) - 1.6 i.e. 75CV (10-1992 A 04-1995) - 1.6 i.e. 78CV (07-1990 A 01-1993) - 1.6 83CV (01-1988 A 10-1991) - 1.6 i.e</p> <p>120x60x50mm 1f-d20mm 2r-d10mm</p>









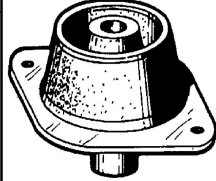
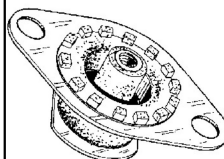
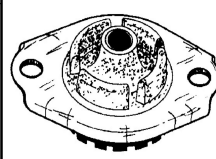
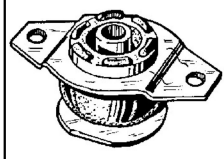
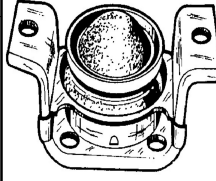

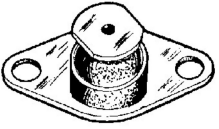
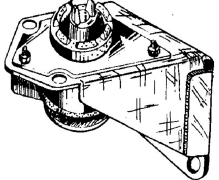
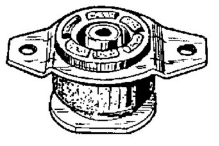
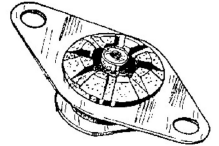
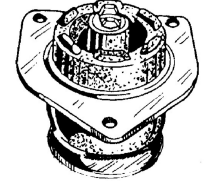
	<p>S1162E21 NO. 60603028</p> <p>SILENT- BLOC CENTRAL DO BRAÇO DA SUSPENSÃO DIANTEIRO(ESQUERDO)</p> <p>FIAT TIPO 1.1 56CV (01-1988 A 10-1991) - 1.4 i.e. 70CV (05-1989 A 04-1995) - 1.4 71CV (07-1987 A 12-1989) - 1.4 i.e. 78CV (05-1989 A 04-1995) - 1.6 i.e. 75CV (10-1992 A 04-1995) - 1.6 i.e. 78CV (07-1990 A 01-1993) - 1.6 83CV (01-1988 A 10-1991) - 1.6 i.e</p> <p>120x60x50mm 1f-d21mm 2r-d10mm</p>		<p>S1189F20 NO. 7601064</p> <p>SILENT- BLOC CENTRAL DO BRAÇO DA SUSPENSÃO DIANTEIRO</p> <p>FIAT TIPO 1.1 56CV (01-1988 A 10-1991) - 1.4 i.e. 70CV (05-1989 A 04-1995) - 1.4 71CV (07-1987 A 12-1989) - 1.4 i.e. 78CV (05-1989 A 04-1995) - 1.6 i.e. 75CV (10-1992 A 04-1995) - 1.6 i.e. 78CV (07-1990 A 01-1993) - 1.6 83CV (01-1988 A 10-1991) - 1.6 i.e.</p> <p>100x51x46mm 1f-d20mm 2r-d10mm</p>
	<p>S1189F21 NO.</p> <p>SILENT- BLOC CENTRAL DO BRAÇO DA SUSPENSÃO DIANTEIRO</p> <p>FIAT TIPO 1.1 56CV (01-1988 A 10-1991) - 1.4 i.e. 70CV (05-1989 A 04-1995) - 1.4 71CV (07-1987 A 12-1989) - 1.4 i.e. 78CV (05-1989 A 04-1995) - 1.6 i.e. 75CV (10-1992 A 04-1995) - 1.6 i.e. 78CV (07-1990 A 01-1993) - 1.6 83CV (01-1988 A 10-1991) - 1.6 i.e.</p> <p>100x51x46mm 1f-d21mm 2r-d10mm</p>		<p>S1252 NO. 7659867</p> <p>SILENT-BLOC DO CHARRIOT TRASEIRO</p> <p>FIAT TIPO</p> <p>d78x50mm 1f-d12mm</p>
	<p>T0647-I NO. 7588036</p> <p>BATENTE SUSPENSÃO DA FRENTE</p> <p>FIAT TIPO (160_) 1.9 TD (160.AW) 03.92 - 06.93 59 80 1929 Hatchback FIAT TIPO (160_) 1.9 TD (160.EL - 160.GL - 160.AQ - 160.EI - 160.AR) 09.90 - 04.95 66 90 1929 Hatchback</p> <p>d56x104mm 1f-d27mm 1f-d21mm</p>		<p>T1026 NO. 7635711</p> <p>BATENTE DA BARRA ESTABILIZADORA</p> <p>FIAT TIPO TT (EXCEPTO 1100) (APÓS 3-1988)</p> <p>60x47x47mm 1f-d20mm</p>
	<p>Z10845 NO. 14203080</p> <p>Mola de fixação</p> <p>FIAT Ritmo</p> <p>15x15x21mm 1p-11x11-19.5mm 1f-d5.5mm</p>		<p>Z80243 NO. 14187880</p> <p>Mola de painel</p> <p>FIAT RITMO</p> <p>d17x17.5mm 1p-d8-11.5mm</p>
	<p>Z80245 NO. 4241451</p> <p>Mola de fixação</p> <p>FIAT RITMO</p> <p>d14x18mm 1p-7.5x6-9mm</p>		<p>Z80247 NO. 14188380</p> <p>Mola de painel</p> <p>FIAT RITMO</p> <p>d16x18.6mm 1p-d7.5-12.6mm</p>
	<p>Z80466 NO. 5944525</p> <p>Mola de fixação</p> <p>FIAT RITMO</p> <p>15x9x14mm 1p-d5.5-5mm</p>		<p>Z80499 NO. 4399987</p> <p>Mola de painel</p> <p>FIAT RITMO</p> <p>d19.5x18mm 1p-d8-10.8mm</p>
	<p>Z80510 NO. 7538675</p> <p>Mola de painel</p> <p>FIAT RITMO</p> <p>d16x17mm 1p-d8.8-11mm</p>		<p>Z80513 NO. 7544349</p> <p>Mola de fixação</p> <p>FIAT RITMO</p> <p>NULL NULL</p>
	<p>Z80519 NO. 4358789</p> <p>Mola de fixação</p> <p>FIAT RITMO</p> <p>d11x9mm 1p-d8.5-7.8mm 1f-d3mm</p>		<p>Z80528 NO. 7603826 - 16400631250</p> <p>Mola de painel</p> <p>FIAT TIPO</p> <p>d18x21.5mm 1p-d6-16mm</p>

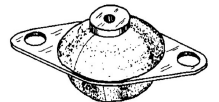
	Z80529 NO. 7603826 <i>Mola de fixação</i> Fiat Tipo d18.5x20mm 1p-d9-18mm 1f-d6mm		Z80547 NO. 82407538 <i>Mola de friso</i> FIAT TIPO NULL NULL
	Z80548 NO. 7658893 <i>Mola de painel</i> FIAT TIPO d16x22.5mm 1p-d7.4-17.1mm		Z80552 NO. <i>Mola de fixação</i> Fiat Tipo NULL NULL
	Z80578 NO. 14569580 - 14569680 <i>Mola de fixação</i> FIAT TIPO (Após 1993) 20x8x15mm 1f-8mm		Z80588 NO. 7637466 <i>Mola de painel</i> FIAT TIPO d24x16.5mm 1p-d16.5-14mm
	Z80604 NO. 7739801 - 500382985 <i>Mola de painel</i> FIAT TIPO d18.2x21.6mm 1p-d6.4-16.1mm		Z80612 NO. 7569468 <i>Mola de fixação</i> FIAT TIPO d10x33.7mm 1p-d6-18.5mm
	Z80619 NO. 7677865 <i>Mola de painel</i> FIAT TIPO d14x12mm 1p-d7.5-10mm		Z80625 NO. 82421028 - 504056662 <i>Mola de fixação</i> FIAT TIPO d18x42.5mm 1p-d8-19mm
	Z80635 NO. 14216080 - 14216087 <i>Mola de fixação</i> FIAT TIPO d18x14mm 1p-10x10-12.5mm 1f-d4.8mm		Z80637 NO. 7788400 <i>Mola de fixação</i> FIAT TIPO d30x31.7mm 1p-d19-29mm
	Z80638 NO. 7638283 <i>Mola de painel</i> FIAT TIPO d25x19.5mm 1p-d8-17mm		Z80646 NO. 7578051 <i>Mola de fixação</i> FIAT TIPO 13x17.8x15mm 1p-9x14-14mm 1f-d5.5mm
	Z80651 NO. 82426359 <i>Mola de fixação</i> FIAT TIPO d18x42mm 1p-d10-19mm		Z80653 NO. 14211580 <i>Mola de fixação</i> FIAT RITMO 9x9x10mm 1p-7x7-9mm 1f-d4.2mm





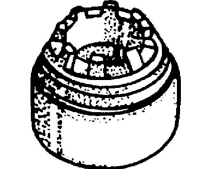

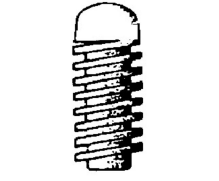
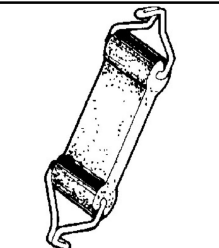

	Z80666 NO. 5962559		Z80675 NO. 182911680
	Mola de fixação FIAT TIPO d11x20mm 1p-d6.2-10mm		Mola de painel FIAT TIPO d20x24.4mm 1p-d9.5-10.6mm
	Z80703 NO. 5988006		Z80705 NO. 14191280 - 82377183
	Mola de fixação FIAT TIPO d15x24mm 1p-d6.5-12mm		Mola de painel FIAT TIPO d21x22.5mm 1p-d7.5-15.5mm
	Z80708 NO. 7630854		Z80851 NO. 7688808
	Mola de fixação FIAT TIPO d15x8.2mm 1p-6x6-6.6mm 1f-d4.8mm		Mola Fiat Tipo 22x12.3x13mm 1p-d6.5-10mm
	Z9002 NO. 7619712 - 7681592 - 82372840		
	MOLA DE ESCAPE 34mm FIAT TIPO (1988 A 1992) d21x34mm NULL		

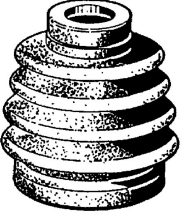
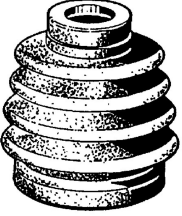
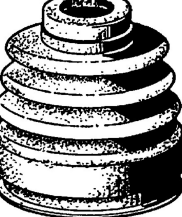
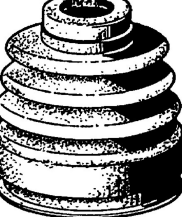
FIAT UNO-FIORINO-DUNA-QUBO

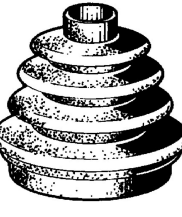
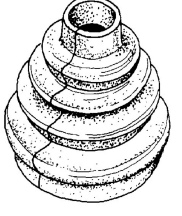

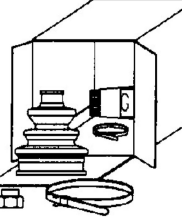
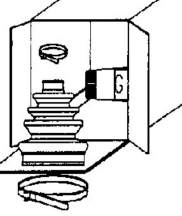
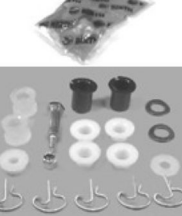

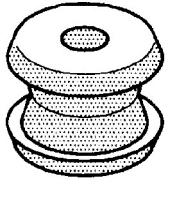
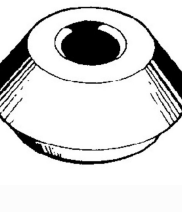









	A0614-I NO. 52007036		A0662-I NO. 4404603
	SUPORTE DO MOTOR FRENTE E TRÁS FIAT FIORINO - (APÓS 5-1980) 115x90x53mm 1f-12mm		SUPORTE FRENTE DO MOTOR E CAIXA FIAT FIORINO 900 - 1050 - 1.0 - 1.0 PCK-UP - 1.3D PICK-UP 112x86x53mm 1f-d12mm
	A0678-I NO. 5937315		A0679-I NO. 5960254
	SUPORTE LATERAL DO MOTOR FIAT UNO 0.9 - 1.0 - 1.1 - 1.3 147x75x42mm 1r-d6mm 1f-d8mm		SUPORTE SUPERIOR DO AMORTECEDOR TRASEIRO FIAT UNO GASOLINA - DIESEL 100x70x25mm 1f-d10mm
	A0680-I NO. 5974777		A0681-I NO. 5988148
	SUPORTE FRENTE DO MOTOR LADO DISTRIBUIÇÃO FIAT UNO 0.9 - 1.0 - 1.0 ie - 1.1 - 1.1 ie - 1.3 - 1.3 TURBO ie - 1.4 - 1.4 ie - 1.4 TURBO ie - 1.5 ie 132x80x57mm 1f-d12mm		APOIO FRENTE MOTOR (LADO DA DISTRIBUIÇÃO) FIAT UNO DIESEL - SUPER - 1.7 133x86x71mm 1r-d10mm

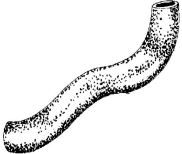

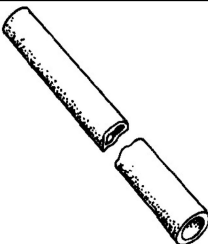

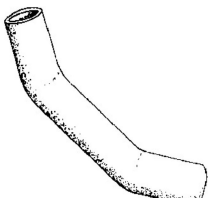



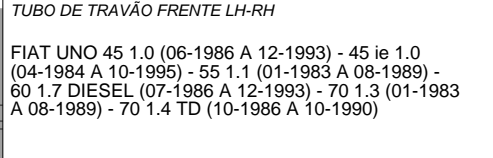

	<p>A0682-I NO. 5985358 - 7534670</p> <p>SUPORTE LATERAL DO MOTOR</p> <p>FIAT UNO DIESEL - 1.3 SUPER - 1.4 TD</p> <p>149x80x56mm 1r-d6mm 1f-d8mm</p>		<p>A0683-I NO. 5981974</p> <p>SUPORTE TRÁS DO MOTOR LADO CAIXA DE VELOCIDADES</p> <p>FIAT UNO DIESEL 1.3 SUPER - 1.7 (GASOLINA) 1.0 - 1.1 ie - 1.1</p> <p>120x107x97mm 1r-d8mm 1f-d10mm</p>
	<p>A0931-I NO. 7589253</p> <p>SUPORTE FRENTE DO MOTOR</p> <p>FIAT UNO 1.4 TD</p> <p>138x78x61mm 1f-d12mm</p>		<p>A0932-I NO. 5985358 - 7534670 - 7567856</p> <p>SUPORTE LATERAL DO MOTOR</p> <p>FIAT UNO TU. i.e. - SPI - MPI - DIESEL 1697 TURBO DIESEL</p> <p>147x75x42mm 1r-d6mm 1f-d8mm</p>
	<p>A0934-I NO. 7571214</p> <p>SUPORTE TRÁS DO MOTOR</p> <p>FIAT UNO DIESEL 1.4 TD - 1.7 TD - 1.9D</p> <p>105x90x62mm 1r-d8mm 1f-d10mm</p>		<p>A0975-I NO. 7563985</p> <p>APOIO SUPERIOR FRENTE DO MOTOR</p> <p>FIAT NOVO FIORINO GASOLINA - NOVO FIORINO 1300D</p> <p>135x90x63mm 1f-d12mm</p>
	<p>A0996 NO. 5974775</p> <p>SUPORTE DO MOTOR LADO DA CAIXA</p> <p>FIAT UNO GASOLINA TT</p> <p>150x80x48mm 1f-d8mm</p>		<p>A1311 NO. 7622921</p> <p>SUPORTE ESQUERDO DO MOTOR</p> <p>FIAT UNO TT - DIESEL (ATÉ 1989)</p> <p>145x91x77mm 1r-d8mm</p>
	<p>A1408 NO. 7589520</p> <p>SUPORTE DA FRENTE MOTOR</p> <p>FIAT UNO D (1697) - UNO D R-89 (1697-1930)</p> <p>170x120x100mm 1p-d10-35mm</p>		<p>A1778 NO. 7587675</p> <p>APOIO DO MOTOR TRÁS INFERIOR LADO DA CAIXA</p> <p>FIAT DUNA DS 1.7 (149 B3.000) 60CV (01-1987 A 12-1991) - FIAT DUNA Weekend DS 1.7 (149 B3.000) 60CV (01-1987 A 12-1991)</p> <p>130x86x55mm 1f-dM10 2f-d9mm</p>
	<p>A1778 NO. 7587675</p> <p>APOIO DO MOTOR TRÁS INFERIOR LADO DA CAIXA</p> <p>FIAT FIORINO 1.7 Diesel (149 B2.000) 57CV (APÓS 01-1988) - 1.7 Diesel (149 B3.000) 60CV (12-1987 A 12-1990) - FIAT FIORINO Furgonato 60 1.7 D (146 B2.000) 57CV (05-1988 A 10-1996) - FIORINO Furgonato 60 1.7 D (149 B3.000) 60CV (05-1988 A 05-2000) - FIAT F</p> <p>130x86x55mm 1f-dM10 2f-d9mm</p>		<p>A1778 NO. 7587675</p> <p>APOIO DO MOTOR TRÁS INFERIOR LADO DA CAIXA</p> <p>FIAT UNO 1.9 D (149 B5.046) 60CV (09-1989 A 03-1994) - UNO 60 Diesel 1.7 (146 B2.000) 57CV (09-1989 A 12-1993)</p> <p>130x86x55mm 1f-dM10 2f-d9mm</p>
	<p>A27407 NO. 5968311 - 7559908</p> <p>SUPORTE - BATENTE SUPERIOR DO AMORTECEDOR FRENTE</p> <p>FIAT UNO TT</p> <p>d65x44mm 1f-d12mm</p>		<p>BE18 NO. 4092067 - 4143428 - 4263436</p> <p>ABRAÇADEIRA DE ESCAPE CÔNCAVA</p> <p>FIAT FIORINO (APÓS 1978)</p> <p>99x62x26mm 2p-d8-60mm</p>
 <p>ESC: 1/2</p>	<p>C0229 NO. 100816 - 4276430</p> <p>BOTÃO DE AFINAÇÃO DO CAPOT (GRANDE)</p> <p>FIAT UNO (146_) 45 1.0 (146A.ED) Mod. tipo: 1 serie, Local de montagem: à frente e atrás 32kW 44CV 999cc Hatchback (DE 06-86 ATÉ 12-93)</p> <p>FIAT UNO (146_) 45 i.e. 1.0 Mod. tipo: 1 serie, Local de montagem: à frente e atrás 33kW 45CV 999cc Hatchback (DE 04-84 ATÉ 10-95)</p> <p>FIAT UNO (146_) 50 1.1 Mod. tipo: 1 serie, Local de montagem: à frente e atrás 37kW 50CV 1116cc Hatchback (DE 01-86 ATÉ 03-94)</p> <p>130x32x15mm NULL</p> <p>FIAT UNO (146_) 55 1.1 Mod. tipo: 1 se...etc.</p>		<p>E0001 NO. 4126729 - 4373254</p> <p>ESTICADOR DE ESCAPE</p> <p>FIAT FIORINO</p> <p>130x32x15mm NULL</p>

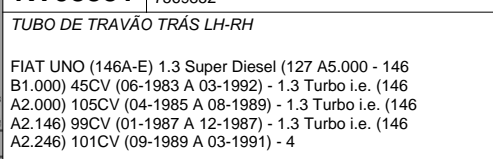

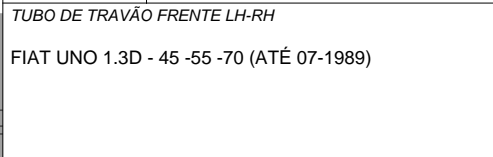
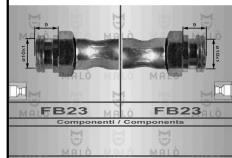
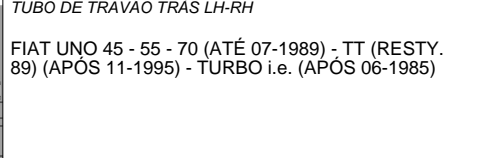
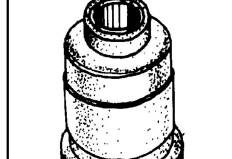
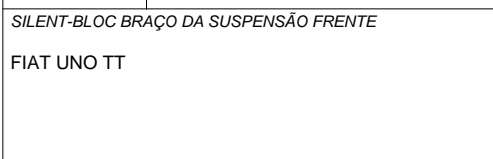

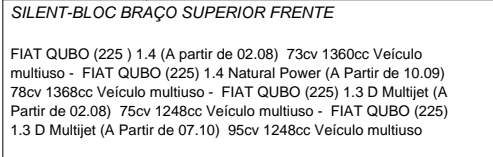

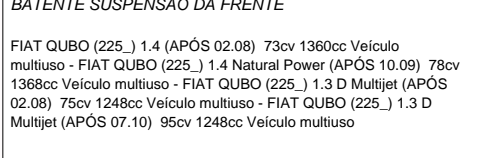

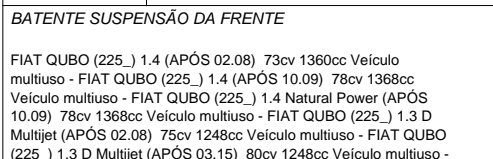

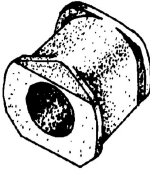



	<p>E0003 NO. 4296059 - 4312280 - 4306054 - 4422065 - 4297082 - 421281 - 4296060</p> <p>ESTICADOR DE ESCAPE</p> <p>FIAT FIORINO</p> <p>80x35x37mm NULL</p>		<p>E0015 NO. 60586017 - 5983764</p> <p>ESTICADOR DE ESCAPE</p> <p>FIAT FIORINO - DUNA</p> <p>87x31x26.5mm NULL</p>
	<p>E0017 NO. 4387293 - 4387294</p> <p>ESTICADOR DE ESCAPE</p> <p>FIAT UNO TT (APÓS 82)</p> <p>55x45x28mm NULL</p>		<p>E0042 NO. 7600807</p> <p>ESTICADOR DE ESCAPE</p> <p>FIAT UNO (APÓS 82)</p> <p>73x45x40mm NULL</p>
	<p>E1105-I NO. 540502745R</p> <p>ESTICADOR DE ESCAPE</p> <p>FIAT UNO</p> <p>72x58x43mm NULL</p>		<p>F0057-I NO. 4294117</p> <p>FOLE DO DIFERENCIAL LADO DA CAIXA (F1012)</p> <p>FIAT FIORINO TT (APÓS 9-82)</p> <p>d95x85mm 1f-d65mm 1f-d23mm</p>
	<p>F0060-I NO. 4239459 - 4371156</p> <p>FOLE DA CREMALHEIRA DA DIRECÇÃO DIREITO (F1038)</p> <p>FIAT UNO TT- FIORINO - NOUVO FIORINO - DUNA</p> <p>d59x180mm d47mm 1f-d1f-d26mm 1f-d10mm</p>		<p>F0388-I NO. 4315444</p> <p>FOLE DO DIFERENCIAL</p> <p>FIAT UNO TURBO i.e.</p> <p>d77x85mm 1f-d62mm 1f-d24mm</p>
	<p>F0389-I NO. 4433969</p> <p>FOLE DO DIFERENCIAL LADO DA RODA</p> <p>FIAT UNO TURBO i.e. (APÓS 11-85)</p> <p>d90x82mm 1f-d76mm 1f-22mm</p>		<p>F0403-I NO. 4383758</p> <p>FOLE DO SEMI-EIXO JUNTO À RODA</p> <p>FIAT FIORINO (ATÉ 12-83)</p> <p>d80x80mm 1f-d70mm 1f-d20mm</p>
	<p>F0468-I NO. 92601216</p> <p>FOLE ESQUERDO E DIREITO DO DIFERENCIAL COM CASQUILHO EM NYLON</p> <p>FIAT UNO (ATÉ 11-84) - DUNA - FIORINO (10-82 A 12-83)</p> <p>d95x70mm 1f-d63mm 1f-d23mm</p>		<p>F0468B-I NO. 92601255</p> <p>FOLE DO DIFERENCIAL SEMI-EIXO ESQUERDO COM CASQUILHO EM NYLON</p> <p>FIAT UNO (12-84 A 2-86) - NOVO FIORINO (APÓS 1-85)</p> <p>d95x73mm 1f-d71mm 1f-d23mm</p>
	<p>F0479-I NO. HH-14153100</p> <p>FOLE DA TRANSMISSÃO JUNTO À CAIXA (COM CASQUILHO DE NYLON LISO FURO 25mm)</p> <p>FIAT FIORINO</p> <p>d96x72mm 1f-d66mm 1f-d25mm</p>		<p>F0514-I NO. 5987092</p> <p>FOLE DO SEMI-EIXO JUNTO À RODA</p> <p>FIAT UNO (APÓS 9-87) - FIORINO (APÓS 1-84) - NOVO FIORINO</p> <p>d86x82mm 1f-d71mm 1f-d20mm</p>
	<p>F0565-I NO. 5978771</p> <p>FOLE DO AMORTECEDOR DA SUSPENSÃO FRENTE (F1059)</p> <p>FIAT UNO TT</p> <p>d62x190mm 1f-d55mm 1f-d16mm</p>		<p>F0787-I NO. 92601366</p> <p>FOLE JUNTO À CAIXA</p> <p>FIAT UNO (3-1986 A 9-1987)</p> <p>d94x76mm 1f-d80mm 1f-d22mm</p>

	<p>F0834-I NO. 7621245</p> <p>FOLE DO DIFERENCIAL SEMI-EIXO DIREITO</p> <p>FIAT UNO 900 - 1000 - 1300 FIRE (APÓS 10-87)</p> <p>d91x82mm 1f-d65mm 1f-d32mm</p>		<p>F0834A-I NO. 7621245</p> <p>FOLE DO DIFERENCIAL SEMI-EIXO DIREITO COM ROLAMENTO d23mm</p> <p>FIAT UNO 900 - 1000 - 1300 FIRE (APÓS 10-87)</p> <p>d93x90mm 1f-d23mm</p>
	<p>F0835-I NO. 7625541</p> <p>FOLE ESQUERDO DO DIFERENCIAL LADO CAIXA</p> <p>FIAT UNO 900 - 1000 - 1300 FIRE (APÓS 10-87)</p> <p>d90x85mm 1f-d77mm 1f-d22.8mm</p>		<p>F0835A-I NO. 7625541</p> <p>FOLE ESQUERDO DO DIFERENCIAL LADO CAIXA COM ROLAMENTO</p> <p>FIAT UNO 900 - 1000 - 1300 FIRE (APÓS 10-87)</p> <p>d90x85mm 1f-d77mm 1f-d22.8mm</p>
	<p>F0898F65 NO. 7682886</p> <p>FOLE JUNTO À RODA</p> <p>FIAT UNO 45 FIRE 999 (12-84 A 9-87) - 45 TURBO DIESEL 1301 (1-84 A 12-85) - 50 IE CAT 1108 - 60 SUPER 1116 (11-85 A 9-87) - 70 SL 1301 - 70 TURBO DIESEL 1367 70IES 1372 - 105 IE TURBO 1301</p> <p>d91x80mm 1f-d65mm 1f-d19mm</p>		<p>F0898F76 NO. 7642776</p> <p>FOLE DO SEMI-EIXO JUNTO À RODA</p> <p>FIAT UNO FIRE (APÓS 10-87) - UNO (APÓS 10-87) - UNO TURBO DIESEL (A PARTIR DO 7344767)</p> <p>d89x83mm 1f-d76mm 1f-d21mm</p>
	<p>F0903-I NO. 82443745</p> <p>FOLE DO DIFERENCIAL LADO DA RODA</p> <p>FIAT UNO TURBO i.e.(APÓS 9-87)</p> <p>d90x82mm 1f-d76mm 1f-d25mm</p>		<p>F1822-I NO. 4315444 - 46307029</p> <p>FOLE DA TRANSMISSÃO JUNTO À CAIXA</p> <p>FIAT UNO 1.3 i.e.T - 1.4 i.e. T (APÓS 83)</p> <p>d102x94mm 1f-d99mm 1f-d25mm</p>
	<p>H527 NO.</p> <p>PALA ORIGINAL</p> <p>FIAT UNO</p> <p>370x205mm NULL</p>		<p>KF1730 NO. 5966569 - 5987092</p> <p>KIT FOLE DO LADO DA RODA</p> <p>FIAT UNO SUPER 75 - 85 - FIORINO</p> <p>d82x80mm 1f-d20mm 1f-d68mm</p>
	<p>KF1775 NO. 7642776</p> <p>KIT FOLE DO LADO DA RODA</p> <p>FIAT UNO TURBO - TD</p> <p>d90x79mm 1f-d21mm 1f-d76mm</p>		<p>KL0004 NO.</p> <p>KIT DE REPARAÇÃO DA ALAVANCA À CAIXA DE VELOCIDADES</p> <p>FIAT UNO T.T. - D - FIORINO</p> <p>NULL NULL</p>
	<p>KL0005 NO.</p> <p>KIT DE REPARAÇÃO DA ALAVANCA À CAIXA DE VELOCIDADES</p> <p>FIAT UNO 900 - 1100</p> <p>NULL NULL</p>		<p>L1001 NO. 4292059</p> <p>CASQUILHO DO BRAÇO DA SUSPENSÃO FRENTE</p> <p>FIAT FIORINO</p> <p>d30x39mm d25mm 1f-d9mm</p>
	<p>L1022 NO. 4227114 - 4223535</p> <p>CASQUILHO DE AMORTECEDOR TRASEIRO</p> <p>FIAT FIORINO</p> <p>d43x20mm 1f-12mm</p>		<p>M6038 NO. 7646609 - 7664769 - 7678282 - 4147260 - 5891207 - 4211272</p> <p>JUNTA DE ESCAPE</p> <p>FIAT FIORINO (1988 A 1995) - UNO (1982 A 1994)</p> <p>104x76mm 2f-d37mm</p>

	<p>M6049 NO. 7669581</p> <p>JUNTA DE ESCAPE</p> <p>FIAT UNO (1985 A 1994)</p> <p>113x60mm 2f-d35mm</p>		<p>M6052 NO. 7545219</p> <p>JUNTA DE ESCAPE</p> <p>FIAT UNO (1987 A 1994)</p> <p>d67x13.8mm 1f-d49.6mm</p>
	<p>M6094 NO. 7544692 - 7690882</p> <p>JUNTA DE ESCAPE</p> <p>FIAT FIORINO (APÓS 1988) - UNO (1985 A 1994)</p> <p>d60x13mm 1f-d45mm</p>		<p>N2331 NO. 4422885 - 4437668 - 7610077</p> <p>ANEL ESCAPE</p> <p>FIAT FIORINO (1988 A 1996) - UNO (1988 A 1994)</p> <p>d58x14mm 1f-d31mm</p>
	<p>N3727 NO.</p> <p>ANEL DE ESCAPE</p> <p>FIAT DUNA - FIORINO</p> <p>d55x12mm 1f-d31mm</p>		<p>P0009-R NO. 4144275</p> <p>CAPA DE PEDAL TRAVÃO E EMBRAIAGEM</p> <p>FIAT FIORINO</p> <p>63x50x12mm NULL</p>
	<p>P1013 NO. 7568442 - 51778057 - 7653554 - 4170605</p> <p>CAPA DE PEDAL DO TRAVÃO E EMBRAIAGEM</p> <p>FIAT UNO</p> <p>80x48x8mm NULL</p>		<p>P1052 NO. 4144275</p> <p>CAPA DE PEDAL DO TRAVÃO E EMBRAIAGEM</p> <p>FIAT FIORINO - N.FIORINO 1A SERIE</p> <p>67x53x12mm NULL</p>
	<p>P1082 NO. 4213235</p> <p>CAPA DE PEDAL DO ACELADOR</p> <p>FIAT ELBA (146) 1.3 (04-1986 A 12-1993) 58CV 1297CC - FIAT ELBA (146) 1.5 (01-1992 A 12-1996) 67CV 1497CC - FIAT ELBA (146) 1.5 (04-1986 A 10-1992) 71CV 1499CC - FIAT ELBA (146) 1.3 D (04-1986 A 10-1992) 45CV 1301CC - FIAT ELBA (146) 1.7 D (04-1989 A 12-1)</p> <p>104x45x8mm NULL</p>		<p>P1082 NO. 4213235</p> <p>CAPA DE PEDAL DO ACELADOR</p> <p>FIAT FIORINO (147) 1.1 60 (11-1986 A 04-1988) 55CV 1116CC - FIAT FIORINO (147) 1.3 (12-1987 A 08-1993) 67CV 1301CC - FIAT FIORINO (147) 1.5 (01-1988 A 08-1993) 75CV 1499CC - FIAT FIORINO (147) 1.3 D (03-1982 A 12-1987) 45CV 1288CC - FIAT FIORINO (147) 1.</p> <p>104x45x8mm NULL</p>
	<p>P1082 NO. 4213235</p> <p>CAPA DE PEDAL DO ACELADOR</p> <p>FIAT PREMIO 1.3 (03-1985 A 06-1992) 58CV 1297CC</p> <p>104x45x8mm NULL</p>		<p>P1082 NO. 4213235</p> <p>CAPA DE PEDAL DO ACELADOR</p> <p>FIAT UNO (146A E) 50 1.1 (01-1990 A 12-1993) 50CV 1108CC - FIAT UNO (146A E) 60 1.1 (04-1989 A 12-1992) 57CV 1108CC - FIAT UNO (146A E) 50 IE 1.1 (6-1992 A 12-1993) 49CV 1116CC - FIAT UNO (146A E) 50 1.1 (01-1986 A 12-1989) 50CV 1116CC - FIAT UNO (146 AE)</p> <p>104x45x8mm NULL</p>
	<p>R017662 NO. 7659600</p> <p>TUBO DO AR DE SOBREALIMENTAÇÃO</p> <p>FIAT UNO (146_) 70 TD 1.4 (10.86 A 10.90) 71cv 1367cc Hatchback</p> <p>B500-d53/50mm 170-230-300-130-110mm</p>		<p>R020408 NO. 7658450</p> <p>TUBO INFERIOR DE SAÍDA DE ÁGUA DO RADIADOR</p> <p>FIAT UNO 1.4 TURBO ie (12-1989 A 12-1996)</p> <p>B330-d34/33mm 90-110-110-60mm</p>
	<p>R020958 NO. 7570384</p> <p>TUBO SUPERIOR DE SAÍDA DE ÁGUA DO RADIADOR</p> <p>FIAT UNO D (1700) - TD</p> <p>B365-d34/34mm 85-105-110-100mm</p>		<p>R020959 NO. 7570385</p> <p>TUBO INFERIOR DE ENTRADA DE ÁGUA DO RADIADOR</p> <p>FIAT UNO D(1700) - TD - 1500 DIESEL - UNO 60SX</p> <p>B510-d33/35mm 105-135-350-125mm</p>











	<p>R020973 NO. 7568331</p> <p>TUBO INFERIOR DO RADIADOR</p> <p>FIAT UNO FIRE TT</p> <p>B320-d35/29mm 95-210-80mm + ch1230-d16mm</p>		<p>R020974 NO. 7559884 - 7727945</p> <p>TUBO SUPERIOR DO RADIADOR</p> <p>FIAT UNO FIRE TT</p> <p>B325-d32/27mm 95-110-95-110mm</p>
	<p>R021813 NO. 4196726 - 4291934 - 7533916 - 7604290</p> <p>TUBO DE LIGAÇÃO DA BOMBA DE ÁGUA À TUBAGEM RÍGIDA DO RADIADOR</p> <p>FIAT UNO T I.E. (1300) - 55 - 70 TT - SX - (1100 - 1300 - 1500) - N. FIORINO (1500)</p> <p>B110-d31/35mm 60-80mm</p>		<p>R021885 NO. 4443820</p> <p>TUBO DO TERMOSTASTO</p> <p>FIAT UNO 45 TT - ES - R-89 (900 - 1000)</p> <p>B110-d9/9mm 35-65-35mm</p>
	<p>R021916 NO. 5970714</p> <p>TUBO DE LIGAÇÃO DO CORPO AO FILTRO DO AR</p> <p>FIAT UNO 55 - 70TT - SX</p> <p>B300-d20/20mm 40-60-165-110mm</p>		<p>R021960 NO. 5953049</p> <p>TUBO SUPERIOR DO RADIADOR</p> <p>FIAT UNO 45 TT - ES</p> <p>B160-d35/35mm 90-65-65mm</p>
	<p>R021961 NO. 5953050</p> <p>TUBO INFERIOR DO RADIADOR</p> <p>FIAT UNO 45 TT-ES</p> <p>B270-d34/34mm 75-160-70mm</p>		<p>R021962 NO. 5938965 - 7567858</p> <p>TUBO DE RADIADOR SUPERIOR</p> <p>FIAT UNO 55 - 60 - 70 - SX - T.I.E.</p> <p>B285-d33/33mm 55-95-85-65mm</p>
	<p>R021963 NO. 5938966 - 82419567</p> <p>TUBO INFERIOR DO RADIADOR</p> <p>FIAT UNO 55 - 60 - 70 - SX</p> <p>B350-d34/34mm 75-120-100-70mm</p>		<p>R021965 NO. 5957582 - 5943090 - EA18633500</p> <p>TUBO DE ENVIO DE ÁGUA AO AQUECIMENTO</p> <p>FIAT UNO 45 TT - ES - 55 - 70 SX - T.I.E.(1300)</p> <p>B605-d15/15mm 605mm</p>
	<p>R021967 NO. 5993534 - 7566610</p> <p>TUBO INFERIOR DO RADIADOR</p> <p>FIAT UNO D TT (1300)</p> <p>B410-d33/33mm 100-115-195-80mm</p>		<p>R021968 NO. 5993535 - 7572271</p> <p>TUBO SUPERIOR DO RADIADOR</p> <p>FIAT UNO D TT (1300)</p> <p>B305-d35/35mm 90-155-95mm</p>
	<p>R021970 NO. 5959652</p> <p>TUBO DE LIGAÇÃO DO FILTRO DE AR À TOMADA DE AR EXTERIOR</p> <p>FIAT UNO 55 - 70 TT</p> <p>B340-d66/54mm 45-200-75mm</p>		<p>R021971 NO. 5963794</p> <p>TUBO DE LIGAÇÃO DO FILTRO DE AR À TOMADA DE AR EXTERIOR</p> <p>FIAT UNO 45 - S</p> <p>B415-d54/42mm 105-220-110mm</p>
	<p>RF5012 NO. 7545122</p> <p>TUBO DE FERRO RADIADOR</p> <p>FIAT UNO FIRE 45 1.0 - 1.0 ie (ATÉ 1993)</p> <p>B270-d27/28mm 225-75mm</p>		<p>RF5013 NO. 7596811</p> <p>TUBO DE FERRO RADIADOR</p> <p>FIAT UNO 1.4 70S - 70 ie</p> <p>B345-d28/28mm 125-220mm+ch30-d13mm+ch25-d10mm</p>

 <p>RT08350 NO. 5966685 - 71736951 - 7566849</p> <p>TUBO DE TRAVÃO FRENTE LH-RH</p> <p>FIAT UNO 45 1.0 (06-1986 A 12-1993) - 45 ie 1.0 (04-1984 A 10-1995) - 55 1.1 (01-1983 A 08-1989) - 60 1.7 DIESEL (07-1986 A 12-1993) - 70 1.3 (01-1983 A 08-1989) - 70 1.4 TD (10-1986 A 10-1990)</p> <p>FB23 MC11 Component / Components</p>	 <p>RT08351 NO. 5944002 - 95599101 - 71736914 - 7569852</p> <p>TUBO DE TRAVÃO TRÁS LH-RH</p> <p>FIAT FIORINO (147) 1.5 (149 C1.000) 75CV (01-1988 A 08-1993) - 1.7 D (149 B2.000) 57CV (01-1988 A 10-1993)</p> <p>FB23 FB23 Component / Components</p>
 <p>RT08351 NO. 5944002 - 95599101 - 71736914 - 7569852</p> <p>TUBO DE TRAVÃO TRÁS LH-RH</p> <p>FIAT UNO (146A-E) 1.3 Super Diesel (127 A5.000 - 146 B1.000) 45CV (06-1983 A 03-1992) - 1.3 Turbo i.e. (146 A2.000) 105CV (04-1985 A 08-1989) - 1.3 Turbo i.e. (146 A2.146) 99CV (01-1987 A 12-1987) - 1.3 Turbo i.e. (146 A2.246) 101CV (09-1989 A 03-1991) - 4</p> <p>FB23 FB23 Component / Components</p>	 <p>RT08352 NO. 5955862 - 5971061 - 7563849 - 7569161 - 7729198 - 5965862 - 71736965</p> <p>TUBO DE TRAVÃO FRENTE LH-RH</p> <p>FIAT FIORINO TT (1988 A 1992)</p> <p>FB23 MC11 Component / Components</p>
 <p>RT08352 NO. 5955862 - 5971061 - 7563849 - 7569161 - 7729198 - 5965862 - 71736965</p> <p>TUBO DE TRAVÃO FRENTE LH-RH</p> <p>FIAT UNO 1.3D - 45 -55 -70 (ATÉ 07-1989)</p> <p>FB23 MC11 Component / Components</p>	 <p>RT08426 NO. 7598927</p> <p>TUBO DE TRAVÃO FRENTE LH-RH</p> <p>FIAT UNO 1.6 (12-1989 A 12-1993) - 1.6 R (12-1992 A 12-1995) - 50 1.1 (01-1986 A 12-1989) - 70 i.e. 1.4 (09-1989 A 12-1993) - 70 S 1.4 (09-1989 A 12-1993) - 75 i.e.1.5 (10-1985 a 12-1993)</p> <p>FB23 MC11 Component / Components</p>
 <p>RT08427 NO. 7563852 - 7603330</p> <p>TUBO DE TRAVÃO TRÁS LH-RH</p> <p>FIAT UNO 45 - 55 - 70 (ATÉ 07-1989) - TT (RESTDY. 89) (APÓS 11-1995) - TURBO i.e. (APÓS 06-1985)</p> <p>FB23 FB23 Component / Components</p>	 <p>S0752-I NO. 5927293</p> <p>SILENT-BLOC DO BRAÇO DA SUSPENSÃO DA FRENTE</p> <p>FIAT UNO TT</p>
 <p>S0753-I NO. 5927292</p> <p>SILENT-BLOC BRAÇO DA SUSPENSÃO FRENTE</p> <p>FIAT UNO TT</p>	 <p>S1595 NO. 50511650 - 50521486 - 51783056 - 51783057</p> <p>SILENT-BLOC BRAÇO SUPERIOR FRENTE</p> <p>FIAT FIORINO Caixa/Combi (225_) 1.4 (A partir de 11.07) 73cv 1360cc Caixa/Combi - FIAT FIORINO Caixa/Combi (225_) 1.4 Natural Power (A partir de 06.08) 78cv 1368cc Caixa/Combi - FIAT FIORINO Caixa/Combi (225_) 1.3 D Multijet (A Partir de 11.07) 75cv 1248cc Caixa/Combi - FIAT FIORINO Caixa/Combi (225_) 1.3 D Multijet (A Partir de 07.09) 95cv 1248cc Caixa/Combi</p>
 <p>S1595 NO. 50511650 - 50521486 - 51783056 - 51783057</p> <p>SILENT-BLOC BRAÇO SUPERIOR FRENTE</p> <p>FIAT QUBO (225_) 1.4 (A partir de 02.08) 73cv 1360cc Veículo multiuso - FIAT QUBO (225_) 1.4 Natural Power (A Partir de 10.09) 78cv 1368cc Veículo multiuso - FIAT QUBO (225_) 1.3 D Multijet (A Partir de 02.08) 75cv 1248cc Veículo multiuso - FIAT QUBO (225_) 1.3 D Multijet (A Partir de 07.10) 95cv 1248cc Veículo multiuso</p>	 <p>T0656-I NO. 51775545 - 51866009</p> <p>BATENTE SUSPENSÃO DA FRENTE</p> <p>FIAT FIORINO Caixa/Combi (225_) 1.4 (APÓS 11.07) 73cv 1360cc Caixa/Combi - FIAT FIORINO Caixa/Combi (225_) 1.4 Natural Power (APÓS 06.08) 78cv 1368cc Caixa/Combi - FIAT FIORINO Caixa/Combi (225_) 1.3 D Multijet (APÓS 11.07) 75cv 1248cc Caixa/Combi - FIAT FIORINO Caixa/Combi (225_) 1.3 D Multijet (APÓS 07.09) 95cv 1248cc Caixa/Combi</p>
 <p>T0656-I NO. 51775545 - 51866009</p> <p>BATENTE SUSPENSÃO DA FRENTE</p> <p>FIAT QUBO (225_) 1.4 (APÓS 02.08) 73cv 1360cc Veículo multiuso - FIAT QUBO (225_) 1.4 Natural Power (APÓS 10.09) 78cv 1368cc Veículo multiuso - FIAT QUBO (225_) 1.3 D Multijet (APÓS 02.08) 75cv 1248cc Veículo multiuso - FIAT QUBO (225_) 1.3 D Multijet (APÓS 07.10) 95cv 1248cc Veículo multiuso</p>	 <p>T0657-I NO. 51804746</p> <p>BATENTE SUSPENSÃO DA FRENTE</p> <p>FIAT FIORINO Caixa/Combi (225_) 1.4 (APÓS 11.07) 73cv 1360cc Caixa/Combi - FIAT FIORINO Caixa/Combi (225_) 1.4 Natural Power (APÓS 06.08) 78cv 1368cc Caixa/Combi - FIAT FIORINO Caixa/Combi (225_) 1.3 D Multijet (APÓS 11.07) 75cv 1248cc Caixa/Combi - FIAT FIORINO Caixa/Combi (225_) 1.3 D Multijet (APÓS 07.09) 95cv 1248cc Caixa/Combi</p>
 <p>T0657-I NO. 51804746</p> <p>BATENTE SUSPENSÃO DA FRENTE</p> <p>FIAT QUBO (225_) 1.4 (APÓS 02.08) 73cv 1360cc Veículo multiuso - FIAT QUBO (225_) 1.4 (APÓS 10.09) 78cv 1368cc Veículo multiuso - FIAT QUBO (225_) 1.4 Natural Power (APÓS 10.09) 78cv 1368cc Veículo multiuso - FIAT QUBO (225_) 1.3 D Multijet (APÓS 02.08) 75cv 1248cc Veículo multiuso - FIAT QUBO (225_) 1.3 D Multijet (APÓS 03.15) 80cv 1248cc Veículo multiuso - FIAT QUBO (225_) 1.3 D Multijet (APÓS 07.10) 95cv 1248cc Veículo multiuso...etc.</p>	 <p>T0658-I NO. 51805787</p> <p>BATENTE SUSPENSÃO DA FRENTE</p> <p>FIAT FIORINO Caixa/Combi (225_) 1.4 (APÓS 11.07) 73cv 1360cc Caixa/Combi - FIAT FIORINO Caixa/Combi (225_) 1.3 D Multijet (APÓS 11.07) 75cv 1248cc Caixa/Combi</p>

	T0658-I NO. 51805787 BATENTE SUSPENSÃO DA FRENTE FIAT QUBO (225_) 1.4 (APÓS 02.08) 73cv 1360cc Veículo multiuso - FIAT QUBO (225_) 1.3 D Multijet (APÓS 02.08) 75cv 1248cc Veículo multiuso		T1062-I NO. 7563151 BATENTE DE ESTABILIZADOR FIAT UNO DIESEL
	d71x110mm 1f-d27mm 1f-d12mm		36x35x30mm 1f-d17mm
	T1156-I NO. 7603476 BATENTE DA BARRA ESTABILIZADORA FIAT UNO TT		W5104 NO. 55182506 POLIE DA CAMBOTA (6+4 PISTAS) FIAT FIORINO 1.3 D MULTIJET (APÓS 02-2008)
	65x35x35mm 1f-d18mm 2p-d8-22mm		d165/144.6mm d35mm
	W5104 NO. 55182506 POLIE DA CAMBOTA (6+4 PISTAS) FIAT QUBO 1.3 D MULTIJET (APÓS 05-2006)		Z10903 NO. 14188880 - 17891280 Mola de fixação FIAT UNO
	d165/144.6mm d35mm		17x12x11mm 1f-d5.5mm
	Z10903 NO. 14188880 - 17891280 Mola de fixação FIAT DUNA		Z80241 NO. 4395881 Mola de friso Fiat Fiorino
	17x12x11mm 1f-d5.5mm		NULL NULL
	Z80243 NO. 14187880 Mola de painel FIAT UNO		Z80243 NO. 14187880 Mola de painel FIAT DUNA
	d17x17.5mm 1p-d8-11.5mm		d17x17.5mm 1p-d8-11.5mm
	Z80247 NO. 14188380 Mola de painel FIAT UNO		Z80352 NO. 14567187 - 17886087 Mola de painel FIAT UNO
	d16x18.6mm 1p-d7.5-12.6mm		d15x19mm 1p-d8-16.5mm
	Z80352 NO. 14567187 - 17886087 Mola de painel FIAT FIORINO		Z80352 NO. 14567187 - 17886087 Mola de painel FIAT DUNA
	d15x19mm 1p-d8-16.5mm		d15x19mm 1p-d8-16.5mm
	Z80465 NO. 4389939 Mola de fixação FIAT UNO		Z80465 NO. 4389939 Mola de fixação FIAT FIORINO
	14x11x15mm 1p-10.5x6-8mm		14x11x15mm 1p-10.5x6-8mm

	Z80465 NO. 4389939 <i>Mola de fixação</i> FIAT DUNA		Z80466 NO. 5944525 <i>Mola de fixação</i> FIAT UNO
	14x11x15mm 1p-10.5x6-8mm		15x9x14mm 1p-d5.5-5mm
	Z80466 NO. 5944525 <i>Mola de fixação</i> FIAT FIORINO		Z80466 NO. 5944525 <i>Mola de fixação</i> FIAT DUNA
	15x9x14mm 1p-d5.5-5mm		15x9x14mm 1p-d5.5-5mm
	Z80476 NO. 14188282 - 46306526 - 60507749 <i>Mola de painel</i> FIAT UNO		Z80502 NO. 5757553 <i>Mola de retenção</i> FIAT UNO
	d18x20.5mm 1p-d8-14mm		d16x9.5mm 1p-7x7-8.5mm 1f-d4.8mm
	Z80510 NO. 7538675 <i>Mola de painel</i> FIAT UNO		Z80510 NO. 7538675 <i>Mola de painel</i> FIAT FIORINO
	d16x17mm 1p-d8.8-11mm		d16x17mm 1p-d8.8-11mm
	Z80510 NO. 7538675 <i>Mola de painel</i> FIAT DUNA		Z80519 NO. 4358789 <i>Mola de fixação</i> FIAT UNO
	d16x17mm 1p-d8.8-11mm		d11x9mm 1p-d8.5-7.8mm 1f-d3mm
	Z80519 NO. 4358789 <i>Mola de fixação</i> FIAT FIORINO		Z80519 NO. 4358789 <i>Mola de fixação</i> FIAT DUNA
	d11x9mm 1p-d8.5-7.8mm 1f-d3mm		d11x9mm 1p-d8.5-7.8mm 1f-d3mm
	Z80532 NO. 5998258 <i>Mola de friso</i> FIAT UNO		Z80532 NO. 5998258 <i>Mola de friso</i> FIAT FIORINO
	20x7x5mm NULL		20x7x5mm NULL
	Z80532 NO. 5998258 <i>Mola de friso</i> FIAT DUNA		Z80533 NO. 7543023 - 7703081019 - 9759904480 <i>Mola de retenção</i> FIAT UNO
	20x7x5mm NULL		10x17x10mm 1p-7.2x14-9mm 1f-d4.2mm

	<p>Z80546 NO. 7641970</p> <p>Mola de friso</p> <p>FIAT UNO (Após 1989)</p> <p>d18x23.5mm 1p-d8.5-16.5mm</p>		<p>Z80578 NO. 14569580 - 14569680</p> <p>Mola de fixação</p> <p>FIAT UNO</p> <p>20x8x15mm 1f-8mm</p>
	<p>Z80587 NO. 7684263</p> <p>Mola de painel</p> <p>FIAT UNO</p> <p>d16x17mm 1p-d9-15mm</p>		<p>Z80587 NO. 7684263</p> <p>Mola de painel</p> <p>FIAT FIORINO</p> <p>d16x17mm 1p-d9-15mm</p>
	<p>Z80590 NO. 14569187</p> <p>Mola de painel</p> <p>FIAT UNO</p> <p>d22x22.5mm 1p-d10.4-20mm</p>		<p>Z80590 NO. 14569187</p> <p>Mola de painel</p> <p>FIAT DUNA</p> <p>d22x22.5mm 1p-d10.4-20mm</p>
	<p>Z80612 NO. 7569468</p> <p>Mola de fixação</p> <p>FIAT UNO</p> <p>d10x33.7mm 1p-d6-18.5mm</p>		<p>Z80619 NO. 7677865</p> <p>Mola de painel</p> <p>FIAT UNO</p> <p>d14x12mm 1p-d7.5-10mm</p>
	<p>Z80620 NO. 833640</p> <p>Mola de painel</p> <p>FIAT UNO</p> <p>d18x18.4mm 1p-d9.5-11.8mm</p>		<p>Z80620 NO. 833640</p> <p>Mola de painel</p> <p>FIAT FIORINO</p> <p>d18x18.4mm 1p-d9.5-11.8mm</p>
	<p>Z80620 NO. 833640</p> <p>Mola de painel</p> <p>FIAT DUNA</p> <p>d18x18.4mm 1p-d9.5-11.8mm</p>		<p>Z80621 NO. 7678808</p> <p>Mola de friso</p> <p>FIAT UNO (Após 1989)</p> <p>24.5x18x17.5mm 1p-9.5x9-10.5mm</p>
	<p>Z80635 NO. 14216080 - 14216087</p> <p>Mola de fixação</p> <p>FIAT UNO</p> <p>d18x14mm 1p-10x10-12.5mm 1f-d4.8mm</p>		<p>Z80635 NO. 14216080 - 14216087</p> <p>Mola de fixação</p> <p>FIAT FIORINO</p> <p>d18x14mm 1p-10x10-12.5mm 1f-d4.8mm</p>
	<p>Z80635 NO. 14216080 - 14216087</p> <p>Mola de fixação</p> <p>FIAT DUNA</p> <p>d18x14mm 1p-10x10-12.5mm 1f-d4.8mm</p>		<p>Z80646 NO. 7578051</p> <p>Mola de fixação</p> <p>FIAT UNO</p> <p>13x17.8x15mm 1p-9x14-14mm 1f-d5.5mm</p>

	Z80646	NO. 7578051		Z80646	NO. 7578051
	<i>Mola de fixação</i> FIAT FIORINO			<i>Mola de fixação</i> FIAT DUNA	
	13x17.8x15mm	1p-9x14-14mm 1f-d5.5mm		13x17.8x15mm	1p-9x14-14mm 1f-d5.5mm
	Z80653	NO. 14211580		Z80653	NO. 14211580
	<i>Mola de fixação</i> FIAT UNO			<i>Mola de fixação</i> FIAT FIORINO	
	9x9x10mm	1p-7x7-9mm 1f-d4.2mm		9x9x10mm	1p-7x7-9mm 1f-d4.2mm
	Z80653	NO. 14211580		Z80666	NO. 5962559
	<i>Mola de fixação</i> FIAT DUNA			<i>Mola de fixação</i> FIAT UNO	
	9x9x10mm	1p-7x7-9mm 1f-d4.2mm		d11x20mm	1p-d6.2-10mm
	Z80703	NO. 5988006		Z80705	NO. 14191280 - 82377183
	<i>Mola de fixação</i> FIAT UNO			<i>Mola de painel</i> FIAT UNO	
	d15x24mm	1p-d6.5-12mm		d21x22.5mm	1p-d7.5-15.5mm
	Z80793	NO. 14203480		Z9002	NO. 7619712 - 7681592 - 82372840
	<i>Mola de retenção</i> FIAT UNO			<i>MOLA DE ESCAPE 34mm</i> FIAT UNO (1983 A 1994)	
	d16x5mm	1p-d10-7mm 1f-d4.5mm		d21x34mm	NULL