

















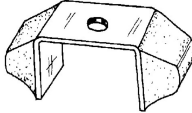
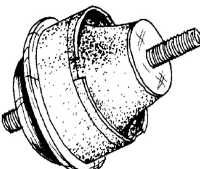
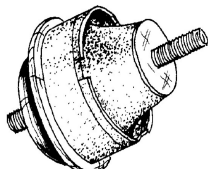





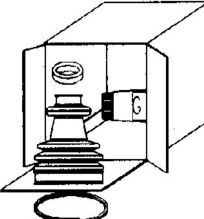









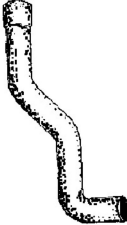

	<p>E0032 NO. 5410471 - DS18280 - DX18280A</p> <p>ESTICADOR DE ESCAPE</p> <p>CITROËN 250 (72-78) - DS (66-74) - D SUPER5 - DS 23 (73-75)</p>		<p>E0033 NO. AMI18275</p> <p>ESTICADOR DE ESCAPE</p> <p>CITROËN 250(72-78)</p>
	<p>H514 NO.</p> <p>PALA ORIGINAL</p> <p>CITROËN</p>		<p>U3304 NO.</p> <p>ANEL DE CADEIRA</p> <p>CITROËN</p>
	<p>UBV8013 NO.</p> <p>BOMBA VACUO (KIT REPARAÇÃO NOVO MODELO) (LARG. 51mm)</p> <p>CITROËN (DIESEL)</p>		<p>UBV8014 NO.</p> <p>BOMBA VACUO (KIT REPARAÇÃO) (NOVO MODELO)</p> <p>CITROËN (DIESEL)</p>
	<p>Y3005 NO. 179845</p> <p>PARAFUSO ESCAPE</p> <p>CITROËN M6X68mm</p>		<p>Z80470 NO. 164361 - 7703072177</p> <p>Mola de fixação</p> <p>CITROËN (TODOS)</p>
	<p>Z80709 NO. 6992P3</p> <p>Mola de fixação</p> <p>CITROËN (TODOS)</p>		

CITROËN AX-AXEL

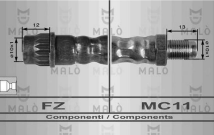
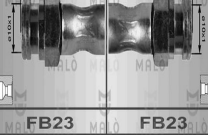
	<p>A0008 NO. 1807.47 - 915071180</p> <p>APOIO TRASEIRO DO MOTOR</p> <p>CITROËN AX DIESEL</p>		<p>A1002 NO. 97521102</p> <p>APOIO INTERMÉDIO DA SUSPENSÃO DO MOTOR FRENTE</p> <p>CITROËN AX TT</p>
	<p>A1028 NO. 91517554 - 91538497</p> <p>SUPORTE FRENTE DIREITO DO MOTOR</p> <p>CITROËN AX 1.0 - 1.1 - 1.4 - 1.6 - 1.6E</p>		<p>A1028-H NO. 91517554</p> <p>SUPORTE FRENTE DIREITO DO MOTOR (HIDRÁULICO)</p> <p>CITROËN AX DIESEL 1.4D - 1.5D</p>

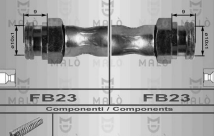
	<p>A1179 NO. 9563167980 - 95631679 - 95205626</p> <p>APOIO DO MOTOR FRENTE DIREITO CITROËN AX 1.0 (1986 A 1998) - 1.1 (1986 A 1997)</p> <p>58x58x40mm 2p-d10-25mm</p>		<p>A1190 NO. 96038337</p> <p>SUPORTE DA CAIXA DE VELOCIDADES CITROËN AX 1.0 - 1.1 - 1.4 - 1.4D</p> <p>110x85x56mm 1f-d17/11mm</p>
	<p>A1297 NO. 95603783 - 5038.08</p> <p>SUPORTE DO AMORTECEDOR CITROËN AX 1.0 - 1.1 - 1.4 - 1.4D - 1.5D</p> <p>NULL NULL</p>		<p>A1357 NO. 96009402 - 184454</p> <p>SUPORTE DO MOTOR INFERIOR (TRÁS) CITROËN AX 1.0 - 1.1 (1986 A 1997) - 1.4</p> <p>150x120x53mm 1f-d10mm</p>
	<p>A1358 NO. 96010396</p> <p>SUPORTE DO MOTOR FRENTE ESQUERDO CITROËN AX DIESEL 1.4D (1988 A 1992)</p> <p>111x74x67mm NULL</p>		<p>A1405 NO. 1843.99 - 96096563</p> <p>SUPORTE FRENTE DO MOTOR CITROËN AX 1.1 INJECT</p> <p>125x70x56mm 1f-d10mm 2p-d8-20mm</p>
	<p>BB04 NO. 5097.27</p> <p>ABRAÇADEIRA DA BARRA ESTABILIZADORA CITROËN AX</p> <p>73x53x28mm 2p-d10-25mm</p>		<p>BB10 NO. 95632726</p> <p>ABRAÇADEIRA DA BARRA ESTABILIZADORA CITROËN AX</p> <p>65x38x30mm 2f-d10mm</p>
	<p>BB11 NO. 509734</p> <p>ABRAÇADEIRA DA BARRA ESTABILIZADORA CITROËN AX 1.4 (1986 A 1997)</p> <p>85x50x43mm NULL</p>		<p>BE15 NO. 0414601A - 75529846 - 75420467 - 5420467</p> <p>ABRAÇADEIRA DE ESCAPE CÔNCAVA 53mm CITROËN AX (1986 A 1992) - AXEL (1984 A 1990)</p> <p>93x52x18mm 53mm</p>
	<p>BE17 NO. 75420467</p> <p>ABRAÇADEIRA DE ESCAPE CÔNCAVA 49mm CITROËN AXEL (1984 A 1990)</p> <p>86x48x15mm 49mm</p>		<p>E0004 NO. 75420014 - 91503080 - 54200.14</p> <p>ESTICADOR DE ESCAPE CITROËN AX (84-90)</p> <p>65x45x24mm NULL</p>
	<p>F0998-I NO. 95619710</p> <p>FOLE DO LADO DA CAIXA (JUNTA d76mm) (F1064) CITROËN AX 1.0 - 1.1 - 1.4 - 1.4D</p> <p>d74x80mm 1f-d70mm 1f-d20mm</p>		<p>F0999K-I NO. 95619709 - 328769 - 3287.68</p> <p>FOLE DO SEMI-EIXO DO LADO DA CAIXA DE VELOCIDADES COM CARTER CITROËN AX 1.0 - 1.1 - 1.3 SPORT - 1.4 - 1.4 4x4 - 1.4D</p> <p>d72x170mm 1f-d72mm 1f-d18mm</p>
	<p>F1124K-I NO. 95653092</p> <p>FOLE DO SEMI-EIXO DO DIFERENCIAL LADO CAIXA CITROËN AX 1.0 - 1.1 - 1.3 SPORT - 1.4 - 1.4D</p> <p>d65x165mm 1f-d63mm 1f-d20mm</p>		<p>F1306-I NO. 9451083480 - 9451076880</p> <p>FOLE DA DIREÇÃO DIREITO CITROËN AX 1.0 - 1.1 - 1.3 SPORT - 1.4 - 1.4D - 1.4i GTI</p> <p>d55x120mm 1f-d42mm 1f-d36mm</p>

	<p>F1307-I NO. 9451076780</p> <p>FOLE DA DIRECÇÃO ESQUERDO</p> <p>CITROËN AX 1.0 - 1.1 - 1.3 SPORT - 1.4 - 1.4D - 1.4i GTi</p> <p>d50x112mm 1f-d40mm</p>		<p>H538 NO.</p> <p>PALA ORIGINAL (FRENTE)</p> <p>CITROËN AX (NOVO)</p> <p>300x225mm NULL</p>
	<p>H601 NO.</p> <p>PALA ORIGINAL CITROËN AX NOVO (TRÁS)</p> <p>CITROËN AX (NOVO)</p> <p>300x220mm NULL</p>		<p>H602 NO.</p> <p>PALA ORIGINAL</p> <p>CITROËN AX (ANTIGO)</p> <p>345x220mm NULL</p>
	<p>H602-A NO.</p> <p>PALA ORIGINAL</p> <p>CITROËN BX (ANTIGO)</p> <p>345x220mm NULL</p>		<p>KF1490 NO. 95619710</p> <p>KIT FOLE DO LADO DA RODA</p> <p>CITROËN AX 1.0 - 1.1 - 1.4 - 1.4 D</p> <p>d78x82mm 1f-d19mm 1f-d73mm</p>
	<p>L3037 NO. 91509516</p> <p>CASQUILHO DOS PARAFUSOS DE ESCAPE</p> <p>CITROËN AX (APÓS 1986)</p> <p>d23x10mm c8mm 1f-d11/16mm</p>		<p>M6011 NO. 95602682 - 95603555</p> <p>JUNTA DE ESCAPE</p> <p>CITROËN AX (APÓS 1986)</p> <p>d59.5x13.5mm 1f-d46.2mm</p>
	<p>M6039 NO. 96000436</p> <p>JUNTA DE ESCAPE</p> <p>CITROËN AX (APÓS 1986)</p> <p>100x92mm 1f-d60mm</p>		<p>M6062 NO. 95638362 - 1710.58</p> <p>JUNTA DE ESCAPE</p> <p>CITROËN AX (APÓS 1989)</p> <p>92x88mm 1f-d43.5mm</p>
	<p>P1007 NO. 95575913</p> <p>CAPA DE PEDAL DO TRAVÃO E EMBRAIAGEM</p> <p>CITROËN AX</p> <p>68x45x11mm NULL</p>		<p>R021812 NO. 95636723 - 1413.95</p> <p>TUBO DE LIGAÇÃO DO CARBURADOR AO COLECTOR</p> <p>CITROËN AX (1.1 - 1.4)</p> <p>B245-d7/7mm 235-65mm</p>
	<p>R220876 NO. 96003400</p> <p>TUBO INFERIOR DA SAÍDA DE ÁGUA DO RADIADOR</p> <p>CITROËN AX DIESEL 1.4D</p> <p>B400-d28/30mm 100-235-85-305-135-145-65mm+ch765-d</p>		<p>R220877 NO. 96003397</p> <p>TUBO SUPERIOR DE ENTRADA DE ÁGUA DO RADIADOR</p> <p>CITROËN AX DIESEL 1.4D</p> <p>B285-d30/27mm 65-65-95-80mm</p>
	<p>R220878 NO. 96086168 - 97533257 - 1413.93</p> <p>TUBO DO CARBURADOR</p> <p>CITROËN AX 1.4</p> <p>B80-d8/8mm 65-70-45mm</p>		<p>R220879 NO. 96058717</p> <p>TUBO DO AQUECIMENTO</p> <p>CITROËN AX TT</p> <p>B265-d18/17mm 55-45-95-75-50mm</p>

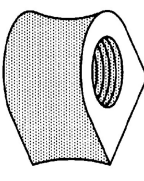







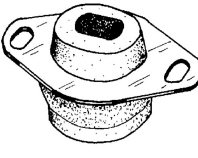
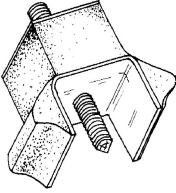
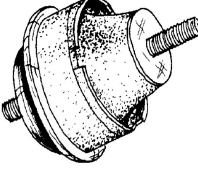
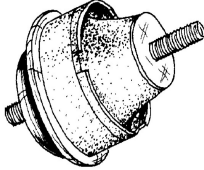

	R220880 NO. 95636003 TUBO DE RADIADOR SUPERIOR CITROËN AX GASOLINA 1.1 - 1.4 B285-d30/28mm 100-55-80-85mm		R220881 NO. 95206756 TUBO INFERIOR DA SAÍDA DE ÁGUA DO RADIADOR CITROËN AX 1.0 - 1.1 (1º TIPO) SPORT B310-d30/26mm 110-140-165-295-80-340mm
	R220882 NO. 96022712 TUBO INFERIOR DO RADIADOR CITROËN AX 1.1 - 1.4 B400-d31/29mm 70-65-60-150-320-75-55-40-135-35-40mm		R220883 NO. 95637678 TUBO DE UNIÃO DA BOMBA DE ÁGUA AO RADIADOR CITROËN AX 1.1 - 1.4 B540 - d14mm 50-55-100-50-60-120-140-50-70-50mm
	R220949 NO. 141394 - 97533256 TUBO DO CARBURADOR CITROËN AX 1.4 B70-d10/10mm 55-90-160-70mm		R8069 NO. 96159736 TUBO DO ARREFECIMENTO CITROËN AX DIESEL 1.4D B340-d17/17mm 1r-d6mm 50-85-205-25-100mm 80-355mm
	RT08317 NO. 96102107 TUBO DE TRAVÃO FRENTE LH-RH CITROËN AX TT (ATÉ 1998) (APÓS CH:05106) 325mm FZ - MC11		RT08351 NO. 5944002 - 95599101 TUBO DE TRAVÃO TRÁS LH-RH CITROËN AX (ZA_) 1.3 Sport (M4A) 95CV (04-1987 A 12-1988) - 1.4 GTI KFY (TU3FJ2) 90CV (08-1991 A 12-1996) - 1.4 GTI KFZ (TU3FJ2) 94CV (06-1991 A 12-1996) - 1.4 GTI KFZ (TU3FJ2) 100CV (06-1991 A 12-1992) - 10 CDZ (TU9M) 50CV (02-1987 A 12-1998) - 11 4X4 218mm FB23 - FB23
	RT08386 NO. 75492063 - 75494063 - 75492063 TUBO DE TRAVÃO FRENTE LH-RH CITROËN AX TT (1987 A 1998) 352mm FB23 - M11		RT08518 NO. 480661 TUBO DE TRAVÃO TRÁS LH CITROËN AX 1.0 (07-86 A 12-98) - 1.1 (09-86 A 12-97) - 1.4 (12-86 A 04-97) 220mm FZ - FZ
	RT08548 NO. 480665 - 96124223 TUBO DE TRAVÃO TRÁS LH-RH CITROËN AX TT (1987 A 1998) 230mm FB23 - FB23		S1108 NO. 96106474 - 95634285 SILENT-BLOC EXTERIOR DO BRAÇO DE SUSPENSÃO CITROËN AX 87x55x46mm 2p-d10-28mm 1f-d16mm
	S1122 NO. 95603308 SILENT-BLOC CENTRAL DO BRAÇO DA SUSPENSÃO CITROËN AX TT d34x48mm c31mm 1f-d12mm		S1123 NO. 96133255 - 96058684 SILENT-BLOC EXTERIOR DO BRAÇO DE SUSPENSÃO CITROËN AX TT 53x45x41mm 1f-d13mm
	S1305 NO. 1809.04 - 91201175 SILENT-BLOC DO TIRANTE TRASEIRO MOTOR CITROËN AX 1.0 - 1.1 - 1.4 - 1.4D d30x34mm c28mm 1f-d12mm		T0029 NO. 96064489 - 96054483 - 95638919 - 95638920 BATENTE DA BARRA ESTABILIZADORA (PONTAS) CITROËN AX 1.4 (1986 A 1997) 34x31x25mm 1f-d19mm

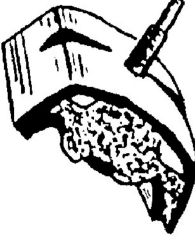



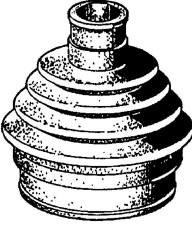



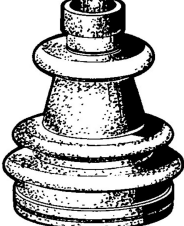

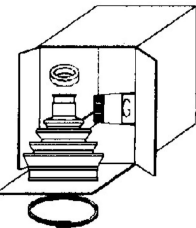

	<p>T0030 NO. 96054481</p> <p>BATENTE DA BARRA ESTABILIZADORA (CENTRO)</p> <p>CITROËN AX 1.4 (1986 A 1997)</p> <p>57x41x41mm 1f-d18mm</p>		<p>W5007 NO. 0515L6 - 0516A4 - 051660</p> <p>POLIE DA CAMBOTA (5 pistas)</p> <p>CITROËN AX (1.5 D - mot. TDU5)</p> <p>d142.5mm d42mm</p>
	<p>W5029 NO. 0515.J3</p> <p>POLIE DA CAMBOTA (5 PISTAS)</p> <p>CITROËN AX 1.5D (TUD5)</p> <p>d128mm d44mm</p>		<p>W5064 NO. 0515.k8</p> <p>POLIE DA CAMBOTA (5 PISTAS)</p> <p>CITROËN AX MOTOR 1.6 16V TU5-JU SEM AR CONDICIONADO</p> <p>d138/139mm d44mm</p>
	<p>Y3001 NO. 95608790 - 91521270 - 91521271 - 96118164</p> <p>PARAFUSO DE ESCAPE</p> <p>CITROËN AX (APÓS 1986)</p> <p>65x8mm 1p-d6-15mm</p>		<p>Y3002 NO. 95608790 - 91521270 - 91521271 - 96118164</p> <p>PARAFUSO DE ESCAPE</p> <p>CITROËN AX (APÓS 1986) - BX (1985 A 1994) - EVASION (APÓS 1994) - JUMPER (APÓS 1994) - XANTIA (APÓS 1993) - XM (APÓS 1989) - ZX (1991 A 1996)</p> <p>d13x60mm d8.5mm 1p-d6-10mm</p>
	<p>Z80268 NO. 7903077112</p> <p>Mola de painel</p> <p>CITROËN AX</p> <p>d16.5x21mm 1p-d6.5-15mm</p>		<p>Z80518 NO. 14115980 - 155809966 - 6992G2</p> <p>Mola de retenção</p> <p>CITROËN AX</p> <p>d13x9mm 1p-7x7-8mm 1f-d4.8mm</p>
	<p>Z80596 NO. 7903077167</p> <p>Mola de painel</p> <p>CITROËN AX</p> <p>d12x20.4mm 1p-d6.5-18.4mm</p>		<p>Z80606 NO. 9609212380</p> <p>Mola de fixação</p> <p>CITROËN AX</p> <p>d10x11mm 1p-d7-10mm 1f-d6mm</p>
	<p>Z80720 NO. 696640</p> <p>Mola de painel</p> <p>CITROËN AX</p> <p>d20x20mm 1p-d8-17.5mm</p>		<p>Z9001 NO. 7910029764 - 91510245 - 75530745 - 9150246180</p> <p>MOLA DE ESCAPE 26mm</p> <p>CITROËN AX (APÓS 1986)</p> <p>d21x26mm NULL</p>
	<p>Z9008 NO. 96062723 - 96092921</p> <p>MOLA DE ESCAPE</p> <p>CITROËN AX (APÓS 1989)</p> <p>d21x34mm NULL</p>		

	<p>A1323 NO. 1844.47 - 1844.77 - 1827.23</p> <p>SUPORTE MOTOR LADO DIREITO</p> <p>CITROËN BERLINGO 1.1i - 1.4i - 1.8i</p> <p>d92x83mm 1p-d10-28mm 1p-d10-20mm</p>		<p>A1323-H NO. 1844.47 - 1844.77 - 1827.23</p> <p>APOIO DE MOTOR DIREITO (HIDRÁULICO)</p> <p>CITROËN BERLINGO 1.9D 70 - 1.9D - 2.0 HDi 90</p> <p>d92x80mm 1p-10-25mm 1p-d10-27mm</p>
	<p>A1400 NO. 182710 - 184436</p> <p>SUPORTE MOTOR ESQUERDO</p> <p>CITROËN BERLINGO 1.8i - 1.9D - 2.0 HDi 90</p> <p>135x90x58mm 1f-d11mm</p>		<p>A1401 NO. 1809.21 - 1809.29 - 1809.16</p> <p>SUPORTE DO MOTOR TRÁS</p> <p>CITROËN BERLINGO 1.1i - 1.4i - 1.8i - 1.9D - 2.0 HDi 90</p> <p>d70x53mm c40mm 1f-d10mm</p>
	<p>A1403 NO. 1844.25</p> <p>SUPORTE LIMITADOR DO APOIO DIREITO (Complemento do A1323 e A1323H)</p> <p>CITROËN BERLINGO</p> <p>112x50x40mm 1f-d10mm</p>		<p>A1738 NO. 503824 - 503878 - 96090345</p> <p>APOIO DO AMORTECEDOR DA FRENTE</p> <p>CITROËN BERLINGO 1.1i - 1.4i - 1.6 16V - 1.8i - 1.8D - 1.9D - 1.9D 70 - 2.0 HDi 90 - 2.0 HDi 90 4WD (APÓS 1996)</p> <p>170x145x50mm 1f-d14mm 4f-d8mm</p>
	<p>A1750 NO. 503823 - 96090346</p> <p>APOIO DO AMORTECEDOR DA FRENTE DIREITO E ESQUERDO (VEÍCULO SEM DIRECÇÃO ASSISTIDA)</p> <p>CITROËN BERLINGO 1.1i (APÓS 07-1996) - 1.4i (APÓS 07-1996) - 1.6 16V (APÓS 10-2000) - 1.8 D (APÓS 07-1998) - 1.8 i (APÓS 05-1997) - 1.8 i 4WD (APÓS 04-1997) - 1.9 D (APÓS 07-1998) - 1.9 D 4WD (APÓS 07-1998) - 2.0 HDi 90 (APÓS 12-1999)</p> <p>165x147x50mm 1f-d14mm 4f-d8mm</p>		<p>A1750 NO. 503823 - 96090346</p> <p>APOIO DO AMORTECEDOR DA FRENTE DIREITO E ESQUERDO (VEÍCULO SEM DIRECÇÃO ASSISTIDA)</p> <p>CITROËN BERLINGO FURGONATO 1.1 i (APÓS 07-1996) - 1.4 i (APÓS 07-1996) - 1.6 16V (APÓS 10-2000) - 1.8 D (APÓS 07-1996) - 1.8 i (APÓS 08-1999) - 1.9 D (APÓS 07-1996) - 1.9 D 70 4WD (APÓS 07-1998) - 1.9 D 70 (APÓS 04-1999) - 2.0 HDi 90 4WD (APÓS 11-2000) -</p> <p>165x147x50mm 1f-d14mm 4f-d8mm</p>
	<p>A1788 NO. 1807GF - 1807XZ - 1807EV</p> <p>APOIO DO MOTOR PARTE DA FRENTE LADO DIREITO</p> <p>CITROËN BERLINGO 1.6 HDi 110 9HR (DV6C) 112CV (APÓS 07-2010) - 1.6 HDi 110 9HZ (DV6TED4) 109CV (APÓS 04-2008) - 1.6 HDi 75 9HT (DV6BTED4) 75CV (APÓS 04-2008) - 1.6 HDi 90 9HX (DV6ATED4) 90CV (APÓS 04-2008) - 1.6 HDi 90 9HX (DV6ATED4) 92CV (APÓS 07-2010)</p> <p>160x125x160mm 3f-d11mm 3f-d12mm 1f-d10mm</p>		<p>A1922 NO. 1714E3 - 9642742880 - 1755E4 - 17565YV010</p> <p>APOIO DO ESCAPE</p> <p>CITROËN BERLINGO (MF) 1.6 HDI 75 (MF9HW) Sistema de escape: para tubo de escape - Local de montagem: à frente (APÓS 07.05) 75cv 1560cc Veículo multiuso - CITROËN BERLINGO (MF) 1.6 HDI 90 (MF9HX) Sistema de escape: para tubo de escape - Local de montagem: à frente (APÓS 07.05) 90cv 1560cc Veículo multiuso - CITROËN BERLINGO Caixa (M_) 1.6 HDI 75 (MB9HW) Sistema de escape: para tubo de escape - Local de montagem: à frente (APÓS 07.05) ...etc.</p> <p>53x39x45mm 2p-d6-18mm</p>
	<p>E0143 NO. 5087.34 - 5087.39 - 5087.42 - 5087.46 - 961152213</p> <p>ESTICADOR DA BARRA ESTABILIZADORA DA FRENTE</p> <p>CITROËN BERLINGO TT - XSARA TT - CITROËN ZX TT</p> <p>330x35x35mm 2p-d10-25mm</p>		<p>E1084 NO. 1755.68</p> <p>ESTICADOR DE ESCAPE (PARTE DE TRÁS)</p> <p>CITROËN BERLINGO 1.1 - 1.4 - 1.8 - 1.9D - 2.0 HDI (APÓS 1996)</p> <p>57x52x20mm NULL</p>
	<p>F1633-I NO. 328781 - 329781</p> <p>FOLE DA TRANSMISSÃO JUNTO À CAIXA</p> <p>CITROËN BERLINGO (APÓS 96) 1.8D - 1.8i - 1.9D - 1.9D 4WD - 2.0 HDi</p> <p>d87x104mm 1f-d80mm 1f-d34mm</p>		<p>F1821-I NO. 328788 - 3287.93</p> <p>FOLE DA TRANSMISSÃO JUNTO À CAIXA</p> <p>CITROËN BERLINGO 1.1i - 1.4i - 1.1i MULTISPACE - 1.4i MULTISPACE (APÓS 1996)</p> <p>d77x85mm 1f-d72mm 1f-d28mm</p>
	<p>KF1425 NO. 329320</p> <p>KIT FOLE LADO RODA</p> <p>CITROËN BERLINGO (MF) 1.1 i (MFHDZ, MFHFX) (07.96 A 05.08) 60cv 1124cc Veículo multiuso - CITROËN BERLINGO (MF) 1.4 i (MFKFX, MFKFW) (07.96 A 10.08) 75cv 1360cc Veículo multiuso - CITROËN BERLINGO (MF) 1.8 i (MFLFX) (05.97 A 10.02) 90cv 1761cc Veículo multiuso - CITROËN BERLINGO (MF) 1.9 D (MFWJZ) (07.98 A 10.05) 70cv 1868cc Veículo multiuso - CITROËN BERLINGO (MF) 1.9 D 4WD (MFWJZ) (07.98 A 10.05) 69cv 1868cc Veículo multiuso ...etc.</p> <p>d96x110mm 1f-d30mm 1f-d77mm</p>		<p>KF1475-T NO. 329314</p> <p>KIT DE FOLE DO CARDAN JUNTO À RODA</p> <p>CITROËN BERLINGO 1.1i - 1.4i (APÓS 1996) - BERLINGO MULTISPACE 1.1i - 1.4i (APÓS 1996) - XSARA 1.6i (1997 A 2004)</p> <p>d95x135mm 1f-d81mm 1f-d24mm</p>

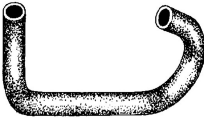
	<p>RT08485 NO. 480685 - 96132698</p> <p>TUBO DE TRAVÃO FRENTE LH-RH</p> <p>CITROËN BERLINGO TT (APÓS 07-1996)</p>		<p>RT08561 NO. 480686</p> <p>TUBO DE TRAVÃO TRÁS LH-RH</p> <p>CITROËN BERLINGO TT (APÓS 07-1996)</p>
	<p>RT80227 NO.</p> <p>TUBO DE TRAVÃO TRÁS LH-RH (APÓS CHASSI 09534)</p> <p>CITROËN BERLINGO TT</p>		<p>RT80440 NO. 4806G4</p> <p>TUBO DE TRAVÃO FRENTE LH-RH</p> <p>CITROËN BERLINGO 1.6 (APÓS 04-2008) - BERLINGO 1.6 Hdi 110 (APÓS 04-2008) - BERLINGO 1.6 Hdi 75 (APÓS 04-2008) - BERLINGO 1.6 Hdi 90 (APÓS 04-2008) - BERLINGO FURGONATO 1.6 (APÓS 04-2008) - BERLINGO FURGONATO 1.6 Hdi 75 (APÓS 04-2008) - BERLINGO FURGONATO</p>
	<p>S1154 NO. 96070064 - 95494716</p> <p>SILENT-BLOC EXTERIOR DO BRAÇO DA SUSPENSÃO DIANTEIRA</p> <p>CITROËN BERLINGO 1.1i - 1.4i (APÓS 07-1996)</p>		<p>S1155 NO. 95637690 - 95494717</p> <p>SILENT-BLOC CENTRAL DO BRAÇO DA SUSPENSÃO DIANTEIRA</p> <p>CITROËN BERLINGO 1.1i - 1.4i (APÓS 07-1996)</p>
	<p>S1304 NO. 95644954 - 4059.07</p> <p>SILENT-BLOC DO PISTÃO DIRECÇÃO ASSISTIDA</p> <p>CITROËN BERLINGO 1.1i - 1.4i - 1.6 16V - 1.8i - 1.8D - 1.9D - 1.9D 70 - 1.6 HDi - 2.0 HDi</p>		<p>S1556 NO. 405910</p> <p>SILENT BLOC DO VEIO DA DIRECÇÃO</p> <p>CITROËN BERLINGO (MF) 1.1 i (MFHDZ - MFHFX) (APÓS 07-1996) 60CV 1124CC - CITROËN BERLINGO (MF) 1.4 bivalent (APÓS 11-2002) 65CV 1360CC - CITROËN BERLINGO (MF) 1.4 i (MFKFX - MFKFW) (07-1996 A 10-2008) 75CV 1360CC - CITROËN BERLINGO (MF) 1.4 i bivalent (MFKF</p>
	<p>T0677-I NO. 503327 - 9151930280</p> <p>BATENTE SUSPENSÃO DA FRENTE</p> <p>CITROËN BERLINGO (MF) 1.1 i (MFHDZ - MFHFX) (APÓS 07.96) 60cv 1124cc Veículo multiuso - CITROËN BERLINGO (MF) 1.4 bivalent (APÓS 11.02) 65cv 1360cc Veículo multiuso - CITROËN BERLINGO (MF) 1.4 (11.02 A 10.05) 72cv 1360cc Veículo multiuso - CITROËN BERLINGO (MF) 1.4 i (MFKFX - MFKFW) (07.96 A 10.08) 75cv 1360cc Veículo multiuso - CITROËN BERLINGO (MF) 1.4 i bivalent (MFKFW) (APÓS 04.03) 75cv 1360cc Veículo multiuso - CITROËN BER...etc.</p>		<p>T0680-I NO. 516663 - 9621916980</p> <p>BATENTE SUSPENSÃO DA FRENTE</p> <p>CITROËN BERLINGO (MF) 1.1 i (MFHDZ - MFHFX) (APÓS 07.96) 60cv 1124cc Veículo multiuso - CITROËN BERLINGO (MF) 1.4 bivalent (APÓS 11.02) 65cv 1360cc Veículo multiuso - CITROËN BERLINGO (MF) 1.4 (11.02 A 10.05) 72cv 1360cc Veículo multiuso - CITROËN BERLINGO (MF) 1.4 i (MFKFX - MFKFW) (07.96 A 10.08) 75cv 1360cc Veículo multiuso - CITROËN BERLINGO (MF) 1.4 i bivalent (MFKFW) (APÓS 04.03) 75cv 1360cc Veículo multiuso - CITROËN BER...etc.</p>
	<p>T0687-I NO. 503365</p> <p>BATENTE SUSPENSÃO DA FRENTE</p> <p>CITROËN BERLINGO (MF) 1.4 bivalent 11.02 - 48 65 1360 Veículo multiuso CITROËN BERLINGO (MF) 1.4 11.02 - 10.05 53 72 1360 Veículo multiuso CITROËN BERLINGO (MF) 1.4 i bivalent (MFKFW) 04.03 - 55 75 1360 Veículo multiuso CITROËN BERLINGO (MF) 1.6 HDI 75 (MF9HW) 07.05 - 55 75 1560 Veículo multiuso CITROËN BERLINGO (MF) 1.6 HDI 90 (MF9HX) 07.05 - 66 90 1560 Veículo multiuso CITROËN BERLINGO (MF) 1.6 HDI 110 08.05 - 80 109 1560 Veículo mu...etc.</p>		<p>T0689-I NO. 503340</p> <p>BATENTE SUSPENSÃO DA FRENTE</p> <p>CITROËN BERLINGO (MF) 1.1 i (MFHDZ - MFHFX) (APÓS 07.96) 60cv 1124cc Veículo multiuso - CITROËN BERLINGO (MF) 1.4 bivalent (APÓS 11.02) 65cv 1360cc Veículo multiuso CITROËN BERLINGO (MF) 1.4 (11.02 A 10.05) 72cv 1360cc Veículo multiuso - CITROËN BERLINGO (MF) 1.4 i (MFKFX - MFKFW) (07.96 A 10.08) 75cv 1360cc Veículo multiuso - CITROËN BERLINGO (MF) 1.4 i bivalent (MFKFW) (APÓS 04.03) 75cv 1360cc Veículo multiuso - CITROËN BERLI...etc.</p>
	<p>T0692-I NO. 503370</p> <p>BATENTE SUSPENSÃO DA FRENTE</p> <p>CITROËN BERLINGO (B 9) 1.6 (APÓS 04.08) 90cv 1587cc Veículo multiuso CITROËN BERLINGO (B 9) 1.6 VTI 95 (APÓS 07.10) 98cv 1598cc Veículo multiuso CITROËN BERLINGO (B 9) 1.6 (04.08) 109cv 1587cc Veículo multiuso CITROËN BERLINGO (B 9) 1.6 VTI 120 (APÓS 11.09) 120cv 1598cc Veículo multiuso CITROËN BERLINGO (B 9) 1.6 HDi 75 (APÓS 04.08) 75cv 1560cc Veículo multiuso - CITROËN BERLINGO (B 9) 1.6 HDi 90 (APÓS 04.08) 90cv 1560cc V...etc.</p>		<p>U7009 NO. 575181</p> <p>TENSORES CORREIA ALTERNADOR</p> <p>CITROËN BERLINGO - XANTIA - ZX</p>
	<p>W5003 NO. 0515P2 - 0515L8 - 0515L9 - 0515T8 - 0515V5 - 0515V6 - 0515Q3 - 0516A4 - 0516A6 - 051660</p> <p>POLIE DA CABBOTA (6 pistas)</p> <p>CITROËN BERLINGO 2.0 HDi (mot. DW10) - 1.9D (MOT DW10 TD-DW12 TE D4)</p>		<p>W5004 NO. 0515G3 - 051660 - 0516A4 - 0516A6</p> <p>POLIE DA CABBOTA (6 pistas)</p> <p>CITROËN BERLINGO (1.9 D 68-70CV - mot.XUD9)</p>

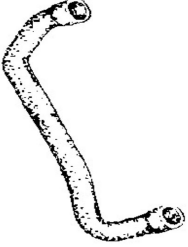
	<p>W5009 NO. 0515Q6 - 0515L7 - 0516A4 - 051660 - 9624596880 - 9637218980 - 9666471189 - 9634848980</p> <p>POLIE DA CAMBOTA (6 pistas)</p> <p>CITROËN BERLINGO 1.9D mot. DW8 s-clima (APÓS 1998)</p>		<p>W5024 NO. 0515H6</p> <p>POLIE DA CAMBOTA (6 pistas)</p> <p>CITROËN BERLINGO MOTORES LFY - XU7JP4 - RFV - XU10J4R - NFZ - XU75P</p>
	<p>W5029 NO. 0515.J3</p> <p>POLIE DA CAMBOTA (5 PISTAS)</p> <p>CITROËN BERLINGO MULTISPACE (1.6 16V)</p>		<p>W5030 NO. 0515.P5 - 0515.S1 - 0515.N0 - 0515.P1 - 0515.R8 - 0515.K1 - 9650653380 - 9636924480 - 9653771880 - 0...</p> <p>POLIE DA CAMBOTA (6 PISTAS)</p> <p>CITROËN BERLINGO 1.1 - 1.4 APÓS 2002</p>
	<p>W5086 NO. 0515.R8 - 0515.P1 - 0515.N0 - 0515.S1 - 9655703580</p> <p>POLIE DA CAMBOTA (6 PISTAS)</p> <p>CITROËN BERLINGO 1.6 16V (MOTOR NFU-TU5JP4) (APÓS 10-2000)</p>		<p>W5091 NO. 0515T3 - 0516A3 - 1690296 - 1487861 - AV6Q6B319AA - Y66211401 - Y40111406A - 11237801979 - 112378019...</p> <p>POLIE DA CAMBOTA (6 PISTAS)</p> <p>CITROËN BERLINGO (APÓS 07-2005) 1.6 Hdi (75-90)</p>
	<p>W5101 NO. 0515V6-0515T8</p> <p>POLIE DA CAMBOTA</p> <p>CITROËN BERLINGO 2.0 HDi - 1.9D</p>		<p>W5120 NO. 0515P8 - 0515T0 - 0515V0 - 0515V7 - 0515V4 - 0515V8 - 0515R0 - 0515TQ - 0516A3</p> <p>POLIE DA CAMBOTA (6 PISTAS)</p> <p>CITROËN - BERLINGO (MF) - 1.6 HDI 90 (MF9HX) (APÓS 07.05) 90cv 1560cc Veículo multiuso - CITROËN - BERLINGO (MF) - 1.6 HDI 110 (APÓS 08.05) 109cv 1560cc Veículo multiuso - CITROËN - BERLINGO Caixa (M_) - 1.6 HDI 90 (MB9HX - MC9HX) (APÓS 07.05) 90cv 1560cc</p>
	<p>W5125 NO. 120459 - 120447</p> <p>POLIE DA BOMBA DE ÁGUA</p> <p>CITROËN - BERLINGO (B9) - 1.6 VTi 120 (APÓS 11.09) 120cv 1598cc Veículo multiuso - CITROËN - BERLINGO Caixa (B9) - 1.6 VTi 120 (APÓS 11.09) 120cv 1598cc</p>		<p>Z10415 NO. 6547.20</p> <p>Mola de painel</p> <p>CITROËN BERLINGO</p>
	<p>Z80518 NO. 14115980 - 155809966 - 6992G2</p> <p>Mola de retenção</p> <p>CITROËN BERLINGO</p>		<p>Z80678 NO. 856535</p> <p>Mola de friso</p> <p>CITROËN BERLINGO</p>
	<p>Z80712 NO. 699050</p> <p>Mola de painel</p> <p>CITROËN BERLINGO</p>		<p>Z80720 NO. 696640</p> <p>Mola de painel</p> <p>CITROËN BERLINGO</p>
	<p>Z80838 NO. 6991.Y8 - 7703077468 - 7703077469 - 8201112162</p> <p>Mola</p> <p>CITROËN BERLINGO (Após 2009)</p>		

	<p>A0008 NO. 1807.47 - 915071180</p> <p>APOIO TRASEIRO DO MOTOR</p> <p>CITROËN BX 1.8D (0-1985 A 09-1993) - 1.9D (10-1983 A 09-1993)</p> <p>d70x53mm c40mm 1f-d10mm</p>		<p>A0330 NO. 96033565 - 91521643</p> <p>SUPORTE CAIXA DE VELOCIDADES ESQUERDO</p> <p>CITROËN BX 1.6 DIESEL TT</p> <p>100x70x42mm 1f-d12mm</p>
	<p>A1013 NO. 1843.88 - 7910032165</p> <p>SUPORTE DO MOTOR DIREITO FRENTE</p> <p>CITROËN BX</p> <p>89x61x40mm 2p-d10-16-28mm</p>		<p>A1028 NO. 91517554 - 91538407</p> <p>SUPORTE FRENTE DIREITO DO MOTOR</p> <p>CITROËN BX 1.6 DIESEL TT</p> <p>d82x79mm 1p-d10-22mm 1p-d10-31mm</p>
	<p>A1028-H NO. 91517554</p> <p>SUPORTE FRENTE DIREITO DO MOTOR (HIDRÁULICO)</p> <p>CITROËN BX 1.6 DIESEL TT</p> <p>d82x79mm 1p-d10-22mm 1p-d10-31mm</p>		<p>A1054 NO. 1844.17</p> <p>SUPORTE DO MOTOR</p> <p>CITROËN BX DIESEL</p> <p>NULL NULL</p>
	<p>A1098 NO. 91504873 - 5149.90 - 9150487380</p> <p>SUPORTE DO MOTOR</p> <p>CITROËN BX 1.4</p> <p>95x75x35mm 1p-d10-12mm 1p-d10-40mm</p>		<p>A1183 NO. 7910032165</p> <p>APOIO DIREITO DO MOTOR</p> <p>CITROËN BX 1.4 (MOTOR K1H-TU3A) (01-1989 A 12-1989)</p> <p>66x48x40mm 2p-d10-20mm</p>
	<p>BE16 NO. 5433461 - 5483762 - 95483762</p> <p>ABRÇADEIRA DE ESCAPE CÔNCAVA 66mm</p> <p>CITROËN BX (1985 A 1994)</p> <p>116x64x16mm 66mm</p>		<p>E0004 NO. 75420014 - 91503080 - 54200.14</p> <p>ESTICADOR DE ESCAPE</p> <p>CITROËN BX (1.4 - 1.6 - 1.9)</p> <p>65x45x24mm NULL</p>
	<p>E0031 NO. G-5420014W - 91503080 - 95576338</p> <p>ESTICADOR DE ESCAPE</p> <p>CITROËN BX TT (APÓS 82)</p> <p>64x45x40mm NULL</p>		<p>F0571-I NO. 95549619</p> <p>FOLE DO SEMI-EIXO JUNTO À RODA</p> <p>CITROËN BX TT</p> <p>d94x78mm 1f-d76 1f-d21mm</p>
	<p>F0803-I NO. 95025088 - 95590794</p> <p>FOLE DO SEMI-EIXO JUNTO À CAIXA DE VELOCIDADES</p> <p>CITROËN BX 1.6 - 1.9</p> <p>d80x95mm 1f-d74mm 1f-d21mm</p>		<p>F0821-I NO. 95495914 - 95604346</p> <p>FOLE DA DIRECÇÃO DIREITO E ESQUERDO</p> <p>CITROËN BX 1.1 - 1.4 . 1.6 - 1.9</p> <p>d73x196mm 1f-d47mm 1f-d11mm</p>
	<p>F0822-I NO. 95496072</p> <p>FOLE DA DIRECÇÃO ASSISTIDA ESQUERDO</p> <p>CITROËN BX 1.6 - 1.9</p> <p>d67x140mm 1f-d52mm 1f-d39mm</p>		<p>F0856-I NO. 95590794</p> <p>FOLE DO SEMI-EIXO JUNTO À CAIXA DE VELOCIDADES</p> <p>CITROËN BX 1.4</p> <p>d70x90mm 1f-d62mm 1f-d19mm</p>

	<p>F1286-I NO. 95618785 - 95653005</p> <p>FOLE DO LADO DA RODA (JUNTA d90mm EIXO d25mm)</p> <p>CITROËN BX GTI 16v. - BX - TURBO DIESEL 1769 cc. - BX 4x4 FRONT</p> <p>d98x98mm 1f-fd86mm 1f-d22mm</p>		<p>KF1470 NO. 95549619 - 95570874 - 95576824 - 95590840 - 95590795 - 95598211 - 95640919</p> <p>KIT FOLE DO LADO DA RODA</p> <p>CITROËN BX 1.1 - 1.4 - 1.6 - 1.9 - 1.9 D - TD - ZX 1.1 - 1.6 - 1.9 - TD - C 15</p> <p>d95x83mm 1f-d21mm 1f-d78mm</p>
	<p>M6011 NO. 95602682 - 95603555</p> <p>JUNTA DE ESCAPE</p> <p>CITROËN BX (1982 A 1994)</p> <p>d59.5x13.5mm 1f-d46.2mm</p>		<p>M6012 NO. 91516522 - 91537797 - 96033780 - 96038954 - 91539094</p> <p>JUNTA DE ESCAPE</p> <p>CITROËN BX (1984 A 1994)</p> <p>d79x14mm 1f-d66mm</p>
	<p>M6039 NO. 96000436</p> <p>JUNTA DE ESCAPE</p> <p>CITROËN BX (APÓS 1982)</p> <p>100x92mm 1f-d60mm</p>		<p>M6086 NO. 91537799 - 96587799</p> <p>JUNTA DE ESCAPE</p> <p>CITROËN BX (1988 A 1994)</p> <p>d70x13mm 1f-d58mm</p>
	<p>P1007 NO. 95575913</p> <p>CAPA DE PEDAL DO TRAVÃO E EMBRAIAGEM</p> <p>CITROËN BX</p> <p>68x45x11mm NULL</p>		<p>R021812 NO. 95636723 - 1413.95</p> <p>TUBO DE LIGAÇÃO DO CARBURADOR AO COLECTOR</p> <p>CITROËN BX (1.4)</p> <p>B245-d7/7mm 235-65mm</p>
	<p>R220425 NO. 95566627</p> <p>TUBO DE RADIADOR INFERIOR</p> <p>CITROËN BX (1.1 - 1.4)</p> <p>B425-d28/30mm 280-410-145-90-80mm</p>		<p>R220426 NO. 95581253</p> <p>TUBO DE RADIADOR SUPERIOR</p> <p>CITROËN BX (1.6 - 1.9= CARB. 1º TIPO))</p> <p>B455-d32/32mm 50-100-380-60mm</p>
	<p>R220428 NO. 95587675</p> <p>TUBO DE RADIADOR SUPERIOR</p> <p>CITROËN BX DIESEL (1.7 - 1.9)(APÓS 87)</p> <p>B365-d33/33mm 100-110-120-110-110mm</p>		<p>R220429 NO. 95587690</p> <p>TUBO DE RADIADOR INFERIOR</p> <p>CITROËN BX DIESEL (1.7 - 1.9)</p> <p>B500-d33/33mm 130-180-220-130-70mm</p>
	<p>R220902 NO. 95612501</p> <p>TUBO DE RADIADOR INFERIOR(APÓS TEL N. 3795)</p> <p>CITROËN BX (1.6 - 1.9 INJ.) - BX DIESEL (1.7 - 1.9)</p> <p>B490-d33/33mm 110-165-235-130-70mm</p>		<p>R220909 NO. 93510787 - 1307.J4</p> <p>TUBO DA BOMBA DE ÁGUA</p> <p>CITROËN BX DIESEL</p> <p>B102-d19/22mm 40-65mm</p>
	<p>R224627 NO. 95640596</p> <p>TUBO INFERIOR DO RADIADOR</p> <p>CITROËN BX (XB-) 1.8 D Especificação: 01/04/87- (10.85 A 09.93) 60cv 1769cc Hatchback - CITROËN BX (XB-) 19 D Ano fabric. a partir de: 04.87,(09.83 A 09.93) 47 64 1905 Hatchback CITROËN BX (XB-) 19 D Especificação: 01/04/87- (09.83 A 09.93) 64cv 1905cc Hatchback - CITROËN BX (XB-) 19 D Especificação: 01/04/87-01/05/92 (03.87 A 02.93) 69cv 1905cc Hatchback - CITROËN BX Break (XB-) 18 D Especificação: 01/04/87- (10.85 A 09.9...etc.</p> <p>B500-30/36mm 60-130-390-60-70mm 1ch-d14mm 300-18</p>		<p>S1154 NO. 96070064 - 95494716</p> <p>SILENT-BLOC EXTERIOR DO BRAÇO DA SUSPENSÃO DIANTEIRA</p> <p>CITROËN BX</p> <p>d50x50mm d40mm c32mm1f-d16mm</p>

	S1155	NO. 95637690 - 95494717		S1304	NO. 95644954 - 4059.07
	SILENT-BLOC CENTRAL DO BRAÇO DA SUSPENSÃO DIANTEIRA CITROËN BX			SILENT-BLOC DO PISTÃO DIREÇÃO ASSISTIDA CITROËN BX	
d40x46mm		c32mm 1f-d16mm	d22x24mm		c20mm 1f-d11.5mm
	U7000	NO. 95622818 - 95612275		W5001	NO. 0515k9
	TUBO DUPLO DEPRESSOR SUSPENSÃO HIDRÁULICA CITROËN BX			POLIE DA CAMBOTA (5 pistas) CITROËN BX (MOT XUD7)	
265x32x18mm		2f-d3mm	d142mm		d30mm
	W5022	NO. 0515.E9		Y3001	NO. 95608790 - 91521270 - 91521271 - 96118164
	POLIE DA CAMBOTA (5 pistas) CITROËN BX MOTOR DFW (XU9J4Z) D6C (XU9J4)			PARAFUSO DE ESCAPE CITROËN BX (1985 A 1994)	
d127mm		d42mm	65x8mm		1p-d6-15mm
	Y3003	NO. 91512792		Z80268	NO. 7903077112
	PARAFUSO ESCAPE CITROËN BX (1982 A 1988)			Mola de painel CITROËN BX	
d13x78mm		d7mm 1p-d7mm	d16.5x21mm		1p-d6.6-15mm
	Z80596	NO. 7903077167		Z80606	NO. 9609212380
	Mola de painel CITROËN BX			Mola de fixação CITROËN BX	
d12x20.4mm		1p-d6.5-18.4mm	d10x11mm		1p-d7-10mm 1f-d6mm
	Z9001	NO. 7910029764 - 91510245 - 75530745 - 9150246180			
	MOLA DE ESCAPE 26mm CITROËN BX (APÓS 1992)				
d21x26mm		NULL			

CITROËN C-CROSSER





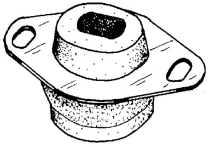
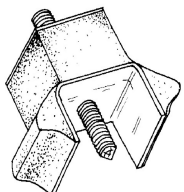
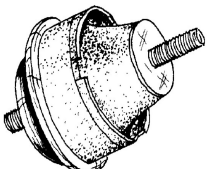
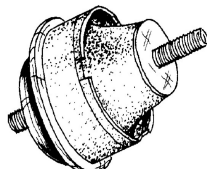

	W5115	NO. 9683886680 - 0515V3 - 515V3 - 1492251 - LR004247 - LR006672			
	POLIE DA CAMBOTA (6 PISTAS) CITROËN C CROSSER (EP) 2.2 HDI (APÓS 02-2007) 156CV 2179CC				
d153mm		d30mm			

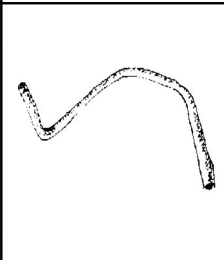
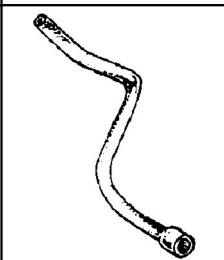
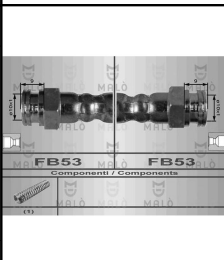
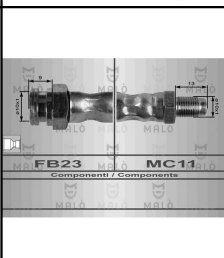
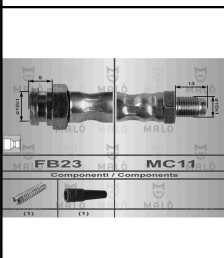
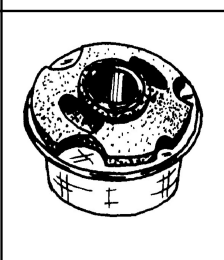
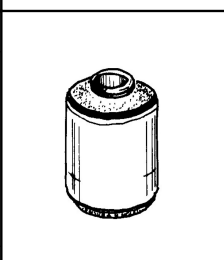
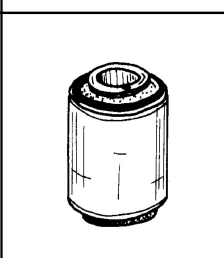

	A1922 NO. 1714E3 - 9642742880 - 1755E4 - 17565YV010 APOIO DO ESCAPE CITROËN C1 (PM_ - PN_) 1.4 HDi Sistema de escape: para tubo de escape - Local de montagem: à frente (APÓS 06.05) 54cv 1398cc Hatchback		E0160 NO. 5091.10 - 5094.A7 - 6822.G1 - 6822.R9 - 6822.S0 - 6822.TV - 48819-70010 - 48817-0D010 - 90177-W0002... ESTICADOR DA BARRA ESTABILIZADORA DA FRENTE CITROËN C1 TT (APÓS 06-2005)
53x39x45mm	2p-d6-18mm	100x33x31mm	2p-d8mm
	E0268-M NO. 180677 - 12363-YV010 - 12363-XV010 ESTICADOR MOTOR TRÁS CITROËN C1 (PM_ - PN_) 1.4 HDi (06.05 a 09.14) 54cv 1398cc Hatchback		E1118 NO. 1755K9 - 1755R4 ESTICADOR DO ESCAPE CITROËN C1 (PM_ - PN_) 1.0 (06.05 A 09.14) 68cv 998cc Hatchback - CITROËN C1 (PM_ - PN_) 1.4 HDi (06.05 A 09.14) 54cv 1398cc Hatchback
180x80x60mm	2f-d14mm	48x25x42mm	2f-d9mm
	KF1491-T NO. 329811 - 4601G0 - 04427-0D030 - 04428-0D030 - 04427-0H010 - 04428-0H010 - 43447-0H030 - 44280-0H010 KIT DE FOLE DO CÂRDAN JUNTO À RODA CITROËN C1 (APÓS 2005) 1.0i		RT80373 NO. 4806F6 TUBO DE TRAVÃO TRÁS LH-RH CITROËN C1 TT (APÓS 06-2005)
d76x100mm	1f-d70mm 1f-d20mm	255mm	FB77 - FB77
	RT80438 NO. 480600 - 4806E2 TUBO DE TRAVÃO FRENTE RH CITROËN C1 TT (APÓS 06-2005)		S1546 NO. 48654-16110 SILENT-BLOC DO BRAÇO DA SUSPENSÃO DA FRENTE PARTE DO CENTRO CITROËN C1 (PM_ - PN_) 1.0 Hatchback (APÓS 06.05) 68CV 998CC - CITROËN C1 (PM_ - PN_) 1.4 HDi Hatchback (APÓS 06.05) 54CV 1398CC
510mm	FB77 - OR127	d33x53mm	d33x30mm 1f-d12,5mm
	W5015 NO. 0515T0 - 0515P8 - 0515V0 - 0515V4 - 0515V7 - 0515V8 - 0515R0 - 0515TQ - 0516A3 - Y40111401A - Y4011... POLIE DA CAMBOTA (6 pistas) CITROËN C1 1.4 HDI MOTOR DV4 TD		W5120 NO. 0515P8 - 0515T0 - 0515V0 - 0515V7 - 0515V4 - 0515V8 - 0515R0 - 0515TQ - 0516A3 POLIE DA CAMBOTA (6 PISTAS) CITROËN - C1 (PM_ - PN_) - 1.4 HDi (APÓS 06.05) 54cv 1398cc Hatchback
d152.8mm	d30mm	d150/162mm	d29,5mm

CITROËN C15

	A0330 NO. 96033565 - 91521643 SUPORTE CAIXA DE VELOCIDADES ESQUERDO CITROËN C15 DIESEL		A1013 NO. 1843.88 - 7910032165 SUPORTE DO MOTOR DIREITO FRENTE CITROËN C15
100x70x42mm	1f-d12mm	89x61x40mm	2p-d10-16-28mm
	A1028 NO. 91517554 - 91538407 SUPORTE FRENTE DIREITO DO MOTOR CITROËN C15 DIESEL		A1028-H NO. 91517554 SUPORTE FRENTE DIREITO DO MOTOR (HIDRÁULICO) CITROËN C15 DIESEL
d82x79mm	1p-d10-22mm 1p-d10-31mm	d82x79mm	1p-d10-22mm 1p-d10-31mm

	<p>A1054 NO. 1844.17</p> <p>SUPORTE DO MOTOR</p> <p>CITROËN C15 1.1i - 1.4 - 1.4i - 1.8D</p> <p>NULL NULL</p>		<p>A1183 NO. 7910032165</p> <p>APOIO DIREITO DO MOTOR</p> <p>CITROËN C15 1.0 - 1.1 - 1.4 - 1.8D</p> <p>66x48x40mm 2p-d10-20mm</p>
	<p>E0026 NO. 5484441</p> <p>ESTICADOR DE ESCAPE</p> <p>CITROËN C15D (APÓS 84) - C15E-(APÓS 84)</p> <p>d60x30mm 1f-d43mm</p>		<p>F0571-I NO. 95549619</p> <p>FOLE DO SEMI-EIXO JUNTO À RODA</p> <p>CITROËN C15 DIESEL</p> <p>d94x78mm 1f-d76 1f-d21mm</p>
	<p>F0803-I NO. 95025088 - 95590794</p> <p>FOLE DO SEMI-EIXO JUNTO À CAIXA DE VELOCIDADES</p> <p>CITROËN C15 DIESEL</p> <p>d80x95mm 1f-d74mm 1f-d21mm</p>		<p>F1089-I NO. 9493293778</p> <p>FOLE DA TRANSMISSÃO LADO DA RODA</p> <p>CITROËN C15 1118cc - 1124cc</p> <p>d93x110mm 1f-d80mm 1f-d22mm</p>
	<p>F1301-I NO. 9609802380 - 329724</p> <p>FOLE DO LADO DA CAIXA</p> <p>CITROËN C15 - (APÓS 94)</p> <p>d90x100mm 1f-d78mm 1f-d25mm</p>		<p>F1633-I NO. 328781 - 329781</p> <p>FOLE DA TRANSMISSÃO JUNTO À CAIXA</p> <p>CITROËN C15 (84 A 97) 1.8D</p> <p>d87x104mm 1f-d80mm 1f-d34mm</p>
	<p>KB2067 NO.</p> <p>KIT DA BARRA ESTABILIZADORA (DIÂMETRO 23)</p> <p>CITROËN C15</p> <p>NULL NULL</p>		<p>KF1471-T NO. 329203 - 329303</p> <p>KIT DE FOLE DO CARDAN JUNTO À RODA</p> <p>CITROËN C15 1.8D (1984 A 1997) - CITROËN ZX 1.6i (1991 A 1997) - BERLINGO 1.8D - 1.8i - 1.9D - 1.9D 4WD - 2.0 HDi (APÓS 1996) - JUMPY 1.6i - 1.9D (APÓS 1994) - XANTIA 1.8i - 1.8i 16V - 1.9D SD - 1.9 TD - 2.0 HDi - 2.0i - 2.0i 16V (1993 A 2001) - XSARA 1.6</p> <p>d110x125mm 1f-d88mm 1f-d35mm</p>
	<p>L3019 NO. 509304</p> <p>CASQUILHO INFERIOR DO BRAÇO DA SUSPENSÃO</p> <p>CITROËN C15</p> <p>d47x11mm 1f-d20mm</p>		<p>M6011 NO. 95602682 - 95603555</p> <p>JUNTA DE ESCAPE</p> <p>CITROËN C15 D (APÓS 1984) - C15 E (APÓS 1988)</p> <p>d59.5x13.5mm 1f-d46.2mm</p>
	<p>M6039 NO. 96000436</p> <p>JUNTA DE ESCAPE</p> <p>CITROËN C15 (APÓS 1984)</p> <p>100x92mm 1f-d60mm</p>		<p>N8066 NO. 5460614 - 5481691 - ZF04437668 - 1755.92 - 1755.38 - 1755.60</p> <p>ANEL DE ESCAPE</p> <p>CITROËN C15 (APÓS 1984)</p> <p>d70x17mm 1f-d38mm</p>
	<p>P1007 NO. 95575913</p> <p>CAPA DE PEDAL DO TRAVÃO E EMBRAIAGEM</p> <p>CITROËN C15</p> <p>68x45x11mm NULL</p>		<p>R220618 NO. 93501397 - 93501394</p> <p>TUBO DA BOMBA DE ÁGUA</p> <p>CITROËN C15 DIESEL</p> <p>B107 - d22/19mm 30-85mm</p>

	R220949 NO. 141394 - 97533256 TUBO DO CARBURADOR CITROËN C15 1.4 B70-d10/10mm 55-90-160-70mm		R220952 NO. 96011359 - 96142709 TUBO DE RADIADOR INFERIOR CITROËN C15 DIESEL B455-d28/28mm 80-55-280-105-110mm
	R220953 NO. 96011773 - 96133835 TUBO DE RADIADOR SUPERIOR CITROËN C15 DIESEL B290-d30/30mm 75-210-110-100mm		R220957 NO. 95593279 - 95638650 TUBO DE AQUECIMENTO CITROËN C15 DIESEL B450-d15/15mm 50-70-110-140-150-145-125mm
	R220958 NO. 95593276 - 6464.FK TUBO DE AQUECIMENTO CITROËN C15 DIESEL B390-d15/15mm 60-110-180-115mm		RT08328 NO. 481626 - 91500635 - 96169410 TUBO DE TRAVÃO TRÁS LH-RH CITROËN C15 TT (10-1984 A 12-1997) 205mm FB53 - FB53
	RT08383 NO. 7910022619 - 7910021226 - 91500900 TUBO DE TRAVÃO FRENTE LH-RH CITROËN C15 1.0 - 1.1 - 1.4 (APÓS 10-1984) 370mm FB23 - MC11		RT08528 NO. 480629 TUBO DE TRAVÃO FRENTE LH-RH CITROËN C15 1.0 - 1.1 - 1.4 (MOTOR TU-E1-G1) (ATÉ 12-1997) 1.8D (10-1984 A 12-1997) 350mm FB23 - MC11
	S1082 NO. 91515653 SILENT-BLOC CENTRAL DO BRAÇO DE SUSPENSÃO FRENTE CITROËN C15 1.8D (07-1986 A 12-2000) d48x25mm d36mm 1f-d12mm		S1088 NO. 3523.20 - 91096727 - 352320 SILENT-BLOC DO BRAÇO DA SUSPENSÃO FRENTE CITROËN C15 1.1i - 1.4 - 1.4i - 1.4E - 1.8D d28x34mm c28mm 1f-d10mm
	S1089 NO. 96096727 - 7910035449 SILENT-BLOC DO BRAÇO DA SUSPENSÃO FRENTE CITROËN C15 1.1i - 1.4 - 1.4i - 1.4E - 1.8D d28x34mm c28mm 1f-d10mm		S1304 NO. 96044954 - 4059.07 SILENT-BLOC DO PISTÃO DIRECÇÃO ASSISTIDA CITROËN C15 d22x24mm c20mm 1f-d11.5mm
	S1305 NO. 1809.04 - 91201175 SILENT-BLOC DO TIRANTE TRASEIRO MOTOR CITROËN C15 (APÓS 1989) d30x34mm c28mm 1f-d12mm		T0053-P NO. 5094.37 - 91516332 BATENTE DA BARRA ESTABILIZADORA DA SUSPENSÃO FRENTE FURO 22mm (VERDE) CITROËN C15 55x38x32mm 1f-d20mm
	T0054-P NO. 5094.40 - 91539592 BATENTE DA BARRA ESTABILIZADORA DA SUSPENSÃO FRENTE FURO 23mm (AZUL) CITROËN C15 55x38x32mm 1f-23mm		W5001 NO. 0515k9 POLIE DA CAMBOTA (5 pistas) CITROËN C15 (MOT XUD7) (1986 A 2000) d142mm d30mm

	Y3003	NO. 91512792		Z9001	NO. 7910029764 - 91510245 - 75530745 - 9150246180
	PARAFUSO ESCAPE CITROËN C15 E (1984 A 1988)			MOLA DE ESCAPE 26mm CITROËN C15 D - E (APÓS 1984)	
	d13x78mm	d7mm 1p-d7mm		d21x26mm	NULL

CITROËN C2

	E0142	NO. 5087.45 - 96288787 - 9628878780		E1026	NO. 1755.F3 - 1755.J4 - 1755.J5
	ESTICADOR DA BARRA ESTABILIZADORA DA FRENTE CITROËN C2 TT - CITROËN C3 TT			ESTICADOR DE ESCAPE TRÁS CITROËN C2 1.1 (APÓS 09-2003) - 1.4 (APÓS 09-2003) - 1.4 HDi (APÓS 09-2003)	
	370x40x40mm	2p-d10-25mm		117x78x64mm	NULL
	F1820-I	NO. 328797		KF1408-T	NO. 329337
	FOLE DA TRANSMISSÃO JUNTO À CAIXA CITROËN C2 1.1i (APÓS 2003)			KIT DE FOLE DO CARDAN JUNTO À RODA CITROËN C2 (APÓS 2003) 1.1i	
	d85x88mm	1f-d73mm 1f-d19mm		d86x113mm	1f-d70mm 1f-d21mm
	KF1482-T	NO. 3293A3		RT08941	NO. 4806A1
	KIT DE FOLE DO CARDAN JUNTO À RODA CITROËN C2 (APÓS 2003) 1.4i HdI - 1.4i - 1.6i			TUBO DE TRAVÃO TRÁS LH-RH CITROËN C2 TT APÓS 11-2005	
	d91x117mm	1f-d75mm 1f-d22mm		210mm	FB23 - FZ
	RT80003	NO. 4806A9		RT80004	NO. 4806C0
	TUBO DE TRAVÃO FRENTE LH-RH CITROËN C2 TT			TUBO DE TRAVÃO TRÁS LH-RH CITROËN C2 TT A 10-2005	
	480mm	FZ - MC11		205mm	FB53 - FZ
	S1463	NO. 352398		S1479	NO. 3523AA - 3523.99 - 3523.AT - 9640877080 - 3520.L4 - 3520.L9 - 3521.H5 - 3521.H6 - 3521.J1 - 3521.J2 ...
	SILENT BLOC DO BRAÇO DA SUSPENSÃO DA FRENTE CITROËN C2 1.1 - 1.4 - 1.4HDi - 1.6 (APÓS 09-2003)			SILENT BLOC DA SUSPENSÃO DA FRENTE PARTE DE TRÁS CITROËN C2 1.1 - 1.4 - 1.4HDi - 1.6 (APÓS 09-2003)	
	d72x48mm	c20mm d56mm 1f-d18mm		d73x48mm	c19mm d56mm 1f-d18mm
	T0690-I	NO. 503382 - 5033A3		T0691-I	NO. 503382 - 5033A3
	BATENTE SUSPENSÃO DA FRENTE CITROËN C 2 (JM) 1.1 (APÓS 09.03) 60cv 1124cc Hatchback - CITROËN C 2 (JM) 1.4 (APÓS 09.03) 73cv 1360cc Hatchback - CITROËN C 2 (JM) 1.4 16 V (APÓS 06.06) 90cv 1360cc Hatchback - CITROËN C 2 (JM) 1.6 (APÓS 09.03) 109cv 1587cc Hatchback - CITROËN C 2 (JM) 1.4 HDi (APÓS 09.03) 68cv 1398cc Hatchback - CITROËN C 3 I (FC) 1.1 i (APÓS 02.02) 60cv 1124cc Hatchback - CITROËN C 3 I (FC) 1.4 i (APÓS 02.02) 73cv 1360cc Hatchback - CITRO...etc.			BATENTE SUSPENSÃO DA FRENTE CITROËN C 2 (JM) 1.1 (APÓS 09.03) 60cv 1124cc Hatchback - CITROËN C 2 (JM) 1.4 (APÓS 09.03) 73cv 1360cc Hatchback - CITROËN C 2 (JM) 1.4 16 V (APÓS 06.06) 90cv 1360cc Hatchback - CITROËN C 2 (JM) 1.6 (APÓS 09.03) 109cv 1587cc Hatchback - CITROËN C 2 (JM) 1.4 HDi (APÓS 09.03) 68cv 1398cc Hatchback - CITROËN C 3 I (FC) 1.1 i (APÓS 02.02) 60cv 1124cc Hatchback - CITROËN C 3 I (FC) 1.4 i (APÓS 02.02) 73cv 1360cc Hatchback - CITRO...etc.	
	d46x95mm	1f-d27mm 1f-d25mm		d46x94mm	1f-d26mm 1f-d20mm

CITROËN C2

	T0692-I NO. 503370 BATENTE SUSPENSÃO DA FRENTE CITROËN C2 (JM) 1.1 (APÓS 09.03) 60cv 1124cc Hatchback - CITROËN C2 (JM) 1.4 (APÓS 09.03) 73cv 1360cc Hatchback - CITROËN C2 (JM) 1.4 16 V (APÓS 06.06) - 90cv 1360cc Hatchback - CITROËN C2 (JM) 1.6 (APÓS 09.03) 109cv 1587cc Hatchback - CITROËN C2 (JM) 1.6 VTS (APÓS 01.05) 122cv 1587cc Hatchback - CITROËN C2 (JM) 1.4 HDi (APÓS 09.03) 68cv 1398cc Hatchback - CITROËN C2 (JM) 1.6 HDi (APÓS 09.05) 109cv 1560cc Hatchback d47x99mm 1f-d27mm 1f-d20mm		T0708-I NO. 516694 - 516667 - 516674 - 516696 - 9646179980 BATENTE DA SUSPENSÃO DE TRÁS CITROËN C2 (JM_) 1.1 (A Partir de 09.03) 60cv 1124cc Hatchback - CITROËN C2 (JM_) 1.4 (A Partir de 09.03) 73cv 1360cc Hatchback - CITROËN C2 (JM_) 1.4 16V (A Partir de 06.06) 90cv 1360cc Hatchback - CITROËN C2 (JM_) 1.6 (A Partir de 09.03) 109cv 1587cc Hatchback - CITROËN C2 (JM_) 1.6 VTS (A Partir de 01.05) 122cv 1587cc Hatchback - CITROËN C2 (JM_) 1.4 HDi (A Partir de 09.03) 68cv 1398cc Hatchback - CITROËN C2 (JM_) 1.6 Hdi (A...etc. 95x45mm NULL
	W5015 NO. 0515T0 - 0515P8 - 0515V0 - 0515V4 - 0515V7 - 0515V8 - 0515R0 - 0515TQ - 0516A3 - Y40111401A - Y4011... POLIE DA CAMBOTA (6 pistas) CITROËN C2 1.4 HDI MOTOR DV4 TD d152.8mm d30mm		W5086 NO. 0515.R8 - 0515.P1 - 0515.N0 - 0515.S1 - 9655703580 POLIE DA CAMBOTA (6 PISTAS) CITROËN C2 1.6 MOTORES TU5JP4 E ET3J4 d143mm d44mm
	W5087 NO. 0515.R4 - 0515.P7 - 0516.A4 - 0516.60 POLIE DA CAMBOTA (6 PISTAS) CITROËN C2 MOTOR 1.4 (TU3) MOTOR 1.6 (TU5) d149mm d44mm		W5091 NO. 0515T3 - 0516A3 - 1690296 - 1487861 - AV6Q6B319AA - Y66211401 - Y40111406A - 11237801979 - 11237801... POLIE DA CAMBOTA (6 PISTAS) CITROËN C2 (APÓS 09-2003) 1.4 Hdi d157mm d30mm
	W5120 NO. 0515P8 - 0515T0 - 0515V0 - 0515V4 - 0515V7 - 0515V8 - 0515R0 - 0515TQ - 0515TQ - 0516A3 POLIE DA CAMBOTA (6 PISTAS) CITROËN - C2 (JM_) - 1.4 HDi Ano fabric. até: (05.05) - N.º de Org. até: (10415) (APÓS 09.03) 68cv 1398cc Hatchback d150/162mm d29,5mm		Z80790 NO. 6991X7 Mola de fixação CITROËN C2 d20x34mm 1p-d8-14mm
	Z80832 NO. 812388 Mola CITROËN C2 67x11x10mm NULL		Z80838 NO. 6991.Y8 - 7703077468 - 7703077469 - 8201112162 Mola CITROËN C2 d17x18.5mm 1p-d7.5-10.5mm

CITROËN C25

	A1012 NO. 184361 APOIO TRASEIRO DO MOTOR (CAIXA DE VELOCIDADES) CITROËN C25 150x96x73mm 1f-d12mm		A1126 NO. 1944.41 APOIO DA CAIXA CITROËN C25 (APÓS 1991) 180x115x72mm 1f-d14mm
	A1184 NO. 5934176 - 1843.80 SUPORTE TRASEIRO DO MOTOR CITROËN C25 148x89x57mm 1f-d28mm		A1283 NO. APOIO DA CAIXA DE VELOCIDADES (SUPLEMENTO DO A1012) CITROËN C25 d70x64mm 1f-d12mm

	A1286 NO. APOIO DA CAIXA DE VELOCIDADES (SUPLEMENTO DO A1126) CITROËN C25 NOVO d85x68mm c54mm 1f-d14.5mm		E0003 NO. 4312280 - 4297083 - 4296050 ESTICADOR DE ESCAPE CITROËN C25 (81 A 82) 80x35x37mm NULL
	F0870-I NO. 95532953 - 95613146 - 95569341 FOLE DO SEMI-EIXO LADO DO DIFERENCIAL CITROËN C25 d104x98mm 1f-d96mm 1f-d24mm		F0871-I NO. 95569342 FOLE DO SEMI-EIXO LADO DA RODA CITROËN C25 d100x145mm 1f-d92mm 1f-d24mm
	F0902-I NO. 9750000380 FOLE DA DIRECÇÃO LADO DIREITO CITROËN C25 d64-220mm 1f-d37mm 1f-d11mm		F0924-I NO. 9750000280 FOLE DA DIRECÇÃO LADO ESQUERDO CITROËN C25 d65x155mm 1f-d49mm 1f-d10mm
	KF1455 NO. 95569342 - 3293.97 KIT FOLE DO LADO DA RODA CITROËN C25 d102x150mm 1f-d24mm 1f-d95mm		M6040 NO. 95604327 - 1710.92 JUNTA DE ESCAPE CITROËN C25D (1987 A 1990) 102x100mm 1f-d58mm
	N8066 NO. 5460614 - 5481691 - ZF04437668 - 1755.92 - 1755.38 - 1755.60 ANEL DE ESCAPE CITROËN C25 (APÓS 1984) d70x17mm 1f-d38mm		R221593 NO. 95572893 TUBO DE RADIADOR INFERIOR CITROËN C25 B370-d45/33mm 120-190-110-90mm
	W5024 NO. 0515H6 POLIE DA CAMBOTA (6 pistas) CITROËN C25 MOTORES LFY - XU7JP4 - RFV - XU10J4R - NFZ - XU75P d127mm d30mm		Z9001 NO. 7910029764 - 91510245 - 75530745 - 9150246180 MOLA DE ESCAPE 26mm CITROËN C25 D - E (1987 A 1994) d21x26mm NULL

CITROËN C3

	A1781 NO. 1807HR APOIO DO MOTOR FRENTE LADO DIREITO CITROËN C3 1.6 HDi 90 (DV6ATED4) 90CV (APÓS 11-2009) - 1.4 16V HDi 8HY (DV4TED4) 90CV (APÓS 02-2002) - 1.6 16V HDi 9HX (DV6ATED4) 90CV (APÓS 10-2005) 140x160x110mm NULL		E1026 NO. 1755.F3 - 1755.J4 - 1755.J5 ESTICADOR DE ESCAPE TRÁS CITROËN C3 1.1i (APÓS 02-2002) - 1.4i BIVALENT (APÓS 02-2002) - 1.4 HDi (APÓS 02-2002) - 1.4 HDi 16V (APÓS 02-2002) 117x78x64mm NULL
---	--	--	---



	E1026 NO. 1755.F3 - 1755.J4 - 1755.J5 ESTICADOR DE ESCAPE TRÁS CITROËN C3 PLURIEL 1.4 (APÓS 05-2003) - 1.4 HDi (APÓS 04-2004) - 1.6 (APÓS 05-2003)		E1035 NO. 112381035R ESTICADOR DE ESCAPE CITROËN C3 1.1i (APÓS 02-2002) - 1.4i (APÓS 02-2002) - 1.4 16V (APÓS 12-2003) - 1.4 HDi (APÓS 02-2002) - 1.4 HDi 16V (APÓS 02-2002) - C3 PLURIEL 1.4 (APÓS 05-2003) - 1.4 HDi (APÓS 04-2004) - 1.6 (APÓS 05-2003)
	E1036 NO. 1755J5 ESTICADOR DE ESCAPE CITROËN C3 1.1i (APÓS 02-2002) - 1.4 (APÓS 05-2003) - 1.4i (APÓS 02-2002) - 1.4 16V (APÓS 12-2003) - 1.4 HDi (APÓS 02-2002) - 1.4 HDi 16V (APÓS 02-2002) - 1.6 (APÓS 05-2003) - 1.6 16V (APÓS 04-2005)		F1821-I NO. 328788 - 3287.93 FOLE DA TRANSMISSÃO JUNTO À CAIXA CITROËN C3 1.4 HDi 16V (APÓS 2002)
	F1842-I NO. 328795 - 3287.94 FOLE DA TRANSMISSÃO JUNTO À CAIXA CITROËN C3 1.4 HDi 16V (APÓS 2002)		F1842-I NO. 328795 - 3287.94 FOLE DA TRANSMISSÃO JUNTO À CAIXA CITROËN C3 PLURIEL 1.4 HDi - 1.6i (APÓS 2003)
	KF1425 NO. 329320 KIT FOLE LADO RODA CITROËN C3 I (FC_) 1.4 16V HDi Mod. t ipo: Exclusive (A Partir de 02.02) 90cv 1398cc Hatchback		KF1425-T NO. 329320 KIT DE FOLE DO CARDAN JUNTO À RODA CITROËN C3 1.4 HDi 16V (APÓS 2002) - CITROËN C3 PLURIEL 1.4 HDi - 1.6i (APÓS 2003) - CITROËN C4 1.4i 16V - 1.6i 16V (APÓS 2004) - BERLINGO 1.1i - 1.4i (APÓS 1996) - BERLINGO MULTISPACE 1.1i - 1.4i (APÓS 1996) - XSARA 1.4i - 1.5D - 1.6i - 1.6i 16V (1997 A)
	KF1482-T NO. 3293A3 KIT DE FOLE DO CARDAN JUNTO À RODA CITROËN C3 (APÓS 2002) 1.1i - 1.4 HDi - 1.4i		RT80003 NO. 4806A9 TUBO DE TRAVÃO FRENTE LH-RH CITROËN C3 TT (APÓS 02-2002)
	RT80004 NO. 4806C0 TUBO DE TRAVÃO TRÁS LH-RH CITROËN C3 TT APÓS 02-2002		S1463 NO. 352398 SILENT BLOC DO BRAÇO DA SUSPENSÃO DA FRENTE CITROËN C3 1.1i - 1.4 HDi 1.4 16V HDi - 1.4i BIVALENT - 1.4 16V - 1.6 16V (APÓS 02-2002) - C3 PLURIEL 1.4 - 1.4HDi - 1.6 (APÓS 05-2003)
	S1479 NO. 3523AA - 3523.99 - 3523.AT - 9640877080 - 3520.L4 - 3520.L9 - 3521.H5 - 3521.H6 - 3521.J1 - 3521.J2 ... SILENT BLOC DA SUSPENSÃO DA FRENTE PARTE DE TRÁS CITROËN C3 1.1i - 1.4i BIVALENT - 1.4 16V - 1.4HDi - 1.4 16V HDi - 1.6 16V (APÓS 0-2002) - PLURIEL 1.4 - 1.4HDi - 1.6 (APÓS 04-2004)		T0679-I NO. 503372 BATENTE SUSPENSÃO DA FRENTE CITROËN C3 I (FC_) 1.1 i (APÓS 02.02) 60cv 1124cc Hatchback - CITROËN C3 I (FC_) 1.4 i (APÓS 02.02) 73cv 1360cc Hatchback - CITROËN C3 I (FC_) 1.4 i Bivalent (APÓS 02.02) 73cv 1360cc Hatchback - CITROËN C3 I (FC_) 1.4 16V (APÓS 12.03) 88cv 1360cc Hatchback - CITROËN C3 I (FC_) 1.6 16V (APÓS 02.02) 109cv 1587cc Hatchback - CITROËN C3 I (FC_) 1.4 HDi (APÓS 02.02) 68cv 1398cc Hatchback - CITROËN C3 I (FC_) 1.4 16V HDi (APÓS 02.02)...etc.
	T0692-I NO. 503370 BATENTE SUSPENSÃO DA FRENTE CITROËN C3 Pluriel (H B_) 1.4 (APÓS 05.03) 73cv 1360cc Cabriolet CITROËN C 3 Pluriel (H B) 1.6 (APÓS 05.03) 109cv 1587cc Cabriolet - CITROËN C3 Pluriel (H B) 1.4 HDi (APÓS 04.04) 68cv 1398cc Cabriolet		T0692-I NO. 503370 BATENTE SUSPENSÃO DA FRENTE CITROËN C3 I (FC) 1.1 i (APÓS 02.02) 60cv 1124cc Hatchback - CITROËN C3 I (FC) 1.4 i (APÓS 02.02) 73cv 1360cc Hatchback - CITROËN C3 I (FC) 1.4 i Bivalent (APÓS 02.02) 73cv 1360cc Hatchback - CITROËN C3 I (FC) 1.4 16 V (APÓS 12.03) 88cv 1360cc Hatchback - CITROËN C3 I (F C) 1.6 16 V (APÓS 02.02) 109cv 1587cc Hatchback - CITROËN C3 I (F C) 1.4 HDi (APÓS 02.02) 68cv 1398cc Hatchback - CITROËN C3 I (FC) 1.4 16 V HDi (APÓS 02.02) ...etc.

	<p>T0692-I NO. 503370</p> <p><i>BATENTE SUSPENSÃO DA FRENTE</i></p> <p>CITROËN C 3 II 1.1 (APÓS 11.09) 60cv 1124cc Hatchback - CITROËN C 3 II 1.4 (APÓS 11.09) 73cv 1360 Hatchback 2/3 - CITROËN C 3 II 1.4 (APÓS 11.09) 73cv 1360cc Hatchback - CITROËN C 3 II 1.4 VTI 95 (APÓS 11.09) 95cv 1397cc Hatchback - CITROËN C 3 II 1.6 VTI 120 (APÓS 11.09) 120cv 1598cc Hatchback - CITROËN C 3 II 1.4 HDi 70 (APÓS 11.09) 68cv 1398cc Hatchback - CITROËN C 3 II 1.6 HDi (APÓS 11.09) 92cv 1560cc Hatchback - CITROË...etc.</p> <p>d47x99mm 1f-d27mm 1f-d20mm</p>		<p>T0692-I NO. 503370</p> <p><i>BATENTE SUSPENSÃO DA FRENTE</i></p> <p>CITROËN C 3 Picasso 1.4 VTI 95 (APÓS 02.09) 95cv 1397cc Veículo multiuso - CITROËN C 3 Picasso 1.6 VTI 120 (APÓS 02.09) 120cv 1598cc Veículo multiuso - CITROËN C 3 Picasso 1.6 HDi (APÓS 02.09) 90cv 1560cc Veículo multiuso - CITROËN C 3 Picasso 1.6 HDi 90 (APÓS 07.10) 92cv 1560cc Veículo multiuso - CITROËN C 3 Picasso 1.6 HDi (APÓS 02.09) 109cv 1560cc Veículo multiuso - CITROËN C 3 Picasso 1.6 HDi 110 (APÓS 05.10) 112cv 1560cc...etc.</p> <p>d47x99mm 1f-d27mm 1f-d20mm</p>
	<p>T0708-I NO. 516694 - 516667 - 516674 - 516696 - 9646179980</p> <p><i>BATENTE DA SUSPENSÃO DE TRÁS</i></p> <p>CITROËN C3 I (FC_) 1.1 i (A Partir de 02.02) 60cv 1124cc Hatchback - CITROËN C3 I (FC_) 1.4 i (A Partir de 02.02) 73cv 1360cc Hatchback - CITROËN C3 I (FC_) 1.4 i Bivalent (A Partir de 02.02) 73cv 1360cc Hatchback - CITROËN C3 I (FC_) 1.4 16V (A Partir de 12.03) 88cv 1360cc Hatchback - CITROËN C3 I (FC_) 1.6 16V (A Partir de 02.02) 109cv 1587cc Hatchback - CITROËN C3 I (FC_) 1.4 HDi (A Partir de 02.02) 68cv 1398cc Hatchback - Cl...etc.</p> <p>95x45mm NULL</p>		<p>T0708-I NO. 516694 - 516667 - 516674 - 516696 - 9646179980</p> <p><i>BATENTE DA SUSPENSÃO DE TRÁS</i></p> <p>CITROËN C3 II 1.1 (A Partir de 11.09) 60cv 1124cc Hatchback - CITROËN C3 II 1.4 (A Partir de 11.09) 73cv 1360cc Hatchback - CITROËN C3 II 1.4 VTI 95 (A Partir de 11.09) 95cv 1397cc Hatchback - CITROËN C3 II 1.6 VTI 120 (A Partir de 11.09) 120cv 1598cc Hatchback - CITROËN C3 II 1.4 HDi 70 (A Partir de 11.09) 68cv 1398cc Hatchback - CITROËN C3 II 1.6 HDi (A Partir de 11.09) 92cv 1560cc Hatchback - CITROËN C3 II 1.6 HDi 110 (A Par...etc.</p> <p>95x45mm NULL</p>
	<p>T0708-I NO. 516694 - 516667 - 516674 - 516696 - 9646179980</p> <p><i>BATENTE DA SUSPENSÃO DE TRÁS</i></p> <p>CITROËN C3 Pluriel (HB_) 1.4 (A Partir de 05.03) 73cv 1360cc Cabriolet - CITROËN C3 Pluriel (HB_) 1.6 (A Partir de 05.03) 109cv 1587cc Cabriolet - CITROËN C3 Pluriel (HB_) 1.4 HDi (A Partir de 04.04) 68cv 1398cc Cabriolet</p> <p>95x45mm NULL</p>		<p>W5015 NO. 0515T0 - 0515P8 - 0515V0 - 0515V4 - 0515V7 - 0515V8 - 0515R0 - 0515TQ - 0516A3 - Y40111401A - Y40111...</p> <p><i>POLIE DA CAMBOTA (6 PISTAS)</i></p> <p>CITROËN C3 1.4 HDI MOTOR DV4 TD</p> <p>d152.8mm d30mm</p>
	<p>W5030 NO. 0515.P5 - 0515.S1 - 0515.N0 - 0515.P1 - 0515.R8 - 0515.K1 - 9650653380 - 9636924480 - 9653771880 - 0...</p> <p><i>POLIE DA CAMBOTA (6 PISTAS)</i></p> <p>CITROËN C3 1.4 16V - 1.6 - 1.6 16V (MOTOR (TU5JP4) (ET3J4)</p> <p>d143mm d44mm</p>		<p>W5086 NO. 0515.R8 - 0515.P1 - 0515.N0 - 0515.S1 - 9655703580</p> <p><i>POLIE DA CAMBOTA (6 PISTAS)</i></p> <p>CITROËN C3 1.6 MOTORES TU5JP4 E ET3J4</p> <p>d143mm d44mm</p>
	<p>W5087 NO. 0515.R4 - 0515.P7 - 0516.A4 - 0516.60</p> <p><i>POLIE DA CAMBOTA (6 PISTAS)</i></p> <p>CITROËN C3 MOTOR 1.4 (TU3) MOTOR 1.6 (TU5)</p> <p>d149mm d44mm</p>		<p>W5091 NO. 0515T3 - 0516A3 - 1690296 - 1487861 - AV606B319AA - Y66211401 - Y40111406A - 11237801979 - 1123780...</p> <p><i>POLIE DA CAMBOTA (6 PISTAS)</i></p> <p>CITROËN C3 (APÓS 02-2002) - 1.4 Hdí (APÓS 04-2004) 1.4 Hdí - PLURIEL (APÓS 09-2005) 1.6 Hdí 16V</p> <p>d157mm d30mm</p>
	<p>W5120 NO. 0515P8 - 0515T0 - 0515V0 - 0515V7 - 0515V4 - 0515V8 - 0515R0 - 0515TQ - 0516A3</p> <p><i>POLIE DA CAMBOTA (6 PISTAS)</i></p> <p>CITROËN - C3 I (FC_) - 1.4 HDi (APÓS 02.02) 68cv 1398cc Hatchback - CITROËN - C3 I (FC_) - 1.4 16V HDi (APÓS 02.02) 90cv 1398cc Hatchback - CITROËN - C3 I (FC_) - 1.6 16V HDi (APÓS 10.05) 90cv 1560cc Hatchback - CITROËN - C3 I (FC_) - 1.6 16V HDi (APÓS</p> <p>d150/162mm d29,5mm</p>		<p>W5125 NO. 120459 - 120447</p> <p><i>POLIE DA BOMBA DE ÁGUA</i></p> <p>CITROËN - C3 II - 1.6 VTI (APÓS 11.09) 120cv 1598cc Hatchback - CITROËN - C3 Picasso - 1.4 VTI Equipamento do veículo: para veículos com caixa de velocidades manual - ID t ransm.: BE4R (APÓS 02.09) 95cv 1397cc Veículo multiuso - CITROËN - C3 Picasso - 1.6</p> <p>d123mm d20mm</p>
	<p>Z80518 NO. 14115980 - 155809966 - 6992G2</p> <p><i>Mola de retenção</i></p> <p>CITROËN C3</p> <p>d13x9mm 1p-7x7-8mm 1f-d4.8mm</p>		<p>Z80754 NO. 6991S6</p> <p><i>Mola de painel</i></p> <p>CITROËN C3</p> <p>d18x18mm 1p-10.5x7.8-10mm</p>
	<p>Z80790 NO. 6991X7</p> <p><i>Mola de fixação</i></p> <p>CITROËN C3</p> <p>d20x34mm 1p-d8-14mm</p>		<p>Z80838 NO. 6991.Y8 - 7703077468 - 7703077469 - 8201112162</p> <p><i>Mola</i></p> <p>CITROËN C3</p> <p>d17x18.5mm 1p-d7.5-10.5mm</p>

	BE20	NO. 5453900 - 54837624		
	ABRAÇADEIRA DE ESCAPE CÔNCAVA 69mm CITROËN C35D (1975 A 1994) - C35E (1975 A 1994)			
	110x64x18mm	NULL		



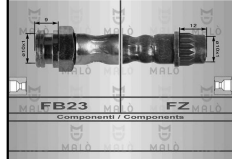



CITROËN C4

	A1788	NO. 1807GF - 1807XZ - 1807EV		A1920	NO. 1755E1 - 1755F6 - 1755G2 - 1755K1 - 1755K3
	APOIO DO MOTOR PARTE DA FRENTE LADO DIREITO CITROËN C4 (B7) 1.6 HDi 110 9HR (DV6C) 112CV (APÓS 11-2009) - 1.6 HDi 90 9HP (DV6DTE) 92CV (APÓS 11-2009) - C4 (LC_) 1.6 HDi 9HX (DV6ATED4) 90CV (APÓS 11-2004) - 1.6 HDi 9HZ (DV6TED4) 109CV (APÓS 11-2004) - C4 Coupé (LA_) 1.6 HDi 9HX (DV6ATED4) 90CV (APÓ			APOIO DO ESCAPE CITROËN C4 I (LC_) 1.4 16V Sistema de escape: para a panela de escape central - Local de montagem: à frente (11.04 A 07.11) 88cv 1360cc Hatchback - CITROËN C4 I (LC_) 1.6 HDi Local de montagem: à frente (11.04 A 07.11) 90cv 1560cc Hatchback - CITROËN C4 Coupé (LA_) 1.4 16V Sistema de escape: para a panela de escape central - Local de montagem: à frente (11.04 A 07.11) 88cv 1360cc Coupé - CITROËN C4 Coupé (LA_) 1.6 HDi Local de mont a...etc.	
	160x125x160mm	3f-d11mm 3f-d12mm 1f-d10mm		160x65x38mm	2p-d6-18mm
	E1023	NO.		E1023	NO.
	ESTICADOR DE ESCAPE CITROËN C4 1.6 HDi (APÓS 11-2004) - 2.0 16V (APÓS 11-2004) - 2.0 HDi (APÓS 11-2004)			ESTICADOR DE ESCAPE CITROËN C4 COUPÉ 1.6 16V (APÓS 11-2004) - 1.6 HDi (APÓS 11-2004) - 2.0 16V (APÓS 11-2004) - 2.0 HDi (APÓS 11-2004)	
	110x38x50mm	NULL		110x38x50mm	NULL
	E1103	NO. 1755C8 - 1755K4 - 1755P5		E1114	NO. 1755A7 - 1755E6 - 1755E7 - 1755K0 - 175594
	ESTICADOR DO ESCAPE PARTE DO CENTRO CITROËN - C4 (LC_) - 1.4 16V Hatchback 88CV 1360cc (APÓS 11-2004) - 2.0 HDi Hatchback 136CV 1997cc (APÓS 11-2004) - C4 COUPÉ (LA_) - 1.4 16V 88CV 1360cc (APÓS 11-2004) - C4 Coupé (LA_) - 2.0 HDi 136CV 1997cc (APÓS 11-2004)			APOIO DO ESCAPE CITROËN C4 I (LC_) 2.0 HDi Sist ema de escape: para catalizador - Equipamento do veículo: para veículos com filtro de partículas diesel (DPF) (11.04 A 07.11) 136cv 1997cc Hatchback - CITROËN C4 Coupé (LA_) 2.0 HDi Sistema de escape: para catalizador - Equipamento do veículo: para veículos com filtro de partículas diesel (DPF) (11.04 A 12.10) 136cv 1997cc Coupé - CITROËN C4 Picasso I (UD_) 2.0 HDi 138 Sistema de escape: para catalizad...etc.	
	81x59x26mm	2f-d14mm		65x39x20mm	1f-d9mm 1f-d15mm
	F1633-I	NO. 328781 - 329781		F1821-I	NO. 328788 - 3287.93
	FOLE DA TRANSMISSÃO JUNTO À CAIXA CITROËN C4 (APÓS 11-04) 1.6HDi - 2.0i 16V			FOLE DA TRANSMISSÃO JUNTO À CAIXA CITROËN C4 1.4i 16V - 1.6i 16V (APÓS 2004)	
	d87x104mm	1f-d80mm 1f-d34mm		d77x85mm	1f-d72mm 1f-d28mm
	KF1425	NO. 329320		KF1472-T	NO. 329302 - 329334
	KIT FOLE LADO RODA CITROËN C4 I (LC_) 1.4 16V (11.04 A 07.11) 88cv 1360cc Hatchback - CITROËN C4 I (LC_) 1.6 16V (11.04 A 07.11) 109cv 1587cc Hatchback - CITROËN C4 I (LC_) 2.0 16V (11.04 A 07.07) 136cv 1997cc Hatchback - CITROËN C4 I (LC_) 2.0 16V (11.04 A 07.11) 140cv 1997cc Hatchback - CITROËN C4 I (LC_) 2.0 16V (11.04 A 07.08) 177cv 1997cc Hatchback - CITROËN C4 I (LC_) 1.6 HDi (11.04 A 07.11) 90cv 1560cc Hatchback - CITROËN C4 I (LC_) 1.6 HD...etc.			KIT DE FOLE DO CARDAN JUNTO À RODA CITROËN C4 2.0 HDi 16V (APÓS 2004) - CITROËN C5 2.0 HDi - 2.2 HDi - 3.0i V6 (APÓS 2001) - CITROËN XM 2.5 TD - 3.0i V6 (1994 A 2000) - XANTIA 2.0 HDi - 2.0i - 2.0i T - 2.1 TD 12V (1993 A 2001)	
	d96x110mm	1f-d30mm 1f-d77mm		d110x135mm	1f-d98mm 1f-d39mm
	KF1480-T	NO. 329331		KF2461-T	NO. 329331
	KIT DE FOLE DO CARDAN JUNTO À RODA CITROËN C4 (APÓS 2004) 1.6 HDi - 2.0i 16V			KIT DE FOLE DO CARDAN JUNTO À RODA CITROËN C4 (APÓS 11-2004) 1.6HDI	
	d107x117mm	1f-d89mm 1f-d35mm		d107x117mm	1f-d83mm 1f-d35mm

	<p>RT08940 NO. 4806A0</p> <p>TUBO DE TRAVÃO FRENTE LH-RH</p> <p>CITROËN C4 TT</p>		<p>RT08941 NO. 4806A1</p> <p>TUBO DE TRAVÃO TRÁS LH-RH</p> <p>CITROËN C4 TT</p>
	<p>RT80440 NO. 4806G4</p> <p>TUBO DE TRAVÃO FRENTE LH-RH</p> <p>CITROËN C4 GRAND PICASSO 1.6 16V (APÓS 07-2008) - C4 GRAND PICASSO 1.6 Hdi (APÓS 10-2006) - C4 GRAND PICASSO 1.8 i 16V (APÓS 10-2006) - C4 GRAND PICASSO 2.0 Hdi (APÓS 10-2006) - C4 GRAND 2.0 i 16V (APÓS 10-2006)</p>		<p>RT80440 NO. 4806G4</p> <p>TUBO DE TRAVÃO FRENTE LH-RH</p> <p>CITROËN C4 PICASSO 1.6 Hdi (APÓS 02-2007) - C4 PICASSO 1.6 THP 140 (APÓS 07-2008) - C4 PICASSO 1.6 Vti 120 (APÓS 07-2008) - C4 PICASSO 1.8 i 16V (APÓS 02-2007) - C4 PICASSO 2.0 Hdi (APÓS 02-2007) - C4 PICASSO 2.0 i 16V (APÓS 02-2007)</p>
	<p>RT80441 NO. 4806G5</p> <p>TUBO DE TRAVÃO TRÁS LH-RH</p> <p>CITROËN C4 GRAND PICASSO 1.6 16V (APÓS 07-2008) - C4 GRAND PICASSO 1.6 Hdi (APÓS 10-2006) - C4 GRAND PICASSO 1.8 i 16V (APÓS 10-2006) - C4 GRAND PICASSO 2.0 Hdi (APÓS 10-2006) - C4 GRAND PICASSO 2.0 i 16V (APÓS 10-2006)</p>		<p>RT80441 NO. 4806G5</p> <p>TUBO DE TRAVÃO TRÁS LH-RH</p> <p>CITROËN C4 PICASSO 1.6 Hdi (APÓS 02-2007) - C4 PICASSO 1.6 THP 140 (APÓS 07-2008) - C4 PICASSO 1.6 Vti 120 (APÓS 07-2008) - C4 PICASSO 1.8 i 16V (APÓS 02-2007) - C4 PICASSO 2.0 Hdi (APÓS 02-2007) - C4 PICASSO 2.0 i 16V (APÓS 02-2007)</p>
	<p>S1587 NO. 9676035280 - 9807892380 - 9678311280 - 9678311380 - 9807914180 - 9807914280</p> <p>SILENT BLOC DO BRAÇO DA SUSPENSÃO DA FRENTE</p> <p>CITROËN C4 Grand Picasso II 1.2 THP 130 (A Partir de 04.14) 130cv 1199cc Veículo multiuso - CITROËN C4 Grand Picasso II 1.6 VTI 120 (A Partir de 09.13) 120cv 1598cc Veículo multiuso - CITROËN C4 Grand Picasso II 1.6 THP 155 (A Partir de 09.13) 156cv 1598cc Veículo multiuso - CITROËN C4 Grand Picasso II 1.6 THP 165 (A partir de 07.14) 165cv 1598cc Veículo multiuso - CITROËN C4 Grand Picasso II 1.6 HDi 90 (A partir de 09.13) 92cv ...etc.</p>		<p>S1587 NO. 9676035280 - 9807892380 - 9678311280 - 9678311380 - 9807914180 - 9807914280</p> <p>SILENT BLOC DO BRAÇO DA SUSPENSÃO DA FRENTE</p> <p>CITROËN C4 Picasso II 1.2 THP 130 (A Partir de 04.14) 130cv 1199cc Veículo multiuso - CITROËN C4 Picasso II 1.6 VTI 120 (A Partir de 02.13) 120cv 1598cc Veículo multiuso - CITROËN C4 Picasso II 1.6 THP 155 (A Partir de 02.13) 156cv 1598cc Veículo multiuso - CITROËN C4 Picasso II 1.6 THP 165 (A partir de 07.14) 165cv 1598cc Veículo multiuso - CITROËN C4 Picasso II 1.6 HDi 90 (A Partir de 02.13) 92cv 1560cc Veículo multiuso - CITRO...etc.</p>
	<p>S1588 NO. 9676032180</p> <p>SILENT BLOC DO BRAÇO DA SUSPENSÃO DA FRENTE</p> <p>CITROËN C4 Grand Picasso II 1.2 THP 130 (A Partir de 04.14) 130cv 1199cc Veículo multiuso - CITROËN C4 Grand Picasso II 1.6 VTI 120 (A Partir de 09.13) 120cv 1598cc Veículo multiuso - CITROËN C4 Grand Picasso II 1.6 THP 155 (A Partir de 09.13) 156cv 1598cc Veículo multiuso - CITROËN C4 Grand Picasso II 1.6 THP 165 (A Partir de 07.14) 165cv 1598cc Veículo multiuso - CITROËN C4 Grand Picasso II 1.6 HDi 90 (A Partir de 09.13) 92cv ...etc.</p>		<p>S1588 NO. 9676032180</p> <p>SILENT BLOC DO BRAÇO DA SUSPENSÃO DA FRENTE</p> <p>CITROËN C4 Picasso II 1.2 THP 130 (A Partir de 04.14) 130cv 1199cc Veículo multiuso - CITROËN C4 Picasso II 1.6 VTI 120 (A Partir de 02.13) 120cv 1598cc Veículo multiuso - CITROËN C4 Picasso II 1.6 THP 155 (A Partir de 02.13) 156cv 1598cc Veículo multiuso - CITROËN C4 Picasso II 1.6 THP 165 (A Partir de 07.14) 165cv 1598cc Veículo multiuso - CITROËN C4 Picasso II 1.6 HDi 90 (A Partir de 02.13) 92cv 1560cc Veículo multiuso - CI...etc.</p>
	<p>T0692-I NO. 503370</p> <p>BATENTE SUSPENSÃO DA FRENTE</p> <p>CITROËN C 4 Coupé (L A) 1.4 16 V (11.04 A 07.11) 88cv 1360cc Coupé - CITROËN C 4 Coupé - (L A) 1.6 16 V (11.04 A 07.11) 109cv 1587cc Coupé - CITROËN C 4 Coupé (L A) 1.6 VTI 120 (07.08 A 07.11) 120cv 1598cc Coupé - CITROËN C 4 Coupé (L A) 1.6 THP 150 (07.08 A 07.11) 150cv 1598cc Coupé - CITROËN C 4 Coupé (L A) 2.0 16 V (11.04 A 07.07) 136cv 1997cc Coupé - CITROËN C 4 Coupé (L A) 2.0 16 V (11.04 A 12.10) 177cv 1997cc Coupé...etc.</p>		<p>T0692-I NO. 503370</p> <p>BATENTE SUSPENSÃO DA FRENTE</p> <p>CITROËN C 4 I (L C) 1.4 16 V (11.04 A 07.11) 88cv 1360 Hatchback - CITROËN C 4 I (L C) 1.6 16 V (11.04 A 07.11) 109cv 1587cc Hatchback - CITROËN C 4 I (L C) 1.6 16 V Bio - Flex (09.07 A 07.08) 109cv 1587cc Hatchback - CITROËN C 4 I (L C) 1.6 VTI 120 (07.08 A 07.11) 120cv 1598cc Hatchback - CITROËN C 4 I (L C) 1.6 THP 140 (07.08 A 07.11) 140cv 1598cc Hatchback - CITROËN C 4 I (L C) 1.6 THP 150 (07.08 A 07.11) 150cv 1598cc Hatchback - C...etc.</p>
	<p>T0692-I NO. 503370</p> <p>BATENTE SUSPENSÃO DA FRENTE</p> <p>CITROËN C 4 II (B 7) 1.4 VTI 95 (APÓS 11.09) 95cv 1397cc Hatchback - CITROËN C 4 II (B 7) 1.6 VTI 120 (APÓS 11.09) 120cv 1598cc Hatchback - CITROËN C 4 II (B 7) 1.6 THP 155 (APÓS 11.09) 156cv 1598cc Hatchback - CITROËN C 4 II (B 7) 1.6 HDi 90 (APÓS 11.09) 92cv 1560cc Hatchback - CITROËN C 4 II (B 7) 1.6 HDi 110 (APÓS 11.09) 112cv 1560cc Hatchback - CITROËN C 4 II (B 7) 2.0 Blu e HDi 150 (APÓS 11.09) 150cv 1997cc Hatchback</p>		<p>T0692-I NO. 503370</p> <p>BATENTE SUSPENSÃO DA FRENTE</p> <p>CITROËN C4 Picasso I (UD) 1.6 VTI 120 (07.08 A 08.13) 120cv 1598cc Veículo multiuso - CITROËN C4 Picasso I (UD) 1.6 THP 140 (07.08 A 08.13) 140cv 1598cc Veículo multiuso - CITROËN C4 Picasso I (UD) 1.6 THP 155 (09.10 A 08.13) 156cv 1598cc Veículo multiuso - CITROËN C4 Picasso I (UD) 1.8 i 16V (02.07 A 12.11) 125cv 1749cc Veículo multiuso - CITROËN C4...etc.</p>
	<p>T0693-I NO. 503385 - 5033C6 - 9644207980 - 9683421580</p> <p>BATENTE SUSPENSÃO DA FRENTE</p> <p>CITROËN C4 I (L C) 2.0 16V (11.04 A 07.11) 140cv 1997cc Hatchback - CITROËN C4 I (L C) 2.0 16V (11.04 A 07.08) 177cv 1997cc Hatchback - CITROËN C4 Coupé (L A) 2.0 16V (11.04 A 12.10) 177cv 1997cc Coupé</p>		<p>W5015 NO. 0515T0 - 0515P8 - 0515V0 - 0515V4 - 0515V7 - 0515V8 - 0515R0 - 0515TQ - 0516A3 - Y - Y40111401A - Y...</p> <p>POLIE DA CABBOTA (6 pistas)</p> <p>CITROËN C4 1.4 HDI MOTOR DV4 TD</p>

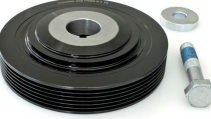
	<p>W5085 NO. 0514Q8 - 96433641</p> <p>POLIE DA CAMBOTA (6 PISTAS)</p> <p>CITROËN C4 2.0 HDi 16V FAP (136CV) (APÓS 01-2005)</p> <p>d153/158mm d16mm</p>		<p>W5086 NO. 0515.R8 - 0515.P1 - 0515.N0 - 0515.S1 - 9655703580</p> <p>POLIE DA CAMBOTA (6 PISTAS)</p> <p>CITROËN C4 1.4 16V MOTOR KFU-ET3J4 - 1.6 16V MOTOR NFU-TU5JP4</p> <p>d143mm d44mm</p>
	<p>W5087 NO. 0515.R4 - 0515.P7 - 0516.A4 - 0516.60</p> <p>POLIE DA CAMBOTA (6 PISTAS)</p> <p>CITROËN C4 MOTOR 1.4 (TU3) MOTOR 1.6 (TU5)</p> <p>d149mm d44mm</p>		<p>W5091 NO. 0515T3 - 0516A3 - 1690296 - 1487861 - AV/606B319AA - Y86211401 - Y40111406A - 11237801979 - 11237801...</p> <p>POLIE DA CAMBOTA (6 PISTAS)</p> <p>CITROËN C4 (APÓS 11-2004) 1.6 Hdi 90 - 1.6 Hdi 110FAP - 1.6 Hdi 90 COUPÉ - 1.6 Hdi 110 FAP COUPÉ (APÓS 10-2006) - 1.6 HDi GRAND PICASSO</p> <p>d157mm d30mm</p>
	<p>W5120 NO. 0515P8 - 0515T0 - 0515V0 - 0515V7 - 0515V4 - 0515V8 - 0515R0 - 0515TQ - 0516A3</p> <p>POLIE DA CAMBOTA (6 PISTAS)</p> <p>CITROËN - C4 I (LC_) - 1.6 HDi Código do motor: DV6ATED4 (11.04 - 07.11) 90cv 1560cc Hatchback - CITROËN - C4 I (LC_) - 1.6 HDi (11.04 - 07.11) 109cv 1560cc Hatchback - CITROËN - C4 Coupé (LA_) - 1.6 HDi Código do motor: DV6ATED4 (11.04 - 07.11) 90cv 15</p> <p>d150/162mm d29,5mm</p>		<p>W5125 NO. 120459 - 120447</p> <p>POLIE DA BOMBA DE ÁGUA</p> <p>CITROËN - C4 I (LC_) - 1.6 VTi (07.08 - 07.11) 120cv 1598cc Hatchback - CITROËN - C4 I (LC_) - 1.6 THP (07.08 - 07.11) 140cv 1598cc Hatchback - CITROËN - C4 I (LC_) - 1.6 THP (07.08 - 07.11) 150cv 1598cc Hatchback</p> <p>d123mm d20mm</p>
	<p>W5125 NO. 120459 - 120447</p> <p>POLIE DA BOMBA DE ÁGUA</p> <p>CITROËN - C4 II (B7) - 1.6 Vti (APÓS 11.09) 120cv 1598cc Hatchback - CITROËN - C4 II (B7) - 1.6 THP Equipamento do veículo: para veículos com caixa de velocidades manual - ID t ransm.: MC (APÓS 11.09) 156cv 1598cc Hatchback</p> <p>d123mm d20mm</p>		<p>W5125 NO. 120459 - 120447</p> <p>POLIE DA BOMBA DE ÁGUA</p> <p>CITROËN - C4 Picasso I (UD_) - 1.6 VTi (07.08 - 08.13) 120cv 1598cc Veículo multiuso - CITROËN - C4 Picasso I (UD_) - 1.6 THP (07.08 - 08.13) 140cv 1598cc Veículo multiuso - CITROËN - C4 Picasso I (UD_) - 1.6 16V (07.08 - 08.13) 150cv 1598cc Veículo multi</p> <p>d123mm d20mm</p>
	<p>W5146 NO. 0515R1</p> <p>POLIE DA CAMBOTA 6 PISTAS</p> <p>CITROËN C4 I (LC_) 2.0 16V Código do motor: EW10J4 (11.04 A 07.07) 136cv 1997cc Hatchback - CITROËN C4 I (LC_) 2.0 16V Código do motor: EW10A (11.04 A 07.11) 140cv 1997cc Hatchback - CITROËN C4 Coupé (LA_) 2.0 16V Código do motor: EW10A - Código do motor: EW10J4 (11.04 A 07.07) 136cv 1997cc Coupé - CITROËN C4 Picasso I (UD_) 1.8 i 16V Código do motor: EW7A (02.07 A 12.11) 125cv 1749cc Veículo multiuso - CITROËN C4 Picasso I (UD_)...etc.</p> <p>d148,5mm d30mm</p>		<p>Z10415 NO. 6547.20</p> <p>Mola de painel</p> <p>CITROËN C4 (Após 2011)</p> <p>d9x15mm 1p-d6-13mm</p>
	<p>Z80518 NO. 14115980 - 155809966 - 6992G2</p> <p>Mola de retenção</p> <p>CITROËN C4</p> <p>d13x9mm 1p-7x7-8mm 1f-d4.8mm</p>		<p>Z80693 NO. 6966.39 - 699100000000</p> <p>Mola de painel</p> <p>CITROËN C4</p> <p>d16.4x20mm 1p-d8-12.3mm</p>
	<p>Z80838 NO. 6991.Y8 - 7703077468 - 7703077469 - 8201112162</p> <p>Mola</p> <p>CITROËN C4</p> <p>d17x18.5mm 1p-d7.5-10.5mm</p>		<p>Z80842 NO. 8565.46 - 8565.47</p> <p>Mola de painel</p> <p>CITROËN C4</p> <p>17.7x10x20mm 1p-d10-9mm</p>

	<p>A1946 NO. 180941</p> <p>APOIO MOTOR TRÁ-S</p> <p>CITROËN C5 III (RD_) 2.2 HDi (A Partir de 02.08) 170cv 2179cc três volumes - CITROËN C5 III Break (TD_) 2.2 HDi (A Partir de 02.08) 170cv 2179cc Combi - CITROËN C5 III Break (TD_) 2.2 HDi 200 (A Partir de 07.10) 204cv 2179cc Combi</p> <p>d80x56mm c45mm 1f-d10mm</p>		<p>E0130 NO. 5087.43 - 5087.48 - 96324274</p> <p>ESTICADOR DA BARRA ESTABILIZADORA DA FRENTE</p> <p>CITROËN C5 TT</p> <p>355x34x34mm 2p-d12-30mm</p>
	<p>E0207-M NO. 1806.28</p> <p>ESTICADOR DO MOTOR (SUPERIOR)</p> <p>CITROËN C5 HDI</p> <p>165x62x44mm NULL</p>		<p>F1633-I NO. 328781 - 329781</p> <p>FOLE DA TRANSMISSÃO JUNTO À CAIXA</p> <p>CITROËN C5 (APÓS 01) 1.8i 16V - 2.0 HDi - 2.0 HPI 16V - 2.0i 16V</p> <p>d87x104mm 1f-d80mm 1f-d34mm</p>
	<p>KF1480-T NO. 329331</p> <p>KIT DE FOLE DO CARDAN JUNTO À RODA</p> <p>CITROËN C5 (APÓS 2005) 1.8i 16V - 2.0 Hdi - 2.0 HPI 16V - 2.0i 16V</p> <p>d107x117mm 1f-d89mm 1f-d35mm</p>		<p>RT80005 NO. 480697</p> <p>TUBO DE TRAVÃO FRENTE LH-RH</p> <p>CITROËN C5 TT (APÓS 03-2001)</p> <p>580mm FZ - MC11</p>
	<p>RT80006 NO. 480698</p> <p>TUBO DE TRAVÃO TRÁS LH-RH</p> <p>CITROËN C5 TT (APÓS 03-2001)</p> <p>260mm FZ - FZ</p>		<p>S1529 NO. 3523.AQ</p> <p>SILENT BLOC DO BRAÇO DA SUSPENSÃO DA FRENTE</p> <p>CITROËN - C5 III (RD_) - 1.6 VTi 120 (APÓS 7.1.0) - 120cv 1598cc três volumes - CITROËN - C5 III (RD_) - 1.6 THP 150 (APÓS 7.1.0) - 150cv 1598cc três volumes - CITROËN - C5 III (RD_) - 1.6 THP 1</p> <p>d56x50mm c33mm 1f-d14mm</p>
	<p>T0678-I NO. 516666</p> <p>BATENTE SUSPENSÃO DE TRÁS</p> <p>CITROËN C5 I (DC_) 1.8 16V (03.01 A 08.04) 115cv 1749cc Hatchback - CITROËN C5 I (DC_) 2.0 16V (03.01 A 08.04) 136cv 1997cc Hatchback - CITROËN C5 I (DC_) 2.0 16V HPI (03.01 A 08.04) 140cv 1997cc Hatchback - CITROËN C5 I (DC_) 3.0 V6 (03.01 A 08.04) 207cv 2946cc Hatchback - CITROËN C5 I (DC_) 2.0 HDi (03.01 A 08.04) 90cv 1997cc Hatchback - CITROËN C5 I (DC_) 2.0 HDi (03.01 A 08.04) 107cv 1997cc Hatchback - CITROËN C5 I (DC_) 2.0 HDi ...etc.</p> <p>d58x65mm 1f-d16mm 1pino-d14x12mm</p>		<p>W5003 NO. 0515P2 - 0515L8 - 0515L9 - 0515T8 - 0515V5 - 0515V6 - 0515Q3 - 0516A4 - 0516A6 - 051660</p> <p>POLIE DA CAMBOTA (6 pistas)</p> <p>CITROËN C5 2.0 HDi mot. DW10 - 2.2 HDi mot. DW12</p> <p>d152.8mm d30mm</p>
	<p>W5012 NO. 0515S2</p> <p>POLIE DA CAMBOTA (6 pistas)</p> <p>CITROËN C5 3.0 V6 BVA (APÓS 09-2004) - 3.0 V6 EXCLUSIVE (APÓS 08-2004)</p> <p>d143.8mm d42mm</p>		<p>W5085 NO. 0514Q8 - 96433641</p> <p>POLIE DA CAMBOTA (6 PISTAS)</p> <p>CITROËN C5 2.0 HDi 16V FAP (136CV) (APÓS 07-2004)</p> <p>d153/158mm d16mm</p>
	<p>W5091 NO. 0515T3 - 0516A3 - 1690296 - 1487861 - AV6Q6B319AA - Y66211401 - Y40111406A - 11237801979 - 1123780...</p> <p>POLIE DA CAMBOTA (6 PISTAS)</p> <p>CITROËN C5 (APÓS 09-2004) 1.6 Hdi</p> <p>d157mm d30mm</p>		<p>W5101 NO. 0515V6-0515T8</p> <p>POLIE DA CAMBOTA</p> <p>CITROËN C5 2.0 HDi - 2.2HDI</p> <p>d152.8mm d30mm</p>
	<p>W5115 NO. 9683886680 - 0515V3 - 515V3 - 1492251 - LR004247 - LR006672</p> <p>POLIE DA CAMBOTA (6 PISTAS)</p> <p>CITROËN C5 II (RC) 2.2 HDi (APÓS 04-2006) 170CV 2179CC - CITROËN C5 II BREAK (RE) 2.2 HDi (APÓS 05-2006) 163CV 2179CC - CITROËN C5 III (RD) 2.2 HDi (APÓS 04-2006) 170CV 2179CC - CITROËN C5 III (RD) 2.2 HDi (APÓS 02-2008) 170CV 2179CC - CITROËN C5 III BRE</p> <p>d153mm d30mm</p>		<p>W5120 NO. 0515P8 - 0515T0 - 0515V0 - 0515V7 - 0515V4 - 0515V8 - 0515R0 - 0515TQ - 0516A3</p> <p>POLIE DA CAMBOTA (6 PISTAS)</p> <p>CITROËN - C5 II (RC_) - 1.6 HDi (RC8HZB) (APÓS 09.04) 109cv 1560cc Hatchback - CITROËN - C5 II Break (RE_) - 1.6 HDi (RE8HZB) (APÓS 09.04) 109cv 1560cc Combi</p> <p>d150/162mm d29,5mm</p>

	<p>W5125 NO. 120459 - 120447</p> <p><i>POLIE DA BOMBA DE ÁGUA</i></p> <p>CITROËN - C5 III (RD_) - 1.6 VTi (APÓS 07.10) 120cv 1598cc três volumes 2/2 - CITROËN - C5 III (RD_) - 1.6 THP 155 Tipo de caixa de velocidades: Caixa de velocidades automática - ID t ransm.: AT6 - Equipamento do veículo: para veiculos com caixa de velocida</p> <p>d123mm d20mm</p>		<p>W5146 NO. 0515R1</p> <p><i>POLIE DA CAMBOTA 6 PISTAS</i></p> <p>CITROËN C5 I (DC_) 1.8 16V (DC6FZB - DC6FZE) N.º mot . a partir de: 0971075 - Código do motor: EW7J4 - Variante de equipamento: Mtr 0971075> - N.º mot . a partir de: 0822888 - Variante de equipamento: Mtr 0822888> (03.01 A 08.04) 115cv 1749cc Hatchback - CITROËN C5 I (DC_) 2.0 16V (DCRFNC - DCRFNF) N.º mot . a partir de: 0961750 - Código do motor: EW10J4 - Variante de equipamento: Mtr 0961750> (03.01 A 08.04) 136cv 1997cc Hatchback - CIT...etc.</p> <p>d148,5mm d30mm</p>
	<p>W5146 NO. 0515R1</p> <p><i>POLIE DA CAMBOTA 6 PISTAS</i></p> <p>CITROËN C5 II (RC_) 1.8 16V (RC6FZB) Código do motor: EW7J4 (APÓS 09.04) 116cv 1749cc Hatchback - CITROËN C5 II (RC_) 1.8 16V Código do motor: EW7A (APÓS 09.05) 125cv 1749cc Hatchback - CITROËN C5 II (RC_) 2.0 16V (RCRFJB - RCRFJC) Código do motor: EW10A (APÓS 09.04) 140cv 1997cc Hatchback - CITROËN C5 II Break (RE_) 1.8 16V (RE6FZB) Código do motor: EW7J4 (APÓS 09.04) 116cv 1749cc Combi - CITROËN C5 II Break (RE_) 1.8 16V Cód...etc.</p> <p>d148,5mm d30mm</p>		<p>W5146 NO. 0515R1</p> <p><i>POLIE DA CAMBOTA 6 PISTAS</i></p> <p>CITROËN C5 III (RD_) 1.8 16V Código do motor: EW7A (APÓS 02.08) 125cv 1749cc três volumes - CITROËN C5 III (RD_) 2.0 16V Código do motor: EW10A (APÓS 02.08) 140cv 1997cc três volumes - CITROËN C5 III Break (TD_) 1.8 16V Código do motor: EW7A (APÓS 02.08) 125cv 1749cc Combi 2/2 - CITROËN C5 III Break (TD_) 2.0 16V Código do motor: EW10A (APÓS 02.08) 140cv 1997cc Combi</p> <p>d148,5mm d30mm</p>
	<p>Z10415 NO. 6547.20</p> <p><i>Mola de painel</i></p> <p>CITROËN C5 (De 2001 A 2008)</p> <p>d9x15mm 1p-d6-13mm</p>		<p>Z80754 NO. 6991S6</p> <p><i>Mola de painel</i></p> <p>CITROËN C5</p> <p>d18x18mm 1p-10.5x7.8-10mm</p>
	<p>Z80790 NO. 6991X7</p> <p><i>Mola de fixação</i></p> <p>CITROËN C5</p> <p>d20x34mm 1p-d8-14mm</p>		

CITROËN C6

	<p>S1529 NO. 3523.AQ</p> <p><i>SILENT BLOC DO BRAÇO DA SUSPENSÃO DA FRENTE</i></p> <p>CITROËN - C6 (TD_) - 3.0 V6 Código do motor: ES9A (APÓS 09.05) 211cv 2946cc três volumes - CITROËN - C6 (TD_) - 2.2 HDi (APÓS 06.06) 163cv 2179cc três volumes - CITROËN - C6 (TD_) - 2.2 HDi (APÓS 06.06) 170cv 2179cc três volumes - CITROËN - C6 (TD_) - 2.</p> <p>d56x50mm c33mm 1f-d14mm</p>		<p>W5115 NO. 9683886680 - 0515V3 - 515V3 - 1492251 - LR004247 - LR006672</p> <p><i>POLIE DA CAMBOTA (6 PISTAS)</i></p> <p>CITROËN C6 (TD) 2.2 HDI (APÓS 06-2006) 170CV 2179CC - CITROËN C8 (EA EB) 2.2 HDI (APÓS 06-2006) 170CV 2179CC</p> <p>d153mm d30mm</p>
--	---	--	--

CITROËN C8

	<p>A1922 NO. 1714E3 - 9642742880 - 1755E4 - 17565YV010</p> <p><i>APOIO DO ESCAPE</i></p> <p>CITROËN C8 (EA_ - EB_) 3.0 V6 Local de montagem: à frente (APÓS 07.02) 204cv 2946cc Veículo multiuso</p> <p>53x39x45mm 2p-d6-18mm</p>		<p>KF1406-T NO. 329306</p> <p><i>KIT DE FOLE DO CARDAN JUNTO À RODA</i></p> <p>CITROËN C8 2.0 HDi - 2.2 HDi - 2.2i - 3.0i V6 (APÓS 2002) - EVASION 1.9 TD - 2.0 HDi - 2.0i T C.T. - 2.1 TD (1994 A 2002) - JUMPY 1.9 TD (APÓS 1994)</p> <p>d110x120mm 1f-d99mm 1f-d30mm</p>
--	---	--	---

	<p>RT08573 NO. 1472157080 - 480667</p> <p>TUBO DE TRAVÃO TRÁS LH-RH</p> <p>CITROËN C8 TT (APÓS 08-2002)</p>		<p>RT80007 NO. 1484536080 - 4806.A6</p> <p>TUBO DE TRAVÃO FRENTE LH-RH</p> <p>CITROËN C8 TT (APÓS 08-2002)</p>
	<p>W5003 NO. 0515P2 - 0515L8 - 0515L9 - 0515T8 - 0515V5 - 0515V6 - 0515Q3 - 0516A4 - 0516A6 - 051660</p> <p>POLIE DA CAMBOTA (6 pistas)</p> <p>CITROËN C8 2.0 HDi (APÓS 02-2002) MOTOR DW10ATED4 - 2.2 HDi (APÓS 07-2002) MOTOR DW12ATED4</p>		<p>W5012 NO. 0515S2</p> <p>POLIE DA CAMBOTA (6 pistas)</p> <p>CITROËN C8</p>
	<p>W5085 NO. 0514Q8 - 96433641</p> <p>POLIE DA CAMBOTA (6 PISTAS)</p> <p>CITROËN C8 2.0 HDi (APÓS 03-2006) Mtr DW10BTED4 100KW</p>		<p>W5101 NO. 0515V6-0515T8</p> <p>POLIE DA CAMBOTA</p> <p>CITROËN C8 2.0 HDi - 2.2 HDi</p>
	<p>W5146 NO. 0515R1</p> <p>POLIE DA CAMBOTA 6 PISTAS</p> <p>CITROËN C8 (EA_ - EB_) 2.0 N.º mot . a partir de: 0822888 - Código do motor: EW10J4 - Variante de equipamento: Mtr 0822888> - N.º mot . a partir de: 0961750 - Variante de equipamento: Mtr 0961750> (APÓS 07.02) 136cv 1997cc Veiculo multiuso - CITROËN C8 (EA_ - EB_) 2.2 N.º mot . a partir de: 0822888 - Código do motor: EW12J4 - Variante de equipamento: Mtr 0822888> (APÓS 07.02) 158cv 2230cc Veiculo multiuso</p>		<p>Z80693 NO. 6966.39 - 699100000000</p> <p>Mola de painel</p> <p>CITROËN C8</p>
	<p>Z80790 NO. 6991X7</p> <p>Mola de fixação</p> <p>CITROËN C8</p>		<p>Z80838 NO. 6991.Y8 - 7703077468 - 7703077469 - 8201112162</p> <p>Mola</p> <p>CITROËN C8</p>
	<p>Z80842 NO. 8565.46 - 8565.47</p> <p>Mola de painel</p> <p>CITROËN C8</p>		







CITROËN CX-GS-GSA



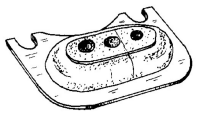
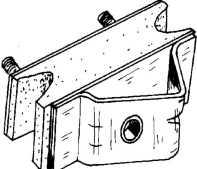

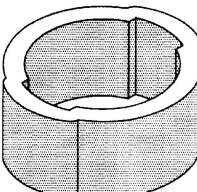
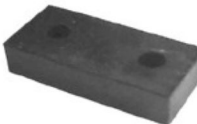

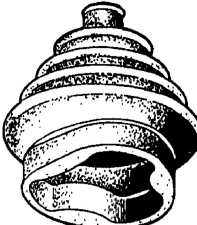

	<p>A1267 NO. CX0710001 - 95525977</p> <p>APOIO FRENTE DO MOTOR</p> <p>CITROËN GS - CX</p>		<p>BE15 NO. 0414601A - 75529846 - 75420467 - 5420467</p> <p>ABRAÇADEIRA DE ESCAPE CÔNCAVA 53mm</p> <p>CITROËN GSA - (1979 A 1986)</p>
	<p>100x95x49mm 2f-d11mm1r-d10mm</p>		<p>93x52x18mm 53mm</p>

	<p>BE16 NO. 5433461 - 5483762 - 95483762</p> <p>ABRAÇADEIRA DE ESCAPE CÔNCAVA 66mm</p> <p>CITROËN CX (1974 A 1991)</p> <p>116x64x16mm 66mm</p>		<p>BE17 NO. 75420467</p> <p>ABRAÇADEIRA DE ESCAPE CÔNCAVA 49mm</p> <p>CITROËN GSA (1979 A 1986)</p> <p>86x48x15mm 49mm</p>
	<p>BE20 NO. 5453900 - 54837624</p> <p>ABRAÇADEIRA DE ESCAPE CÔNCAVA 69mm</p> <p>CITROËN CX (1974 A 1989)</p> <p>110x64x18mm NULL</p>		<p>E004 NO. 75420014 - 91503080 - 54200.14</p> <p>ESTICADOR DE ESCAPE</p> <p>CITROËN GS - CX</p> <p>65x45x24mm NULL</p>
	<p>E003 NO. G-5420014W - 91503080 - 95576338</p> <p>ESTICADOR DE ESCAPE</p> <p>CITROËN GS TT</p> <p>64x45x40mm NULL</p>		<p>F0839-I NO. CX1010601A</p> <p>FOLE DO SEMI-EIXO JUNTO À CAIXA DE VELOCIDADES</p> <p>CITROËN GS 1015 - GS 1220 - GSA</p> <p>d116x86mm 1f-d18mm</p>
	<p>F0870-I NO. 95532953 - 95613146 - 95569341</p> <p>FOLE DO SEMI-EIXO LADO DO DIFERENCIAL</p> <p>CITROËN CX 2.5LiE TURBO</p> <p>d104x98mm 1f-d96mm 1f-d24mm</p>		<p>F1053 NO. AM37399A - AM37399O - 95532941 - 5420024</p> <p>FOLE DO SEMI-EIXO DO LADO DA RODA</p> <p>CITROËN GS 1015-1220 - GSA</p> <p>d110x73mm 1f-d80mm 1f-d20mm</p>
	<p>N3727 NO.</p> <p>ANEL DE ESCAPE</p> <p>CITROËN CX TT</p> <p>d55x12mm 1f-d31mm</p>		<p>N8066 NO. 5460614 - 5481691 - ZF04437668 - 1755.92 - 1755.38 - 1755.60</p> <p>ANEL DE ESCAPE</p> <p>CITROËN CX (APÓS 1980)</p> <p>d70x17mm 1f-d38mm</p>
	<p>S0014 NO. 7542974</p> <p>SILENT-BLOC DO BRAÇO INFERIOR DA SUSPENSÃO</p> <p>CITROËN GS - GSA</p> <p>d48x82mm d43mm d36mm1f-d14mm</p>		<p>Z80632 NO. 698317</p> <p>Mola de painel</p> <p>CITROËN GSA</p> <p>d21x26mm 1p-d7.5-24mm</p>
	<p>Z9001 NO. 7910029764 - 91510245 - 75530745 - 9150246180</p> <p>MOLA DE ESCAPE 26mm</p> <p>CITROËN CX (1979 A 1989)</p> <p>d21x26mm NULL</p>		

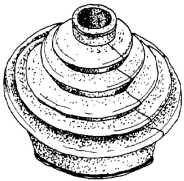
	W5125	NO. 120459 - 120447		W5125	NO. 120459 - 120447
	POLIE DA BOMBA DE ÁGUA CITROËN - DS3 - 1.6 Vti (APÓS 04.10) 120cv 1598cc Hatchback - CITROËN - DS3 - 1.6 THP (APÓS 01.10) 150cv 1598cc Hatchback - CITROËN - DS3 - 1.6 Racing (APÓS 02.11) 207cv 1598cc Hatchback			POLIE DA BOMBA DE ÁGUA CITROËN - DS4 - 1.6 VTi (APÓS 04.11) 120cv 1598cc Hatchback - CITROËN - DS4 - 1.6 THP 155 Equipamento do veículo: para veículos com caixa de velocidades manual - ID t ransm.: MC (APÓS 04.11) 156cv 1598cc Hatchback - CITROËN - DS4 - 1.6 THP 200 Equipamento do	
d123mm		d20mm	d123mm		d20mm
	W5125	NO. 120459 - 120447			
	POLIE DA BOMBA DE ÁGUA CITROËN - DS5 - 1.6 THP 155 Tipo de caixa de velocidades: Caixa de velocidades automática - ID t ransm.: AT6 (APÓS 11.11) 156cv 1598cc Hatchback - CITROËN - DS5 - 1.6 THP (APÓS 11.11) 200cv 1598cc Hatchback				
d123mm		d20mm			

CITROËN DYANE-AMI-2CV-ACADYANE-MEHARI

	A0367	NO. A-133.1A - AM-133.1 - AM1331A		A0409	NO. AM-133.2 - 5421915 - 75421915 - 95587825
	SUPORTE DA CAIXA DE VELOCIDADES TRÁS CITROËN 2CV - AMI 6 - AMI 8 - DYANE			SUPORTE FRENTE DO MOTOR CITROËN 2CV - AMI 6 - AMI 8	
110x90x15.5mm		2f-d7mm 1f-d14	95x57x35mm		2p-d7 1f-d8mm
	BE17	NO. 75420467		BE26	NO. AM1826B
	ABRAÇADEIRA DE ESCAPE CÔNCAVA 49mm CITROËN ACADYANE (1978 A 1988) - 2CV6 (1970 A 1990)			ABRAÇADEIRA DE ESCAPE CÔNCAVA 47MM CITROËN ACADYANE (78 A 88) - MEHARI (75 A 87) - 2CV6 (70 A 90)	
86x48x15mm		49mm	d47mm		NULL
	E0009	NO. AM-183-482237030 - AM.183.48 - 2237030		E0032	NO. 5410471 - DS18280 - DX18280A
	ESTICADOR DE ESCAPE CITROËN ACADYANE (78-88) - AMI 8 (68-78) - DYANE (68-84) - MEHARI (75-87) - 2CV (70-90)			ESTICADOR DE ESCAPE CITROËN 2CV 6 (70-90) - AMI 8 (69-78) - DYANE (68-84) - 2CV (70-78)	
d85x25mm		1f-d62mm	68x30x13mm		NULL
	E0032	NO. 5410471 - DS18280 - DX18280A		E0033	NO. AMI18275
	ESTICADOR DE ESCAPE CITROËN 2CV 6 (70-90) - CITROËN 250 (72-78) - CITROËN AMI 8 (69-78) - CITROËN DYANE (68-84) - CITROËN DS (66-74) - CITROËN D SUPER5 - DS 23 (73-75) - CITROËN H - HY - HZ (69-75) - CITROËN 2CV (70-78)			ESTICADOR DE ESCAPE CITROËN AMI8 (69-78) - CITROËN DYANE (68-84) - CITROËN 2CV (70-78) - CITROËN 2CV 6 (70-90)	
68x30x13mm		NULL	133x30x14mm		NULL
	F0068	NO.		F0839-I	NO. CX1010601A
	FOLE DA TRANSMISSÃO CITROËN 2CV			FOLE DO SEMI-EIXO JUNTO À CAIXA DE VELOCIDADES CITROËN AMI 8 SUPER	
d100x75mm		1f-d85mm 1f-d24mm	d116x86mm		1f-d18mm

	<p>F0840-I NO. 95532942 - AZ37303 - AZ37388A</p> <p>FOLE DO LADO DA CAIXA</p> <p>CITROËN DYANE - AMI6 - AMI8 - MEHARI</p>		<p>F1047 NO. A37288A - AM37288A</p> <p>FOLE DA TRANSMISSÃO CENTRAL</p> <p>CITROËN DYANE - 2CV</p>
	<p>F1053 NO. AM37399A - AM37399O - 95532941 - 5420024</p> <p>FOLE DO SEMI-EIXO DO LADO DA RODA</p> <p>CITROËN DYANE 2CV - MEHARI - AMI 6 - AMI 8</p>		<p>KF0840 NO. 95532942 - 95532947 - AZ17388A - AZ37303</p> <p>KIT FOLE CARDAN JUNTO CAIXA</p> <p>CITROËN 2CV 4 (03.63 A 02.70) 16cv 425cc Formato especial - CITROËN 2CV 4 (01.70 A 12.75) 23cv 435cc Formato especial</p>
	<p>KF0840 NO. 95532942 - 95532947 - AZ17388A - AZ37303</p> <p>KIT FOLE CARDAN JUNTO CAIXA</p> <p>CITROËN AMI 6 (AM, AMB) (01.63 A 05.68) 24cv 602cc três volumes - CITROËN AMI 6 (AM, AMB) (05.68 A 07.69) 33cv 602cc três volumes - CITROËN AMI 8 (AM3) (07.69 A 12.77) 33cv 602cc três volumes - CITROËN AMI Break 6 (AMB) (05.68 A 07.69) 33cv 602cc Combi - CITROËN AMI Break 8 (AM3) (07.69 A 12.77) 33cv 602cc Combi</p>		<p>KF0840 NO. 95532942 - 95532947 - AZ17388A - AZ37303</p> <p>KIT FOLE CARDAN JUNTO CAIXA</p> <p>CITROËN DYANE 4 (08.67 A 03.68) 18cv 425cc Formato especial</p>
	<p>KF1420 NO. 5480032 - 95532941 - 95532948 - 95543833 - 95576829 - 95600345 - AM37399A</p> <p>KIT DE FOLE DO CARDAN JUNTO À RODA</p> <p>CITROËN 2CV (63 A 90) 0.4 - 0.6 - ACADYANE (78 A 88) 0.6 - AMI (63 A 77) 0.6 8 - 1.0 10 SUPER - DYANE (67 A 84) 0.4 - 0.6 - MEHARI (68 A 87) 0.6 - 0.6 4X4</p>		<p>P1007 NO. 95575913</p> <p>CAPA DE PEDAL DO TRAVÃO E EMBRAIAGEM</p> <p>CITROËN 2CV</p>
	<p>Z80280 NO.</p> <p>Mola de friso</p> <p>Citroën Dyane</p>		
	<p>12x6.5x13mm</p> <p>1p-d5-4.6mm</p>		

CITROËN EVASION

	<p>A1588 NO. 1827.16</p> <p>APOIO DO MOTOR PARTE DE TRÁS</p> <p>CITROËN EVASION 1.9 TD - 2.0 IE 16V - 2.0 IE TURBO - 2.0 TD - 2.1 TD</p>		<p>BE22 NO. 171344</p> <p>ABRÇADEIRA ESCAPE</p> <p>CITROËN EVASION (APÓS 1994)</p>
	<p>E0144 NO. 5087.35 - 1308664080 - 1317425080</p> <p>ESTICADOR DA BARRA ESTABILIZADORA DA FRENTE</p> <p>CITROËN EVASION TT - JUMPY TT</p>		<p>E0207-M NO. 1806.28</p> <p>ESTICADOR DO MOTOR (SUPERIOR)</p> <p>CITROËN EVASION</p>
	<p>140x98x92mm</p> <p>NULL</p>		<p>96x100x18mm</p> <p>1p-d10-75mm</p>
	<p>120x40x40mm</p> <p>1p-d12-25mm 1f-d12mm</p>		<p>165x62x44mm</p> <p>NULL</p>

	<p>E1056 NO.</p> <p>ESTICADOR DE ESCAPE</p> <p>CITROËN EVASION (APÓS 1994)</p> <p>65x63x38mm 1f-d14mm 1f-d9mm</p>		<p>F0897-I NO. 9566934088 - 3293.01 - 60808619 - 9566934080</p> <p>FOLE JUNTO À RODA</p> <p>CITROËN EVASION 1998 cc. (APÓS 9-1994) (V6 SÉRIES VB)</p> <p>d100x98mm 1f-d86mm 1f-d26mm</p>
	<p>F1301-I NO. 9609802380 - 329724</p> <p>FOLE DO LADO DA CAIXA</p> <p>CITROËN EVASION 1998 cc. (APÓS 09-94)</p> <p>d90x100mm 1f-d78mm 1f-d25mm</p>		<p>F1356-I NO. 9617054480 - 3287.77 - 9564479480</p> <p>FOLE DO LADO DA CAIXA</p> <p>CITROËN EVASION 1998 cc. (APÓS 9-94) - EVASION 1905 cc. TURBO DIESEL (APÓS 9-94)</p> <p>d85x90mm 1f-d76mm 1f-d28mm</p>
	<p>F1356-I NO. 9617054480 - 3287.77 - 9564479480</p> <p>FOLE DO LADO DA CAIXA</p> <p>CITROËN EVASION 1998 cc. (APÓS 9-94) - EVASION 1905 cc. TURBO DIESEL (APÓS 9-94)</p> <p>d85x90mm 1f-d76mm 1f-d28mm</p>		<p>F4037 NO. 406641</p> <p>FOLE DA DIRECÇÃO LADO DIREITO E ESQUERDO</p> <p>CITROËN EVASION 1.8 i - 1.9 TD - 2.0 i - 2.0 iT - 2.0 HDi - 2.1 TD 94-02</p> <p>d72/54x240mm 1f-d68mm 1f-d10mm</p>
	<p>KF1060 NO. 329301 - 9566934080 - 9566934088</p> <p>KIT DE FOLE DO CARDAN JUNTO À RODA</p> <p>CITROËN EVASION 1.8 - 1.8i - 1.9 TD - 2.0 - 2.0i (1994 A 1998) - JUMPY 1.6 - 1.8 - 1.9D (APÓS 1996)</p> <p>d100x100mm 1f-d78mm 1f-d24mm</p>		<p>KF1405 NO. 329301 - 9566934080</p> <p>KIT DE FOLE DO CARDAN JUNTO À RODA</p> <p>CITROËN EVASION (94 A 2002) 1.8i - 1.9 TD - 2.0i</p> <p>d101x97mm 1f-d80mm 1f-d25mm</p>
	<p>KF2435 NO. 329300 - 9566933988</p> <p>KIT DE FOLE DO CARDAN JUNTO À RODA</p> <p>CITROËN EVASION (1994 A 2002) 1.9TD - 2.0HDi - 2.0iT C.T - 2.1TD</p> <p>d110x80mm 1f-d97mm 1f-d28mm</p>		<p>L3037 NO. 91509516</p> <p>CASQUILHO DOS PARAFUSOS DE ESCAPE</p> <p>CITROËN EVASION (APÓS 1994)</p> <p>d23x10mm c8mm 1f-d11/16mm</p>
	<p>M6012 NO. 91516522 - 915377797 - 96033780 - 96038954 - 91539094</p> <p>JUNTA DE ESCAPE</p> <p>CITROËN EVASION (APÓS 1994)</p> <p>d79x14mm 1f-d66mm</p>		<p>M6086 NO. 91537799 - 96587799</p> <p>JUNTA DE ESCAPE</p> <p>CITROËN EVASION (APÓS 1994)</p> <p>d70x13mm 1f-d58mm</p>
	<p>RT08569 NO. 147919080 - 480682</p> <p>TUBO DE TRAVÃO FRENTE LH-RH</p> <p>CITROËN EVASION TT (06-1994 A 07-2002)</p> <p>515mm FZ - MG1</p>		<p>RT08570 NO. 480668 - 480681</p> <p>TUBO DE TRAVÃO TRÁS LH-RH</p> <p>CITROËN EVASION TT (06-1994 A 07-2002)</p> <p>325mm FZ - MC11</p>
	<p>RT08573 NO. 1472157080 - 480667</p> <p>TUBO DE TRAVÃO TRÁS LH-RH</p> <p>CITROËN EVASION TT (06-1994 A 07-2002)</p> <p>275mm FZ - FZ</p>		<p>S1468 NO. 1313083080 - 1305551080</p> <p>SILENT BLOC ESQUERDO DO BRAÇO DA SUSPENSÃO DA FRENTE</p> <p>CITROËN EVASION 1.8 - 1.9TD - 2.0 - 2.0 16V - 2.0TD - 2.0 TURBO CT - 2.1TD (1994 A 2002)</p> <p>130x132x85mm d60mm c62mm 1f-d22.8mm</p>

	<p>S1469 NO. 1313084080 - 1305552080</p> <p>SILENT BLOC DIREITO DO BRAÇO DA SUSPENSÃO DA FRENTE CITROËN EVASION 1.8 - 1.9TD - 2.0 - 2.0 16V - 2.0TD - 2.0 TURBO CT - 2.1TD (1994 A 2002)</p> <p>130x132x85mm d60mm c62mm 1f-d22.8mm</p>		<p>S1470 NO. 1312317080</p> <p>SILENT BLOC CENTRAL DO BRAÇO DA SUSPENSÃO DA FRENTE CITROËN EVASION 1.8 - 1.9TD - 2.0 - 2.0 16V - 2.0TD - 2.0 TURBO CT - 2.1TD (1994 A 2002)</p> <p>126x50x62mm 1f-d22.8mm 2f-d12mm</p>
	<p>S1519 NO. 515261 - 1479759080 - 515261</p> <p>SILENT BLOC DO BRAÇO TRANSVERSAL EIXO TRASEIRO CITROËN EVASION (22 U6) 1.8 (05-1997 A 07-2002) 99CV 1761CC - CITROËN EVASION (22 U6) 2.0 (06-1994 A 07-2002) 121CV 1998CC - CITROËN EVASION (22 U6) 2.0 16V (05-1998 A 04-2000) 132CV 1998CC - CITROËN EVASION (22 U6) 2.0 16V (05-2000 A 07-2002) 136CV 1997C</p> <p>d46.5x60mm c48mm 1f-d12mm</p>		<p>T0665-I NO. 503339 - 1307021080</p> <p>BATENTE SUSPENSÃO DA FRENTE CITROËN EVASION (22 - U6) 1.8 (05.97 A 07.02) 99cv 1761cc Veículo multiuso - CITROËN EVASION (22 - U6) 2.0 (06.94 A 07.02) 121cv 1998cc Veículo multiuso - CITROËN EVASION (22 - U6) 2.0 16V (05.98 A 04.00) 132cv 1998cc Veículo multiuso - CITROËN EVASION (22 - U6) 2.0 16V (05.00 A 07.02) 136cv 1997cc Veículo multiuso - CITROËN EVASION (22 - U6) 2.0 Turbo C.T. (06.94 A 07.02) 147cv 1998cc Veículo multiuso - CITROËN EVASION (22 - U6) ...etc.</p> <p>d54x107mm 1f-d25mm 1f-d20mm</p>
	<p>T1123 NO. 509469</p> <p>BATENTE DA BARRA ESTABILIZADORA DA FRENTE CITROËN EVASION 1.8 LFZ (XU7JP) 99 CV (05-1997 A 07-2002) - 1.9 TD D8B (XUD9TF) - DHX (XUD9TF/BTF) 90CV (11-1994 A 07-2002) - 1.9 TD D8B (XUD9TF) 92CV (10-1995 A 12-1998) - 2.0 RFU (XU10J2/C) 121CV (06-1994 A 07-2002) - 2.0 16V RFN (EW10J4) 136CV (05-2000)</p> <p>64x53x45x50mm 1f-d24.5mm</p>		<p>W5003 NO. 0515P2 - 0515L8 - 0515L9 - 0515T8 - 0515V5 - 0515V6 - 0515Q3 - 0516A4 - 0516A6 - 051660</p> <p>POLIE DA CAMBOTA (6 pistas) CITROËN EVASION 2.0 HDi (mot. DW12)</p> <p>d152.8mm d30mm</p>
	<p>W5004 NO. 0515G3 - 051660 - 0516A4 - 0516A6</p> <p>POLIE DA CAMBOTA (6 pistas) CITROËN EVASION (1.9 TD 90 CV - mot. XUD9)</p> <p>d152.8mm d30mm</p>		<p>W5011 NO. 0515J9</p> <p>POLIE DA CAMBOTA (6 pistas) CITROËN EVASION 2.1 TD 12V mot. XUD11</p> <p>d152.8mm d30mm</p>
	<p>W5024 NO. 0515H6</p> <p>POLIE DA CAMBOTA (6 pistas) CITROËN EVASION 1.8 MOTORES LFY - XU7JP4 - RFV - XU10J4R - NFZ - XU75P</p> <p>d127mm d30mm</p>		<p>W5101 NO. 0515V6-0515T8</p> <p>POLIE DA CAMBOTA CITROËN EVASION 2.0 HDi (1999 - 2002)</p> <p>d152.8mm d30mm</p>
	<p>Y3001 NO. 95608790 - 91521270 - 91521271 - 96118164</p> <p>PARAFUSO DE ESCAPE CITROËN EVASION (APÓS 1994)</p> <p>65x8mm 1p-d6-15mm</p>		<p>Z80680 NO. 9605146380 - 6999A3</p> <p>Mola de painel CITROËN EVASION</p> <p>d12x12mm 1p-d6-10mm</p>
	<p>Z80720 NO. 696640</p> <p>Mola de painel CITROËN EVASION</p> <p>d20x20mm 1p-d8-17.5mm</p>		<p>Z9008 NO. 96062723 - 96092921</p> <p>MOLA DE ESCAPE CITROËN EVASION (APÓS 1994)</p> <p>d21x34mm NULL</p>

	<p>A1499 NO. 1846.66</p> <p>APOIO MOTOR TRÁS ESQUERDO (CAIXA)</p> <p>CITROËN JUMPER 2.5D - 2.5TD - CITROËN MODELO JUMPER 2002TT</p> <p>160x65x65mm 1f-d15mm 2r-d15mm</p>		<p>A1500 NO. 1846.65</p> <p>APOIO MOTOR TRÁS DIREITO</p> <p>CITROËN JUMPER 2.5D - 2.5TD - CITROËN MODELO JUMPER 2002TT</p> <p>93x70x55mm 1f-d14mm</p>
	<p>A1648 NO. 182718</p> <p>APOIO DO MOTOR PARTE DE TRÁS</p> <p>CITROËN JUMPER 1905 D - 1905 TD - 1930 D - 1930 TD</p> <p>150x70x65mm 1p-d12-30mm</p>		<p>A1649 NO. 182717</p> <p>APOIO DO MOTOR PARTE DE TRÁS</p> <p>CITROËN JUMPER 2500 D - 2500 TD - 2800 TD</p> <p>150x75x70mm 1p-d12-32mm</p>
	<p>A1650 NO. 184446 - 182719</p> <p>APOIO DO MOTOR PARTE DA FRENTE</p> <p>CITROËN JUMPER 1905 D - 1905 TD - 1930 D - 1930 TD - 2500 D - 2500 TD - 2800 TD</p> <p>155x80x65mm 1p-d12-32mm</p>		<p>A1945 NO. 180691 - 1348993080</p> <p>APOIO CAIXA VELOCIDADES</p> <p>CITROËN JUMPER Autocarro 2.2 HDi 110 (A Partir de 07.11) 110cv 2198cc Autocarro - CITROËN JUMPER Autocarro 2.2 H Di 130 (A Partir de 07.11) 130cv 2198cc Autocarro - CITROËN JUMPER Autocarro 2.2 HDi 150 (A Partir de 07.11) 150cv 2198cc Autocarro - CITROËN JUMPER Caixa 2.2 HDi 110 (A Partir de 07.11) 110cv 2198cc Caixa - CITROËN JUMPER Caixa 2.2 HDi 120 (A Partir de 04.06) 120cv 2198cc Caixa - CITROËN JUMPER Caixa 2.2 HDi 130 (A Pa...etc.</p> <p>150x105x50mm 1f-d16mm 3f-d14mm 3r-d12mm</p>
	<p>A1956 NO. 1339629080 - 1345897080 - 935019160 - 9405031789</p> <p>APOIO AMORTECEDOR FRENTE LADO ESQUERDO</p> <p>CITROËN JUMPER Autocarro (230P) 1.9 D (01.99 A 04.02) 69cv 1905cc Autocarro - CITROËN JUMPER Autocarro (230P) 1.9 TD (08.94 A 04.02) 90cv 1905cc Autocarro - CITROËN JUMPER Autocarro (230P) 1.9 TD (02.94 A 04.02) 92cv 1905cc Autocarro - CITROËN JUMPER Autocarro (230P) 2.5 D (08.94 A 04.02) 86cv 2446cc Autocarro - CITROËN JUMPER Autocarro (230P) 2.5 TD (08.94 A 04.02) 103cv 2446cc Autocarro - CITROËN JUMPER Autocarro (230P) 2.8 HDi...etc.</p> <p>160x170x80mm 1f-d14mm 3r-d10mm</p>		<p>E0089 NO. 508149 - 509213 - 509316 - 693971 - 1300716080 - 5087.37</p> <p>ESTICADOR DA BARRA ESTABILIZADORA DA FRENTE</p> <p>CITROËN JUMPER TT (DIESEL) - JUMPER (MOD.2002) 2.0 - JUMPER (MOD. 2002) 2.8 HdI</p> <p>155x42x35mm 1f-d14mm</p>
	<p>E0089-C NO. 5087.37 - 1300716080 - 5093.15</p> <p>ESTICADOR DA BARRA ESTABILIZADORA DA FRENTE</p> <p>CITROËN JUMPER TT (DIESEL) - JUMPER (MOD. 2002) 2.0 - 2.8 HDi</p> <p>155x35x43mm 1f-d14mm 1p-d12-23mm</p>		<p>E1056 NO.</p> <p>ESTICADOR DE ESCAPE</p> <p>CITROËN JUMPER (1995 A 1996)</p> <p>65x63x38mm 1f-d14mm 1f-d9mm</p>
	<p>E1106 NO.</p> <p>ESTICADOR DO ESCAPE PARTE DE TRÁS</p> <p>CITROËN - JUMPER Caixa (230L) - 2.0 HDi 84CV 1997cc (11-2001 A 04-2002) - JUMPER Autocarro (244 - Z_) - 2.2 HDi 101CV 2179cc (APÓS 04-2002) - 2.8 HDi Autocarro 128CV 2798cc (APÓS 04-2002) - CITROËN JUMPER Caixa (244) - 2.0 HDi 84CV 1997cc (APÓS 04-2002)</p> <p>55x45x25mm 2f-d10mm</p>		<p>E1107 NO. 1755K8</p> <p>ESTICADOR DO ESCAPE PARTE DE TRÁS</p> <p>CITROËN - JUMPER Caixa (244) - 2.0 110CV 1998cc (APÓS 04-2002) - 2.0 bivalent 110cv 1998cc (APÓS 02-2003) - 2.0 HDi Caixa 84CV 1997cc (APÓS 04-2002) - 2.2 HDi Caixa 101CV 2179cc (APÓS 04-2002) - 2.8 HDi Caixa 128CV 2798cc (APÓS 04-2002) - 2.8 HDi 4X4 CA</p> <p>82x55x31mm 3f-d10mm</p>
	<p>F1352-I NO. 9564478780</p> <p>FOLE JUNTO À RODA</p> <p>CITROËN JUMPER 1800Kg (APÓS 9-1994)</p> <p>d120x95mm 1f-d112mm 1f-d32mm</p>		<p>F1355-I NO. 328778</p> <p>FOLE DA TRANSMISSÃO JUNTO À CAIXA</p> <p>CITROËN JUMPER 2.0i - 2.2HDi - 2.5D & 4X4 - 2.5TD - 2.5TD Id & 4x4 - 2.8 HDi (94 A 02)</p> <p>d97x95mm 1f-d33mm 1f-d87mm</p>
	<p>F1356-I NO. 9617054480 - 3287.77 - 9564479480</p> <p>FOLE DO LADO DA CAIXA</p> <p>CITROËN JUMPER 1400 kg (APÓS 9-1994)</p> <p>d85x90mm 1f-d76mm 1f-d28mm</p>		<p>F1361-I NO. 3293.98</p> <p>FOLE DO LADO DA RODA</p> <p>CITROËN JUMPER 1400 kg (APÓS 9-1994)</p> <p>d127x150mm 1f-d110mm 1f-d32mm</p>

	F1910-T NO. 40308383 - 46308480 - 1607740880 - LR003160 - 39242EB30B - C9241EB30A FOLE DO EIXO DE TRANSMISSÃO LADO DA RODA CITROËN JUMPER Autocarro 2.2 HDi 110 (A Partir de 07.11) 110cv 2198cc Autocarro - CITROËN JUMPER Caixa 2.2 HDi 110 (A Partir de 07.11) 110cv 2198cc Caixa - CITROËN JUMPER Camião de plataforma/chassis 2.2 HDi 110 (A Partir de 07.11) 110cv 2198cc Camião de plataforma/chassis d120x150mm 1f-d28mm 1f-d100mm		KF1407-T NO. 3293A2 - 329307 KIT DE FOLE DO CARDAN JUNTO À RODA CITROËN JUMPER 2.0i - 2.2 HDi - 2.5D & 4X4 - 2.5 TD - 2.5 TD iD & 4x4 - 2.8 HDi (1994 A 2002) d130x170mm 1f-d112mm 1f-d33mm
	KF1456 NO. 329399 - 9564478780 KIT DE FOLE CITROËN JUMPER (1994 A 2002) 2.0i - 2.5TD - 2.5D d100x107mm 1f-d94mm 1f-d24mm		KF1477-T NO. 3293A1 KIT DE FOLE DO CARDAN JUNTO À RODA CITROËN JUMPER (94 A 02) 2.0 Hdi - 2.2 Hdi d116x149mm 1f-d97mm 1f-d29mm
	KF2539-T NO. 3293A1 KIT DE FOLE DO CARDAN JUNTO À RODA CITROËN JUMPER 2.0 HDi - 2.0i - 2.2 HDi (APÓS 2002) d110x150mm 1f-d98mm 1f-d30mm		KT0504 NO. 503341 - 1313045080 - 503341 KIT DE BATENTE SUSPENSÃO DA FRENTE CITROËN JUMPER Autocarro (230P) 2.0 (02.94 A 04.02) 109cv 1998cc Autocarro - CITROËN JUMPER Autocarro (230P) 2.0 4x4 (08.96 A 04.02) 109cv 1998cc Autocarro - CITROËN JUMPER Autocarro (230P) 1.9 D (01.99 A 04.02) 69cv 1905cc Autocarro - CITROËN JUMPER Autocarro (230P) 1.9 TD (08.94 A 04.02) 90cv 1905cc Autocarro - CITROËN JUMPER Autocarro (230P) 1.9 TD (02.94 A 04.02) 92cv 1905cc Autocarro - CITROËN JUMPER Autocarro (230P) 1.9 TD 4x4 (0...etc. d86x211mm 1f-d22mm 1f-d81mm
	KT0507 NO. 503392 - 1340928080 KIT DE BATENTE SUSPENSÃO DA FRENTE CITROËN JUMPER Autocarro (244 - Z_) 2.0 (APÓS 04.02) 110cv 1998cc Autocarro - CITROËN JUMPER Autocarro (244 - Z_) 2.0 bivalent (APÓS 02.03) 110cv 1998cc Autocarro - CITROËN JUMPER Autocarro (244 - Z_) 2.0 HDi (APÓS 04.02) 84cv 1997cc Autocarro - CITROËN JUMPER Autocarro (244 - Z_) 2.2 HDi (APÓS 04.02) 101cv 2179cc Autocarro - CITROËN JUMPER Autocarro (244 - Z_) 2.8 HDi (APÓS 04.02) 128cv 2798cc Autocarro - CITROËN JUMPER Autocarro...etc. d83x191mm 1f-d26mm 1f-d81mm		L3037 NO. 91509516 CASQUILHO DOS PARAFUSOS DE ESCAPE CITROËN JUMPER (APÓS 1994) d23x10mm c8mm 1f-d11/16mm
	L3062 NO. 3523.93 CASQUILHO CENTRAL DO BRAÇO OSCILANTE DA SUSPENSÃO FRENTE CITROËN JUMPER DIESEL TT d58x55mm d44mm 1f-d26mm		M6011 NO. 95602682 - 95603555 JUNTA DE ESCAPE CITROËN JUMPER (APÓS 1994) d59.5x13.5mm 1f-d46.2mm
	M6012 NO. 91516522 - 915377797 - 96033780 - 96038954 - 91539094 JUNTA DE ESCAPE CITROËN JUMPER (APÓS 1994) d79x14mm 1f-d66mm		P1052 NO. 450410 - 450416 CAPA DE PEDAL DO TRAVÃO E EMBRAIAGEM CITROËN JUMPER 1905D - 1930D - 2500D 67x53x12mm NULL
	R221593 NO. 95572893 TUBO DE RADIADOR INFERIOR CITROËN JUMPER B370-d45/33mm 120-190-110-90mm		R8134 NO. 1192E3 TUBO VALVULA REGULADORA DE VELOCIDADE CITROËN JUMPER Autocarro (230P) 1.9 TD (08.94 A 04.02) 90cv 1905cc Autocarro - CITROËN JUMPER Autocarro (230P) 1.9 TD (02.94 A 04.02) 92cv 1905cc Autocarro - CITROËN JUMPER Caixa (230L) 1.9 TD (03.94 A 04.02) 90cv 1905cc Caixa - CITROËN JUMPER Caixa (230L) 1.9 TD (03.94 A 04.02) 92cv 1905cc Caixa - CITROËN JUMPER Camião de plataforma/chassis (230) 1.9 TD (03.94 A 04.02) 90cv 1905cc Camião de plataforma/chassis - CITROËN JUMPER C...etc. B115-d18/16mm 40-40-40mm
	RT08425 NO. 481636 - 481633 TUBO DE TRAVÃO TRÁS LH CITROËN JUMPER TT(+ABS) (APÓS 02-1994) 335mm FB23 - MC11		RT08459 NO. 4806C4 TUBO DE TRAVÃO TRÁS LH-RH CITROËN JUMPER AUTOBUS 2.0 (02-1994 A 04-2002) - 2.0 4X4 (08-1996 A 04-2002) - 2.5 D 4X4 (08-1996 A 04-2002) - 2.8 HDi (09-2000 A 04-2002) - 2.8 HDi 4X4(09-2000 A 04-2002) - 2.0 (APÓS 04-2002) - 2.0 bivalent (APÓS 02-2003) - 2.0 HDi (APÓS 04-2002) - 2.2 H 182mm FB23 - MC11



	<p>RT08459 NO. 4806C4</p> <p>TUBO DE TRAVÃO TRÁS LH-RH</p> <p>CITROËN JUMPER FURGONATO 2.0 (03-1994 A 04-2002) - 2.0 HDi (11-2001 A 04-2002) - 2.5 D 4X4 (03-2000 A 04-2002) - 2.8 HDi (09-2000 A 04-2002) - 2.8 HDi 4X4 (09-2000 A 04-2002) - 2.0 (APÓS 04-2002) - 2.0 bivalent (APÓS 02-2003) - 2.0 HDi (APÓS 04-2002) - 2.</p>		<p>RT08459 NO. 4806C4</p> <p>TUBO DE TRAVÃO TRÁS LH-RH</p> <p>CITROËN JUMPER PIANALE PIATTO/TELAIO 2.0 (03-1994 A 04-2002) - 2.5 D 4X4 (03-2000 A 04-2002) - 2.5 TDi (12-1996 A 04-2002) - 2.5 TDi 4X4 (03-2000 A 04-2002) - 2.8 HDi (09-2000 A 04-2002) - 2.0 HDi (APÓS 04-2002) - 2.2 HDi 16V (APÓS 04-2002) - 2.8 HDi (APÓ</p>
	<p>RT08517 NO. 1306893080 - 480673 - 60750508 - 795023</p> <p>TUBO DE TRAVÃO TRÁS RH</p> <p>CITROËN JUMPER TT(+ABS) (APÓS 02-1994)</p>		<p>RT08531 NO. 480637 - 480654</p> <p>TUBO DE TRAVÃO TRÁS LH-RH</p> <p>CITROËN JUMPER TT (-ABS) (APÓS 02-1994)</p>
	<p>RT08571 NO. 1311401080 - 480670 - 480696</p> <p>TUBO DE TRAVÃO FRENTE LH-RH</p> <p>CITROËN JUMPER TT (APÓS 02-1994)</p>		<p>RT80177 NO. 4806C8</p> <p>TUBO DE TRAVÃO CENTRAL</p> <p>CITROËN JUMPER (MOD 2002) TT (APÓS 11-2001)</p>
	<p>RT80284 NO. 1617432680 - 4806.G7 - 4806.P5</p> <p>TUBO DE TRAVÃO TRÁS LH-RH</p> <p>CITROËN JUMPER TT (APÓS 07-2006)</p>		<p>RT80285 NO. 4806.H4</p> <p>TUBO DE TRAVÃO TRÁS LH-RH</p> <p>CITROËN JUMPER TT (APÓS 07-2006)</p>
	<p>S1514 NO. 513172</p> <p>SILENT BLOC DAS MOLAS DE TRÁS</p> <p>CITROËN - JUMPER Autocarro (230P) - 2.0 Código do mot or: XU10J2U (02.94 - 04.02) 109cv 1998cc - CITROËN - JUMPER Autocarro (230P) - 1.9 TD Código do mot or: XUD9TF - N.º (08.94 - 04.02) 90cv 1905cc - CITROËN - JUMPER Autocarro (230P) - 1.9 TD Código do mot</p>		<p>T0611-I NO. 516661 - 516650 - 516651 - 5166.88</p> <p>BATENTE DA SUSPENSÃO EIXO TRASEIRO</p> <p>CITROËN - JUMPER Autocarro (230P) - 2.0 (02.94 - 04.02) 109cv 1998cc - CITROËN - JUMPER Autocarro (230P) - 2.0 4x4 (08.96 - 04.02) 109cv 1998cc - CITROËN - JUMPER Autocarro (230P) - 1.9 D (01.99 - 04.02) 69cv 1905cc - CITROËN - JUMPER Autocarro (230P) - 1</p>
	<p>T0662-I NO. 1613189980 - 5033.A7 - 5033.A9 - 5033.E6 - 50706737 - 93501847</p> <p>BATENTE SUSPENSÃO DE TRÁS</p> <p>CITROËN JUMPER Autocarro 2.2 HDi 100 (APÓS 04.06) 101cv 2198cc Autocarro - CITROËN JUMPER Autocarro 2.2 HDi 110 (APÓS 07.11) 110cv 2198cc Autocarro - CITROËN JUMPER Autocarro 2.2 HDi 120 (APÓS 04.06) 120cv 2198cc Autocarro - CITROËN JUMPER Autocarro 2.2 HDi 130 (APÓS 07.11) 130cv 2198cc Autocarro - CITROËN JUMPER Autocarro 2.2 HDi 150 (APÓS 07.11) 150cv 2198cc Autocarro - CITROËN JUMPER Autocarro 3.0 HDi 155 (APÓS 07.10) 157cv...etc.</p>		<p>T0663-I NO. 1613190080 - 5033C2 - 50705234 - 50707856</p> <p>BATENTE SUSPENSÃO DA FRENTE</p> <p>CITROËN JUMPER Autocarro 2.2 HDi 110 (APÓS 07.11) 110cv 2198cc Autocarro - CITROËN JUMPER Autocarro 2.2 HDi 130 (APÓS 07.11) 130cv 2198cc Autocarro - CITROËN JUMPER Autocarro 2.2 HDi 150 (APÓS 07.11) 150cv 2198cc Autocarro - CITROËN JUMPER Autocarro 3.0 HDi 155 (APÓS 07.10) 157cv 2999cc Autocarro - CITROËN JUMPER Autocarro 3.0 HDi 180 (APÓS 07.11) 177cv 2999cc Autocarro - CITROËN JUMPER Caixa 2.2 HDi 110 (APÓS 07.11) 110cv 2198cc...etc.</p>
	<p>T0664-I NO. 1613189980 - 5033A7 - 5033A9 - 5033E6 - 50706737 - 935001847</p> <p>BATENTE SUSPENSÃO DA FRENTE</p> <p>CITROËN JUMPER Autocarro 2.2 HDi 100 (APÓS 04.06) 101cv 2198cc Autocarro - CITROËN JUMPER Autocarro 2.2 HDi 110 (APÓS 07.11) 110cv 2198cc Autocarro - CITROËN JUMPER Autocarro 2.2 HDi 120 (APÓS 04.06) 120cv 2198cc Autocarro - CITROËN JUMPER Autocarro 2.2 HDi 130 (APÓS 07.11) 130cv 2198cc Autocarro - CITROËN JUMPER Autocarro 2.2 HDi 150 (APÓS 07.11) 150cv 2198cc Autocarro - CITROËN JUMPER Autocarro 3.0 HDi 155 (APÓS 07.10) 157cv...etc.</p>		<p>T0695-I NO. 503357</p> <p>BATENTE SUSPENSÃO DA FRENTE</p> <p>CITROËN JUMPER Autocarro (230P) 2.8 HDi 4x4 (09.00 A 04.02) 128cv 2798cc Autocarro - CITROËN JUMPER Caixa (230L) 2.8 HDi (09.00 A 04.02) 128cv 2798cc Caixa - CITROËN JUMPER Camião de plataforma/chassis (230) 2.8 D (01.99 A 02.02) 87cv 2798cc Camião de plataforma/chassis - CITROËN JUMPER Autocarro (244 - Z_) 2.0 HDi (APÓS 04.02) 84cv 1997cc Autocarro - CITROËN JUMPER Autocarro (244 - Z_) 2.2 HDi (APÓS 04.02) 101cv 2179cc Autocarro - ...etc.</p>
	<p>W5003 NO. 0515P2 - 0515L8 - 0515L9 - 0515T8 - 0515V5 - 0515V6 - 0515Q3 - 0516A4 - 0516A6 - 051660</p> <p>POLIE DA CABBOTA (6 pistas)</p> <p>CITROËN JUMPER (APÓS 02-2002) 2.0HDI MOTOR DW10 - 2.2HDI MOTOR DW12</p>		<p>W5004 NO. 0515G3 - 051660 - 0516A4 - 0516A6</p> <p>POLIE DA CABBOTA (6 pistas)</p> <p>CITROËN JUMPER (1.9 TD 90 CV - mot. XUD9)</p>

CITROËN JUMPER

Rafri, Lda.

	W5010 NO. 0515.K4 POLIE DA CAMBOTA (6 pistas) CITROËN JUMPER 1.9 D mot. DW8 s-clima (APÓS 1998)		W5073 NO. 0515H7 POLIE DA CAMBOTA (6 PISTAS) CITROËN JUMPER 1.9D TD APÓS 1996
d152.8mm	d30mm	d152.8mm	d30mm
	W5100 NO. 0515.T1 POLIE DA CAMBOTA CITROËN JUMPER 2.2 HDi (APÓS 04-2006)		W5101 NO. 0515V6-0515T8 POLIE DA CAMBOTA CITROËN JUMPER 2.0 HDi
d159.8-139.8mm	d59mm	d152.8mm	d30mm
	W5103 NO. 0515Q0 - 0515S8 POLIE DA CAMBOTA (6 PISTAS) CITROËN JUMPER 2.0 HDi (motor DW10UTD) (APÓS 04-2002)		W5113 NO. 0515S9 - 0515T1 - 9677608180 - 9806722380 POLIE DA CAMBOTA (6+4 PISTAS) CITROËN JUMPER Autocarro 2.2 HDi 100 101CV 2198cc (APÓS 04-2006) - 110CV 2198cc (APÓS 07-2011) - 120CV 2198cc (APÓS 04-2006) - 130CV 2198cc (APÓS 07-2011) - 150CV 2198cc (APÓS 07-2011)
d155/158mm	d30mm	d167mm	3f-d13mm
	W5113 NO. 0515S9 - 0515T1 - 9677608180 - 9806722380 POLIE DA CAMBOTA (6+4 PISTAS) CITROËN JUMPER Caixa 2.2 HDi 100 101CV 2198cc (APÓS 04-2006) - 110CV 2198cc (APÓS 07-2011) - 120CV 2198cc (APÓS 04-2006) - 130CV 2198cc (APÓS 07-2011) - 150CV 2198cc (APÓS 07-2011)		W5113 NO. 0515S9 - 0515T1 - 9677608180 - 9806722380 POLIE DA CAMBOTA (6+4 PISTAS) CITROËN JUMPER Camião de plataforma/chassis - 2.2 HDi 100 101CV 2198cc (APÓS 04-2006) - 120CV 2198cc (APÓS 04-2006) - 130CV 2198cc (APÓS 07-2011) - 150CV 2198cc (APÓS 07-2011)
d167mm	3f-d13mm	d167mm	3f-d13mm
	Y3001 NO. 95608790 - 91521270 - 91521271 - 96118164 PARAFUSO DE ESCAPE CITROËN JUMPER (APÓS 1994)		Z80805 NO. 856543 MOLA DE FIXAÇÃO FRISO LATERAL CITROËN JUMPER II - III
65x8mm	1p-d6-15mm	F-7.6 - T-20 - L-11 - H-17 - H-18	NULL
	Z9001 NO. 7910029764 - 91510245 - 75530745 - 9150246180 MOLA DE ESCAPE 26mm CITROËN JUMPER (APÓS 1994)		Z9008 NO. 96062723 - 96092921 MOLA DE ESCAPE CITROËN JUMPER (APÓS 1994)
d21x26mm	NULL	d21x34mm	NULL

CITROËN JUMPY

	A1588 NO. 1827.16 APOIO DO MOTOR PARTE DE TRÁS CITROËN JUMPY 1.6 - 1.9 TD - 2.0 - 2.0 TD		E0207-M NO. 1806.28 ESTICADOR DO MOTOR (SUPERIOR) CITROËN JUMPY
140x98x92mm	NULL	165x62x44mm	NULL

	<p>F1633-I NO. 328781 - 329781</p> <p>FOLE DA TRANSMISSÃO JUNTO À CAIXA</p> <p>CITROËN JUMPY (APÓS 94) 1.6i - 1.9D</p>		<p>F4037 NO. 406641</p> <p>FOLE DA DIREÇÃO LADO DIREITO E ESQUERDO</p> <p>CITROËN JUMPY 1.6 i - 1.9 D - 1.9 TD APÓS 94</p>
	<p>KF1405 NO. 329301 - 9566934080</p> <p>KIT DE FOLE DO CARDAN JUNTO À RODA</p> <p>CITROËN JUMPY (APÓS 1994) 1.9D</p>		<p>KF2435 NO. 329300 - 9566933988</p> <p>KIT DE FOLE DO CARDAN JUNTO À RODA</p> <p>CITROËN JUMPY (APÓS 1994) 1.9TD</p>
	<p>Q2009 NO.</p> <p>UNIÃO DE ESCAPE 48/45x80mm</p> <p>CITROËN - JUMPY (U6U) - 1.9 D (10.95 - 04.98) 69cv 1905cc Veículo multiuso</p>		<p>RT08569 NO. 147919080 - 480682</p> <p>TUBO DE TRAVÃO FRENTE LH-RH</p> <p>CITROËN JUMPY TT (APÓS 02-1996)</p>
	<p>RT08570 NO. 480668 - 480681</p> <p>TUBO DE TRAVÃO TRÁS LH-RH</p> <p>CITROËN JUMPY TT (APÓS 02-1996)</p>		<p>RT08573 NO. 1472157080 - 480667</p> <p>TUBO DE TRAVÃO TRÁS LH-RH</p> <p>CITROËN JUMPY TT (APÓS 02-1996)</p>
	<p>RT80318 NO. 4806.H5</p> <p>TUBO DE TRAVÃO TRÁS LH-RH</p> <p>CITROËN JUMPY TT (APÓS 01-2007)</p>		<p>RT80329 NO. 4806.H6</p> <p>TUBO DE TRAVÃO TRÁS LH-RH</p> <p>CITROËN JUMPY TT (APÓS 01-2007)</p>
	<p>RT80361 NO. 4806.H0</p> <p>TUBO DE TRAVÃO FRENTE LH-RH</p> <p>CITROËN JUMPY TT (APÓS 01-2007)</p>		<p>S1468 NO. 1313083080 - 1305551080</p> <p>SILENT BLOC ESQUERDO DO BRAÇO DA SUSPENSÃO DA FRENTE</p> <p>CITROËN JUMPY 1.6 - 1.6i - 1.9D - 1.9D 70 - 1.9TD - 2.0 - 2.0HDI 95 - 2.0HDI 110 (APÓS 1995)</p>
	<p>S1469 NO. 1313084080 - 1305552080</p> <p>SILENT BLOC DIREITO DO BRAÇO DA SUSPENSÃO DA FRENTE</p> <p>CITROËN JUMPY 1.6 - 1.6i - 1.9D - 1.9D 70 - 1.9TD - 2.0 - 2.0HDI 95 - 2.0HDI 110 (APÓS 1995)</p>		<p>S1470 NO. 1312317080</p> <p>SILENT BLOC CENTRAL DO BRAÇO DA SUSPENSÃO DA FRENTE</p> <p>CITROËN JUMPY 1.6 - 1.6i - 1.9D - 1.9D 70 - 1.9TD - 2.0 - 2.0HDI 95 - 2.0HDI 110 (APÓS 1995)</p>
	<p>S1519 NO. 515261 - 1479759080 - 515261</p> <p>SILENT BLOC DO BRAÇO TRANSVERSAL EIXO TRASEIRO</p> <p>CITROËN JUMPY (U6U) 1.6 (APÓS 10-1995) 79CV 1581CC - CITROËN JUMPY (U6U) 2.0 (04-2000 A 12-2006) 136CV 1997CC - CITROËN JUMPY 1.9 D 70 (APÓS 04-1998) 60CV 1868CC - CITROËN JUMPY (U6U) 1.9 D (10-1995 A 04-1998) 69CV 1905CC - CITROËN JUMPY (U6U) 1.9 TD (APÓS 04-1995) 69CV 1905CC</p>		<p>S1594 NO. 5131F4 - 1400171280</p> <p>SILENT-BLOC SUSPENSÃO EIXO TRASEIRO</p> <p>CITROËN JUMPY 2.0 i (A Partir de 01.07) 140cv 1997cc Veículo multiuso - CITROËN JUMPY 1.6 HDI 90 16V (A Partir de 01.07) 90cv 1560cc Veículo multiuso - CITROËN JUMPY 2.0 HDi 120 (A Partir de 01.07) 120cv 1997cc Veículo multiuso - CITROËN JUMPY 2.0 HDi 140 (A Partir de 01.07) 136cv 1997cc Veículo multiuso - CITROËN JUMPY 2.0 HDi 165 (A partir de 07.10) 163cv 1997cc Veículo multiuso</p>

	<p>T0665-I NO. 503339 - 1307021080</p> <p><i>BATENTE SUSPENSÃO DA FRENTE</i></p> <p>CITROËN JUMPY (U6U) 1.6 (APÓS 10.95) 79cv 1581cc Veículo multiuso - CITROËN JUMPY (U6U) 2.0 (04.00 A 12.06) 136cv 1997cc Veículo multiuso - CITROËN JUMPY (U6U) 2.0 i 16V (APÓS 03.00) 138cv 1997cc Veículo multiuso - CITROËN JUMPY (U6U) 1.9 D 70 (APÓS 04.98) 69cv 1868cc Veículo multiuso - CITROËN JUMPY (U6U) 1.9 D (10.95 A 04.98) 69cv 1905cc Veículo multiuso - CITROËN JUMPY (U6U) 1.9 TD (APÓS 10.95) 90cv 1905cc Veículo multius...etc.</p> <p>d54x107mm 1f-d25mm 1f-d20mm</p>		<p>T1123 NO. 509469</p> <p><i>BATENTE DA BARRA ESTABILIZADORA DA FRENTE</i></p> <p>CITROËN JUMPY 1.6 1580 SPI - 220 A2.00 79CV (APÓS 10-1995) - 1.9 D D9B (XUD9A/U) 69CV (10-1995 A 04-1998) - 1.9 D 70 WJZ (DW8) 69CV (APÓS 04-1998) - 1.9 TD (D8B (XUD9TF) 92CV (APÓS 04-1996) - 1.9 TD DHX (XUD9TF/BTF) 90CV (APÓS 10-1995) - 2.0 RFN (EW10J4) 13</p> <p>64x53x45x50mm 1f-d24.5mm</p>
	<p>T1123 NO. 509469</p> <p><i>BATENTE DA BARRA ESTABILIZADORA DA FRENTE</i></p> <p>CITROËN JUMPY FURGONATO 1.6 i 1580 SPI - 220 A2.00 79CV (APÓS 10-1995) - 1.9 D 70 WJZ (DW8) 69CV (APÓS 04-1998) - 1.9 TD DHX (XUD9TF/BTF) 90CV (APÓS 10-1995) - 2.0 HDi 110 RHW (DW10ATED4) 109CV (APÓS 01-2002) - 2.0 HDi 110 RHZ (DW10ATED) 109CV (APÓS 01-2002)</p> <p>64x53x45x50mm 1f-d24.5mm</p>		<p>W5003 NO. 0515P2 - 0515L8 - 0515L9 - 0515T8 - 0515V5 - 0515V6 - 0515Q3 - 0516A4 - 0516A6 - 051660</p> <p><i>POLIE DA CAMBOTA (6 pistas)</i></p> <p>CITROËN JUMPY 1.9D mot. DW8 - 2.0 HDi 95 MOTOR DW10BTED - 2.0 HDi 110 MOTOR DW10ATED - 2.0 HDi 120 MOTOR DW10UTED4</p> <p>d152.8mm d30mm</p>
	<p>W5004 NO. 0515G3 - 051660 - 0516A4 - 0516A6</p> <p><i>POLIE DA CAMBOTA (6 pistas)</i></p> <p>CITROËN JUMPY (1.9 TD 90 CV - mot. XUD9)</p> <p>d152.8mm d30mm</p>		<p>W5009 NO. 0515Q6 - 0515L7 - 0516A4 - 051660 - 9624596880 - 9637218980 - 9666471189 - 9634848980</p> <p><i>POLIE DA CAMBOTA (6 pistas)</i></p> <p>CITROËN JUMPY 1.9D mot. DW8 s-clima (APÓS 1998)</p> <p>d152.8mm d36mm</p>
	<p>W5085 NO. 0514Q8 - 96433641</p> <p><i>POLIE DA CAMBOTA (6 PISTAS)</i></p> <p>CITROËN JUMPY (MOD 2007) 2.0 HD (APÓS 01-2007) Mtr DW10BTED4 (88-100KW)</p> <p>d153/158mm d16mm</p>		<p>W5091 NO. 0515T3 - 0516A3 - 1690296 - 1487861 - AV6Q6B319AA - Y66211401 - Y40111406A - 11237801979 - 112378...</p> <p><i>POLIE DA CAMBOTA (6 PISTAS)</i></p> <p>CITROËN JUMPY (APÓS 01-2007) 1.6 HDi 90</p> <p>d157mm d30mm</p>
	<p>W5101 NO. 0515V6-0515T8</p> <p><i>POLIE DA CAMBOTA</i></p> <p>CITROËN JUMPY 1.9D - 2.0 HDi</p> <p>d152.8mm d30mm</p>		<p>W5146 NO. 0515R1</p> <p><i>POLIE DA CAMBOTA 6 PISTAS</i></p> <p>CITROËN JUMPY (U6U) 2.0 N.º mot . a part ir de: 0961750 - Código do motor: EW10J4 - Variant e de equipamento: Mtr 0961750> - N.º mot . a part ir de: 0822887 - Variant e de equipament o: Mtr 0822887> 04.00 - 12.06 100 136 1997 Veículo multiuso CITROËN JUMPY (U6U) 2.0 i 16V Código do mot or: EW10J4 03.00 - 102 138 1997 Veículo multiuso CITROËN JUMPY Caixa (BS_ - BT_ - BY_ - BZ_) 2.0 i 16V N.º mot . a part ir de: 0822887 - Código do mot o...etc.</p> <p>d148,5mm d30mm</p>
	<p>Z80518 NO. 14115980 - 155809966 - 6992G2</p> <p><i>Mola de retenção</i></p> <p>CITROËN JUMPY</p> <p>d13x9mm 1p-7x7-8mm 1f-d4.8mm</p>		<p>Z80838 NO. 6991_Y8 - 7703077468 - 7703077469 - 8201112162</p> <p><i>Mola</i></p> <p>CITROËN JUMPY</p> <p>d17x18.5mm 1p-d7.5-10.5mm</p>
	<p>Z80842 NO. 8565.46 - 8565.47</p> <p><i>Mola de painel</i></p> <p>CITROËN JUMPY</p> <p>17.7x10x20mm 1p-d10-9mm</p>		

	S1595 NO. 50511650 - 50521486 - 51783056 - 51783057		T0656-I NO. 5033.00 - 5033.F2 - 5033.E2
	SILENT-BLOC BRAÇO SUPERIOR FRENTE CITROËN NEMO Combi 1.4 (A partir de 04.09) 73cv 1360cc Combi - CITROËN NEMO Combi 1.3 HDi 75 (A partir de 10.10) 75cv 1248cc Combi - CITROËN NEMO Combi 1.4 HDi (A partir de 04.09) 68cv 1399cc Combi - CITROËN NEMO Caixa (AA_) 1.4 (A partir de 02.08) 73cv 1360cc Caixa - CITROËN NEMO Caixa (AA_) 1.3 HDi 75 (A partir de 10.10) 75cv 1248cc Caixa - CITROËN NEMO Caixa (AA_) 1.4 HDi (A partir de 02.08) 68cv 1398cc Caixa		BATENTE SUSPENSÃO DA FRENTE CITROËN NEMO Caixa (AA_) 1.4 (APÓS 02.08) 73cv 1360cc Caixa - CITROËN NEMO Caixa (AA_) 1.3 HDi 75 (APÓS 10.10) 75cv 1248cc Caixa - CITROËN NEMO Caixa (AA_) 1.4 HDi (APÓS 02.08) 68cv 1398cc Caixa
d53x67mm d41mm 1f-d14mm		d63x65mm 1f-d27mm 1f-d20mm	
	T0657-I NO. 51804746		
	BATENTE SUSPENSÃO DA FRENTE CITROËN NEMO Combi 1.4 (APÓS 04.09) 73cv 1360cc Combi - CITROËN NEMO Combi 1.3 HDi 75 (APÓS 10.10) 75cv 1248cc Combi - CITROËN NEMO Caixa (AA_) 1.4 (APÓS 02.08) 73cv 1360cc Caixa - CITROËN NEMO Caixa (AA_) 1.3 HDi 75 (APÓS 10.10) 75cv 1248cc Caixa - CITROËN NEMO Caixa (AA_) 1.4 HDi (APÓS 02.08) 68cv 1398cc Caixa		
d71x76mm 1f-d25mm 1f-d12mm			

CITROËN SAXO

	A1522 NO. 1844.60 - 1844.58 - 1844.66 - 9401844666 - 9628826080		A1633 NO. 184459
	APOIO MOTOR FRENTE LADO DIREITO CITROËN SAXO (APÓS 1996) 1.5D - 1.6		APOIO DO MOTOR PARTE DA FRENTE INTERMÉDIO CITROËN SAXO 1.0 - 1.1 - 1.4 - 1.5 D - 1.6
150x90x90mm NULL		110x50x40mm NULL	
	E0131 NO. 5087.40 - 93802209 - 9617783680		E1046 NO. 175570
	ESTICADOR DA BARRA ESTABILIZADORA DA FRENTE CITROËN SAXO TT (APÓS 1996) (APÓS CH:08150)		ESTICADOR DE ESCAPE CENTRAL CITROËN SAXO 1.5 D (09-1996 A 06-2003)
340x40x40mm 2p-d12-35mm		74x35x48mm NULL	
	F1124K-I NO. 95653092		KF1474-T NO. 329311
	FOLE DO SEMI-EIXO DO DIFERENCIAL LADO CAIXA CITROËN SAXO 1.0i - 1.1i		KIT DE FOLE DO CARDAN JUNTO À RODA CITROËN SAXO 1.0i X - 1.1i X - SX - 1.4i VTS - 1.5D - EL (APÓS 1996)
d65x165mm 1f-d63mm 1f-d20mm		d80x110mm 1f-d72mm 1f-d22mm	
	KF2418-T NO. 329313		KF2419-T NO. 329308
	KIT DE FOLE DO CARDAN JUNTO À RODA CITROËN SAXO 1.0i X - 1.1i X - SX - 1.4i VTS - 1.5D (APÓS 1996)		KIT DE FOLE DO CARDAN JUNTO À RODA CITROËN SAXO 1.0i X - 1.1i X - SX (APÓS 1996)
d85x110mm 1f-d72mm 1f-d30mm		d85x110mm 1f-d73mm 1f-d20mm	
	RT08515 NO. 480656 - 96080322		RT08516 NO. 480657 - 480675 - 480694
	TUBO DE TRAVÃO FRENTE LH-RH CITROËN SAXO TT		TUBO DE TRAVÃO TRÁS RH CITROËN SAXO TT (APÓS 02-1996)
315mm FZ - MC11		220mm FZ - FZ	





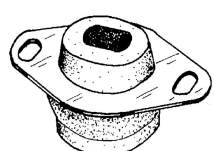









	RT08518 NO. 480661 TUBO DE TRAVÃO TRÁS LH CITROËN SAXO 1.0X (05-96 A 11-98) - 1.1X - SX (05-96 A 09-03) - 1.4 VTS (05-96 A 06-03) - 1.5D (09-96 A 09-03) - 1.6 VTS (06-96 A 09-03) - 1.6 VTL - VTR (05-96 A 06-03)		RT08570 NO. 480668 - 480681 TUBO DE TRAVÃO FRENTE LH-RH CITROËN SAXO TT (APÓS 02-1996)
	RT08620 NO. 480655 TUBO DE TRAVÃO FRENTE LH-RH CITROËN SAXO 1.0 - 1.1 (APÓS 02-1996) (TAMBOR COM 3 FUIROS APÓS CHASSI O08093)		S1557 NO. 513163 - 5131.65 SILENT BOLC DO EIXO TRASEIRO CITROËN SAXO (S0 - S1) 1.0 X 05.96 - 11.98 33 45 954 Hatchback CITROËN SAXO (S0 - S1) 1.0 X 05.98 - 06.03 37 50 954 Hatchback CITROËN SAXO (S0 - S1) 1.1 X - SX 05.96 - 09.03 40 54 1124 Hatchback CITROËN SAXO (S0 - S1) 1.1 X - SX 05.96 - 09.03 44 60 1124 Hatchback
	T0030 NO. 96054481 BATENTE DA BARRA ESTABILIZADORA (CENTRO) CITROËN SAXO 1.4 - 1.4VTS - 1.5 (1998 A 2003)		W5007 NO. 0515L6 - 0516A4 - 051660 POLIE DA CAMBOTA (5 pistas) CITROËN SAXO (1.5 D - mot. TDU5)
	W5024 NO. 0515H6 POLIE DA CAMBOTA (6 pistas) CITROËN SAXO 1.6 VTS MOTORES LFY - XU7JP4 - RFV - XU10J4R - NFZ - XU75P		W5029 NO. 0515.J3 POLIE DA CAMBOTA (5 PISTAS) CITROËN SAXO 1.6 VTS (TU5JP4-NFT)
	W5064 NO. 0515.k8 POLIE DA CAMBOTA (5 PISTAS) CITROËN SAXO 1.6 MOTOR TU5JP		Z80518 NO. 14115980 - 155809966 - 6992G2 Mola de retenção CITROËN SAXO
	Z80712 NO. 699050 Mola de painel CITROËN SAXO		Z80720 NO. 696640 Mola de painel CITROËN SAXO

CITROËN VISA-CITROËN LN-LNA

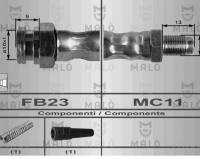
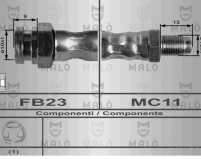
	A0008 NO. 1807.47 - 915071180 APOIO TRASEIRO DO MOTOR CITROËN VISA DIESEL		A0330 NO. 96033565 - 91521643 SUPORTE CAIXA DE VELOCIDADES ESQUERDO CITROËN VISA GT DIESEL
--	--	--	---

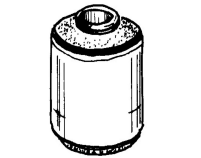
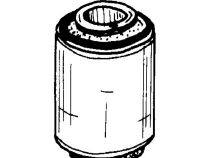









	A1028 NO. 91517554 - 91538407 SUPORTE FRENTE DIREITO DO MOTOR CITROËN VISA GT DIESEL d82x79mm 1p-d10-22mm 1p-d10-31mm		A1028-H NO. 91517554 SUPORTE FRENTE DIREITO DO MOTOR (HIDRÁULICO) CITROËN VISA GT DIESEL d82x79mm 1p-d10-22mm 1p-d10-31mm
	A1054 NO. 1844.17 SUPORTE DO MOTOR CITROËN VISA NULL NULL		A1183 NO. 7910032165 APOIO DIREITO DO MOTOR CITROËN VISA - VISA 11 - VISA GT 66x48x40mm 2p-d10-20mm
	BB12 NO. ABRAÇADEIRA DA BARRA ESTABILIZADORA CITROËN VISA 79x52x40mm NULL		BE17 NO. 75420467 ABRAÇADEIRA DE ESCAPE CÔNCAVA 49mm CITROËN LN - LNA (1976 A 1986) 86x48x15mm 49mm
	BE17 NO. 75420467 ABRAÇADEIRA DE ESCAPE CÔNCAVA 49mm CITROËN VISA (1978 A 1988) 86x48x15mm 49mm		E0004 NO. 75420014 - 91503080 - 54200.14 ESTICADOR DE ESCAPE CITROËN LN - LNA (77-86) - LNA (82-86) 65x45x24mm NULL
	E0004 NO. 75420014 - 91503080 - 54200.14 ESTICADOR DE ESCAPE CITROËN VISA (82-88) - CITROËN VISA I - 11 (78-88) - CITROËN VISA DIESEL 65x45x24mm NULL		E0011 NO. 5503569 - 7910031809 - 791009543 - 7910009543 ESTICADOR DE ESCAPE CITROËN LN - LNA (77-86) - CITROËN LNA (82-86) d80x35mm d60mm 2f-d8mm
	E0011 NO. 5503569 - 7910031809 - 791009543 - 7910009543 ESTICADOR DE ESCAPE CITROËN VISA I. II (78-88) d80x35mm d60mm 2f-d8mm		E0026 NO. 5484441 ESTICADOR DE ESCAPE CITROËN LN - LNA (77-86) d60x30mm 1f-d43mm
	E0031 NO. G-5420014W - 91503080 - 95576338 ESTICADOR DE ESCAPE CITROËN LN - LNA 64x45x40mm NULL		E0031 NO. G-5420014W - 91503080 - 95576338 ESTICADOR DE ESCAPE CITROËN VISA TT 64x45x40mm NULL
	E0145 NO. 5087.23 - 5087.32 ESTICADOR DA BARRA ESTABILIZADORA DA FRENTE CITROËN VISA 1.6 GTI 350x45x40mm 1p-d10-30mm 1p-d10-24mm		F0079 NO. 7910014837 - 7910032252 FOLE DA CREMALHEIRA DA DIREÇÃO ESQ. E DIR. CITROËN LN - LNA (ATÉ 10-78) d80x108mm 1f-d47mm 1f-d26mm

	<p>F0505-I NO. 406614 - 7910014837 - 7910032252</p> <p>FOLE DA DIREÇÃO LADO DIREITO E ESQUERDO</p> <p>CITROËN - LNA - 0.6 (1.7.6 A 0.7.9) 3 3cv 6 0 2cc Hatchback - CITROËN - LNA - 0.6 (0.7.8 2 A 0.4.8 5) 3 4cv 6 5 2cc Hatchback - CITROËN - LNA - 0.6 L (1.7.8 A 0.7.8 6) 3 5cv 6 5 2cc Hatchback - CITROËN - LN</p> <p>d85x125mm 1f-d25mm 1f-d43mm</p>		<p>F0506-I NO. 91510923 - 91510913</p> <p>FOLE DA CREMALHEIRA DA DIREÇÃO ESQ. E DIR. (F29)</p> <p>CITROËN LN - LNA</p> <p>d71x155mm 1f-d39mm 1f-d9mm</p>
	<p>F0506-I NO. 91510923 - 91510913</p> <p>FOLE DA CREMALHEIRA DA DIREÇÃO ESQ. E DIR. (F29)</p> <p>CITROËN VISA SUPER L - GT - VISA DIESEL</p> <p>d71x155mm 1f-d39mm 1f-d9mm</p>		<p>F0817-I NO. 95532950</p> <p>FOLE DO SEMI-EIXO JUNTO À RODA</p> <p>CITROËN VISA T.T</p> <p>d80x116mm 1f-d73mm 1f-d18mm</p>
	<p>F0818-I NO. 95532951</p> <p>FOLE DO SEMI-EIXO JUNTO À CAIXA DE VELOCIDADES</p> <p>CITROËN VISA ESPECIAL DIESEL</p> <p>d85x86mm 1f-d18mm</p>		<p>F1089-I NO. 9403293778</p> <p>FOLE DA TRANSMISSÃO LADO DA RODA</p> <p>CITROËN VISA 1.8 DIESEL</p> <p>d93x110mm 1f-d80mm 1f-d22mm</p>
	<p>KB2069 NO.</p> <p>KIT DA BARRA ESTABILIZADORA</p> <p>CITROËN VISA</p> <p>NULL NULL</p>		<p>KF0840 NO. 95532942 - 95532947 - AZ17388A - AZ37303</p> <p>KIT FOLE CARDAN JUNTO CAIXA</p> <p>CITROËN LNA 0.6 (11.76 A 07.79) 33cv 602cc Hatchback - CITROËN LNA 0.6 (07.82 A 04.85) 34cv 652cc Hatchback - CITROËN LNA 0.6 (11.78 A 07.86) 35cv 652cc Hatchback - CITROËN LNA 1.0 (07.84 A 10.86) 45cv 954cc Hatchback - CITROËN LNA 1.1 (07.82 A 04.85) 50cv 1124cc Hatchback</p> <p>d107x60mm 1f-d41mm 1f-d73mm</p>
	<p>L1008 NO. 91500679</p> <p>CASQUILO DA BARRA ESTABILIZADORA</p> <p>CITROËN VISA</p> <p>d21x14mm 1f-d8mm</p>		<p>L3019 NO. 509304</p> <p>CASQUILHO INFERIOR DO BRAÇO DA SUSPENSÃO</p> <p>CITROËN LNA</p> <p>d47x11mm 1f-d20mm</p>
	<p>L3019 NO. 509304</p> <p>CASQUILHO INFERIOR DO BRAÇO DA SUSPENSÃO</p> <p>CITROËN VISA</p> <p>d47x11mm 1f-d20mm</p>		<p>M6012 NO. 91516522 - 915377797 - 96033780 - 96038954 - 91539094</p> <p>JUNTA DE ESCAPE</p> <p>CITROËN VISA (1985 A 1988)</p> <p>d79x14mm 1f-d66mm</p>
	<p>M6086 NO. 91537799 - 96587799</p> <p>JUNTA DE ESCAPE</p> <p>CITROËN VISA (1984 A 1987)</p> <p>d70x13mm 1f-d58mm</p>		<p>MT6700 NO.</p> <p>JUNTA DE TERMOSTATO</p> <p>CITROËN VISA (GASOLINA-DIESEL)</p> <p>d52x2mm 1f-d43mm</p>
	<p>N3727 NO.</p> <p>ANEL DE ESCAPE</p> <p>CITROËN VISA GTI</p> <p>d55x12mm 1f-d31mm</p>		<p>N8066 NO. 5460614 - 5481691 - ZF04437668 - 1755.92 - 1755.38 - 1755.60</p> <p>ANEL DE ESCAPE</p> <p>CITROËN VISA GTi 1.6L (APÓS 1985)</p> <p>d70x17mm 1f-d38mm</p>

	<p>R220494 NO. 75515119 TUBO DE RADIADOR SUPERIOR CITROËN VISA (1124)</p> <p>B375-d35/35mm 60-75-185-55mm</p>		<p>R220495 NO. 75515121 - 95533542 TUBO DE RADIADOR INFERIOR CITROËN VISA (1124)</p> <p>B395-d32/32mm 50-125-330-155mm</p>
	<p>R220496 NO. 95545882 TUBO DE RADIADOR SUPERIOR CITROËN VISA (1219)</p> <p>B395-d32/30mm 65-205-75-60mm</p>		<p>R220497 NO. 95545880 TUBO DE RADIADOR INFERIOR CITROËN VISA (1219)</p> <p>B410-d30/32mm 50-55-340-100-70mm</p>
	<p>RT08383 NO. 7910022619 - 7910021226 - 91500900 TUBO DE TRAVÃO FRENTE LH-RH CITROËN LN (10-1976 A 7-1979) - LNA 4CV (652) (11-1978 A 1988)</p> <p>370mm FB23 - MC11</p>		<p>RT08383 NO. 7910022619 - 7910021226 - 91500900 TUBO DE TRAVÃO FRENTE LH-RH CITROËN VISA TT (09-1978 A 1986) (1.6GTi - 1.7 D 5 vel)</p> <p>370mm FB23 - MC11</p>
	<p>RT08386 NO. 75492063 - 75494063 - 75492063 TUBO DE TRAVÃO FRENTE LH CITROËN LNA 1124 (07-1982 A 1988)</p> <p>352mm FB23 - M11</p>		<p>RT08386 NO. 75492063 - 75494063 - 75492063 TUBO DE TRAVÃO FRENTE LH-RH CITROËN VISA TT (09-1978 A 1986)</p> <p>352mm FB23 - M11</p>
	<p>RT08528 NO. 480629 TUBO DE TRAVÃO FRENTE LH-RH CITROËN VISA 1.7 D (04-1984 A 1986)</p> <p>350mm FB23 - MC11</p>		<p>RT08529 NO. 480631 - 91517513 TUBO DE TRAVÃO FRENTE LH-RH CITROËN VISA 1.6 GTi (01-1985 A 03-1991)</p> <p>435mm FB23 - MC11</p>
	<p>S1082 NO. 91515653 SILENT-BLOC CENTRAL DO BRAÇO DE SUSPENSÃO FRENTE CITROËN VISA 0.6 (07-1982 A 03-1991) - VISA 1.7D (04-1984 A 03-1991)</p> <p>d48x25mm d36mm 1f-d12mm</p>		<p>S1088 NO. 3523.20 - 91096727 - 352320 SILENT-BLOC DO BRAÇO DA SUSPENSÃO FRENTE CITROËN VISA 0.6 - 1.4GT - 1.7D</p> <p>d28x34mm c28mm 1f-d10mm</p>
	<p>S1089 NO. 96096727 - 7910035449 SILENT-BLOC DO BRAÇO DA SUSPENSÃO FRENTE CITROËN VISA TT</p> <p>d28x34mm c28mm 1f-d10mm</p>		<p>S1195 NO. 3523.14 SILENT-BLOC DO BRAÇO DA SUSPENSÃO CITROËN VISA 0.6 MOTOR V06-665</p> <p>d38x42mm c24mm 1f-d13.6mm</p>
	<p>S1305 NO. 1809.04 - 91201175 SILENT-BLOC DO TIRANTE TRASEIRO MOTOR CITROËN VISA D - 0.6 MOTPR V06-665</p> <p>d30x34mm c28mm 1f-d12mm</p>		<p>T1008 NO. 91500679 BATENTE DE ESTABILIZADOR CITROËN VISA 0.6 MOTOR V06-665</p> <p>43x38x43mm 1f-d-22mm</p>

CITROËN VISA-CITROËN LN-LNA

Rafri, Lda.

	W5001 NO. 0515k9 POLIE DA CAMBOTA (5 pistas) CITROËN VISA (MOT XUD7) d142mm d30mm		Y3003 NO. 91512792 PARAFUSO ESCAPE CITROËN LNA (1982 A 1986) d13x78mm d7mm 1p-d7mm
	Y3003 NO. 91512792 PARAFUSO ESCAPE CITROËN VISA (1978 A 1988) d13x78mm d7mm 1p-d7mm		Z80275 NO. Mola de painel Citroën Visa d14x16.5mm NULL
	Z80520 NO. 95571660 Mola de friso CITROËN VISA 54x27x5mm NULL		Z80632 NO. 698317 Mola de painel CITROËN LNA d21x26mm 1p-d7.5-24mm
	Z80752 NO. 7568H0 Mola de painel CITROËN LNA d21.7x17mm 1p-d7.7-14mm		Z80752 NO. 7568H0 Mola de painel CITROËN LN d21.7x17mm 1p-d7.7-14mm
	Z80753 NO. 7903074042 - 6995Q3 Mola de fixação CITROËN LNA d15x14.5mm 1p-11x15-12.5mm 1f-d9mm		Z80753 NO. 7903074042 - 6995Q3 Mola de fixação CITROËN LN d15x14.5mm 1p-11x15-12.5mm 1f-d9mm

CITROËN XANTIA

	A1400 NO. 182710 - 184436 SUPORTE MOTOR ESQUERDO CITROËN XANTIA 1.9 SD - 1.9TD - 2.0i 16V - 2.0 HDi 135x90x58mm 1f-d11mm		A1401 NO. 1809.21 - 1809.29 - 1809.16 SUPORTE DO MOTOR TRÁS CITROËN XANTIA 1.8i - 1.9D - 2.0 TURBO - 2.1TD - 2.0 HDi d70x53mm c40mm 1f-d10mm
	A1738 NO. 503824 - 503878 - 96090345 APOIO DO AMORTECEDOR DA FRENTE CITROËN XANTIA 2.0 HDi 90 - 2.0 HDi 90 BREAK (03-1999 A 04-2003) 170x145x50mm 1f-d14mm 4f-d8mm		BE20 NO. 5453900 - 54837624 ABRAÇADEIRA DE ESCAPE CÔNCAVA 69mm CITROËN XANTIA (APÓS 1993) 110x64x18mm NULL

	<p>E0131 NO. 5087.40 - 93802209 - 9617783680</p> <p>ESTICADOR DA BARRA ESTABILIZADORA DA FRENTE</p> <p>CITROËN XANTIA TT (APÓS 1996) (APÓS CH:08150)</p> <p>340x40x40mm 2p-d12-35mm</p>		<p>E0132 NO. 96145457</p> <p>ESTICADOR DA BARRA ESTABILIZADORA DA FRENTE</p> <p>CITROËN XANTIA TT (APÓS 1993) (APÓS CH:06614)</p> <p>345x40x40mm 2p-d10-25mm</p>
	<p>E1006 NO. 175561 - 96125080 - 1755.56</p> <p>ESTICADOR DE ESCAPE</p> <p>CITROËN XANTIA</p> <p>68x45x20mm NULL</p>		<p>E1008 NO. 175559 - 96037651</p> <p>ESTICADOR DE ESCAPE</p> <p>CITROËN XANTIA TURBO DIESEL (APÓS 03-1993) - XANTIA CATALIZADOR (APÓS 03-1993) - XANTIA DIESEL (APÓS 03-1993)</p> <p>70x46x36mm NULL</p>
	<p>E1037 NO. 1755.H2 - 8V517M121AD</p> <p>ESTICADOR DE ESCAPE CENTRAL</p> <p>CITROËN XANTIA 1.6i (03-1993 A 01-1998) - 1.8i 16V (06-1995 A 04-2003) - 1.8i16V BREAK (06-1995 A 04-2003) - 1.9 D (06-1994 A 01-1998) - 1.9 TD (10-1994 A 04-2003) - 1.9 TD BREAK (06-1995 A 04-2003) - 2.0i 16V (03-1993 A 04-2003) - 2.0i 16V BREAK (06-1995)</p> <p>74x50x39mm NULL</p>		<p>E1056 NO.</p> <p>ESTICADOR DE ESCAPE</p> <p>CITROËN XANTIA (APÓS 1995)</p> <p>65x63x38mm 1f-d14mm 1f-d9mm</p>
	<p>E1066 NO. 175586</p> <p>ESTICADOR DE ESCAPE FRENTE</p> <p>CITROËN XANTIA 2.0 HDi 90 (03-1999 A 04-2003) - 2.0 HDi 90 BREAK (03-1999 A 04-2003)</p> <p>74x60x48mm NULL</p>		<p>F1286-I NO. 95618785 - 95653005</p> <p>FOLE DO LADO DA RODA (JUNTA d90mm EIXO d25mm)</p> <p>CITROËN XANTIA 1.9D (1993 A 1998)</p> <p>d98x98mm 1f-d86mm 1f-d22mm</p>
	<p>F1299-I NO. 96127397</p> <p>FOLE DIRECÇÃO ASSISTIDA DIREITO E ESQUERDO</p> <p>CITROËN XANTIA (APÓS 1993) 1.6 - 1.8 - 1.9D - 1.9TD - 2.0 16V - 2.0 TURBO - 2.1TD</p> <p>d66x210mm 1f-d42mm 1f-d10mm</p>		<p>F1301-I NO. 9609802380 - 329724</p> <p>FOLE DO LADO DA CAIXA</p> <p>CITROËN XANTIA 1.6i - 2.0i (1993 A 1998) - 2.0i (APÓS 1998)</p> <p>d90x100mm 1f-d78mm 1f-d25mm</p>
	<p>F1367-T NO. 3293.03</p> <p>FOLE DA TRANSMISSÃO LADO DA RODA (Termoplástico)</p> <p>CITROËN XANTIA 1.6 - 1.8 - 2.0 - 1.9 DIESEL - 1.9 TURBO DIESEL</p> <p>d108x115mm 1f-d87mm 1f-d35mm</p>		<p>F1369-T NO. 3293.02</p> <p>FOLE DA TRANSMISSÃO LADO DA RODA</p> <p>CITROËN XANTIA 2.0 TURBO - 2.0 TURBO DIESEL (APÓS 1996)</p> <p>d109x129mm 1f-d98mm 1f-d40mm</p>
	<p>F1633-I NO. 328781 - 329781</p> <p>FOLE DA TRANSMISSÃO JUNTO À CAIXA</p> <p>CITROËN XANTIA (98 A 01) 1.8i - 1.8i 16V - 1.9 D SD - 1.9 TD - 2.0 HDi - 2.0i - 2.0i 16V</p> <p>d87x104mm 1f-d80mm 1f-d34mm</p>		<p>L3037 NO. 91509516</p> <p>CASQUILHO DOS PARAFUSOS DE ESCAPE</p> <p>CITROËN XANTIA (APÓS 1993)</p> <p>d23x10mm c8mm 1f-d11/16mm</p>
	<p>M6011 NO. 95602682 - 95603555</p> <p>JUNTA DE ESCAPE</p> <p>CITROËN XANTIA (APÓS 1993)</p> <p>d59.5x13.5mm 1f-d46.2mm</p>		<p>M6012 NO. 91516522 - 91537797 - 96033780 - 96038954 - 91539094</p> <p>JUNTA DE ESCAPE</p> <p>CITROËN XANTIA (APÓS 1993)</p> <p>d79x14mm 1f-d66mm</p>





	<p>M6086 NO. 91537799 - 96587799</p> <p>JUNTA DE ESCAPE</p> <p>CITROËN XANTIA (APÓS 1993)</p> <p>d70x13mm 1f-d58mm</p>		<p>P1006 NO. 160407 - 9603694380</p> <p>CAPA DE PEDAL DO ACELERADOR</p> <p>CITROËN XANTIA 2.0 HDi</p> <p>82x43x11mm NULL</p>
	<p>P1086 NO. 213015</p> <p>CAPA DE PEDAL DA EMBRAIAGEM</p> <p>CITROËN XANTIA (X2) 2.0 HDI 90 (03-1999 A 04-2003) 90CV 1997CC - CITROËN XANTIA BREAK (X2) 2.0 HDI 90 (03-1999 A 04-2003) 90CV 1997CC</p> <p>76x46x12mm NULL</p>		<p>RT08577 NO. 96109017</p> <p>TUBO DE TRAVÃO FRENTE LH-RH</p> <p>CITROËN XANTIA TT (APÓS 1993)</p> <p>385mm FZ - MC11</p>
	<p>S1184-D NO. 352382 - 96188215</p> <p>SILENT-BLOC DA SUSPENSÃO DA FRENTE LADO DIREITO</p> <p>CITROËN XANTIA 1.6i - 1.8i - 1.9D - 1.9TD - 2.0i - 2.0 TURBO - 2.1TD</p> <p>105x90x75mm 1f-d18mm</p>		<p>S1184-E NO. 352381 - 96188214</p> <p>SILENT-BLOC EXTERIOR DO BRAÇO DA SUSPENSÃO FRENTE</p> <p>CITROËN XANTIA 1.6i - 1.8i - 1.9D - 1.9TD - 2.0i - 2.0 TURBO - 2.1TD</p> <p>100x90x70mm 1f-d18mm</p>
	<p>S1204 NO. 96083570 - 3523.84 - 3523.87</p> <p>SILENT-BLOC SUSPENSÃO DA FRENTE</p> <p>CITROËN XANTIA 1.6i - 1.8i - 1.9D - 1.9TD - 2.0i - 2.0 TURBO - 2.1TD - 2.0HDi - 3.0V6</p> <p>d46x38mm d37mm 1f-d12mm</p>		<p>S1468 NO. 1313083080 - 1305551080</p> <p>SILENT BLOC ESQUERDO DO BRAÇO DA SUSPENSÃO DA FRENTE</p> <p>CITROËN XANTIA 2.0 HDi 109 (1999 A 2003)</p> <p>130x132x85mm d60mm c62mm 1f-d22.8mm</p>
	<p>S1469 NO. 1313084080 - 1305552080</p> <p>SILENT BLOC DIREITO DO BRAÇO DA SUSPENSÃO DA FRENTE</p> <p>CITROËN XANTIA 2.0HDi 109 (1999 A 2003)</p> <p>130x132x85mm d60mm c62mm 1f-d22.8mm</p>		<p>S1470 NO. 1312317080</p> <p>SILENT BLOC CENTRAL DO BRAÇO DA SUSPENSÃO DA FRENTE</p> <p>CITROËN XANTIA 2.0HDi 109 (1999 A 2003)</p> <p>126x50x62mm 1f-d22.8mm 2f-d12mm</p>
	<p>W5003 NO. 0515P2 - 0515L8 - 0515L9 - 0515T8 - 0515V5 - 0515V6 - 0515Q3 - 0516A4 - 0516A6 - 051660</p> <p>POLIE DA CAMBOTA (6 pistas)</p> <p>CITROËN XANTIA (2.0 HDi-mot. DW10)</p> <p>d152.8mm d30mm</p>		<p>W5004 NO. 0515G3 - 051660 - 0516A4 - 0516A6</p> <p>POLIE DA CAMBOTA (6 pistas)</p> <p>CITROËN XANTIA (1.9 D 75CV - mot. XUD9)</p> <p>d152.8mm d30mm</p>
	<p>W5004 NO. 0515G3 - 051660 - 0516A4 - 0516A6</p> <p>POLIE DA CAMBOTA (6 pistas)</p> <p>CITROËN XANTIA (1.9 TD 90 CV - mot. XUD9)</p> <p>d152.8mm d30mm</p>		<p>W5011 NO. 0515J9</p> <p>POLIE DA CAMBOTA (6 pistas)</p> <p>CITROËN XANTIA 2.1 TD 12V mot. XUD11 - XM</p> <p>d152.8mm d30mm</p>
	<p>W5012 NO. 0515S2</p> <p>POLIE DA CAMBOTA (6 pistas)</p> <p>CITROËN XANTIA EXCLUSIVE V6 BVA - 3.0 V6 ACTIVA - EXCLUSIVE V6 BREAK</p> <p>d143.8mm d42mm</p>		<p>W5014 NO. 0515G6</p> <p>POLIE DA CAMBOTA (6 pistas)</p> <p>CITROËN XANTIA 2.0i 16V (06-1998 A 01-1998) MOTOR XU10J4</p> <p>d127mm d42mm</p>





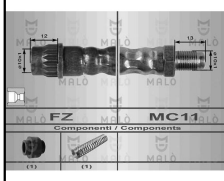









	<p>W5024 NO. 0515H6</p> <p>POLIE DA CAMBOTA (6 pistas)</p> <p>CITROËN XANTIA 1.8i - 1.8i 16v - 2.0i MOTORES LFY - XU7JP4 - RFV - XU10J4R - NFZ - XU75P</p> <p>d127mm d30mm</p>		<p>W5033 NO. 0515.K6</p> <p>POLIE DA CAMBOTA (6 PISTAS)</p> <p>CITROËN XANTIA 1.6i (03-1993 A 01-1998) MOTOR XU5JP - 1.8i 16V (06-1995 A 01-1998) MOTOR XU7JP4</p> <p>d127mm d30mm</p>
	<p>W5101 NO. 0515V6-0515T8</p> <p>POLIE DA CAMBOTA</p> <p>CITROËN XANTIA 2.0 HDi</p> <p>d152.8mm d30mm</p>		<p>Y3001 NO. 95608790 - 91521270 - 91521271 - 96118164</p> <p>PARAFUSO DE ESCAPE</p> <p>CITROËN XANTIA (APÓS 1993)</p> <p>65x8mm 1p-d6-15mm</p>
	<p>Z80268 NO. 7903077112</p> <p>Mola de painel</p> <p>CITROËN XANTIA</p> <p>d16.5x21mm 1p-d6.6-15mm</p>		<p>Z80518 NO. 14115980 - 155809966 - 6992G2</p> <p>Mola de retenção</p> <p>CITROËN XANTIA</p> <p>d13x9mm 1p-7x7-8mm 1f-d4.8mm</p>
	<p>Z80594 NO. 696634</p> <p>Mola de painel</p> <p>CITROËN XANTIA</p> <p>d18x19.5mm 1p-d7.5-17mm</p>		<p>Z80596 NO. 7903077167</p> <p>Mola de painel</p> <p>CITROËN XANTIA</p> <p>d12x20.4mm 1p-d6.5-18.4mm</p>
	<p>Z80606 NO. 9609212380</p> <p>Mola de fixação</p> <p>CITROËN XANTIA</p> <p>d10x11mm 1p-d7-10mm 1f-d6mm</p>		<p>Z80678 NO. 856535</p> <p>Mola de friso</p> <p>CITROËN XANTIA</p> <p>d18x20mm 1p-d9-14mm</p>
	<p>Z80720 NO. 696640</p> <p>Mola de painel</p> <p>CITROËN XANTIA</p> <p>d20x20mm 1p-d8-17.5mm</p>		<p>Z80755 NO. 96120786</p> <p>Mola de painel</p> <p>CITROËN XANTIA</p> <p>d16.6x40mm 1p-d7.5-18mm</p>
	<p>Z9008 NO. 96062723 - 96092921</p> <p>MOLA DE ESCAPE</p> <p>CITROËN XANTIA (APÓS 1993)</p> <p>d21x34mm NULL</p>		

	<p>BE16 NO. 5433461 - 5483762 - 95483762</p> <p>ABRAÇADEIRA DE ESCAPE CÔNCAVA 66mm</p> <p>CITROËN XM (1989 A 1996)</p> <p>116x64x16mm 66mm</p>		<p>BE22 NO. 171344</p> <p>ABRAÇADEIRA ESCAPE</p> <p>CITROËN XM (APÓS 1993)</p> <p>96x100x18mm 1p-d10-75mm</p>
	<p>E1006 NO. 175561 - 96125080 - 1755.56</p> <p>ESTICADOR DE ESCAPE</p> <p>CITROËN XM</p> <p>68x45x20mm NULL</p>		<p>E1008 NO. 175559 - 96037651</p> <p>ESTICADOR DE ESCAPE</p> <p>CITROËN XM 2.0i - 2.1TD - 2.0 TURBO - 2.5TD - 3.0 V6</p> <p>70x46x36mm NULL</p>
	<p>E1037 NO. 1755.H2 - 1755.A2 - 1755.L5 - 9652054680</p> <p>ESTICADOR DE ESCAPE CENTRAL</p> <p>CITROËN XM 2.1 TD 12V (11-1991 A 04-1994)</p> <p>74x50x39mm NULL</p>		<p>F1286-I NO. 95618785 - 95653005</p> <p>FOLE DO LADO DA RODA (JUNTA d90mm EIXO d25mm)</p> <p>CITROËN XM 3.0 INJEÇÃO 2975 cc.</p> <p>d98x98mm 1f-d86mm 1f-d22mm</p>
	<p>F1298-I NO. 95639173</p> <p>FOLE DIREÇÃO ASSISTIDA</p> <p>CITROËN XM 2.0i (1998 A 1994) - 2.1D (1989 A 2000)</p> <p>d68x120mm 2f-d42mm</p>		<p>F1356-I NO. 9617054480 - 3287.77 - 9564479480</p> <p>FOLE DO LADO DA CAIXA</p> <p>CITROËN XM 16 S 1998 cc. BVM (ME5-T) (APÓS 9-93) - 2.0iT - 2.0i - 2.5TD - 3.0i (1994 A 2000)</p> <p>d85x90mm 1f-d76mm 1f-d28mm</p>
	<p>F1369-T NO. 3293.02</p> <p>FOLE DA TRANSMISSÃO LADO DA RODA</p> <p>CITROËN XM 2.5 TURBO DIESEL (APÓS 9-1994)</p> <p>d109x129mm 1f-d98mm 1f-d40mm</p>		<p>F1627-I NO. 328780</p> <p>FOLE DA TRANSMISSÃO JUNTO À CAIXA</p> <p>CITROËN XM 2.5 TD - 3.0i V6 (1994 A 2000) - XANTIA 2.0 HDi - 2.0i - 2.0i T - 2.1 TD 12V (1993 A 2001)</p> <p>d90x95mm 1f-d83mm 1f-d40mm</p>
	<p>KF1473-T NO. 329398</p> <p>KIT DE FOLE DO CARDAN JUNTO À RODA</p> <p>CITROËN XM 2.0i 16V - 2.0i T - 2.5 TD - 3.0i V6 (1994 A 2000) - JUMPER 1.9D - 1.9 TD - 2.0i - 2.5D & 4X4 - 2.5 TD - 2.5 TD iD & 4X4 (1994 A 2002) - XANTIA 2.0i - 2.1 TD 12V (1993 A 2001)</p> <p>d110x150mm 1f-d98mm 1f-d29mm</p>		<p>KF1497-T NO. 329396</p> <p>KIT DE FOLE DO CARDAN JUNTO À RODA E CAIXA</p> <p>CITROËN XM 2.0i 16V - 2.1D 12V - 2.1D D12 (1989 A 2000) - XANTIA 2.0i - 2.0i 16V - 2.0i T (1993 A 2001)</p> <p>d105x140mm 1f-d88mm 1f-d25mm</p>
	<p>L3037 NO. 91509516</p> <p>CASQUILHO DOS PARAFUSOS DE ESCAPE</p> <p>CITROËN XM (APÓS 1989)</p> <p>d23x10mm c8mm 1f-d11/16mm</p>		<p>M6012 NO. 91516522 - 915377797 - 96033780 - 96038954 - 91539094</p> <p>JUNTA DE ESCAPE</p> <p>CITROËN XM (APÓS 1989)</p> <p>d79x14mm 1f-d66mm</p>
	<p>P1006 NO. 160407 - 9603694380</p> <p>CAPA DE PEDAL DO ACELERADOR</p> <p>CITROËN XM</p> <p>82x43x11mm NULL</p>		<p>W5011 NO. 0515J9</p> <p>POLIE DA CAMBOTA (6 pistas)</p> <p>CITROËN XM 2.1TD 12V MOTOR XUD11ATE</p> <p>d152.8mm d30mm</p>

	<p>W5012 NO. 0515S2 <i>POLIE DA CAMBOTA (6 pistas)</i> CITROËN XM 3.0 V6 (03-2001 A 08-2004)</p> <p>d143.8mm d42mm</p>		<p>W5014 NO. 0515G6 <i>POLIE DA CAMBOTA (6 pistas)</i> CITROËN XM</p> <p>d127mm d42mm</p>
	<p>W5021 NO. 0515H3 - 051660 - 0516A4 <i>POLIE DA CAMBOTA (6 pistas)</i> CITROËN XM (2.5 TD) (ATÉ 1994)</p> <p>d142.5mm d31mm</p>		<p>W5031 NO. 0515.F8 <i>POLIE DA CAMBOTA (5 PISTAS)</i> CITROËN XM 2.1D TD</p> <p>d146mm d30mm</p>
	<p>W5033 NO. 0515.K6 <i>POLIE DA CAMBOTA (6 PISTAS)</i> CITROËN XM 2.0 16V</p> <p>d127mm d30mm</p>		<p>Y3001 NO. 95608790 - 91521270 - 91521271 - 96118164 <i>PARAFUSO DE ESCAPE</i> CITROËN XM (APÓS 1989)</p> <p>65x8mm 1p-d6-15mm</p>
	<p>Z10673 NO. 697207 - 113857117B <i>Mola de fixação</i> CITROËN XM</p> <p>d8x17.7mm 1p-d3.5-8.2mm</p>		<p>Z80268 NO. 7903077112 <i>Mola de painel</i> CITROËN XM</p> <p>d16.5x21mm 1p-d6.6-15mm</p>
	<p>Z80594 NO. 696634 <i>Mola de painel</i> CITROËN XM</p> <p>d18x19.5mm 1p-d7.5-17mm</p>		<p>Z80596 NO. 7903077167 <i>Mola de painel</i> CITROËN XM</p> <p>d12x20.4mm 1p-d6.5-18.4mm</p>
	<p>Z80606 NO. 9609212380 <i>Mola de fixação</i> CITROËN XM</p> <p>d10x11mm 1p-d7-10mm 1f-d6mm</p>		<p>Z9001 NO. 7910029764 - 91510245 - 75530745 - 9150246180 <i>MOLA DE ESCAPE 26mm</i> CITROËN XM (1989 A 1996)</p> <p>d21x26mm NULL</p>
	<p>Z9008 NO. 96062723 - 96092921 <i>MOLA DE ESCAPE</i> CITROËN XM (APÓS 1989)</p> <p>d21x34mm NULL</p>		

	<p>A1693 NO. 1807J2</p> <p>APOIO DO MOTOR PARTE DE TRÁS</p> <p>CITROËN XSARA PICASSO 1.8 (16V) - 2.0 HDI</p> <p>210x200x115mm 1f-d10mm</p>		<p>A1738 NO. 503824 - 503878 - 96090345</p> <p>APOIO DO AMORTECEDOR DA FRENTE</p> <p>CITROËN XSARA 1.4i - 1.4HDI - 1.5D - 1.6 16V - 1.8i - 1.8i AUT - 1.8D - 1.9D - 1.9SD - 1.9TD - 2.0 16V - 2.0 HDi 90 - 2.0 HDi 109 (1997 A 2005) - XSARA BREAK (1997 A 2005) - XSARA COUPÉ (1997 A 2005) - XSARA PICASSO 1.6 - 1.6HDI - 1.8 16V - 2.0 16V - 2.0H</p> <p>170x145x50mm 1f-d14mm 4f-d8mm</p>
	<p>A1922 NO. 1714E3 - 9642742880 - 1755E4 - 17565YV010</p> <p>APOIO DO ESCAPE</p> <p>CITROËN XSARA (N1) 2.0 16V N.º chas. a partir de: NR.PR.08946 (09.00 A 03.05) 136cv 1997cc Hatchback - CITROËN XSARA (N1) 1.4 HDi Sistema de escape: para tubo de escape (01.03 A 03.05) 68cv 1398cc Hatchback - CITROËN XSARA Break (N2) 1.4 HDi Sistema de escape: para tubo de escape (01.03 A 08.05) 68cv 1398cc Combi - CITROËN XSARA PICASSO (N68) 1.6 HDi Sistema de escape: para tubo de escape - Local de montagem: à frente (APÓS 05.04) 109c...etc.</p> <p>53x39x45mm 2p-d6-18mm</p>		<p>E1037 NO. 1755.H2 - 1755.A2 - 1755.L5 - 9652054680</p> <p>ESTICADOR DE ESCAPE CENTRAL</p> <p>CITROËN XSARA 1.4i (04-1997 A 03-2005) - 1.4i BREAK (10-1997 A 08-2005) - 1.4i COUPÉ (03-1998 A 03-2005) - 1.4i HDi (01-2003 A 03-2005) - 1.4 HDi BREAK (01-2003 A 08-2005) - 1.4 HDi COUPÉ (01-2003 A 03-2005) - 1.5 D (04-1997 A 09-2000) - 1.5 BREAK (10-1999</p> <p>74x50x39mm NULL</p>
	<p>E1037 NO. 1755.H2 - 1755.A2 - 1755.L5 - 9652054680</p> <p>ESTICADOR DE ESCAPE CENTRAL</p> <p>CITROËN XSARA 1.9 D (04-1997 A 03-2005) - 1.9 D BREAK (10-1997 A 08-2005) - 1.9 D COUPÉ (02-1998 A 03-2005) - 1.9 TD (04-1997 A 09-2000) - 1.9 TD BREAK (10-1997 A 09-2000) - 1.9 TD COUPÉ (02-1998 A 09-2000) - 1.9 SD (01-1998 A 09-2000) - 2.0i 16V COUPÉ (0</p> <p>74x50x39mm NULL</p>		<p>E1037 NO. 1755.H2 - 1755.A2 - 1755.L5 - 9652054680</p> <p>ESTICADOR DE ESCAPE CENTRAL</p> <p>CITROËN XSARA PICASSO 1.6 (APÓS 06-2000) - 1.6 HDi (APÓS 05-2004) - 1.8 16V (APÓS 02-2000) - 2.0 16V (APÓS 01-2003) - 2.0 HDi (APÓS 12-1999)</p> <p>74x50x39mm NULL</p>
	<p>E1066 NO. 175586</p> <p>ESTICADOR DE ESCAPE FRENTE</p> <p>CITROËN XSARA 1.4i (04-1997 A 03-2005) - 1.4i BREAK (10-1997 A 08-2005) - 1.4i COUPÉ (03-1998 A 03-2005) - 1.5 D (04-1997 A 09-2000) - 1.5 D BREAK (10-1997 A 09-2000) - 1.6i (04-1997 A 09-2000) - 1.6i BREAK (10-1997 A 09-2000) - 1.6i COUPÉ (02-1998 A 09-2</p> <p>74x60x48mm NULL</p>		<p>E1066 NO. 175586</p> <p>ESTICADOR DE ESCAPE FRENTE</p> <p>CITROËN XSARA 1.8 i (04-1997 A 09-2000) - 1.8 i BREAK (10-1997 A 09-2000) - 1.8 i COUPÉ (02-1998 A 09-2000) - 1.8 i AUT.(04-1997 A 09-2000) - 1.8 i 16V (04-1997 A 09-2000) - 1.8 i 16V BREAK (10-1997 A 09-2000) - 1.8 i 16V COUPÉ (02-1998 A 09-2000) - 1.9 D</p> <p>74x60x48mm NULL</p>
	<p>E1066 NO. 175586</p> <p>ESTICADOR DE ESCAPE FRENTE</p> <p>CITROËN XSARA 2.0 16V (04-1997 A 03-2005) - 2.0 16V BREAK (07-1998 A 08-2005) - 2.0 16V COUPÉ (09-2000 A 03-2005) - 2.0 HDi 90 (02-1999 A 03-2005) - 2.0 HDi 90 BREAK (02-1999 A 08-2005) - 2.0 HDi 90 COUPÉ (02-1999 A 03-2005) - 2.0 HDi 109 (05-2001 A 03-20</p> <p>74x60x48mm NULL</p>		<p>E1101 NO. 175591</p> <p>ESTICADOR DE ESCAPE FRENTE</p> <p>CITROËN XSARA PICASSO 1.6 (APÓS 06-2000) - 1.8 16V (APÓS 02-2000) - 2.0 HDi (APÓS 12-1999)</p> <p>180x64x40mm 2p-d6-18mm</p>
	<p>F1463-I NO. 406616</p> <p>FOLE DA DIRECÇÃO LADO DIREITO E ESQUERDO</p> <p>CITROËN XSARA 1.4 HDi - 1.4i - 1.5D - 1.6i - 1.6i 16V - 1.8D - 1.8i - 1.8i 16V - 1.9D - 1.9 TD - 2.0 HDi - 2.0i 16V (1997 A 2004) - XSARA PICASSO 1.6i - 1.8i 16V - 2.0 HDi (APÓS 1999)</p> <p>d50x70mm 1f-d40mm 1f-d10mm</p>		<p>F1633-I NO. 328781 - 329781</p> <p>FOLE DA TRANSMISSÃO JUNTO À CAIXA</p> <p>CITROËN XSARA (97 A 04) 1.4 HDi - 1.6i 16V - 1.8 D - 1.8i - 1.8i 16V - 1.9 D - 1.9 TD - 2.0 HDi - 2.0i 16V</p> <p>d87x104mm 1f-d80mm 1f-d34mm</p>
	<p>F1633-I NO. 328781 - 329781</p> <p>FOLE DA TRANSMISSÃO JUNTO À CAIXA</p> <p>CITROËN XSARA PICASSO (APÓS 99) 1.6i - 1.8i 16V - 2.0 HDi - 2.0i 16V</p> <p>d87x104mm 1f-d80mm 1f-d34mm</p>		<p>F1821-I NO. 328788 - 3287.93</p> <p>FOLE DA TRANSMISSÃO JUNTO À CAIXA</p> <p>CITROËN XSARA 1.4i - 1.5D - 1.6i 16V (97 A 04)</p> <p>d77x85mm 1f-d72mm 1f-d28mm</p>
	<p>KF1425 NO. 329320</p> <p>KIT FOLE LADO RODA</p> <p>CITROËN XSARA (N1) 1.4 i (04.97 A 03.05) 75cv 1360cc Hatchback - CITROËN XSARA (N1) 1.6 i (04.97 A 09.00) 88cv 1587cc Hatchback - CITROËN XSARA (N1) 1.6 16V (09.00 A 03.05) 109cv 1587cc Hatchback - CITROËN XSARA Break (N2) 1.4 i (10.97 A 08.05) 75cv 1360cc Combi - CITROËN XSARA Break (N2) 1.6 i (10.97 A 09.00) 88cv 1587cc Combi - CITROËN XSARA Break (N2) 1.6 i (10.97 A 09.00) 88cv 1587cc Combi - CITROËN XSARA Break (N2) 1.6 16V (09.00 A 08.05) 109cv 1587cc Combi - CITROËN XSARA Coupé (N0) 1.4...etc.</p> <p>d96x110mm 1f-d30mm 1f-d77mm</p>		<p>KF1480-T NO. 329331</p> <p>KIT DE FOLE DO CARDAN JUNTO À RODA</p> <p>CITROËN XSARA (97 A 04) 1.4 HDi - 1.6i 16V - 1.9 D - 2.0 HDi - 2.0i 16V - XSARA PICASSO (APÓS 1999) 2.0 HDi - 2.0i 16V</p> <p>d107x117mm 1f-d89mm 1f-d35mm</p>

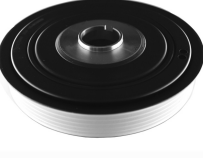
	<p>P1086 NO. 213015</p> <p>CAPA DE PEDAL DA EMBRAIAGEM</p> <p>CITROËN XSARA (N1) 1.4 I (04-1997 A 03-2005) 75CV 1360CC - CITROËN XSARA (N1) 1.6 I (04-1997 A 09-2000) 88CV 1587CC - CITROËN XSARA (N1) 1.6 16V (09-2000 A 03-2005) 109CV 1587CC - CITROËN XSARA (N1) 1.8 I (04-1997 A 09-2000) 90CV 1761CC - CITROËN XSARA (N)</p> <p>76x46x12mm NULL</p>		<p>RT08485 NO. 480685 - 96132698</p> <p>TUBO DE TRAVÃO FRENTE LH-RH</p> <p>CITROËN XSARA - XSARA PICASSO - TT (APÓS 12-1999)</p> <p>470mm FZ - MC11</p>
	<p>RT08519 NO. 480691 - 4806E0 - 4806A8 - 96037347</p> <p>TUBO DE TRAVÃO FRENTE LH-RH</p> <p>CITROËN XSARA TT (APÓS 4-1997) (BERLINA 1.4 - 1.6 - 1.8 - 1.9D) (ABS)</p> <p>484mm FZ - MC11</p>		<p>RT08548 NO. 480665 - 96124223</p> <p>TUBO DE TRAVÃO TRÁS LH-RH</p> <p>CITROËN XSARA BERLINA 1.4 1.6 1.8 1.9D (-ABS) (APÓS 04-1997) - XSARA TT EXCEPTO BERLINA 1.4 1.6 1.8 1.9D</p> <p>230mm FB23 - FB23</p>
	<p>RT08548 NO. 480665 - 96124223</p> <p>TUBO DE TRAVÃO TRÁS LH</p> <p>CITROËN XSARA TT EXCEPTO BERLINA 1.4 1.6 1.8 1.9D (-ABS) (APÓS 04-1997)</p> <p>230mm FB23 - FB23</p>		<p>RT08561 NO. 480686</p> <p>TUBO DE TRAVÃO TRÁS LH-RH</p> <p>CITROËN XSARA - XSARA PICASSO - TT (APÓS 12-1999)</p> <p>255mm FZ1 - FZ1</p>
	<p>RT08626 NO. 480664</p> <p>TUBO DE TRAVÃO TRÁS RH</p> <p>CITROËN XSARA TT (APÓS 1997) - XSARA TT (-ABS) (APÓS 04-1997)</p> <p>265mm FB23 - FB23</p>		<p>RT80227 NO.</p> <p>TUBO DE TRAVÃO TRÁS LH-RH (APÓS CHASSI 09527)</p> <p>CITROËN XSARA PICASSO TT</p> <p>260mm FB53 - FZ</p>
	<p>S1304 NO. 95644954 - 4059.07</p> <p>SILENT-BLOC DO PISTÃO DIRECÇÃO ASSISTIDA</p> <p>CITROËN XSARA 1.4I - 1.5D - 1.8D - 1.8TD - 1.8i 16V - 1.9D - 1.9TD - 2.0 16V - 2.0HDI 90-109</p> <p>d22x24mm c20mm 1f-d11.5mm</p>		<p>S1381 NO. 352383</p> <p>SILENT-BLOC DO BRAÇO DA SUSPENSÃO DA FRENTE</p> <p>CITROËN XSARA PICASSO 1.6 - 1.8 16V - 2.0 HDI</p> <p>100x60x40mm 1f-d18mm</p>
	<p>T0677-I NO. 503327 - 9151930280</p> <p>BATENTE SUSPENSÃO DA FRENTE</p> <p>CITROËN XSARA (N 1) 1.4 i (04.97 A 03.05) 75cv 1360cc Hatchback - CITROËN XSARA (N 1) 1.6 i (04.97 A 09.00) 88cv 1587cc Hatchback - CITROËN XSARA (N 1) 1.6 16V (09.00 A 03.05) 109cv 1587cc Hatchback - CITROËN XSARA (N 1) 1.8 i (04.97 A 09.00) 90cv 1761cc Hatchback - CITROËN XSARA (N 1) 1.8 i Aut. (04.97 A 09.00) 101cv 1761cc Hatchback - CITROËN XSARA (N 1) 1.8 i 16V (04.97 A 09.00) 110cv 1761cc Hatchback - CITROËN XSARA (N 1) 2.0 16...etc.</p> <p>d57x102mm 1f-d26mm 1f-d18mm</p>		<p>T0677-I NO. 503327 - 9151930280</p> <p>BATENTE SUSPENSÃO DA FRENTE</p> <p>CITROËN XSARA PICASSO (N68) 1.6 (APÓS 12.99) 88cv 1587cc Veículo multiuso - CITROËN XSARA PICASSO (N 68) 1.6 (APÓS 12.99) 95cv 1587cc Veículo multiuso 3/3 CITROËN XSARA PICASSO (N68) 1.6 16V (APÓS 09.05) 109cv 1587cc Veículo multiuso - CITROËN XSARA PICASSO (N68) 1.8 16V (APÓS 02.00) 115cv 1749cc Veículo multiuso - CITROËN XSARA PICASSO (N68) 2.0 16V (APÓS 01.03) 136cv 1997cc Veículo multiuso - CITROËN XSARA PICASSO (N68) 1.6...etc.</p> <p>d57x102mm 1f-d26mm 1f-d18mm</p>
	<p>T0680-I NO. 516663 - 9621916980</p> <p>BATENTE SUSPENSÃO DA FRENTE</p> <p>CITROËN XSARA Break (N2) 1.4 i (10.97 A 08.05) 75cv 1360cc Combi - CITROËN XSARA Break (N2) 1.6 i (10.97 A 09.00) 88cv 1587cc Combi - CITROËN XSARA Break (N2) 1.6 16V (09.00 A 08.05) 109cv 1587cc Combi - CITROËN XSARA Break (N2) 1.8 i (10.97 A 09.00) 90cv 1761cc Combi - CITROËN XSARA Break (N2) 1.8 i Aut. (10.97 A 09.00) 101cv 1761cc Combi - CITROËN XSARA Break (N2) 1.8 i 16V (10.97 A 09.00) 110cv 1761cc Combi - CITROËN XSARA Break (...etc.</p> <p>d54x82mm 1f-d18mm 1f-d18x7mm</p>		<p>T0680-I NO. 516663 - 9621916980</p> <p>BATENTE SUSPENSÃO DA FRENTE</p> <p>CITROËN XSARA PICASSO (N68) 1.6 (APÓS 12.99) 88cv 1587cc Veículo multiuso - CITROËN XSARA PICASSO (N68) 1.6 (APÓS 12.99) 95cv 1587cc Veículo multiuso - CITROËN XSARA PICASSO (N68) 1.6 16V (APÓS 09.05) 109cv 1587cc Veículo multiuso - CITROËN XSARA PICASSO (N68) 1.8 16V (APÓS 02.00) 115cv 1749cc Veículo multiuso - CITROËN XSARA PICASSO (N68) 2.0 16V (APÓS 01.03) 136cv 1997cc Veículo multiuso - CITROËN XSARA PICASSO (N68) 1.6 HD...etc.</p> <p>d54x82mm 1f-d18mm 1f-d18x7mm</p>
	<p>T0681-I NO. 503326 - 9151964280</p> <p>BATENTE SUSPENSÃO DA FRENTE</p> <p>CITROËN XSARA (N1) 1.4 i (04.97 A 03.05) 75cv 1360cc Hatchback - CITROËN XSARA (N1) 1.6 i (04.97 A 09.00) 88cv 1587cc Hatchback - CITROËN XSARA (N1) 1.6 16V (09.00 A 03.05) 109cv 1587cc Hatchback - CITROËN XSARA (N1) 1.8 i (04.97 A 09.00) 90cv 1761cc Hatchback - CITROËN XSARA (N1) 1.8 i Aut. (04.97 A 09.00) 101cv 1761cc Hatchback - CITROËN XSARA (N1) 1.8 i 16V (04.97 A 09.00) 110cv 1761cc Hatchback - CITROËN XSARA (N1) 2.0 16V (04.97...etc.</p> <p>d55x81mm 1f-d25mm 1f-d16mm</p>		<p>T0681-I NO. 503326 - 9151964280</p> <p>BATENTE SUSPENSÃO DA FRENTE</p> <p>CITROËN XSARA Break (N2) 1.6 i (10.97 A 09.00) 88cv 1587cc Combi - CITROËN XSARA Break (N2) 1.6 16V (09.00 A 08.05) 109cv 1587cc Combi - CITROËN XSARA Break (N2) 1.8 i (10.97 A 09.00) 90cv 1761cc Combi - CITROËN XSARA Break (N2) 1.8 i Aut. (10.97 A 09.00) 101cv 1761cc Combi - CITROËN XSARA Break (N2) 1.8 i 16V (10.97 A 09.00) 110cv 1761cc Combi - CITROËN XSARA Break (N2) 1.8 i 16V (10.97 A 09.00) 110cv 1761cc Combi - CITROËN XSARA Break (N2) 2.0 16V (09.00 A 08.05) 136cv 1997cc Combi - CITROËN XSARA Brea...etc.</p> <p>d55x81mm 1f-d25mm 1f-d16mm</p>











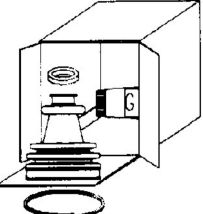



	T0681-I NO. 503326 - 9151964280 BATENTE SUSPENSÃO DA FRENTE CITROËN XSARA Coupé (N0) 1.4 i (03.98 A 03.05) 75cv 1360cc Coupé - CITROËN XSARA Coupé (N0) 1.6 i (02.98 A 09.00) 88cv 1587cc Coupé - CITROËN XSARA Coupé (N0) 1.8 i (02.98 A 09.00) 101cv 1761cc Coupé - CITROËN XSARA Coupé (N0) 1.8 i 16V (02.98 A 09.00) 110cv 1761cc Coupé - CITROËN XSARA Coupé (N0) 2.0 i 16V (02.98 A 03.05) 163cv 1998cc Coupé - CITROËN XSARA Coupé (N0) 1.9 TD (02.98 A 09.00) 90cv 1905cc Coupé d55x81mm 1f-d25mm 1f-d16mm		T0687-I NO. 503365 BATENTE SUSPENSÃO DA FRENTE CITROËN XSARA PICASSO (N68) 1.6 (APÓS 12.99) 88cv 1587cc Veículo multiuso - CITROËN XSARA PICASSO (N68) 1.6 (APÓS 12.99) 95cv 1587cc Veículo multiuso - CITROËN XSARA PICASSO (N68) 1.6 16V (APÓS 09.05) 109cv 1587cc Veículo multiuso - CITROËN XSARA PICASSO (N68) 1.8 16V (APÓS 02.00) 115cv 1749cc Veículo multiuso - CITROËN XSARA PICASSO (N68) 2.0 16V (APÓS 01.03) 136cv 1997cc Veículo multiuso - CITROËN XSARA PICASSO (N68) 1.6 HD...etc. d56x112mm 1f-d24mm 1f-d19mm
	W5001 NO. 0515K9 POLIE DA CAMBOTA (5 pistas) CITROËN XSARA (MOT XUD7) (1997 A 2000) d142mm d30mm		W5003 NO. 0515P2 - 0515L8 - 0515L9 - 0515T8 - 0515V5 - 0515V6 - 0515Q3 - 0516A4 - 0516A6 - 051660 POLIE DA CAMBOTA (6 pistas) CITROËN XSARA (2.0 HDi-mot. DW10) - XSARA PICASSO d152.8mm d30mm
	W5004 NO. 0515G3 - 051660 - 0516A4 - 0516A6 POLIE DA CAMBOTA (6 pistas) CITROËN XSARA (1.9 TD 90 CV - mot. XUD9) - XSARA (1.9D 68CV - mot. XUD9) d152.8mm d30mm		W5009 NO. 0515Q6 - 0516L9 - 0516A4 - 051660 - 9624596880 - 9637218980 - 9666471189 - 9634848980 POLIE DA CAMBOTA (6 pistas) CITROËN XSARA 1.9D mot. DW8 s-clima (APÓS 1998) d152.8mm d36mm
	W5014 NO. 0515G6 POLIE DA CAMBOTA (6 pistas) CITROËN XSARA d127mm d42mm		W5024 NO. 0515H6 POLIE DA CAMBOTA (6 pistas) CITROËN XSARA 1.8i - 2.0i MOTORES LFY - XU7JP4 - RFV - XU10J4R - NFZ - XU75P d127mm d30mm
	W5033 NO. 0515.K6 POLIE DA CAMBOTA (6 PISTAS) CITROËN XSARA 1.8 16V 2.0 16V d127mm d30mm		W5086 NO. 0515.R8 - 0515.P1 - 0515.N0 - 0515.S1 POLIE DA CAMBOTA (6 PISTAS) CITROËN XSARA APÓS 2001 MOTORES 1.6 (TU5JP4 E ET3J4) d143mm d44mm
	W5091 NO. 0515T3 - 0516A3 - 1690296 - 1487861 - AV6Q6B319AA - Y66211401 - Y40111406A - 11237801979 - 112378... POLIE DA CAMBOTA (6 PISTAS) CITROËN XSARA PICASSO (APÓS 09-2005) 1.6 Hdi d157mm d30mm		W5101 NO. 0515V6-0515T8 POLIE DA CAMBOTA CITROËN XSARA 1.9D - 2.0HDI d152.8mm d30mm
	W5101 NO. 0515V6-0515T8 POLIE DA CAMBOTA CITROËN XSARA PICASSO 1.9D - 2.0HDI d152.8mm d30mm		W5120 NO. 0515P8 - 0515T0 - 0515V0 - 0515V7 - 0515V4 - 0515V8 - 0515R0 - 0515TQ - 0516A3 POLIE DA CAMBOTA (6 PISTAS) CITROËN - XSARA (N1) - 1.4 HDi (01.03 - 03.05) 68cv 1398cc Hatchback - CITROËN - XSARA Break (N2) - 1.4 HDi (01.03 - 08.05) 68cv 1398cc Combi - CITROËN - XSARA Coupé (N0) - 1.4 HDi (01.03 - 03.05) 68cv 1398cc Coupé d150/162mm d29,5mm
	W5146 NO. 0515R1 POLIE DA CAMBOTA 6 PISTAS CITROËN XSARA Break (N2) 2.0 16V N.º mot. a partir de: 0961750 - Código do motor or: EW10J4 - Variante de equipamento o: Mtr 0961750> - N.º mot. até: 0822888 - Variante de equipamento: >Mtr 0822888 (09.00 A 08.05) 136cv 1997cc Combi - CITROËN XSARA Coupé (N0) 2.0 16V N.º mot. a partir de: 0961750 - Código do motor: EW10J4 - Variante de equipamento: Mtr 0961750> - N.º mot. até: 0822888 - Variante de equipamento: >Mtr 0822888 (09.00 ...etc. d148,5mm d30mm		Z80518 NO. 14115980 - 155809966 - 6992G2 Mola de retenção CITROËN XSARA d13x9mm 1p-7x7-8mm 1f-d4.8mm

	Z80678	NO. 856535		Z80678	NO. 856535
	Mola de friso CITROËN XSARA PICASSO			Mola de friso CITROËN XSARA	
d18x20mm		1p-d9-14mm	d18x20mm		1p-d9-14mm
	Z80808	NO. 699786 - 7701044547 - 9619769080			
	Mola de fixação CITROËN XSARA				
NULL		NULL			





CITROËN ZX

	A0008	NO. 1807.47 - 915071180		A0330	NO. 96033565 - 91521643
	APOIO TRASEIRO DO MOTOR CITROËN ZX			SUPORTE CAIXA DE VELOCIDADES ESQUERDO CITROËN ZX DIESEL	
d70x53mm		c40mm 1f-d10mm	100x70x42mm		1f-d12mm
	A1002	NO. 97521102		A1028	NO. 91517554 - 91538407
	APOIO INTERMÉDIO DA SUSPENSÃO DO MOTOR FRENTE CITROËN ZX			SUPORTE FRENTE DIREITO DO MOTOR CITROËN ZX 1.1i - 1.4i - 1.6i - 1.8i	
88x40x31mm		1f-d11mm	d82x79mm		1p-d10-22mm 1p-d10-31mm
	A1028-H	NO. 91517554		A1190	NO. 96038337
	SUPORTE FRENTE DIREITO DO MOTOR (HIDRÁULICO) CITROËN ZX DIESEL 1.9D - 1.9TD			SUPORTE DA CAIXA DE VELOCIDADES CITROËN ZX	
d82x79mm		1p-d10-22mm 1p-d10-31mm	110x85x56mm		1f-d17/11mm
	A1192	NO. 1843.91 - 91517554		A1323	NO. 1844.47 - 1844.77 - 1827.23
	SUPORTE DIREITO DO MOTOR CITROËN ZX 1.6			SUPORTE MOTOR LADO DIREITO CITROËN ZX 2.0i - 2.0i V6	
d61x33mm		1p-d10-54mm 1p-d10-22mm	d92x83mm		1p-d10-28mm 1p-d10-20mm
	A1323-H	NO. 1844.47 - 1844.77 - 1827.23		A1400	NO. 182710 - 184436
	APOIO DE MOTOR DIREITO (HIDRÁULICO) CITROËN ZX 1.9D			SUPORTE MOTOR ESQUERDO CITROËN ZX 1.6i - 1.8i - 1.8i 16V - 2.0i - 2.0i 16V	
d92x80mm		1p-10-25mm 1p-d10-27mm	135x90x58mm		1f-d11mm

	A1401	NO. 1809.21 - 1809.29 - 1809.16 SUPPORTE DO MOTOR TRÁS CITROËN ZX 1.1 - 1.4i - 1.8i 16V - 1.8D - 1.9i - 1.9D - 1.9TD		A1403	NO. 1844.25 SUPPORTE LIMITADOR DO APOIO DIREITO (Complemento do A1323 e A1323H) CITROËN ZX 1.9D - 2.0i - 2.0i 16V
		d70x53mm			c40mm 1f-d10mm
	A1463	NO. 5131.71 SUPPORTE MOTOR DO BRAÇO SUSPENSÃO TRASEIRO CITROËN ZX 1.1 - 1.4i - 1.6i - 1.8i - 1.8i 16V - 1.8d - 1.9D - 1.9TD - 2.0i - 2.0i 16V		A1738	NO. 503824 - 503878 - 96090345 APOIO DO AMORTECEDOR DA FRENTE CITROËN ZX 1.1 - 1.4 - 1.4i - 1.6i - 1.8i - 1.8D - 1.9i - 1.9D - 1.9TD (1991 A 1997) - ZX BREAK (1993 A 1997)
		74x66x36mm			1p-d10-33mm 1p-d10-18mm
	A1750	NO. 503823 - 96090346 APOIO DO AMORTECEDOR DA FRENTE DIREITO E ESQUERDO (VEÍCULO SEM DIRECÇÃO ASSISTIDA) CITROËN ZX 1.1 H1A (03-1991 A 06-1997) - 1.4 (03-1991 A 06-1997) - 1.4 i (03-1991 A 06-1997) - 1.6 i (03-1991 A 06-1997) - 1.8 D (06-1993 A 06-1997) - 1.8 i 16V (07-1992 A 06-1997) - 1.8 i 16V (01-1996 A 06-1997) - 1.9 D (06-1994 A 06-1997) - 1.9 i (03-		A1750	NO. 503823 - 96090346 APOIO DO AMORTECEDOR DA FRENTE DIREITO E ESQUERDO (VEÍCULO SEM DIRECÇÃO ASSISTIDA) CITROËN ZX BREAK 1.4 i (10-1993 A 10-1997) - 1.6 i (10-1993 A 10-1997) - 1.8 D (10-1993 A 10-1997) - 1.8 i (10-1993 A 10-1997) - 1.8 i 16V (01-1996 A 02-1998) - 1.9 D (06-1994 A 10-1997) - 1.9 TD (10-1993 A 10-1997)
		165x147x50mm			1f-d14mm 4f-d8mm
	BB09	NO. 96029014 ABRACADEIRA DA BARRA ESTABILIZADORA CITROËN ZX		BE16	NO. 5433461 - 5483762 - 95483762 ABRACADEIRA DE ESCAPE CÔNCAVA 66mm CITROËN ZX (APÓS 1992)
		107x50x45mm			NULL
	E1006	NO. 175561 - 96125080 - 1755.56 ESTICADOR DE ESCAPE CITROËN ZX KAT. (APÓS 03-1991) - ZX DIESEL (APÓS 09-1991) - ZX DIESEL KAT. (APÓS 1992)		E1008	NO. 175559 - 96037651 ESTICADOR DE ESCAPE CITROËN ZX KAT. (APÓS 03-1991) - ZX DIESEL (APÓS 09-1991) - ZX DIESEL KAT. (APÓS 1992)
		68x45x20mm			NULL
	F0998-I	NO. 95619710 FOLE DO LADO DA CAIXA (JUNTA d76mm) (F1064) CITROËN ZX 1124 cc.		F1286-I	NO. 95618785 - 95653005 FOLE DO LADO DA RODA (JUNTA d90mm EIXO d25mm) CITROËN ZX DIESEL
		d74x80mm			1f-d70mm 1f-d20mm
	F1301-I	NO. 9609802380 - 329724 FOLE DO LADO DA CAIXA CITROËN ZX (1991 A 1997) 1.4i - 1.6i - 1.8i - 1.9i - 1.9TD - 2.0i		F1302-I	NO. 3293.77 FOLE DO LADO DA RODA (JUNTA d86mm EIXO d25mm) CITROËN ZX AVANTAGE 1.1 - 1.6 - 1.4i - 1.8i - 1.9D - 1.9TD
		d90x100mm			1f-d78mm 1f-d25mm
	F1339-I	NO. 91510864 - 95510864 FOLE DA DIRECÇÃO DIREITO (COM DIRECÇÃO ASSISTIDA) CITROËN ZX 1.4i 1.6i - 1.8i - 1.9i - 1.9D - 1.9TD - 2.0i		F1633-I	NO. 328781 - 329781 FOLE DA TRANSMISSÃO JUNTO À CAIXA CITROËN ZX (91 A 97) 1.6i - 1.6 ABS - 1.8 ABS - 1.8 Di ABS - 1.9 ABS - 1.9 Di ABS - 2.0 - 2.0 16V
		d72x128mm			1f-d40mm 1f-d40mm
					d87x104mm
					1f-d80mm 1f-d34mm

	<p>H570-T NO. [blank]</p> <p>PALA ORIGINAL TRÁS</p> <p>CITROËN ZX</p> <p>300x220mm NULL</p>		<p>KF1485 NO. 3293.77</p> <p>KIT FOLE DO LADO DA RODA</p> <p>CITROËN ZX AURA - AVANTAGE - REFLEX 1.1 - 1.4i - 1.6 - 1.8i - 1.9D - 1.9TD</p> <p>d84x85mm 1f-d20mm 1f-d80mm</p>
	<p>KF2416-T NO. 329305</p> <p>KIT DE FOLE DO CARDAN JUNTO À RODA</p> <p>CITROËN ZX 1.4i (1991 A 1997) - CITROËN C15 1.1i - 1.4 - 1.4i - 1.8D (1984 A 1997) - BERLINGO 1.1i - 1.4i - EL (APÓS 1996) - BERLINGO MULTISPACE EL - 1.1i - 1.4i (APÓS 1996) - SAXO 1.6i VTL - VTR - 1.6i VTS (APÓS 1996) - XSARA 1.4i - 1.5D - 1.6i (1997 A 2</p> <p>d95x130mm 1f-d82mm 1f-d23mm</p>		<p>L3037 NO. 91509516</p> <p>CASQUILHO DOS PARAFUSOS DE ESCAPE</p> <p>CITROËN ZX (1991 A 1996)</p> <p>d23x10mm c8mm 1f-d11/16mm</p>
	<p>M6011 NO. 95602682 - 95603555</p> <p>JUNTA DE ESCAPE</p> <p>CITROËN ZX (1991 A 1996)</p> <p>d59.5x13.5mm 1f-d46.2mm</p>		<p>M6012 NO. 91516522 - 91537797 - 96033780 - 96038954 - 91539094</p> <p>JUNTA DE ESCAPE</p> <p>CITROËN ZX (APÓS 1991)</p> <p>d79x14mm 1f-d66mm</p>
	<p>M6039 NO. 96000436</p> <p>JUNTA DE ESCAPE</p> <p>CITROËN ZX (1991 A 1992)</p> <p>100x92mm 1f-d60mm</p>		<p>M6086 NO. 91537799 - 96587799</p> <p>JUNTA DE ESCAPE</p> <p>CITROËN ZX (APÓS 1992)</p> <p>d70x13mm 1f-d58mm</p>
	<p>P1007 NO. 95575913</p> <p>CAPA DE PEDAL DO TRAVÃO E EMBRAIAGEM</p> <p>CITROËN ZX</p> <p>68x45x11mm NULL</p>		<p>R220962 NO. 96050236 - 1343.K1</p> <p>TUBO DE RADIADOR SUPERIOR</p> <p>CITROËN ZX (1.6 - 1.8) 1º TIPO</p> <p>B420-d30/38mm 80-90-95-80-100-70mm</p>
	<p>R220963 NO. 95667385 - 95667383 - 1351.K3</p> <p>TUBO INFERIOR RADIADOR</p> <p>CITROËN ZX 1.6 - 1.8 - 1º TIPO</p> <p>B520-d31/31mm 110-40-75-200-65-180-130mm + B620-d2</p>		<p>R220964 NO. 96125069 - 1343.H7</p> <p>TUBO DE RADIADOR SUPERIOR</p> <p>CITROËN ZX (1.6 - 1.8) 2º TIPO</p> <p>B400-d38/38mm 75-180-240mm</p>
	<p>R220966 NO. 96089334 - 1343.N7</p> <p>TUBO DE RADIADOR INFERIOR</p> <p>CITROËN ZX (1.4)</p> <p>B295-d30/30mm 65-95-90-100mm</p>		<p>R220967 NO. 96089333 - 1343.J2 - 1343.V6</p> <p>TUBO DE RADIADOR SUPERIOR</p> <p>CITROËN ZX (1.1 - 1.4)</p> <p>B190-d28/36mm 75-60-80-100-65mm</p>
	<p>R220968 NO. 1351.G8 - 1351.J4 - 95667384 - 96050221</p> <p>TUBO INFERIOR DO RADIADOR</p> <p>CITROËN ZX 1.1 - 1.4</p> <p>B370-d31/32mm 150-165-55-220-80-80-200-90-55mm</p>		<p>R220970 NO. 1343.L3 - 1343.X3</p> <p>TUBO SUPERIOR DO RADIADOR</p> <p>CITROËN ZX DIESEL</p> <p>B270-d40/30mm 75-90-65-70mm</p>

	R220972 NO. 1343.K2 TUBO SUPERIOR DO RADIADOR CITROËN ZX TD B350-d34/38mm 90-255-85mm		R220973 NO. 95667382 - 1351.K4 - 1351.N1 - 1351.V5 - 1351.W1 - 1351.X9 TUBO INFERIOR RADIADOR CITROËN ZX TD B490-d31/34mm 135-170-65-200-30-120-115mm
	RT08547 NO. 96124230 TUBO DE TRAVÃO FRENTE LH-RH CITROËN ZX TT (03-1991 A 06-1997) 460mm FZ - MC11		RT08548 NO. 480665 - 96124223 TUBO DE TRAVÃO TRÁS LH CITROËN ZX TT (03-1991 A 06-1997) 230mm FB23 - FB23
	RT08626 NO. 480664 TUBO DE TRAVÃO TRÁS RH CITROËN ZX TT (03-1991 A 06-1997) 265mm FB23 - FB23		S1107 NO. 96110483 - 3520.H5 - 96111043 - 5314.30 - 96011483 - 3520.A1 - 3520.H6 - 3521.71 - 3521.E5 - 3521.E6 SILENT-BLOC CENTRAL DO BRAÇO DA SUSPENSÃO CITROËN ZX 1.1 - 1.4i - 1.6i - 1.9D - 1.9TD - 2.0i - 2.0i 16V d44x31mm d33mm 1f-d12mm
	S1125 NO. 3523.62 - 3523.75 - 3523.59 - 96097927 SILENT-BLOC EXTERIOR DO BRAÇO DE SUSPENSÃO CITROËN ZX 1.1 - 1.4i - 1.6i - 1.9D - 1.9TD - 2.0i - 2.0i 16V 103x60x38mm 1f-d19mm		S1304 NO. 95644954 - 4059.07 SILENT-BLOC DO PISTÃO DIRECÇÃO ASSISTIDA CITROËN ZX 1.1 - 1.4i - 1.6i - 1.9D - 1.9TD - 2.0i - 2.0i 16V d22x24mm c20mm 1f-d11.5mm
	S1305 NO. 1809.04 - 91201175 SILENT-BLOC DO TIRANTE TRASEIRO MOTOR CITROËN ZX 1.4 - 1.6 - 1.8 d30x34mm c28mm 1f-d12mm		T0681-I NO. 503326 - 9151964280 BATENTE SUSPENSÃO DA FRENTE CITROËN ZX (N2) 1.6 i (03.91 A 06.97) 88cv 1580cc Hatchback - CITROËN ZX (N2) 1.6 (07.94 A 10.97) 90cv 1580cc Hatchback - CITROËN ZX (N2) 1.8 i (07.92 A 06.97) 101cv 1761cc Hatchback - CITROËN ZX (N2) 1.9 D (03.91 A 06.97) 64cv 1905cc Hatchback - CITROËN ZX (N2) 1.9 D (07.93 A 06.97) 68cv 1905cc Hatchback d55x81mm 1f-d25mm 1f-d16mm
	T1013 NO. 509465 - 5094.77 BATENTE DA BARRA ESTABILIZADORA CITROËN ZX 50x46x43mm 1f-d21mm		T1014 NO. 96051398 BATENTE DA BARRA ESTABILIZADORA CITROËN ZX 1.1 - 1.4i - 1.6i - 1.9D - 1.9TD - 2.0i - 2.0i 16V 50x46x45mm 1f-d22mm
	W5001 NO. 0515K9 POLIE DA CAMBOTA (5 pistas) CITROËN ZX (MOT XUD7) (1993 A 1997) d142mm d30mm		W5004 NO. 0515G3 - 051660 - 0516A4 - 0516A6 POLIE DA CAMBOTA (6 pistas) CITROËN ZX (1.9D 68CV - mot. XUD9) - ZX (1.9 TD 90 CV - mot. XUD9) - ZX (1.9 TD 90 CV - mot. XUD9) d152.8mm d30mm
	W5014 NO. 0515G6 POLIE DA CAMBOTA (6 pistas) CITROËN ZX d127mm d42mm		Y3001 NO. 95608790 - 91521270 - 91521271 - 96118164 PARAFUSO DE ESCAPE CITROËN ZX (1991 A 1996) 65x8mm 1p-d6-15mm

	<p>Z10415 NO. 6547.20</p> <p><i>Mola de painel</i></p> <p>CITROËN ZX</p> <p>d9x15mm 1p-d6-13mm</p>		<p>Z10508 NO. 7701397195</p> <p><i>Mola de fixação</i></p> <p>CITROËN ZX</p> <p>d16.5x16.7mm 1p-d8-18.8mm 1f-d7.5mm</p>
	<p>Z80518 NO. 14115980 - 155809966 - 6992G2</p> <p><i>Mola de retenção</i></p> <p>CITROËN ZX</p> <p>d13x9mm 1p-7x7-8mm 1f-d4.8mm</p>		<p>Z80720 NO. 696640</p> <p><i>Mola de painel</i></p> <p>CITROËN ZX</p> <p>d20x20mm 1p-d8-17.5mm</p>
	<p>Z80755 NO. 96120786</p> <p><i>Mola de painel</i></p> <p>CITROËN ZX</p> <p>d16.6x40mm 1p-d7.5-18mm</p>		<p>Z9008 NO. 96062723 - 96092921</p> <p><i>MOLA DE ESCAPE</i></p> <p>CITROËN ZX (1991 A 1996)</p> <p>d21x34mm NULL</p>