











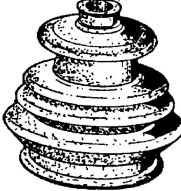

	Z00531	NO. 1470998 - 207217563 - N0154322		Z01561	NO. 211837223
	<i>Mola porca rápida</i> AUDI (TODOS)			<i>Mola porca rápida</i> AUDI (TODOS)	
24.6x16.2x5.5mm		1f-d6.3mm	24x11x4mm		1f-d4.2mm
	Z80470	NO. 164361 - 7703072177		Z80684	NO. 1800940 - 90127883 - 16131176747
	<i>Mola de fixação</i> AUDI (TODOS)			<i>Mola de retenção</i> AUDI (TODOS)	
d5x45mm		NULL	d16x10mm		1f-d6mm
	Z80715	NO. 811807577C			
	<i>Mola de fixação</i> AUDI (TODOS)				
12.5x7.5x12.5mm		1p-7.5x7.5-11.5mm 1f-d4.8mm			

AUDI 200

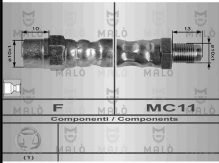
	E0019	NO. 823253147A - 823253149		F1323-I	NO. 3B0498201A - 8A0407283 - 8A0498201
	<i>ESTICADOR DE ESCAPE</i> AUDI 200 (79-86)			<i>FOLE DA TRANSMISSÃO JUNTO À CAIXA</i> AUDI 200 C3 2.1i T QUATTRO (83 A 91)	
60x57x12mm		NULL	d90x85mm		1f-d82mm 1f-d33mm
	M6029	NO. 431253137A - 073253137A - 855253137A - 477253137 - 443253137C - 0063613483 - AA70A13483		M6030	NO. 431253115A - 443253115A
	<i>JUNTA DE ESCAPE</i> AUDI 200 (1979 A 1984)			<i>JUNTA DE ESCAPE</i> AUDI 200 (1980 A 1985)	
d60.3x13.8mm		1f-d46.5mm	170x90mm		2f-d52mm
	M6109	NO. 026129589A - 028129589B - 056129589A		N2331	NO. 861253147 - 823010459 - 893253147F
	<i>JUNTA DE ESCAPE</i> AUDI 200 (10-1979 A 12-1991)			<i>ANEL ESCAPE</i> AUDI 200 (1979 A 1986)	
82x41mm		1f-38/27mm	d58x14mm		1f-d31mm
	Z80459	NO. 823867299		Z80749	NO. 703867299
	<i>Mola de painel</i> AUDI 200			<i>Mola de painel</i> AUDI 200	
d18x21.2mm		1p-d7.6-14.2mm	d18x20.5mm		1p-d8.4-13.5mm

	<p>E0019 NO. 823253147A - 823253149</p> <p>ESTICADOR DE ESCAPE</p> <p>AUDI 50 (74-78)</p> <p>60x57x12mm NULL</p>		<p>F0814-I NO. 171407282B</p> <p>FOLE DO SEMI-EIXO LADO DA CAIXA DE VELOCIDADES</p> <p>AUDI 50</p> <p>d91x90mm 1f-d21mm flange 87mm</p>
	<p>F1057-I NO. 191498201D - 321498201A - 321498201D - 443498201</p> <p>FOLE DA TRANSMISSÃO JUNTO À CAIXA</p> <p>AUDI 50 1.3 (74 A 78)</p> <p>d91x83mm 1f-d82mm 1f-d21mm</p>		<p>F1058-I NO. 171407285A</p> <p>FOLE DO SEMI-EIXO LADO RODA</p> <p>AUDI 50</p> <p>d98x96mm 1f-d69mm 1f-d18mm</p>
	<p>F1084-I NO. 861419831B</p> <p>FOLE DIREÇÃO ESQUERDO</p> <p>AUDI 50 (APÓS 9-1979)</p> <p>d57x110mm 1f-d22mm 1f-d35mm</p>		<p>F1090-I NO. 861419832</p> <p>FOLE DA DIREÇÃO DIREITO</p> <p>AUDI 50 (APÓS 9-1979)</p> <p>d40x127mm 1f-d34mm</p>
	<p>M6072 NO. 036253115 - 036253115A - 191253115B - 191253115H - 861253115A</p> <p>JUNTA DE ESCAPE</p> <p>AUDI 50 (1974 A 1978) - AUDI 80 (1979 A 1981)</p> <p>125x70mm 2f-d40mm</p>		<p>RT08226 NO. 801611707C - 861611707B - 861611707C</p> <p>TUBO DE TRAVÃO FRENTE LH-RH</p> <p>AUDI 50 1.1 - 1.3 (8-1974 A 8-1978)</p> <p>290mm F - MC11</p>

AUDI A1

	<p>F4106 NO. 357413175A</p> <p>FOLE AMORTECEDORES FRENTE</p> <p>AUDI A1 (8X1, 8XK) 1.2 TFSI (A Partir de 05.10) 86cv 1197cc Hatchback - AUDI A1 (8X1, 8XK) 1.4 TFSI (A Partir de 05.10) 122cv 1390cc Hatchback - AUDI A1 (8X1, 8XK) 1.4 TFSI (A Partir de 11.14) 125cv 1395cc Hatchback - AUDI A1 (8X1, 8XK) 1.4 TFSI (A Partir de 11.14) 150cv 1395cc Hatchback - AUDI A1 (8X1, 8XK) 1.4 TFSI (A Partir de 01.11) 185cv 1390cc Hatchback - AUDI A1 (8X1, 8XK) 1.8 TFSI (A Partir de 02.15) 192cv 1798cc Hatchback - A...etc.</p> <p>d80x210mm 1f-d20mm 1f-d73mm</p>		<p>T0629-I NO. 357412303 F - 6U0413175 - 6K0413031B - 6U6412303 - 005443152 - 115450331 - 6UA412303 - 6U0412303 - 7...</p> <p>BATENTE SUSPENSÃO FRENTE</p> <p>AUDI A1 (8X1 - 8XK) 1.2 TFSI /APÓS 05.10) 86cv 1197cc Hatchback - AUDI A1 (8X1 - 8XK) 1.4 TFSI (APÓS 05.10) 122cv 1390cc Hatchback - AUDI A1 (8X1 - 8XK) 1.4 TFSI (APÓS 04.12) 140cv 1395cc Hatchback - AUDI A1 (8X1 - 8XK) 1.4 TFSI (APÓS 01.11) 185cv 1390cc Hatchback - AUDI A1 (8X1 - 8XK) 2.0 TFSI quattro (APÓS 03.12) 256cv 1984cc Hatchback - AUDI A1 (8X1 - 8XK) 1.6 TDI (APÓS 03.11) 90cv 1598cc Hatchback - AUDI A1 (8X1 - 8XK) 1.6 TDI (A...etc.</p> <p>d50x78mm 1f-d18mm 1f-d26mm</p>
	<p>T0632-I NO. 1H0412303 B - 1H0412303B</p> <p>BATENTE SUSPENSÃO FRENTE</p> <p>AUDI A1 (8X1 - 8XK) 1.2 TFSI Chassis: para veículos com chassis standard (APÓS 05.10) 86cv 1197cc Hatchback - AUDI A1 (8X1 - 8XK) 1.2 TFSI Chassis: para veículos com chassis desportivo (APÓS 05.10) 86cv 1197cc Hatchback - AUDI A1 (8X1 - 8XK) 1.2 TFSI Variante de equipamento : Sport S - Line (APÓS 05.10) 86cv 1197cc Hatchback - AUDI A1 (8X1 - 8XK) 1.4 TFSI Chassis: para veículos com chassis desportivo (APÓS 05.10) 122cv 1390cc Hatc...etc.</p> <p>d49x64mm 1f-d18mm 1f-d22mm</p>		<p>T0633-I NO. 6Q0512131 B</p> <p>BATENTE SUSPENSÃO FRENTE</p> <p>AUDI A1 (8X1 - 8XK) 1.2 TFSI (APÓS 05.10) 86cv 1197cc Hatchback - AUDI A1 (8X1 - 8XK) 1.4 TFSI (APÓS 05.10) 122cv 1390cc Hatchback - AUDI A1 (8X1 - 8XK) 1.4 TFSI (APÓS 04.12) 140cv 1395cc Hatchback - AUDI A1 (8X1 - 8XK) 1.4 TFSI (APÓS 01.11) 185cv 1390cc Hatchback - AUDI A1 (8X1 - 8XK) 2.0 TFSI quattro (APÓS 03.12) 256cv 1984 - Hatchback AUDI A1 (8X1 - 8XK) 1.6 TDI (APÓS 03.11) 90cv 1598cc Hatchback - AUDI A1 (8X1 - 8XK) 1.6 TDI (APÓ...etc.</p> <p>d58x126mm 1f-d17mm 1f-d17mm</p>
	<p>W5122 NO. 038105243M - 038105243L</p> <p>POLIE DA CAMBOTA (6 PISTAS)</p> <p>AUDI - A1 (8X1 - 8XF) - 1.6 TDI (APÓS 03.11) 90cv 1598cc Hatchback - AUDI - A1 (8X1 - 8XF) 1.6 TDI (APÓS 05.10) 105cv 1598cc Hatchback - AUDI - A1 (8X1 - 8XF) - 2.0 TDI (APÓS 09.11) 143cv 1968cc Hatchback - AUDI - A1 Sportback (8XA - 8XK) - 1.6 TDI (APÓS 11.</p> <p>d143mm d29,5mm</p>		

	<p>E0092 NO. 6Q0411315C - 6Q0411315F - 6Q0411315A - 6Q0411315B - 6Q0411315D - 6Q0411315E</p> <p>ESTICADOR DA BARRA ESTABILIZADORA DA FRENTE</p> <p>AUDI A2 1.4 16V (Mtr.-Eng AUA - BBY 55KW) - A2 1.4 TDI (Mtr.-Eng. AMF 55KW) - A2 1.6 FSI (Mts.-Eng BAD) APOS 2000</p>		<p>F1725-I NO. 6N0422831</p> <p>FOLE DA DIREÇÃO ASSISTIDA DIREITO E ESQUERDO</p> <p>AUDI A2</p>
	<p>F1824-I NO. 1J0498201B - 1J0498201D</p> <p>FOLE DA TRANSMISSÃO JUNTO À CAIXA</p> <p>AUDI A2 1.4 TDI PD R3 (APÓS 2000) - AUDI A3 1.6i - 1.8i T 20V - 1.8i T 20V QUATTRO - 1.8i T S3 QUATTRO - 1.9 TDI (1996 A 2003) - AUDI TT 1.8i T 20V (APÓS 1998)</p>		<p>F1841-I NO. 6E0498201 - 6Q0498201C</p> <p>FOLE DA TRANSMISSÃO JUNTO À CAIXA</p> <p>AUDI A2 1.2 TDI PD (APÓS 2000)</p>
	<p>KF1172-T NO. 1H0407283A - 1H0407285A - 1H0407285B - 1H0498203 - 1H0498203A - 1H0498285A - 6Q0498203A</p> <p>KIT DE FOLE DO CARDAN JUNTO À RODA</p> <p>AUDI A2 1.4 TDI PD R3 - 1.6i FSI (APÓS 2000) - AUDI A3 1.6i - 1.6i FSI - 1.8i 20V - 1.8i T 20V - 1.8i T 20V QUATTRO - 1.9 TDI - 1.9 TDI PD - 2.0 TDI PD QUATTRO - 2.0i FSI - 3.2i VR6 QUATTRO (1996 A 2003) - AUDI TT 1.8i T 20V (APÓS 1998)</p>		<p>KF1791-T NO. 6Q0498203</p> <p>KIT DE FOLE DO CARDAN JUNTO À RODA</p> <p>AUDI A2 1.4i (APÓS 2000)</p>
	<p>Q2008 NO.</p> <p>UNIÃO DE ESCAPE 41/38x90mm</p> <p>AUDI - A2 (8Z0) - 1.2 TDI (03.01 - 08.05) 61cv 1191cc HATCHBACK</p>		<p>Q2009 NO.</p> <p>UNIÃO DE ESCAPE 48/45x80mm</p> <p>AUDI - A2 (8Z0) - 1.4 (02.00 - 08.05) 75cv 1390cc Hatchback</p>
	<p>RT80172 NO. 8Z0611707C - 8Z0611707</p> <p>TUBO DE TRAVÃO FRENTE LH-RH</p> <p>AUDI A2 1.2 TDI (03-2001 A 8-2005) - A2 1.4 (02-2000 A 08-2005) - A2 1.4 TDI (02-2000 A 08-2005) - A2 1.6 FSI (05-2002 A 08-2005) - A2 1.2 TDI (03-2001 A 08-2005) - A2 1.4 (02-2000 A 08-2005) - A2 1.4 TDI (02-2000 A 08-2005) - A2 1.6 FSI (05-2002 A 08-2005)</p>		<p>RT80173 NO. 8Z0611775B</p> <p>TUBO DE TRAVÃO TRÁS LH-RH</p> <p>AUDI A2 1.2 Tdi (03-2001 A 08-2005) - A2 1.4 (02-2000 A 08-2005) - A2 1.4 Tdi (02-2000 A 08-2005) - A2 1.6 Fsi (05-2002 A 08-2005)</p>
	<p>S1501 NO. 6LL407183 - 8Z0407183A</p> <p>SILENT BLOCO SUSPENSÃO FRENTE BILATERAL</p> <p>AUDI A2 (8Z0) 1.2 Tdi (ANY) 61CV (03-2001 A 08-2005) - 1.4(AUA - BBY) 75CV (02-2000 A 08-2005) - 1.4 Tdi (AMF - BHC) 75CV (02-2000 A 08-2005) - 1.4 Tdi (ATL) 90CV (11-2003 A 08-2005) - 1.6 Fsi (BAD) 110CV (05-2002 A 08-2005)</p>		<p>S1503 NO. 8Z0407182B - 8Z0407182C - 8Z0407195D</p> <p>SILENT BLOCO DO BRAÇO DA SUSPENSÃO DA FRENTE PARTE INFERIOR</p> <p>AUDI A2(8Z0) 1.2 TDI ANY 45 61CV (03-2001 A 08-2005) - 1.4 AUA - BBY 55 75CV (02-2000 A 08-2005) - 1.4 TDI AMF - BHC 55 75CV (02-2000 A 08-2005) - 1.4 TDI ATL 66 90CV (11-2003 A 08-2005) - 1.6 FSI BAD 81 110CV (05-2002 A 08-2005)</p>
	<p>W5124 NO. 045105243C - 045105243 - 045105243D</p> <p>POLIE DA CAMBOTA (6 PISTAS)</p> <p>AUDI - A2 (8Z0) - 1.4 TDI (02.00 - 08.05) 75cv 1422cc Hatchback - AUDI - A2 (8Z0) - 1.4 TDI (11.03 - 08.05) 90cv 1422cc Hatchback</p>		<p>Z29990 NO. 4B0867276A</p> <p>Mola de friso</p> <p>AUDI A2</p>
	<p>Z80692 NO. N90821401</p> <p>Mola de fixação</p> <p>AUDI A2</p>		<p>Z80791 NO. 8Z0868243</p> <p>Mola de painel</p> <p>AUDI A2</p>

	<p>A1548 NO. 1J0199555AK - 1J0199555AJ</p> <p>APOIO MOTOR FRENTE LADO CAIXA</p> <p>AUDI A3 1.6(APÓS 96) - 1.8 20V - 1.9 TDI 20CV - 110CV(APÓS 96)</p> <p>172x150x105mm NULL</p>		<p>A1549 NO. 1J0199262BE - 1J0199262BF</p> <p>APOIO DO MOTOR FRENTE DIREITO</p> <p>AUDI A3 1.6 - 1.8 20V - 1.8 20VT - 1.9TDI(APÓS 96)</p> <p>170x140x120mm NULL</p>
	<p>A1921 NO. 1K0253059BT - 1K0253059DF - 1K0253059HB - 1K0253144AE - 1K0254500Q</p> <p>APOIO DO ESCAPE</p> <p>AUDI A3 (8P1) 1.6 N.º peças nec.: 2 - N.º chas. até: 8P-7-034 719 (05.03 A 08.12) 102cv 1595cc Hatchback - AUDI A3 (8P1) 2.0 FSI N.º peças nec.: 1 - N.º chas. até: 8P-7-034 719 (05.03 A 06.08) 150cv 1984cc Hatchback - AUDI A3 (8P1) 2.0 TFSI N.º peças nec.: 1 - Código do motor: BWA - N.º chas. até: 8P-7-034 719 (09.04 A 08.12) 200cv 1984cc Hatchback - AUDI A3 (8P1) 2.0 TFSI quattro N.º peças nec.: 1 - Código do motor: BWA - N.º...etc.</p> <p>280x50x40mm 2f-d9mm 2f-d12mm</p>		<p>A1954 NO. 1J0253144A</p> <p>APOIO DO ESCAPE</p> <p>AUDI A3 (8L1) 1.6 Local de montagem: com painel de escape central (08.00 A 05.03) 102cv 1595cc Hatchback - AUDI A3 (8L1) 1.8 Local de montagem: com painel de escape central (09.96 A 05.03) 125cv 1781cc Hatchback - AUDI A3 (8L1) 1.8 T Local de montagem: com painel de escape central (12.96 A 05.03) 150cv 1781cc Hatchback - AUDI A3 (8L1) 1.9 TDI Local de montagem: com painel de escape central (09.96 A 07.01) 90cv 1896cc Hatchback - AUDI...etc.</p> <p>160x115x90mm 2f-15x10mm 2f-d5mm 1f-d12mm</p>
	<p>E0093 NO. 1J0411315G - 1J0411315C - 1J0411315H</p> <p>ESTICADOR DA BARRA ESTABILIZADORA DA FRENTE</p> <p>AUDI A3 TT APÓS 1996</p> <p>140x35x35mm 1p-d10-25mm 1f-d10mm</p>		<p>E0094 NO. 1J0411315C - 1J0411315G - 1J0411315H</p> <p>ESTICADOR DA BARRA ESTABILIZADORA DA FRENTE</p> <p>AUDI A3 TT APÓS 1996</p> <p>145x37x37mm 1p-d10-25mm 1f-d10mm</p>
	<p>E0095 NO. 1J0411316D</p> <p>ESTICADOR DA BARRA ESTABILIZADORA DA FRENTE LADO DIREITO</p> <p>AUDI A3 TT APÓS 1996</p> <p>370x40x40mm 2p-d12d35mm</p>		<p>E0096 NO. 1J0411315D</p> <p>ESTICADOR DA BARRA ESTABILIZADORA DA FRENTE LADO ESQUERDO</p> <p>AUDI A3 TT (QUATTRO) APÓS 1996</p> <p>370x40x40mm 1p-d12-35mm</p>
	<p>E0168 NO. 1K0505465K - 1K0505465C - 1K0505465J</p> <p>ESTICADOR DA BARRA ESTABILIZADORA DE TRÁS</p> <p>AUDI A3 (MOD. 2003) TT</p> <p>130x33x35mm 1p-d10-35mm 1f-d10mm</p>		<p>E0169 NO. 1K0411315D - 1K0411315B - 1K0411315J - 1K0411315G - 1K0411315K - 1K0411315N - 1K0411315P - 1K0411315L...</p> <p>ESTICADOR DA BARRA ESTABILIZADORA DA FRENTE</p> <p>AUDI A3 (MOD. 2003) TT</p> <p>365x35x35mm 2p-d12-26mm</p>
	<p>E0208-M NO. 1J0199851AA - 1J0199851M</p> <p>ESTICADOR DO MOTOR PARTE TRÁS</p> <p>AUDI A3 1.6 - 1.8 20V(APÓS 96)</p> <p>360x145x60mm NULL</p>		<p>E1064 NO. 1J0253144</p> <p>ESTICADOR DE ESCAPE</p> <p>AUDI A3 (APÓS 1998)</p> <p>112x70x50mm NULL</p>
	<p>E1091 NO. 6X0253144B - 1J0253144L - 1J0253144K</p> <p>ESTICADOR DE ESCAPE</p> <p>AUDI A3 QUATTRO (APÓS 08-1998) - TT QUATTRO (APÓS 10-1998)</p> <p>148x70x50mm NULL</p>		<p>F0799B-I NO. 1J0498201E - 3D0598201 - 7M0407283 - 7M0498201 - 7M0498201A - 7M0498202 - 8E0498201A - 8N0498201A - ...</p> <p>FOLE DA TRANSMISSÃO JUNTO À CAIXA</p> <p>AUDI A3 1.8i T 20V - 1.8i T 20V QUATTRO - 1.8i T S3 QUATTRO - 1.9 TDi PD QUATTRO (1996 A 2003)</p> <p>d80x100mm 1f-d58mm 1f-d23mm</p>
	<p>F1790-I NO. 1J0422831 - 1J0422831B - 8N0422831</p> <p>FOLE DA DIRECÇÃO ASSISTIDA DIREITO E ESQUERDO</p> <p>AUDI A3 (APÓS 1996) 1.6 - 1.8 20V - 1.8 20 VT - 1.9 TDI</p> <p>d60x185mm 1f-d48mm 1f-d18mm</p>		<p>F1825-I NO. 1J0498201G - 7M3498201 - 7M3498201A - 8E0498201B</p> <p>FOLE DA TRANSMISSÃO JUNTO À CAIXA</p> <p>AUDI A3 1.8i T 20V - 1.9 TDi PD (1996 A 2003) - AUDI A4 B6 1.8i T 20V - 1.8i T 20V QUATTRO - 1.8i T R4 20V - 1.9 TDi PD - 1.9 TDi PD QUATTRO - 2.0i 20V - 2.0i FSI - 2.4i 30V - 2.5 TDi V6 (APÓS 2000) - AUDI A6 C5 2.4i 30V - 2.4i V6 30V - 2.5 TDi V6 - 4.2i</p> <p>d95x120mm 1f-d80mm 1f-d23mm</p>

	<p>F4050 NO. 1K0423831A</p> <p>FOLE DA DIRECÇÃO LADO ESQUERDO E DIREITO</p> <p>AUDI A3 S3 QUATTRO (APÓS 03-1999)</p> <p>d60x190mm 1f-d48mm 1f-d16mm</p>		<p>F4106 NO. 357413175A</p> <p>FOLE AMORTECEDORES FRENTE</p> <p>AUDI A3 (8L1) 1.6 (09.96 A 05.03) 101cv 1595cc Hatchback - AUDI A3 (8L1) 1.6 (08.00 A 05.03) 102cv 1595cc Hatchback - AUDI A3 (8L1) 1.8 (09.96 A 05.03) 125cv 1781cc Hatchback - AUDI A3 (8L1) 1.8 T (12.96 A 05.03) 150cv 1781cc Hatchback - AUDI A3 (8L1) 1.8 T quattro (12.96 A 05.03) 150cv 1781cc Hatchback - AUDI A3 (8L1) 1.8 T (12.98 A 05.03) 180cv 1781cc Hatchback - AUDI A3 (8L1) 1.8 T quattro (10.98 A 05.03) 180cv 1781cc Hatchback - ...etc.</p> <p>d80x210mm 1f-d20mm 1f-d73mm</p>
	<p>F9048H-I NO. 5M0498203SK - 5M0498203</p> <p>FOLE DO CARDAN LADO DA RODA</p> <p>AUDI A3 (8P1)1.2 TSI Hatchback 1197cc 105CV (04-2010 A 08-2012) - 1.4 TFSI Hatchback 1390cc 125CV (09-2007 A 08-2012) - 1.8 TFSI Hatchback 1798cc 160CV (11-2006 A 08-2012) - 1.6 TDI Hatchback 1598cc 90CV (05-2009 A 08-2012) - 1.6 TDI Hatchback 1598cc 105</p> <p>d98x116mm 1f-d26mm 1f-d95mm</p>		<p>KF1182-T NO. 1J0498203A - 3B0498203B - 6Q0498203B - 8N0498203</p> <p>KIT DE FOLE DO CARDAN JUNTO À RODA</p> <p>AUDI A3 (1996 A 2003) 1.8i T 20V - 1.8i T 20V Quattro - 1.8i T S3 Quattro - 1.9 TDI PD - 1.9 TDI PD Quattro - AUDI TT (APOS 1998) 1.8i T 20V - 1.8i T 20V Quattro - 3.2i VR6 Quattro</p> <p>d113x121mm 1f-d99mm 1f-d29mm</p>
	<p>KF2965-T NO. 1K0498203A - 1J0407285A - 8N0498203 - 8N0498203A</p> <p>KIT DE FOLE DO CARDAN JUNTO À RODA</p> <p>AUDI A3 (APÓS 2003) 2.0TDI PD - 2.0TDi PD QUATRO - 2.0i T FSI - 3.2i VR6 QUATRO</p> <p>d110x120mm 1f-d97mm 1f-d29mm</p>		<p>KL2763 NO. 028103638G - 028103665 - 028103937</p> <p>KIT CASQUILHOS REPARAÇÃO CAIXA FILTRO OLEO</p> <p>AUDI A3 (8L1) 1.6 (09.96 A 05.03) 101cv 1595cc Hatchback - AUDI A3 (8L1) 1.6 (08.00 A 05.03) 102cv 1595cc Hatchback - AUDI A3 (8L1) 1.8 (09.96 A 05.03) 125cv 1781cc Hatchback - AUDI A3 (8L1) 1.8 T (12.96 A 05.03) 150cv 1781cc Hatchback - AUDI A3 (8L1) 1.8 T quattro (12.96 A 05.03) 150cv 1781cc Hatchback - AUDI A3 (8L1) 1.8 T (12.98 A 05.03) 180cv 1781cc Hatchback - AUDI A3 (8L1) 1.8 T quattro (10.98 A 05.03) 180cv 1781cc Hatchback - ...etc.</p> <p>d28x19mm 1f-d9mm</p>
	<p>KT0508 NO. 1H0412303B</p> <p>KIT BATENTE AMORTECEDORES FRENTE</p> <p>AUDI A3 (8L1) 1.6 (08.00 A 05.03) 102cv 1595cc Hatchback - AUDI A3 (8L1) 1.8 T quattro (12.96 A 05.03) 150cv 1781cc Hatchback - AUDI A3 (8L1) 1.8 T (12.98 A 05.03) 180cv 1781cc Hatchback - AUDI A3 (8L1) 1.8 T quattro (10.98 A 05.03) 180cv 1781cc Hatchback - AUDI A3 (8L1) 1.9 TDI quattro (08.00 A 05.03) 130cv 1896cc Hatchback</p> <p>d80x210mm / d50x53mm 1f-d20mm 1f-d73mm / 1f-d18mm 1f-d23mm</p>		<p>M6077 NO. 1H0253115A</p> <p>JUNTA DE ESCAPE</p> <p>AUDI A3 TDI (APÓS 1996) - A4 TDI (APÓS 1995) - A6 TDI (APÓS 1994) - CABRIO TDI (APÓS 1995)</p> <p>107x90mm 4f-d9mm</p>
	<p>M6109 NO. 026129589A - 028129589B - 056129589A</p> <p>JUNTA DE ESCAPE</p> <p>AUDI A3 (09-1976 A 07-2001)</p> <p>82x41mm 1f-38/27mm</p>		<p>Q2003 NO. 3572531411 - 357253141 - 443253141D</p> <p>UNIÃO DE ESCAPE 56/60x125mm</p> <p>AUDI A3 (APÓS 1996) - A4 (APÓS 1994)</p> <p>125x90x67mm 1f-d57mm</p>
	<p>Q2009 NO.</p> <p>UNIÃO DE ESCAPE 48/45x80mm</p> <p>AUDI - A3 (8L1) - 1.6 (09.96 - 05.03)101cv 1595cc Hatchback - AUDI - A3 (8L1) - 1.6 (08.00 - 05.03) 102cv 1595cc Hatchback</p> <p>80x77x55mm 1f-d45/48mm</p>		<p>R221153 NO. 1J0145828T</p> <p>TUBO DE LIGAÇÃO DO AR AO TURBO</p> <p>AUDI A3 (8L1) 1.9 TDI (09.96 - 07.01) 90cv 1896cc Hatchback - AUDI A3 (8L1) 1.9 TDI (10.00 - 05.03) 100cv 1896cc Hatchback - AUDI A3 (8L1) 1.9 TDI (08.97 - 07.01) 110cv 1896cc Hatchback</p> <p>B220-35/36mm 60-130-60mm</p>
	<p>R221870 NO. 1K0145832B</p> <p>TUBO DE LIGAÇÃO DO AR AO TURBO</p> <p>AUDI A3 (8P1) 2.0 TFSI (09.04 - 08.12) 200cv 1984cc Hatchback - AUDI A3 (8P1) 2.0 TFSI quattro (09.04 - 08.12) 200cv 1984cc Hatchback - AUDI A3 (8P1) 1.9 TDI (05.03 - 05.10) 105cv 1896cc Hatchback - AUDI A3 Sportback (8PA) 2.0 TFSI (09.04 - 03.13) 200cv 1</p> <p>B280-50/53mm 150-90-100mm</p>		<p>R221906 NO.</p> <p>TUBO DE ADMISSÃO DO FILTRO DE AR</p> <p>AUDI A3 (8L1) 1.9 TDI (09.96 - 07.01) 90cv 1896cc Hatchback - AUDI A4 (8D2 - B5) 1.9 TDI (03.00 - 11.00) 116cv 1896cc três volumes - AUDI A4 (8D2 - B5) 1.9 TDI quattro (03.00 - 11.00) 116cv 1896cc três volumes - AUDI A4 Avant (8D5 - B5) 1.9 TDI (03.00 - 09.0)</p> <p>B210-32/34mm 80-140-40mm</p>
	<p>R221907 NO. 1J0145838B</p> <p>TUBO DE ADMISSÃO DO FILTRO DE AR</p> <p>AUDI A3 (8L1) 1.9 TDI (09.96 - 07.01) 90cv 1896cc Hatchback - AUDI A3 (8L1) 1.9 TDI (10.00 - 05.03) 100cv 1896cc Hatchback - AUDI A3 (8L1) 1.9 TDI (08.97 - 07.01) 110cv 1896cc Hatchback</p> <p>B190-48/48mm 100-50-120mm</p>		<p>R221914 NO.</p> <p>TUBO DE LIGAÇÃO DO AR AO TURBO</p> <p>AUDI A3 (8P1) 1.9 TDI (05.03 - 05.10) 105cv 1896cc Hatchback - AUDI A3 (8P1) 2.0 TDI (05.03 - 08.12) 136cv 1968cc Hatchback - AUDI A3 (8P1) 2.0 TDI (06.05 - 06.08) 140cv 1968cc Hatchback - AUDI A3 (8P1) 2.0 TDI (06.06 - 06.08) 163cv 1968cc Hatchback - AUD</p> <p>B280-50/53mm 240-120mm</p>

	<p>R221921 NO. 1K0145828S</p> <p>TUBO ADMISSÃO FILTRO DE AR</p> <p>AUDI A3 Cabriolet (8P7) 1.8 TFSI (04.08 A 05.13) 160cv 1798cc Cabriolet</p>		<p>RT08616 NO. 1J0611701 - 1J0611701L - 1J0611704L - 1J0611701N</p> <p>TUBO DE TRAVÃO FRENTE LH-RH</p> <p>AUDI A3 TT (APÓS 09-1996)</p>
	<p>RT08903 NO. 1J0611775 - 6X0611775 - 6Q0611775A - 6Q0611775B - 6X0611775A - 6X0611775B</p> <p>TUBO DE TRAVÃO TRÁS LH-RH</p> <p>AUDI A3 TT (APÓS 09-1996)</p>		<p>RT80160 NO. 1K0611701B - 1K0611701 - 1K0611701H - 1K0611701K - 1K0611701M</p> <p>TUBO DE TRAVÃO FRENTE LH-RH</p> <p>AUDI A3 (MOD 2003) TT (APÓS 05-2003)</p>
	<p>RT80161 NO. 1K0611775C - 1K0611775 - 1K0611775A - 1K0611775B - 1T0611775A - 3C0611775C</p> <p>TUBO DE TRAVÃO TRÁS LH-RH</p> <p>AUDI A3 (MOD 2003) TT (APÓS 05-2003)</p>		<p>RT80275 NO. 8N0611707A</p> <p>TUBO DE TRAVÃO FRENTE LH-RH</p> <p>AUDI A3 (APÓS 2003) 1.6i - 1.6i FSi - 1.9 TDi PD - 2.0 TDi PD - 2.0 TDi PD QUATTRO - 2.0i FSi - 2.0i T FSi - 3.2i VR6 QUATTRO</p>
	<p>RT80623 NO. 1J0611764K</p> <p>TUBO DE TRAVÃO TRÁS RH</p> <p>AUDI A3 (8L1) 1.6 (APÓS 08-2000) - 1.8 (APÓS 09-1996) - 1.8 QUATTRO (APÓS 08-1998) - 1.8 T (APÓS 12-1998) - 1.8 T QUATTRO (APÓS 10-1998) - 1.9 TDi (APÓS 10-2000) - 1.9 TDi QUATTRO (APÓS 08-2000)</p>		<p>S1361 NO. 1J0199429</p> <p>SILENT-BLOC DO SEMI-EIXO DA FRENTE</p> <p>AUDI A3 1.6 - 1.8 20V - 1.8 20VT - 1.9 TDi</p>
	<p>S1362 NO. 1J0501541C</p> <p>SILENT-BLOC DA SUSPENSÃO DE TRÁS</p> <p>AUDI A3 1.6 - 1.8 20V T APÓS 12-96 - 1.8 20V - 1.9 TDi APÓS 9-96</p>		<p>S1377 NO. 1J0407181</p> <p>SILENT-BLOC DO BRAÇO DA SUSPENSÃO DA FRENTE PARTE DE TRÁS</p> <p>AUDI A3 APÓS 09-96 1.6 - 1.8 20V - 1.8 20VT - 1.9 TDi</p>
	<p>S1526 NO. 1K0199231G - 1K0199231J - 1K0199231H - 1K0199231K - 1K0199297G</p> <p>SILENT BLOCO DO BRAÇO DA SUSPENSÃO DA FRENTE LADO ESQUERDO</p> <p>AUDI A3 (8P1) 1.6 (BGU - BSE - BSF - CCSA - CMXA) 102CV (05-2003 A 08-2012) - 1.6 FSi (BAG - BLF - BLP) 115CV (08-2003 A 09-2007) - 1.9 TDi (BKC - BLS - BXE) 105CV (05-2003 A 05-2010) - 2.0 FSi (AXW - BLR - BLX - BLY - BMB - BVY - BVZ) 150CV (05-2003 A 06-2008) - 2.0 TDi</p>		<p>S1527 NO. 1K0199232G - 1K0199232J - 1K0199232H - 1K0199298G</p> <p>SILENT BLOC DO BRAÇO DE SUSPENSÃO DA FRENTE LADO DIREITO</p> <p>AUDI A3 (8P1) 1.6 (BGU - BSE - BSF - CCSA - CMXA) 102CV (05-2003 A 08-2012) - 1.6 FSi (BAG - BLF - BLP) 115CV (08-2003 A 09-2007) - 1.9 TDi (BKC - BLS - BXE) 105CV (05-2003 A 05-2010) - 2.0 FSi (AXW - BLR - BLX - BLY - BMB - BVY - BVZ) 150CV (05-2003 A 06-2008) - 2.0 TDi</p>
	<p>T0632-I NO. 1H0412303 B</p> <p>BATENTE SUSPENSÃO FRENTE</p> <p>AUDI A3 (8L1) 1.6 (09.96 A 05.03) 101cv 1595cc Hatchback - AUDI A3 (8L1) 1.6 (08.00 A 05.03) 102cv 1595cc Hatchback - AUDI A3 (8L1) 1.8 (09.96 A 05.03) 125cv 1781cc Hatchback 2/2 - AUDI A3 (8L1) 1.8 T (12.96 A 05.03) 150cv 1781cc Hatchback - AUDI A3 (8L1) 1.8 T quattro Chassis: para veículos sem chassis desportivo (12.96 A 05.03) 150cv 1781cc Hatchback - AUDI A3 (8L1) 1.8 T (12.98 A 05.03) 180cv 1781cc Hatchback - AUDI A3 (8L1) 1.8 T quat...etc.</p>		<p>T0637-I NO. 1K0412303 B</p> <p>BATENTE SUSPENSÃO FRENTE</p> <p>AUDI A3 (8P1) 1.6 para fabricante e: Avus Motorsport - Chassis: para veículos com chassis desportivo - para número PR: G35 - N.º chas. at é: 8P- 6A110320 - N.º chas. at é: 8P-6B011800 (05.03 A 08.12) 102cv 1595cc Hatchback - AUDI A3 (8P1) 1.6 FSi para fabricante e: Avus Motorsport - Chassis: para veículos com chassis desportivo - N.º chas. at é: 8P-6A110320 - para número PR: G35 - N.º chas. at é: 8P-6B011800 (08.03 A 09.07) 115cv 1598...etc.</p>
	<p>T0638-I NO. 1J0412303</p> <p>BATENTE SUSPENSÃO DA FRENTE</p> <p>AUDI A3 (8L1) 1.6 (09.96 A 05.03) 101cv 1595cc Hatchback - AUDI A3 (8L1) 1.6 (08.00 A 05.03) 102cv 1595cc Hatchback - AUDI A3 (8L1) 1.8 (09.96 A 05.03) 125cv 1781cc Hatchback - AUDI A3 (8L1) 1.8 T (12.96 A 05.03) 150cv 1781cc Hatchback - AUDI A3 (8L1) 1.8 T (12.98 A 05.03) 180cv 1781cc Hatchback - AUDI A3 (8L1) S3 quattro (03.99 A 04.02) 210cv 1781cc Hatchback - AUDI A3 (8L1) S3 quattro (10.01 A 05.03) 224cv 1781cc Hatchback - AUDI A3 (8L1)...etc.</p>		<p>T0701-I NO. 1J0512131C</p> <p>BATENTE SUSPENSÃO DA FRENTE</p> <p>AUDI A3 (8L1) 1.6 (09.96 A 05.03) 101cv 1595cc Hatchback - AUDI A3 (8L1) 1.6 (08.00 A 05.03) 102cv 1595cc Hatchback - AUDI A3 (8L1) 1.8 (09.96 A 05.03) 125cv 1781cc Hatchback - AUDI A3 (8L1) 1.8 T (12.96 A 05.03) 150cv 1781cc Hatchback - AUDI A3 (8L1) 1.8 T quattro (12.96 A 05.03) 150cv 1781cc Hatchback - AUDI A3 (8L1) 1.8 T (12.98 A 05.03) 180cv 1781cc Hatchback - AUDI A3 (8L1) 1.8 T quattro (10.98 A 05.03) 180cv 1781cc Hatchback - AUDI A3...etc.</p>

	<p>T1094 NO. 1J0411314C</p> <p>BATENTE DA BARRA ESTABILIZADORA DA FRENTE</p> <p>AUDI A3(8L1) 1.6 - 1.8 - 1.8T - 1.8 T QUATTRO - 1.9 Tdi - 1.9 Tdi QUATTRO APOS 09-96</p> <p>37x36x25mm 1f-d20mm</p>		<p>T1148 NO. 1J0411314M - 1J0411314N - 1J0411314RS1 - 1J0411314SS1 - 1J0411314B - 1J0411314R - 8N041134B</p> <p>BATENTE DA BARRA ESTABILIZADORA DA FRENTE</p> <p>AUDI A3 (8L1) 1.6 Hatchback (09-1996 a 05-2003) 101CV 1595CC - AUDI A3 (8L1) 1.6 Hatchback (08-2000 A 05-2003) 102CV 1595CC - AUDI A3 (8L1) 1.8 Hatchback (09-1996 A 05-2003) 125CV 1781CC - AUDI A3 (8L1) 1.8 T Hatchback (12-1996 A 05-2003) 150CV 1781CC - A</p> <p>38x37x26mm 36x25x20mm</p>
	<p>UFV2001 NO. 38103663</p> <p>FUNIL VARETA NIVEL ÓLEO</p> <p>AUDI A3 (8L1) 1.9 TDI (09.96 A 07.01) 90cv 1896cc Hatchback - AUDI A3 (8L1) 1.9 TDI (10.00 A 05.03) 100cv 1896cc Hatchback - AUDI A3 (8L1) 1.9 TDI (08.97 A 07.01) 110cv 1896cc Hatchback - AUDI A3 (8L1) 1.9 TDI (08.00 A 05.03) 130cv 1896cc Hatchback - AUDI A3 (8L1) 1.9 TDI quattro (08.00 A 05.03) 130cv 1896cc Hatchback</p> <p>260x25mm 1f-d18mm 1f-d20mm</p>		<p>UFV2002 NO. 06A103663C</p> <p>FUNIL VARETA NIVEL ÓLEO</p> <p>AUDI A3 (8L1) 1.6 Código do mot or: AVU (08.00 A 05.03) 102cv 1595cc Hatchback - AUDI A3 (8L1) 1.8 (09.96 A 05.03) 125cv 1781cc Hatchback</p> <p>240x25mm 1f-d18mm 1f-d20mm</p>
	<p>UFV2003 NO. 06A103663B</p> <p>FUNIL VARETA NIVEL ÓLEO</p> <p>AUDI A3 (8L1) 1.6 (09.96 A 05.03) 101cv 1595cc Hatchback - AUDI A3 (8L1) 1.8 Ano fabric.: 01.97, N.º chas. at é: 8L-V-150 000 (09.96 A 05.03) 125cv 1781cc Hatchback - AUDI A3 (8L1) 1.8 T (12.96 A 05.03) 150cv 1781cc Hatchback - AUDI A3 (8L1) 1.8 T quattro Código do mot or: AGU, Código do mot or: AQA (12.96 A 05.03) 150cv 1781cc Hatchback - AUDI A3 (8L1) 1.8 T Código do mot or: AJQ, Código do mot or: APP, Código do mot or: AUQ (12.9...etc.</p> <p>240x25mm 1f-d18mm 1f-d20mm</p>		<p>UMV25733 NO. 8L0863278BN</p> <p>MANETE ALAVANCA VELOCIDADES</p> <p>AUDI A3 (8L)</p> <p>120x51x27mm 1pino-d14mm</p>
	<p>UMV25733 NO. 8L0863278BN</p> <p>MANETE ALAVANCA VELOCIDADES</p> <p>AUDI A3 (S3)</p> <p>120x51x27mm 1pino-d14mm</p>		<p>UMV25733 NO. 8L0863278BN</p> <p>MANETE ALAVANCA VELOCIDADES</p> <p>AUDI A3 QUATTRO</p> <p>120x51x27mm 1pino-d14mm</p>
	<p>UMV25733 NO. 8L0863278BN</p> <p>MANETE ALAVANCA VELOCIDADES</p> <p>AUDI A3 SPORTBACK</p> <p>120x51x27mm 1pino-d14mm</p>		<p>W5005 NO. 38105243</p> <p>POLIE DA CAMBOTA (6 pistas)</p> <p>AUDI A3 - S3 (1996 A 2003) - 1.9 TDI 115 CV - 130CV</p> <p>d138.8mm d30mm</p>
	<p>W5006 NO. 06A105243E - 06B105243F - 06A105255K</p> <p>POLIE DA CAMBOTA (6 pistas)</p> <p>AUDI A3 (1996 A 2003) 1.8</p> <p>d138.5mm d30mm</p>		<p>W5039 NO. 038105243K</p> <p>POLIE DA CAMBOTA (6 PISTAS)</p> <p>AUDI A3 SERIE 3 (1996 A 2003)</p> <p>d138mm d30mm</p>
	<p>W5048 NO. 03G105243 - 03G105243C - 03G105243E - 038105243E</p> <p>POLIE DA CAMBOTA (6 PISTAS)</p> <p>AUDI A3 1.9 TDI (09-1996 A 07-2001 Mtr AHF-ASV (81Kw) AUDI A3 1.9 TDI (08-1997 A 07-2001 Mtr ALH (66Kw) AUDI A3 (MOD. 2003) 1.9 TDI APOS 05-2003 Mtr BKC (105CV) AUDI A3 (MOD 2003) 2.0 TDI APOS 05-2003 Mtr AZV BKD BMM (136-140CV)</p> <p>d143mm d30mm</p>		<p>W5122 NO. 038105243M - 038105243L</p> <p>POLIE DA CAMBOTA (6 PISTAS)</p> <p>AUDI - A3 (8P1) - 1.6 TDI Ano fabric. a partir de: (11.09) (05.09 - 08.12) 90cv 1598cc Hatchback - AUDI - A3 (8P1) - 1.6 TDI (05.09 - 08.12) 105cv 1598cc Hatchback - AUDI - A3 (8P1) - 2.0 TDI Código do motor: CFFA (05.03 - 08.12) 136cv 1968cc Hatchback -</p> <p>d143mm d29,5mm</p>
	<p>Z29990 NO. 4B0867276A</p> <p>Mola de friso</p> <p>AUDI A3</p> <p>16x3x10mm NULL</p>		<p>Z80641A NO. 1H0853586</p> <p>Mola de fixação</p> <p>AUDI A3</p> <p>d13x13mm 1p-d10-12mm 1f-d8.5mm</p>

	Z80692 NO. N90821401 <i>Mola de fixação</i> AUDI A3 d15x21.5mm 1p-7.5x7.5-19.5mm 1f-d4.8mm		Z80750 NO. 51471904317 - N90201601H - 2207713 - 6998849 <i>Mola de painel</i> AUDI A3 d20x23mm 1p-d9-20mm
	Z80787 NO. 1039463 - 8E0825267 <i>Mola de fixação</i> AUDI A3 d20x34mm 1p-d8.5-21mm		Z80791 NO. 8Z0868243 <i>Mola de painel</i> AUDI A3 d21x22mm 1p-d10.5-13mm
	Z80803 NO. 1008068 - 7M0867299K <i>Mola de painel</i> AUDI A3 d17.7x21mm 1p-d8.6-15mm		Z80835 NO. 8L0807300 <i>Rebite</i> AUDI A3 d20x23mm 1p-d8-10mm

AUDI A4

	A1187 NO. 8A0253144E <i>APOIO DE ESCAPE</i> AUDI A4 (APÓS 94) 126x70x25mm 1f-d11mm if-d16mm		A1504 NO. 1J0253144H <i>APOIO DE ESCAPE</i> AUDI A4 240x54x30mm 2f-d12mm
	A1554 NO. 8D0199382B - 8D0199382G - 8D0199382K - 8D0199382M <i>APOIO DO MOTOR FRENTE DIREITO</i> AUDI A4 1.9TDI(APÓS 94) d100x105mm 2p-d8-30mm		A1555 NO. 8D0199379A - 8D0199379G - 8D0199379J - 8D0199379S <i>APOIO DO MOTOR FRENTE ESQUERDO</i> AUDI A4 1.6 - 1.8 - 1.9 TDI(APÓS 94) d98x105mm 2p-d8-30mm
	A1556 NO. 8D0199382L <i>APOIO DO MOTOR FRENTE DIREITO</i> AUDI A4 1.6 - 1.8(APÓS 94) d100x100mm 2p-d10-30mm		A1557 NO. 8D0399151J - 8D0399151P <i>APOIO DA CAIXA CENTRAL</i> AUDI A4 1.6 - 1.8 - 1.9TDI - 2.5TDI (APÓS 94) 122x90x55mm NULL
	A1954 NO. 1J0253144A <i>APOIO DO ESCAPE</i> AUDI A4 (8D2, B5) 1.9 TDI Local de montagem: com panela de escape central (01.95 A 11.00) 90cv 1896cc três volumes - AUDI A4 Avant (8D5, B5) 1.9 TDI Local de montagem: com panela de escape central (02.96 A 09.01) 90cv 1896cc Combi - AUDI A4 Avant (8D5, B5) 1.9 DUO Local de montagem: com panela de escape central (03.98 A 09.01) 90cv 1896cc Combi 160x115x90mm 2f-15x10mm 2f-d5mm 1f-d12mm		E0091 NO. 8A0505465C - 8D0505465 <i>ESTICADOR DA BARRA ESTABILIZADORA DE TRÁS LADO ESQUERDO</i> AUDI A4 TT (QUATTRO) (1997 A 2001) 265x35x35mm 1p-d10-28mm 1f-d10mm

	<p>E0097 NO. 4D0411317K</p> <p>ESTICADOR DA BARRA ESTABILIZADORA DA FRENTE</p> <p>AUDI A4 TT (1995 A 1997)</p> <p>70x30x32mm 2f-d11mm</p>		<p>E0098 NO. 4D0411318 - 8D0407318D</p> <p>ESTICADOR DA BARRA ESTABILIZADORA DA FRENTE</p> <p>AUDI A4 TT (1997 A 2001)</p> <p>125x70x37mm 2f-d10mm</p>
	<p>E0099 NO. 4D0411317 - 8D0407317D</p> <p>ESTICADOR DA BARRA ESTABILIZADORA DA FRENTE</p> <p>AUDI A4 TT (1997 A 2001)</p> <p>130x75x38mm 2f-d10mm</p>		<p>E0183 NO. 8E0411318</p> <p>ESTICADOR DA BARRA ESTABILIZADORA DA FRENTE LADO DIREITO</p> <p>AUDI A4 (MOD.2001) TT (ATÉ 12-2004) - AUDI A4 (MOD.2004) TT (APÓS 11-2004)</p> <p>125x70x35mm 1r-d10mm 1f-d11mm</p>
	<p>E0232 NO. 8E0411317</p> <p>ESTICADOR DA BARRA ESTABILIZADORA DA FRENTE LADO ESQUERDO</p> <p>AUDI A4 1.6(11-2000 A 12-2004) - 1.8 T(11-2000 A 12-2004) - 1.8 QUATTRO (09-2001 A 12-2004) - 1.9 Tdi (11-2000 A 12-2004) - 2.0(11-2000 A 12-2005) - 2.0 FSi (07-2002 A 12-2004) - 2.0 TFSi (ATÉ 06-2005) - 2.0 TFSi QUATTRO (ATÉ 11-2004) - 2.4 (9-2001 A 12-2)</p> <p>128x64x38mm 1f-d11mm 1f-M10mm</p>		<p>E1079 NO. 8D0253144A - 8D02531445</p> <p>ESTICADOR DE ESCAPE</p> <p>AUDI A4 (APÓS 1994)</p> <p>64x59x30mm NULL</p>
	<p>E1080 NO. 8D0253144 - 8D0253144K - 8D0253144R - 8D0253144AE</p> <p>ESTICADOR DE ESCAPE</p> <p>AUDI A4 (APÓS 1994)</p> <p>65x60x30mm NULL</p>		<p>E1081 NO. 1192E3</p> <p>ESTICADOR DE ESCAPE</p> <p>AUDI A4 (APÓS 1994)</p> <p>160x150x110mm NULL</p>
	<p>E1089 NO. 8E0253147 - 4B0253144H - 4B0253144K - 8E0253144L - 8E0253144N - 8D0253144Q - 8D0253144D - 8D0253144M...</p> <p>ESTICADOR DE ESCAPE</p> <p>AUDI A4 (APÓS 11-1994)</p> <p>150x100x40mm NULL</p>		<p>E1096 NO. 8D0253144AC - 8D0253144H - 8D0253144P</p> <p>ESTICADOR DE ESCAPE</p> <p>AUDI A4 (1995 A 2002)</p> <p>155x100x42mm NULL</p>
	<p>E1097 NO. 8D0253144G - 8D0253144N</p> <p>ESTICADOR DE ESCAPE</p> <p>AUDI A4 (1995 A 2002)</p> <p>155x75x65mm NULL</p>		<p>E1108 NO. 8K0253144D - 8k0253144M</p> <p>APOIO DO ESCAPE</p> <p>AUDI A4 (8K2 - B8) 1.8 TFSI N.º chas. a partir de: 8K-8-000001 - N.º chas. até: 8K-C-715000 - Sistema de escape: para a panela de escape traseira - Local de montagem: à direita (01.08 A 12.15) 120cv 1798cc três volumes - AUDI A4 (8K2 - B8) 1.8 TFSI N.º chas. a partir de: 8K-8-000001 - N.º chas. até: 8K-C-715000 - Sistema de escape: para a panela de escape traseira - Local de montagem: à direita (11.07 A 03.12) 160cv 1798cc três volume...etc.</p> <p>130x60x64mm 2f-d13mm 2f-d5mm</p>
	<p>F0799B-I NO. 1J0498201E - 3D0598201 - 7M0407283 - 7M0498201 - 7M0498201A - 7M0498202 - 8E0498201A - 8N0498201A - ...</p> <p>FOLE DA TRANSMISSÃO JUNTO À CAIXA</p> <p>AUDI A4 B6 1.8i T 20V - 1.8i T 20V QUATTRO - 1.8i T R4 20V - 2.0i 20V - 2.0i FSi QUATTRO - 3.0 TDi CR QUATTRO - 3.0i QUATTRO - 3.0i V6 30V QUATTRO (APÓS 2000) - AUDI B7 2.0i T FSi - 3.0 TDi CR - 3.2i FSi - 4.2i (APÓS 2004) - AUDI TT 1.8i T 20V - 1.8i T 20</p> <p>d80x100mm 1f-d58mm 1f-d23mm</p>		<p>F0799C-I NO. 3B0498201 - 443407283A - 443498201A - 8D0498201 - 8E0498201</p> <p>FOLE DA TRANSMISSÃO JUNTO À CAIXA</p> <p>AUDI A4 B5 1.6i - 1.8i 20V QUATTRO - 1.8i QUATTRO - 1.8i T 20V - 1.8i T 20V QUATTRO - 1.8i T QUATTRO - 1.9 TDi - 1.9 TDi PD QUATTRO - 1.9 TDi QUATTRO (1995 A 2001) - AUDI A4 B6 1.8i T (APÓS 2000) - AUDI A4 B7 1.6i - 1.8i T (APÓS 2004) - AUDI A6 C4 1.8i T</p> <p>d102x120mm 1f-d55mm 1f-d22mm</p>
	<p>F1057-I NO. 191498201D - 321498201A - 321498201D - 443498201</p> <p>FOLE DA TRANSMISSÃO JUNTO À CAIXA</p> <p>AUDI A4 (B5) 2.8i 12V QUATTRO (95 A 01)</p> <p>d91x83mm 1f-d82mm 1f-d21mm</p>		<p>F1323-I NO. 3B0498201A - 8A0407283 - 8A0498201</p> <p>FOLE DA TRANSMISSÃO JUNTO À CAIXA</p> <p>AUDI A4 (B5) 1.6i - 1.8i 20V (95 A 01)</p> <p>d90x85mm 1f-d82mm 1f-d33mm</p>

	F1651-I NO. 8D0419831K FOLE DA DIRECÇÃO ASSISTIDA LADO DIREITO AUDI A4 d67x240mm 1f-d62mm 1f-d18mm		F1652-I NO. 4D0419831D FOLE DA DIRECÇÃO ASSISTIDA LADO ESQUERDO AUDI A4 d67x200mm 1f-d50mm 1f-d17mm
	F4103 NO. 8D0711110D - 8D0711110DA21 FOLE ALAVANCA VELOCIDADES AUDI A4 (8D2, B5) 1.6 Ano fabric. até: 07.97 (11.94 A 10.00) 100cv 1595cc três volumes - AUDI A4 (8D2, B5) 1.8 Ano fabric. até: 07.97 (11.94 A 11.00) 125cv 1781cc três volumes - AUDI A4 (8D2, B5) 1.8 quattro Ano fabric. até: 07.97 (01.95 A 11.00) 125cv 1781cc três volumes - AUDI A4 (8D2, B5) 1.8 T Ano fabric. até: 07.97 (01.95 A 11.00) 150cv 1781cc três volumes - AUDI A4 (8D2, B5) 1.8 T quattro Ano fabric. até: 07.97 (01.95 A 11....etc. 250x220mm 1f-d12mm 1f-d160mm		KF1177-T NO. 8D0407285 KIT DE FOLE DO CARDAN JUNTO À RODA AUDI A4 B5 1.6i - 1.8i - 1.8i T - 1.9 Tdi - 2.8i d98x116mm 1f-d85mm 1f-d26mm
	KF1181-T NO. 3B0498203A - 4A0498203C - 6X0498203 - 8D0498099C - 8D0498203A - 8E0498203 KIT DE FOLE DO CARDAN JUNTO À RODA AUDI A4 B5 1.6i - 1.8i - 1.8i 20V - 1.8i 20V QUATTRO - 1.8i QUATTRO - 1.8i T 20V - 1.8i T 20V QUATTRO - 1.8i T QUATTRO - 1.9 TDi - 1.9 TDi PD (1995 A 2001) - AUDI A4 B6 1.8 iT - 2.0i FSi - 2.0i (APÓS 2000) - AUDI A4 B7 1.6i - 1.8 iT - 2.0i - 2.0 iT FSi (A) d100x120mm 1f-d85mm 1f-d26mm		KF1185 NO. 3B0598203 - 4B0598203 - 4E0598203 - 8E0598203 KIT DE FOLE DO CARDAN JUNTO À RODA AUDI A4 B5 1.8i T 20V QUATTRO - 1.8i T QUATTRO - 1.8i T R4 20V - 1.9 TDi PD - 1.9 TDi PD QUATTRO - 2.0i T FSi QUATTRO - 2.4i 30V QUATTRO - 2.5 TDi (1995 A 2001) - AUDI A4 B6 1.8 iT - 1.9 TDi PD - 2.5 TDi - 3.0i - 4.2i (APÓS 2000) - AUDI A4 B7 1.8 iT - 2.0 d105x80mm 1f-d84mm 1f-d21mm
	KL2763 NO. 028103638G - 028103665 - 028103937 KIT CASQUILHOS REPARAÇÃO CAIXA FILTRO OLEO AUDI A4 (8D2, B5) 1.9 TDI (12.95 A 11.00) 75cv 1896cc três volumes - AUDI A4 (8D2, B5) 1.9 TDI (01.95 A 11.00) 90cv 1896cc três volumes - AUDI A4 (8D2, B5) 1.9 TDI (10.95 A 11.00) 110cv 1896cc três volumes - AUDI A4 (8D2, B5) 1.9 TDI (03.00 A 11.00) 116cv 1896cc três volumes - AUDI A4 Avant (8D5, B5) 1.9 TDI (03.96 A 09.01) 75cv 1896cc Combi - AUDI A4 Avant (8D5, B5) 1.9 TDI (02.96 A 09.01) 90cv 1896cc Combi - AUDI A4 Avant (8D5, ...etc. d28x19mm 1f-d9mm		M6029 NO. 431253137A - 073253137A - 855253137A - 477253137 - 443253137C - 0063613483 - AA70A13483 JUNTA DE ESCAPE AUDI A4 (APÓS 1994) d60.3x13.8mm 1f-d46.5mm
	M6030 NO. 431253115A - 443253115A JUNTA DE ESCAPE AUDI A4 (APÓS 1994) 170x90mm 2f-d52mm		M6109 NO. 026129589A - 028129589B - 056129589A JUNTA DE ESCAPE AUDI A4 (APÓS 01-1995) - A6 (06-1994 A 01-2005) - CABRIO (05-91 A 08-00) - COUPE (07-80 A 12-96) - QUATTRO (07-80 A 07-89) 82x41mm 1f-38/27mm
	Q2006 NO. 893253139 UNIÃO DE ESCAPE 50.5x54x90mm AUDI A4 (APÓS 1994) - CABRIO (APÓS 1993) - COUPE (APÓS 1989) 94x84x59mm 1f-d50mm		Q2009 NO. UNIÃO DE ESCAPE 48/45x80mm AUDI - A4 (8E2 - B6) - 1.8 T (11.00 - 07.02) 150cv 1781cc três volumes - AUDI - A4 (8E2 - B6) - 1.8 T (07.02 - 12.04) 163cv 1781cc três volumes - AUDI - A4 (8E2 - B6) - 1.8 T (11.02 - 12.04) 190cv 1781cc três volumes - AUDI - A4 Avant (8E5 - B6) - 1.8 T (09) 80x77x55mm 1f-d45/48mm
	R221846 NO. 058121058B TUBO DE LIGAÇÃO AO RADIADOR DO ÓLEO AUDI - A4 (8D2 - B5) - 1.8 TRÊS VOLUMES 125CV 1781cc (01-1995 A 11-2000) - 1.8 quattro TRÊS VOLUMES 125CV 1781cc (01-1995 A 11-2000) - 1.8 T TRÊS VOLUMES 150CV 1781cc (01-1995 A 11-2000) - 1.8 T quattro TRÊS VOLUMES 150CV 1781cc (01-1995 A 11-2000) - 1.8 B150-16/19mm 80-90-60mm		R221863 NO. TUBO ADMISSÃO FILTRO DE AR AUDI A4 (8E2 B6) 1.9 TDI (05-2001 A 12-2004) 101CV 1896CC - AUDI A4 (E82 B6) 1.9 TDI (06-2004 A 12-2004) 116CV 1896CC B130-49/46mm 90-80mm
	R221866 NO. 8D0145828A - 8S0145828G TUBO ADMISSÃO FILTRO DE AR AUDI A4 (8D2, B5) 1.9 TDI (12.95 A 11.00) 75cv 1896cc três volumes - AUDI A4 (8D2, B5) 1.9 TDI (01.95 A 11.00) 90cv 1896cc três volumes - AUDI A4 Avant (8D5, B5) 1.9 TDI (02.96 A 09.01) 90cv 1896cc Comb B370-35/50mm 50-130-80-100-50-80mm		R221912 NO. TUBO DE LIGAÇÃO DO AR AO TURBO AUDI A4 (8D2 - B5) 1.9 TDI (12.95 - 11.00) 75cv 1896cc três volumes - AUDI A4 (8D2 - B5) 1.9 TDI (01.95 - 11.00) 90cv 1896cc três volumes - AUDI A4 (8D2 - B5) 1.9 TDI (10.95 - 11.00) 110cv 1896cc três volumes - AUDI A4 (8D2 - B5) 1.9 TDI quattro (09.96 - 11.0 B55-50/50mm 55mm

	<p>R221931 NO. 058145856A - 58145856</p> <p>TUBO ADMISSÃO FILTRO DE AR</p> <p>AUDI A4 (8D2, B5) 1.9 TDI (12.95 A 11.00) 75cv 1896cc três volumes - AUDI A4 (8D2, B5) 1.9 TDI (01.95 A 11.00) 90cv 1896cc três volumes - AUDI A4 (8D2, B5) 1.9 TDI (10.95 A 11.00) 110cv 1896cc três volumes - AUDI A4 (8D2, B5) 1.9 TDI quattro (09.96 A 11.00) 110cv 1896cc três volumes - AUDI A4 Avant (8D5, B5) 1.9 TDI (03.96 A 09.01) 75cv 1896cc Combi - AUDI A4 Avant (8D5, B5) 1.9 TDI (02.96 A 09.01) 90cv 1896cc Combi - AUDI A4 Avan...etc.</p> <p>B230-47/50mm 70-80-50-80-80mm</p>		<p>R221943 NO. 8E0145745B</p> <p>TUBO ADMISSÃO FILTRO DE AR DO TURBO</p> <p>AUDI - A4 (8E2 - B6) - 1.9 TDI Código do mot or: AVF - N.º chas. at é: 8E-4- 080000 (11.00 - 12.04) 130cv 1896cc três volumes - AUDI - A4 (8E2 - B6) - 1.9 TDI Código do mot or: AWX - N.º chas. at é: 8E-4- 080000 (11.00 - 12.04) 130cv 1896cc três volumes - AU</p> <p>B360-d53/53mm 90-140-130-120mm</p>
	<p>R222106 NO. 48121063</p> <p>TUBO DE LIGAÇÃO À BOMBA DE ÁGUA</p> <p>AUDI - A4 (8D2 - B5) - 1.6 TRÊS VOLUMES 100CV 1595cc (11-1994 A 10-2000) - 1.9 Di TRÊS VOLUMES 75CV 1896cc (12-1995 A 11-2000) - 1.9 TDI TRÊS VOLUMES 75CV 1896cc (12-1995 A 11-2000) - AUDI A4 Avant (8D5, B5) - 1.6 COMBI 100CV 1595cc (11-1994 A 09-2001) -</p> <p>B120-18/24mm 60-95mm</p>		<p>RF5016 NO. 028121065AD</p> <p>TUBO DE FERRO RADIADOR REFRIGERAÇÃO</p> <p>AUDI A4 (8D2_ B5) 1.9 TDI (01.95 A 11.00) 90cv 1896cc três volumes - AUDI A4 (8D2, B5) 1.9 TDI (10.95 A 11.00) 110cv 1896cc três volumes - AUDI A4 (8D2, B5) 1.9 TDI quattro (09.96 A 11.00) 110cv 1896cc três volumes - AUDI A4 Avant (8D5, B5) 1.9 TDI (02.96 A 09.01) 90cv 1896cc Combi - AUDI A4 Avant (8D5, B5) 1.9 TDI (02.96 A 09.01) 110cv 1896cc Combi - AUDI A4 Avant (8D5, B5) 1.9 TDI quattro (09.96 A 09.01) 110cv 1896cc Combi</p> <p>B330-17/17mm 60-80-140-80-110mm 1ch-40-d13mm</p>
	<p>RT08035 NO.</p> <p>TUBO DE TRAVÃO FRENTE LH-RH</p> <p>AUDI A4 (APÓS 1994)</p> <p>310mm F5 - F5</p>		<p>RT08061 NO. 8D0611775E - 4E0611775F</p> <p>TUBO DE TRAVÃO TRÁS LH-RH</p> <p>AUDI A4 (01-1995 - 09-2001)</p> <p>205mm F5 - F5</p>
	<p>RT08062 NO. 8D0611775B - 7701204509</p> <p>TUBO DE TRAVÃO TRÁS LH-RH</p> <p>AUDI A4 (MOD.95-00) TT (APÓS 01-1995)</p> <p>228mm F5 - MC11</p>		<p>RT08904 NO. 8D0611775J</p> <p>TUBO DE TRAVÃO TRÁS LH-RH</p> <p>AUDI A4 TT (ATÉ 09-2001) (CH:8DV160001)</p> <p>240mm F5 - OR26</p>
	<p>RT80171 NO. 8E0611707G - 8E0611707A - 8E0611707 - 8E0611707D</p> <p>TUBO DE TRAVÃO FRENTE LH-RH</p> <p>AUDI A4 1.6 (11-2000 A 12-2004) - 1.8 T (11-2000 A 12-2004) - 1.8 T QUATTRO (11-2000 A 12-2004) - 1.9 TDI (11-2000 A 12-2004) - 1.9 TDI QUATTRO (11-2001 A 12-2004) - 2.0 (11-2000 A 12-2004) - 2.0 FSI (07-2002 A 12-2004) - 2.4 09-2001 A 12-2004) - 2.5 TDI</p> <p>328mm F5 - F5</p>		<p>RT80171 NO. 8E0611707G - 8E0611707A - 8E0611707 - 8E0611707D</p> <p>TUBO DE TRAVÃO FRENTE LH-RH</p> <p>AUDI A4 AVANT 1.6 (09-2001 A 12-2004) - 1.8 T (09-2001 A 12-2004) - 1.8 T QUATTRO (09-2001 A 12-2004) - 1.9 TDI (09-2001 A 12-2004) - 1.9 TDI QUATTRO (11-2001 A 12-2004) - 2.0 (09-2001 A 12-2004) - 2.0 FSI (07-2002 A 12-2004) - 2.4 (09-2001 A 12-2004) - 2</p> <p>328mm F5 - F5</p>
	<p>RT80171 NO. 8E0611707G - 8E0611707A - 8E0611707 - 8E0611707D</p> <p>TUBO DE TRAVÃO FRENTE LH-RH</p> <p>AUDI A4 CABRIOLET 1.8 T (APÓS 07-2002) - 2.4 (04-2002 A 12-2005) - 2.5 TDI (08-20002 A 12-2005) - 3.0 (04-2002 A 12-2005)</p> <p>328mm F5 - F5</p>		<p>RT80254 NO. 8E0611775H - 8E0611775N</p> <p>TUBO DE TRAVÃO TRÁS LH-RH</p> <p>AUDI A4 (MOD.2001) TT (APÓS 10-2000) - (MOD.2004) TT (APÓS 11-2004)</p> <p>280mm F7 - OR27</p>
	<p>S1357 NO. 8A0511247B</p> <p>SILENT-BLOC DO BRAÇO DA SUSPENSÃO DE TRÁS</p> <p>AUDI A4 1.8 4X4 APÓS 1-96 - 1.8 20 V T 4X4 APÓS 1-96 - 1.9 TDI 4X4 APÓS 9-96 - 2.5 TDI 4X4 APÓS 9-97</p> <p>d52x25mm d44mm 1f-d12mm</p>		<p>S1358 NO. 4D0407182E</p> <p>SILENT-BLOC DO BRAÇO DA SUSPENSÃO DA FRENTE</p> <p>AUDI A4 1.6 SW APÓS 1-95 - 1.8 20V 4X4 SW APÓS 1-95 - 1.9 TDI 4X4 SW APÓS 1-95 - 2.5 TDI 4X4 SW APÓS 9-97</p> <p>d50x60mm c31mm 1f-d12mm</p>
	<p>S1359 NO. 8D0151541D - 8D0501541D - 8D0501541A</p> <p>SILENT-BLOC DA SUSPENSÃO DE TRÁS</p> <p>AUDI A4 1.6 SW 1-95 A 7-00 - 1.8 SW 2-96 A 9-01 - 1.8T 20V SW 1-95 A 9-01 - 1.9 TDI 1-95 A 9-01 - 2.5 TDI SW 9-97 A 9-01</p> <p>d37x101mm d56mm 1f-d12mm</p>		<p>S1360 NO. 4D0407183M - 4D0407183N - 4D0407183P - 4D0407183Q - 4D04071835</p> <p>SILENT-BLOC DO BRAÇO DA SUSPENSÃO DA FRENTE</p> <p>AUDI A4 1.6 SW APÓS 1-95 - 1.8 20V 4X4 SW APÓS 1-95 - 1.8 20V T 4X4 SW APÓS 3-96</p> <p>d65x80mm c65mm 1f-d12mm</p>





	<p>T0704-I NO. 3B0512131H - 4B9512131 - 3B0512131C</p> <p>BATENTE SUSPENSÃO DA FRENTE</p> <p>AUDI A4 (8E2 - B6) 1.6 (11.00 A 12.04) 102cv 1595cc três volumes - AUDI A4 (8E2 - B6) 1.8 T (11.00 A 07.02) 150cv 1781cc três volumes - AUDI A4 (8E2 - B6) 1.8 T quattro (11.00 - 07.02) 150cv 1781cc três volumes - AUDI A4 (8E2 - B6) 1.8 T (07.02 A 12.04) 163cv 1781cc três volumes - AUDI A4 (8E2 - B6) 1.8 T quattro (07.02 A 12.04) 163cv 1781cc três volumes - AUDI A4 (8E2 - B6) 1.8 T (11.02 A 12.04) 190cv 1781cc três volumes - AUDI A4 (8...etc.</p> <p>d61x136mm 1f-d18mm 1f-d15mm</p>		<p>UFV2000 NO. 06A103663A</p> <p>FUNIL VARETA NIVEL ÓLEO</p> <p>AUDI A4 (8D2, B5) 1.6 N.º chas. at é: 8D-X-400 000, Código do mot or: AHL, Código do mot or: ANA, Código do mot or: ARM (11.94 A 10.00) 100cv 1595cc três volumes - AUDI A4 Avant (8D5, B5) 1.6 N.º chas. at é: 8D-X-400 000, Código do mot or: AHL, Código do mot or: ANA, Código do mot or: ARM (11.94 A 09.01) 100cv 1595cc Combi</p> <p>75x25mm 1f-d18mm 1f-d20mm</p>
	<p>UFV2001 NO. 38103663</p> <p>FUNIL VARETA NIVEL ÓLEO</p> <p>AUDI A4 (8D2, B5) 1.9 TDI N.º chas. a part ir de: 8D-X-200 001 03.00 - 11.00 85 116 1896 três volumes AUDI A4 (8D2, B5) 1.9 TDI quattro N.º chas. a part ir de: 8D-X-200 001, Código do mot or: AJM 03.00 - 11.00 85 116 1896 três volumes AUDI A4 Avant (8D5, B5) 1.9 TDI N.º chas. a part ir de: 8D-X-200 001 03.00 - 09.01 85 115 1896 Combi AUDI A4 Avant (8D5, B5) 1.9 TDI quattro N.º chas. a part ir de: 8D-X-200 001 03.00 - 09.01 85 115 1896 Comb...etc.</p> <p>260x25mm 1f-d18mm 1f-d20mm</p>		<p>UFV2004 NO. 06B103663B - 06B103663G</p> <p>FUNIL VARETA NIVEL ÓLEO</p> <p>AUDI A4 (8D2, B5) 1.6 Ano fabric. a part ir de: 07.99, Código do mot or: AHL, Código do mot or: ANA, Código do mot or: ARM (11.94 A 10.00) 100cv 1595cc três volumes - AUDI A4 (8D2, B5) 1.6 (07.00 A 11.00) 102cv 1595cc três volumes - AUDI A4 (8D2, B5) 1.8 T Ano fabric. a part ir de: 06.00, Código do mot or: AWT (01.95 A 11.00) 150cv 1781cc três volumes - AUDI A4 (8D2, B5) 1.8 T quattro Ano fabric. a part ir de: 06.00, Código do mot or...etc.</p> <p>240x25mm 1f-d18mm 1f-d20mm</p>
	<p>W5006 NO. 06A105243E - 06B105243F - 06A105255K</p> <p>POLIE DA CAMBOTA (6 pistas)</p> <p>AUDI A4 (APÓS 2000) - 1.8</p> <p>d138.5mm d30mm</p>		<p>W5048 NO. 03G105243 - 03G105243C - 03G105243E</p> <p>POLIE DA CAMBOTA (6 PISTAS)</p> <p>AUDI A4 (MOD 2001) 1.9TDi (05-2001 A 12-2004) Mtr AVB (74Kw) - AUDI A4 (MOD 2001) 1.9 TDi (11-2000 A 12-2004) Mtr AWX AVF (96Kw) A4 (MOD 2001) 1.9 TDi (06-2004 A 12-2004) Mtr BKE (85Kw) - AUDI A4 (MOD 2004) 1.9 TDi (APÓS 11-2004) Mtr BKE (85Kw) - AUDI A4</p> <p>d143mm d30mm</p>
	<p>W5049 NO. 038105243F</p> <p>POLIE DA CAMBOTA (5 + 4 PISTAS)</p> <p>AUDI A4 1.9 TDi (03-2000 A 12-2000) Mtr AJM ATJ (85Kw) - A4 (MOD 2001) 1.9 TDi (05-2001 A 12-2004) Mtr AVB (74Kw) - A4 (MOD 2001) 1.9 TDi (11-2000 A 12-2004) Mtr AWX AVF (96Kw) - A4 (MOD 2004) 1.9 TDi APÓS 11-2004 Mtr BKE (85Kw)</p> <p>d139mm d30mm</p>		<p>W5052 NO. 059105251AD - 059105251S - 059105251N - 059105251AA - 059105251AH - 059105251AS - 059105251AG - 0591...</p> <p>POLIE DA CAMBOTA (6 PISTAS)</p> <p>AUDI A4 (MOD 2004) 3.0 TDi - QUATTRO APÓS 11-2004 Mtr BKN (204CV)</p> <p>d190mm d24mm</p>
	<p>W5053 NO. 059105251AC - 059105251M</p> <p>POLIE DA CAMBOTA (6 + 4 PISTAS)</p> <p>AUDI A4 2.5 TDi (09-1997 A 10-2000) Mtr AFB AKN (150CV) - AUDI A4 (MOD 2001) 2.5 TDi (08-2001 A 07-2002) Mtr AYM (155CV) - AUDI A4 (MOD 2001) 2.5 TDi APÓS 08-2002 Mtr BCZ BDE BFC (163CV)</p> <p>d193mm d33.8mm</p>		<p>W5056 NO. 028105243Q</p> <p>POLIE DA CAMBOTA (5 + 4 PISTAS)</p> <p>AUDI A4 1.9 TDi APÓS 12-1995 Mtr AFF (55Kw) - A4 1.9 TDi (01-1995 A 11-2000) Mtr AHH (66Kw) - A4 1.9 TDi (01-1995 A 11-2000) Mtr AHU-1Z (66Kw) Mtr AFN AVG (81Kw)</p> <p>d138/143mm d30mm</p>
	<p>W5122 NO. 038105243M - 038105243L</p> <p>POLIE DA CAMBOTA (6 PISTAS)</p> <p>AUDI - A4 (8K2 - B8) - 2.0 TDi Código do motor: CJCC (APÓS 06.08) 120cv 1968cc três volumes - AUDI - A4 (8K2 - B8) - 2.0 TDi Código do motor: CJCB (APÓS 11.07) 136cv 1968cc três volumes - AUDI - A4 (8K2 - B8) - 2.0 TDi Código do motor: CJCA - CMFA (APÓS 11.07)</p> <p>d143mm d29.5mm</p>		<p>Z80626 NO. 161867299</p> <p>Mola de fixação</p> <p>AUDI A4</p> <p>d16x28mm 1p-d9-14mm</p>
	<p>Z80692 NO. N90821401</p> <p>Mola de fixação</p> <p>AUDI A4</p> <p>d15x21.5mm 1p-7.5x7.5-19.5mm 1f-d4.8mm</p>		<p>Z80750 NO. 51471904317 - N90201601H - 2207713 - 6998849</p> <p>Mola de painel</p> <p>AUDI A4</p> <p>d20x23mm 1p-d9-20mm</p>
	<p>Z80766 NO. N10516801</p> <p>Mola de fixação</p> <p>AUDI A4</p> <p>d15x17.5mm 1p-8x8.5-14.5mm 1f-d4.8mm</p>		<p>Z80785 NO. 4A0805121A</p> <p>Mola de fixação</p> <p>AUDI A4</p> <p>d25x28mm 1p-10x6.5-21mm</p>

	Z80786 NO. 4A0805163 <i>Mola de fixação</i> AUDI A4		Z80787 NO. 1039463 - 8E0825267 <i>Mola de fixação</i> AUDI A4 (Após 2002)
	20x14x16mm 1f-d10mm		d20x34mm 1p-d8.5-21mm
	Z80791 NO. 8Z0868243 <i>Mola de painel</i> AUDI A4		Z80801 NO. 4A0805960 - 8D0805960 <i>Mola de fixação</i> AUDI A4
	d21x22mm 1p-d10.5-13mm		25x25x9.6mm NULL
	Z80821 NO. 8E0868243 NULL AUDI A4 (Até 2002)		Z80885 NO. 7L6868243 <i>MOLA DE PAINEL</i> AUDI A4 (A Partir de 2008)
	d27x30mm 1p-d10-17mm		d22x30mm 1p-d8-10mm







AUDI A5







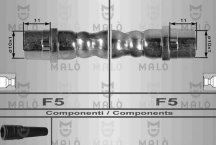
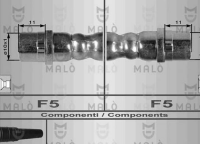
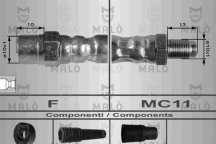
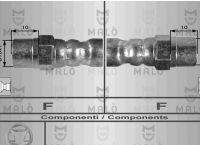
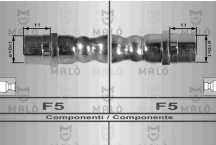
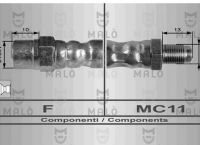
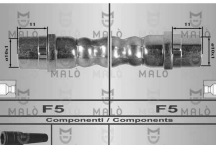
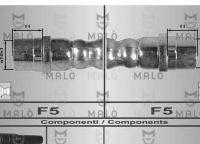
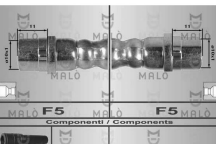

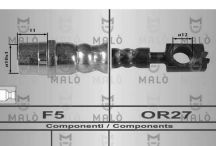







	W5122 NO. 038105243M - 038105243L <i>POLIE DA CAMBOTA (6 PISTAS)</i> AUDI - A5 (8T3) - 2.0 TDI (APÓS 10.11) 177cv 1968cc Coupé - AUDI - A5 (8T3) - 2.0 TDI quattro (APÓS 12.11) 177cv 1968cc Coupé - AUDI - A5 Sportback (8TA) - 2.0 TDI Código do motor: CJCB (APÓS 09.09) 136cv 1968cc Hatchback - AUDI - A5 Sportback (8TA) - 2.0		Z80885 NO. 7L6868243 <i>MOLA DE PAINEL</i> AUDI A5 (A Partir de 2008)
	d143mm d29,5mm		d22x30mm 1p-d8-10mm

AUDI A6

	A1554 NO. 8D0199382B - 8D0199382G - 8D0199382K - 8D0199382M <i>APOIO DO MOTOR FRENTE DIREITO</i> AUDI A6 1.9TDI(APÓS 97)		A1555 NO. 8D0199379A - 8D0199379G - 8D0199379J - 8D0199379S <i>APOIO DO MOTOR FRENTE ESQUERDO</i> AUDI A6 1.8 (APÓS 97) - 1.8 T (APÓS 97)
	d100x105mm 2p-d8-30mm		d98x105mm 2p-d8-30mm
	A1556 NO. 8D0199382L <i>APOIO DO MOTOR FRENTE DIREITO</i> AUDI A6 1.8 - 1.8T (APÓS 97)		A1557 NO. 8D0399151J - 8D0399151P <i>APOIO DA CAIXA CENTRAL</i> AUDI A6 1.8 - 1.8T - 1.9TDI - 2.5TDI(APÓS 97)
	d100x100mm 2p-d10-30mm		122x90x55mm NULL

	<p>A1954 NO. 1J0253144A</p> <p>APOIO DO ESCAPE</p> <p>AUDI A6 (4A, C4) 1.9 TDI Local de montagem: com panela de escape central (06.94 A 10.97) 90cv 1896cc três volumes - AUDI A6 Avant (4A, C4) 1.9 TDI Local de montagem: com panela de escape central (06.94 A 12.97) 90cv 1896cc Combi</p>		<p>E0090 NO. 8A0505466C - 8D0505466</p> <p>ESTICADOR DA BARRA ESTABILIZADORA DE TRÁS LADO DIREITO</p> <p>AUDI A6 (MOD.97) TT (QUATTRO)</p>
	<p>E0091 NO. 8A0505465C - 8D0505465</p> <p>ESTICADOR DA BARRA ESTABILIZADORA DE TRÁS LADO ESQUERDO</p> <p>AUDI A6 (MOD.97) TT (QUATTRO)</p>		<p>E0098 NO. 4D0411318 - 8D0407318D</p> <p>ESTICADOR DA BARRA ESTABILIZADORA DA FRENTE</p> <p>AUDI A6 (MOD.97) TT APÓS 1997</p>
	<p>E0099 NO. 4D0411317 - 8D0407317D</p> <p>ESTICADOR DA BARRA ESTABILIZADORA DA FRENTE</p> <p>AUDI A6 (MOD.97) TT (APÓS 1997)</p>		<p>E1079 NO. 8D0253144A - 8D02531445</p> <p>ESTICADOR DE ESCAPE</p> <p>AUDI A6 (APÓS 1998)</p>
	<p>E1080 NO. 8D0253144 - 8D0253144K - 8D0253144R - 8D0253144AE</p> <p>ESTICADOR DE ESCAPE</p> <p>AUDI A6 (APÓS 1998)</p>		<p>E1089 NO. 8E0253147 - 4B0253144H - 4B0253144K - 8E0253144L - 8E0253144N - 8D0253144Q - 8D0253144D - 8D0253144M...</p> <p>ESTICADOR DE ESCAPE</p> <p>AUDI A6 (APÓS 04-1997)</p>
	<p>F0799A-I NO. 443407283A - 321407283</p> <p>FOLE LADO DA CAIXA</p> <p>AUDI A6 AVANT 2.0 - 2.3 (ABS) - QUATTRO 2.0 - 2.2 - 2.6 - 2.8</p>		<p>F9047H-I NO. 4H0498203</p> <p>FOLE DO CARDAN LADO DA RODA</p> <p>AUDI A6 4GH ALLROAD 3.0 TDi Station Wagon - 5 p.(Quattro) (180kW) (APÓS 01-2012) - (230KW) (APÓS 01-2012) - (150KW) (APÓS 01-2012) - 3.0 TFSi Station Wagon - 5 p.(Quattro) (228KW)(APÓS 01-2012)</p>
	<p>KF1177-T NO. 8D0407285</p> <p>KIT DE FOLE DO CARDAN JUNTO À RODA</p> <p>AUDI A6 C5 (1997 A 2004) 1.8i T - 1.8i (1995 A 2001)</p>		<p>KL2763 NO. 028103638G - 028103665 - 028103937</p> <p>KIT CASQUILHOS REPARAÇÃO CAIXA FILTRO OLEO</p> <p>AUDI A6 (4A, C4) 1.9 TDI (06.94 A 10.97) 90cv 1896cc três volumes - AUDI A6 Avant (4A, C4) 1.9 TDI (06.94 A 12.97) 90cv 1896cc Combi - AUDI A6 (4B2, C5) 1.9 TDI (04.97 A 10.00) 110cv 1896cc três volumes - AUDI A6 (4B2, C5) 1.9 TDI (07.00 A 01.05) 115cv 1896cc três volumes - AUDI A6 (4B2, C5) 1.9 TDI (08.01 A 01.05) 130cv 1896cc três volumes - AUDI A6 Avant (4B5, C5) 1.9 TDI (02.98 A 04.01) 110cv 1896cc Combi - AUDI A6 Avant (4B5, ...etc.</p>
	<p>M6029 NO. 431253137A - 073253137A - 855253137A - 477253137 - 443253137C - 0063613483 - AA70A13483</p> <p>JUNTA DE ESCAPE</p> <p>AUDI A6 (1994 A 1996) - COUPE (1980 A 1991)</p>		<p>M6030 NO. 431253115A - 443253115A</p> <p>JUNTA DE ESCAPE</p> <p>AUDI A6 (1994 A 1996) - CABRIO (APÓS 1991) - COUPE (1980 A 1996)</p>
	<p>M6109 NO. 026129589A - 028129589B - 056129589A</p> <p>JUNTA DE ESCAPE</p> <p>AUDI A6 (06-1994 A 01-2005)</p>		<p>N2331 NO. 861253147 - 823010459 - 893253147F</p> <p>ANEL ESCAPE</p> <p>AUDI A6 (1994 A 1997) - CABRIO (APÓS 1988) - COUPE (APÓS 1980)</p>







	<p>Q2003 NO. 3572531411 - 357253141 - 443253141D</p> <p>UNIÃO DE ESCAPE 56/60x125mm</p> <p>AUDI A6 (APÓS 1994)</p> <p>125x90x67mm 1f-d57mm</p>		<p>Q2007 NO. 893253139B - 893253139C - 437253141</p> <p>UNIÃO DE ESCAPE 61/65x130 mm</p> <p>AUDI A6 (1994 A 1997) - A8 (APÓS 1994) - V8 (1991 A 1994)</p> <p>130x90x70mm 1f-d61mm</p>
	<p>R221846 NO. 058121058B</p> <p>TUBO DE LIGAÇÃO AO RADIADOR DO ÓLEO</p> <p>AUDI A6 (4A - C4) - 1.8 TRÊS VOLUMES 125CV 1781cc (12-1995 A 10-1997) - 1.8 quattro TRÊS VOLUMES 125CV 1781cc (12-1995 A 10-1997) - 1.9 TDI TRÊS VOLUMES 90CV 1896cc (06-1994 A 10-1997) - 1.8 COMBI 125CV 1781cc (12-1995 A 12-1997) - 1.8 quattro COMBI 125CV</p> <p>B150-16/19mm 80-90-60mm</p>		<p>R221863 NO.</p> <p>TUBO ADMISSÃO FILTRO DE AR</p> <p>AUDI A6 (4B2 C5) 1.9 TDI (08-2001 A 01-2005) 130CV 1896CC - AUDI A6 AVANT (4B5 C5) 1.9 TDI (08-2001 A 01-2005) 130CV 1896CC</p> <p>B130-49/46mm 90-80mm</p>
	<p>RF5016 NO. 028121065AD</p> <p>TUBO DE FERRO RADIADOR REFRIGERAÇÃO</p> <p>AUDI A6 (4B2 C5) 1.9 TDI 04.97 - 10.00 81 110 1896 três volumes AUDI A6 Avant (4B5, C5) 1.9 TDI 02.98 - 04.01 81 110 1896 Combi</p> <p>B330-17/17mm 60-80-140-80-110mm 1ch-40-d13mm</p>		<p>RT08030 NO. 4A0611707 - 171611701G</p> <p>TUBO DE TRAVÃO FRENTE LH-RH</p> <p>AUDI A6 (MOD.95-97) TT</p> <p>295mm F5 - F5</p>
	<p>RT08035 NO.</p> <p>TUBO DE TRAVÃO FRENTE LH-RH</p> <p>AUDI A6 (Mod 97)</p> <p>310mm F5 - F5</p>		<p>RT08043 NO. 4A0611775 - 4B0611775</p> <p>TUBO DE TRAVÃO TRÁS LH-RH</p> <p>AUDI A6 1.8 QUATTRO (12-1995 A 10-1997) - A6 2.0 16V QUATTRO (06-1994 A 10-1997) - A6 2.3 QUATTRO (06-1994 A 12-1995) - A6 2.5 TDI QUATTRO (10-1995 A 10-1997) - A6 2.6 QUATTRO (06-1994 A 10-1997) - A6 2.8 QUATTRO (06-1994 A 10-1997) - A6 S6 4.2 QUATTRO ()</p> <p>235mm F - MC11</p>
	<p>RT08227 NO. 433611775A - 431611775A - 433611755A - 443611775D</p> <p>TUBO DE TRAVÃO TRÁS LH-RH</p> <p>AUDI A6 (APÓS 1995)</p> <p>180mm F - F</p>		<p>RT08905 NO. 4B0611775</p> <p>TUBO DE TRAVÃO TRÁS LH-RH INTERMÉDIO</p> <p>AUDI A6 (MOD.97) TT</p> <p>195mm F5 - F5</p>
	<p>RT08906 NO. 4A0611775B</p> <p>TUBO DE TRAVÃO TRÁS LH-RH</p> <p>AUDI A6 (MOD.95-97) TT</p> <p>205mm F - MC11</p>		<p>RT80164 NO. 4F0611707 - 4F0611707B</p> <p>TUBO DE TRAVÃO FRENTE LH-RH</p> <p>AUDI A6 2.0 Tdi (APÓS 07/2004) - A6 2.0 TFSi (APÓS 06-2005) - A6 2.4 (05-2004 A 10-2008) - A6 2.4 QUATTRO (01-2005 A 10-2008) - A6 2.7 TDi (APÓS 11-2004) - A6 2.7 TDI QUATTRO (APÓS 06-2005) - A6 3.0 TDI QUATTRO (APÓS 05-2004) - A6 3.2 FSi (05-2004 A 10-20)</p> <p>340mm F5 - F5</p>
	<p>RT80164 NO. 4F0611707 - 4F0611707B</p> <p>TUBO DE TRAVÃO FRENTE LH-RH</p> <p>AUDI A6 ALLROAD 2.7 TDI QUATTRO (APÓS 05-2006) - A6 ALLROAD 3.0 TDi QUATTRO (APÓS 05-2006) - A6 ALLROAD 3.0 TFSi QUATTRO (APÓS 10-2008) - A6 ALLROAD 3.2 FSi QUATTRO (APÓS 05-2006) - A6 ALLROAD 4.2 FSi QUATTRO (APÓS 05-2006)</p> <p>340mm F5 - F5</p>		<p>RT80164 NO. 4F0611707 - 4F0611707B</p> <p>TUBO DE TRAVÃO FRENTE LH-RH</p> <p>AUDI A6 AVANT 2.0 TDi (APÓS 06-2005) - A6 AVANT 2.0 TFSi (APÓS 06-2005) - A6 AVANT 2.4 (03-2005 A 10-2008) - A6 AVANT 2.4 QUATTRO (03-2005 A 10-2008) - A6 AVANT 2.7 TDi (APÓS 03-2005) - A6 AVANT 2.7 TDI QUATTRO (APÓS 06-2005) - A6 AVANT 3.0 TDI QUATTRO (A)</p> <p>340mm F5 - F5</p>
	<p>RT80165 NO. 4F0611775 - 4F0611775D</p> <p>TUBO DE TRAVÃO TRÁS LH-RH</p> <p>AUDI A6 2.0 TDi (APÓS 10-2008) - A6 2.0 TFSi (APÓS 06-2005) - A6 2.4 (05-2004 A 10-2008) - A6 2.4 (05-2004 A 10-2008) - A6 2.7 TDi (APÓS 10-2008) - A6 2.7 TDI QUATTRO (APÓS 10-2008) - A6 3.0 TDI QUATTRO (APÓS 05-2006) - A6 3.2 FSi (05-2004 A 10-2008) - A6</p> <p>350mm F5 - MC11</p>		<p>RT80248 NO. 4B0611775C - 4B0611775A - 4B0611775B - 8E0611775C</p> <p>TUBO DE TRAVÃO TRÁS LH-RH</p> <p>AUDI A6 (QUATTRO) TT (02-1997 A 01-2005)</p> <p>330mm F5 - OR27</p>

	<p>S1358 NO. 4D0407182E</p> <p>SILENT-BLOC DO BRAÇO DA SUSPENSÃO DA FRENTE</p> <p>AUDI A6 1.8 - 1.8 T SW APÓS 7-97 - 1.9 TDI APÓS 2-97 - 2.5 TDI SW APÓS 7-97</p> <p>d50x60mm c31mm 1f-d12mm</p>		<p>S1360 NO. 4D0407183M - 4D0407183N - 4D0407183P - 4D0407183Q - 4D0407183S</p> <p>SILENT-BLOC DO BRAÇO DA SUSPENSÃO DA FRENTE</p> <p>AUDI A6 1.8 4X4 APÓS 12-95 - 1.8 T 4X4 APÓS 7-97 - 1.9 TDI APÓS 6-94 - 2.0 6-94 A 2-97 - 2.0 16V 4X4 6-94 A 2-97 - 2.5 TDI 4X4 APÓS 6-94</p> <p>d65x80mm c65mm 1f-d12mm</p>
	<p>T0704-I NO. 3B0512131H - 4B9512131 - 3B0512131C</p> <p>BATENTE SUSPENSÃO DA FRENTE</p> <p>AUDI A6 (4B2 - C5) 1.8 (07.97 A 01.05) 125cv 1781cc três volumes - AUDI A6 (4B2 - C5) 1.8 T (01.97 A 01.05) 150cv 1781cc três volumes - AUDI A6 (4B2 - C5) 1.8 T (12.97 A 01.05) 180cv 1781cc três volumes - AUDI A6 (4B2 - C5) 2.0 (08.01 A 01.05) 130cv 1984cc três volumes 2/2 - AUDI A6 (4B2 - C5) 2.4 (07.98 A 01.05) 136cv 2393cc três volumes - AUDI A6 (4B2 - C5) 2.4 (02.97 A 01.05) 156cv 2393cc três volumes - AUDI A6 (4B2 - C5) 2.4 (02.9...etc.</p> <p>d61x136mm 1f-d18mm 1f-d15mm</p>		<p>UFV2000 NO. 06A103663A</p> <p>FUNIL VARETA NÍVEL ÓLEO</p> <p>AUDI A6 (4B2, C5) 1.8 Código do mot or: AJP, Código do mot or: AQE, Código do mot or: ARH (07.97 A 01.05) 125cv 1781cc três volumes - AUDI A6 Avant (4B5, C5) 1.8 (12.97 A 01.05) 125cv 1781cc Combi</p> <p>75x25mm 1f-d18mm 1f-d20mm</p>
	<p>UFV2001 NO. 38103663</p> <p>FUNIL VARETA NÍVEL ÓLEO</p> <p>AUDI A6 (4B2, C5) 1.9 TDI (07.00 A 01.05) 115cv 1896cc três volumes - AUDI A6 (4B2, C5) 1.9 TDI (08.01 A 01.05) 130cv 1896cc três volumes - AUDI A6 Avant (4B5, C5) 1.9 TDI (07.00 A 01.05) 115cv 1896cc Combi - AUDI A6 Avant (4B5, C5) 1.9 TDI (08.01 A 01.05) 130cv 1896cc Combi</p> <p>260x25mm 1f-d18mm 1f-d20mm</p>		<p>UFV2004 NO. 06B103663B - 06B103663G</p> <p>FUNIL VARETA NÍVEL ÓLEO</p> <p>AUDI A6 (4B2, C5) 1.8 T Ano fabric. a part ir de: 05.00, Código do mot or: AWT (01.97 A 01.05) 150cv 1781cc três volumes - AUDI A6 (4B2, C5) 1.8 T quatro Ano fabric. a part ir de: 05.00, Código do mot or: AWT (02.97 A 01.05) 150cv 1781cc três volumes - AUDI A6 Avant (4B5, C5) 1.8 T Ano fabric. a part ir de: 05.00, Código do mot or: AWT (12.97 A 01.05) 150cv 1781cc Combi - AUDI A6 Avant (4B5, C5) 1.8 T quatro Ano fabric. a part ir de:...etc.</p> <p>240x25mm 1f-d18mm 1f-d20mm</p>
	<p>W5008 NO. 028105243T - 028105243G - 028105243H - 028105243K - 028105243R</p> <p>POLIE DA CAMBOTA (6 pistas)</p> <p>AUDI A6 mod.95-97 1.9 TDI (06-1994 A 02-1997)</p> <p>d155.5mm d30mm</p>		<p>W5048 NO. 03G105243 - 03G105243C - 03G105243E</p> <p>POLIE DA CAMBOTA (6 PISTAS)</p> <p>AUDI A6 (MOD 2004) 2.0 TDi APÓS 07-2004 Mtr BLB BRE (103Kw)</p> <p>d143mm d30mm</p>
	<p>W5049 NO. 038105243F</p> <p>POLIE DA CAMBOTA (5 + 4 PISTAS)</p> <p>AUDI A6 (MOD 97) 1.9 TDi (08-2000 A 12-2003 Mtr AJM (85Kw) - A6 (MOD 97) 1.9 TDi (11-2000 A 12-2004 Mtr AWF AWX (96Kw)</p> <p>d139mm d30mm</p>		<p>W5052 NO. 059105251AD - 059105251S - 059105251N - 059105251AA - 059105251AH - 059105251AS - 059105251AG - 0591...</p> <p>POLIE DA CAMBOTA (6 PISTAS)</p> <p>AUDI A6 (MOD 2004) 2.7 TDi APÓS 11-2004 Mtr BSG BPP (163-180CV) AUDI A6 (MOD 2004) 3.0 TDi QUATTRO APÓS 05-2004 Mtr BNG BMK (211-225CV)</p> <p>d190mm d24mm</p>
	<p>W5053 NO. 059105251AC - 059105251M</p> <p>POLIE DA CAMBOTA (6 + 4 PISTAS)</p> <p>AUDI A6 (MOD 97) 2.5 24V TDi APÓS 07-1997 Mtr AFB AKN (110Kw) - AUDI A6 (MOD 97) 2.5 24V TDi APÓS 02-2000 Mtr AKE (132Kw) - AUDI A6 (MOD 97) 2.5 V6 TDi (08-2001 A 07-2002 Mtr AYN (114Kw) - AUDI A6 2.5 V6 TDi APÓS 08-2002 Mtr BCZ BDG (120Kw)</p> <p>d193mm d33.8mm</p>		<p>W5056 NO. 028105243Q</p> <p>POLIE DA CAMBOTA (5 + 4 PISTAS)</p> <p>AUDI A6 (MOD 97) 1.9 TDi APÓS 02-1997 Mtr AFN AVG (81Kw)</p> <p>d138/143mm d30mm</p>
	<p>W5122 NO. 038105243M - 038105243L</p> <p>POLIE DA CAMBOTA (6 PISTAS)</p> <p>AUDI - A6 (4G2 - C7 - 4GC) - 2.0 TDI (APÓS 03.11) 163cv 1968cc três volumes - AUDI - A6 (4G2 - C7 - 4GC) - 2.0 TDI (APÓS 03.11) 177cv 1968cc três volumes - AUDI - A6 Avant (4G5 - C7 - 4GD) - 2.0 TDI (APÓS 05.11) 163cv 1968cc Combi - AUDI - A6 Avant (4G5 - C7 - 4G</p> <p>d143mm d29.5mm</p>		<p>Z80459 NO. 823867299</p> <p>Mola de painel</p> <p>AUDI A6</p> <p>d18x21.2mm 1p-d7.6-14.2mm</p>
	<p>Z80692 NO. N90821401</p> <p>Mola de fixação</p> <p>AUDI A6</p> <p>d15x21.5mm 1p-7.5x7.5-19.5mm 1f-d4.8mm</p>		<p>Z80748 NO. 893867290</p> <p>Mola de painel</p> <p>AUDI A6</p> <p>d18x19.5mm 1p-d8-14.5mm</p>

	Z80749 NO. 703867299 Mola de painel AUDI A6		Z80750 NO. 51471904317 - N90201601H - 2207713 - 6998849 Mola de painel AUDI A6
	d18x20.5mm 1p-d8.4-13.5mm		d20x23mm 1p-d9-20mm
	Z80785 NO. 4A0805121A Mola de fixação AUDI A6		Z80786 NO. 4A0805163 Mola de fixação AUDI A6
	d25x28mm 1p-10x6.5-21mm		20x14x16mm 1f-d10mm
	Z80801 NO. 4A0805960 - 8D0805960 Mola de fixação AUDI A6		Z80803 NO. 1008068 - 7M0867299K Mola de painel AUDI A6
	25x25x9.6mm NULL		d17.7x21mm 1p-d8.6-15mm

AUDI A8

	E1073 NO. 441253147B ESTICADOR DE ESCAPE AUDI A8 (APÓS 1994)		E1089 NO. 8E0253147 - 4B0253144H - 4B0253144K - 8E0253144L - 8E0253144N - 8D0253144Q - 8D0253144D - 8D0253144M... ESTICADOR DE ESCAPE AUDI A8 (APÓS 06-1997)
	70x50x23mm NULL		150x100x40mm NULL
	Q2003 NO. 3572531411 - 357253141 - 443253141D UNIÃO DE ESCAPE 56/60x125mm AUDI A8 (APÓS 1994) - COUPÉ (APÓS 1989) - V8 (1988 A 1993)		RT80163 NO. 4D0611707H - 4D0611707D - 4D0611707F TUBO DE TRAVÃO FRENTE LH-RH AUDI A8 2.5 TDi (01-1997 A 09-2002) - A8 2.5 TDi QUATTRO (07-1997 A 09-2002) - A8 2.8 (03-1994 A 09-2002) - A8 2.8 QUATTRO (03-1994 A 09-2002) - A8 3.3 TDi QUATTRO (06-2000 A 09-2002) - A8 3.7 (07-1995 A 09-2002)
	125x90x67mm 1f-d57mm		384mm F5 - F5
	RT80163 NO. 4D0611707H - 4D0611707D - 4D0611707F TUBO DE TRAVÃO FRENTE LH-RH AUDI A8 3.7 QUATTRO (07-1995 A 09-2002) - A8 4.2 QUATTRO (03-1994 A 04-2000) - A8 6.0 W12 QUATTRO (01-2001 A 09-2002) - A8 S 8 QUATTRO (07-1996 A 09-2002)		RT80317 NO. 4D0611775B - 4D0611775A TUBO DE TRAVÃO TRÁS LH-RH AUDI A8 2.5 TDi QUATTRO (07-1997 A 09-2002) - A8 2.8 QUATTRO (03-1994 A 09-2002) - A8 3.3 TDi QUATTRO (06-2000 A 09-2002) - A8 3.7 (07-1995 A 09-2002) - A8 3.7 QUATTRO (07-1995 A 09-2002) - A8 4.2 QUATTRO (03-1994 A 09-2002) - A8 6.0 W12 QUATTRO (01-2001)
	384mm F5 - F5		280mm F - MC55
	W5052 NO. 059105251AD - 059105251S - 059105251N - 059105251AA - 059105251AH - 059105251AS - 059105251AG - 0591... POLIE DA CABBOTA (6 PISTAS) AUDI A8 3.0 TDi QUATTRO APÓS 08-2003 Mtr ASB (232CV)		W5053 NO. 059105251AC - 059105251M POLIE DA CABBOTA (6 + 4 PISTAS) AUDI A8 2.5 V6 TDi (09-2000 A 09-2002 Mtr AKE (132Kw)
	d190mm d24mm		d193mm d33.8mm

	W5063 NO. 057105251D POLIE DA CAMBOTA (6 PISTAS) AUDI A8 APÓS 2003		Z80459 NO. 823867299 Mola de painel AUDI A8
	d188/192mm d24mm		d18x21.2mm 1p-d7.6-14.2mm
	Z80692 NO. N90821401 Mola de fixação AUDI A8		Z80748 NO. 893867290 Mola de painel AUDI A8
	d15x21.5mm 1p-7.5x7.5-19.5mm 1f-d4.8mm		d18x19.5mm 1p-d8-14.5mm
	Z80785 NO. 4A0805121A Mola de fixação AUDI A8		Z80786 NO. 4A0805163 Mola de fixação AUDI A8
	d25x28mm 1p-10x6.5-21mm		20x14x16mm 1f-d10mm
	Z80801 NO. 4A0805960 - 8D0805960 Mola de fixação AUDI A8		Z80803 NO. 1008068 - 7M0867299K Mola de painel AUDI A8
	25x25x9.6mm NULL		d17.7x21mm 1p-d8.6-15mm

AUDI CABRIOLET

	A1954 NO. 1J0253144A APOIO DO ESCAPE AUDI CABRIOLET (8G7, B4) 1.9 TDI Local de montagem: com painela de escape central (06.95 A 08.00) 90cv 1896cc Cabriolet		F1057-I NO. 191498201D - 321498201A - 321498201D - 443498201 FOLE DA TRANSMISSÃO JUNTO À CAIXA AUDI CABRIOLET (B4) 2.3iE (91 A 00)
	160x115x90mm 2f-15x10mm 2f-d5mm 1f-d12mm		d91x83mm 1f-d82mm 1f-d21mm
	F4108 NO. 893711110B FOLE ALAVANCA VELOCIDADES AUDI CABRIOLET (8G7, B4) 1.8 (01.97 A 08.00) 125cv 1781cc Cabriolet - AUDI CABRIOLET (8G7, B4) 2.0 E (01.93 A 07.98) 115cv 1984cc Cabriolet - AUDI CABRIOLET (8G7, B4) 2.3 E (05.91 A 07.94) 133cv 2309cc Cabriolet - AUDI CABRIOLET (8G7, B4) 2.6 (06.93 A 08.00) 150cv 2598cc Cabriolet - AUDI CABRIOLET (8G7, B4) 2.8 (11.92 A 08.00) 174cv 2771cc Cabriolet 2 / 2 - AUDI CABRIOLET (8G7, B4) 1.9 TDI (06.95 A 08.00) 90cv 1896cc Cabriolet		M6109 NO. 026129589A - 028129589B - 056129589A JUNTA DE ESCAPE AUDI CABRIO (05-91 A 08-00)
	210x150mm 1f-d12mm 1f-d140mm		82x41mm 1f-38/27mm
	R221846 NO. 058121058B TUBO DE LIGAÇÃO AO RADIADOR DO ÓLEO AUDI - CABRIOLET (8G7 - B4) - 1.8 125CV 1781cc (01-1997 A 08-2000) - 1.9 TDI 90CV 1896cc (06-1995 A 08-2000)		
	B150-16/19mm 80-90-60mm		

	<p>E0030 NO. 803253147</p> <p>ESTICADOR DE ESCAPE</p> <p>AUDI COUPE (APÓS 88)</p> <p>60x53x15mm NULL</p>		<p>F1057-I NO. 191498201D - 321498201A - 321498201D - 443498201</p> <p>FOLE DA TRANSMISSÃO JUNTO À CAIXA</p> <p>AUDI COUPE 1.8GT - 1.8GT QUATTRO - 1.8i GT(80 A 88)</p> <p>d91x83mm 1f-d82mm 1f-d21mm</p>
	<p>M6093 NO. 893253137D</p> <p>JUNTA DE ESCAPE</p> <p>AUDI COUPE (1988 A 1991)</p> <p>d72x18mm 1f-d56mm</p>		<p>M6109 NO. 026129589A - 028129589B - 056129589A</p> <p>JUNTA DE ESCAPE</p> <p>AUDI COUPE (07-80 A 12-96) - QUATTRO (07-80 A 07-89)</p> <p>82x41mm 1f-38/27mm</p>
	<p>RT08228 NO. 171611701G - 191611701 - 171611701L - 175611701A - 321611701B - 823611707 - 84911707A - 849611707A</p> <p>TUBO DE TRAVÃO FRENTE LH-RH</p> <p>AUDI COUPÉ 1.6 (07-1980 A 08-1981) - 1.8 (08-1981 A 07-1983) - 1.8 GT (09-1982 A 10-1988) - 1.8 GT QUATTRO (12-1984 A 10-1988) - 1.9 (08-1980 A 07-1983) - 2.0 (09-1983 A 04-1988) - 2.1 GT (09-1982 A 08-1984) - 2.2 GT (09-1984 A 10-1988) - 2.2 QUATTRO (10-</p> <p>310mm F - MC11</p>		<p>RT08228 NO. 171611701G - 191611701 - 171611701L - 175611701A - 321611701B - 823611707 - 84911707A - 849611707A</p> <p>TUBO DE TRAVÃO FRENTE LH-RH</p> <p>AUDI QUATTRO 2.1 TURBO (07-1980 A 07-1987)</p> <p>310mm F - MC11</p>
	<p>Z80456 NO. 811853329E</p> <p>Mola de friso</p> <p>AUDI COUPE QUATTRO</p> <p>17.2x12x10mm NULL</p>		<p>Z80459 NO. 823867299</p> <p>Mola de painel</p> <p>AUDI COUPE QUATTRO</p> <p>d18x21.2mm 1p-d7.6-14.2mm</p>

AUDI Q3-Q7











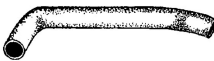

	<p>A1877 NO.</p> <p>APOIO DA TRANSMISSÃO</p> <p>AUDI Q7</p> <p>97x123x41mm 1f-d30mm</p>		<p>W5122 NO. 038105243M - 038105243L</p> <p>POLIE DA CAMBOTA (6 PISTAS)</p> <p>AUDI - Q3 (8U) - 2.0 TDI (APÓS 09.11) 136cv 1968cc Veículo todo-terreno fechado - AUDI - Q3 (8U) - 2.0 TDI (APÓS 09.11) 140cv 1968cc Veículo todo-terreno fechado - AUDI - Q3 (8U) - 2.0 TDI quattro (APÓS 01.12) 140cv 1968cc Veículo todo-terreno fechado - A</p> <p>d143mm d29,5mm</p>
	<p>Z80885 NO. 7L6868243</p> <p>MOLA DE PAINEL</p> <p>AUDI Q5 (A Partir de 2008)</p> <p>d22x30mm 1p-d8-10mm</p>		<p>Z80885 NO. 7L6868243</p> <p>MOLA DE PAINEL</p> <p>AUDI Q7 (A Partir de 2008)</p> <p>d22x30mm 1p-d8-10mm</p>

	<p>A1921 NO. 1K0253059BT - 1K0253059DF - 1K0253059HB - 1K0253144AE - 1K0254500Q</p> <p>APOIO DO ESCAPE</p> <p>AUDI TT (8J3) 2.0 TFSI N.º peças nec.: 1 (08.06 A 06.10) 200cv 1984cc Coupé - AUDI TT (8J3) 2.0 TFSI quattro N.º peças nec.: 1 - Código do motor: CCZA (06.08 A 06.10) 200cv 1984cc Coupé - AUDI TT Roadster (8J9) 1.8 TFSI (06.08 A 06.14) 160cv 1798cc Cabriolet - AUDI TT Roadster (8J9) 2.0 TFSI N.º peças nec.: 1 (03.07 A 06.10) 200cv 1984cc Cabriolet - AUDI TT Roadster (8J9) 2.0 TFSI quattro (06.08 A 06.10) 200cv 1984cc Cabriolet - AUD...etc.</p> <p>280x50x40mm 2f-d9mm 2f-d12mm</p>		<p>F4106 NO. 357413175A</p> <p>FOLE AMORTECEDORES FRENTE</p> <p>AUDI TT (8N3) 1.8 T (09.02 A 06.06) 150cv 1781cc Coupé - AUDI TT (8N3) 1.8 T (09.05 A 06.06) 163cv 1781cc Coupé - AUDI TT (8N3) 1.8 T (10.98 A 06.06) 180cv 1781cc Coupé - AUDI TT (8N3) 1.8 T quattro (10.98 A 06.06) 180cv 1781cc Coupé - AUDI TT (8N3) 1.8 T (09.05 A 06.06) 190cv 1781cc Coupé - AUDI TT (8N3) 1.8 T quattro (09.05 A 06.06) 190cv 1781cc Coupé - AUDI TT (8N3) 1.8 T quattro (10.98 A 06.06) 224cv 1781cc Coupé - AUDI T...etc.</p> <p>d80x210mm 1f-d20mm 1f-d73mm</p>
	<p>R221921 NO. 1K0145828S</p> <p>TUBO ADMISSÃO FILTRO DE AR</p> <p>AUDI TT (8J3) 2.0 TDI quattro (06.08 A 06.14) 170cv 1968cc Coupé - AUDI TT Roadster (8J9) 2.0 TDI quattro (06.08 A 06.14) 170cv 1968cc Cabriolet</p> <p>B100-47/47mm 50-50mm</p>		<p>RT80275 NO. 8N0611707A</p> <p>TUBO DE TRAVÃO FRENTE LH-RH</p> <p>AUDI TT 1.8 T (10-1998 A 06-2006) - TT 1.8 T QUATTRO (10-1998 A 06-2006)</p> <p>575mm FB49 - OR22</p>
	<p>RT80275 NO. 8N0611707A</p> <p>TUBO DE TRAVÃO FRENTE LH-RH</p> <p>AUDI TT ROADSTER 1.8 T (10-1999 A 06-2006) - TT ROADSTER 1.8 T QUATTRO (10-1999 A 06-2006)</p> <p>575mm FB49 - OR22</p>		<p>T0632-I NO. 1H0412303 B</p> <p>BATENTE SUSPENSÃO FRENTE</p> <p>AUDI TT (8N3) 1.8 T Chassis: para veículos com chassis desportivo (09.02 A 06.06) 150cv 1781cc Coupé - AUDI TT (8N3) 1.8 T Chassis: para veículos com chassis desportivo (10.98 A 06.06) 180cv 1781cc Coupé - AUDI TT (8N3) 1.8 T quattro Chassis: para veículos com chassis desportivo (10.98 A 06.06) 180cv 1781cc Coupé - AUDI TT (8N3) 1.8 T quattro Chassis: para veículos com chassis desportivo (10.98 A 06.06) 224cv 1781cc Coupé - AUDI TT (8...etc.</p> <p>d49x64mm 1f-d18mm 1f-d22mm</p>
	<p>T0638-I NO. 1J0412303</p> <p>BATENTE SUSPENSÃO DA FRENTE</p> <p>AUDI TT (8N3) 1.8 T (09.02 A 06.06) 150cv 1781cc Coupé - AUDI TT (8N3) 1.8 T (09.05 A 06.06) 163cv 1781cc Coupé - AUDI TT (8N3) 1.8 T (10.98 A 06.06) 180cv 1781cc Coupé - AUDI TT (8N3) 1.8 T quattro (10.98 A 06.06) 180cv 1781cc Coupé - AUDI TT (8N3) 1.8 T (09.05 A 06.06) 190cv 1781cc Coupé - AUDI TT (8N3) 1.8 T quattro (09.05 A 06.06) 190cv 1781cc Coupé - AUDI TT (8N3) 1.8 T quattro (10.98 A 06.06) 224cv 1781cc Coupé - AUDI TT (8N3)...etc.</p> <p>d58x53mm 1f-d26mm 1f-d22mm</p>		<p>T0701-I NO. 1J0512131C</p> <p>BATENTE SUSPENSÃO DA FRENTE</p> <p>AUDI TT (8N3) 1.8 T (09.02 A 06.06) 150cv 1781cc Coupé - AUDI TT (8N3) 1.8 T (09.05 A 06.06) 163cv 1781cc Coupé - AUDI TT (8N3) 1.8 T (10.98 A 06.06) 180cv 1781cc Coupé - AUDI TT (8N3) 1.8 T quattro (10.98 A 06.06) 180cv 1781cc Coupé - AUDI TT (8N3) 1.8 T (09.05 A 06.06) 190cv 1781cc Coupé - AUDI TT (8N3) 1.8 T quattro (09.05 A 06.06) 190cv 1781cc Coupé - AUDI TT (8N3) 1.8 T quattro (10.98 A 06.06) 224cv 1781cc Coupé - AUDI TT (8N3)...etc.</p> <p>d58x147mm 1f-d16mm 1f-d15mm</p>
	<p>UFV2003 NO. 06A103663B</p> <p>FUNIL VARETA NIVEL ÓLEO</p> <p>AUDI TT (8N3) 1.8 T (09.02 A 06.06) 150cv 1781cc Coupé - AUDI TT (8N3) 1.8 T Código do motor: AJQ, Código do motor: APP, Código do mot or: ARY, Código do motor: AUQ (10.98 A 06.06) 180cv 1781cc Coupé - AUDI TT (8N3) 1.8 T quattro Código do mot or: AJQ, Código do mot or: ARY (10.98 A 06.06) 180cv 1781cc Coupé - AUDI TT (8N3) 1.8 T quattro Código do mot or: APX, Código do mot or: BAM (10.98 A 06.06) 224cv 1781cc Coupé - AUDI TT ...etc.</p> <p>240x25mm 1f-d18mm 1f-d20mm</p>		<p>Z80641A NO. 1H0853586</p> <p><i>Mola de fixação</i></p> <p>AUDI TT</p> <p>d13x13mm 1p-d10-12mm 1f-d8.5mm</p>
	<p>Z80692 NO. N90821401</p> <p><i>Mola de fixação</i></p> <p>AUDI TT</p> <p>d15x21.5mm 1p-7.5x7.5-19.5mm 1f-d4.8mm</p>		<p>Z80750 NO. 51471904317 - N90201601H - 2207713 - 6998849</p> <p><i>Mola de painel</i></p> <p>AUDI TT</p> <p>d20x23mm 1p-d9-20mm</p>
	<p>Z80785 NO. 4A0805121A</p> <p><i>Mola de fixação</i></p> <p>AUDI TT</p> <p>d25x28mm 1p-10x6.5-21mm</p>		<p>Z80786 NO. 4A0805163</p> <p><i>Mola de fixação</i></p> <p>AUDI TT</p> <p>20x14x16mm 1f-d10mm</p>

	<p>A1066C14 NO. 811412323C - 811412323D - 811412323 - 8A0412323B - 8A0412323D</p> <p>APOIO SUPERIOR DO AMORTECEDOR DIANTEIRO (COM ROLAMENTO)</p> <p>AUDI 80 1.7 (09-1966 A 08-1968) - 1.3 (05-1972 A 07-1978) - 1.4 (08-1986 A 07-1988) - 1.5 (05-1972 A 07-1976) - 1.6 (09-1975 A 10-1994) - 1.6 GT (09-1973 A 07-1976) - 1.6 GTE (01-1976 A 07-1978) - 1.6 D (08-1980 A 08-1991) - 1.6 GLE (01-1979 A 12-1986) -</p>		<p>A1066C14 NO. 811412323C - 811412323D - 811412323 - 8A0412323B - 8A0412323D</p> <p>APOIO SUPERIOR DO AMORTECEDOR DIANTEIRO (COM ROLAMENTO)</p> <p>AUDI 90 1.6 TD (10-1985 A 01-1987) - 2.0 (10-1984 A 03-1987) - 2.0 QUATTRO (08-1984 A 08-1986) - 2.2 (10-1984 A 03-1987) - 2.2 E QUATTRO (11-1984 A 03-1987) - 1.6 TD (04-1987 A 09-1991) - 2.0 (07-1988 A 09-1991) - 2.0 20 V (08-1989 A 07-1991) - 2.0 20V</p>
	<p>A1080 NO. 893199381B - 823199381B</p> <p>SUPORTE DE MOTOR FRENTE</p> <p>AUDI 80 - AUDI 90 - QUATTRO</p>		<p>A1187 NO. 8A0253144E</p> <p>APOIO DE ESCAPE</p> <p>AUDI 80 (1991 A 1994)</p>
	<p>A1196 NO. 443199381C</p> <p>SUPORTE DA FRENTE DO MOTOR</p> <p>AUDI 80 - 90 - 100</p>		<p>A1196-H NO. 443199381C</p> <p>SUPORTE DA FRENTE MOTOR (HIDRÁULICO)</p> <p>AUDI 80 - 90 - 100</p>
	<p>A1458 NO. 811399151B</p> <p>SUPORTE DA CAIXA DE VELOCIDADES</p> <p>AUDI 80 (ATÉ 1991)</p>		<p>A1652 NO. 893199339D</p> <p>APOIO SUPLEMENTO DE SUPORTE DO MOTOR FRENTE</p> <p>AUDI 80 1.6 TD (01-1991 A 08-1991) - AUDI 80 1.9D (08-1989 A 08-1991) - AUDI 80 1.9 TD - 1.9 TDi - SW - CABRIO (09-1991 A 05-1995) - AUDI A6 1.8 - 1.9 TDi SW - 4X4 (1995 A 1997)</p>
	<p>A1954 NO. 1J0253144A</p> <p>APOIO DO ESCAPE</p> <p>AUDI 80 (89, 89Q, 8A, B3) 1.6 Local de montagem: com panela de escape central (08.90 A 10.91) 102cv 1595cc três volumes</p>		<p>BE14 NO. 443253269</p> <p>ABRAÇADEIRA DE ESCAPE</p> <p>AUDI 100 (ATÉ 1986)</p>
	<p>E0019 NO. 823253147A - 823253149</p> <p>ESTICADOR DE ESCAPE</p> <p>AUDI 80 (APÓS 87) - AUDI 90 (84-87) - AUDI COUPE (APÓS 80) - AUDI 100 (74-76) - AUDI 100 AVANT (86-87) - AUDI 100 AVANT (APÓS 77)</p>		<p>E0030 NO. 803253147</p> <p>ESTICADOR DE ESCAPE</p> <p>AUDI 100 (74 A 76) - AUDI 80 (APÓS 82) - AUDI 90 (APÓS 87)</p>
	<p>E0090 NO. 8A0505466C - 8D0505466</p> <p>ESTICADOR DA BARRA ESTABILIZADORA DE TRÁS LADO DIREITO</p> <p>AUDI 80 - 90 TT (QUATTRO) - A4 TT (QUATTRO) (1997 A 2001)</p>		<p>E0091 NO. 8A0505465C - 8D0505465</p> <p>ESTICADOR DA BARRA ESTABILIZADORA DE TRÁS LADO ESQUERDO</p> <p>AUDI 80 - 90 TT (QUATTRO)</p>
	<p>E1062 NO. 8A0253147A - 893253147E</p> <p>ESTICADOR DE ESCAPE</p> <p>AUDI 80 (1991 A 1995)</p>		<p>F0469-I NO. 803407283C</p> <p>FOLE DA TRANSMISSÃO LADO DA CAIXA</p> <p>AUDI 100 1.8 - 1.9 4cyl (APÓS 9-1974) - 100 2.0 - 2.2 5cyl (1976 A 1979) - 100 AVANT (PORSCHE 911 - 911 TURBO - TARGA - CARRERA)</p>

	<p>F0494-I NO. 321498201 - 431407285 - 431498203 - 16400.17047.01.06 - 431407285B - 7701033432</p> <p>FOLE DO SEMI-EIXO JUNTO À RODA</p> <p>AUDI 80 5 CIL. (1-83 a 6-84) - AUDI 80 GTE (8-81 a 6-84) - AUDI 80 GTE 4 cil. (7-84) - AUDI 80 - 90 Quattro - AUDI 90 - 2.0 - 2.2 (7-84) - AUDI 100-1.6 (74 a 82) - AVANT - COUPÉ (1983) - AUDI 100</p> <p>d93x82mm 1f-d79mm 1f-d21mm</p>		<p>F0503-I NO. 811419831B</p> <p>FOLE DA CREMALHEIRA DA DIRECÇÃO ESQ. E DIR.</p> <p>AUDI 80 TT MODELO 82</p> <p>d64x160mm 1f-d35mm 1f-d24mm</p>
	<p>F0715-I NO. 113501149</p> <p>FOLE DO SEMI-EIXO JUNTO À CAIXA DE VELOCIDADES</p> <p>AUDI 80 - 90 - QUATTRO (APÓS 1985) - 4CIL (APÓS 1981) - AUDI 100 - AUDI 200 - TURBO 5 CIL. - AUDI QUATTRO - 80 4CIL. (10-80 A 12-82) - 80 GT 2.0 - 2.2 - (1-83 A 8-84) - 80 AUT. 5 CIL. (9-1978 A 11-1982) - 90 4CIL. (APÓS 9-1984)</p> <p>d95x95mm 1f-d20mm 1f-d45mm</p>		<p>F0716-I NO. 211501150</p> <p>FOLE JUNTO À CAIXA</p> <p>AUDI 80 5 CIL. (12-1982 A 8-1984) - AUDI GTE 4 CIL. (1981 A 8-1984) - AUDI GT 55 (12-1982 A 8-1984)</p> <p>d102x98mm 1f-d56mm 1f-d21mm</p>
	<p>F0799A-I NO. 443407283A - 321407283</p> <p>FOLE LADO DA CAIXA</p> <p>AUDI 80 V8 - 90 2.0 - 100 ? 200</p> <p>d110x122mm 1f-d57mm 1f-d23mm</p>		<p>F0906-I NO. 893407285 - 4A0407285</p> <p>FOLE DO LADO DA RODA</p> <p>AUDI 100 (91 A 93) - 80 (90 A 94) - 80 - 90 (2.3) (APÓS 89)</p> <p>d103x83mm 1f-d80mm 1f-d22mm</p>
	<p>F1057-I NO. 191498201D - 321498201A - 321498201D - 443498201</p> <p>FOLE DA TRANSMISSÃO JUNTO À CAIXA</p> <p>AUDI 100 (C1) 1.8 QUATTRO - 1.8i QUATTRO - 1.9 (68 A 76) - (C3) 1.8 - 1.8i (82 A 90)</p> <p>d91x83mm 1f-d82mm 1f-d21mm</p>		<p>F1057-I NO. 191498201D - 321498201A - 321498201D - 443498201</p> <p>FOLE DA TRANSMISSÃO JUNTO À CAIXA</p> <p>AUDI 80 (B1) 1.3 - 1.5 - 1.6 - 1.6D - 1.6TD - 1.8 - 1.8CC QUATTRO - 1.8S QUATTRO - 1.8i - 1.8i GTE - 1.8iS - 1.8iS QUATTRO - 1.9D - 2.0i - 2.3iE (72 A 78) - (B2) 1.3 - 1.6 - 1.6D - 1.6TD - 1.8 - 1.8i (78 A 86) - (B3) 1.6 - 1.6D - 1.6TD - 1.8 - 1.8i - 1.9D</p> <p>d91x83mm 1f-d82mm 1f-d21mm</p>
	<p>F1057-I NO. 191498201D - 321498201A - 321498201D - 443498201</p> <p>FOLE DA TRANSMISSÃO JUNTO À CAIXA</p> <p>AUDI 90 (B2) 1.6 TD - 2.3iE (84 A 87) - (B3) 1.6TD - 2.3i (87 A 91)</p> <p>d91x83mm 1f-d82mm 1f-d21mm</p>		<p>F1121-I NO. 191498201C - 191407283A - 1J0498201 - 321407283A</p> <p>FOLE JUNTO À CAIXA LADO ESQUERDO</p> <p>AUDI 80 2.0-2.3 - AUDI 90 2.2-2.3-2.6</p> <p>d103x120mm 1f-d18mm</p>
	<p>F1122-I NO. 191407283</p> <p>FOLE JUNTO À CAIXA LADO DIREITO</p> <p>AUDI 80 2.0-2.3 - AUDI 90 2.2-2.3-2.6</p> <p>d103x113mm 1f-d35mm 1f-d22mm</p>		<p>F1184-I NO. 431419831</p> <p>FOLE DA DIRECÇÃO LADO DIREITO E ESQUERDO</p> <p>AUDI 100 08-76 A 7-94 - 100 QUATTRO 10-84 A 07-94 - 200 10-79 A 11-90 - 200 AVANT 11-84 A 12-90 - A6 - A6 AVANT APÓS 06-94 - AUDI V8 APÓS 10-88</p> <p>d78x540mm 1f-d48mm 1f-d40mm</p>
	<p>F1185-I NO. 191498201 - 191498201B - 191498201C - 191498202C - 1J0498201C - 321407282 - 321498201 - 357498201A - ...</p> <p>FOLE DA TRANSMISSÃO JUNTO À CAIXA</p> <p>AUDI 80 B2 1.8i GTE - 2.6i 12V QUATTRO - 2.8i 12V QUATTRO (1978 A 1986) - AUDI 80 B4 2.6i - 2.8i (1991 A 1996) - AUDI A3 1.8i 20V - 1.8i T 20V - 1.8i T 20V QUATTRO - 1.8i T S3 QUATTRO - 1.9 TDi PD QUATTRO (1996 A 2003) - AUDI A4 B5 1.8i 20V QUATTRO - 1.8i</p> <p>d102x120mm 1f-d54mm 1f-d29mm</p>		<p>F1281-I NO. 811419831B</p> <p>FOLE DA DIRECÇÃO LADO DIREITO</p> <p>AUDI 80 - 90 (APÓS 1980) - A4 - A6</p> <p>d50x145mm 1f-d47mm 1f-d30mm</p>
	<p>F1308-I NO. 441407285A</p> <p>FOLE JUNTO À RODA</p> <p>AUDI 80 (APÓS 1987) - 100 (1977 A 1981) - 100 (APÓS 1991) 100 QUATTRO (APÓS 1991) - CABRIO (APÓS 1992)</p> <p>d108x93mm 1f-d92mm 1f-d24mm</p>		<p>F4108 NO. 893711110B</p> <p>FOLE ALAVANCA VELOCIDADES</p> <p>AUDI 80 (89, 89Q, 8A, B3) 1.4 (08.86 A 07.88) 65cv 1400cc três volumes - AUDI 80 (89, 89Q, 8A, B3) 1.6 (08.87 A 09.91) 70cv 1595cc três volumes - AUDI 80 (89, 89Q, 8A, B3) 1.6 (09.86 A 08.91) 75cv 1595cc três volumes - AUDI 80 (89, 89Q, 8A, B3) 1.6 (08.90 A 10.91) 102cv 1595cc três volumes - AUDI 80 (89, 89Q, 8A, B3) 1.8 (10.86 A 01.90) 75cv 1781cc três volumes - AUDI 80 (89, 89Q, 8A, B3) 1.8 S (08.86 A 01.90) 88cv 1781cc três vo...etc.</p> <p>210x150mm 1f-d12mm 1f-d140mm</p>

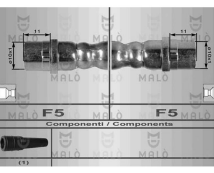
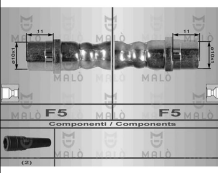
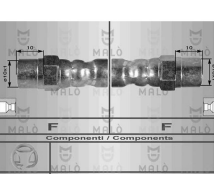
	<p>F4108 NO. 893711110B</p> <p>FOLE ALAVANCA VELOCIDADES</p> <p>AUDI 80 (8C, B4) 1.6 (09.91 A 12.94) 71cv 1595cc três volumes - AUDI 80 (8C, B4) 1.6 E (06.93 A 12.94) 101cv 1595cc três volumes - AUDI 80 (8C, B4) 2.0 (09.91 A 12.94) 90cv 1984cc três volumes - AUDI 80 (8C, B4) 2.0 E (09.91 A 12.94) 115cv 1984cc três volumes - AUDI 80 (8C, B4) 2.0 E quattro (09.91 A 12.94) 115cv 1984cc três volumes - AUDI 80 (8C, B4) 2.0 E 16V (09.91 A 07.92) 137cv 1984cc três volumes - AUDI 80 (8C, B4) 2.0 E 1...etc.</p> <p>210x150mm 1f-d12mm 1f-d140mm</p>		<p>F4108 NO. 893711110B</p> <p>FOLE ALAVANCA VELOCIDADES</p> <p>AUDI 90 (89, 89Q, 8A, B3) 2.2 E (04.87 A 07.91) 136cv 2226cc três volumes - AUDI 90 (89, 89Q, 8A, B3) 2.3 E 20V (04.90 A 07.91) 167cv 2309cc três volumes - AUDI 90 (89, 89Q, 8A, B3) 2.3 E 20V (08.88 A 07.91) 170cv 2309cc três volumes</p> <p>210x150mm 1f-d12mm 1f-d140mm</p>
	<p>F4108 NO. 893711110B</p> <p>FOLE ALAVANCA VELOCIDADES</p> <p>AUDI COUPE (89, 8B) 1.8 (08.89 A 07.91) 112cv 1781cc Coupé - AUDI COUPE (89, 8B) 2.0 (03.90 A 07.90) 112cv 1984cc Coupé - AUDI COUPE (89, 8B) 2.0 (05.89 A 03.90) 113cv 1984cc Coupé - AUDI COUPE (89, 8B) 2.0 (05.89 A 12.96) 115cv 1984cc Coupé - AUDI COUPE (89, 8B) 2.0 16 V (01.92 A 07.92) 137cv 1984cc Coupé - AUDI COUPE (89, 8B) 2.0 16 V (08.92 A 12.96) 140cv 1984cc Coupé - AUDI COUPE (89, 8B) 2.2 quattro (11.88 A 07.91) 136cv 2...etc.</p> <p>210x150mm 1f-d12mm 1f-d140mm</p>		<p>H245 NO.</p> <p>PALA ORIGINAL</p> <p>AUDI 80</p> <p>370x215mm NULL</p>
	<p>KF1174-T NO. 171498203 - 191407285 - 191407285E - 191407285F - 191407285G - 191498203C - 191498203D - 191598203 - ...</p> <p>KIT DE FOLE DO CARDAN JUNTO À RODA</p> <p>AUDI 100 C3 2.2i QUATTRO - 2.3i E QUATTRO (1982 A 1990) - AUDI 100 C4 2.3i (1990 A 1994) - AUDI A3 1.6i - 1.8i T 20V QUATTRO - 1.8i T S3 QUATTRO - 1.9 TDi PD QUATTRO (1996 A 2003)</p> <p>d105x115mm 1f-d80mm 1f-d26mm</p>		<p>M6029 NO. 431253137A - 073253137A - 855253137A - 477253137 - 443253137C - 0063613483 - AA70A13483</p> <p>JUNTA DE ESCAPE</p> <p>AUDI 80 (1979 A 1994) - 90 (1984 A 1990) - 100 (1977 A 1994)</p> <p>d60.3x13.8mm 1f-d46.5mm</p>
	<p>M6030 NO. 431253115A - 443253115A</p> <p>JUNTA DE ESCAPE</p> <p>AUDI 80 (1979 A 1995) - 90 (1984 A 1991) - 100 (1977 A 1994)</p> <p>170x90mm 2f-d52mm</p>		<p>M6050 NO. 843253115</p> <p>JUNTA DE ESCAPE</p> <p>AUDI 80 (1972 A 1987)</p> <p>119x68mm 2f-d37mm</p>
	<p>M6093 NO. 893253137D</p> <p>JUNTA DE ESCAPE</p> <p>AUDI 80 (1990 A 1991) - 80 QUATRO (1990 A 1991)</p> <p>d72x18mm 1f-d56mm</p>		<p>M6093 NO. 893253137D</p> <p>JUNTA DE ESCAPE</p> <p>AUDI 90 (1988 A 1991) - 90 QUATRO (1988 A 1991)</p> <p>d72x18mm 1f-d56mm</p>
	<p>M6109 NO. 026129589A - 028129589B - 056129589A</p> <p>JUNTA DE ESCAPE</p> <p>AUDI 80 (05-1972 A 01-1996) - 90 (10-84 A 09-91) - 100 (08-1976 A 06-1994)</p> <p>82x41mm 1f-38/27mm</p>		<p>M6502 NO. 050129761A - 050129761B</p> <p>JUNTA DO CARBURADOR</p> <p>AUDI 80 - 100</p> <p>145x111x26mm NULL</p>
	<p>N2331 NO. 861253147 - 823010459 - 893253147F</p> <p>ANEL ESCAPE</p> <p>AUDI 80 (1979 A 1992) - 90 (1984 A 1991) - 100 (1980 A 1994)</p> <p>d58x14mm 1f-d31mm</p>		<p>N3727 NO. 861253147</p> <p>ANEL DE ESCAPE</p> <p>AUDI 80 TURBO D - AUDI 90 SUPER</p> <p>d55x12mm 1f-d31mm</p>
	<p>P1011 NO. 823721173</p> <p>CAPA DE PEDAL DO TRAVÃO E EMBRAIAGEM</p> <p>AUDI 80 - L - S - SL - GL</p> <p>58x50x90mm NULL</p>		<p>P1017 NO. 321721173 - 7212341</p> <p>CAPA DE PEDAL DO TRAVÃO E EMBRAIAGEM</p> <p>AUDI 80 TT</p> <p>67x55x10mm NULL</p>

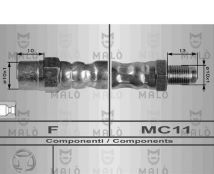
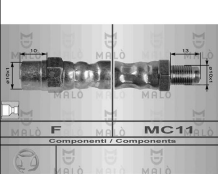
	<p>Q2003 NO. 3572531411 - 357253141 - 443253141D UNIÃO DE ESCAPE 56/60x125mm AUDI 80 (1986 A 1995) - 100 (1984 A 1994)</p> <p>125x90x67mm 1f-d57mm</p>		<p>Q2006 NO. 893253139 UNIÃO DE ESCAPE 50.5x54x90mm AUDI 80 (1986 A 1991) - 90 (1987 A 1991)</p> <p>94x84x59mm 1f-d50mm</p>
	<p>Q2007 NO. 893253139B - 893253139C - 437253141 UNIÃO DE ESCAPE 61/65x130 mm AUDI 100 (1993 A 1994) - 100 QUATTRO T (1986 A 1990) - 200 QUATTRO T (1979 A 1990)</p> <p>130x90x70mm 1f-d61mm</p>		<p>R220179 NO. 811121051 TUBO INFERIOR DO RADIADOR AUDI 80 TT</p> <p>B320-d33/30mm 80-90-230-80mm</p>
	<p>R220180 NO. 811121101A - 811121101H TUBO DE RADIADOR SUPERIOR (8/81 A 1/84) AUDI 80 D TT</p> <p>B535-d30/30mm 90-390-105mm</p>		<p>R220202 NO. 811121101E - 811121101F - 811121101J - 855121101 TUBO SUPERIOR DO RADIADOR AUDI 80 1.6TD (APÓS 1987) - 1.9TD (APÓS 1987) - AUDI 100 1.8 (APÓS 8-82)</p> <p>B560-d30/30mm 105-380-150mm</p>
	<p>R220388 NO. TUBO DE LIGAÇÃO DA BOMBA DE ÁGUA AO TERMOSTATO (MOD.82 a 84 - 90 a 92) AUDI 80 D TT</p> <p>B295-d24/24mm 90-40-120-60mm</p>		<p>R220635 NO. TUBO DE LIGAÇÃO DA BOMBA DE ÁGUA AO TERMOSTATO AUDI 80 GASOLINA TT - AUDI 100 (1.6 - 1.8)</p> <p>B290-d23/23mm 85-110-60-45-60mm</p>
	<p>R221014 NO. 8A0121101C TUBO SUPERIOR DO RADIADOR AUDI 80 1.6 (1992 A 1993) - 1.6TD (1992 A 1996) - 1.9 TD (1992 A 1996) - 2.0 (1992 A 1993)</p> <p>B550-d30/30mm 90-390-135mm</p>		<p>R221016 NO. 8A0121051A TUBO INFERIOR DO RADIADOR AUDI - 80 (80 - 82 - B1) - 1.3 (05.72 - 07.78) 55cv 1297cc - AUDI - 80 (80 - 82 - B1) - 1.3 (05.72 - 07.78) 60cv 1297cc - AUDI - 80 (80 - 82 - B1) - 1.5 (05.72 - 08.75) 75cv 1471cc - AUDI - 80 (80 - 82 - B1) - 1.6 (09.75 - 07.78) 75cv 1588cc - AUDI - 80 (80 - 82 -</p> <p>B310-d30/30mm 200-60-130-60mm</p>
	<p>RT08030 NO. 4A0611707 - 171611701G TUBO DE TRAVÃO FRENTE LH-RH AUDI 100 TT (1990 A 1994)</p> <p>295mm F5 - F5</p>		<p>RT08035 NO. TUBO DE TRAVÃO FRENTE LH-RH AUDI 80 (1.3 - 1.6 - 1.8) (APÓS 09-1981) - AUDI 80E (1.8 - 1.9 - 2.0) (APÓS 9-1989) - AUDI 80 (2.0 - 90PS) (APÓS 9-1991) - AUDI 80 D - TD (4-1987 A 8-1991) - AUDI 80 D - TD (9-1991 A 7-1992)</p> <p>310mm F5 - F5</p>
	<p>RT08227 NO. 433611775A - 431611775A - 433611775A - 443611775D TUBO DE TRAVÃO TRÁS LH-RH AUDI 80 (1.3 - 1.6 - 1.8) (09-1986 A 08-1989) - AUDI 80 D - TD (8-1982 A 3-1987) - AUDI 100 - 100D - TD (ATÉ 1989) - AUDI 100 - 100D ? TD</p> <p>180mm F - F</p>		<p>RT08228 NO. 171611701G - 191611701 - 171611701L - 175611701A - 321611701B - 823611707 - 84911707A - 849611707A TUBO DE TRAVÃO FRENTE LH-RH AUDI 100 1.8 (08-1982 A 07-1989) - 1.8 CAT (03-1985 A 11-1990) - 1.8 QUATTRO (10-1984 A 07-1990) - 1.8 QUATTRO CAT (08-1985 A 11-1990) - 2.0 (08-1984 A 12-1987) - 2.0 CAT (01-1988 A 11-1990) - 2.0 D (08-1982 A 07-1988) - 2.0 D TURBO (08-1982 A 11-1990) -</p> <p>310mm F - MC11</p>
	<p>RT08228 NO. 171611701G - 191611701 - 171611701L - 175611701A - 321611701B - 823611707 - 84911707A - 849611707A TUBO DE TRAVÃO FRENTE LH-RH AUDI 80 1.3 (05-1972 A 07-1986) - 1.5 (05-1972 A 07-1976) - 1.6 (09-1975 A 07-1986) - 1.6 D (08-1980 A 08-1986) - 1.6 GLE (01-1979 A 12-1986) - 1.6 TD (08-1981 A 05-1986) - 1.8 (01-1983 A 08-1986) - 1.8 CC QUATTRO (08-1984 A 08-1986) - 1.8 GTE (10-1984 A</p> <p>310mm F - MC11</p>		<p>RT08228 NO. 171611701G - 191611701 - 171611701L - 175611701A - 321611701B - 823611707 - 84911707A - 849611707A TUBO DE TRAVÃO FRENTE LH-RH AUDI 90 1.6 TD (10-1985 A 01-1987) - 2.0 (10-1984 A 03-1987) - 2.2 (10-1984 A 03-1987) - 2.2 E QUATTRO (11-1984 A 03-1987) - 1.6 TD (04-1987 A 09-1991) - 2.0 (07-1988 A 09-1991) - 2.0 20V (08-1989 A 07-1991) - 2.2 E (04-1987 A 07-1991) - 2.2 E QUATTRO (04</p> <p>310mm F - MC11</p>

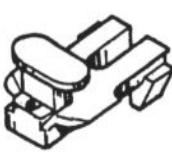
	<p>S1149 NO. 857407181</p> <p>SILENT-BLOC DO BRAÇO DA SUSPENSÃO FRENTE</p> <p>AUDI 80 - 90</p> <p>d48x44mm d37mm 1f-d10mm</p>		<p>S1357 NO. 8A0511247B</p> <p>SILENT-BLOC DO BRAÇO DA SUSPENSÃO DE TRÁS</p> <p>AUDI 80 SW 4X4 2.3 9-91 A 11-94 - 2.6 V6 SW 4X4 7-92 A 5-95 - 2.8 V6 SW 4X4 8-92 A 5-95</p> <p>d52x25mm d44mm 1f-d12mm</p>
	<p>T0608-I NO. 861412131</p> <p>BATEANTE DA SUSPENSÃO DA FRENTE</p> <p>AUDI 80 - 90</p> <p>d43x45mm 1f-d18mm</p>		<p>T1029 NO. 823411313A</p> <p>BATEANTE DA BARRA ESTABILIZADORA (CENTRO)</p> <p>AUDI 80 (1973 A 1990)</p> <p>42x39x24mm 1f-d12mm</p>
	<p>W5008 NO. 028105243T - 028105243G - 028105243H - 028105243K - 028105243R</p> <p>POLIE DA CAMBOTA (6 pistas)</p> <p>AUDI 100</p> <p>d155.5mm d30mm</p>		<p>W5008 NO. 028105243T - 028105243G - 028105243H - 028105243K - 028105243R</p> <p>POLIE DA CAMBOTA (6 pistas)</p> <p>AUDI 80 - 90 - (1.9TD - 1.9TDI) (09-91 A 12-94) - AUDI 100</p> <p>d155.5mm d30mm</p>
	<p>Z80248 NO. 811807447</p> <p>Mola de friso</p> <p>AUDI 80</p> <p>NULL NULL</p>		<p>Z80440 NO. 803853139C</p> <p>Mola de friso</p> <p>AUDI 80</p> <p>18x9.3x18.5mm 1p-d6.5-6.5mm</p>
	<p>Z80440 NO. 803853139C</p> <p>Mola de friso</p> <p>AUDI 100</p> <p>18x9.3x18.5mm 1p-d6.5-6.5mm</p>		<p>Z80456 NO. 811853329E</p> <p>Mola de friso</p> <p>AUDI 90</p> <p>17.2x12x10mm NULL</p>
	<p>Z80456 NO. 811853329E</p> <p>Mola de friso</p> <p>AUDI 80</p> <p>17.2x12x10mm NULL</p>		<p>Z80459 NO. 823867299</p> <p>Mola de painel</p> <p>AUDI 80</p> <p>d18x21.2mm 1p-d7.6-14.2mm</p>
	<p>Z80459 NO. 823867299</p> <p>Mola de painel</p> <p>AUDI 100</p> <p>d18x21.2mm 1p-d7.6-14.2mm</p>		<p>Z80626 NO. 161867299</p> <p>Mola de fixação</p> <p>AUDI 80</p> <p>d16x28mm 1p-d9-14mm</p>
	<p>Z80748 NO. 893867290</p> <p>Mola de painel</p> <p>AUDI 80</p> <p>d18x19.5mm 1p-d8-14.5mm</p>		<p>Z80748 NO. 893867290</p> <p>Mola de painel</p> <p>AUDI 100</p> <p>d18x19.5mm 1p-d8-14.5mm</p>

	<p>Z80749 NO. 703867299</p> <p><i>Mola de painel</i></p> <p>AUDI 80</p> <p>d18x20.5mm 1p-d8.4-13.5mm</p>		<p>Z80749 NO. 703867299</p> <p><i>Mola de painel</i></p> <p>AUDI 100</p> <p>d18x20.5mm 1p-d8.4-13.5mm</p>
	<p>Z80750 NO. 51471904317 - N90201601H - 2207713 - 6998849</p> <p><i>Mola de painel</i></p> <p>AUDI 80</p> <p>d20x23mm 1p-d9-20mm</p>		<p>Z80785 NO. 4A0805121A</p> <p><i>Mola de fixação</i></p> <p>AUDI 80</p> <p>d25x28mm 1p-10x6.5-21mm</p>
	<p>Z80785 NO. 4A0805121A</p> <p><i>Mola de fixação</i></p> <p>AUDI 100</p> <p>d25x28mm 1p-10x6.5-21mm</p>		<p>Z80786 NO. 4A0805163</p> <p><i>Mola de fixação</i></p> <p>AUDI 80</p> <p>20x14x16mm 1f-d10mm</p>
	<p>Z80786 NO. 4A0805163</p> <p><i>Mola de fixação</i></p> <p>AUDI 100</p> <p>20x14x16mm 1f-d10mm</p>		